

# JBC

[www.jbctools.com](http://www.jbctools.com)



## Nano Soldering station

Ref. NANE-B

# Packing List

The following items should be included:

**Control Unit** ..... 1 unit  
Ref. NAE-1B (120V)  
NAE-2B (230V)  
NAE-9B (100V)



**Nano Handle** ..... 2 units  
Ref. NT105-A



**Tool Holder** ..... 2 units  
Ref. 0016606



**Cartridge dispenser**  
**Case** ..... 1 unit  
Ref. 0011568



**Cartridges included**  
Ref. C105-101 x1  
C105-103 x1  
C105-105 x2  
C105-107 x1  
C105-112 x1  
C105-113 x2

**Allen key** ..... 1 unit  
Ref. 009848



**Metal Brush** ..... 1 unit  
Ref. CL2466



**Brass Wool** ..... 1 unit  
Ref. CL6210



**Power Cord** ..... 1 unit  
Ref. 0009417 (100/120V)  
0009401 (230V)



**Manual** ..... 1 unit  
Ref. 0016765

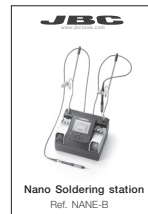

## Features

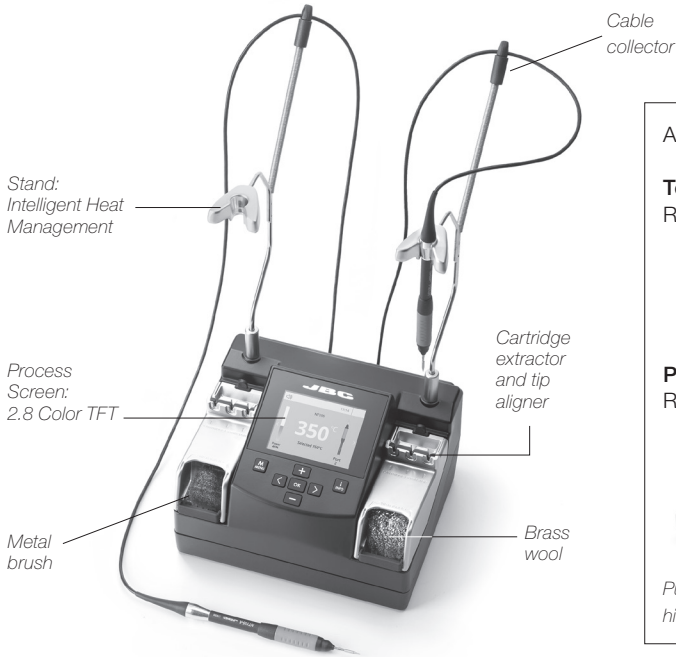

Accessories not included:

**Tool extension cord (1m)**  
Ref. A1205



**Pedal**  
Ref. P-005



Puts the tool into hibernation mode

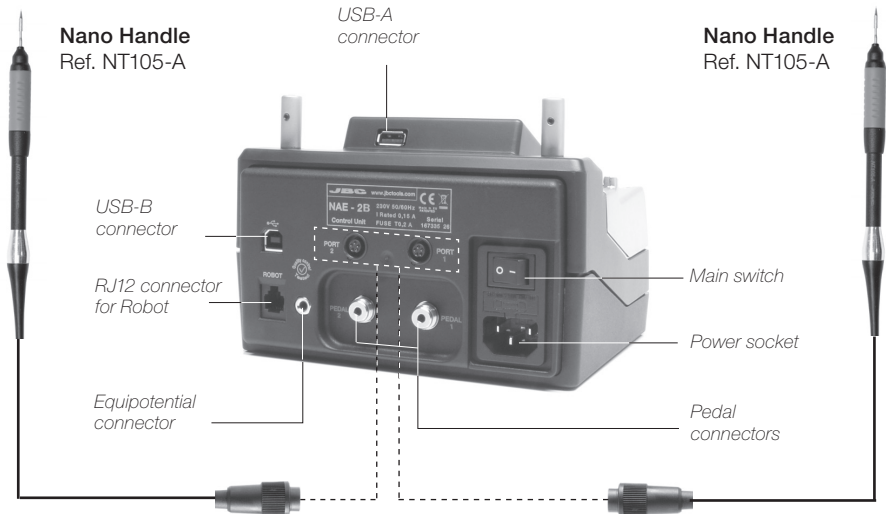

# Tool Holder assembly

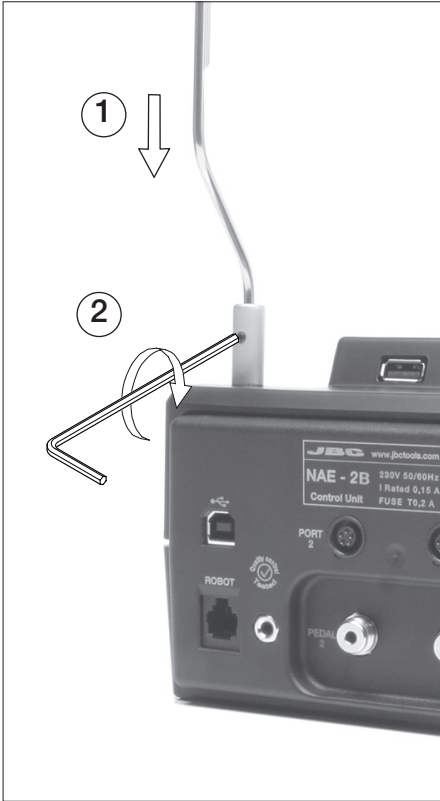

# Cable assembly

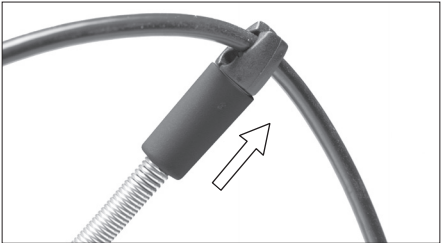
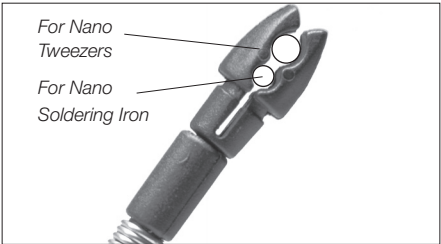

# Changing the tip cleaning system

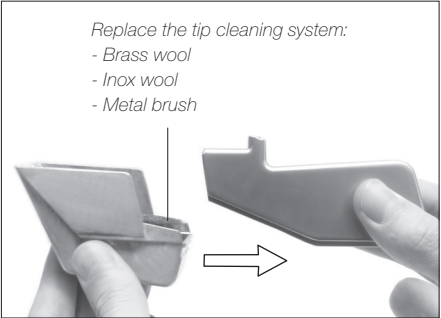
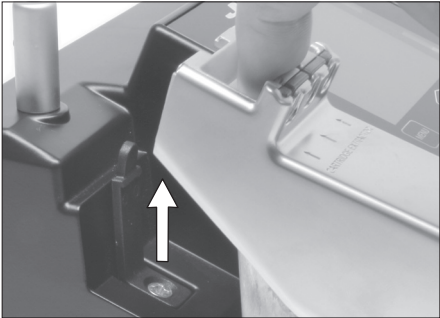

## Changing cartridges

Save time and change cartridges safely without having to switch the station off.

### Removing

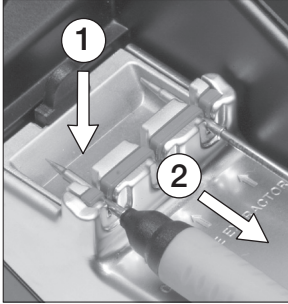

Place the cartridge in the slot as shown and pull the handle to remove it.

### Inserting

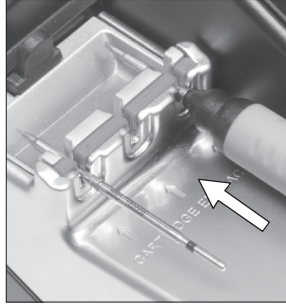

Push the cartridge into the handle to the mark\*.

### Aligning

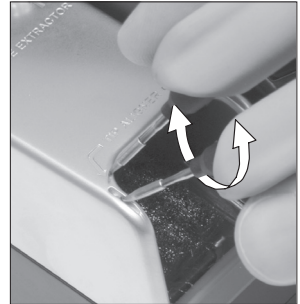

Use the holes to rotate the cartridges for a proper alignment.

### \*Important

It is essential to insert the cartridges as far as the mark for a proper connection.

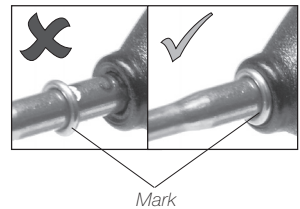

## Compatible cartridges

The NANE-B station works with C105 cartridge range.

See the full range in [www.jbctools.com](http://www.jbctools.com) and find the model that best suits your soldering needs.

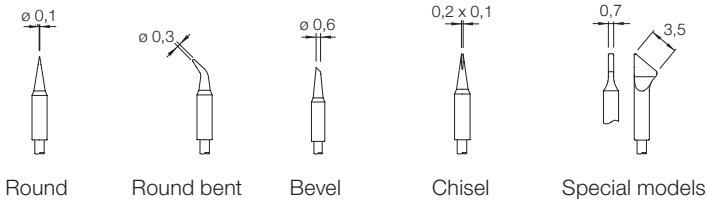

All the cartridges shown are actual size. All measurements are in millimeters (mm).  
Contact JBC if you need alternative shapes.

# Operation

## The JBC Exclusive Heating System

Our revolutionary technology is able to recover tip temperature extremely quickly. It means the user can work at a lower temperature and improve the quality of soldering. Tip temperature is further reduced thanks to the Sleep and Hibernation modes which increase tip life by 5.

### 1. Work

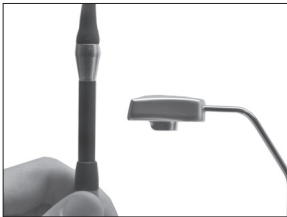

When the tool is lifted from the holder the tip will heat up to the selected temperature.

### 2. Sleep

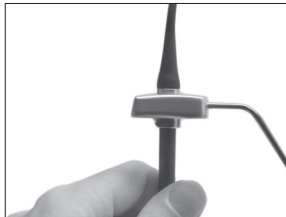

When the tool is in the holder, the temperature falls to 180°C / 360°F (preset sleep temperature).

### 3. Hibernation



After longer periods of inactivity (pre-set to 30 min.), the power is cut off and the tool cools down to room temperature.

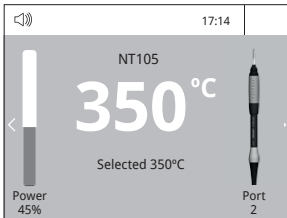

- Set temperature limits
- Select temperature levels

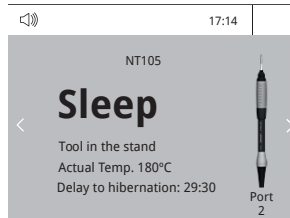

- Set Sleep temperature
- Set Sleep delay (from 0 to 9 min or no Sleep)

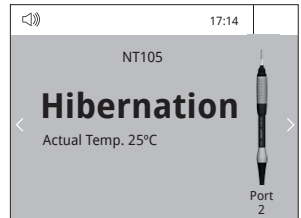

- Set Hibernation delay (from 0 to 60 min or no hibernation)

## Work Screen

The NANE-B offers an **intuitive user interface** which provides **quick access** to station parameters.

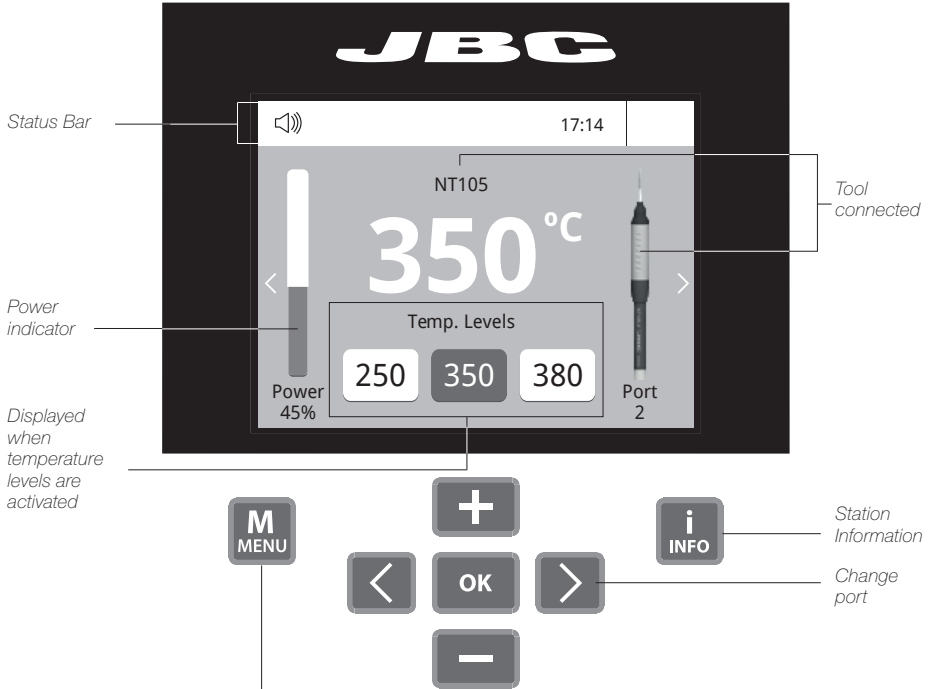

### Menu Options

Press INFO for each parameter description.



Station



Tools



Counters









Graphics



Reset

### System notifications (Status Bar)

-  USB flash drive is connected.
-  Station is controlled by a PC.
-  Station is controlled by a Robot.
-  Station software update.  
Press INFO to start the process.
-  Warning.  
Press INFO for failure description.
-  Error. Press INFO for failure description, the type of error and how to proceed.

# Process analysis



Graphics

By pressing Graphics in the main MENU, temperature and power figures in real time are displayed for each port. This helps you decide which tip to use to obtain the best quality solder joint.

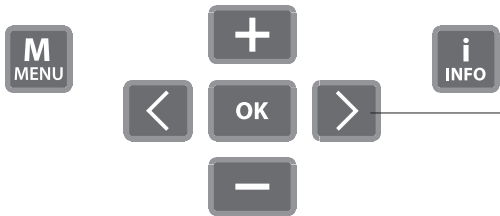
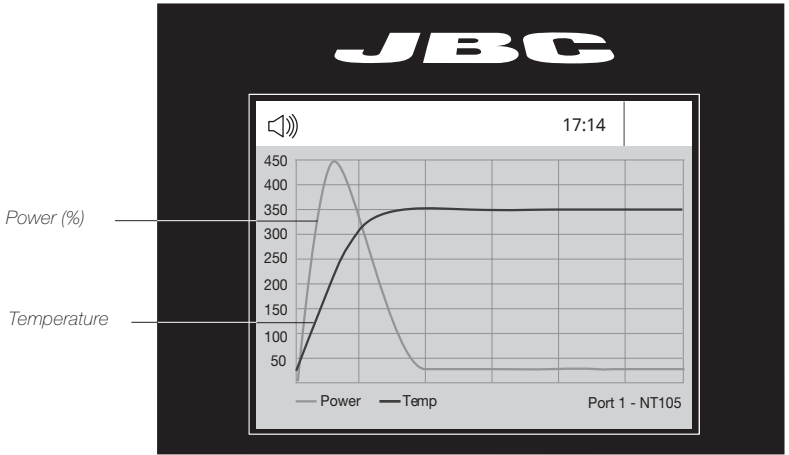

See other port graphic

## Export graphics

Insert a USB flash drive into the USB-A connector to save your soldering process in csv format.

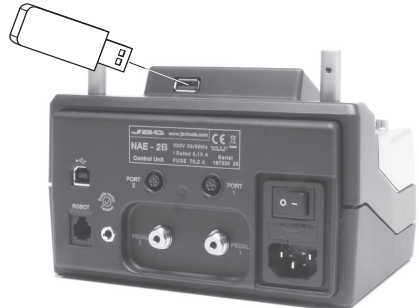



## Soldering Net

Remotely manage and monitor as many stations as your PC can handle.

1. Download the **JBC Manager software** and the user manual from [www.jbctools.com/manager.html](http://www.jbctools.com/manager.html)
2. Connect the stations via USB-B connector and the PC will automatically detect them.
3. The notification  will be displayed on the station.

### Functions:

- Set all the station parameters from your PC.
- Organize groups of stations and set all their parameters at the same time.
- Store specific configurations for later use.
- Analyze the soldering graphics of the stations on your PC and export them.

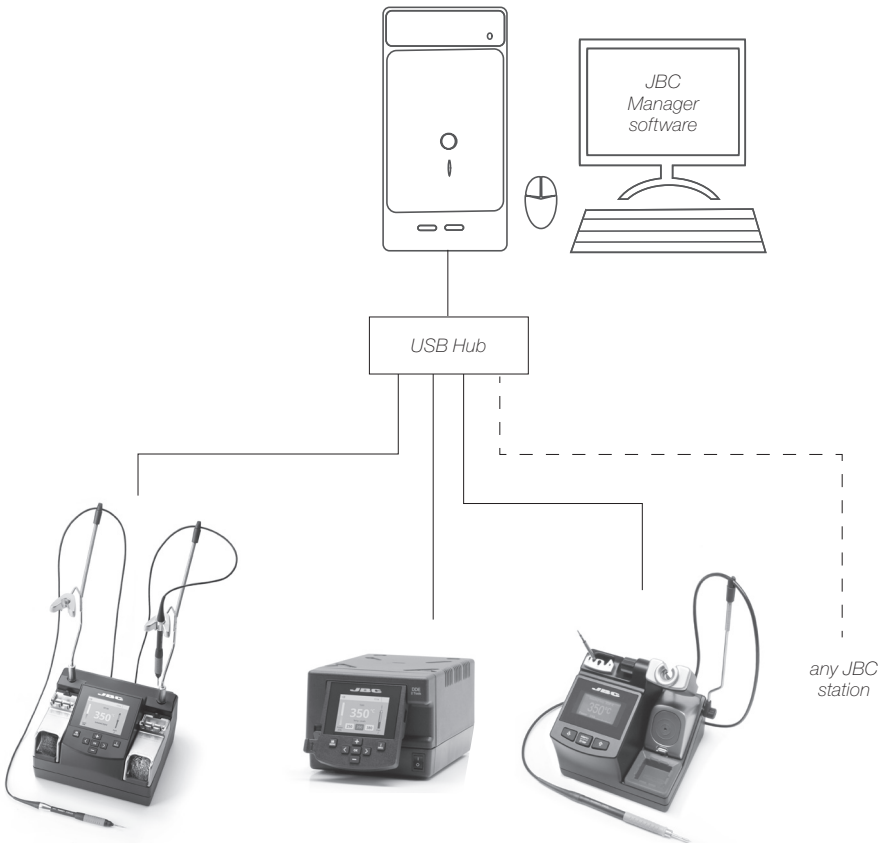

# Working with Robots

Manage and monitor the station using a Robotic system.

1. Connect the tool to the port and connect your Robot system to the Robot connector (RJ12). DB9-RJ12 Adapter available only if necessary (Ref: 0013772).
2. Enable the Robot option in the station settings and the notification will be displayed: 
3. Set your Robot's commands according to the Robot Communication Protocol, available on the website [www.jbctools.com/jbcsoftware-menu-115.html](http://www.jbctools.com/jbcsoftware-menu-115.html)

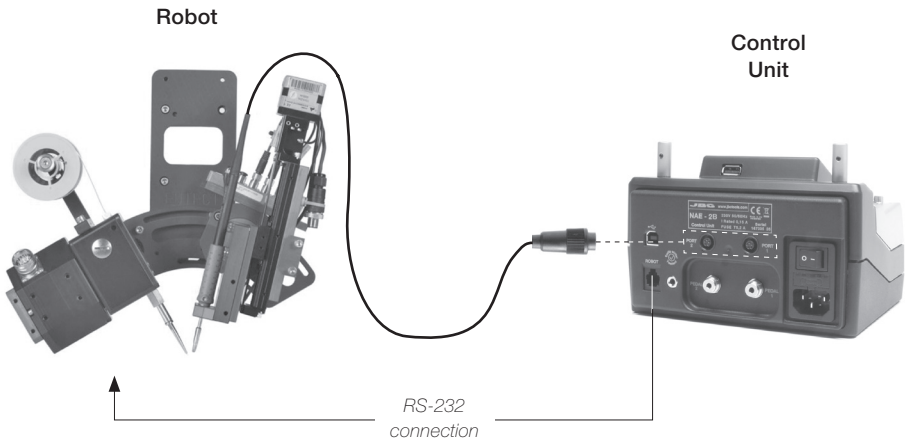

## Update the station software

1. Download the JBC Updater software from [www.jbctools.com/software.html](http://www.jbctools.com/software.html) and save it on a USB flash drive. Preferably one with no other files.

2. Insert the USB flash drive. The icon  is displayed while updating.

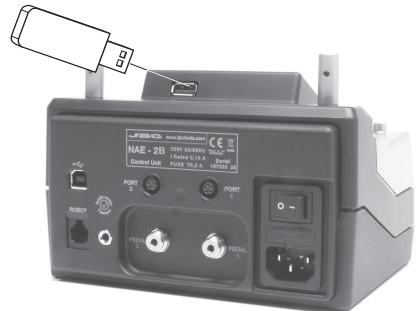
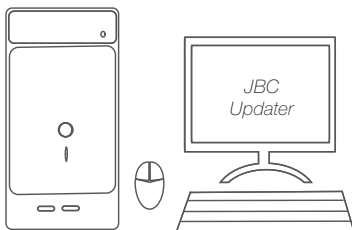

## Maintenance

Before carrying out maintenance, always allow the equipment to cool.

- Clean the station screen with a glass cleaner or a damp cloth.
- Use a damp cloth to keep the casing and the tool clean. Alcohol can only be used to clean the metal parts.
- Maintain tip surface clean and tinned prior to storage in order to avoid tip oxidation. Rusty and dirty surfaces reduce heat transfer to the solder joint.
- Periodically check all cables and tubes.
- Periodically check that the metal parts of the tool and stand are clean so that the station can detect the tool status.



- Replace a blown fuse as follows:

**1.** Pull off the fuse holder and remove the fuse. If necessary use a tool to lever it off.

**2.** Press the new fuse into the fuse holder and replace it in the station.

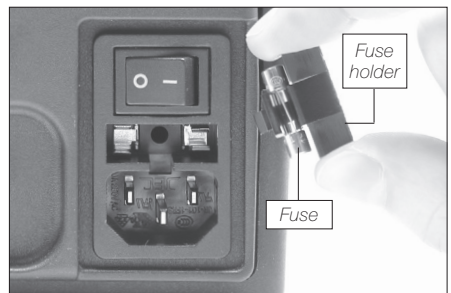
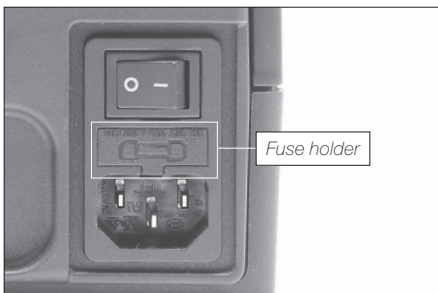

- Replace any defective or damaged pieces. Use original JBC spare parts only.
- Repairs should only be performed by a JBC authorized technical service.

# Safety



**It is imperative to follow safety guidelines to prevent electric shock, injury, fire or explosion.**

- Do not use the units for any purpose other than soldering or rework. Incorrect use may cause fire.
- The power cord must be plugged into approved bases. Be sure that it is properly grounded before use. When unplugging it, hold the plug, not the wire.
- Do not work on electrically live parts.
- The tool should be placed in the stand when not in use in order to activate the sleep mode. The soldering tip, the metal part of the tool and the stand may still be hot even when the station is turned off. Handle with care.
- Do not leave the appliance unattended when it is on.
- Do not cover the ventilation grills. Heat can cause inflammable products to ignite.
- Avoid the contact of flux with skin or eyes to prevent irritation.
- Be careful with the fumes produced when soldering.
- Keep your workplace clean and tidy. Wear appropriate protective glasses and gloves when working to avoid personal harm.
- Utmost care must be taken with liquid tin waste which can cause burns.
- This appliance can be used by children over the age of eight and also persons with reduced physical, sensory or mental capabilities or lack of experience provided that they have been given adequate supervision or instruction concerning use of the appliance and understand the hazards involved. Children must not play with the appliance.
- Maintenance must not be carried out by children unless supervised.

## Exploded View

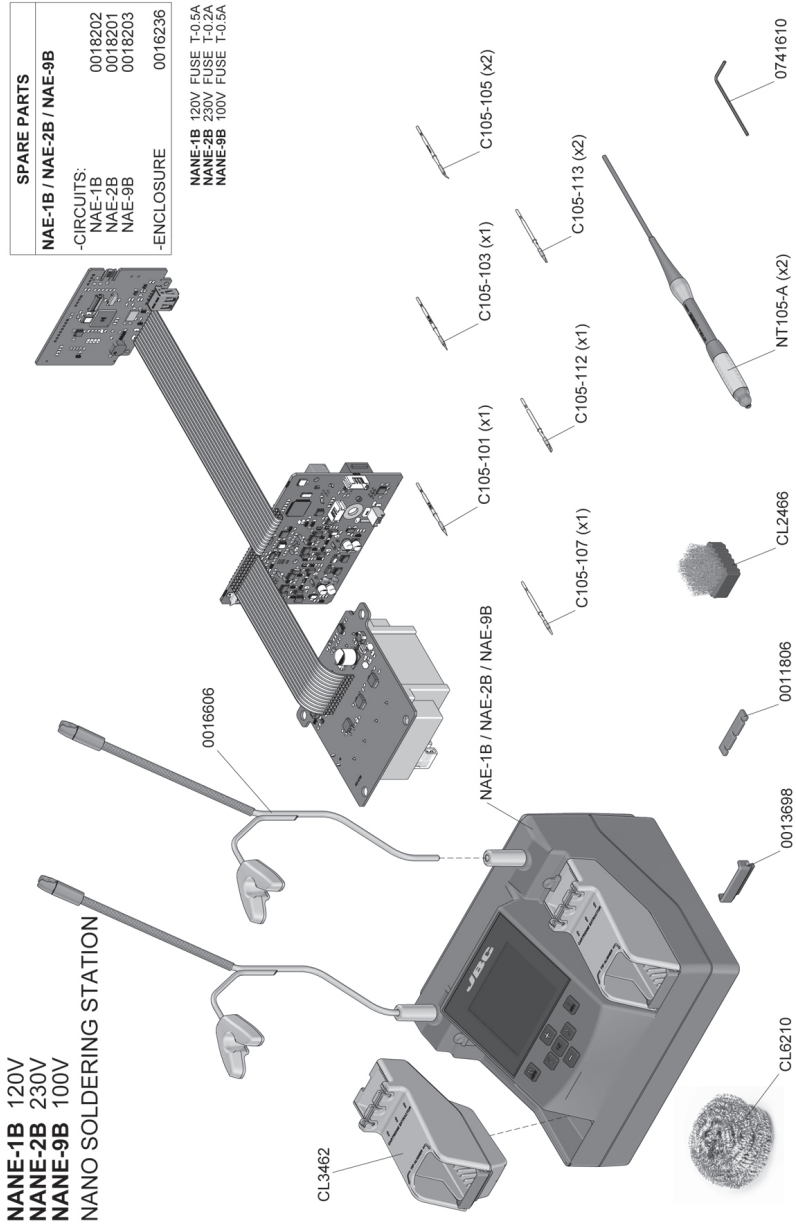





# Specifications

**NANE-1B** 120V 50/60Hz. Input fuse: 0.5A. Output: 8.5V

**NANE-2B** 230V 50/60Hz. Input fuse: 0.2A. Output: 8.5V

**NANE-9B** 100V 50/60Hz. Input fuse: 0.5A. Output: 8.5V

- Weight: 2.450 kg (5.40 lb)
- Dimensions: 170 x 90 x 135 mm
- Output Peak Power: 14W per tool
- Temperature Range: 90-450°C (190-840°F) ±5%
- Idle Temp. Stability (still air): ±3 °C (±5.5 °F)
- Tip to ground resistance: <2 ohms
- Ambient operating temp: 10 - 40 °C (50 - 104 °F)
- USB-A / USB-B / Pedal connectors
- RJ12 connector for Robot

Complies with CE standards  
ESD protected housing "skin effect"



## Warranty

JBC's 2 year warranty covers this equipment against all manufacturing defects, including the replacement of defective parts and labour.

Warranty does not cover product wear or misuse.

In order for the warranty to be valid, equipment must be returned, postage paid, to the dealer where it was purchased.



This product should not be thrown in the garbage.

In accordance with the European directive 2002/96/EC, electronic equipment at the end of their life must be collected and returned to an authorized recycling facility.



Manual in other languages available on our website

**[www.jbctools.com](http://www.jbctools.com)**