

# JBC

www.jbctools.com

## INSTRUCTION MANUAL



## High-Temperature Wire Stripper

Ref. WS-A

# Index

|                                 | Page  |
|---------------------------------|-------|
| 1. Packing List .....           | 3     |
| 2. Safety .....                 | 4     |
| 3. Features & Connections ..... | 5     |
| 4. Changing Cartridges .....    | 6     |
| 5. Cartridge Range .....        | 6     |
| 6. Adjustable Strip Gauge ..... | 7     |
| 7. Operation .....              | 8-10  |
| 8. Control Process .....        | 11    |
| 9. Maintenance .....            | 12    |
| 10. Notes .....                 | 13    |
| 10. Specifications .....        | 14-15 |

## Packing List

The following items are included:

**WS Control Unit** .....1 unit  
Ref. WS-1A (120V)  
WS-2A (230V)



**Stand** .....1 unit  
Ref. WS-SA



**High Temperature Stripper Tweezers**.....1 unit  
Ref. WS440-A



**Cartridge Holder** .....1 unit  
Ref. SCH-A



**Stand cable** ..... 1 unit  
Ref. 0011283



**Metal Brush**.....1 unit  
Ref. 0022793



**Power Cord** .....1 unit  
Ref. 0009417 (100V/120V)  
0009401 (230V)



**Manual** ..... 1 unit  
Ref. 0022824



## Safety

### Warning

- Do not touch the blade or the metal parts around.
- Do not allow the blade be close to flammable materials.
- Keep your workplace clean and tidy. Wear appropriate protection glasses and gloves when working to avoid personal harm.
- This appliance can be used by children over the age of eight and also persons with reduced physical, sensory or mental capabilities or lack of experience provided that they have been given adequate supervision or instruction concerning use of the appliance and understand the hazards involved.
- Maintenance must not be carried out by children unless supervised.
- Place the tool on the stand when is not in use.
- Turn off the power when not in use, changing parts or storing.

### Caution

- Do not use the Wire Stripper for other applications than wire stripping.
- Do not modify or customize the Wire Stripper.
- Do not hit the blade against workbench to eliminate stripped insulation debris, This behavior would damage the blade.
- Remove power from the tool by holding the plug, not the wires.
- Be careful with the fumes produced when stripping. We recomend to use our fume extractor.

## Features & Connections

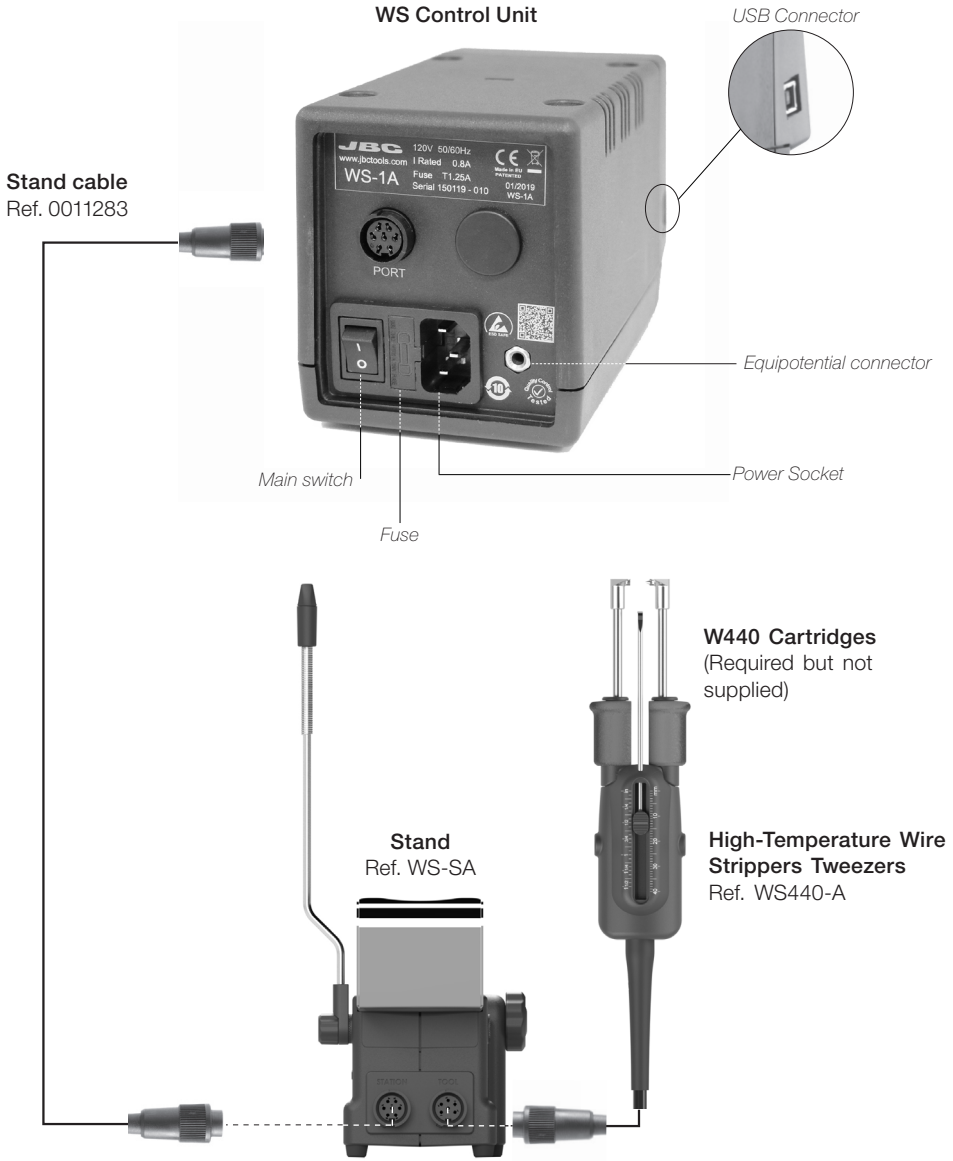

# Changing Blade Cartridges

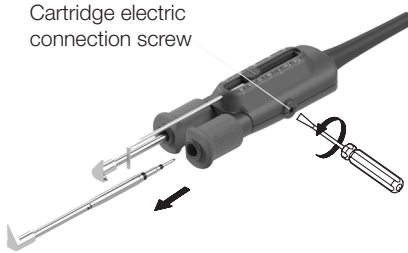

**WARNING:** It is essential to tighten this screw for the tool to function.

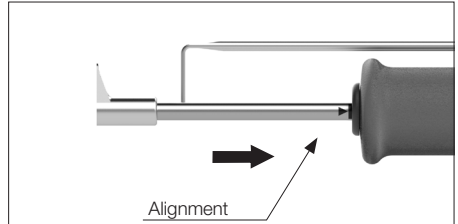

**Important:** It is essential to insert the cartridge till the end for a good connection. Take the mark  as reference and check that both tips of the tweezers match.

**W440 blade cartridges**, due to its design, has a proper centering to ensure a good functionality. Before tightening the screw, fix the cartridges in working position.

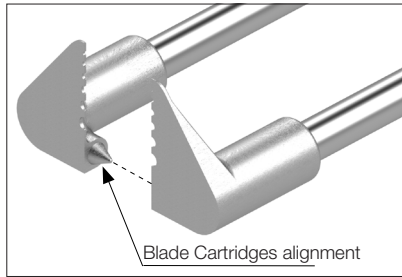

## Cartridge Range

The **WS440-A** works with **W440** blade cartridges. Find the model that best suits your soldering needs on [www.jbctools.com](http://www.jbctools.com).

### AWG (mm)

- 36 (0.127)
- 32 (0.202)
- 30 (0.255)
- 28 (0.321)
- 26 (0.405)
- 24 (0.511)

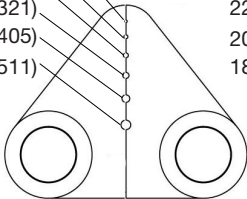

Ref. **W440-021**

### AWG (mm)

- 28 (0.321)
- 26 (0.405)
- 24 (0.511)
- 22 (0.644)
- 20 (0.812)
- 18 (1.020)

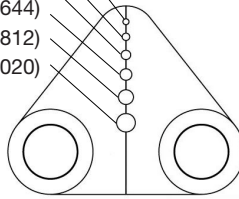

**W440-023**

Flat Blade (no holes)

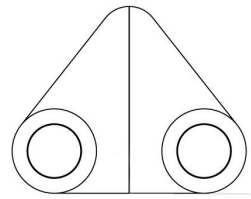

**W440-025**

For **special blade cartridges** contact us on [customtips@jbctools.com](mailto:customtips@jbctools.com)

## Adjustable Strip Gauge

Adjust the strip gauge according to your stripping requirements.

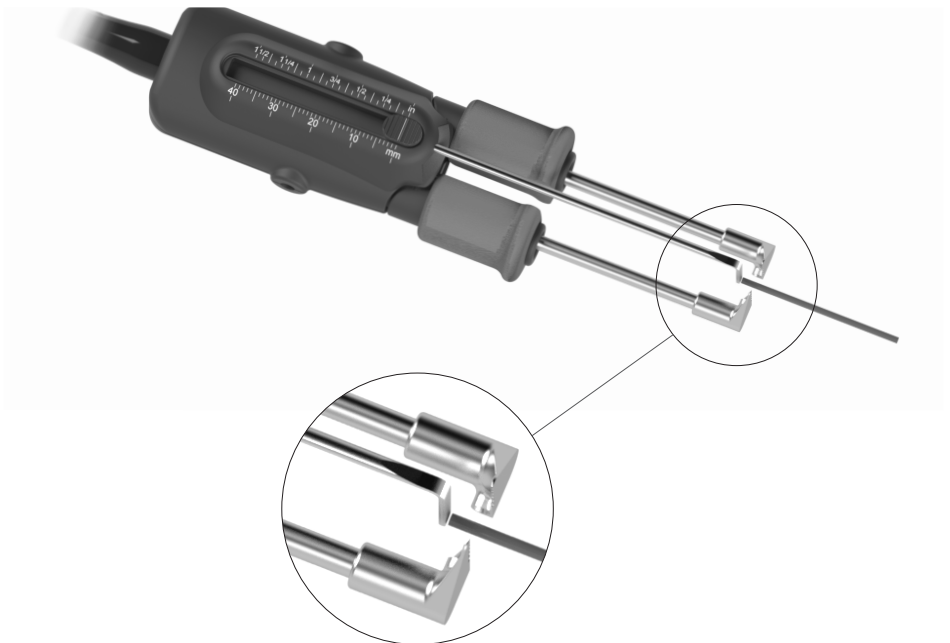
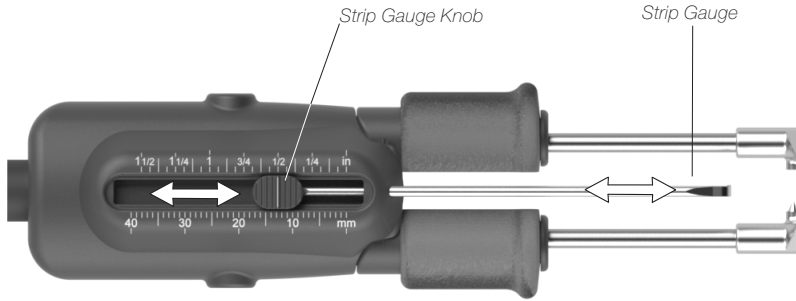

# Operation

The **WS** incorporates predetermined power levels and it also feature a customized working mode. It allows you to work on wire insulations made of thermoplastics and thermostable materials such as **teflon\***, **kapton\***, **silicone**, **rubber**, etc.

Programs included:

|                       | Insulation Material       | Symbol  | Power Level |
|-----------------------|---------------------------|---------|-------------|
| <b>Thermoplastics</b> | Polyvinyl Chloride        | PVC     | 13%         |
|                       | Polyethylene              | PE      | 15%         |
|                       | Nylon                     | PA      | 21%         |
|                       | Kynar <sup>2</sup>        | PVDF    | 31%         |
|                       | Tefzel <sup>1</sup>       | ETFE    | 34%         |
| <b>Thermostable</b>   | Teflon <sup>1</sup>       | FEP     | 31%         |
|                       |                           | PFA     | 41%         |
|                       |                           | PTFE    | 57%         |
|                       | Ethylene Propylene Rubber | EPM/EPR | 61%         |
|                       | Silicone Rubber           | SI      | 64%         |
| Kapton <sup>1</sup>   | PI                        | 87%     |             |

<sup>1</sup> Registered Trade Marks of DuPont

<sup>2</sup> Registered Trade Marks of Arkema



## How to Operate

### 1. Select Material Mode



After switching on the power, firstly you have to select the working mode. Press the screen buttons **UP** and **DOWN** to chose between all the materials.

### 2. Custom Mode



If you want to work on a customized mode, press **OK** and then use the **UP** and **DOWN** buttons to set up your own power configuration.

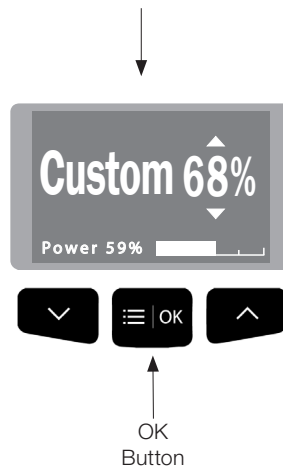
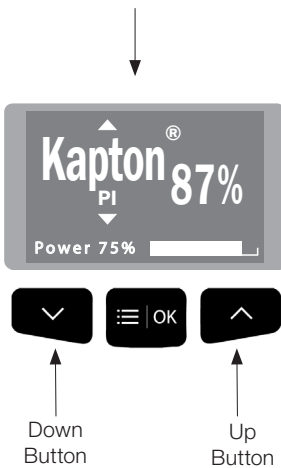

Once you choose any **Operation Mode**, you are able to begin the working process.

### 3. Work

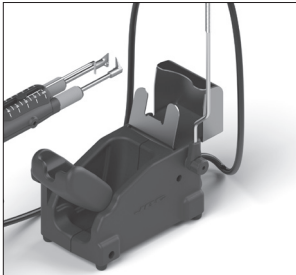

When the tweezers are lifted from the stand the tip will heat up to the selected material configuration.

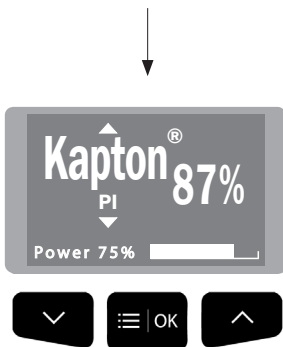

· Select material power level

### 4. Sleep

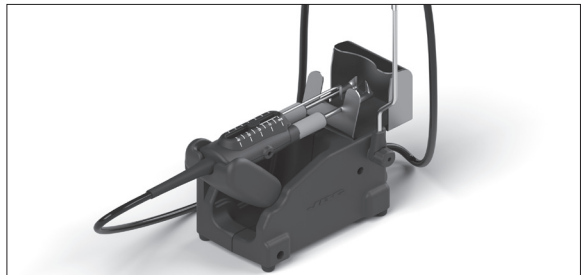

When the tweezers are in the stand, the power falls after a specified time.

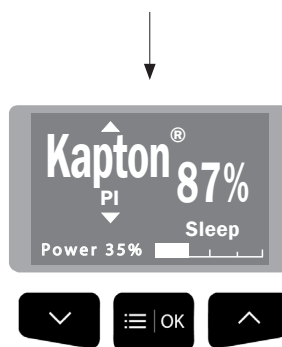

· Set Sleep delay  
(from 0 to 9 min or no Sleep)

### 5. Hibernation

After longer periods of inactivity, the power is cut off and the tool cools down to room temperature.

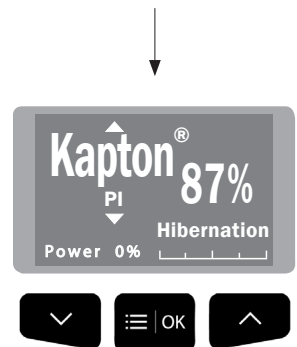

· Change Hibernation delay  
(from 0 to 60 min or no hibernation)

## Control Process

### Work Screen

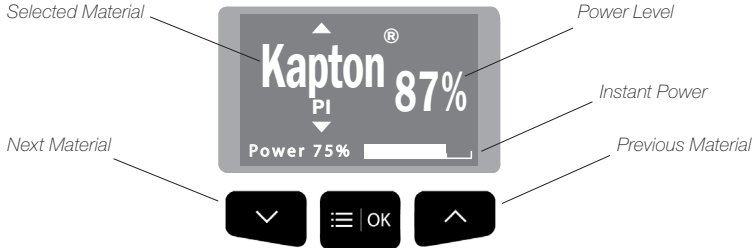

### Menu Screen

Press and hold  button to access the **Main Menu**

Default **PIN**: 0105

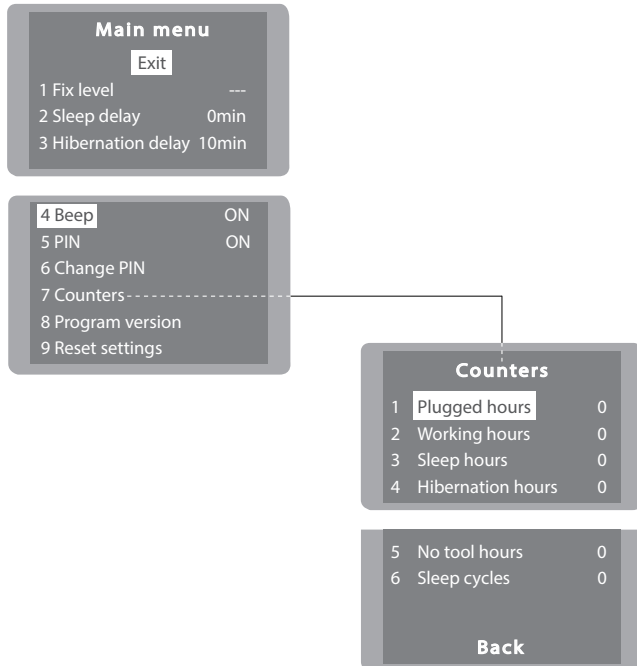

# Maintenance

Before carrying out maintenance or storage, always allow the equipment to cool and unplug the stand from the station and the tool.

- Clean the station screen with a glass cleaner or a damp cloth.
- Use a damp cloth to clean the casing, the stand and the tool. Alcohol can only be used for cleaning the metal parts.
- Periodically check that the metal parts of the tool and stand are clean so that the station can detect the tool status.
- Maintain tip surface clean in order to ensure a correct stripped wire.
- Periodically check all cables.
- Replace a blown fuse as follows (see specification chart) :



1. Pull off the fuse holder and remove the fuse. If necessary use a tool to lever it off.
2. Press the new fuse into the fuse holder and replace it in the station.

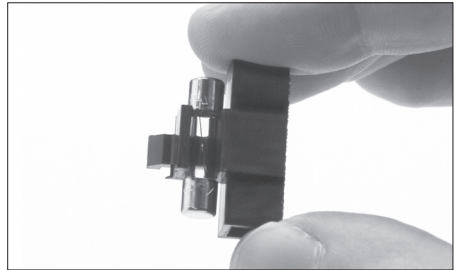

- Replace any defective or damaged pieces. Use original JBC spare parts only.
- Repairs should only be performed by a JBC authorized technical service.



# 有害物质含量表

产品中有害物质的名称及含量

| 部件名称 | 有害物质  |       |       |             |           |             |
|------|-------|-------|-------|-------------|-----------|-------------|
|      | 铅(Pb) | 汞(Hg) | 镉(Cd) | 六价铬(Cr(VI)) | 多溴联苯(PBB) | 多溴二苯醚(PBDE) |
| 烙铁头  | ○     | ○     | ○     | ○           | ○         | ○           |
| 手柄   | ○     | ○     | ○     | ○           | ○         | ○           |
| 电源线  | ○     | ○     | ○     | ○           | ○         | ○           |
| 主机   | ○     | ○     | ○     | ○           | ○         | ○           |
| 电源插座 | ○     | ○     | ○     | ○           | ○         | ○           |
| 保险丝  | ○     | ○     | ○     | ○           | ○         | ○           |
| 主开关  | ○     | ○     | ○     | ○           | ○         | ○           |
| 电位连接 | X     | ○     | ○     | ○           | ○         | ○           |
| 变压器  | ○     | ○     | ○     | ○           | ○         | ○           |
| 线路板  | X     | ○     | ○     | ○           | ○         | ○           |

○ 表示该有害物质在该部件所有均质材料中的含量均在GB/T 26572 规定的限量要求以下。  
 X 表示该有害物质至少在该部件的某一均质材料中的含量超出GB/T 26572 规定的限量要求。

## High Temperature Wire Stripper

### WS-1A / WS-2A

**WS-1A** 120V 50/60Hz. Input fuse: 1.25A. 5x20mm Output: 15V.

**WS-2A** 230V 50/60Hz. Input fuse: 0.63A. 5x20mm Output: 15V.

- Temperature Max : 800 °C (1472 °F)
- Idle Temp. Stability (still air):  $\pm 1.5$  °C /  $\pm 3$  °F
- Power: 75W
- Ambient operating temp: 10 to 50 °C (50 to 120 °F)
- Connections: USB-B
  
- Control Unit Weight: 2.2 kg (4.85 lb)
- Control Unit Dimensions: 90 x 105 x 180 mm (3.5 x 4.1 x 7.1 in)
  
- Total weight: 4.6 kg (10.1 lb)

Complies with CE standards.

ESD protected.

# JBC

---

## Warranty

JBC's 2 year warranty covers this equipment against all manufacturing defects, including the replacement of defective parts and labour.

Warranty does not cover product wear or misuse.

In order for the warranty to be valid, equipment must be returned, postage paid, to the dealer where it was purchased.

**Get 1 extra year JBC warranty by registering here:**  
<https://www.jbctools.com/productregistration/>  
**within 30 days of purchase.**

---



This product should not be thrown in the garbage.

In accordance with the European directive 2012/19/EU, electronic equipment at the end of its life must be collected and returned to an authorized recycling facility.



[www.jbctools.com](http://www.jbctools.com)