

Model 3520
pH/mV/Temperature Meter
Operating Manual

Safety

Please read this information carefully prior to installing or using this equipment.

1. The unit described in this manual is designed to be operated only by trained personnel. Any adjustments, maintenance and repair must be carried out as defined in this manual, by a person qualified to be aware of the hazards involved.
2. It is essential that both operating and service personnel employ a safe system of work, in addition to the detailed instructions specified in this manual.
3. References should always be made to the Health & Safety data supplied with any chemicals used. Generally accepted laboratory procedures for safe handling of chemicals should be employed.
4. If it is suspected that safety protection has been impaired in any way, the unit must be made inoperative and secured against any intended operation. The fault condition should immediately be reported to the appropriate servicing authority.

Model 3520 pH/mV/Temperature Meter Operating Manual

Contents

Section 1	Introduction	
	Instrument Description	1.1
	Instrument Specification	1.2
Section 2	Installation	
	Unpacking	2.1
	Installation	2.2
	Displays/Controls	2.3
	Inputs/Outputs	2.4
Section 3	Operation	
	Theory of pH measurement	3.1
	pH Measurement	3.2
	Preparation of Buffer Solution	3.3
	Solution Temperature Values	3.4
	Good Practice Guidelines	3.5
	Set-Up Parameters	3.6
	pH Calibration	3.7
	Error Codes	3.8
	mV Mode	3.9
	Performing Measurements	3.10
	Status Page	3.11
	Results Storage and Display	3.12
	GLP Functions	3.13
Section 4	Maintenance	
	General	4.1
	Cleaning/Re-conditioning of Glass Electrodes	4.2
Section 5	Optional Accessories	
	Optional Accessories	5.1
	Spares	5.2
Section 6	Interfacing	
	Analogue	6.1
	RS232	6.2
	Keypad Emulation	6.3
	Printing	6.4
Section 7	Troubleshooting	
	Troubleshooting	7.1
	Functional Checks	7.2
	Reset Procedure	7.3

EC Declaration of Conformity

Section 1

Introduction

1.1 Instrument Description

The Model 3520 is a fully specified laboratory pH/mV/Temperature meter that includes full support for good laboratory practices (GLP). The meter supports 1, 2 or 3 point pH calibration on either manually entered pH buffers or automatically temperature compensated buffers to DIN, JIS and NIST standards. Powerful data logging capabilities are included with the ability to store up to 500 readings either manually, at timed intervals or on alarm events.

1.2 Instrument Specification

pH (1, 2 or 3 point cal)

Range: -2.000 to 20.000pH

Resolution: 0.001 / 0.01 / 0.1pH

Accuracy: ± 0.003 pH

mV (Absolute or Relative)

Range: -1999 to +1999mV

Resolution: 0.1mV

Accuracy: ± 0.2 mV

Input Impedance: $>10^{12}$ ohms

Temperature Measuring

Ranges: -10 to +105°C / 14 to 221°F

Resolution: 0.1°C / 1°F

Accuracy: ± 0.5 °C / ± 1 °F

ATC Range: 0 to 100°C / 32 to 212°F

Manual Temp. Compensation: 0 to 100°C / 32 to 212°F

Auto Buffer Selection: Jenway (2.00, 4.00, 7.00, 9.20 and 10.00)

DIN (3.06, 4.65, 6.79, 9.23, 12.75)

NIST (1.68, 4.01, 6.87, 9.18, 12.45)

JIS (1.68, 4.01, 6.87, 9.18, 12.45) or manually entered buffers

Calibration: User selectable 1, 2 or 3 point

Outputs: Analogue 1mV per 0.01pH

RS232 serial and IrDA printer interface

Alarm - open collector

Clock: 24 hours, hrs/min/sec or day of month/month/year, leap year corrected (European and American formats)

GLP: Calibration reminder interval (1-999 hours)

Alarm outputs (open collector and audible)

Security code protected user data

Display: Back lit 1/8 VGA monochrome LCD

Languages: English, French, German, Italian, Spanish, Portuguese

Power: Power Supply 9Vac

Size: 275(l)x240(w)x150(d)mm

Weight: 850g

Section 2

Installation

2.1 Unpacking

Remove the Model 3520 from the packaging and ensure the following items are included:

1. Model 3520 pH/mV/Temperature Meter
2. Glass bodied combination pH electrode (924 005)
3. ATC probe (027 500)
4. Electrode holder
5. 4, 7 and 10pH buffer sachets
6. BNC shorting plug (009 146)
7. Power Supply (as specified at time of ordering the product)
8. Condensed operating instructions (352 051)
9. Operating Manual (352 050)

Any shortages or damage should be reported immediately to the manufacturer or your local distributor.

2.2 Installation

The Model 3520 is supplied ready to use. Connect the ATC (if required) and the pH electrode to the rear panel Temp and pH sockets.

The electrode stand requires minimal assembly (refer to the diagram below).

Fig. 2.2.1 Electrode Holder Assembly

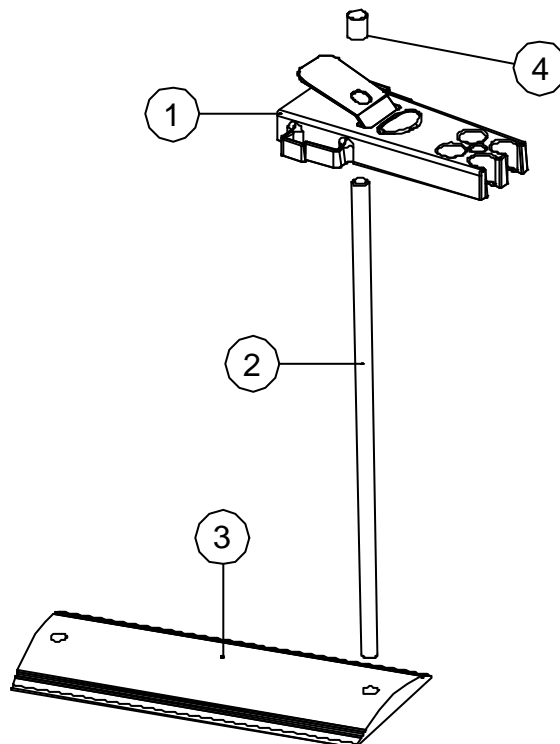

2.3 Display

Fig. 2.3.1 – Display

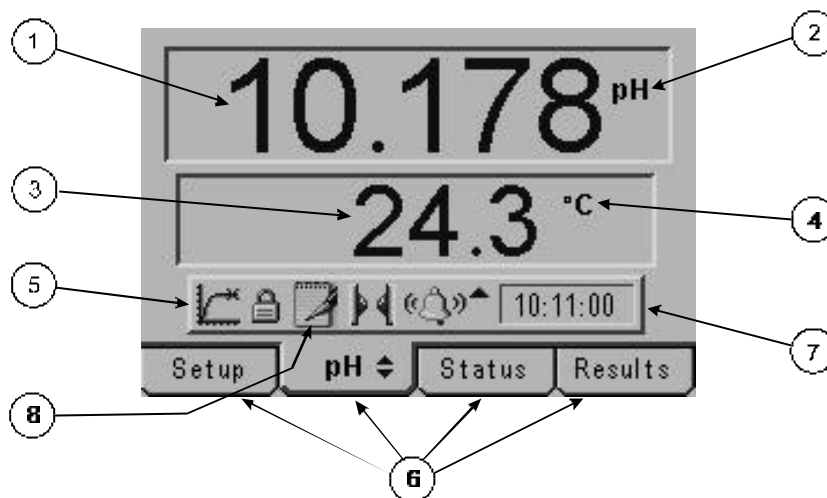

1. Primary display – 4½ digit. Provides direct readout in pH and millivolts of samples and standards.
2. Mode annunciators – shows selected measurement mode; pH, mV (Absolute and Relative).
3. Secondary display – 3½ digit display. Provides direct readout of automatic or manual temperature.
4. Mode annunciators – indicates temperature in °C or °F and whether the measurements are manually temperature compensated (MAN symbol).
5. Endpoint symbol – this symbol is displayed when an endpoint has been detected.
6. Mode tags – Each mode tag is highlighted when selected; SETUP, MODE (pH or mV), STATUS or RESULTS. If a double headed arrow symbol is present this indicates that the mode can be changed to an alternative option (pH/mV).
7. Real time clock - will display either date or time.
8. The following symbols will appear along the display:

Padlock - Set up parameters security locked

Notepad symbol - data logging to internal memory

IrDA status

Alarm indication - an Up arrow refers to Hi alarm / a Down arrow refers to Low alarm

2.4 Keypad

2.4.1 Keypad

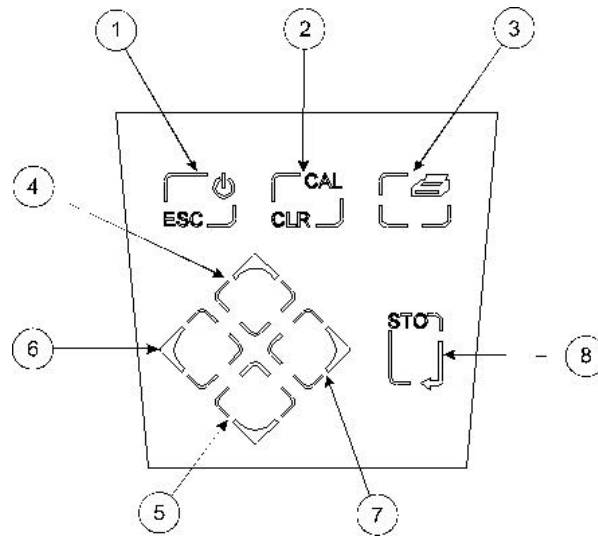

- | | |
|--------------|---|
| 1. ESC | used to switch the instrument on and to place into standby mode (only if power supply lead remains connected to the instrument). Also used to escape/exit a mode. |
| 2. CAL / CLR | used to select and perform a calibration sequence. This key is also used to clear readings from Memory. Used to select Abs/Rel mV in mV mode. |
| 3. Print key | used to initiate a print. |
| 4. Up Arrow | used for adjustment during set up, to scroll results and to toggle between mV and pH modes. |
| Down Arrow | used for adjustment during set up, to scroll results and to toggle between mV and pH modes. |
| Left Arrow | used for adjustment during set up and to move between mode tags. |
| Right Arrow | used for adjustment during set up and to move between mode tags. |
| STO | used to accept an entered value in set-up mode and to instigate a stored reading. This key can also be used as a CAL key during calibration. |

2.5 Inputs/Outputs

Fig. 2.5.1 – Rear panel layout

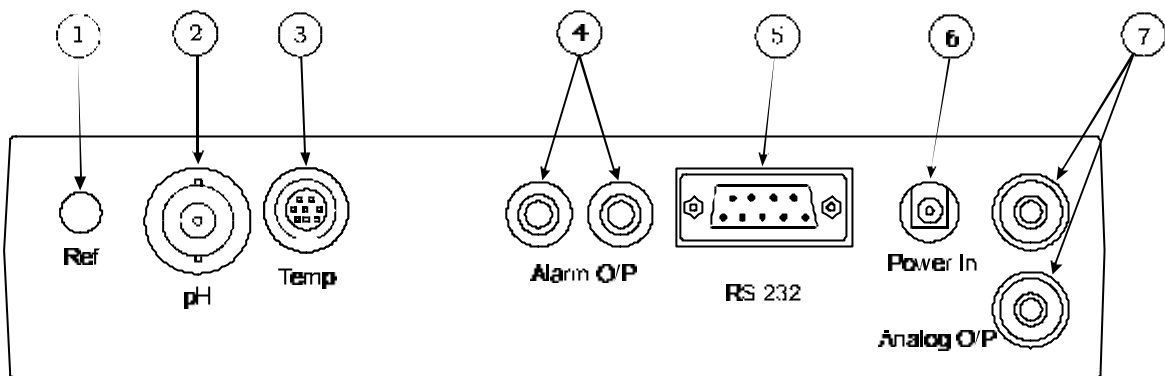

1. Ref Socket 2mm pin socket. Connection socket for separate reference electrode. When performing measurements with some pH and ion selective electrodes a separate reference electrode is needed.
2. pH Socket BNC type socket which allows combination pH or redox electrodes to be used.
3. Temp Socket 8 pin mini-DIN socket. This allows the optional Automatic Temperature Compensation (ATC) probe to be connected.
4. Alarm Output 2 x 4mm sockets. Open collector alarm outputs. Red for Hi / Black for Low.
5. Printer Socket 9 way socket for RS232 and IrDA connection.
6. Power In AC 9V I/P socket. 2.1 x 5.5mm socket allowing the power supply to be connected to the instrument.
7. Analog Out 2x4mm sockets. Analogue output (buffered electrode potential).

Section 3

Operation

3.1 Theory of pH Measurement

pH is a unit of measurement which defines the degree of acidity or alkalinity of a solution. It is measured on a scale of 0 to 14. The pH value quantifies the degree of hydrogen ion activity of an acid or a base.

The internationally accepted symbol, pH, is derived from “p”, the mathematical symbol of the negative logarithm and “H”, the chemical symbol for Hydrogen. The pH value is the negative logarithm of Hydrogen ion activity as shown in the mathematical relationship $pH = -\log[H^+]$.

The pH value of a substance is directly related to the ratio of the Hydrogen ion $[H^+]$ and the Hydroxyl ion $[OH^-]$ concentrations. If the concentration of H^+ is greater than OH^- , the material is acidic and has a pH value of less than 7. Conversely, if the concentration of OH^- is greater than H^+ the material is basic, with a pH value greater than 7. If the concentrations of H^+ and OH^- are equal the material is neutral with a pH value of 7.

It can, therefore, be seen that pH is a measurement of both acidity and alkalinity, even though by definition it is a selective measurement of hydrogen ion activity. The logarithmic relationship between hydrogen ion concentration and the pH unit means that a change of one pH unit represents a ten-fold change in hydrogen ion concentration.

3.2 pH Measurement

pH can be measured by using either pH papers/indicators or a pH meter, dependent on the level of accuracy required. pH papers or indicators change colour as the pH level varies. These can be used as a guide to the pH level, but can be limited in accuracy and difficult to interpret correctly in murky or coloured samples.

For greater accuracy the use of a high impedance pH meter is recommended, together with a pH measuring electrode and reference electrode.

Each component part of the measurement system can be described as follows:

- a) the pH meter – is a high impedance amplifier used to accurately measure the minute electrode voltages produced. The pH meter will display the results directly in pH units on either an analogue or digital display. Voltages can also be read for special applications, ORP (Oxidation-Reduction Potential) measurements or with Ion Selective Electrodes.
- b) the pH electrode – is a hydrogen ion sensitive glass bulb, with a millivolt output that varies with the changes in the relative hydrogen ion concentration inside and outside of the bulb. The pH electrode has very high internal resistance, making the voltage change with pH difficult to measure. The input impedance of the pH meter and leakage resistances are therefore important factors.
- c) the reference electrode – these cells consist of an internal element, usually a silver/silver chloride wire, electrolyte (KCl) and a liquid junction. The liquid junction provides a leak path for the internal electrolyte to “weep” into the sample chamber and provide an electrical contact with the liquid to be measured. If the liquid junction is inefficient then measurement will be inaccurate. It is common for the reference electrode to be incorporated into the pH electrode. It is then called a combination electrode. The Model 3520 is supplied with a combination electrode.

The voltage developed by each individual pH electrode in the presence of a known hydrogen ion concentration is theoretically predictable, but in practise deviations from the theoretical value can be expected. These deviations will change slowly during the life of an electrode. It is therefore essential to routinely calibrate the system using solutions with a known and constant pH value. These solutions are called buffers.

3.3 Preparation of Buffer Solutions

Care must be taken in the preparation of all buffer solutions. The correct quantity of distilled or deionised water should be used when preparing the solutions. For accurate and repeatable results it is essential to follow the manufacturers instructions carefully.

3.4 Solution Temperature Values

The value of all buffer solutions varies with solution temperature. For accurate calibration of electrodes using buffer solutions, it is necessary to measure the temperature of the buffer solution being used. The unit should then be calibrated to the corrected pH value. Manufacturers of buffer powders and solutions will provide a table of values at varying temperatures for their buffers.

Note: Buffer solutions will contaminate with exposure to air and should be stored in airtight containers when not in use. Used solution should be discarded and not returned to the container as this will cause contamination.

For best results fresh solutions should be prepared prior to calibration.

3.5 Good Practice Guidelines

The types of electrodes are many and various. For the majority of tests carried out on aqueous solutions, with a reasonable ionic strength; at ambient temperatures and with limited use in strongly acidic or alkaline solutions, the standard glass or epoxy bodied combination electrode is ideal. For other applications a more suitable pH/reference electrode pair may be required; details or advice supplied on request.

The following general guidelines indicate the care and maintenance required for the three main groups of electrodes (Combination, Reference and pH). For more detailed advice on specific electrodes contact the electrode manufacturer.

- 1)

After use	Rinse thoroughly with deionised water
Short term storage	Immerse in pH 4 buffer (all types)
Long term storage	Fit wetting cap filled with 3M KCl adjusted to pH 4.

- 2) Electrodes should be stored
 - a) away from direct sunlight
 - b) in a vertical position
 - c) within their specified temperature range

- 3) Always ensure the electrode is used within its specified temperature range. Degradation of electrodes used above their specified temperature is rapid and irreversible.

- 4) Ensure the level of fill solution is above the internal elements in the electrode and that this level remains above the sample in use.

- 5) **DO NOT** touch the sensitive glass pH membrane or reference junction during use. Excess droplets of solution may be removed by gently blotting with filter paper or tissue. **DO NOT** rub the electrode as this may induce an electrostatic charge.

- 6) Ensure no air bubbles are trapped at the bottom of the electrode. Removal of air bubbles is possible by holding the electrode vertically and gently tapping the electrode body. Larger bubbles may be removed by shaking the electrode in a downward direction.

- 7) During use ensure the electrode is rinsed in deionised water between each measurement to eliminate risk of contamination of solutions.

- 8) Ensure that the side port/inlet if present is uncovered, especially during a long run of tests.

- 9) For samples such as blood, serum or any measurements of Tris buffer solutions the junction may become badly clogged. For these measurements it is recommended that the Tris buffer electrode is used (924 030).

- 10) For applications associated with the measurement of food extracts, it is recommended that the Food electrode is used (924 051). This will reduce the risk of blockage from fat proteins, will be easy to clean and is perfect for measurements in agar media. This electrode is also recommended for measurements where deposits on the electrodes are likely. The flat surface is easy to clean and robust.

- 11) For low ionic strength applications the Environmental electrode (924 050) is recommended.

3.6 Set Up Parameters

The following section details the set-up modes available to the user on the main set up menu screen:



3.6.1 Instrument Setup

This option will allow the following parameters to be set:



- | | |
|--------------------|---|
| Exit | allows the user to exit this menu. |
| pH Resolution | allows the user to select the preferred resolution for the samples under test. Use the Up/Down arrows on the keypad to scroll between 0.001pH, 0.01pH and 0.1pH. |
| mV Resolution | allows the user to select the preferred resolution. Use the Up/Down arrows on the keypad to scroll between 0.1mV and 1mV. |
| Language | enables the selection of the appropriate language – English, French, German, Italian, Spanish or Portuguese. Use the Up/Down keys to scroll through the language options. |
| LCD Brightness (%) | enter the value using the keypad. Press the STO key to accept the value. |



3.6.2 Temperature Setup...

Select the Temperature Setup sub menu by highlighting the option and pressing the STO key. The following menu will be shown:

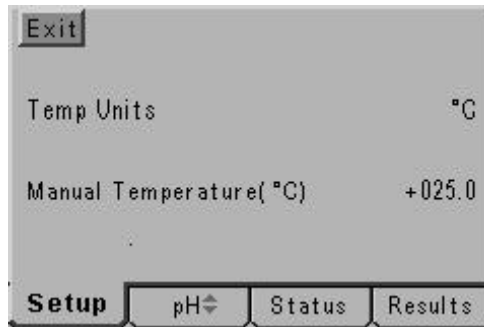

- Temp units allows selection of the preferred unit of measurement (either °C or °F) using the Up/Down keys which toggle between the two units.
- Manual temperature allows the manual temperature value to be set. Press the STO key to accept the value.

3.6.3 Calibration Set up ...

This option allows the following parameters to be set:

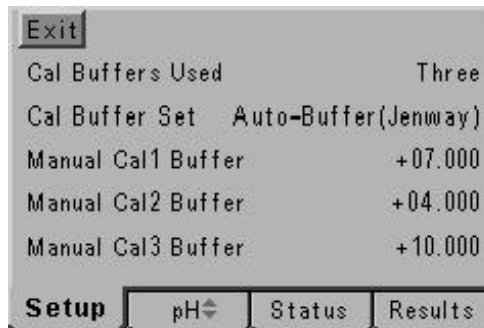

- Exit enables the user to exit the Setup menu and return to the main set up screen.
- Cal Buffers Used allows selection of 1, 2 or 3 point calibration.
- Cal Buffer Set allows selection to be made from the choice of buffer types available: Auto-Buffer (Jenway), Manual Entry, Auto-Buffer (JIS), Auto-Buffer (NIST) or Auto-Buffer (DIN).
- Manual Cal 1 allows Cal 1 manual buffer value to be set using the Up/Down keys. The Left/Right arrow keys allow forward and backward movement along the row of digits. Press the STO key to accept the value.
- Manual Cal 2 allows Cal 2 manual buffer value to be set using the Up/Down keys. The Left/Right arrow keys allow forward and backward movement along the row of digits. Press the STO key to accept the value.
- Manual Cal 3 allows Cal 3 manual buffer value to be set using the Up/Down keys. The Left/Right arrow keys allow forward and backward movement along the row of digits. Press the STO key to accept the value.

3.6.4 Alarms Setup...



- Exit enables the user to exit the Setup menu and return to the main set up screen.
- Alarm Outputs can be enabled or disabled by using the Up/Down keys which toggle between the two settings.
- Audible Alarm Warning can be enabled or disabled by using the Up/Down keys which toggle between the two settings.
- pH Alarm High allows the user to set the high alarm limit up to 20.000 pH.
- pH Alarm Low allows the user to set the low alarm limit down to -2.000 pH.
- mV Alarm High allows the user to set the high alarm limit up to +1999.9mV.
- mV Alarm Low allows the user to set the low alarm limit -1999.9 mV.

3.6.5 G.L.P Setup ...



- Exit enables the user to exit the Setup menu and return to the main set up screen.
- Cal Reminder can be enabled or disabled by using the Up/Down keys which toggle between the two settings.
- Cal Reminder Interval can be set within the limits of 001 to 999 hours by using the Up/Down keys. The Left/Right arrow keys allow forward and backward movement along the row of digits. Press the STO key to accept the value.
- Cal Reminder Audible Alarm can be enabled or disabled by using the Up/Down keys which toggle between the two settings.
- User ID up to a 4 digit code can be set using the Up/Down keys. The Left/Right arrow keys allow forward and backward movement along the row of digits. Press the STO key to accept the value

Batch ID up to a 3 digit code can be set by using the Up/Down keys. The Left/Right arrow keys allow forward and backward movement along the row of digits. Press the STO key to accept the value.

3.6.6. Security Setup ...

Select the Security Setup sub menu by highlighting the option and pressing the STO key. The following menu will be shown:

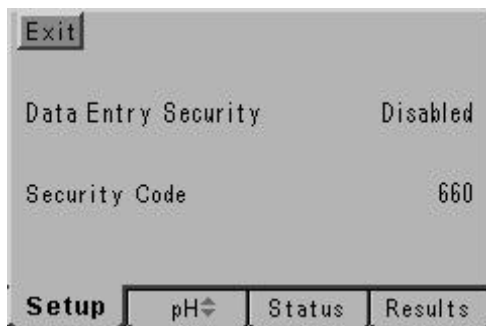

- Exit enables the user to exit the Set Up menu and return to the previous set up screen.
- Data Entry Security can be enabled or disabled by using the Up/Down keys which toggle between the two settings.
- Security Code up to a 3 digit code can be set by using the Up/Down keys. The Left/Right arrow keys allow forward and backward movement along the row of digits. Press the STO key to accept the value.

3.6.7 Data Logging Set up ...



- Exit enables the user to exit the Set Up menu and return to the main set up screen.
- Data Log Event can be enabled or disabled by using the Up/Down keys which toggle between the two settings.
- Data Log To allows the data to be sent to Memory or to the external Printer. Selection is made via the Up/Down keys which toggle between the two settings.

Data Log Interval	can be set between 00:00:01 and 23:59:59.
Memory Full	gives the user to select the Stop (cease storing results and not to overwrite existing stored information) or Overwrite (overwrite existing results) options when the memory is full. Selection is made via the Up/Down keys which toggle between the two settings.
Prompt Before Deleting	can be enabled or disabled by using the Up/Down keys which toggle between the two settings.
Clr Key	toggles between Deletes Results Before, Deletes All Results and Deletes Results Since. Selection is made via the Up/Down keys which toggle between the four settings.

3.6.8 Printer Setup ...

Select the Printer Setup sub menu by highlighting the option and pressing the STO key. The following menu will be shown:

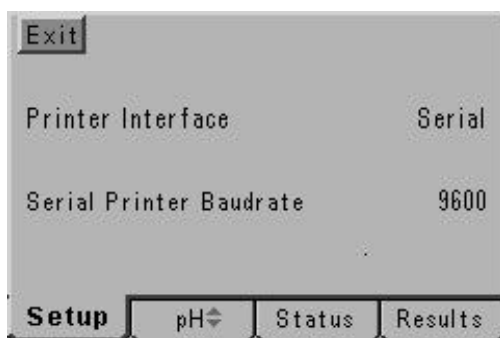

Exit	enables the user to exit the Setup menu and return to the main instrument display.
Printer Interface	toggles between Infrared and Serial. Selection of the preferred option can be made using the Up/Down keys which toggle between the two settings.
Serial Printer Baudrate	toggles between 9600 and 1200. Selection of the preferred option can be made using the Up/Down keys which toggle between the two settings. (Refer Section 6.2).

3.6.9 Endpoint Detection Set up ...

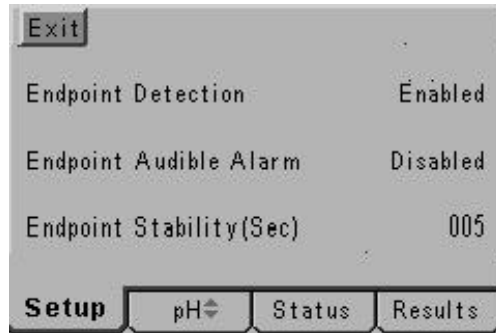

- Exit enables the user to exit the Set Up menu and return to the main instrument display.
- Endpoint detection can be enabled or disabled by using the Up/Down keys which toggle between the two settings.
- Endpoint Audible Alarm can be enabled or disabled by using the Up/Down keys which toggle between the two settings.
- Endpoint Stability (Sec) can be set within the limits of 001 to 999 seconds.

3.6.10 Clock Set up ...

Select the Clock Setup sub menu buy highlighting the option and pressing the STO key. The following screens will be shown:

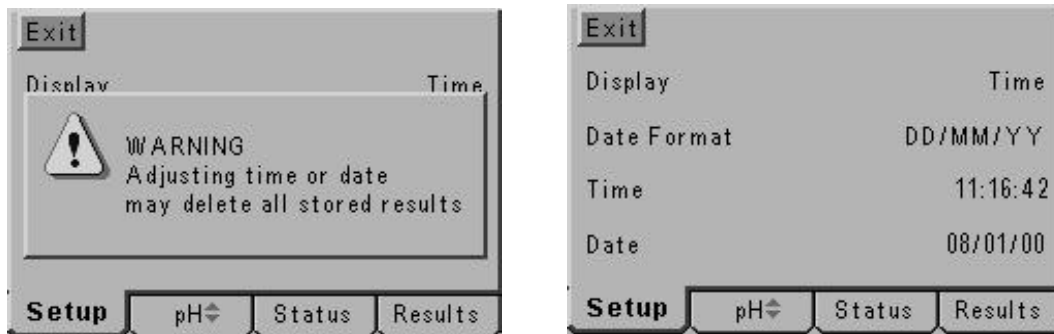

- Exit enables the user to exit the Setup menu and return to the main instrument display.
- Display toggles between Time and Date. Selection of the preferred option can be made using the Up/Down keys which toggle between the two settings.
- Date Format toggles between European (DD/MM/YY) and American (MM/DD/YY) formats. Selection of the preferred option can be made using the Up/Down keys which toggle between the two settings.
- Time allows time to be set (hrs/min/sec) using the Up/Down keys. The Left/Right arrow keys allow forward and backward movement along the row of digits. Press the STO key to accept the setting.
- Date allows date to be set (in previously selected format – European or American) using the Up/Down keys. The Left/Right arrow keys allow forward and backward movement along the row of digits. Press the STO key to accept the setting.

3.7 pH Calibration

3.7.1 Calibration with pH Buffers - Manual Temperature Compensation

To exit the calibration sequence at any time press the ESC key. This will cancel the pH calibration and return the instrument to the MODE menu.

Note: Buffer solutions should be carefully prepared as per the manufacturers instructions. When using manual temperature compensation (no ATC probe fitted) the solution temperature should be measured and the value entered in the set up menu prior to calibrating the instrument (refer 3.6.5). The buffer solutions should all be at the same temperature.

1. Select the pH measuring mode using the Up/Down arrows which toggle between pH and mV modes. Press the CAL key.

The primary display will show the current pH reading.

The secondary display will show the manually set temperature reading in °C or °F. When manual temperature compensation is being used the annunciator will indicate MAN.

2. Immerse the electrode(s) in the first buffer solution and allow the instrument to stabilise. When no pH change of less than 0.005pH is detected over a five second period the endpoint symbol will be displayed. The symbol display will show:

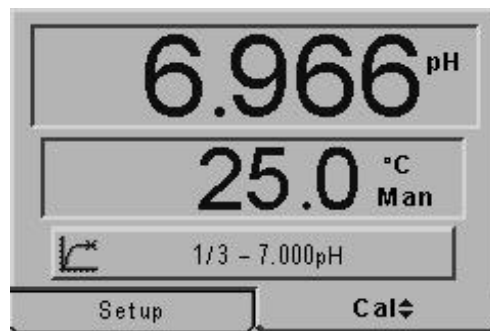

where 1/3 is the number of calibration points selected in the Calibration Setup menu. Value should show the manually temperature corrected value of the buffer used. Press the CAL or STO key.

The display will then show the next part of the calibration sequence if a 2 and/or 3 point calibration has been selected. If a 1 point calibration only is required the instrument will display CAL OK and the Eo value and then return to the main measuring screen. The current calibration information, including the Eo value can be found on the Status screens.

Rinse the electrode(s) in deionised water.

3. CAL 2 Immerse the electrode(s) in the second buffer solution and allow the instrument to stabilise. When no pH change of less than 0.005pH is detected over a five second period the endpoint symbol will be displayed.

The symbol display will show:



where 2/3 is the number of calibration points selected.
Value should show the manually temperature corrected value of the buffer used.
Press the STO or CAL key.

The display will then show the next part of the calibration sequence if a 2 and/or 3 point calibration has been selected. If a 2 point calibration only is required the instrument will display CAL OK, the Eo value and the slope efficiency and then return to the main measuring screen. The current calibration information, including the Eo value can be found on the Status screens.

Rinse the electrode(s) in deionised water.

3. CAL 3 Immerse the electrode(s) in the second buffer solution and allow the instrument to stabilise. When no pH change of less than 0.005pH is detected over a five second period the endpoint symbol will be displayed.

The symbol display will show:



where 3/3 is the number of calibration points selected.
Value should show the manually temperature corrected value of the buffer used.
Press the STO or CAL key.

The instrument will display CAL OK, the Eo value and the slope efficiency.
The instrument will return to the main measuring screen. The current calibration information, including the Eo value can be found on the Status screens.

Rinse the electrode(s) in deionised water.

Once a successful calibration has been completed the instrument will return to the measuring mode.

The instrument is then ready to undertake the measurement of unknown solutions. If the temperature of the unknown solution differs from the buffer, the Temperature Set up menu should be used to set the instrument display to the temperature of the unknown solution.

If the instrument fails a calibration the error message ERROR Eo OUTSIDE ± 30 mV LIMITS will scroll along the secondary display. (refer Section 3.8 for details of Error Codes).

3.7.2 Calibration with pH Buffers - Automatic Temperature Compensation

To exit the calibration sequence at any time press the ESC key. This will cancel the pH calibration and return the instrument to the MODE menu.

Note: Buffer solutions should be carefully prepared as per the manufacturers instructions. The buffer solutions should all be at the same temperature.

1. Select the pH measuring mode using the Up/Down arrows which toggle between pH and mV modes. Press the CAL key.
The primary display will show the current pH reading. The main display annunciators will indicate CAL 1 and the buffer type being used.
The secondary display will show the ATC temperature in $^{\circ}$ C or $^{\circ}$ F.

2. Immerse the electrode(s) in the first buffer solution and allow the instrument to stabilise. When no change in the least significant display digit is detected over a five second period the endpoint symbol will be displayed. Press the CAL or STO key.

The display will show:



where 1/3 is the number of calibration points selected in the Calibration Setup menu.
Value should show the STC value of the buffer used.
Press the CAL or STO key.

The display will then show the next part of the calibration sequence if a 2 and/or 3 point calibration has been selected. If a 1 point calibration only is required the instrument will display CAL OK and the Eo value and then return to the main measuring screen. The current calibration information, including the Eo value can be found on the Status screens.

Rinse the electrode(s) in deionised water.

3. CAL 2 Immerse the electrode(s) in the second buffer solution and allow the instrument to stabilise. When no pH change of less than 0.005pH is detected over a five second period the endpoint symbol will be displayed.

The symbol display will show:



where 2/3 is the number of calibration points selected.

Value should show the ATC value of the buffer used.

Press the STO or CAL key.

The display will then show the next part of the calibration sequence if a 2 and/or 3 point calibration has been selected. If a 2 point calibration only is required the instrument will display CAL OK, the Eo value and the slope efficiency and then return to the main measuring screen. The current calibration information, including the Eo value can be found on the Status screens.

Rinse the electrode(s) in deionised water.

3. CAL 3 Immerse the electrode(s) in the second buffer solution and allow the instrument to stabilise. When no pH change of less than 0.005pH is detected over a five second period the endpoint symbol will be displayed.

The symbol display will show:

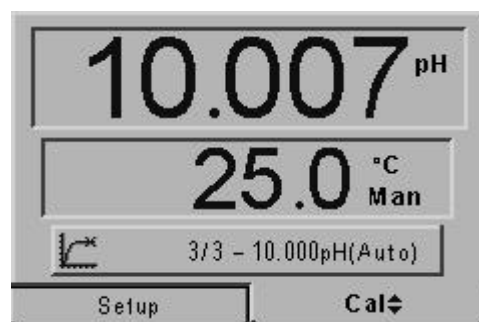

where 3/3 is the number of calibration points selected.

Value should show the ATC value of the buffer used.

Press the STO or CAL key.

The screen will display CAL OK, the Eo value and the slope efficiency.

The instrument will return to the main measuring screen. The current calibration information, including the Eo value can be found on the Status screens.

Rinse the electrode(s) in deionised water.

Once a successful calibration has been completed the instrument will return to the measuring mode.

The instrument is then ready to undertake the measurement of unknown solutions. If the temperature of the unknown solution differs from the buffer, the Temperature Set up menu should be used to set the instrument display to the temperature of the unknown solution.

If the instrument fails a calibration the error message ERROR E₀ OUTSIDE ± 30 mV LIMITS will scroll along the secondary display. (refer Section 3.8 for details of Error Codes).

3.8 Error Codes

ERROR E₀ OUTSIDE ± 30 mV LIMITS

This error message will be displayed when the mV value for a buffer is more or less than 30mV from the ideal Nernstian value.

ERROR SLOPE OUTSIDE 75% -125%LIMITS

This error message is displayed when the slope value is outside the range of 75 - 125%.

UNABLE TO RECOGNISE BUFFER

This error message will be displayed when the buffer value is more than 0.5 pH units from the set value.

3.9 Millivolt Mode

Absolute Millivolts

When this mode is selected the unit will display the actual voltage developed by the electrode when it is immersed in a solution containing ions to which the electrode is sensitive.

The electrode may be a combination type or a suitable sensing/reference pair, depending on the specific test being carried out.

pH, Redox and Ion Selective electrodes can all be used in this mode. Most of these determinations will require the preparation of calibration curves or other analytical methods to enable the mV reading to be converted to a concentration unit. For further information on these determinations refer to the electrode instructions, which will normally give details of calibration solutions, interferences and the limits of the methodology.

A very useful application of the Absolute mV range is for monitoring the performance of standard pH electrodes. Using accurate and fresh buffers at a constant temperature, the millivolt output of the electrode should be noted and compared to the theoretical ideal. As the electrode ages, becomes contaminated or dirty, these values will drift, indicating that corrective action should be taken.

Recording these values as part of a routine Quality Control program can give a good indication of the condition of the electrode.

Relative Millivolts

This mode is suitable for determinations using Redox and Ion Selective Electrodes and has the additional benefit of being able to zero any offset voltage developed by the electrode in a blank solution, i.e; a solution that has none of the ions to be measured, but has all the other characteristics of the unknown samples. A blank solution would normally have its ionic strength and pH adjusted as required for the electrode in use.

As the display is zeroed automatically when the Relative millivolt mode is selected, it is necessary to immerse the electrode in the blank solution with the Absolute mV mode selected. When the reading has stabilised the Relative mV mode should then be selected. The display will be set to zero, thereby removing any offset voltage.

Sample measurement is then carried out by using a variety of well tried analytical methods; from simple calibration curves through titrations, to single and multiple addition methods.

Select the mV mode using the Up/Down arrows which toggle between pH and mV modes.

The CAL/CLR key switches between Absolute and Relative mV. Relative mV is indicated by REL on the display.

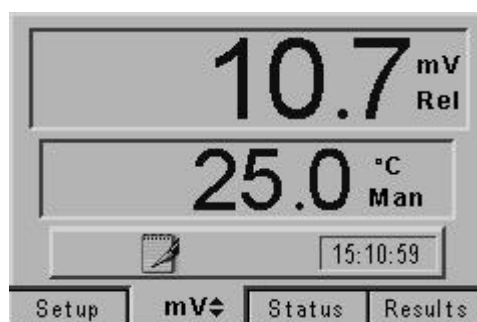
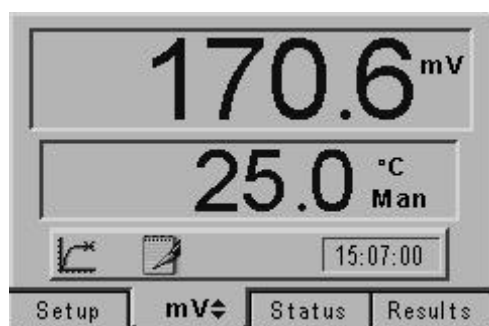

3.10 Performing Measurements

To perform measurements in pH, mV or temperature modes the following should be carried out:

1. **mV Measurement**
 - a) Connect the electrode to the unit via the BNC socket on the rear panel. If a separate reference electrode is to be used, this should be connected to the **Ref** socket.
 - b) Select **mV** mode using the Up/Down arrows. The display will show the electrode output directly in mV.

2. **Temperature Measurement (using ATC)**
 - a) Connect the ATC probe to the unit via the **Temp** socket on the rear panel.
 - b) Select **°C** or **°F** via the Set up menu.
The secondary display will show ATC probe temperature directly in °C or °F.

3. **Temperature Measurement (Manual)**
 - a) If Manual temperature compensation is being used, the preferred measurement range should be selected via the Set Up menu.
 - b) Immerse the electrode into the solution and set the to the solution temperature via the Set Up menu.

4. **pH Measurement**
 - a) Perform a calibration sequence using manual or automatic temperature compensation.
 - b) Immerse the electrode(s) into the solution to be measured and note the results once the reading has stabilised.

NOTE: Ensure the pH/Reference probe combination are compatible with the samples being measured. Non-compatibility may be indicated by drifting readings, noise or shortened electrode life. During use the electrode must be rinsed between each measurement to eliminate contamination of solutions. Excess droplets of solution may be removed by gently blotting with filter paper or tissue.
For further details refer to Section 3.5-Good Practice Guidelines.

3.11 Status Page

The Status page displays the current calibration information.

If no valid calibration data is stored (e.g. after a reset or a failed calibration) the warning screen:

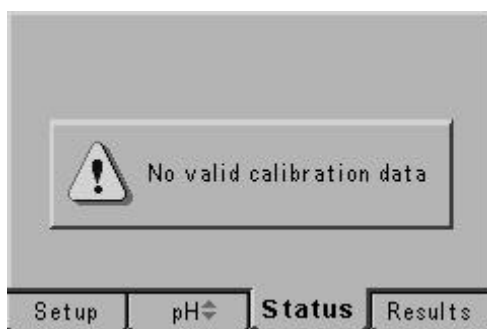

will be shown.

The status page will show the calibration data in the order it was carried out. Date, time, temperature, mV and pH readings will be displayed for each buffer.

The Eo value and slope efficiency are displayed at the bottom of the calibration information.

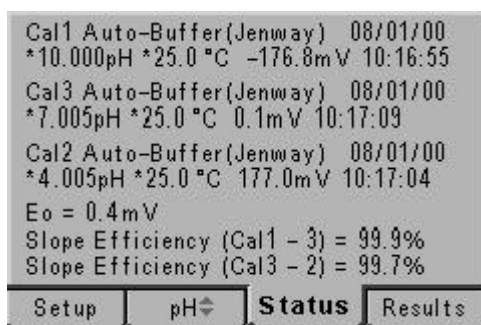

3.12 Results storage and display

The Model 3520 has a variety of options relating to the storage of data.



To initiate data logging the Data Log Event setting should be ENABLED.

By default this option is MANUAL.

The settings available are: Manual, Timed Interval, Endpoint Detection, Timed After Endpoint, Alarm Set, Alarm Clear, Alarm Set & Clear and Disabled. Press the Up/Down arrows to cycle through them.

- Manual** - logs results on pressing the STO key.
- Timed Interval** - logs on time and interval set by Data Log Interval in Hr:Min:Sec.
- Endpoint Detection** - logs data when the endpoint is detected.
- Timed After Endpoint** - logs at the Data Log Interval after the endpoint.
- Alarm Set** - data logs when the alarm set point is reached.
- Alarm Clear** - data logs when the alarm is cleared.
- Alarm Set & Clear** - data logs at the alarm set point and when the alarm condition clears.
- Disabled** - no data logging is possible when this option is selected.

The 3520 can log to either the memory or the printer. The memory can hold 500 data points which can be accessed via the Results screen.

When the memory is full there are two options available regarding any additional logging. The default is STOP.

- Stop** - when the memory is full no further data logging can occur until some locations are deleted.
- Overwrite** overwrites data from the earlier storage point.

To prevent the accidental erasure of data the "Prompt Before Deleting" option can be either Enabled or Disabled.

The function of the CLR key can also be set in this menu. The options define the use of the delete key.

- Disabled** - no manual deleting of results is possible.
- Deletes Results Before** - deletes all results before the selected data point.
- Delete Results Since** - deletes all results since the selected data points.
- Deletes All Results** - deletes all stored results.

3.12.1 Accessing Stored Results

To access results which have been stored use the Right arrow key to select results. The most recently stored results will be displayed on the screen. If more results are stored than can fit on a single screen then a series of data screens are available. The current screen and total number of screens are shown in the bottom right hand corner of the screen.

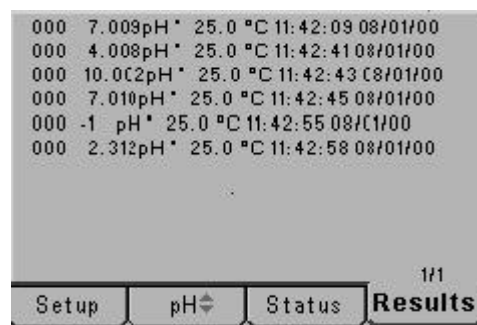

Other screens of data can be accessed using the Up/Down arrow keys.

The CLR key will delete data according to the set mode.

If the PROMPT BEFORE DELETING warning is set then a second CLR is required to delete results.

The PRINT key will print all stored data.

3.13 GLP Functions

A variety of GLP functions are available via the GLP Setup menu.



A reminder that calibration is due can be set via the Cal Reminder option. Once this option is set a valid calibration is required to use the 3520 after the time limit has elapsed. This option is DISABLED by default.

The interval time is set in hours on this menu.

NOTE: A calibration should be performed immediately after the setting of this value to reset the clock. This should be done as soon as set up is complete.

The on screen reminder can be accompanied by an audible alarm. This is set using the audible alarm setting on this menu.

NOTE: The use of the Calibration Reminder feature will prevent the user from performing measurements with the 3520 until a valid calibration is carried out.

The user and batch ID can be used to identify sets of samples and a specific user. This information is printed when data is output to the printer. The batch number is also stored in the results memory.

3.13.1 Security

To control access to set up options and data manipulation functions a security code can be set using this menu. When enabled a password is required to make any changes to the set up menus.

When the code is ENABLED a user can measure a sample, log data and calibrate the unit, but cannot change settings within the set up screens until a valid password is entered.

Section 4

Maintenance

4.1 General

The Model 3520 is designed to give optimum performance with minimum maintenance. It is only necessary to keep the external surfaces clean and free from dust. To give added protection when not in use the unit should be switched off and covered with the optional dust cover.

4.2 Cleaning/Re-conditioning of Combination Electrodes

For general purpose use, combination electrodes can be cleaned with a mild detergent solution or a commercial glass cleaning solution (provided these are not strongly acidic). The electrode surface should be wiped with a clean cloth soaked in the cleaning agent, and/or allow the membrane to stand in the solution until clean. Rinse and repeat as necessary. Electrodes which have been allowed to dry out should be soaked overnight in warm distilled water.

Table of Cleaning Agents for Glass Electrodes

Deposit	Cleaning Agent
General deposits	Genklene or mild detergent solution
Inorganic coatings	Commercial glass cleaning solution (not strongly acidic)
Metal compounds	Acid solution, not stronger than 1M
Oil/Grease	Complexing agent (EDTA) or suitable solvent
Resins/Lignins	Acetone, alcohol or detergent (not strongly acidic)
Proteins (blood, etc)	Enzyme solutions (e.g; pepsin in 0.1M HCl)
Stubborn deposits	Hydrogen peroxide, sodium hypochlorite or domestic bleach

Note: Solvents such as carbon tetrachloride, trichloroethylene, petroleum, ether, etc, MUST NOT be used for cleaning electrodes that have a plastic body or a plastic protective skirt.

Section 5

Optional Accessories

5.1 Optional Accessories

The following list of items are available as optional accessories for use with the Model 3520:

- 060 406** Dust cover
- 037 701** IrDA printer supplied with roll of thermal paper, serial connection lead, power supply, power connection lead (UK) and pouch
- 037 801** Interface cable kit
- 050 002** Serial communication software (3½" disk)

pH electrodes

- 924 001** General purpose, epoxy bodied combination, 12mm diameter. For liquids.
- 924 005** General purpose, glass bodied combination, 12mm diameter. For liquids.

For a complete listing of all available electrodes please contact your local distributor.

Buffer Solutions

- 025 163** 2.00 pH buffer (500ml)
- 025 037** 4.00 pH buffer (500ml)
- 025 038** 7.00 pH buffer (500ml)
- 025 162** 9.22 pH buffer (500ml)
- 025 039** 10.05 pH buffer (500ml)
- 025 179** pH 4 buffer sachets (pack of 10)
- 025 180** pH 7 buffer sachets (pack of 10)
- 025 181** pH 10 buffer sachets (pack of 10)

Redox Standards

- 025 157** 200mV @ 25°C (500ml)
- 025 158** 300mV @ 25°C (500ml)
- 025 159** 465mV @ 25°C (500ml)

Miscellaneous

- 025 160** 3M KCl Electrode Fill Solution (100ml)
- 025 161** Electrode Cleaning Solution (500ml)

5.2 Spares

- 924 005** pH combination electrode (glass bodied)
- 027 500** ATC probe
- 009 146** BNC shorting plug
- 037 702** Paper roll, thermal
- 021 030** UK 230V power supply
- 021 031** European 230V power supply
- 021 032** US 115V power supply
- 021 033** 230V leaded power supply

Section 6

Interfacing

6.1 Analogue

All units are provided with 2 x 4mm sockets, marked as ANALOG OUT, on the rear panel. An analogue output voltage of 1mV per least significant digit is available from these sockets. Recorder output $\pm 2000\text{mV}$, proportional to displayed reading:

- 1mV per 0.01pH (pH measurement and calibration modes)
- 1mV per 1mV (mV measurement mode)

6.2 RS232

The Bi-directional RS232 interface is available on the rear panel 9 way D type connector. The connections are as follows:

DCD 1	- LINKED TO DTR AND DSR
RXD 2	- INPUT TO 3520
TXD 3	- OUTPUT FROM 3520
DTR 4	- LINKED TO DCD AND DSR
GND 5	
DSR 6	- LINKED TO DCD AND DTR
RTS 7	- OUTPUT FROM 3520
CTS 8	- INPUT TO 3520

Suggested interconnections are detailed below:

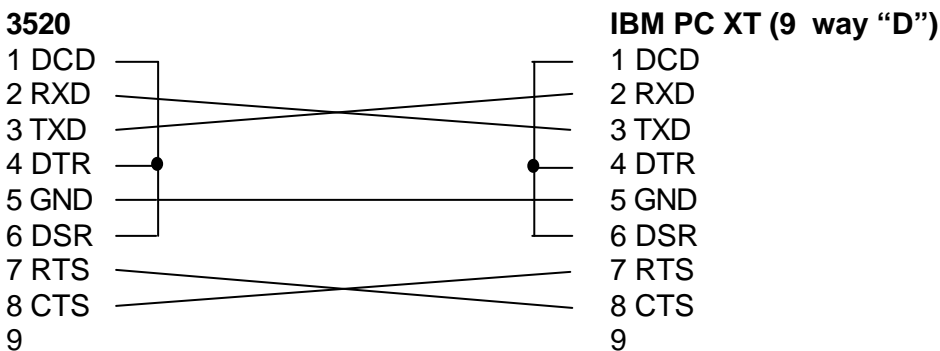
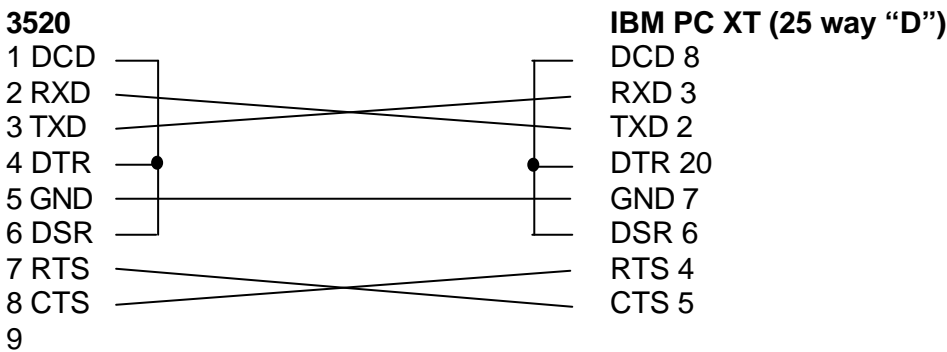

NOTE: Interface Cable (Order Code: 013 203) is required.

Interfacing (continued)

The RS232 communications parameters on the computer or printer need to be set to match those of the Model 3520, as detailed below:

1200 Baud		9600 Baud
7 Data Bits		8 data bits
Odd Parity	OR	No parity
1 Stop Bit		1 stop bit

Setting of these options is detailed in Section 3.6.6.

The Model 3520 supports both hardware (CTS/RTS) flow control and software XON/XOFF flow control.

Pressing the PRINT key outputs from the RS232 interface.

Sending an ASCII "D" to the 3520 causes a printout of the current displayed reading plus sample number.

Sending an ASCII "C" causes a printout of the last calibration parameters.

Sending an ASCII "P" causes a printout of the stored readings.

6.3 Keypad Emulation

Keypad remote control using RS232 interface:

7	- Instrument On / Standby / Escape
1	- Calibrate / Memory Clear
9	- Print
8	- Up Arrow
2	- Down Arrow
4	- Left Arrow
6	- Right Arrow
3 or 5	- Enter / Store

6.4 Printing

A 32 column serial printer (037 701) is available for use with the Model 3520.

There are two methods of connecting the serial printer to the Model 3520:

- a) IrDA - the IrDA interface is a line of sight, wireless communication protocol. The IrDA sensor (located on the front left hand corner of the printer) should be in line with the Ir window on the side of the 3520. The Ir icon on the symbol display indicates whether the units are attempting to connect (single icon flashing) or connected (two icons).
- b) Connect serial cable supplied with the printer to the 9 way socket located on the rear panel of the instrument.

To initiate a print out of data press the print key.

When the first print is performed a header section will be printed showing:

- Instrument name
- Time and Date
- Spacing for entry of Operator & User ID
- Operator ID number
- Most recent calibration information
- Eo value
- Slope efficiency
- Buffer type

This will be followed by results data in either pH or mV dependent on mode selected. Details will also be given on temperature. Time and date of the stored readings will be displayed.

An asterisk (*) indicates that manual temperature compensation is being used.

A reading in the Relative mV mode will be indicated by an R.

Each reading will be identified by a batch number.

A calibration will reset the printout and the header information will be re-printed.

To obtain a print out of stored readings, enter the RESULTS MODE and press the print key. A print out of all filled memory locations will then be generated.

6.5 Alarm Outputs

The 3520 provides two alarm outputs. These can be accessed using the two 4mm connectors on the rear of the 3520. They are open collector outputs. To set the alarm limits at which these are activated, please refer to section 3.6.4.

To use the alarm outputs, they should be ENABLED in the Alarms Setup screen see section 3.6.4 They will operate in both pH measurement and absolute millivolts. The alarm outputs will remain active until the alarm condition is no longer evident or the alarm limits are reset in the Alarm Set up menu.

For the Hi alarm output please use the Red 4mm phone connector.

For the Low alarm output please use the Black 4mm Phono connector.

For further information please contact your local distributor or the manufacturer.

Section 7

Troubleshooting and functional checks

7.1 Troubleshooting

Fault	Possible Cause	Action
No display	Check power supply	Check that correct 9V ac power supply is connected and switched on.
Erratic display	Check power supply	Unit must be used with supplied 9V ac power supply. Usage of other units will cause the 3520 not to operate.
Drifting erratic readings	Electrode fault	Use BNC cap to test 3520 (see 7.2) Replace electrode.
Cannot calibrate	Electrode Fault	Use BNC cap to test 3520 (see 7.2) Replace electrode.
ERROR EO ... ERROR SLOPE	Buffer problem Electrode problem	Use freshly prepared buffers. Use BNC cap to test 3520 (see 7.2) Replace electrode.
Unable to recognise buffers	Using correct buffer set	Is the buffer type correct? Use AUTO for Jenway supplied buffers. Replace buffers Use BNC cap to test 3520 (see 7.2) Replace electrode.
Temperature readings fluctuating	Temp probe faulty	Check 3520 using section 7.2 Replace temperature probe.
Temperature readings incorrect	Temp probe faulty Manual temp not set	Check 3520 using section 7.2 Replace temperature probe. Set meter to read °C and set temperature against a calibrated thermometer.
Will not print	IrDA Connection broken Paper out Battery flat	Line up units or alternatively use supplied RS232 connector. The feed light on the printer will flash if the unit requires paper. Connect ac power supply.

If the above does not answer your query try the FAQ section on the www.Jenway.com Website.

7.2 Functional check

The measurement function of the meter can be checked using the enclosed BNC shorting cap (009 146).

- 1) Remove the ATC probe if connected.
- 2) Set Manual temperature compensation to 25°C.
- 3) Remove pH probe and replace with BNC shorting cap.
- 4) Select mV mode the display should read ± 1 .

If the mV reading is greater than ± 1 mV perform a reset (refer Section 7.3).

To make measurements from this point refit the ATC probe and pH probe and calibrate the 3520 using fresh buffer solutions (see section 3.6).

Temperature input check.

Remove the temperature probe and apply a 10Kohm resistor across the pins of the temp input as described in fig 7.2.1

Fig 7.2.1 Temperature input with connection detail

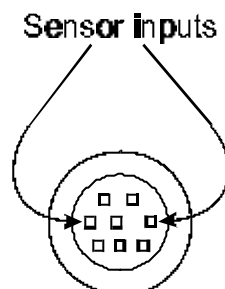

7.3 Reset Procedure

NOTE: Performing a reset will return all options to the default values. It will not delete stored data.

1. Remove AC power connector from the rear panel socket.
2. Press and hold the STO key.
3. Replace the AC power connector into the rear panel socket. The secondary display will momentarily show E2 RST.
4. If this does not resolve the problem please contact the manufacturer or your local distributor.

EC Declaration of Conformity

Jenway Model 3520 pH/mV/Temperature Meter complies with the following European Standards:

EN 50081-1:1992 Electromagnetic compatibility – Generic emission standard

EN 50082-1:1992 Electromagnetic compatibility – Generic immunity standard

EN 61010-1:2001 Safety requirements for electrical equipment for measurement, control and laboratory use

Following the provision of:

EMC Directive – 89/336/EEC and Low Voltage Directive – 73/23/EEC

Martyn J. Fall
Managing Director, Jenway
Gransmore Green, Felsted, Dunmow,
Essex, CM6 3LB, England