



DYNEO™ DD



english

## Immersion / Open Bath / Refrigerated Circulators Operating Instructions

Important: keep original operating manual for future use.

1.953.1300-V1

## Table of contents

<b>1</b>	<b>DYNEO DD Product Overview</b> .....	<b>5</b>
<b>2</b>	<b>Intended use</b> .....	<b>5</b>
<b>3</b>	<b>DYNEO DD - Description</b> .....	<b>6</b>
<b>4</b>	<b>Explanation of safety information</b> .....	<b>7</b>
4.1	Explanation of other information .....	7
<b>5</b>	<b>Safety instructions</b> .....	<b>8</b>
<b>6</b>	<b>Operator's responsibility - safety instructions</b> .....	<b>10</b>
6.1	Requirements for the operating personnel .....	10
6.2	Operating and ambient conditions for using the unit.....	10
6.3	Operating the unit.....	11
<b>7</b>	<b>Control and functional elements</b> .....	<b>13</b>
7.1	Installation of the circulator.....	16
<b>8</b>	<b>Preparations for operating the device</b> .....	<b>16</b>
8.1	Securing the immersion circulator .....	16
8.2	Closed stainless steel bath tanks.....	21
8.3	Basic refrigeration baths .....	22
8.4	Bath fluids .....	23
8.5	Temperature control for external connected systems .....	25
8.6	Tubing .....	26
<b>9</b>	<b>Commissioning</b> .....	<b>27</b>
9.1	Excess temperature and low level safety devices.....	27
<b>10</b>	<b>Filling</b> .....	<b>28</b>
10.1	Pump settings.....	29
<b>11</b>	<b>Display elements</b> .....	<b>30</b>
<b>12</b>	<b>Switching on/selecting language</b> .....	<b>32</b>
<b>13</b>	<b>Adjust safety</b> .....	<b>34</b>
13.1	Temperature limits.....	34
13.2	Adjusting setpoint limits .....	35

<b>14 Adjusting setpoint temperature/start/stop .....</b>	<b>37</b>
<b>15 Main menu.....</b>	<b>38</b>
15.1 Applying settings .....	38
15.2 Thermodynamic .....	42
15.3 Use programmer .....	48
15.4 Connecting unit with PC .....	56
15.5 Install unit.....	65
15.1 Record data .....	69
15.2 Service .....	71
<b>16 Emptying the bath tank.....</b>	<b>72</b>
<b>17 Technical data .....</b>	<b>73</b>
17.1 Technical data for circulator.....	73
17.2 Technical data for refrigeration circulation circulator .....	74
17.3 Refrigerant.....	78
<b>18 Materials for parts in contact with the medium .....</b>	<b>80</b>
18.1 Circulator .....	80
<b>19 Accessories .....</b>	<b>80</b>
19.1 For external connection .....	80
19.2 For open baths .....	80
<b>20 Maintenance, cleaning, storage .....</b>	<b>81</b>
20.1 Maintain the refrigeration capacity. ....	81
20.2 Cleaning.....	81
20.3 Storage .....	82
<b>21 Repair service.....</b>	<b>82</b>
<b>22 Waste disposal .....</b>	<b>83</b>
22.1 Packaging.....	83
22.2 Unit.....	83
22.3 Refrigerant.....	83
<b>23 Warranty.....</b>	<b>84</b>

## **Congratulations.**

You have made an excellent choice.

JULABO thanks you for the trust.

This operating manual is designed to familiarize you with the operation of our units and their possible applications. Please read the operating manual carefully.

Please call us if you have any questions about the operation of the unit or about the operating manual.

---



### **Contact:**

JULABO USA, Inc.

884 Marcon Boulevard

Allentown, PA 18109

Phone: +1 (610) 231-0250

Fax: +1 (610) 231-0260

info@julabo.us

www.julabo.us

---

## **The JULABO quality management system**



The standards for the development, production and distribution of temperature control devices for laboratory and industry use satisfy the requirements of ISO 9001 and ISO 14001. Registration certificate No. 01 100044846.

## **Unpacking and inspection**

If the packaging is damaged or if you discover any concealed transport damage when you have unpacked the devices and the accessories, please notify the supplier in the form of a statement of damage.





### **NOTICE**

The operating manual

- should be kept for future use.
- must be available to operating personnel at all times.

## 1 DYNEO DD Product Overview

The circulators of the DYNEO DD series can be combined with the transparent BT bath, stainless steel BC baths, and the refrigerated bath base unit.

Immersion circulator	Bath circulator	Refrigerated circulator
 <p data-bbox="126 647 393 699">DYNEO DD for bath tanks up to 50 l.</p>	 <p data-bbox="434 647 712 727">DYNEO DD BC6 for temperate control in an internal bath or an external application.</p>	 <p data-bbox="742 647 1016 727">DYNEO DD 601F for standard temperature control and routine tasks.</p>

## 2 Intended use

JULABO circulators are laboratory devices which are designed for the temperature control of certain liquid media in a bath tank or with a refrigeration unit. The bath fluids recommended by JULABO must be used as tempering media.

Units with pump connections allow the tempering tasks to be carried out in an external temperature control system.

JULABO circulators are not designed for the direct temperature control of foods, semi-luxury foods and tobacco, or pharmaceutical and medical products.

- Direct temperature control means unprotected contact between the object and the tempering medium (bath fluid).
- The devices are not suitable for use in potentially explosive environments.

## 3 DYNEO DD - Description

### Special features

- Internal and external applications
- Easy to switch between internal and external circulation
- Temperature range -50 °C to +200 °C
- Large color TFT display
- Easy to operate using the state-of-the-art turn & push controller
- Multi-lingual user interface
- Integrated programmer
- Heating capacity 2 kW ( 1 kW on 115 V models)
- USB interface
- Analog interfaces (optional)
- Class III (FL) according to DIN 12876-1
- Continuously adjustable, powerful pump
- External Pt100 sensor connection
- RS232 interface (optional)



### NOTICE

It is important to follow these safety instructions to prevent personal injury and property damage. These instructions apply in addition to the safety instructions at your workstation.

**It is essential that you read the user information before starting the device.**

## 4 Explanation of safety information



The operating manual contains warnings to increase safety when using the device. The general warning sign, consisting of an equilateral triangle surrounding an exclamation sign and reproduced in various signal colors, is preceded by the signal words.

"Warning of a danger zone".

The significance of the danger is classed with a signal word. Read the instructions carefully and follow them,



### **⚠ DANGER**

This signal word designates a danger with a high level of risk which, if not prevented, will result in death or serious injury.



### **⚠ WARNING**

This signal word designates a danger with a medium level of risk which, if not prevented, may result in death or serious injury.



### **⚠ CAUTION**

This signal word designates a danger with a low level of risk which, if not prevented, may result in minor or moderate injury.

### **NOTICE**

This signal word designates a possibly harmful situation. If it is not prevented, the system or something near it may be damaged.

### 4.1 Explanation of other information



#### **HINT**

Your attention is drawn to something special by this.

Designates user hints and other useful information.



#### **Dangers at second glance**

Designates states which only occur after the start of an action and could have been prevented if the warning had been heeded.



#### **Informative note**

Provides additional information.

## 5 Safety instructions

It is important to follow these safety instructions to prevent personal injury and property damage. These instructions apply in addition to standard safety practices for working places.

- It is essential that you read the user information before starting the unit.
- Use PPE (safety gloves, safety shoes, safety goggles).
- Transport the unit carefully. The interior of the unit can also be damaged by impacts or if it is dropped.
- Do not loiter under the unit during transportation and operation.
- The unit is not intended for use in potentially explosive areas.
- Please observe the specifications for the minimum space requirement when setting up the unit.
- Only operate the unit in rooms that are well-ventilated, dry and free of frost.
- Switch the unit off immediately if there is refrigerant leakage.
- Place the unit on a flat surface of non-flammable material.
- Operate the unit under an exhaust hood as much as possible.
- Do not start the unit if it is damaged or leaking.
- Compare the mains voltage and frequency with the specifications on the type plate.
- Only connect the unit to a fused mains connection via a FI circuit breaker ( $I_a=30$  mA).
- Only connect the unit to a power socket with ground contact (PE – protective earth)!
- The power supply plug serves as safe disconnecting device from the power supply network and must be freely accessible at all times.
- Check the mains cable regularly for signs of damage.
- Do not start the unit if it has a damaged power cable.
- Keep the mains cable away from hot pump connections.
- Refer to the safety sticker. Parts of the unit can be hot or cold.
- Never use the unit without bath fluid.
- Do not reach into the thermal bath fluid.
- Check the filling level of the bath fluid at regular intervals. The pump and heater must always be completely covered with bath fluid.
- Adjust over-temperature safety device below the flash point of the bath fluid.



- Consider the restricted working temperature range if you are using plastic bath tanks.
- Monitor the heat expansion of the bath oils as the bath temperature rises.
- Prevent water getting into hot bath oils.
- Use suitable tubing.
- Secure the tubing connections to prevent them sliding off.
- Do not bend the bath fluid tubing.
- Check the hoses at regular intervals for signs of material fatigue (for example cracking).
- Do not drain the bath fluid when it is hot.
- Check the temperature of the bath fluid before draining it, for example by switching on the unit briefly.
- Switch off the unit and pull the plug before moving the unit or carrying out service or repair work.
- Have all service and repair work carried out by authorized specialists only.
- Switch off the unit and disconnect it from the power supply before cleaning it.
- Drain the unit completely before transporting it.

## 6 Operator's responsibility - safety instructions

Products manufactured by JULABO GmbH ensure safe operation when installed, operated and according to common safety regulations. This section explains the potential dangers which may occur when operating the unit and specifies the most important safety measures to prevent these dangers as far as possible.

### 6.1 Requirements for the operating personnel

---

The operator is responsible for the qualifications of the personnel operating the unit. Ensure that the personnel who operate the unit are trained in the relevant work application by a trained person.

The operative must receive regular training about the dangers involved with their work and about action to prevent such dangers.

Ensure that everybody involved with the operation, maintenance and installation have read and understood the safety information and the operating manual. The unit may only be configured, installed, maintained and repaired by trained personnel.

If hazardous substances or substances which may become hazardous are used, the unit may only be used by a person who is completely familiar with these substances and the unit. This person must be able to assess the possible dangers in full.

### 6.2 Operating and ambient conditions for using the unit

---

- Avoid impacts on the housing, vibrations, damage to the operative keypad (keys and display) and heavy soiling.
- Ensure that the product is checked at regular intervals suitable for its frequency of use to ensure that it is in perfect condition.
- Check the proper condition of the mandatory warning, prohibition, and safety labels at least every 2 years.
- Ensure that the mains supply has a low impedance to prevent influencing of other units powered in the same mains.
- The unit is designed for operation in a controlled electromagnetic environment. This means that in an environment of this nature, transmission equipment such as mobile phones should not be used in the immediate vicinity.
- Other units with components which are susceptible to magnetic fields may be influenced by magnetic radiation. We recommend to maintain a minimum distance of 1 m.
- Permissible ambient temperature: max. 40 °C, min. 5 °C.
- The relative humidity should not exceed 50% (40°C).
- Do not store in an aggressive atmosphere. Protect from dirt.
- Protect from direct sunlight.

### 6.3 Operating the unit

The bath may be filled with flammable materials. **Fire hazard!**

Chemical dangers may occur, depending on the bath medium.

Refer to all warnings on the substances used (bath fluids) and in the relevant instructions (safety data sheets).

The formation of explosive mixtures is possible if the ventilation is inadequate.

Only use the units in well ventilated areas. The unit is not suitable for use in potentially explosive environments.

Special substance specifications (bath fluids) must be observed for correct operation. Caustic or corrosive bath fluids must not be used.

When using hazardous substances or substances which may be hazardous, the operator must apply the enclosed safety symbols (1 + 2a or 2b) on the control side panel where they are clearly visible:



3

**WARNING:** This product contains chemicals known to the state of California to cause cancer, birth defects or other reproductive harm.

Warning of a danger zone. Attention!  
Observe documentation. (Operating manual, safety data sheet)

It is essential that you read the user information prior to operation.  
Area of validity: EU

It is essential that you read the user information prior to operation.  
Area of validity: USA, NAFTA

Warning label Proposition 65

As a result of the wide range of operating temperatures, special care and caution is essential.

There are thermal dangers: Burns, scalds, hot steam, hot parts and surfaces which may be touched.



Warning about hot surfaces.

(The label is applied by JULABO)

### **If external units are connected**

Refer to the instructions in the manuals for the external units which you connect to the JULABO unit, particularly the safety instructions.

The connection assignment of the plugs and the technical data for the products must be observed at all times.

## 7 Control and functional elements

Front

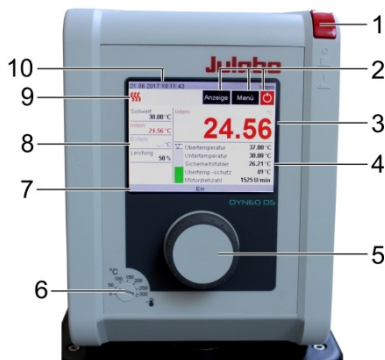

Rear

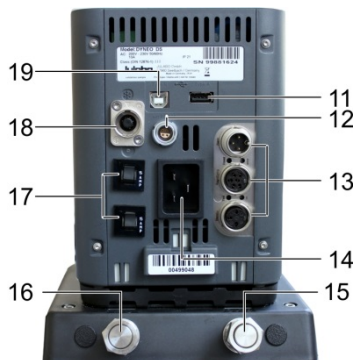

Position	Designation
1	Main switch
2	Operating elements: Display, menu, start/stop
3	Actual value display – internal/external
4	Display of safety values High temperature Low temperature Safety sensor High temperature cut-off Motor speed Liquid level indicator
5	Central controller
6	Adjustable excess temperature safety device
7	Unit status indicator (On/Standby)
8	Temperature displays Setpoint Internal temperature External temperature Performance display
9	Control indicator  heating / cooling
10	Date/time display, internal/external control, analog/digital actuating value specification

11	USB host interface (type A)		
12	Connection: external PT100		
13	Optional: Analog connections Alarm Reg-/Eprog Standby  RS232 interface		
14	Electrical connection: Integrated connector to supply power to the circulator (Power cord included in the scope of supply).		
15	Pump connection: Supply,	OUT	M16x1, external
16	Pump connection: Return,	IN	M16x1, external
17	Fuses: Miniature circuit-breakers, for refrigeration machine Resettable fuses for 600F refrigeration units (115 V, 100 V)		
18	CAN plug for connecting to the circulator.		
19	USB-Device-interface (Type B) for data transfer to PC, e.g. for control applications with the EasyTEMP software.		

## Refrigerated Circulators DYNEO DD 300F

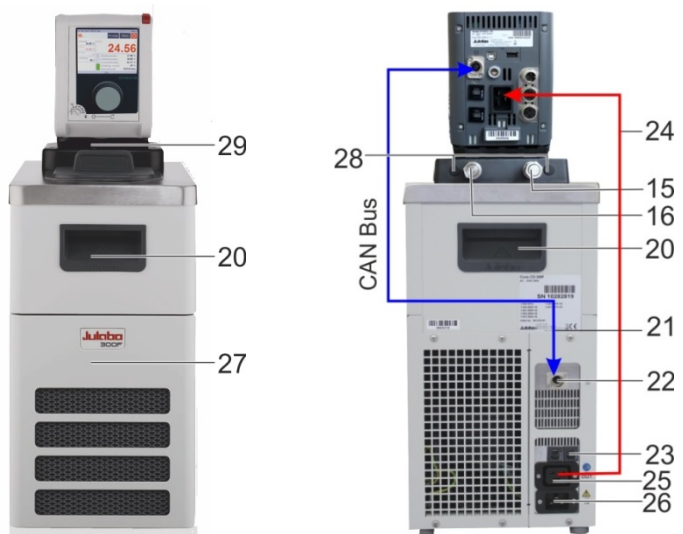

20	Recessed handle (front, rear)		
21	CAN connection cable for refrigeration machine circulator		
22	CAN plug for connecting to the circulator.		

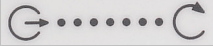
23	Fuses: Miniature circuit-breakers, for refrigeration machine
24	Connection cable: Voltage supply, refrigeration machine → circulator
25	Electrical connection: Integrated connector to supply power to the refrigeration circulator
26	Electrical connection: Integrated connector to supply power to the refrigeration machine
27	Drain tap and drain port (behind ventilation grille)
28	Caps (connectors for the cooling coil)
29	Pump switchover with DYNEO DD, Delivery  external.....internal

### Accessories, included in the supply



1x Main cable for voltage supply for the refrigeration machine (26) and circulator (14)  
(use one only for refrigeration circulator)



1x Connection cable: Refrigeration machine (25) → Circulator (14)

1x CAN connection cable (21)

Mains cable, country-specific, order number, see [www.julabo.com](http://www.julabo.com).

## 7.1 Installation of the circulator



### **CAUTION**

#### **Danger of scalding due to leaks from the baths**

The JULABO plastic baths are not solvent-resistant. JULABO plastic bath tanks are for water at a working temperature range from +20°C to +100°C.

Do not contaminate the bath fluid with solvents.

#### **Things to keep in mind during the installation process:**

### **WARNING**

#### **Risk of tipping due to improper transportation**

#### **Crushing, damage to the unit**

- Use PPE (safety gloves, safety shoes, safety goggles).
- Carry the unit with 2 persons (see the Technical Data for the weight).
- Transport the unit carefully on firm, level ground. The interior of the unit can also be damaged by impacts or if it is dropped.
- Do not loiter under the unit during transportation and operation.
- The installation site should be a sufficiently large room to ensure that it does not become too hot due to the heat emission.
- The surface for the device should be flat and made of non-flammable material.
- A specific room size is prescribed for refrigerated circulators.
- At high temperatures, position the unit under an exhaust hood as much as possible due to potential vapors from the thermal bath fluid.
- Observe the safety sticker - do not remove!

## 8 Preparations for operating the device

### 8.1 Securing the immersion circulator



### **WARNING**

#### **Danger of electric shock.**

Carefully secure the immersion circulator on the bath vessel. Poorly installed circulators can fall into the bath tank.

Have the unit checked by a service technician prior to re-use. The heater must not be in contact with the wall or the bottom of the bath tank. Minimum distance 15 mm.

Pull the plug to disconnect the unit from the power supply. Only then take the immersion circulator out of the bath tank.



A range of accessories is available for various applications:

- Bath clamp (for securing the circulator to baths)
- Bracket (for securing the circulator to JULABO refrigeration machines)
- Pump set (for connecting external applications)
- Cooling coil (for operating close to ambient temperature)
- Stand holder with rod (for securing to a laboratory stand)



**Bath attachment clamp, order No. 9970420**

- Pay special attention to the circulator's immersion depth (see Technical data) when selecting the bath.
- Place the bath on a flat surface on a pad made of non-flammable material.
- Secure the bath attachment clamp to the bath tank. The wall thickness may be up to 30 mm.
- Attach the circulator with a "click" to the bath attachment clamp.
- 



**Stand attachment, order No. 9970022**

For use with glass tanks a stand attachment with rod is available as an optional accessory.

The circulator must be mounted vertically and secured against rotation. If necessary, secure the nuts of the rod also.

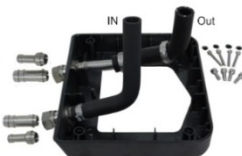

**Bracket, order no. 9970170**

## Installation on the circulator



Disassemble heater from circulator (Torx: 2.5 mm).



Slide bracket over pump.



Secure the bracket to the base of the circulator using the four screws.

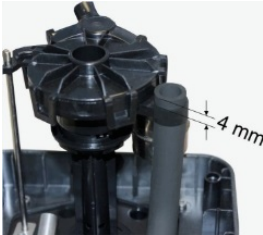

Push the end of the hose on the "IN" side into the holding device on the pump, until an excess end of approx. 4 mm is created.

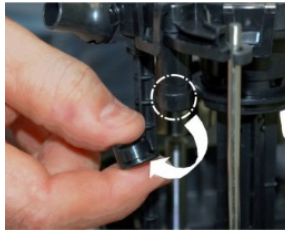

Remove the cap from the pump fitting.



Attach hose until it stops on the pump fitting. Label "PUMP >>..." in the direction of the pump fitting.



Fasten hose with 1-ear clamps (2x).



Insert heater and screw tight.



### Connecting an external system:

- Remove the union nuts and sealing plates from the pump connectors.
- The hose connectors can be used for hoses with M16x1 connections in this state.

Or:

- Secure hose barbs to the union nuts.
- Connect tubings and secure them with hose clips to prevent them sliding off.
- Connect the hoses for the supply and return to the pump connectors and the external consumer and secure them with hose clips.
- Switch the pump function to external circulation.



### Pump set, order No. 9970141

#### Installation on the circulator

- Push the end of the tubing on the "OUT" side on to the port on the pump.
- Secure against slipping using the tube clamps.
- Push the end of the tubing on the "IN" side on to the holding device on the pump.
- Secure the pump housing to the base of the circulator using the two screws.
- Attach the circulator to the bath clamp.  
The total immersion depth will be reduced due to the pump set.

#### Connect an external system (also applies to bracket)

- Remove the union nuts and sealing plates from the pump connectors.
- The hose connectors can be used for tubing with M16x1 connections in this state.

Or:

- Secure barbed fittings to the union nuts.
- Connect tubing and secure them with tube clamps to prevent them sliding off.
- Connect the tubing for the supply and return to the pump connectors and the external consumer and secure them with tube clamps.
- Switch the pump function to external circulation.



## **Cooling coil, order No. 9970100**



A cooling coil is required for working at around ambient temperature (20 °C) A cooling water flow rate of 45 ml/min is generally sufficient to compensate for the intrinsic temperature.

The cooling water temperature should be at least 5 °C lower than the working temperature.

---

## **Install the cooling coil on the pump set**



- Remove the caps from the pump set.
  - Insert the ends of the cooling coil through the fastening boreholes and secure them with the washers and hex nuts.
  - Install the connection ports to the cooling coil.
  - Slide the cooling water hoses over the connection ports and prevent slipping.
- 

## **Bracket with cooling coil, order No. 9970171**

### **Install the cooling coil on the bracket**



- Remove the caps from the bracket.
  - Slide the ends of the cooling coil through the fastening boreholes.
  - Secure them with the washers and hex nuts.
  - Install the connection ports to the cooling coil.
  - Slide the cooling water tubing over the connection ports and prevent slipping.
-

## 8.2 Closed stainless steel bath tanks



### Intended use

JULABO BC4, BC6, BC12 and BC26 closed stainless steel baths can be combined with JULABO circulators from the CORIO or DYNEO product series. When combined with these circulators they are designed for controlling the temperature of JULABO recommend liquid media.

### Technical details for the sealed baths

The circulators feature the bracket which is secured to the baths.

Type		BC4	BC6	BC12	BC26
Order No.		9905504	9905506	9905512	9905526
Temperature range	°C	+20...+150			
Approx. weight	kg	5.2	6.4	8.2	15.0
Dimensions (WxDxH*)	cm	23x41x42	24x44x47	33x49x47	39x62x48
Useful bath opening (WxLxD), inner	cm	13x15x15	13x15x20	22x15x20	22x30x20
Filling volume Min. ... Max.	l	3.0...4.5	4.5...6.0	8.5 ... 12.0	19.0 ...26.0
Materials for parts in contact with the medium		Bath and drain cock: 1.4301 / 304H Bath/Bath cover seal: FKM Viton® O-ring on drain cock: FKM Viton®			

\* / with circulator

## 8.3 Basic refrigeration baths



### Intended use

The basic refrigeration baths can be combined with JULABO circulators of the CORIO and DYNEO product series. In combination with these circulators, they are intended for the temperature control of liquid media (bath fluids).

### Technical details for basic refrigeration baths

The bracket is required for installation on the circulator.

Type		200F	201F	300F	600F
Order No.		9461701	9461702	9461703	9461704
Temperature range	°C	-20...150	-20...150	-25...150	-35...150
Weight	kg	26,0	25,0	28,0	36,0
Dimensions (WxDxH*)	cm	23x39x65	44x41x44	24x42x66	33x47x69
Useful bath opening (WxLxD), inner	cm	13x15x15	13x15x15	13x15x15	22x15x15
Filling volume Min. ... Max.	l	3,0...4,0	3,0...4,0	3,0 ... 4,0	5,0 ...7,5
Materials for parts in contact with the medium		Bath and drain valve: 1.4301 / 304H Bath/Bath cover seal: FKM Viton® O-ring on drain valve: FKM Viton®			

Type		601F	900F	1000F	1001F
Order No.		9461705	9461706	<b>9461707</b>	<b>9461707</b>
Temperature range	°C	-40...200	-40...200	-40...150	-38...100
Weight	kg	36,0	52,0	49,0	68,0
Dimensions (WxDxH*)	cm	36x46x74	39x62x75	42x49x70	45x64x77
Useful bath opening (WxLxD), inner	cm	22x15x20	26x35x20	18x13x15	35x41x30
Filling volume Min. ... Max.	l	8,0...10,0	21,0...30,0	5...7,5	42...56
Materials for parts in contact with the medium		Bath and drain valve: 1.4301 / 304H Bath/Bath cover seal: FKM Viton® O-ring on drain valve: FKM Viton®			

\* / with circulator

## 8.4 Bath fluids



### **WARNING**

**Danger of burns and property damage if unsuitable bath fluid is used.**

- Only use thermal oils which are recommended by JULABO. The viscosity of the oil is tailored to the pump capacity.
- Refer to the safety data sheet of the bath fluid, particularly its flash point.
- Set the excess temperature protector correctly.
- Always store bath fluid so that it cannot harm the environment.

There is a selection of recommended bath fluids on the JULABO homepage at [www.julabo.com](http://www.julabo.com). Do not exceed the maximum viscosity of 50 mm<sup>2</sup>/s when you select your product.

### Water as the bath fluid

#### **NOTICE**

##### **If you use water as the bath fluid**

Recommended water mixture:

70 % soft/decalcified water and 30 % tap water for a temperature range from 5 °C to 80 °C.

The parts of the bath which come into contact with the bath fluid may be damaged and cause the failure of the device.

The water quality depends on the local conditions.

- Hard water is not suitable for temperature control tasks due to its high lime content and will produce lime deposits in the bath.
- Ferrous water can cause corrosion, even on stainless steel.
- Chloric water can cause pitting corrosion.
- Distilled and deionized water is not suitable. Their specific properties cause corrosion in the bath, even on stainless steel.
- Check the quality of the water you use at regular intervals.
- Evaporation and constant refilling may produce a concentration of harmful substances in the bath.

You should therefore check the quality of the water in the bath at regular intervals.

- Replace the water in the bath in full at regular intervals.



## **⚠ CAUTION**

### **Unsuitable bath fluids.**

JULABO cannot accept any liability for damage caused by the selection of an unsuitable **bath fluid**.

Unsuitable products include **bath fluids** which

- are highly viscous (much higher than recommended at the relevant working temperature).
- tend to crack.
- have a toxic, caustic or corrosive effect.



## **⚠ CAUTION**

### **Properties of indirectly temperature-controlled fluids and substances**

The intended use of the units includes the indirect temperature control of fluids.

We do not know which substances these are.

Many substances are:

- inflammable, flammable or explosive
- harmful
- polluting

### **In other words: dangerous**

The user bears sole responsibility for handling these substances!

Use personal protective equipment!

The following questions should help to identify possible dangers and minimize risk.

- Are hazardous vapors or gases produced when heated?  
Does operation of the bath has to be conducted in a fume hood?
- What should you do if a dangerous substance has been spilled on or in the device?  
Obtain information on the substance before starting work and define a decontamination method.
- Are all hoses and electrical cables securely connected and routed?  
Keywords: Sharp edges, hot surfaces during operation, moving machine parts, etc.





## 8.5 Temperature control for external connected systems



### CAUTION

**Danger from the incorrect use of external connected systems.**

**Unsuitable materials may cause the failure of the system.**

**Check the externally connected systems for the following:**

- Compression strength.
- Corrosion resistance.
- Check the materials used for parts in contact with the medium.

The circulator is designed for the temperature control of external connected systems (temperature control system).

#### Connect an external system

Remove the union nuts and sealing plates from the pump connectors.

The tube connectors can be used for tubing with M16x1 (internal) connections in this state.

Tighten the connections with a maximum torque of 3 Nm, holding the nuts (a.f. 17 mm) as you do so.



#### Second method

Secure barbed fittings to the union nuts. Tighten the connections with a maximum torque of 3 Nm, holding the nuts (a.f. 17 mm) as you do so.

Connect tubing and secure them with tube clamps to prevent them sliding off.

Connect the tubing for the supply and return to the pump connectors and the external consumer and secure them with tube clamps.

Switch the pump function to external circulation.



## 8.6 Tubing



### **CAUTION**

#### **Danger of injury from defective tubing.**

The bath fluid tubing is a potential source of danger at high working temperatures. Large volumes of hot bath fluids can be pumped out of a damaged tubing in a short period of time.

#### **Possible consequences:**

- Skin burns
- Breathing problems due to the hot atmosphere

#### **Danger from unsealed pump connections.**

- If the pump connections are not sealed, bath fluid may be pumped out without any control.
- Set the lever on the pump to internal circulation.
- Unused pump connections must always be sealed with sealing screws.

#### **Danger from the incorrect use of tubing.**

- The tubing must be suitable for the pressure and temperature range which results from operation and for the bath fluid (for example silicon oil must not be used with silicon tubings).
- Secure the tubing connections to prevent them sliding off. Use tube clamps.
- Do not kink the tubing. This will reduce throughput and may cause the maximum pressure in the system to be exceeded (glass reactor). The tube length should therefore be kept at a reasonable level.
- Prepare a maintenance plan.  
Check tubing at regular intervals, at least once per year, for signs of material fatigue (for example cracking)  
The tubing must be replaced at regular intervals if they are in constant use.

We recommend that you select suitable tubing on the JULABO homepage.

## 9 Commissioning



### **⚠ WARNING**

#### **Danger from mains voltage.**

Risk of injury from electric power.

- Compare the mains voltage and frequency with the details on the model plate.
- Connect the device only to a safe power supply via FI-circuit breaker (IA = 30 mA).
- The device may only be connected to power outlets with a ground contact (PE – protective earth).
- The mains plug serves as a safe disconnecting device from the power supply network and must be freely accessible at all times.
- Do not start the device if it has a damaged mains cable.
- Check the mains cable regularly for signs of damage.
- We disclaim all liability for damage caused by incorrect line voltages!

#### **Commissioning the circulator with a refrigeration machine**

Connect the circulator and refrigeration machine using the mains lead. Connect them to the voltage supply using the fitted plug on the refrigeration machine and the mains lead. Connect the CAN jacks on both devices with the CAN connection cable to transfer data.



### **⚠ CAUTION**

#### **Cold or hot unit surfaces**

**Risk of frostbite, risk of burns**

#### **What should be observed when operating the JULABO temperature control unit?**

- Unit parts may develop high surface temperatures. A hot surface means it has a temperature of 60 °C / 140 °F or more.
- Let the device cool down to an uncritical safe temperature.
- Use safety gloves.

### 9.1 Excess temperature and low level safety devices

The safety devices are not affected by the control circuit. When they trip all actors are permanently shut down.

The alarm is displayed optically and acoustics with a continuous signal tone and the reason for the alarm is shown on the display as a number.

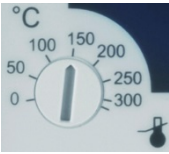

## ⚠ WARNING

### Danger from damaged safety devices

Possible serious consequences for personnel and working areas.

**Check the safety devices at least twice per year.**

### Excess temperature protector, IEC 61010-2-010

Turn the adjustable excess temperature protector to the cut-out point (actual temperature) using a screwdriver. The actors will be shut down on all poles, the circulator will show error message E 14, the "Alarm" control display will be lit and a continuous signal tone will sound.

### Low level safety device, IEC 61010-2-010

The float switch in this device must be moved manually in the bath to test the function, for example using a screwdriver. Push down the float until it reaches the mechanical stop.

The actors will be shut down on all poles, the circulator will show error message E 01, the "Alarm" control display will be lit and a continuous signal tone will sound.

## 10 Filling



## ⚠ CAUTION

### Basic dangers.

The volume of oil used as bath fluid changes with the temperature. Starting from the volume when the bath is filled (room temperature) it may increase or decrease during operation.

The bath temperature rises - hot bath fluid can overflow.

The bath temperature falls - the low level alarm will stop the tempering process.

Monitor the level until it reaches working temperature.

### Filling process

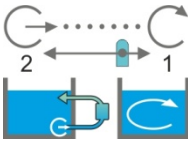

- Ensure that the drain valve is closed. Turn the knurled screw.
- Carefully insert bath fluid - never allow bath fluid to get inside the circulator.
- Do not exceed the maximum bath capacity (see Technical Data).
- 1 - The bath temperature rises - hot bath fluid can overflow.
- 2 - The bath temperature falls - the low level alarm will stop the tempering process.
- Monitor the level until it reaches working temperature.

## 10.1 Pump settings



To meet all the requirements for internal and/or external temperature control tasks, the direction of the pump flow is continuously adjustable.

For this purpose the lever below the head of the circulator can be adjusted from:

- 1.)  Max. internal pump flow to...
- 2.)  Max. external pump flow.

### **CAUTION**

#### **Risk of burns due to hot bath fluid**

When adjusting the pump flow, make sure that no bath fluid is spilled from the bath opening due to circulation. For internal temperature control (external pump connections closed), the adjusting lever is to be set first to reduced internal circulation (2) before the circulator is started. After starting the circulator, circulation can be optimized through adjustment.

## 11 Display elements

### Central controller (operating and function elements, pos. 5)

Using the central controller (rotary switch), the parameters can be selected and adjusted clockwise or counterclockwise. After selecting and adjusting, the setting is applied (confirmed) by pressing the controller.



Selecting (turning)    Confirming (pressing)

Date/time

Internal/external setpoint specification

Heating/cooling icon

 = Analog plug-in /

 RS232 interface

R = remote control

USB interface

LAN connection

Display selection

Menu selection

Start/stop switch

Setpoint

Internal

External

Pump capacity in %

Liquid level indicator

Safety setting values

- High temperature
- Low temperature
- Safety sensor
- High temperature cut-off
- Motor speed

Standby unit mode

Different representations can be selected for the display:

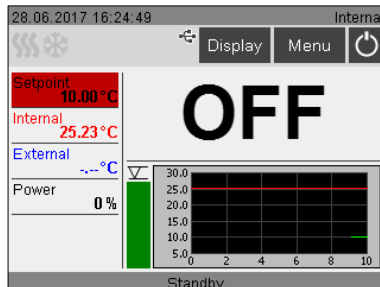
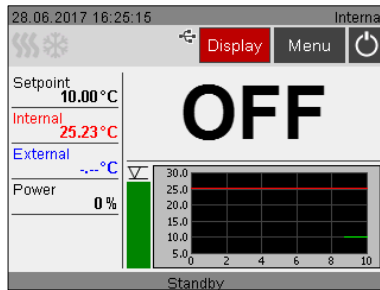
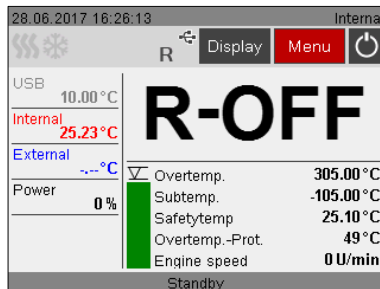

The current menu level is shown at the top left in the menu setting dialog (e.g., main menu).



One level back.



Home (return to normal display).



Save value/parameter.



Call help menu

Select  button and  button and  confirm



The operating manual is called up in the Internet using the QR code.

### Displays in the error case

Error messages are divided into two categories:

**ALARM Red** > 

**WARNING Yellow** > 

An alarm leads to unit cut-off of heater, refrigeration aggregate, and circulating pump.

The unit switches into "OFF" state.

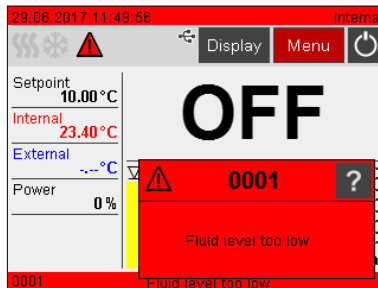

A low liquid level warning is outputted in the example below.

A warning does not lead to unit cut-off of heater, refrigeration aggregate, and circulating pump.

To call up help with troubleshooting the

alarm and warning, select



and confirm



This display shows the required remedies.

The unit offers the option to define some of the warning limits.

If such a limit is exceeded, a warning is displayed (continuous display and signal), as long as the cause is present.

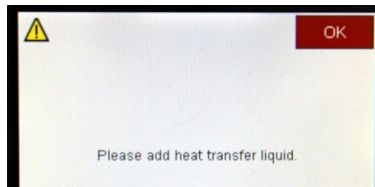
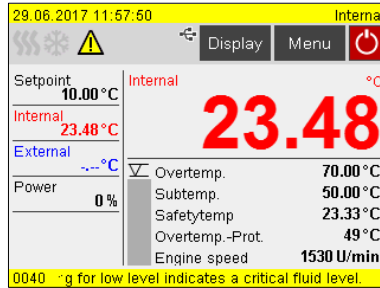

To correct the cause of the warning, bath fluid must be refilled.

## 12 Switching on/selecting language



### Switching on:

The unit is switched on by pressing the main switch. Name and voltage variant of the unit are displayed briefly.

The unit switches into the operating mode, in which it was prior to being switched off: Manual mode (operation at the unit), or Remote control mode (operation via PC).

It is a good idea to hold the circulator head with one hand whilst pressing the buttons.

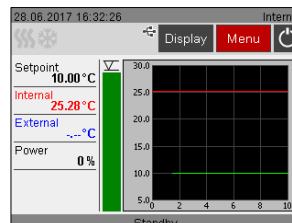
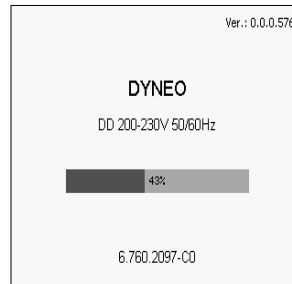



To adjust the language for the operating dialog,

proceed as follows. Select



confirm



to call up the main menu.

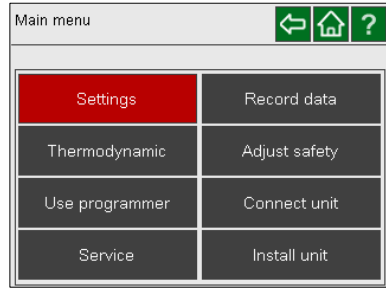

Select



in the main menu

and confirm

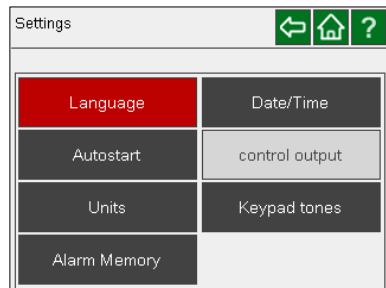

Select



in the

menu and confirm



Select



the screen

language and confirm

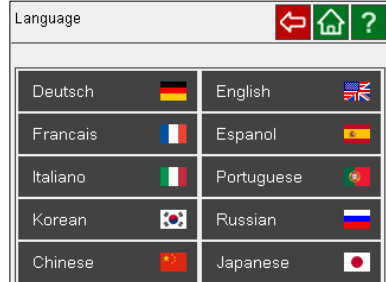

## 13 Adjust safety



### **WARNING**

#### **Flammable bath fluid Danger of burns**

The unit can be filled with approved flammable media. Danger of fire! Chemical dangers may occur, depending on the bath medium.

Refer to all warnings on the substances used (bath fluids) and in the relevant instructions (safety data sheets).

To avoid personal injuries and damage to the unit, several safety settings must be adjusted, and limit values set.

### 13.1 Temperature limits

Select  to call up the main menu and confirm .

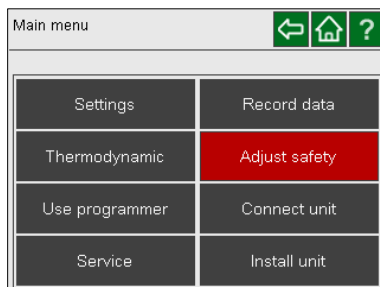

Select  and confirm .

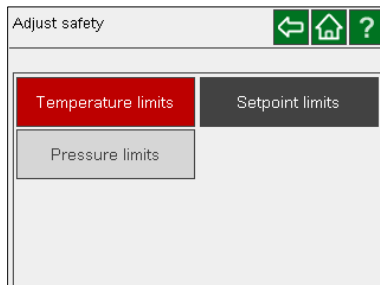

The pressure limits cannot be adjusted in this unit.



The low and high temperature are adjusted here. High temperature as well as the safety function can be adjusted using a screwdriver.

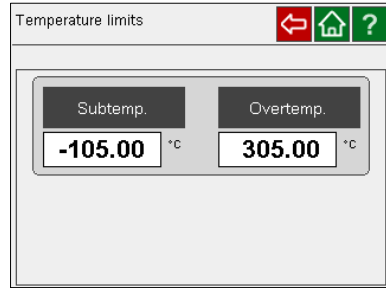

### Adjusting low/high temperature

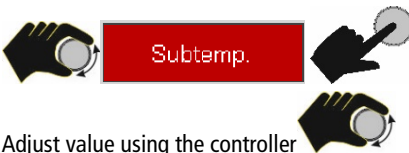

Adjust value using the controller

and confirm



is adjusted similarly.

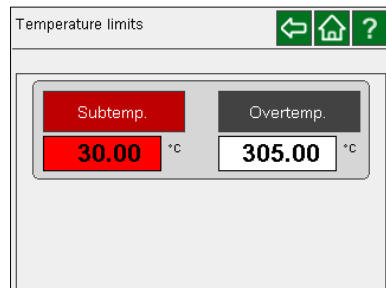

## 13.2 Adjusting setpoint limits

Minimum and maximum setpoints can be adjusted. This way, a range can be defined, in which process sequence execution is safe.

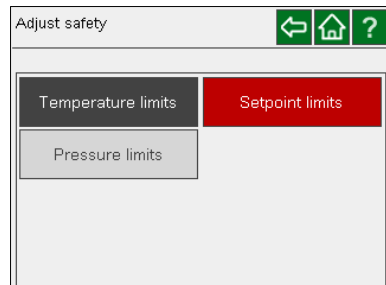

## Setpoint min./max.

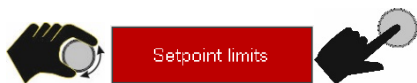

Adjust value using the controller



and confirm



Setpoint max.

is adjusted similarly.

## Adjusting pump stage max.

Select



Pumpstage max

and confirm



Adjust value using the controller



and confirm



**Max pressure setpoint (not implemented in this unit).**

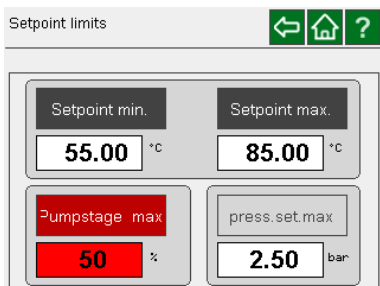
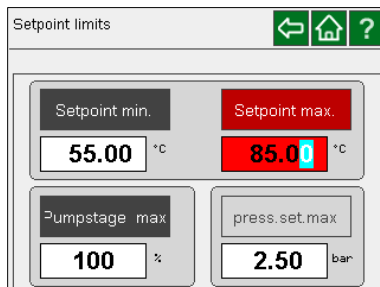
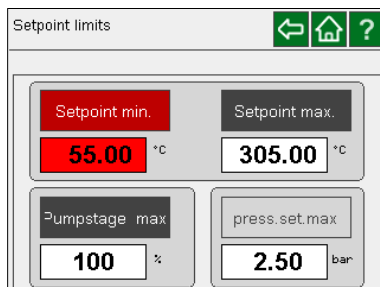

## 14 Adjusting setpoint temperature/start/stop

Here, you set the temperature, which should be reached and maintained in your application.

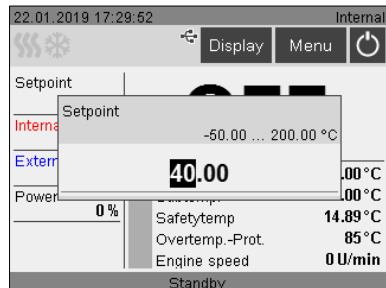
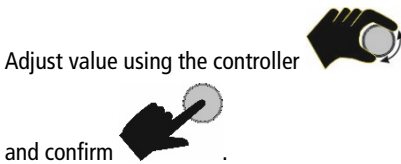
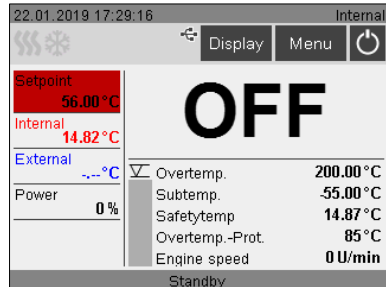

To start and stop the temperature control application

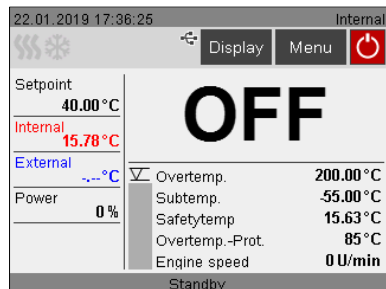

## 15 Main menu

In the main menu, you can find all unit settings and their parameter to adjust your unit to the temperature application.



To call up the main menu.

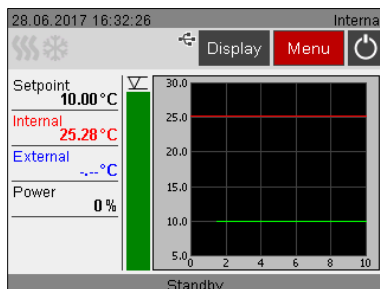

The following can be selected in the main menu



- - Settings
- - Record data
- - Thermodynamic
- - Adjust safety
- - Use programmer
- - Connect unit
- - Service
- - Install unit.

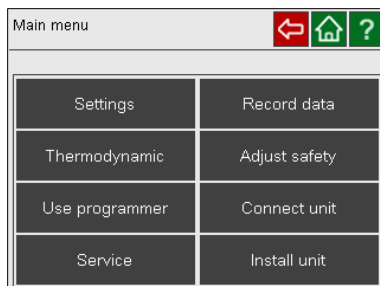

### 15.1 Applying settings

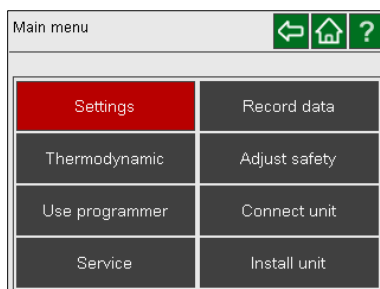

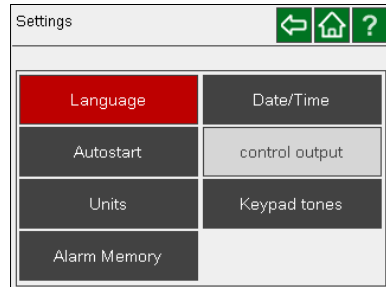

## Selecting language

Setting the language  is already described in chapter “Switching on.”

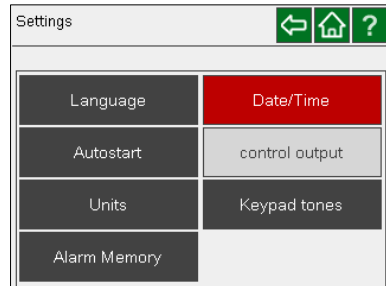

## Setting date/time



Date and time can be set with  and



. Dates can be shown in different formats.

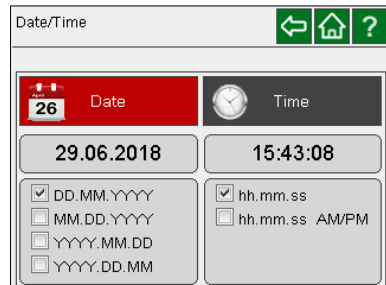

## Selecting autostart



Allows starting the circulator directly using the mains switch.

The circulator is configured and delivered by JULABO according to the NAMUR recommendation. For starting this means that the unit must be switched into a safe operating status after a power failure (autostart "off"). This safe operating status is indicated on the display with "OFF". The main function elements refrigeration aggregate, heater, and pump motor are disconnected from the mains voltage.

The AUTOSTART function can only be executed with a specified setpoint via >Setpoint< and >EPROG input<.

If such a safety standard is not requested, the NAMUR recommendation can be bypassed with the AUTOSTART function (autostart "on"). This allows starting the circulator directly using the mains switch or via a timer.

Select  the desired operating mode and confirm .

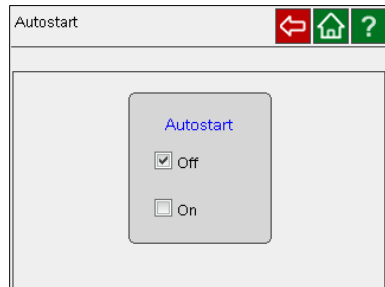
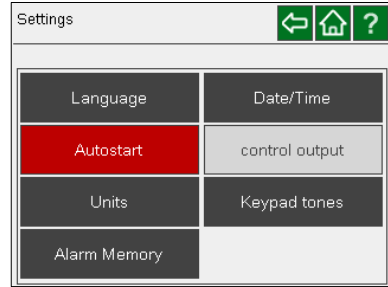



The  adjustment is not implemented in the DYNEO.



## Adjusting physical units



Select  the desired physical parameter and unit and confirm .

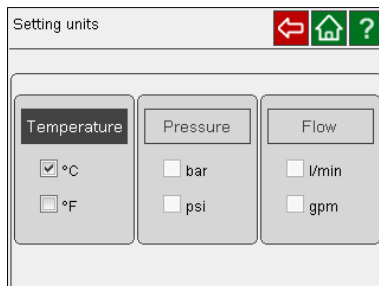
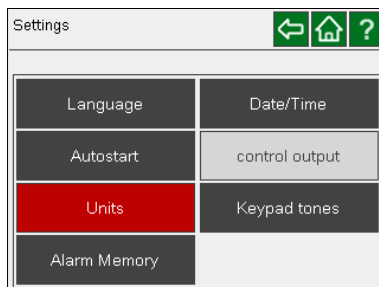

## Reading out the alarm memory



The stored alarm messages are listed with date, time, alarm code and unit identifier.

The data is cleared using

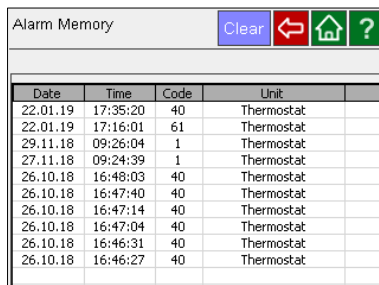
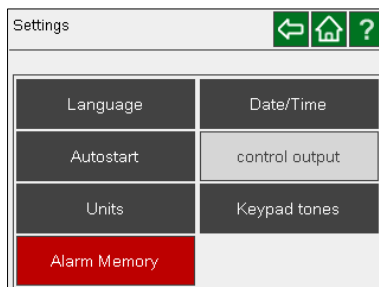

## Keypad tones on/off

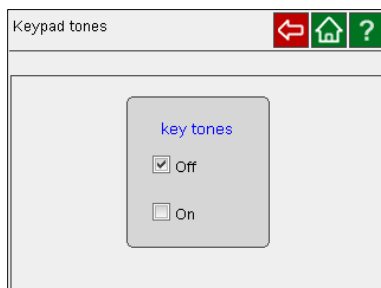
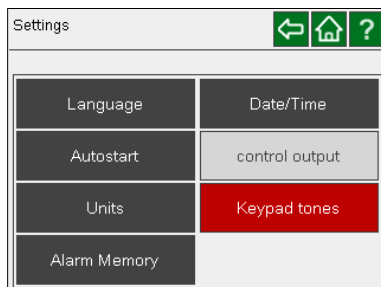
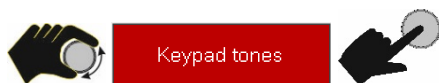

## 15.2 Thermodynamic

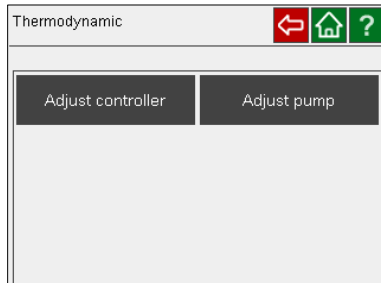
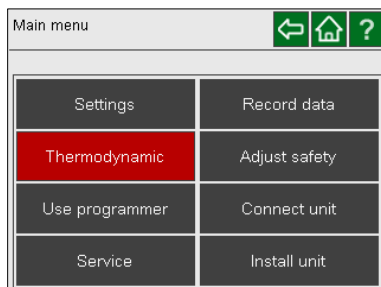
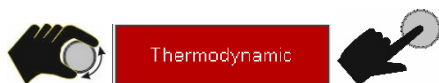

## Adjust controller

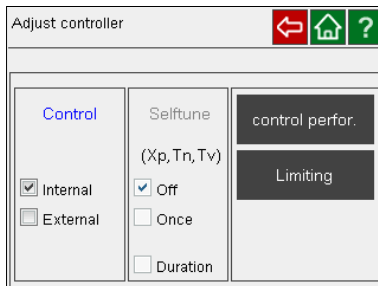
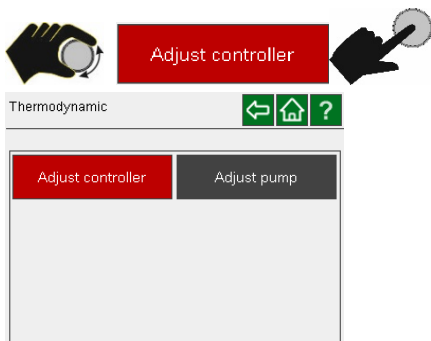

### Control

The DYNEO models offer temperature control in the internal heat exchanger or external control in the consumer (loop circuit).

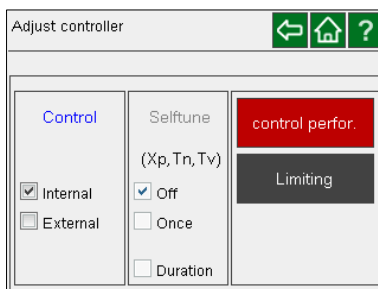
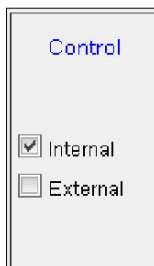
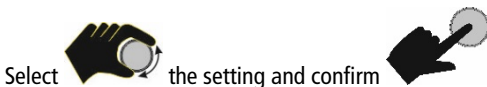

### Internal parameters – external parameters

In the most cases, the factory-set control parameters are sufficient to achieve an optimum temperature sequence in the samples.

The adjustable control parameters enable an adjustment to special controlled processes.

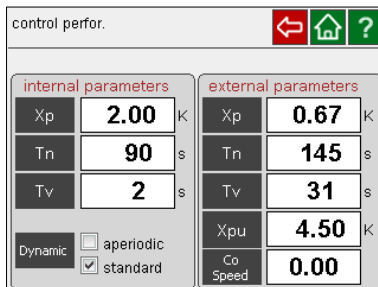
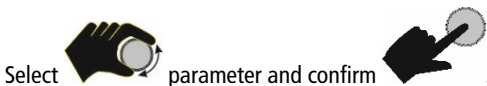

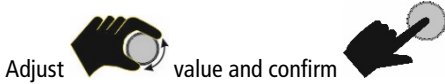

Adjust value and confirm

## Proportional range >Xp<

The proportional range is the temperature range underneath the setpoint, in which the heating capacity is controlled from 100 % to 0 %.

Xp 0.13 K

## Integral time >Tn< (integral portion)

Compensation for the residual control deviation caused by the proportional controller. Too short integral times can lead to instabilities. Too long integral times unnecessarily extend the control difference compensation.

Tn 80 s

## Derivative time >Tv< (differential portion)

The differential portion shortens the settling time. A too short derivative time extends the transient compensation and leads to large overshooting during start-up. Too long derivative times can lead to instabilities (oscillations).

Tv 9 s



Adjustable parameters:

## Aperiodic

The temperature increase is temporally offset without overshoots.

## Standard

The temperature increase is faster, however, overshooting of up to 5 % may occur. If a ramp is defined, the temperature sequence mostly follows this ramp.

For both settings, sufficient temperature stability is achieved after approx. the same time.

- A Standard
- B Aperiodic
- C Constant temp.
- D Setpoint
- E Temperature ramp

This parameter influences the temperature sequence only with **internal** control.

Dynamic  aperiodic  standard

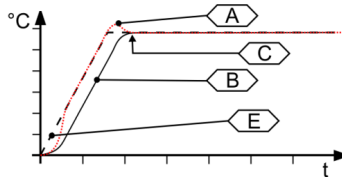
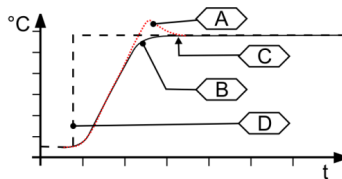

### Proportional range >Xpu<

The proportional range Xpu of the underlying controller is required for **external control only**.

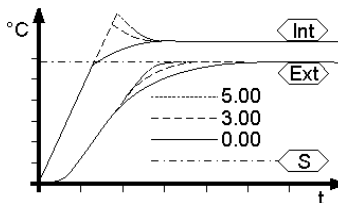

### >CoSpeed Factor<

This parameter influences the temperature sequence only with **external** control. The setting influences the calculation of the control parameters during identification, and thus the control behavior.

S Setpoint  
Ext Ext. temp.  
Int Int. temp.

### Optimization information for PID control parameters

The temperature sequence over time of the samples provides information about possible incorrect control parameter settings.

- optimally adjusted

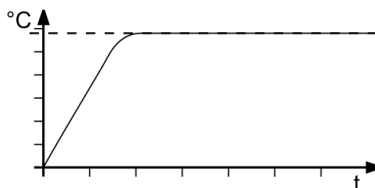

Incorrect settings can lead to the following heating curves:

Xp too small

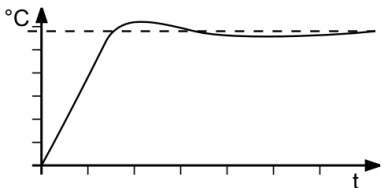

Tv/Tn too small

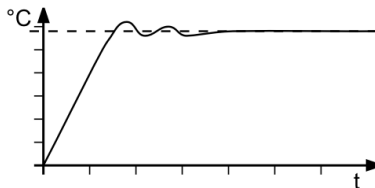

Xp too big or Tv too big

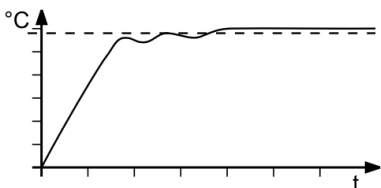

Tv/Tn too big or Xp too big

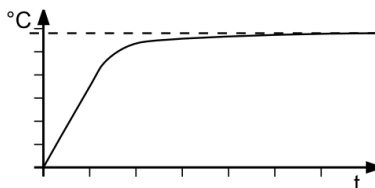



In the >Limiting< menu, the minimum and maximum values can be defined for all important setting ranges and performance parameters.

To adjust the values:

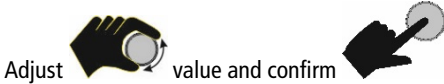

## Max. cooling capacity/max. heating capacity

The heating and cooling capacity of the unit are adjustable. 100 % correspond to the capacities specified in the technical data.

Setting range:

Maximum heating capacity from 0 to 100 % in 1 % steps

Maximum cooling capacity from 0 to 100 % in 1 % steps

## Internal minimum/internal maximum

Maximum and minimum setpoint in the internal bath.

The internal maximum and internal minimum limits are only effective in external control operating mode. Using internal maximum and internal minimum, static limits are defined for the temperature to be expected. The temperature controller cannot exceed these limits, even if this would be required for the temperature in the external system. Under certain circumstances, this can result in the external preset value not being achieved.

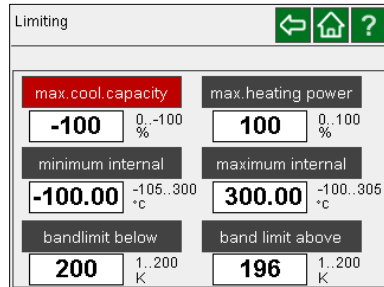
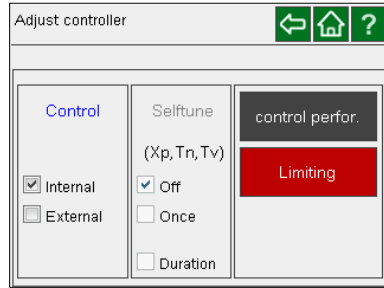
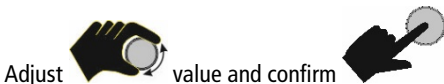

## Meaning of the limit:

- Protection of the bath fluid from overheating.
- Protection from unintended alarm cut-off by the high temperature cut-off >Error 14<  
Set the value of >internal maximum< at least 5 °C below the value of the >TANK< high temperature cut-off.
- Protection of the pump motor from too high viscosity of the bath fluid at low temperatures.

## Band limit below and band limit above

The band limit is active with external control. Different, practice-oriented settings are possible for the heating and cooling phase.

Setting range: 0 °C ... 200 K

Using > **band limit above** < and > **band limit below** <, maximum permissible temperature differences between the internal bath and the external system are defined for the heating and cooling phase.

This difference value is always added to the current external temperature during the heating phase. In the cooling phase, the difference value is subtracted.

As long as >selftune band limit< is active, the band limit is switched off for external control.

As long as >selftune band limit< is active, the band limit is switched off for external control.

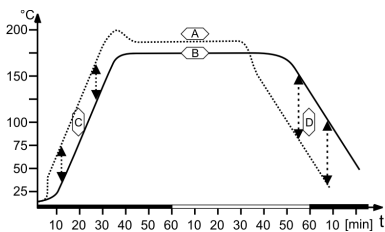

Legend:

A = Internal bath

B = External system

C = Band limit above

D = Band limit below

### Meaning of the limit:

- Protection of the sample through gentle temperature control application.
- Protection of, e.g., glass reactors from thermal stresses.

## Adjust the pump

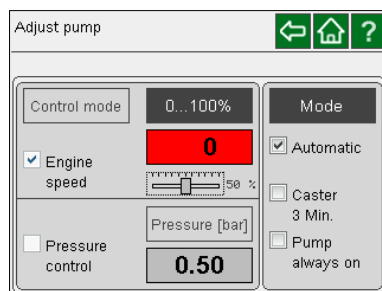
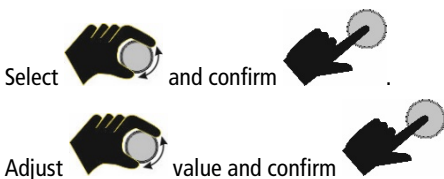
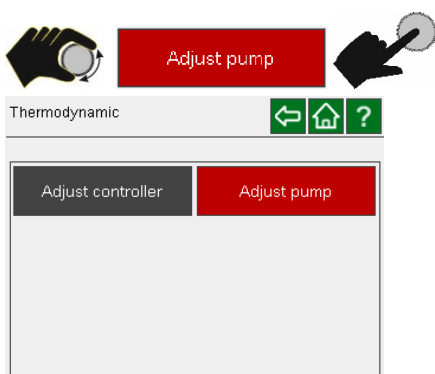

The delivery volume of the pump can be adjusted using the motor speed or the pressure. Regardless of that, the pump runs:

- Automatically (Auto),
- With a 3 min after-run,
- Always (pump always on)

## 15.3 Use programmer



Using programmer, setpoint temperature sequences can be quickly and easily programmed. Such a temperature sequence is referred to as profile. A profile is compiled of individual steps. The steps are defined using duration (t:) and gradient ( $^{\circ}/t$ ) and target temperature.

The target temperature is the setpoint temperature, which is reached after completing a step. Based on the time and temperature difference in a step, the programmer calculates a temperature ramp (1).

### Caution:

If the time specified is too short, the actual temperature cannot reach the setpoint temperature. For this case, the programmer can be used to edit a profile.

If the time for a step is defined as 00:00:00, the setpoint temperature "jumps" (2) to the target temperature.

Only after the specified temperature is reached ( $\pm 0.2^{\circ}\text{C}$ ), the profile is continued with the next step.

Eight profiles with up to 60 steps each can be stored.

The **Standard** or **Gradient** settings can be mixed in a profile.

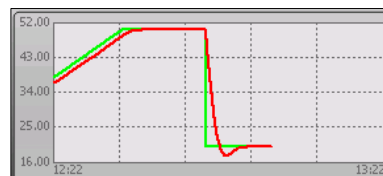
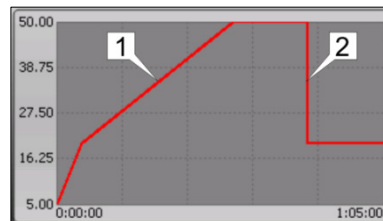
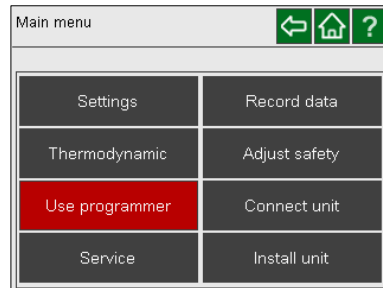

Setpoint = green

Actual value = red



## Timer

Using the timer, the setpoint temperature is adjusted at a certain time for a certain duration of the temperature control application.



Select temperature, time, and duration

and confirm

Adjust values and confirm

The timer is activated by setting the checkmark



## Profile timer

Using the profile timer, up to eight temperature sequences can be adjusted. Call up the desired profile (e.g., ).

start time, start date or number of profile

passes, and confirm

Adjust values and confirm

At the end of a profile, the unit is set into a selectable, definable final state:

- In standby (OFF),
- Temperature to last setpoint value,
- Temperature to start setpoint value

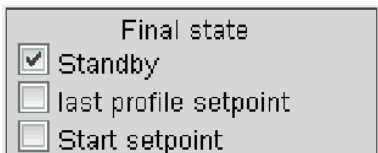
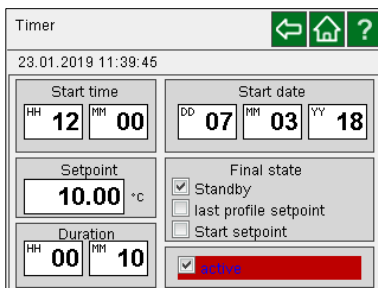
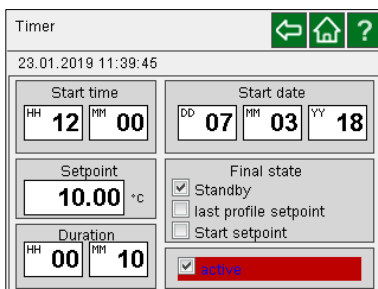
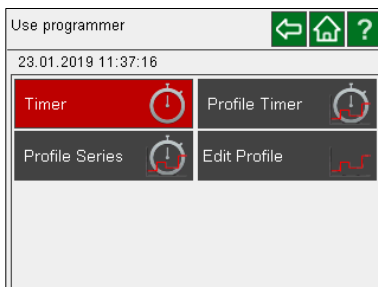

Set checkmark for the desired final state. With activation of the adjusted profile, it is executed using the specified data.



## Exemplary creation/editing of a profile

The profile can be called up in the profile timer and changed as well.

The profile can be directly changed via the



Profile Timer		←	🏠	?
23.01.2019 11:41:44				
Start time		Start date		
HH	MM	DD	MM	YY
23	00	06	12	18
Profile passes		Final state		
10		<input checked="" type="checkbox"/> Standby		
		<input type="checkbox"/> last profile setpoint		
		<input type="checkbox"/> Start setpoint		
Profile: 1		<input checked="" type="checkbox"/> active		



Or

Use programmer		←	🏠	?
23.01.2019 11:42:31				
Timer	🕒	Profile Timer	🕒	
Profile Series	🕒	Edit Profile	📈	

Of the 8 profiles, the selected profile is red.

Select "Edit" and confirm .

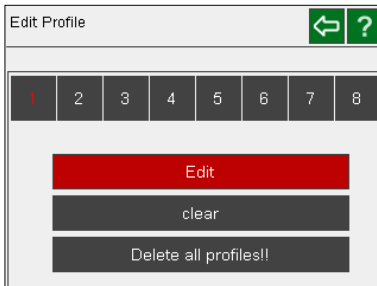

To create a profile, select "Add" and confirm . A preset line (step) is inserted.

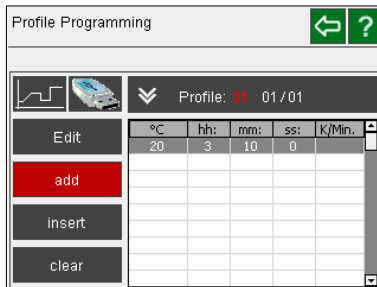

To change, select "Edit" and confirm . Columns °C, hh, mm, ss, K/MIN can be

selected and adjusted after confirming

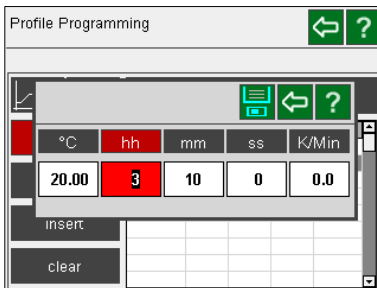

. Thus, the setpoint (°C), duration in hours (hh:), minutes (mm:), seconds (ss:) and the temperature gradient (K/Min.) can be adjusted in every step.

If a temperature gradient is entered, the time is set to zero. To store the adjusted values, select

the button and confirm . Saving is confirmed with "Successfully completed."

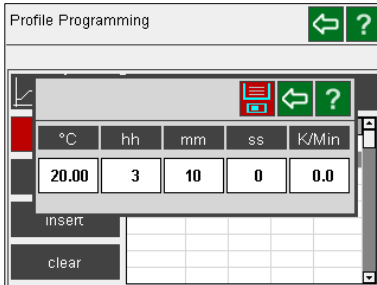

To confirm successful saving, press OK .

To add another profile line, select "Add" and confirm .

Another preset line is inserted. The line is highlighted

in gray. To edit the values, select  "Edit"

and confirm  . To insert a line, select

 " and  confirm  . The step is highlighted in red. Select the insertion point

 and confirm  (step is

highlighted in gray). Select  the "Insert"

button and confirm  . A line (with preset values) is inserted below the selected line.

This way, up to 60 steps can be created.

To remove, select  step with  and

confirm  (step is highlighted in gray).

Select  the "Clear" button and confirm

To edit a step, select via   .

The selected step in the profile is highlighted in red.



By confirming  , the step is highlighted in



gray and can be changed via 

Save

Successfully completed

OK

Profile Programming  



  Profile: 03 07 / 07



	°C	hh:	mm:	ss:	K/Min.
Edit	30	0	4	0	
	20	0	10	0	
add	40	0	10	0	
	20	0	10	0	
insert	20	0	10	0	
	20	0	10	0	
clear	20	0	10	0	

From display

 Profile: 03 04 / 07

profile no. (03), selected step (01), and total number of steps (07) in the profile can be obtained.

Profile Programming  

  Profile: 03 03 / 07

	°C	hh:	mm:	ss:	K/Min.
Edit	30	0	4	0	
	20	0	10	0	
add	40	0	10	0	
	20	0	10	0	
insert	20	0	10	0	
	20	0	10	0	
clear	20	0	10	0	



Another step can be added to the profile.







Or inserted.

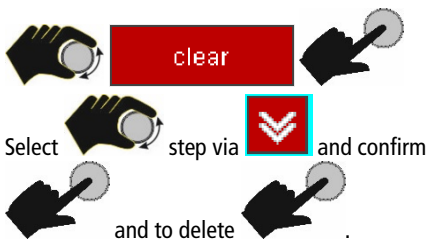



Individual steps can be deleted:





Profile Programming  



  Profile: 03 / 03/07



	°C	hh:	mm:	ss:	K/Min.
Edit	30	0	4	0	
add	20	0	10	0	
insert	40	0	10	0	
clear	20	0	10	0	
	20	0	10	0	
	20	0	10	0	
	20	0	10	0	

Profile Programming  



  Profile: 03 / 01/07



	°C	hh:	mm:	ss:	K/Min.
Edit	20	0	10	0	
add	20	0	10	0	
insert	20	0	10	0	
clear	20	0	10	0	
	20	0	10	0	
	20	0	10	0	
	20	0	10	0	

Profile Programming  



  Profile: 03 / 07/07



	°C	hh:	mm:	ss:	K/Min.
Edit	30	0	4	0	
add	20	0	10	0	
insert	40	0	10	0	
clear	20	0	10	0	
	20	0	10	0	
	20	0	10	0	
	20	0	10	0	

Profile Programming  

  Profile: 03 / 04/07

	°C	hh:	mm:	ss:	K/Min.
Edit	30	0	4	0	
add	20	0	10	0	
insert	40	0	10	0	
clear	20	0	10	0	
	20	0	10	0	
	20	0	10	0	
	20	0	10	0	

Profile Programming  

  Profile: 03 / 06/08



	°C	hh:	mm:	ss:	K/Min.
Edit	30	0	4	0	
add	20	0	10	0	
insert	40	0	10	0	
clear	20	0	10	0	
	20	0	10	0	
	20	0	10	0	
	20	0	10	0	

The profile can be shown graphically. Select the

graphic symbol   and confirm



Profile Programming ← ?

  Profile: 01\_05/08

	°C	hh:	mm:	ss:	K/Min.
Edit	30	0	4	0	
add	20	0	10	0	
	40	0	10	0	
insert	20	0	10	0	
	20	0	10	0	
clear	20	0	10	0	
	20	0	10	0	

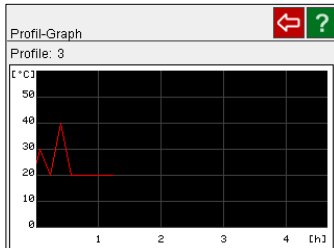



You can save the created profile or load saved

profiles.   and confirm



Profile Programming ← ?

  Profile: 01\_05/08

	°C	hh:	mm:	ss:	K/Min.
Edit	30	0	4	0	
add	20	0	10	0	
	40	0	10	0	
insert	20	0	10	0	
	20	0	10	0	
clear	20	0	10	0	
	20	0	10	0	

Profile... ← ?

load Profile

save profile

To load:



To save:



Profile... ← ?

load Profile

save profile

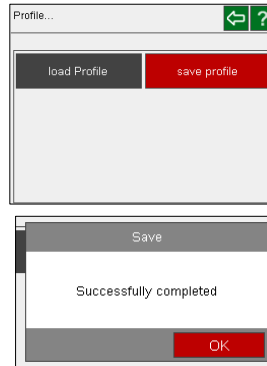

### Profile series

Using the profile series, profiles can be started and ended selectively day by day over any time frames.

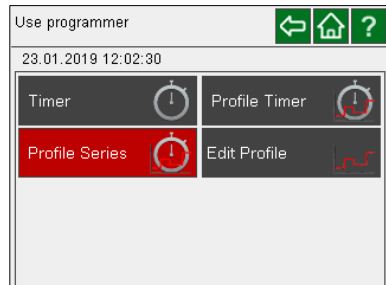

At the end of a profile, the unit is set into a selectable, definable final state:

- In standby (OFF),
- Temperature to last setpoint value,
- Temperature to start setpoint value.

Set checkmark for the desired final state. With activation of the adjusted profile, it is executed using the specified data.

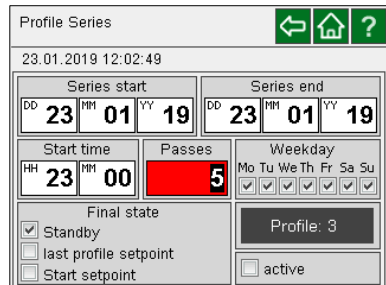

The profiles can be deleted selectively

**clear** or all by pressing a button. Select profile and delete or select



**Delete all profiles!!**

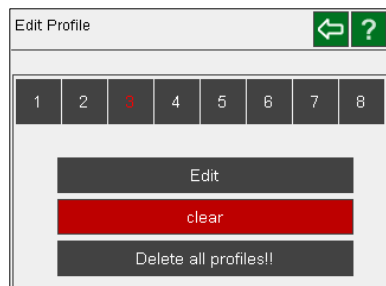



and confirm. All profiles are deleted.

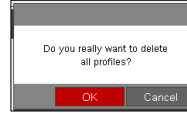
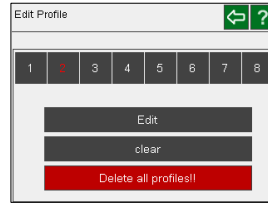

## 15.4 Connecting unit with PC

Select in the main menu:



The control type of the unit as well as the type of actuating value specification are adjusted here.

The settings of the digital and analog interfaces can be adjusted as well.

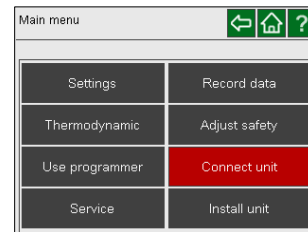

### Remote control

The unit can be remote-controlled via RS232 or USB interface. If the USB interface is selected, values such as the internal temperature can be read out via RS232. However, unit settings can only be adjusted via the selected interface.



For this purpose, select the desired setting

- Off (no remote control)
- USB
- RS232

(checkmark). In the display, this is indicated in the status line with an "R" and in the display with R-OFF.

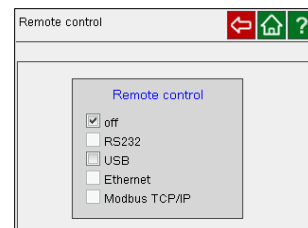
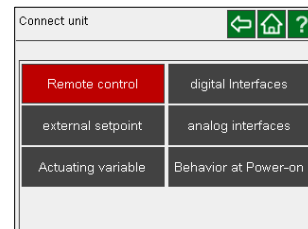



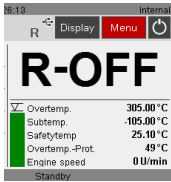

Ethernet and Modbus TCP/IP are not implemented.

## External setpoint

In addition to remote control via the serial interface, the unit also supports external setpoint specification via the analog interfaces >ext. PT100< or >EPROG<.



### - Off

Setpoint adjustment on the unit or via programmer

### - PT100

Setpoint adjustment via analog interface EXT PT100 through an external temperature sensor or a voltage/current source.

### - EPROG

Setpoint adjustment via analog interface REG+EPROG through an external programmer.

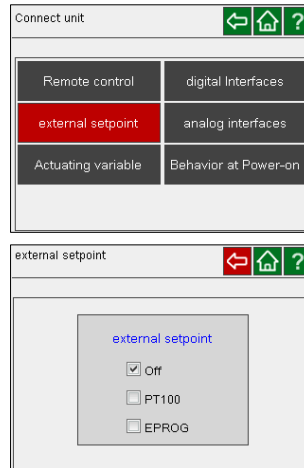

## Digital interfaces (option)

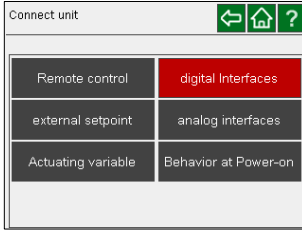

The parameter settings of the RS232 interface must be made in this menu.

Select settings of the interface.



and confirm.

### Parity:

none, uneven, **even\***

### Baud rate [Baud]:

1200    19200    2400    38400

**4800\***    57600    9600    115200

### Handshake:

none, Software-, **Hardware-\***

Datenbits 7, Stopbit 1

\* Factory setting

### Pin assignment

Pin 2	RxD	Receive Data
Pin 3	TxD	Transmit Data
Pin 5	0 V	Signal GND
Pin 7	RST	Request to send
Pin 8	CTS	Clear to send

Pin 1, 4, 6, 9 are reserved, not for use.

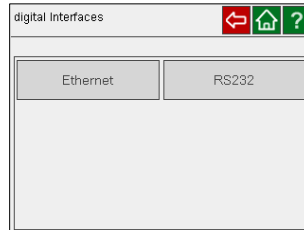

Connect unit and PC using a RS232 interface cable.

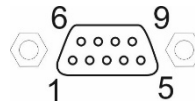
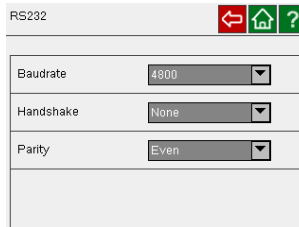

## Analog interfaces (option)

The analog module has three circular female connectors.

1. Alarm – Output for an external alarm signal
2. Female connector **REG+E-PROG** with three logging outputs and one input for an external programmer or other voltage and/or current sources.
3. Female connector **Standby** input external „off“ - key).



### Information regarding labeling:

**Test** For service purposes only. This key has no function during regular operation.

**reset** The module can be „reset“ with this key. This may be necessary in case of an error, for example if the red LED (error) lights up.

#### on **Green LED is illuminated**

The module has operating voltage but does not receive any information (CAN-Messages).

Green LED is not illuminated

The unit is turned off or the module is damaged or it has no power supply.

Green LED blinks

Irregular blinking indicates that the module receives information (CAN-Messages) and works correctly.

#### error **Red LED is illuminated**

Alarm of the module. The TFT display shows the type of error and required measures.

Red LED is not illuminated

If the unit is operating and the diode is not illuminated the module works correctly.

Red LED blinks

An unknown error has occurred during the data transfer on the CAN-Bus. The CAN-Bus has deactivated itself for safety reasons. Turn the unit off and then on again after several second. If the error occurs again, please contact JULABO service.

Using the "Analog interfaces" menu, the "Setpoint, internal, external, power" can be assigned to measurement values. This menu can only be selected, if the optional analog module is used and connected.

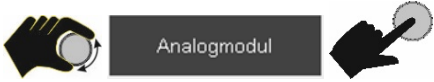

Channels 1 and 2 refer to the voltage output 0 V to 10 V.

For channel 3, the current outputs of 0 mA and 4 mA can be selected by ticking. The final value is 20 mA each

The setpoint, internal, external and the power can be set as input variables.

If the preset upper and lower values are to be retained, they must be explicitly confirmed after

switching over by pressing

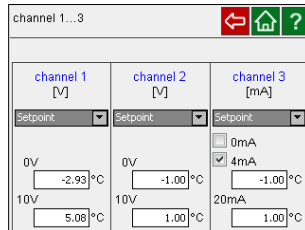
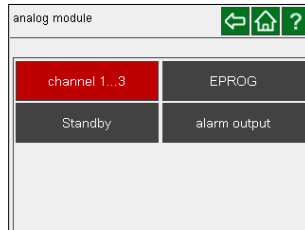
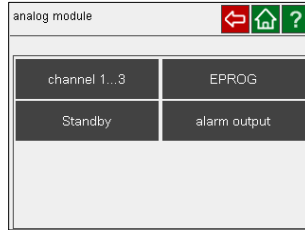
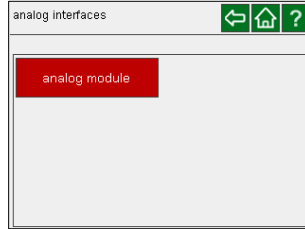
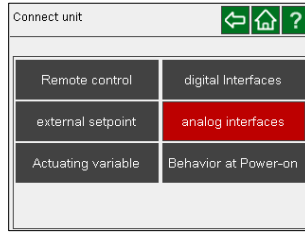
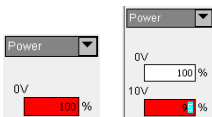

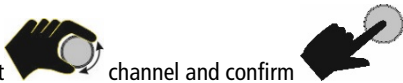

Select channel and confirm

Adjust the input parameter (highlighted in red).

Adjust the corresponding temperature values for 0 V (lowest temperature value) and 10 V (highest temperature value).

value).

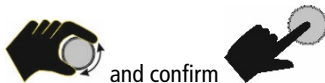

Adjust value with and confirm

These steps are the same for the three channels.

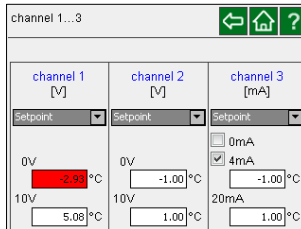
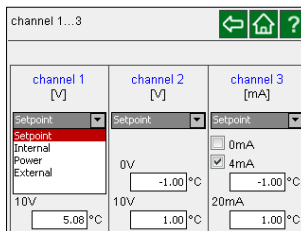

Using the EPROG setting, the input parameters

- Setpoint (in °C or °F)
- Power (in %)
- Flow (in LPM)

(with voltage and current signal types) can be evaluated.

For this purpose, the lowest measured value must be assigned to the lowest input value and the highest measured value to the highest input value.

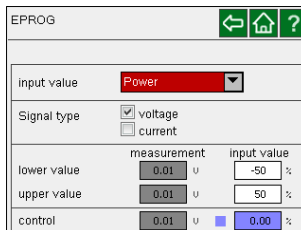
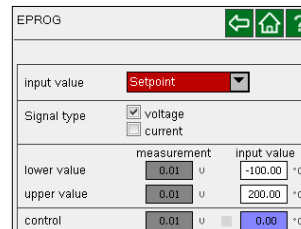
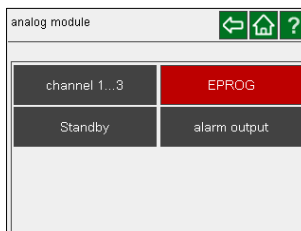
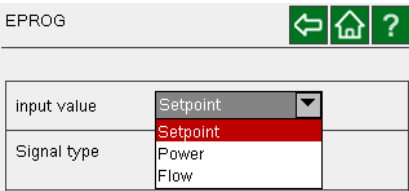

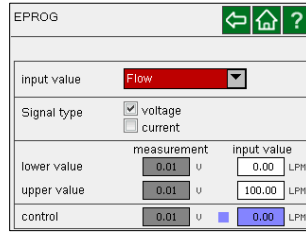

Consisting of three register outputs and one input for an external programmer:

- 1 Channel 1 voltage output 0...10 V
- 2 Channel 2 voltage output 0...10 V
- 3 Gnd for outputs 0 V
- 4 EProg programmer input. 0...10 V / 0...20 mA
- 5 Channel 3 current output 4...20 mA / 0...20 mA
- 6 Gnd for programmer 0 V



### Activating stand-by input:

1. Adjust the parameter under the Standby menu item to **>active<**.
2. Establish the connection to an external contact (AK, e.g., external cut-off) or to an alarm contact of the superordinate system.

If the connection between pin 2 and pin 3 is interrupted through opening of the AK contact, the unit switches off heater, pump motor, and compressor and switches into **"E-OFF"** state.

If the contact is closed again, the unit remains in **"External-OFF"** state.

### Assignment

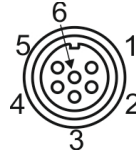

Only SELV-input (Safety Extra Low Voltage)

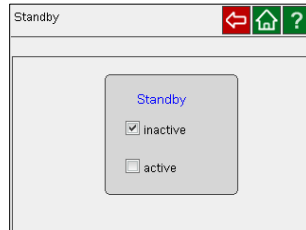
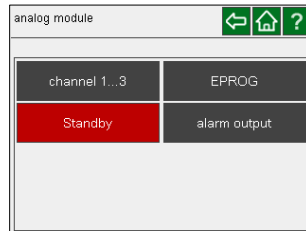

### Principle:

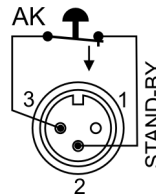

Alarm output for an external alarm signal.



The current setting is displayed on the keypad.

Switch power

max. 30 W / 25 VA

Switch voltage

max. 30 V<sub>DC</sub>; max. 25 V<sub>AC</sub>

Switch current

max. 1 A

This connection is realized as potential-free changeover contact. Without changing the plug connection, all operating statuses of the unit can be reported to the outside using the settings in the >Alarm output< menu.

Pin 2 and 3 are connected for the **Standby; Alarm; Alarm+Stdby** settings.

Pin 2 and 1 are connected for the Standby / Invers; Alarm / Invers; Alarm+Stdby / Invers settings.

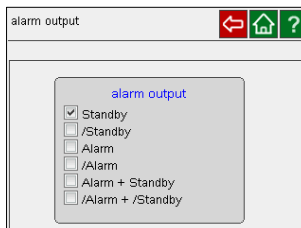
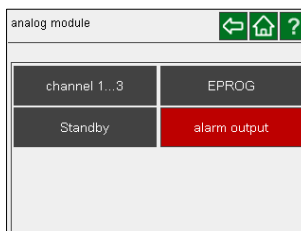

Principle:

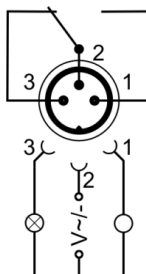

## Actuating value specification

The actuating value is the measure used to actuate the heater or cooling unit of the temperature control system. Heat or coldness is introduced into the bath depending on this measure. If the control electronics of the unit, referred to as >controller<, is used. the bath temperature is adjusted to the adjusted setpoint and maintained consistently at this temperature.

Actuating value specifications in the >Digital< and >EProg< positions are only implemented if the unit is in start mode.



## Controller

The internal control electronics of the unit controls heater and cooling unit.

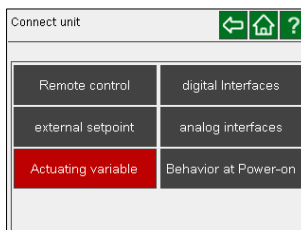



## Digital

The heater or cooling unit receives the control signal via a digital interface  
>RS232< / >USB< / >Ethernet<.

## EProg

The heater or cooling unit receives the control signal via the EProg input.  
- Can only be adjusted with the electronic module option.

Select  the desired setting and confirm 

## Behavior at Power-on

 Behavior at Power-on 

With Behavior at Power-on, values of the  
- Manual settings  
or  
- Remote control can be applied.

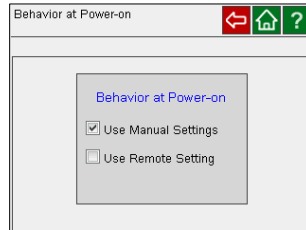
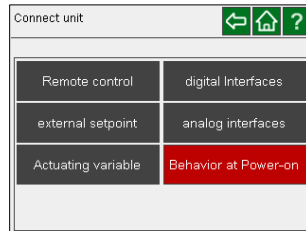
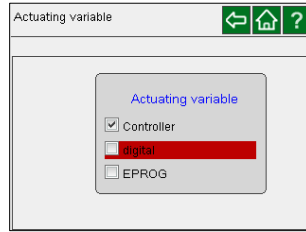



## 15.5 Install unit

Select



Install unit

in the main menu

and confirm



If the circulator is operated without refrigeration base units, the “Cooling mode” and “Power supply” menu fields are grayed out.

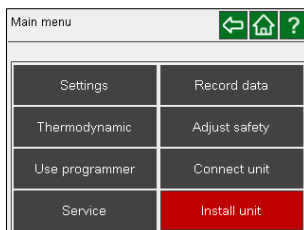

Install unit

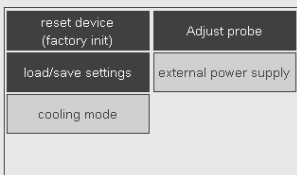

### Reset device (factory init)

All adjustable unit parameters can be reset into the status at delivery.

Select



Reset device (factory init)

and

confirm

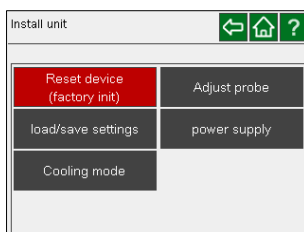

## Adjust probe

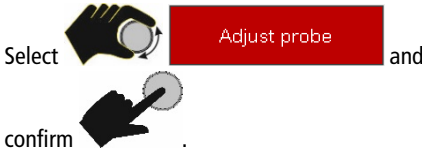

The sensor (probe) is adjusted (calibrated) for the internal and an external temperature sensor in "inactive" mode. If the desired values are entered under "Cal.", switch to the desired mode and save with .

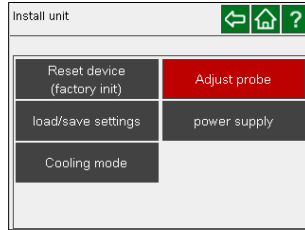

### Principle: External sensor calibration

For sensor calibration in the external bath, the bath temperature is determined using a reference temperature sensor in the adjusted state.

This value is then adjusted on the temperature control system in the >Adjust probe< menu, in menu item > Cal.<.

A >1 point<, >2 point< or >3 point< calibration can be performed.

Select the desired number of curve points in Mode.  $T_{T1}$  = original curve

In the case of 1-point calibration, the calibration curve is shifted towards the original curve of the sensor element overall.

In the case of 3-point calibration, a curve can be created. This can improve the accuracy of the temperature display in the range important for the application.

Proceed as follows to define the points:

1. Specify setpoint
2. Wait, until the specified setpoint is displayed.
3. Read out the temperature on the calibrated thermometer.
4. Enter the read-out value under Cal.

In the case of 1-point calibration, the calibration curve is shifted towards the original curve of the sensor element overall.

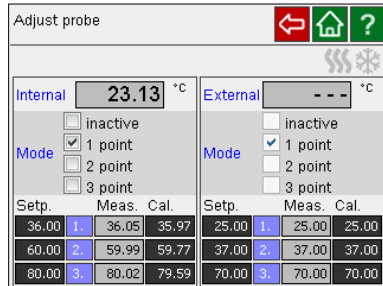

### Examples:

#### 1-point calibration

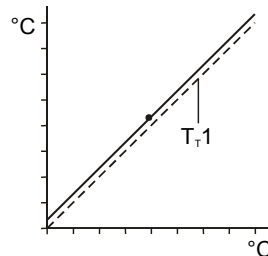

In the case of 3-point calibration, a curve can be created. This can improve the accuracy of the temperature display in the range important for the application.

### 3-point calibration

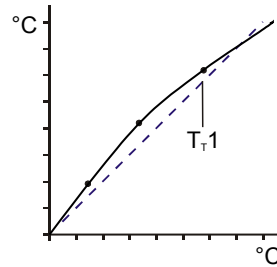

$T_T 1$  = original curve

1. Temperature control system
2. External Pt100 sensor
3. External bath
4. Temperature measuring instrument with reference temperature sensor

Read out the calibration value here.

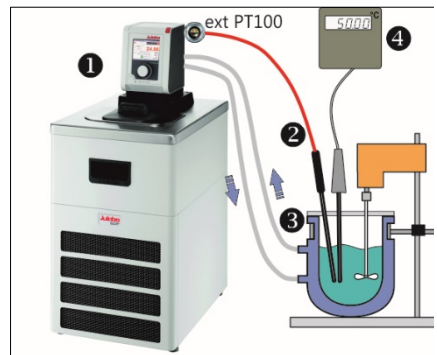

### Preparation:

- Connect the external Pt100 sensor to the "EXT Pt100" port.
- Adjust the unit to >Internal control<.

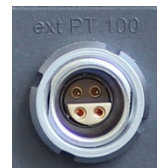

### Load/save settings

You can save adjusted values under an individual name on a USB stick and reload them as needed.

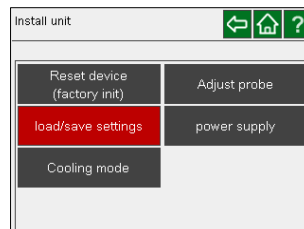
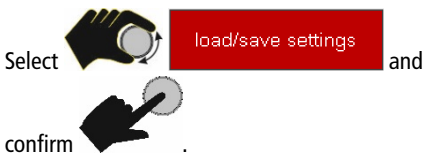

Apply the setting saved on the USB stick.

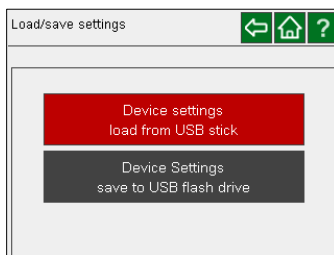

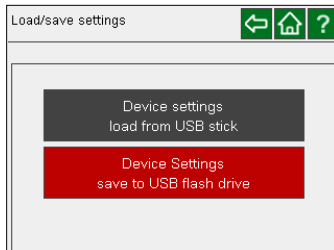

Save setting on the USB stick.



## Cooling mode

The refrigeration unit operating mode can be adjusted.

Select  **Cooling mode** and confirm .

The following can be selected:

- **Automatic** (factory setting), if cooling capacity may be required.
- **Always on**, if cooling capacity is required for maintaining the bath temperature.
- **Always off**, if no cooling capacity is required.

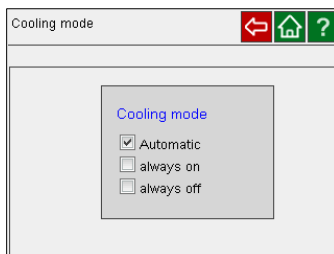
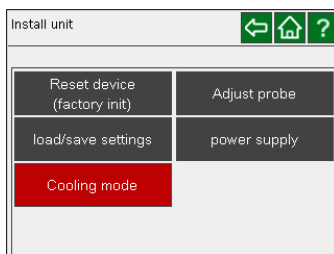

## Power supply

The circulator is supplied with power via the refrigeration base unit. However, circulator and refrigeration base unit can be supplied separately.



Left selection: The circulator is supplied with voltage from the refrigeration unit.

Right selection: Circulator and refrigeration unit are supplied separately.

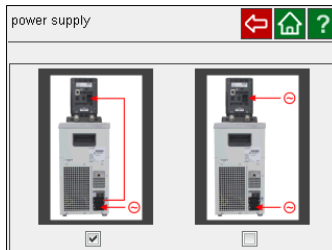
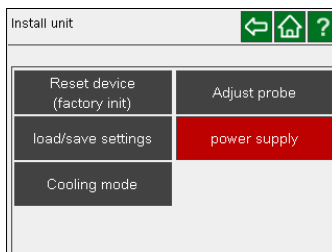

## 15.1 Record data

Insert a USB stick into the USB port on the back of the device. To record data in the main menu, select

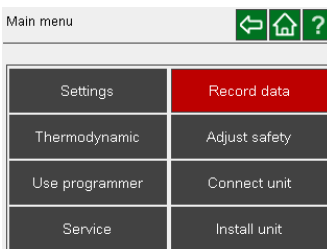
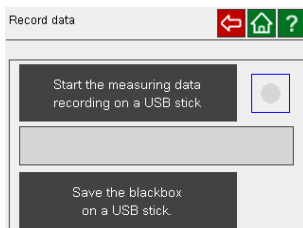

## Measuring data recording

The date, time, setpoint, internal, external, performance, status can be documented here

To prepare the recording select

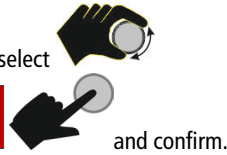

and confirm.

To set the sampling time



set the desired value and

confirm



The data series can be assigned an individual file name under which the data can be stored.

To start recording select



and confirm

A pulsating red dot indicates that the recording is in

progress. To stop the recording select

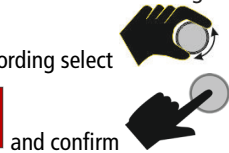

and confirm

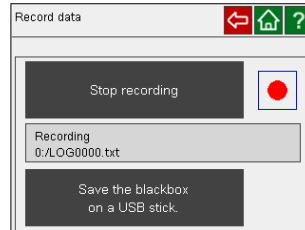
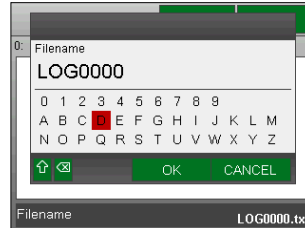
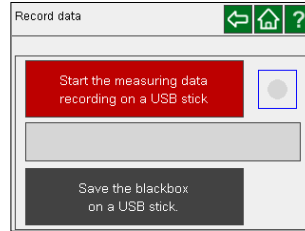

## Store Blackbox on USB stick

JULABO DYNEDO units are equipped with a so-called "black box". It is integrated into the controller, where all relevant data of the most recent 30 minutes are recorded.

This data can be exported when servicing the unit. To receive rapid and competent assistance, e-mail the file to our service department at [service@julabo.us](mailto:service@julabo.us).

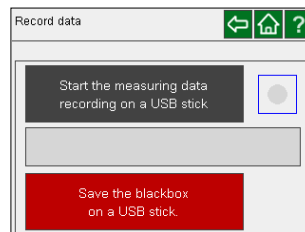

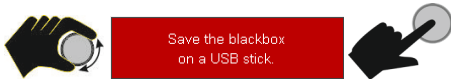

The blackbox data series can be assigned an individual file name under which the data can be stored.

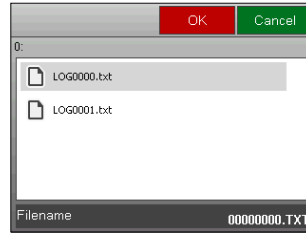

To save the recordet data select

## 15.2 Service

Select



menu and confirm

Access to the service menu is only granted to the JULABO Service team.

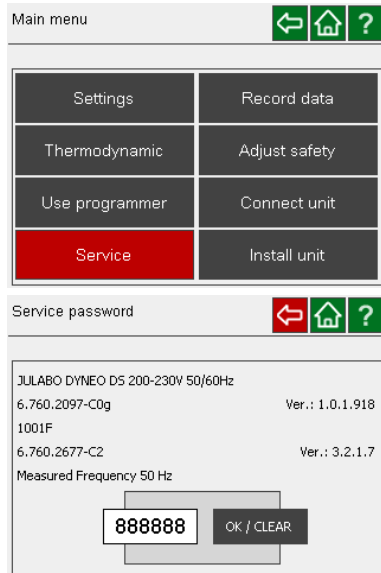

## 16 Emptying the bath tank



### **WARNING**

**Danger of scalds from hot bath fluid or hot drain tap.**

**Please note the following when draining the bath fluid:**

- Hot bath fluid:  
Do not drain the bath fluid when it is hot.
- Environmental Hazard:  
Refer to all regulations for disposing of bath fluids.



### **Emptying**

- Switch off the unit and pull the plug or disconnect the connection to the power supply on all poles.  
For baths without a drain tap, remove the circulator from the bath tank.
- Small bath tanks do not have a drain tap and can be carried for drainging. The temperature of the bath fluid should not exceed 50 °C.

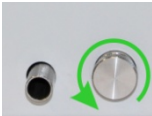

### **Enclosed baths and refrigeration machines**

- Connect a suitable hose to the drain port (Ø 12 mm external).
- Route the hose to a vessel or drain.
- Open the drain valve with the knurled screw.
  
- To reduce the weight, the bath can be partly emptied using a hose pump (transfer pump).
- Do not empty the bath in temperatures of  $\leq 0^{\circ}\text{C}$  since the drain tap may freeze.



## 17 Technical data

### 17.1 Technical data for circulator

Circulator		DYNEO™ DD
Working temperature range	°C	20 ... 200
Temperature stability	°C	±0.01
Temperature setting		digital
Temperature display		TFT
Resolution	°C	0.01
ATC - Absolute Temperature Calibration		3-point
Temperature control		PID3
Heating capacity (at 100 V / 50 Hz / 60 Hz)	kW	0.8
Heating capacity (at 115 V / 50 Hz / 60 Hz)	kW	1.0
Heating capacity (at 200 V / 50 Hz / 60 Hz)	kW	1.5
Heating capacity (at 230 V / 50 Hz / 60 Hz)	kW	2.0
Circulating pump:		
Delivery rate at 0 bar	l/min	8...23
Pressure at 0 liters	bar	0.1...0.6
Max. viscosity	cSt	50
Dimensions (WxDxH)	cm	13.2 x 16.0 x 35.5
Useful immersion depth	cm	16.0
Weight	kg	2.5
Ambient temperature range	°C	5 ... 40
Mains power connection 100 V/50 Hz/60 Hz	V / Hz	100 ±10 % / 50 / 60
Power consumption	A	10
Mains power connection 115 V/50 Hz/60 Hz	V / Hz	115 ±10 % / 50 / 60
Power consumption	A	11
Mains power connection 200 V/50 Hz/60 Hz	V / Hz	200 ±10 % / 50 / 60
Power consumption	A	9
Mains power connection 230 V/50 Hz/60 Hz	V / Hz	230 ±10 % / 50 / 60
Power consumption (at 230 V)	A	10
Classification, according to DIN 12876-1		III (FL)

## 17.2 Technical data for refrigeration circulation circulator

Refrigeration circulator		DYNEO DD-200F				DYNEO DD-201F	
Working temperature range	°C	-20 ... 200				-20 ... 200	
Temperature stability	°C	±0.01					
Temperature display		TFT					
Setting/Display resolution	°C	0.01					
ATC – Absolute Temperature		1-point					
Temperature control		PID2					
Refrigeration capacity	°C	+200	+20	+10	0	-10	-20
(Medium ethanol)	kW	0,2	0,2	0,17	0,15	0,1	0,02
Refrigerant		R134a					
Overall dimensions (HxDxH)	cm	23 x 39 x 65				44 x 41 x 44	
Useful bath opening (WxD)	cm	13 x 15				13 x 15	
Bath depth	cm	15				15	
Filling volume, from...to	Liters	3.0 ... 4.0				3.0 ... 4.0	
Weight, with circulator	kg	25.7				24.7	
Ambient temperature range	°C	5 ... 40					
Mains connection	V / Hz	100 ± 10 % / 50 / 60					
Power consumption (at 100 V)	A	Nom. 4 / Tot. 15					
Mains connection	V / Hz	115 ±10% / 60					
Power consumption (at 115 V)	A	Nom. 4 / Tot. 12				Nom. 3 / Tot. 12	
Mains connection	V / Hz	230 ±10% / 50 / 60					
Power consumption (at 230 V)	A	Nom. 2 / Tot. 16					
For CH model (at 230 V)	A	Nom. 2 / Tot. 10					
For GB model (at 230 V)	A	Nom. 2 / Tot. 13					

Refrigeration circulator		DYNEO DD-300F			DYNEO DD-600F		
Working temperature range	°C	-30 ... 200			-35 ... 200		
Temperature stability	°C	±0.01					
Temperature display		TFT					
Resolution	°C	0.01					
ATC – Absolute Temperat. Calibration		1-point					
Temperature control		PID2					
Refrigeration capacity	°C	+200	+20	+10	+200	+20	+10
(Medium ethanol)	kW	0,3	0,3	0,3	0,6	0,6	0,54
Kälteleistung	°C	0	-10	-20	0	-10	-20
(Medium Ethanol)	kW	0,27	0,19	0,08	0,5	0,33	0,19
Refrigerant		R134a			R404A, R452A*		
Dimensions (WxDxH)	cm	24 x 42 x 66			33 x 47 x 69		
Useful bath opening (WxD)	cm	13 x 15			22 x 15		
Bath depth	cm	15			15		
Filling volume, from...to	Liters	3.0 ... 4.0			5.0 ... 7.5		
Weight, with circulator	kg	27.7			35.7		
Ambient temperature range	°C	5 ... 40			5 ... 40		
Mains connection	V / Hz	100 ±10% /50-60			100 ±10% / 50 / 60		
Power consumption	A	Nom. 5 / Tot. 15			Nom. 11 / Tot. 15		
Mains connection	V / Hz	115 ±10% / 60			115 ±10% / 60		
Power consumption (at 115 V)	A	Nom. 4 / Tot. 12			Nom. 7 / Tot. 12		
Mains connection	V / Hz	200-230 ±10 % 50 / 60			200-230 ±10 % 50 / 60		
Power consumption (at 230 V)	A	Nom. 2 / Tot. 16			Nom. 3-4 / Tot. 16		
For CH model (at 230 V)	A	Nom. 2 / Tot. 10			Nom. 3-4 / Tot. 10		
For GB model (at 230 V)	A	Nom. 2 / Tot. 13			Nom. 3-4 / Tot. 13		
Mains connection	V / Hz	208-230 ±10 % / 60			-		
Power consumpt. (208- 230 V)	A	Nom. 2 / Tot. 16			-		

\* at 200 V- 230 V / 50 Hz / 60 Hz; 230 V / 50 Hz / 60 Hz

Refrigeration circulator		DYNEO DD-601F			DYNEO DD-900F		
Working temperature range	°C	-35 ... 200			-38 ... 200		
Temperature stability	°C	±0.01					
Temperature display		TFT					
Resolution	°C	0.01					
ATC – Absolute Temperat. Calibration		1-point					
Temperature control		PID2					
Refrigeration capacity	°C	+200	+10	0	+10	0	-10
(Medium ethanol)	kW	0.6	0.54	0.5	0,9	0,85	0,8
Refrigeration capacity	°C	-10	-20	-30	-20	-30	-40
(Medium ethanol)	kW	0.33	0.19	0.07	0,52	0,31	0,11
Refrigerant		R404A, R452A			R452A		
Dimensions (WxDxH)	cm	36 x 46 x 74			39 x 62 x 75		
Useful bath opening (WxD)	cm	22.0 x 15.0			26.0 x 35.0		
Bath depth	cm	20.0			20.0		
Filling volume, from...to	Liter	8.0 ... 10.0			21.0 ... 30.0		
Weight, with circulator	kg	38.2			52.0		
Ambient temperature range	°C	5 ... 40					
Mains connection	V/ Hz	100 ±10 % / 50 / 60			-		
Power consumption (at 100 V)	A	Nom. 11 / Tot. 15			-		
Mains connection	V/ Hz	115 ±10 % / 60			115 ±10 % / 60		
Power consumption (at 115 V)	A	Nom. 7 / Tot. 12			Nom. 8 / Tot. 16		
Mains connection	V Hz	200-230 ±10 % 50 / 60			200-230 ±10 % 50 / 60		
Power consumption (at 230 V)	A	Nom. 3-4 / Tot. 16			Nom. 5 / Tot. 16		
For CH model (at 230 V)	A	Nom. 3-4 / Tot. 10			Nom. 5 / Tot. 10		
For GB model (at 230 V)		Nom. 3-4 / Tot. 13			Nom. 5 / Tot. 13		

\* at 200 V - 230 V / 50 Hz / 60 Hz

Refrigeration circulator		DYNEO DD-1000F			DYNEO DD-1001F		
Working temperature range	°C	-48 ... 200			-30 ... 100		
Temperature stability	°C	±0.01			±0.01		
Temperature display		TFT			TFT		
Resolution	°C	0.01			0.01		
ATC – Absolute Temperat. Calibration		1-point			1-point		
Temperature control		PID2			PID2		
Refrigeration capacity	°C	20	0	-10	20	10	0
(Medium ethanol)	kW	1	0,9	0,73	1	0,95	0,85
Refrigeration capacity	°C	-20	-30	-40	-10	-20	-30
(Medium ethanol)	kW	0,5	0,3	0,13	0,6	0,32	0,12
Refrigerant		R452A			R452A		
Dimensions (WxDxH)	cm	42 x 49 x 70			45x64x77		
Useful bath opening (WxD)	cm	18.0 x 13.0			35,0x41,0		
Bath depth	cm	15.0			30,0		
Filling volume, from...to	Liter	5.0 ... 7.5			42...56		
Weight, with circulator	kg	36.0			68,0		
Ambient temperature range	°C	5 ... 40					
Mains connection	V/ Hz	115 ±10 % / 60					
Power consumption (at 115 V)	A	Nom. 7 / Tot. 12					
Mains connection	V Hz	200-230 -10 %; 5 % 50/60			200-230 ±5 % 50/60		
Power consumption (at 230 V)	A	Nom. 3-4 / Tot. 16			Nom. 5 / Tot. 16		
For CH model (at 230 V)	A	Nom. 4 / Tot. 10			Nom. 5 / Tot. 10		
For GB model (at 230 V)		Nom. 3-4 / Tot. 13			Nom. 5 / Tot. 13		
Mains connection	V Hz	230 -10 %; 5 % 60					
Power consumpt. (230 V)	A	Nom. 4 / Tot. 16					

All measurements have been carried out at: rated voltage and frequency  
 ambient temperature: 20 °C Technical changes without prior notification reserved.

Safety precautions to IEC 61010-2-010:  
 Excess temperature protection, adjustable  
 Low level protection  
 Classification to DIN 12876-1  
 Alarm

0°C ... 320°C  
 Float switch  
 Class III  
 Optical and audible (permanent)

Ambient conditions to IEC 61010-1:

- For indoor use only.
- Altitude up to 200 m - normal zero.
- Ambient temperature: +5 ... +40 °C

EMC requirements

The device is an ISM device of group 1 per CISPR 11 (uses HF for internal purposes) and is classified in class A (industrial and commercial sector).

## NOTICE

- Devices of class A are intended for the use in an industrial electromagnetic environment.
- When operating in other electromagnetic environments, their electromagnetic compatibility may be impacted.
- This device is not intended for the use in living areas and cannot guarantee adequate protection of the radio reception in such environments.

Humidity

- Maximum relative humidity 80%, for temperatures up to 31°C,
- Linear decrease to 50% relative humidity at a temperature of 40°C
- Max. voltage fluctuation of  $\pm 10\%$  are permissible.

Protection class to EN 60 529:

IP 21

The device complies with

Safety class I

Overvoltage category

II

Pollution degree

2

## 17.3 Refrigerant

---

In the event of an error in the refrigeration system (leak) a certain room size is specified in standard EN 378 for each kg of refrigerant.

The refrigerant used and the quantity are stated on the type plate.

Refrigerant used in relation to JULABO	Limit value for 1 m <sup>3</sup> volume [kg]
R23	0.68
R134a	0.25
R404A	0.52

Refrigerant used in relation to JULABO	Limit value for 1 m <sup>3</sup> volume [kg]
R507	0.53
R508B	0.2
R452A	0.423
Propane (R290)	0.008
Ethylene (R1150)	0.007

### Information about the used refrigerants

The **Regulation (EU) No. 517/2014 on fluorinated greenhouse gases** applies to all systems which contain fluorinated refrigerants and replaces (EC) 842/2006.

The aim of the Regulation is to protect the environment by reducing emissions of fluorinated greenhouse gases.

Among other things it regulates the emission limits, use and recovery of these substances. It also contains requirements for operators of systems which require / contain these substances to function.

Under Regulation 517/2014, the operator of a system of this nature has the following duties:

- The operator must ensure that the equipment is checked at regular intervals for leaks.
- These intervals depend on the CO<sub>2</sub> equivalent of the system. This is calculated from the refrigerant fill volume and type of refrigerant. The CO<sub>2</sub> equivalent of your system is shown on the model plate.
- The operator undertakes to have maintenance, repair, service, recovery and recycling work carried out by certified personnel who have been authorized by JULABO.
- All such work must be documented. The operator must keep records and archive them for at least five years. The records must be submitted to the relevant authority on request.

Refer to the text of the Regulation for further information.

## 18 Materials for parts in contact with the medium

### 18.1 Circulator

---

Description	Material
Motor	1.4301
Motor shaft and adapter	1.4404
Pump	PPS
Heater	1.4404 / 316L
Sensor 2xPt 100 metal, fitted	1.4571
Sensor connection	1.4301
Float	1.4401
Float pipe	1.4571
Hose	FPM / FKM

## 19 Accessories

A wide selection of accessories is available for the following products at [www.julabo.us](http://www.julabo.us) for optimum adaption to your temperature control task.

### 19.1 For external connection

---

- Bath fluids
- Tubing
- Shut-off valve
- Barbed fittings
- Adapters

### 19.2 For open baths

---

Temperature applications for samples, preparation of samples for serology and clinical chemistry, analysis, etc.

- Test tube racks
- Immersion-height adjustable platforms



## 20 Maintenance, cleaning, storage

### CAUTION



#### **Danger of injury during maintenance, repair and transport Danger from mains voltage.**

- Have all service and repair work carried out by authorized specialists only.
- Switch off the unit and pull the plug,
  - before starting any cleaning work,
  - before carrying out any service or repair work or
  - before moving the unit.
- Empty the unit completely before moving it.
- Transport the unit carefully.

### 20.1 Maintain the refrigeration capacity.



The device is designed for continuous operation in normal conditions. No regular maintenance work is required.

The condenser on the front should be cleaned from time to time to maintain the full refrigeration capacity.

1. Switch off the device.
2. Pull the plug.
3. Let the unit cool down to room temperature.
4. Remove the ventilation grille.
5. Vacuum the dirt on the condenser.

### 20.2 Cleaning

Use low surface tension water (for example soap suds) to clean the bath and the functional parts of the circulator which are immersed in it. Clean the exterior device with a cloth and low surface tension water.

The circulator is designed for continuous use in normal conditions. No regular maintenance work is required.

The bath tank should only be filled with suitable bath fluid. In the event of contamination, the bath fluid must be replaced from time to time.

#### **Cleaning open bath tanks**

### **NOTICE**

- Leaking bath tanks due to unsuitable cleaning products.
- These bath tanks are not resistant to solvents and pure alcohol. Incorrect cleaning products will make the surface of the bath go

cloudy and will dissolve the adhesive. Plastic baths will therefore start to leak.

- Clean bath tanks with wet products - never rub them dry. The cloths or sponges you use should not be contaminated (with scouring particles or dust).
- A good, essentially smear-free cleaning effect can be achieved using a microfiber cloth moistened with water.
- Use warm water with a few drops of washing-up liquid and a soft cloth to clean the bath.
- If it has heavier soiling, particularly if it is greasy, benzol-free pure benzene (washing benzene, light benzene) can be used for cleaning.

## 20.3 Storage

---

Units which are not to be reused must be stored in a dry, place, protected from dust and frost, after cleaning. The system components must be fully emptied and carefully dried, for example using compressed air. Seal the connectors.

## 21 Repair service

Before asking for a service technician or returning a JULABO unit for repair, please contact our Technical Service Department.

JULABO Technical Service

Phone: 610-231-0250 Option 3

Fax: 610-231-0260

Email: [service@julabo.us](mailto:service@julabo.us)

If you return a unit to JULABO:

- Clean the unit to avoid any harm to the service personnel.
- It is essential that you enclose a short fault description.
- Before returning the device, please complete an online return form at <http://www.julabo.com/us/support/us-rma>.
- Ensure careful and adequate packing.
- JULABO cannot accept any liability for damage caused by incorrect packaging.
- In the interest of product improvement, JULABO reserves the right to make any necessary technical modifications during the repair to ensure the proper functioning of the unit.

---

## 22 Waste disposal

### 22.1 Packaging

---

Packaging materials must be disposed of as prescribed by the current local regulations.

### 22.2 Unit

---



In the European Economic Area (EEA) the disposal of waste equipment is regulated in the "**Directive of the European Parliament and of the Council on Waste Electrical and Electronic Equipment (WEEE)**". The current official journal on this matter is available on the European Parliament's homepage.

The symbol for the separate collection of electrical and electronic equipment is a crossed-out trash can.

Disposal with household waste (unsorted waste) or similar collections of municipal waste is not permitted!

Contact an authorized waste disposal contractor in your country.

### 22.3 Refrigerant

---

Refrigerants must be disposed of as prescribed by the current local regulations.

They may only be disposed of by trained personnel.

## 23 Warranty

The following Warranty Provisions shall apply to products sold in North America by Julabo (“**Seller**”) to the entity shown as buyer (“**Buyer**”) on Seller’s invoice.

1. **Initial Warranty.**

Upon Seller’s receipt of payment in full for the products and subject to Buyer’s compliance with the terms of sale and any other agreement with Seller relating to the products, Seller warrants to the Buyer that the products manufactured by the Seller are free from defects in material and workmanship for a period not to exceed two (2) years or ten thousand (10,000) hours of operation, whichever comes first, from the date the product is shipped by Seller to Buyer (the “**Initial Warranty**”).

2. **EXCLUSION OF ALL OTHER EXPRESS WARRANTIES; EXCLUSION OF ALL IMPLIED WARRANTIES. OTHER THAN THE INITIAL WARRANTY, NO OTHER EXPRESS WARRANTIES ARE MADE. ALL IMPLIED WARRANTIES OF EVERY TYPE AND KIND, INCLUDING BUT NOT LIMITED TO ANY IMPLIED WARRANTY OF MERCHANTABILITY OR FITNESS FOR A PARTICULAR PURPOSE OR USE, ARE EXCLUDED IN ALL RESPECTS AND FOR ALL PURPOSES. SELLER DISCLAIMS AND MAKES NO IMPLIED WARRANTIES WHATSOEVER.**

3. **Exclusions.**

The Initial Warranty does not include damage to the product resulting from accident, misuse, improper installation or operation, unauthorized or improper repair, replacement or alteration (including but not limited to repairs, replacements, or alterations made or performed by persons other than Seller’s employees or authorized representatives), failure to provide or use of improper maintenance, unreasonable use or abuse of the product, or failure to follow written installation or operating instructions. Buyer must return the product’s record of purchase to the Seller or one of Seller’s authorized representatives within thirty (30) days of the date the product is shipped by Seller to Buyer in order to make a claim under the Initial Warranty. Notwithstanding anything contained herein to the contrary, all glassware, including but not limited to reference thermometers, are expressly excluded from the Initial Warranty.

4. **Buyer’s sole remedies; Limitations on Seller’s Liability.** Buyer’s sole and exclusive remedy under the Initial Warranty is strictly limited, in Seller’s sole discretion, to either: (i) repairing defective parts; or (ii) replacing defective parts. In either case, the warranty period for the product receiving a repaired or replaced part pursuant to the terms of the Initial Warranty shall not be extended. All

repairs or replacements performed by Seller pursuant to these Warranty Provisions shall be performed at Seller's facility in Allentown, Pennsylvania, U.S.A. or at the facility of an authorized representative of Seller, which location shall be determined by Seller in its sole discretion; provided, however, that Seller may, in its sole discretion perform such repairs or replacements at Buyer's facility in which case Buyer shall pay Seller's travel, living and related expenses incurred by Seller in performing the repairs or replacements at Buyer's facility. As a condition precedent to Seller's obligation to repair or replace a product part under the Initial Warranty, Buyer shall (i) promptly notify Seller in writing of any such defect; (ii) shall have returned the product's record of purchase to Seller or to one of Seller's authorized representatives within thirty (30) days of the date the product is delivered to Buyer; and (iii) assist Seller in all respects in its attempts to determine the legitimacy and basis of any claims made by or on behalf of Buyer including but not limited to providing Seller with access to the product to check operating conditions. If Buyer does not provide such written notice to Seller within the Initial Warranty period or fails to return the product's record of purchase as set forth above, Seller shall have no further liability or obligation to Buyer therefore. In no event shall Seller's liability under the Initial Warranty exceed the original purchase price of the product which is the subject of the alleged defect.

**5. THE REMEDIES PROVIDED IN THE INITIAL WARRANTY ARE THE SOLE AND EXCLUSIVE REMEDIES AVAILABLE TO THE BUYER. NOTWITHSTANDING ANYTHING TO THE CONTRARY CONTAINED HEREIN, AND EVEN IF THE SOLE AND EXCLUSIVE REMEDIES FAIL OF THEIR ESSENTIAL PURPOSE FOR ANY REASON WHATSOEVER, IN NO EVENT SHALL SELLER BE LIABLE FOR BUYER'S MANUFACTURING COSTS, LOST PROFITS, GOODWILL, OR ANY OTHER SPECIAL, INDIRECT, PUNITIVE, INCIDENTAL OR CONSEQUENTIAL DAMAGES TO BUYER OR ANY THIRD PARTY AND ALL SUCH DAMAGES ARE HEREBY DISCLAIMED.**

6. **Assignment.** Buyer shall not assign any of its rights or obligations hereunder without the prior written approval of Seller; provided, however, that if Buyer is a distributor of Seller, the rights and obligations of Buyer under these Warranty Provisions shall inure to the benefit of and be binding upon Buyer's customers who provide the product's proof of purchase to Seller pursuant to the terms set forth herein. Seller may assign any or all of its rights or obligations hereunder without Buyer's prior consent.

7. **Governing Law.**

The Warranty Provisions and all questions relating to their validity, interpretation, performance, and enforcement shall be construed in accordance with, and shall be governed by, the substantive laws of the Commonwealth of Pennsylvania without regard to its principles of conflicts of law.

8. **Waiver.**

Any failure of the part of Seller to insist on strict compliance with the Warranty Provisions shall no way constitute a waiver of such right. No claim or rights arising out of a breach of the Warranty Provisions by Buyer may be discharged in whole or in part by a waiver of the claim or right, unless the waiver is in writing signed by an authorized representative of Seller. Seller's waiver or acceptance of any breach by Buyer of any provisions of the Warranty Provisions shall not constitute a waiver of or an excuse for nonperformance as to any other provision of the Warranty Provisions nor as to any prior or subsequent breach of the same provision.

9. **Freight.**

Buyer will arrange and pay for shipping and handling charges for the unit to be returned to the Seller. Seller will arrange and pay for shipping and handling for the return of the unit to the Buyer.



**JULABO USA, Inc.**

884 Marcon Boulevard

Allentown, PA 18109

Phone: +1(610) 231-0250

Fax: +1(610) 231-0260

info@julabo.us

[www.julabo.us](http://www.julabo.us)



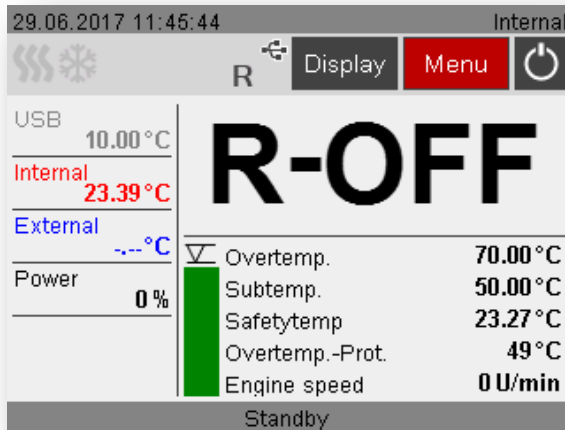

## Remote control and unit messages with DYNEO

### Operating manual

**Important:** keep original operating manual for future use.

19531301-V0

## 1 Operating the DYNEO DD via RS232 interface

### 1.1 Preparations for remote operation via the RS232 interface

#### NOTICE

**Use shielded cables only.**

The shield should be continuous, and should be electrically connected to the plug's housing.

**When working with the SERIAL interface, use a null modem cable.**

Normal operation can be ensured only if cables no longer than 3m (9.85 ft.) are used. The use of longer cables does not itself affect proper performance of the unit, however external interference (e.g. cellular phones) may have a negative impact on performance in this configuration.

Use this socket to connect a PC via null modem cable to the circulator in order to remotely control the temperature control system.

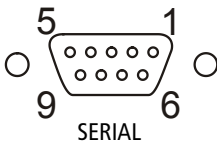

#### RS232 pin assignments

Pin 2	RxD	Receive Data
Pin 3	TxD	Transmit Data
Pin 5	0 V	Signal GND
Pin 7	RTS	Request to send
Pin 8	CTS	Clear to send

Pin 1; 4; 6, 9 Reserved - do not use!

#### Factory settings of the interface parameter

BAUDRATE	4800 Bd
PARITY	even parity
HANDSHAKE	Protocol RTS/CTS (Hardware handshake)
Datenbits	7
Stopbit	1

#### Accessories

**Order No.**

**Order text**

- |             |  |
|-------------|--|
| • 8 980 073 | • RS232 interface cable 9-pole/9-pole , 2.5 m long |
| • 8 900 110 | • USB Interface-adapter cable                      |

## 1.2 Interface commands

<b>IN-PV (PV= Process value)</b>	<b>Response of instrument</b>
in_pv_00	Actual bath temperature.
in_pv_01	Heating power being used (%).
in_pv_02	Temperature value registered by the external Pt100 sensor.
in_pv_03	Temperature value registered by the safety sensor >TANK<.
in_pv_04	Over-temperature safety device setting.
<b>IN-SP (SP= Setpoint)</b>	
in_sp_00	Working temperature (setpoint 1).
in_sp_03	Upper temperature limit.
in_sp_04	Lower temperature limit.
in_sp_05	Setpoint temperature of the external programmer (socket REG+E-PROG).
in_sp_07*	Selected pump stages (1...4)
in_sp_27	Pump adjustments
in_sp_10	Selected variable setting via the serial interface.
in_sp_11	Temperature indication in 0 = °C 1 = °F
* do not use for reprogramming, see in_sp_27. At pump level 4, the outlet pressure is approx. 450 mbar.	





<b>IN_MODE</b>	
in_mode_01	Setpoint for control set to 0
in_mode_03	Type of external programmer input (EPROG): 0 = Voltage      0 V to 10 V 1 = Current      0 mA to 20 mA
in_mode_04	Internal/external temperature control: 0 = Temperature control with internal sensor. 1 = Temperature control with external Pt100 sensor.
in_mode_05	Unit in stop/start condition: 0 = stop 1 = start
in_mode_08	Adjusted control dynamics 0 = aperiodic 1 = standard
in_mode_11	Source of correcting variable 1 = Circulator 1 = serial 2 = analog (Eprog)
<b>IN_PAR</b>	
in_par_00	Difference between the working sensor and the safety sensor
in_par_01	Te - Time constant of the external bath.
in_par_02	Si - Internal slope.
in_par_03	Ti - Time constant of the internal bath.
in_par_04	Control parameter CoSpeed of the external controller.
in_par_05	Ratio of cooling / heating capacity pk to ph.
in_par_06	Xp control parameter of the internal controller.
in_par_07	Tn control parameter of the internal controller.
in_par_08	Tv control parameter of the internal controller.
in_par_09	Xp control parameter of the cascade controller.
in_par_10	Proportional share of the cascade controller.
in_par_11	Tn control parameter of the cascade controller.
in_par_12	Tv control parameter of the cascade controller.

in_par_13	Adjusted maximum internal temperature of the cascade controller.
in_par_14	Adjusted minimum internal temperature of the cascade controller.
in_par_15	Adjusted minimum internal temperature of the cascade controller.
in_par_16	Band limit (lower); Lower band limit.
<b>IN_HIL</b>	<b>Parameter</b>
in_hil_00	Max. cooling power (%).
in_hil_01	Max. heating power (%).
	<b>Special parameter</b>
version	Firmware version.
status	Status/ error .
	<b>Parameter OUT-SP</b>
out_sp_00	Adjustment of the setpoint. xxx.xx
out_sp_03	Adjustment of the upper temperature. xx.xx
out_sp_04	Adjustment of the lower temperature.. xxx.xx
out_sp_07*	Set pump to factory settings 1 ... 4.
out_sp_27	Adjust the pump stepless
out_sp_10	Adjustment of the setpoint correction variable via the serial interface.
out_sp_11	Temperature units. 0 = °C 1 = °F
* do not use for reprogramming, see out_sp_27. At pump level 4, the outlet pressure is approx. 450 mbar.	
	<b>OUT commands</b>
out_mode_01	Use working temperature 0
out_mode_03	Set external programmer EPROG input to: 0 = 0 - 10V 1 = 0 - 20mA
out_mode_04	Temperature control of bath. 0 = internal; 1 = external with Pt100 sensor

out_mode_05	Start-/Stop command in remote operation. 0 = R -OFF 1 = R -ON-
out_mode_08	Set the control dynamics. 0 = aperiodic 1 = standard
out_mode_11	Source of correcting variable 1 = Circulator 1 = serial 2 = analog (Eprog)
	<b>System parameter OUT_PAR</b>
out_par_06	Xp control parameter of the internal controller.
out_par_07	Tn control parameter of the internal controller.
out_par_08	Tv control parameter of the internal controller.
out_par_09	Xp control parameter of the cascade controller.
out_par_10	Proportional portion of the cascade controller.
out_par_11	Tn control parameter of the cascade controller.
out_par_12	Tv control parameter of the cascade controller.
out_par_13	Maximum internal temperature of the cascade controller.
out_par_14	Minimum internal temperature of the cascade controller.
out_par_15	Upper band limit.
out_par_16	Lower band limit.
	<b>Parameter OUT_HIL</b>
out_hil_00	Max. cooling power (%).
out_hil_01	Max. heating power (%).

## 2 Unit messages

### 2.1 Error messages / Diagnosis / Remedy

 + 	<p>The following faults which trigger alarms result in the units's heater and circulating pump being shut down permanently.</p> <p>The alarm indicator  lights up and a continuous signal tone will sound. The reason for the alarm or warning will be shown on the LED temperature display in coded form.</p> <p>Warnings are displayed alternately with the actual value on the display.</p>
	<p>The signal tone can be muted by pressing the control key.</p>
<p><b>E 01</b></p>	<p>The device is being operated with no or too little bath fluid or the level is below the minimum level. Top up the bath fluid.</p> <p>A hose has burst (bath fluid level too low because it has been pumped out). Replace the hose and top up the bath fluid.</p>
<p><b>E 03</b></p>	<p>The temperature measured is above the overheating limit. Please raise the overheating limit, or lower the temperature setpoint.</p>
<p><b>E04</b></p>	<p>The temperature measured is below the configured subtemperature limit. Please lower the subtemperature limit, or increase the temperature setpoint.</p>
<p><b>E 05</b></p>	<p>The cable for the working temperature sensor has been interrupted or short-circuited.</p>
<p><b>E 06</b></p>	<p>Defect of the working or excess temperature sensor.</p> <p>The working and excess temperature sensors report a temperature difference of more than 20 K.</p>
<p><b>E 14</b></p>	<p>The cut-out value of the excessive temperature protector is below the defined working temperature .</p> <p>Set the safety temperature to a higher value.</p>
<p><b>E 15</b></p>	<p>The unit is configured for external control but the line to the external control probe (EXT Pt100) is short circuit or interrupted.</p> <p>Check the electrical connection to the external control probe.</p>
<p><b>E 33</b></p>	<p>The cable for the overtemperature safety sensor has been broken or short-circuited.</p>
<p><b>E 40</b></p>	<p>Please refill temperature control liquid.</p>
<p><b>E 60</b></p>	<p>Internal error. Contact JULABO Service Department.</p>

<p><b>E 61</b></p>	<p>Connection error between DYNEO and refrigeration unit</p> <p>The data communication between the DYNEO and the refrigeration unit is permanently monitored. If communication cannot be established (e.g. by a defective connection cable), the error message „E 61“ is generated. By pressing the „Control“ key, the alarm is acknowledged. The DYNEO continues operating purely as heating circulator until the next interruption of the power supply (power-off). When the fault has been repaired, the DYNEO controls the refrigeration unit according to the settings in the menu (Off, Auto, On) after the next power-on.</p>
<p><b>E 63</b></p>	<p>Internal error. Contact JULABO Service Department.</p>
<p><b>E 70</b></p>	<p>Internal error. Contact JULABO Service Department.</p>
<p><b>E 71</b></p>	<p>Unit ist operated with wrong mains voltage frequency.</p>
<p><b>E 72, E80</b></p>	<p>Internal error. Contact JULABO Service Department</p>
<p><b>E 82</b></p>	<p>Warning: Update error (incorrect hex file). Contact JULABO Service Department.</p>
<p><b>E 83</b></p>	<p>Warning: Excessive power consumption via USB interface (&lt;300 mA).</p>
<p><b>E 104, E 106, E 107, E 112</b></p>	<p>Internal error. Contact JULABO Service Department</p>
<p><b>E108 E116</b></p>	<p>The self-locking alarm is still active. Switch off the device at the main switch. Wait for approx. 4 seconds and then switch it on again.</p>
<p><b>E118, E 1103</b></p>	<p>Internal error. Contact JULABO Service Department</p>
<p><b>E 1109</b></p>	<p>Check heat transfer medium for suitability for use in the temperature range in use! The viscosity of the heat transfer medium may not exceed the maximum permitted value at any working temperature. Please contact JULABO Service if you have any questions regarding JULABO heat transfer media.</p>
<p><b>E 1305</b></p>	<p>Motor defective or viscosity of heat transfer medium is to high.</p>



	<b>Alarms and warnings for refrigeration machines 200F, 201F, 300F</b>
<b>E431</b>	Maximum compressor current exceeded.
<b>E1431</b>	Warning: No compressor current detected.

	<b>Alarms and warnings for refrigeration machine 600F, 1000F, 1001F</b>
<b>E401</b>	Temperature sensor evaporator outlet defective (short circuit).
<b>E402</b>	Temperature sensor evaporator outlet defective (break).
<b>E413</b>	Evaporation pressure sensor defective (short circuit).
<b>E414</b>	Evaporation pressure sensor defective (break).
<b>E417</b>	Condensation pressure sensor defective (short circuit).
<b>E418</b>	Condensation pressure sensor defective (break).
<b>E425</b>	Error in refrigeration system.
<b>E426</b>	Error in refrigeration system.
<b>E427</b>	Error in refrigeration system.
<b>E1427</b>	Warning: Error in refrigeration system
<b>E431</b>	Maximum compressor current exceeded.
<b>E432</b>	Error in refrigeration system.
<b>E433</b>	Error in refrigeration system.
<b>E1431</b>	Warning: No compressor current detected.

## **To cancel the alarm state**

1. Switch off the device at the main switch.
2. Eliminate the cause of the alarm.
3. Eliminate the cause of the alarm or wait for approx. 4 seconds, depending on error type.
4. Switch on the device again at the mains power switch.
5. If the error occurs again, a remote diagnostic is to be made.

## **Faults which are not displayed:**

Circulating pump motor overload protection.

The circulating pump motor is protected from overloads. After a cooling phase the motor will restart automatically.

If necessary the unit should be inspected by a JULABO service technician.

## **JULABO Technical Service**

Phone: 610-231-0250 Option 3

Fax: 610-231-0260

Email: [service@julabo.us](mailto:service@julabo.us)



**JULABO USA, Inc.**

884 Marcon Boulevard

Allentown, PA 18109

Phone: +1(610) 231-0250

Fax: +1(610) 231-0260

info@julabo.us

[www.julabo.us](http://www.julabo.us)