

# OPERATING MANUAL

## Refrigerated/Heating Circulators

air-cooled

F25-HL

F32-HL

F33-HL

FP35-HL

FP40-HL

FP50-HL

---

water-cooled

FPW50-HL

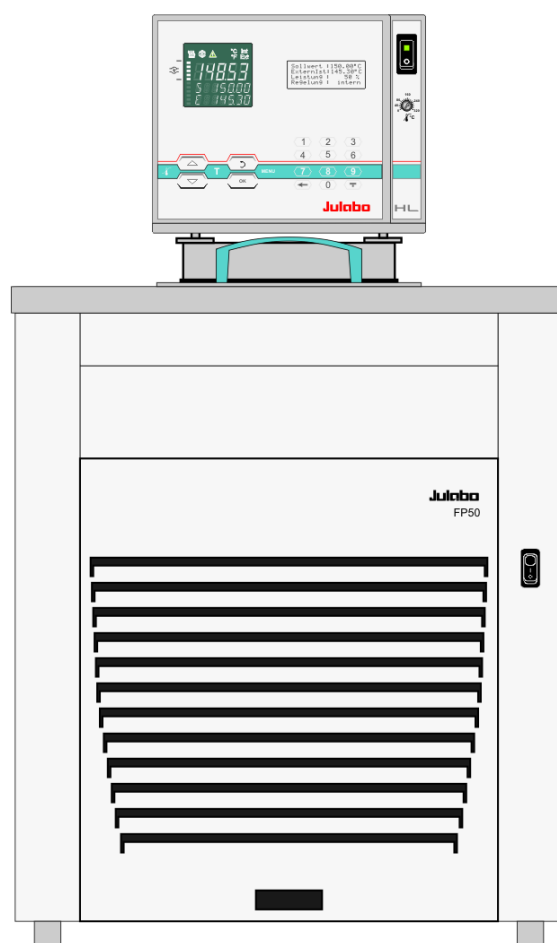

Original Operating Manual

**Julabo**  
THE TEMPERATURE CONTROL COMPANY

JULABO USA, Inc.  
884 Marcon Boulevard  
Allentown, PA 18109  
Phone: +1(610) 231-0250  
Fax: +1(610) 231-0260  
info.us@julabo.com  
www.julabo.com

---

## **Congratulations!**

You have made an excellent choice.

JULABO thanks you for the trust you have placed in us.

This operating manual has been designed to help you gain an understanding of the operation and possible applications of our circulators. For optimal utilization of all functions, we recommend that you thoroughly study this manual prior to beginning operation.

## **The JULABO Quality Management System**



Temperature control devices for research and industry are developed, produced, and distributed according to the requirements of ISO 9001 and ISO 14001. Certificate Registration No. 01 100044846

## **Unpacking and inspecting**

Unpack the circulator and accessories and inspect them for possible transport damage. Damage should be reported to the responsible carrier, railway, or postal authority, and a damage report should be requested. These instructions must be followed fully for us to guarantee our full support of your claim for protecting against loss from concealed damage. The form required for filing such a claim will be provided by the carrier.

Printed in Germany



Changes without prior notification reserved

**Important:** keep operation manual for future use

1.953.2809-V6

06/18

## TABLE OF CONTENTS

Operating manual.....	5
1. Intended use.....	5
1.1. Description.....	5
2. Operator responsibility – Safety recommendations.....	6
2.1. Disposal.....	8
2.2. Technical specifications.....	9
2.3. Cooling water connection.....	13
Operating instructions.....	14
3. Safety notes for the user.....	14
3.1. Explanation of safety notes.....	14
3.2. Explanation of other notes.....	14
3.3. Safety recommendations.....	15
4. Operating controls and functional elements.....	17
5. Preparations.....	22
5.1. Installation.....	22
5.2. Bath fluids.....	22
5.3. Temperature application to external systems.....	24
5.3.1. Tubing.....	25
5.4. Filling / draining.....	26
6. Operating procedures.....	27
6.1. Power connection.....	27
6.2. Switching on / Selecting the language.....	27
6.2.1. Switching on the circulator.....	27
6.2.2. Switching on the cooling machine.....	28
6.3. Start - Stop.....	28
7.  Setting of temperatures.....	29
8.  Safety installations, warning functions.....	29
8.0.1. Early warning system, low level protection.....	33
9.  Menu functions.....	34
9.1. Start of a program.....	36
9.1.1. Status at the end of a program.....	38
9.1.2. Indication after successful start.....	38
9.1.3. Editing after Start.....	39
9.1.4. Interrupting a program.....	39
9.1.5. Interruption after a power failure.....	40
9.1.6. Termination of a program.....	40
9.2. Program administration, creation.....	41
9.3. Setting the pump pressure.....	45
9.4. Configuration.....	46
9.4.1. Remote control via the serial interface.....	49
9.4.2. Keypad control or setpoint setting via the analog input.....	49
9.4.3. Autostart.....	50

---

9.4.4. Off-Mode .....	50
9.4.5. ActVar - actuating variable.....	51
9.4.6. Setting of clock and date .....	52
9.4.7. Language .....	52
9.4.8. Unit.....	52
9.4.9. Program type.....	52
9.4.10. Reset.....	52
9.5. Control .....	53
9.5.1. Control internal / external.....	55
9.5.2. Selftuning .....	56
9.5.3. Dynamik intern .....	56
9.5.4. CoSpeed - extern .....	57
9.5.5. Control parameters – internal/external.....	57
9.6. Serial Interface.....	59
9.7. ATC Absolute Temperature Calibration, 3-point calibration.....	60
9.7.1. ATC Fühler - intern / extern .....	63
9.7.2. ATC Status - yes / no .....	63
9.7.3. Type 1 -/ 2 -/ 3 point .....	63
9.7.4. Example: 3-point calibration for internal control .....	64
9.8. Limits .....	66
9.8.1. Limits for internal control and external control.....	67
9.8.2. Limits for external control.....	68
9.9. Analog inputs/outputs .....	69
9.9.1. Control connector .....	73
9.9.2. Outputs of the connector - REG+E-PROG.....	74
9.9.3. Input of the connector - REG+E-PROG .....	75
9.9.4. External Stand-by input .....	77
9.9.5. Alarm-output.....	78
10. Troubleshooting guide / Error messages .....	79
11. Electrical connections.....	82
12. Remote control .....	85
12.1. Setup for remote control.....	85
12.2. Communication with a PC or a superordinated data system .....	85
12.3. List of commands.....	86
12.4. Status messages .....	90
12.5. Error messages.....	90
13. Installation of electronic module with analog connectors .....	91
14. JULABO Service – Online remote diagnosis .....	92
15. Cleaning / repairing the unit.....	93
16. WARRANTY PROVISIONS.....	94

## Operating manual

### 1. Intended use

JULABO circulators have been designed to control the temperature of specific fluids in a bath tank. The units feature pump connections for temperature control of external systems (loop circuit).



JULABO circulators are not suitable for direct temperature control of foods, semi-luxury foods and tobacco, or pharmaceutical and medical products. Direct temperature control means unprotected contact of the object with the bath medium (bath fluid).

#### 1.1. Description

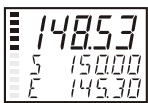

Setpoint : 150.00°C  
InternAct : 148.53°C  
Power : 602  
Control : Intern

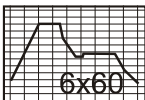
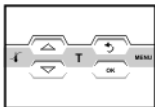

**ICC**

**TCF**

**ATC<sup>3</sup>**

**RS232**  
**RS485**

**Pt100**

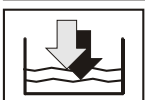
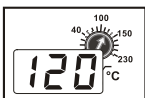

**SMART PUMP**

- The circulators are operated via the splash-proof keypad. The implemented microprocessor technology allows to set and to store different values that can be indicated on the VFD COMFORT-DISPLAY and LCD DIALOG-DISPLAY. Three menu keys facilitate adjusting setpoints, warning and safety functions and menu functions.
- The integrated programmer allows storing and running temperature and time-dependent processes.
- The control electronics including “ICC - Intelligent Cascade Control“ automatically adapts the heat supplied to the thermal requirements of the bath.
- The TCF - **Temperature Control Features** allow the user to have access to all important temperature control parameters. This means: Full control on the control mode and the chance to manually adjust or adapt control to the specific application.
- Absolute Temperature Calibration (ATC3) provides high temperature stability in the bath. With the 3-point calibration an offset is adjusted at three temperatures to ensure an accurate temperature pattern at the selected spot in the bath over the full temperature range.
- Electrical connections:  
The serial interface, switchable from RS232 to RS485, allows modern process technology without additional interface.  
Connection for Pt100 external sensor for external temperature measurement and control.  
Alarm output for external alarm message or control of JULABO refrigerating baths or solenoid valve (cooling water).  
The electronic module (option) provides 3 further analog connections (alarm input, standby input, recorder output, programmer input).
- The excess temperature protection conforming to IEC 61010-2-010 is a safety installation independent from the control circuit. This protection can be indicated and set on the LCD DIALOG-DISPLAY.
- The early warning system for low level signals that bath fluid needs to be refilled before the low level protection conforming to IEC 61010-2-010 causes a complete shut-down of the main functional elements.
- Intelligent pump system: The pump capacity (electronically adjustable via the motor speed) enables to adapt to varying conditions for internal and external temperature applications.

## 2. Operator responsibility – Safety recommendations

The products of JULABO ensure safe operation when installed, operated, and maintained according to common safety regulations. This section explains the potential dangers that may arise when operating the circulator and also specifies the most important safety precautions to preclude these dangers as far as possible.

- The operator is responsible for the qualification of the personnel operating the units.
- The personnel operating the units should be regularly instructed about the dangers involved with their job activities as well as measures to avert these dangers.
- Make sure all persons tasked with operating, installing, and maintaining the unit have read and understand the safety information and operating instructions.
- When using hazardous materials or materials that could become hazardous, the circulator may be operated only by persons who are absolutely familiar with these materials and the circulator. These persons must be fully aware of possible risks.

If you have any questions concerning the operation of your unit or the information in this manual, please contact us!

<b>Contact</b>	JULABO USA, Inc. 884 Marcon Boulevard Allentown, PA 18109	Phone: +1(610) 231-0250 Fax: +1(610) 231-0260 info.us@julabo.com www.julabo.com
----------------	---	--

### Safety instructions for the operator:

- You have received a product designed for industrial use. Nevertheless, avoid strikes to the housing, vibrations, damage to the operating-element panel (keypad, display), and contamination.
- Make sure the product is checked for proper condition regularly (depending on the conditions of use). Regularly check (at least every 2 years) the proper condition of the mandatory, warning, prohibition and safety labels.
- Make sure that the mains power supply has low impedance to avoid any negative effects on instruments being operated on the same mains.
- This unit is designed for operation in a controlled electromagnetic environment. This means that transmitting devices (e.g., cellular phones) should not be used in the immediate vicinity. Magnetic radiation may affect other devices with components sensitive to magnetic fields (e.g., monitors). We recommend maintaining a minimum distance of 1 m.
- Permissible ambient temperature: max. 40 °C, min. 5 °C.
- Permissible relative humidity: 50% (40 °C).
- Do not store the unit in an aggressive atmosphere.
- Protect the unit from contamination.
- Do not expose the unit to sunlight.

### Appropriate operation

Only qualified personnel is authorized to perform configuration, installation, maintenance and repairs of the circulator.

Routine operation can also be carried out by untrained personnel who should however be instructed by trained personnel.

**Use:**

The bath can be filled with flammable materials. Fire hazard!

There might be chemical dangers depending on the bath medium used.

Observe all warnings for the used materials (bath fluids) and the respective instructions (safety data sheets).



Insufficient ventilation may result in the formation of explosive mixtures. Only use the unit in well ventilated areas.

Only use recommended materials (bath fluids). Only use non-acid and non corroding materials.

When using hazardous materials or materials that could become hazardous, **the operator must** affix the enclosed safety labels to the front of the unit so they are highly visible:

If this unit is intended for use within the United States of America, all 3 warning labels **must** be affixed to the housing of the unit prior to use.

Directions for the positioning of the individual warning labels are enclosed with the warning labels included in the delivery. Warning labels must be easily visible to users.

<b>1</b>		Warning label W00: Colors: yellow, black Danger area. Attention! Observe instructions. (operating manual, safety data sheet)
<b>2</b>		Mandatory label M018: Colors: blue, white Carefully read the user information prior to beginning operation. <b>Scope: EU</b>
<b>or</b>		
<b>2</b>		Semi S1-0701 Table A1-2 #9 Carefully read the user information prior to beginning operation. <b>Scope: USA, NAFTA</b>
<b>3</b>	<div style="border: 1px solid black; padding: 5px; width: fit-content; margin: auto;"><b>WARNING:</b> This product contains chemicals known to the state of California to cause cancer, birth defects or other reproductive harm.</div>	Warning label Proposition 65

Particular care and attention is necessary because of the wide operating range.

There are thermal dangers: Burn, scald, hot steam, hot parts and surfaces that can be touched.

	Warning label W26: Colors: yellow, black Hot surface warning. (The label is put on by JULABO)
---	---

Observe the instructions in the manuals for instruments of a different make that you connect to the circulator, particularly the respective safety recommendations. Also observe the pin assignment of plugs and technical specifications of the products.

## 2.1. Disposal

The circulator contains a back-up battery that supplies voltage to memory chips when the unit is switched off. Do not dispose of the battery with household waste!

Depending on battery regulations in your country, you might be obliged to give back used or defect batteries to gathering places.

The product may be used with oil as bath fluid. These oils fully or partially consist of mineral oil or synthetic oil. For disposal, observe the instructions in the safety data sheets.

This unit contains refrigerants, which at this time are not considered harmful to the ozone layer. However, over the long operating period of the unit, disposal rules may change. Therefore, only qualified personnel should handle the disposal.

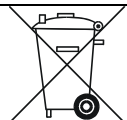

Contact an authorized waste management company in your country.  
Disposal with household waste (unsorted waste) or similar collections of municipal waste is not permitted!



## 2.2. Technical specifications

			F25-HL	F32-HL
Working temperature range		°C	-28 ... 200	-35 ... 200
Temperature stability		°C	±0,01	±0,01
Cooling capacity		°C	<u>+20 0 -20</u>	<u>+20 0 -20 -30</u>
Medium: ethanol		kW	0.26 0.2 0.06	0.45 0.39 0.15 0.06
Refrigerant			R134a	R134a
Overall dimensions	(WxDxH)	cm	23x42x64	31x42x64
Bath opening	(WxL)	cm	12x14	18x12
Bath depth		cm	14	15
Filling volume		liters	3 ... 4,5	5,5 ... 8
Weight		kg	32	38
Mains power connection		V/ Hz	230 / 50	230 / 50
Current draw	(at 230 V)	A	12	12
Current draw, CH, GB	(at 230 V)	A	<9+2>	<9+2>
Mains power connection		V/ Hz	-----	230 / 60
Current draw	(at 230 V)	A	-----	12
Mains power connection		V/ Hz	115 / 60	115 / 60
Current draw	(at 115 V)	A	13	14
Mains power connection		V/ Hz	100 / 50/60	100 / 50/60
Current draw	(at 100 V)	A	13	14

			F33-HL
Working temperature range		°C	-30 ... 200
Temperature stability		°C	±0.01
Cooling capacity		°C	<u>+20 0 -20 -30</u>
Medium: ethanol		kW	0.5 0.32 0.12 0.03
Refrigerant			R134a
Overall dimensions	(WxDxH)	cm	36x46x71
Bath opening	(WxL)	cm	23x14
Bath depth		cm	20
Filling volume		liters	12 ... 16
Weight		kg	45
Mains power connection		V/Hz	230 / 50/60
Current draw	(at 230 V)	A	12
Current draw, CH, GB	(at 230 V)	A	<9+2>
Mains power connection		V/ Hz	100 / 50/60
Current draw	(at 100 V)	A	15
Mains power connection		V/ Hz	115 / 60
Current draw	(at 115 V)	A	15

			FP35-HL	FP40-HL
Working temperature range		°C	-35 ... 200	-40 ... 200
Temperature stability		°C	±0.01	±0.01
Cooling capacity		°C	<u>+20</u> <u>0</u> <u>-20</u> <u>-30</u>	<u>+20</u> <u>0</u> <u>-20</u> <u>-40</u>
Medium: ethanol		kW	0.45 0.39 0.15 0.05	0.68 0.5 0.32 0.04
Refrigerant			R134a	R134a
Overall dimensions	(WxDxH)	cm	31x42x66	36x46x71
Bath opening	(WxL)	cm	18x12	23x14
Bath depth		cm	----	20
Filling volume		liters	2.5	9 ... 16
Weight		kg	38	49
Mains power connection		V/Hz	230 / 50	230 / 50
Current draw	(at 230 V)	A	12	13
Current draw, CH, GB	(at 230 V)	A	<9+2>	<9+3>
Mains power connection		V/ Hz	----	230 / 60
Current draw	(at 230 V)	A	----	13
Mains power connection		V/ Hz	115 / 60	----
Current draw	(at 115 V)	A	14	----
Mains power connection		V/ Hz	100 / 50/60	----
Current draw	(at 100 V)	A	14	----

			FP50-HL	
Working temperature range		°C	-50 ... 200	
Temperature stability		°C	±0.01	
Cooling capacity		°C	<u>+20</u> <u>0</u> <u>-20</u> <u>-40</u>	
Medium: ethanol		kW	0.9 0.8 0.5 0.16	
Refrigerant			R404A / R507	
Overall dimensions	(WxDxH)	cm	42x49x72	
Bath opening	(WxL)	cm	18x12	
Bath depth		cm	20	
Filling volume		liters	5.5 ... 8	
Weight		kg	57	
Mains power connection	230 V/50 Hz	V/Hz	230 / 50	
Current draw	(at 230 V)	A	14	
Current draw, CH, GB	(at 230 V)	A	<9+4>	
Mains power connection		V/ Hz	230 / 60	
Current draw	(at 230 V)	A	14	

FPW50-HL			
Working temperature range		°C	-50 ... 200
Temperature stability		°C	±0.01
Cooling capacity		°C	<u>+20</u> 0 -20 -40
Medium: ethanol		kW	0.9 0.8 0.5 0.16
Refrigerant			R404A / R507
Overall dimensions	(WxDxH)	cm	42x49x72
Bath opening	(WxL)	cm	18x12
Bath depth		cm	20
Filling volume		liters	5.5 ... 8
Weight		kg	57
Mains power connection		V/Hz	230/ 50
Current draw	(at 230 V)	A	14
Current draw, CH, GB	(at 230 V)	A	<9+4>
Mains power connection		V/ Hz	230 / 60
Current draw	(at 230 V)	A	14

HL			
Temperature selection			digital
via keypad			indication on LCD DIALOG-DISPLAY (°C/°F)
remote control via PC			indication on monitor
Temperature indication			VFD COMFORT-DISPLAY (°C/°F)
Resolution		°C	0.01
ATC3	INT / EXT	°C	±3 / ±9
Temperature control			ICC - Intelligent Cascade Control
Heater wattage	(at 230 V)	kW	2.0
Heater wattage	(at 115 V)	kW	1.0
Electronically adj. pump capacity		stages	1 ... 4
Flow rate	at 0 bar	l/min	22 ... 26
Max. pressure	at 0 liters	bar	0.7
Max. suction	at 0 liters	bar	0.4
Electrical connections:			see page 12
Ambient temperature		°C	5 ... 40
Mains power connection		V/ Hz	208-230 / 50/60
Current draw	(at 208 V / 230 V)	A	8 / 9
Mains power connection		V/ Hz	100-115 / 50/60
Current draw	(at 100 V / 115 V)	A	9 / 10

All measurements have been carried out at: rated voltage and frequency  
 ambient temperature: 20 °C      Technical changes without prior notification reserved.

**Electrical connections:**

External alarm device            24-0 V DC / max. 25 mA  
 Computer interface RS232 or RS485  
 External Pt100 sensor

<u>Optional for HL, SL</u>	
(Order No. 8900100 Electronic module with analog connections)	
Programmer input -100 °C to 400 °C = 0 - 10 V or 0 - 20 mA or 4 - 20 mA	
Input for the signal of a flow meter or external manipulated variable	
Temperature recorder outputs	0 - 10 V (0 V = -100 °C, 10 V = 400 °C)
	0 - 20 mA (0 mA = -100 °C, 20 mA = 400 °C)
	4 - 20 mA (4 mA = -100 °C, 20 mA = 400 °C)
Standby input	for external emergency switch-off
Alarm output	for external alarm signal

Safety installations according to IEC 61010-2-010:

Excess temperature protection	adjustable from 0 °C ... 320 °C
Low liquid level protection	float switch
Classification according to DIN 12876-1	class III

Supplementary safety installations

Early warning system for low level	float switch
High temperature warning function	optical + audible (in intervals)
Low temperature warning function	optical + audible (in intervals)
Supervision of working sensor	plausibility control
Reciprocal sensor monitoring between working and safety sensors	difference >35 K
Alarm message	optical + audible (permanent)
Warning message	optical + audible (in intervals)

Environmental conditions according to IEC 61 010-1:

Use indoors only.  
 Altitude up to 2000 m - normal zero.  
 Ambient temperature: see Technical specifications  
 Humidity:  
 Max. relative humidity 80% for temperatures up to +31 °C,  
 linear decrease down to 50% relative humidity at a temperature of +40 °C  
 Max. mains voltage fluctuations of ±10% are permissible.

Protection class according to IEC 60 529	IP21
The unit corresponds to Class I	
Overvoltage category	II
Pollution degree	2



**Caution:**

The unit is not suitable for use in explosive environment

## EMC requirements

The device is an ISM device of group 1 per CISPR 11 (uses HF for internal purposes) and is classified in class A (industrial and commercial sector).

### NOTICE:

- Devices of class A are intended for the use in an industrial electromagnetic environment.
- When operating in other electromagnetic environments, their electromagnetic compatibility may be impacted.
- This device is not intended for the use in living areas and cannot guarantee adequate protection of the radio reception in such environments.

## 2.3. Cooling water connection

Cooling water pressure (IN / OUT )	max.	6 bar
Difference pressure (IN - OUT )		3.5 to 6 bar
Cooling water temperature		<20 °C

### Recommended quality of cooling water:

pH – value	7,5 to 9,0
Sulfate [SO <sub>4</sub> 2- ]	< 100 ppm
Hydrocarbonate [HCO <sub>3</sub> - ] / Sulphate [SO <sub>4</sub> 2-]	> 1 ppm
Hardness [Ca <sup>2+</sup> , Mg <sup>2+</sup> ] / [HCO <sub>3</sub> -]	> 0,5 dH
Alkalinity	60 ppm < [HCO <sub>3</sub> -] < 300 ppm
Conductivity	< 500 µs / cm
Chloride (CL-)	< 50 ppm
Phosphate (PO <sub>4</sub> 3-)	< 2 ppm
Ammonia (NH <sub>3</sub> )	< 0,5 ppm
Free Chlorine	< 0,5 ppm
Ferri Ions (Fe <sup>3+</sup> )	< 0,5 ppm
Mangano Ions (Mn <sup>2+</sup> )	< 0,05 ppm
Carbon dioxide (CO <sub>2</sub> )	< 10 ppm
Hydrosulfide (H <sub>2</sub> S)	< 50 ppm
Content of oxygen	< 0,1 ppm
Algae growth	impermissible
Suspended solids	impermissible



### Notice:

#### Danger of corrosion of heat exchanger due to unsuitable quality of cooling water.

- Due to its high content of lime hart water is not suitable for cooling and causes calcination of the heat exchanger.
- Ferrous water or water containing ferrous particles will cause formation of rust even in heat exchangers made of stainless steel.
- Chlorous water will cause pitting corrosion in heat exchangers made of stainless steel.
- Due to its corrosive characteristics distilled and deionized water is unsuitable and will cause corrosion of the bath. .
- Due to its corrosive characteristics sea water is not suitable.
- Due to its microbiological (bacteria) components which settle in the heat exchanger untreated and unpurified river water and water from cooling towers is unsuitable.
- Avoid particulate matter in cooling water.
- Avoid putrid water.



**Notice:**      **Cooling water circuit**

Risk of oil leaking from the cooling circuit (compressor) of the recirculating cooler into the cooling water in case of a fault in the circuit!  
Observe the laws and regulations of the water distribution company valid in the location where the unit is operated.

## Operating instructions

### 3. Safety notes for the user

#### 3.1. Explanation of safety notes



In addition to the safety warnings listed, warnings are posted throughout the operating manual. These warnings are designated by an exclamation mark inside an equilateral triangle. "Warning of a dangerous situation (Attention! Please follow the documentation)."

The danger is classified using a signal word.

Read and follow these important instructions for averting dangers.



**Warning:**

Describes a **possibly** highly dangerous situation. If these instructions are not followed, serious injury and danger to life could result.



**Caution:**

Describes a **possibly** dangerous situation. If this is not avoided, slight or minor injuries could result. A warning of possible property damage may also be contained in the text.



**Notice:**

Describes a **possibly** harmful situation. If this is not avoided, the product or anything in its surroundings can be damaged.

#### 3.2. Explanation of other notes



Note!

Draws attention to something special.



Important!

Indicates usage tips and other useful information.



This icon is used in the operating instructions to indicate flashing values or parameters which have to be set or confirmed.

### 3.3. Safety recommendations

Follow the safety instructions to avoid personal injury and property damage. Also, the valid safety instructions for workplaces must be followed.



- Only connect the unit to a power socket with an earthing contact (PE – protective earth)!
- The power supply plug serves as a safe disconnecting device from the line and must always be easily accessible.
- Place the unit on an even surface on a base made of nonflammable material.
- Do not stay in the area below the unit.
- Make sure you read and understand all instructions and safety precautions listed in this manual before installing or operating your unit.
- Adjust excess-temperature safety device below the flash point of the bath fluid.
- Observe the limited working temperature range when using plastic bath tanks.
- Never operate the unit without bath fluid in the bath.
- Pay attention to the thermal expansion of bath oil during heating to avoid overflowing of the fluid.
- Prevent water from entering the hot bath oil.
- Do not drain the bath fluid while it is hot!  
Check the temperature of the bath fluid prior to draining (e.g., by switching the unit on for a short moment).
- Use suitable connecting tubing.
- Avoid sharp bends in the tubing, and maintain a sufficient distance from surrounding walls.
- Make sure that the tubing is securely attached.
- Regularly check the tubing for material defects (e.g., for cracks).
- Never operate damaged or leaking units.
- Always turn off the unit and disconnect the mains cable from the power source before performing any service or maintenance procedures, or before moving the unit.
- Always turn off the unit and disconnect the mains cable from the power source before cleaning the unit.
- Always empty the bath before moving the unit.
- Transport the unit with care.
- Sudden jolts or drops may cause damage in the interior of the unit.
- Observe all warning labels.
- Never remove warning labels.
- Never operate units with damaged mains power cables.
- Repairs are to be carried out only by qualified service personnel.



- Some parts of the bath tank and the pump connections may become extremely hot during continuous operation. Therefore, exercise particular caution when touching these parts.



**Caution:**

The temperature controlling i.e. of fluids in a reactor constitutes normal circulator practice.

We do not know which substances are contained within these vessels.

Many substances are:

- inflammable, easily ignited or explosive
- hazardous to health
- environmentally unsafe

i.e.: **dangerous**

**The user alone is responsible for the handling of these substances!**

The following questions shall help to recognize possible dangers and to reduce the risks to a minimum.

- Are all tubes and electrical cables connected and installed?  
Note:  
sharp edges, hot surfaces in operation, moving machine parts, etc.
- Do dangerous steams or gases arise when heating?  
Is an exhaust needed when working?
- What to do when a dangerous substance was spilled on or in the unit?  
Before starting to work, obtain information concerning the substance and determine the method of decontamination.



**Notice:**

Check the safety installations at least twice a year!

- Excess temperature protection according to IEC 61010-2-010.  
With a screwdriver turn back the adjustable excess temperature protection until the shut-down point (actual temperature).
- Low level protection according to IEC 61010-2-010.  
To check the function of the float, it can be manually lowered with a screwdriver for example.



**WARNING**

This product contains chemicals known to the state of California to cause cancer, birth defects or other reproductive harm.



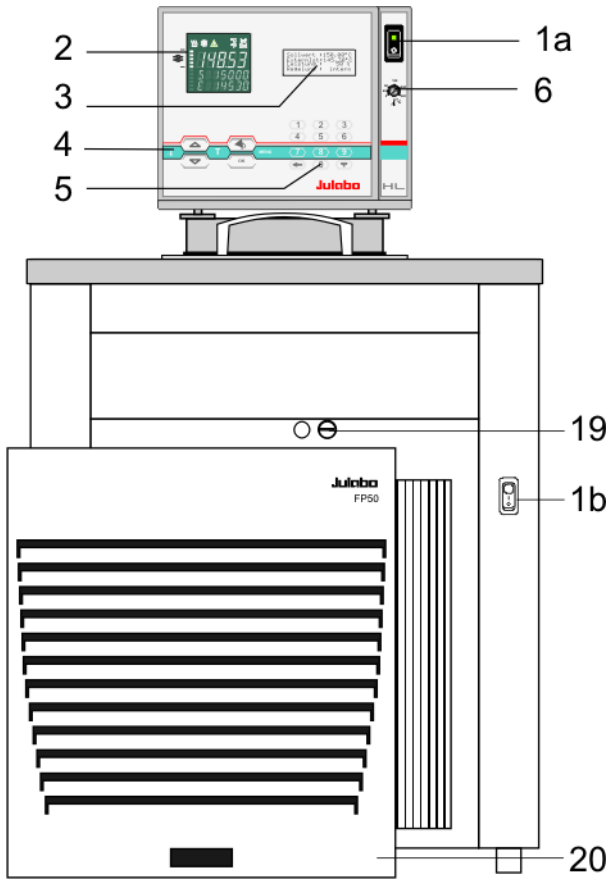

### 4. Operating controls and functional elements

Front view

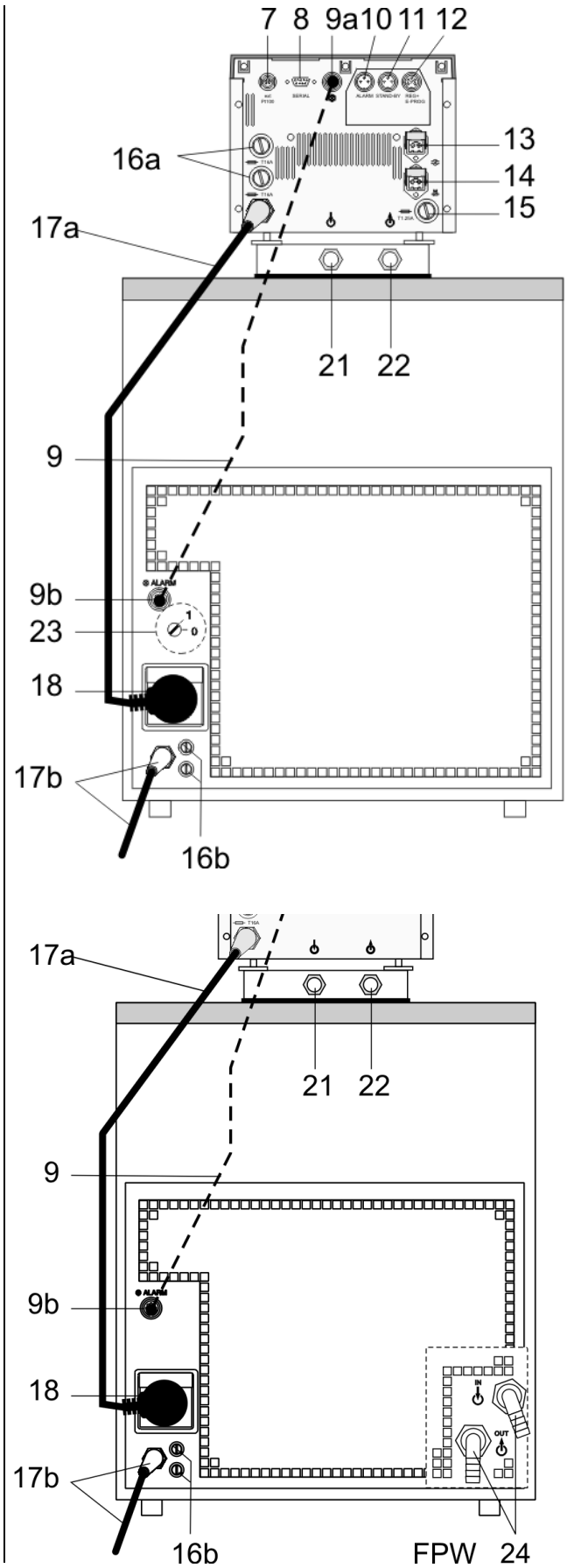

Rear view



- 1a  Mains power switch, illuminated for circulator
- 1b  Mains power switch, illuminated for cooling machine

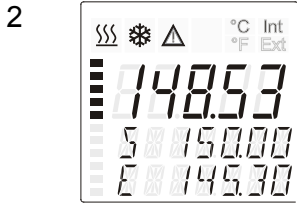

**VFD COMFORT-DISPLAY**

Header: Control indicators

Line 1: Actual value internal or external  
 The display is depending on the selected control mode in the menu > Control < (internal or external).

Line 2: Working temp. setpoint, constantly S xxx.xx

Line 3: Actual value (E = external or I = internal)  
 Alternating with the display in line 1

- Use the keys  to indicate further values in line 3
- PI Capacity in % - with manipulated variable set to >control<\*
- PS Capacity in % - with manipulated variable set to >serial<\* or >eprog<\*
- H Heater capacity in Watts
- U Mains voltage Volts
- F Flow rate in liters/minute  
 (providing EPROG input set to >Flow rate<)

\*refer to >MENU / CONFIGIGURATIO> page 36

- 2.1  Control indicators in the header:  
 Heating / Cooling / Alarm /  
**R**emote control

- 2.2  Control indicators in the header:  
 Temperature indication **I**nternal or **E**xternal actual value  
 Temperature indication in **°C** or **°F**

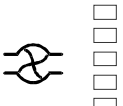
- 2.3  Display for the adjusted pump pressure stage in the -OFF- mode.  
 Display for the effective pump pressure stage (rotation speed) after start.  
 Four stages, adjustable via the **MENU** button, in the menu >PUMP<.

**3 LCD DIALOG-DISPLAY**

Setpoint1:	150.00°C
IntIst :	148.53°C
Power :	80 %
Control :	intern

Line 1: Setpoint and origin of setpoint programming  
 (Key / RS232 or RS485 / ext. Pt100 / EProg)

RS232 :	150.00°C
ExtAct :	148.53°C
Power :	80 %
Control :	extern

Line 2: Actual value - internal or external,  
 identical to line 1 of the VFD-COMFORT-DISPLAY

Line 3: Heating capacity in %.

Line 4: Control type: internal / external

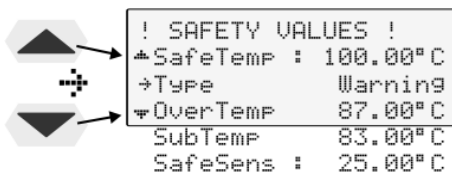

**Navigation aid in MENU - Window**

Keys / :  
 Selection of menu items / parameters  
 - Setting in line 3:  
 Actual value / parameter

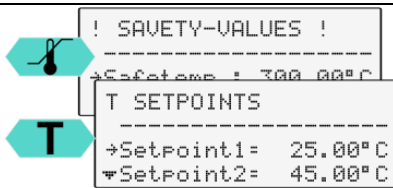

**Orientation aid in MENU - Window**

Line 1 - name with allocation to key  
 Safety values  
 T – Setpoint  
 MENU  
 1 Main menu Level 1  
 2 Submenu Level 2  
 Example: CONFIGURATION  
 3 Submenu Level 3

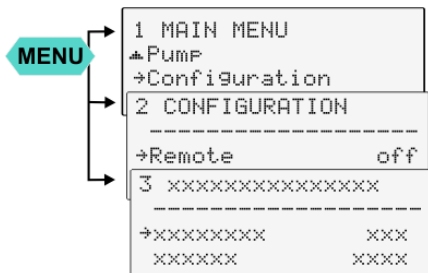

**4 Keypad 1 Navigation keys**

4.1 1. Key: >OK< Start / Stop (pump / heater )  
 2. >OK< in the menu Menu item / select submenu for setting  
 Save set value  
 Save selected parameter  
 A beep signals the end of setting



After the actions Start, Stop and change from VFD Display to standard display the key is locked for a short time.  
 The above graph “front side” shows an example for standard display.

4.2 1. Key: >Return< Stop (pump / heater)  
 Special display on VFD Display leave line 3.  
 2. >Return< in the menu one menu level down  
 Correction function for parameters or values (prior to OK)



immediately back to standard display



- icon for „keep key pressed down“.



4.3 /   
 1. Key: >Up / Down <temperature – increase/decrease setpoint  
 Push key quickly for single steps,  
 Keep key pressed for fast change.  
 2. >Up/Down< in the menu selection of menu items / parameters

**Menu keys**

4.4 Key: start the menu > warning and safety values<

4.5 Key: start the menu >temperature setpoints<





4.6 Key: display of MENU structure

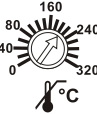

5	Keypad 2	
		Numeric keypad: numerals 0 to 9
		minus / decimal point
		Backspace key on LCD DIALOG-DISPLAY.





Setpoint1: 155 °C 

6		Adjustable excess temperature protection according to IEC 61010-2-010
---	---	---

Rear view

7	 ext Pt100	Socket for external measurement and control sensor or external setpoint programming
8	 SERIAL	Interface RS232 / RS485: remote control via personal computer
9		Control cable of JULABO refrigerated circulator
9a		Socket: output for alarm messages
9b		Socket:

Option: Electronic module		Order No. 8 900 100
The circulator automatically recognizes the connected electronic module.		
10	 ALARM	Alarm output (for external alarm signal)
11	 STAND-BY	Standby input (for external emergency switch-off)
12	 REG+E-PROG	Programmer input and temperature recorder output

13		Connector for supplementary pump or solenoid valve 230 V / max. 1.25 A No control voltage in the <b>-OFF-</b> condition
14		Connector solenoid valve 1. No control voltage in the <b>-OFF-</b> condition 2. Configurable (Refer to page 69)
15		Fuses (for connectors 13, 14), T1.25A
16		Mains fuses, T16A

- 17a Mains power cable with plug for circulator
- 17b Mains power cable with plug cooling machine



18  Built-in mains outlet for connection of circulator (230 V / 16 A)

19  Drain screw with drain connection

20 Venting grid, removable

21 Pump connections  suction pump  pressure pump

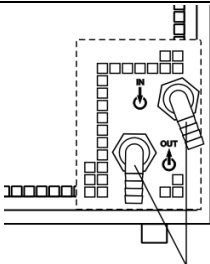
23  Selector dial for cooling machine (only F25)  
Position "1" for operation with HL circulator.

24  **OUT IN**  
   
Cooling water OUTLET and INLET.  $\frac{3}{4}$ "  
FPW 24

## 5. Preparations

### 5.1. Installation

- Place the unit on an even surface on a pad made of **non-flammable** material.
- Cooling machine, pump motor and electronics produce intrinsic heat that is dissipated via the venting openings! Never cover these openings!
- Keep at least 20 cm of open space on the front and rear venting grids.
- The place of installation should be large enough and provide sufficient air ventilation to ensure the room does not warm up excessively because of the heat the instrument rejects to the environment. (Max. permissible ambient temperature: 40 °C).  
For a fault (leakage) in the refrigeration system, the standard EN 378 prescribes a certain room space to be available for each kg of refrigerant.  
The refrigerant quantity is specified on the type plate.  
> > For 0.25 kg of refrigerant R134a, a room space of 1 m<sup>3</sup> is required.  
> For 0.52 kg of refrigerant R404A, a room space of 1 m<sup>3</sup> is required.  
> For 0.49 kg of refrigerant R507, a room space of 1 m<sup>3</sup> is required.
- Do not set up the unit in the immediate vicinity of heat sources and do not expose to sun light
- Before operating the unit after transport, wait about one hour after setting it up. This will allow any oil that has accumulated laterally during transport to flow back down thus ensuring maximum cooling performance of the compressor.
- Set selector dial for cooling machine (23) in position "1" for operation with HL circulator.  (only F25, factory setting)

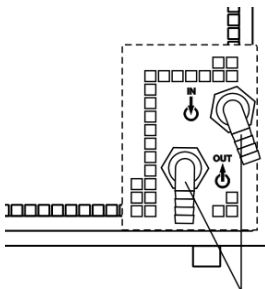

FPW 24

Only water cooled models:

Ensure circulation of cooling water by connecting the tubing to cooling water inlet and outlet on the rear of the refrigerated circulator.

- Cooling water connector 3/4"
- Cooling water see page 13

### 5.2. Bath fluids



**Caution:**

Carefully read the safety data sheet of the bath fluid used, particularly with regard to the fire point!  
If a bath fluid with a fire point of ≤65 °C is used, only supervised operation is possible.

**Water:** The quality of water depends on local conditions.

- Due to the high concentration of lime, hard water is not suitable for temperature control because it leads to calcification in the bath.

- Ferrous water can cause corrosion - even on stainless steel.
- Chloric water can cause pitting corrosion.
- Distilled and deionized water is unsuitable. Their special properties cause corrosion in the bath, even in stainless steel.

### Recommended bath fluids:

Bath fluid	Temperature range
soft/decalcified water	5 °C to 80 °C
mixture water/glycol, mixture 1:1	-20°C to 50°C

### JULABO bath fluids

JULABO Description		Thermal G	Thermal HY	Thermal H5
Order Number	10 liters	8 940 124	8 940 104	8 940 106
	5 liters	8 940 125	8 940 105	8 940 107
Temperature range	°C	-30 ... 80	-80 ... 55	-50 ... 105
Flash point	°C	--	78	124
Fire point	°C	--	80	142
Color		light yellow	clear	clear

JULABO Description		Thermal H10	Thermal H20S
Order Number	10 liters	8 940 114	8 940 108
	5 liters	8 940 115	8 940 109
Temperature range	°C	-20 ... 180	0 ... 220
Flash point	°C	190	230
Fire point	°C	216	274
Color		clear	light brown



See website for list of recommended bath fluids.

ATTENTION: The maximum permissible viscosity is 70 mm<sup>2</sup> /s.



#### Caution:

#### Fire or other dangers when using bath fluids that are not recommended:

Use only non-acidic and non-corroding bath fluids.

JULABO assumes no liability for damage caused by the selection of an unsuitable bath liquid.

Unsuitable bath fluids are fluids which, e.g.,

- are highly viscous  
(much higher than recommended at the respective working temperature)
- have a low viscosity and have creep characteristics
- have corrosive characteristics or
- tend to crack.
- **No liability for use of other bath fluids!**

### 5.3. Temperature application to external systems



**Caution:** Securely attach all tubing to prevent slipping.

If the circulator is operated without external system, close the pump connector (22) with the cap nut.

#### Temperature application to external, closed systems

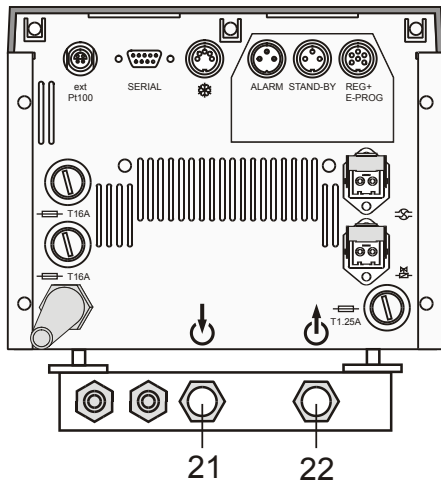

The circulator is used for temperature application to external, closed systems (loop circuit) with simultaneous temperature application in the circulator bath.

- Unscrew the M16x1 collar nuts on the pump connectors with a 19 mm (3/4") wrench and remove the sealing disks. Using the collar nuts, screw on the tubing connection fittings (for tubing 8 mm or 12 mm in diameter) delivered with the unit and tighten firmly. (Pressure pump: 22, suction pump: 21)
- Push on the tubing, and secure with tube clamps.
- Attach the tubing to the connectors of the external closed system, e.g., an instrument with a pressure-resistant temperature jacket or a temperature coil, and fasten with tube clamps to prevent slipping.

#### Temperature application to external, open systems

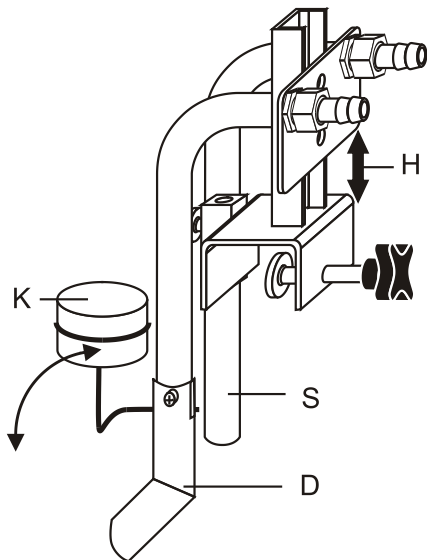

S = Suction pump connection  
 D = Pressure pump connection  
 K = Float  
 H = Height adjustment

The circulator is equipped with both a pressure and suction pump for external temperature application in open systems.

Differing flow rates of the pressure and suction pumps should be compensated. To maintain a constant liquid level, the JULABO „D+S“ Level Adapter is recommended for the external bath tank. The flow rate of the pressure pump will be then regulated by a built-in float device. The liquid level may be changed by a height adjustment on the „D+S“ Level Adapter.

Accessory: „D+S“ Level Adapter      Order No. 8 970 410

**Important:**

- ⓘ The liquid level should be equal in the internal and external baths (absolute height).
- ⓘ If you take out samples (for example Erlenmeyer flasks) from the external bath, turn the circulator off with the Start/Stop key.



### Backflow safety device

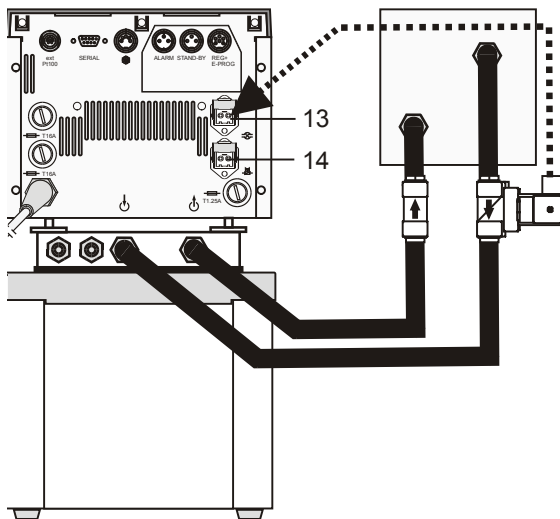

```

2 INPUTS/OUTPUTS
-----
→SV-OUT      Backflow
▼Chan1      | ActInt
  
```

(see page 69)

If the liquid levels in the circulator bath and the external system are at different heights, overflowing must be prevented after the power has been turned off.



#### Flood hazard!

For this reason, solenoid valves for loop circuit or shut-off valves can be integrated in the loop circuit.

① Connect the valve to the connector (13).

① If socket (14) is used:  
In menu >Inputs/Outputs< set the menu item >SV-Out< to >Backflow<.

Order No.	Description
8 980 701	Set of solenoid valves for loop circuit up to +100 °C
8 970 456	Shut-off valve (suitable up to +90 °C)
8 970 457	Shut-off valve (suitable up to +200 °C)

### 5.3.1. Tubing

#### Recommended tubing:

Order No.	Length		Temperature range
8930008	1 m	CR <sup>®</sup> tubing 8 mm inner dia.	-20 °C to 120 °C
8930012	1 m	CR <sup>®</sup> tubing 12 mm inner dia.	-20 °C to 120 °C
8930108	1 m	Viton tubing 8 mm inner dia.	-35 °C to 200 °C
8930112	1 m	Viton tubing 12 mm inner dia.	-35 °C to 200 °C
8930410	1 m	Insulation for tubing 8 mm inner dia.	-50 °C to 100 °C
8930412	1 m	Insulation for tubing 12 mm inner dia.	-50 °C to 100 °C
8 930 209	0.5 m	Metal tubing, triple insulated, M16x1	-100 °C to +350 °C
8 930 210	1.0 m		
8 930 211	1.5 m		
8 930 214	3.0 m		
8 930 220	0.5 m	Metal tubing, insulated, M16x1	-50 °C to +200 °C
8 930 221	1.0 m		
8 930 222	1.5 m		
8 930 223	3.0 m		



#### Warning:

Tubing:

At high working temperatures the tubing used for temperature application and cooling water supply represents a danger source.

A damaged tubing line may cause hot bath fluid to be pumped out within a short time. This may result in:

- Burning of skin
- Difficulties in breathing due to hot atmosphere

**Safety recommendations**

- Employ suitable connecting tubing.
- Make sure that the tubing is securely attached.
- Avoid sharp bends in the tubing, and maintain a sufficient distance from surrounding walls.
- Regularly check the tubing for material defects (e.g. for cracks).
- Preventive maintenance: Replace the tubing from time to time.

**5.4. Filling / draining**



**Notice:**

- Pay attention to the thermal expansion of bath oil during heating to avoid overflowing of the liquid.
- Do not drain the bath fluid while it is hot!  
Recommendation: Temperature range 5 °C to 40 °C  
Check the temperature of the bath fluid prior to draining (by switching the unit on for a short moment, for example).
- Store and dispose the used bath fluid according to the laws for environmental protection.

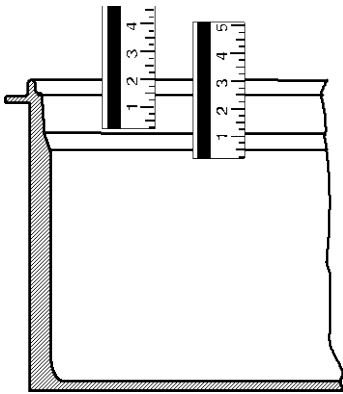

**Filling**

Take care that no liquid enters the interior of the circulator.

- Recommended maximum filling level with water as bath fluid: 30 mm below the tank rim
  - Recommended maximum filling level with bath oils: 40 mm below the tank rim
- i** After filling, immerse the samples in the bath or place the lid on the bath, in case the opening is not to be used.
- i** The circulator provides an early warning system for low level (description – please refer to page 33) that may be triggered when changing samples in the bath.

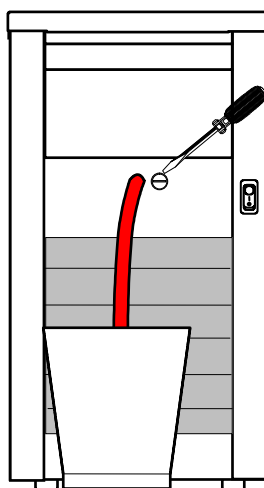
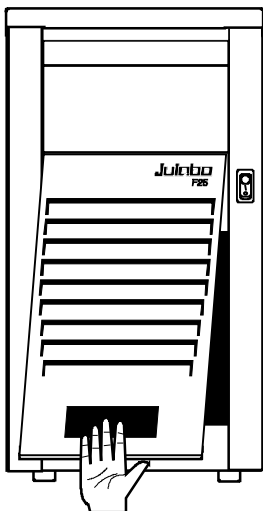

**Draining:**

- Turn off the unit and disconnect the mains cable from the power source.
- Hold the venting grid, pull out and remove.
- Slide a short piece of tube onto the drain connection and hold it into a container.
- Loosen the drain screw a few turns and drain the unit completely.
- Tighten the drain tap.

## 6. Operating procedures

### 6.1. Power connection



#### Caution:

- Only connect the unit to a power socket with earthing contact (PE – protective earth)!
- The power supply plug serves as safe disconnecting device from the line and must be always easily accessible.
- Never operate equipment with damaged mains power cables.
- Regularly check the mains power cables for material defects (e.g. for cracks).
- We disclaim all liability for damage caused by incorrect line voltages!

Check to make sure that the line voltage matches the supply voltage specified on the identification plate.

- Connect the circulator with mains power cable (17a) to the mains outlet (18).
- Connect the control cable (9) to the ⚡ sockets (9a, 9b).
- Connect the refrigerated circulator with mains power cable (17b) to the mains socket.

### 6.2. Switching on / Selecting the language

#### 6.2.1. Switching on the circulator

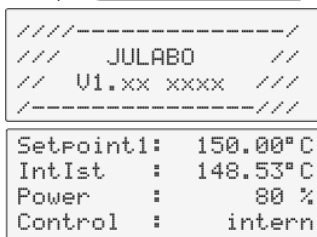
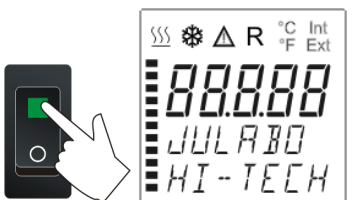

#### Switching on:

- Turn on the mains power switch (1a).
- ❗ The unit performs a self-test. Then the software version (example: V 1.xx-xxxx) appears. The display „OFF“ or „R OFF“ indicates the unit is ready to operate.
- ❗ The circulator enters the operating mode activated before switching the circulator off:  
**keypad control mode** (manual operation) or  
**remote control mode** (operation via personal computer).

#### Selecting the language:

There are two options for the language of the LCD DIALOG-DISPLAY: German or English. Select the desired language in the menu >Configuration< under the submenu >Language/Sprache<.

Press the respective keys in the following order:

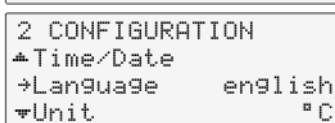
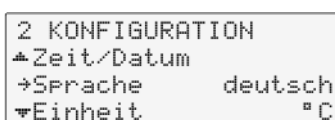
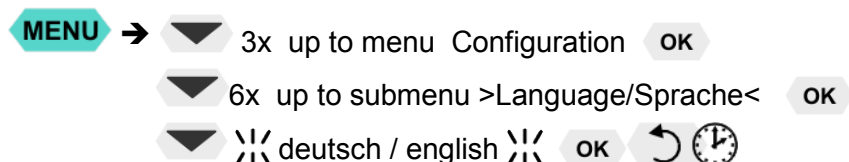

### 6.2.2. Switching on the cooling machine



Switching on:

- Switch on the cooling machine using the switch (1b) .

#### **i** Control of the cooling machine:

With the mains switch (1b) turned on, the circulator automatically switches the cooling machine off and on.

- It is switched off if:
  - the current working temperature is increased by  $> 30\text{ }^{\circ}\text{C}$  (cooling is not required).
  - the heater operates at full power ( $> 800\text{ W}$ ) for longer than 5 minutes.
- It is switched on if:
  - cooling is necessary to maintain the bath temperature.After switch-off, the cooling machine automatically switches on only after a delay of 5 minutes to protect the cooling compressor.

- i** To save energy, turn off the cooling machine with the mains switch (1b) whenever cooling is not required.

### 6.3. Start - Stop



**Start:**

- Press **OK** key.  
The actual bath temperature is displayed on the VFD COMFORT-DISPLAY. The circulating pump starts with a slight delay.

**Stop:**

- Press **OK** key.  
or  
Keep  key pressed.

The VFD COMFORT-DISPLAY indicates the message "OFF".





## 7. Setting of temperatures

Press the  key to call up the menu for temperature selection.

3 different working temperatures can be adjusted. Their values are freely selectable within the operating temperature range.

 The temperatures can be set in start or stop mode.

### Setting of working temperature in the menu

1. Press the key . The value flashes .
2. Select SETPOINT 1 or 2 or 3 using the key  or .
3. Confirm by pressing the  key.

 The circulator uses the new working temperature value for temperature control.

Factory settings:

```
T SETPOINTS
-----
+Setpoint1 = 25.00°C
▽Setpoint2 = 37.00°C
Setpoint3 = 70.00°C
```

```
Setpoint3: 70.00°C
ActIst   : 24.64°C
Power    : 80 %
Control  : internal
```



```
Setpoint3: 85.00°C
ActIst   : 24.64°C
Power    : 80 %
Control  : internal
```

### Example:

#### Adjustment/modification of the pre-setting of "SETPOINT 3"

 If the active Setpoint is changed, the new value is immediately used for the control of the working temperature.  
The heater control indicator flashes.

Setpoint3: Change the value from 70.00°C to 80.00°C.  
See standard display line 1

- Use the numeric keypad to enter  and .
- Then press enter  to store the value.



Notice: Refer to SETPOINT MAX / MIN in chapter „LIMITS“

## 8. Safety installations, warning functions



Check the safety installations at least twice a year! Refer to page 16.

Settings for the excess temperature protection > SafeTemp< and for the warning functions > OverTemp< and > SubTemp< are made in a menu which is called up by pressing the key .

Menu item > Type< allows choosing between a warning and an alarm cut-off for the menu items > OverTemp< and > SubTemp<.



**Warning:**



Adjust excess-temperature safety device below the flash point of the bath fluid.  
 In case of wrong setting there is a fire hazard!  
 We disclaim all liability for damage caused by wrong settings!

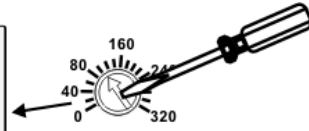
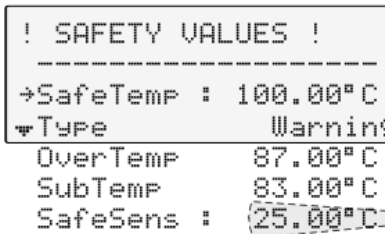

**SafeTemp:**

Setting range: 20 °C ... 320 °C

ⓘ Rough setting can be effected by using the temperature scale.

**Settings:**

- Press the key and by pressing the key or select the menu item and confirm the by pressing the key .

**For setting proceed as follows.**

**SafeTemp:**

- Set the new cut-out value within 30 seconds with a screw driver.  
 Exact display and setting on LCD display  
 Recommendation:  
 Set over temperature-protective setting >SafeTemp< 5 °C to 10 °C above the set point of the working temperature.

**Type:**

Switch-over from warning to shutdown function

- Change the parameter by pressing the key and confirm by pressing the key .
- or  
 pressing the key if the parameter is to be retained.

Possible parameters: **warning or alarm**

**OverTemp :**

- Set value on numeric keypad and confirm by pressing

**SubTemp:**

Example: 83.00 °C

Press the keys and and confirm by pressing



**SafeSens:**

Indicated is the temperature value of the safety sensor.

**SafeTemperature:**

Setting range: 20 °C ... 320 °C

Indicated is the cut-out value set with a screwdriver on the excess temperature protection device.

This safety installation is independent of the control circuit. When the temperature of the bath fluid has reached the safety temperature, a complete shutdown of the heater and pump is effected.

The alarm is indicated by optical and audible signals (continuous tone).  
 The following error message appears on the VFD COMFORT-DISPLAY:

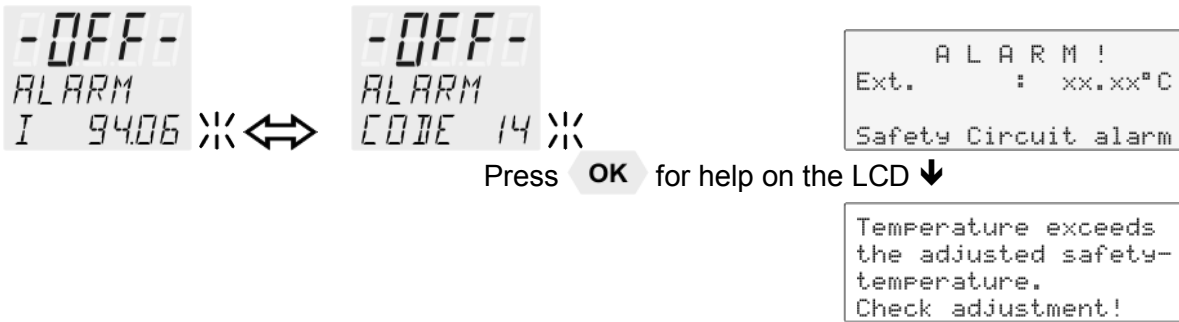

- ① Depending on the setting of >ControlType - internal or external< the actual temperature values for both sensors are shown/indicated on both displays.

Examples: I 94.06 and Ext. : xx.xx°C

**Type:** >Warning< or >Alarm<

For the two menu items >OverTemp< and >SubTemp< choose between a warning message being signaled or a complete shutdown of the main functional elements such as heater and circulating pump being effected.

**OverTemperature:** **SubTemperature:**

If for a sensitive temperature application task adherence to a working temperature value >Setpoint< is to be supervised, then set high and low temperature warning values.

In the example below, the >Setpoint< of 85 °C is surrounded by the values >OverTemp< 87 °C and >SubTemp< 83 °C. The electronics immediately registers when the actual temperature attains a temperature out of the limits and it follows a reaction according to what is set in the menu item >-Type<.

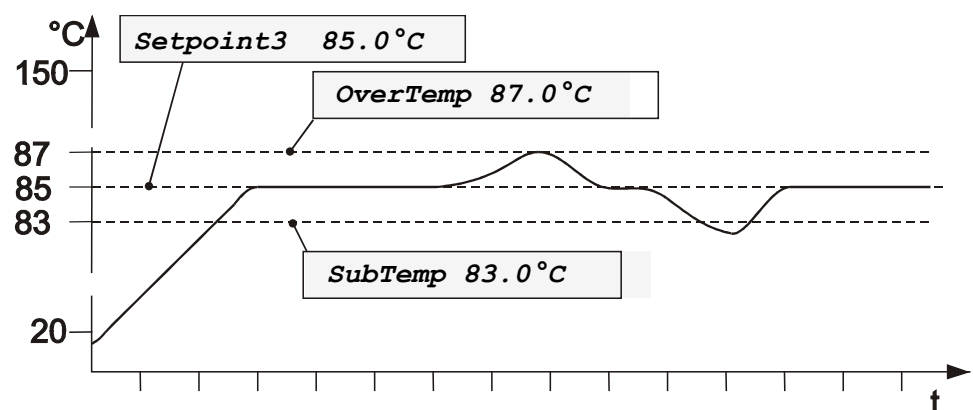

- ① The warning functions are only triggered when the actual bath temperature, after start from the „OFF“ or „rOFF“ mode, lies within the set limits for 3 seconds.

- Setting **>WARNING<**

A mere warning function with optical and audible warning signal (interval tone) A message appears on the VFD COMFORT-DISPLAY:



```

    88888
    WARNING
    CODE 03 or
    OverTemp
    
```

```

    88888
    WARNING
    CODE 04
    SubTemp
    
```

The LCD -DISPLAY shows the message:

```

    Setpoint1: 150.00°C
    IntAct   : 148.53°C
    excess temperature!
    -check limits-
    
```

```

    Setpoint1: 150.00°C
    IntAct   : 148.53°C
    low temperature!
    -check limits -
    
```

- Setting **>ALARM<**

Temperature limit with shutdown of heater and circulating pump. An audible alarm sounds (continuous tone) and a message appears on the VFD COMFORT-DISPLAY:



```

    -OFF-
    ALARM
    CODE 03 or
    OverTemp
    
```

```

    -OFF-
    ALARM
    CODE 04
    SubTemp
    
```

The LCD -DISPLAY shows the message

```

    A L A R M !
    Ext.      : xx.xx°C
    Excess Temperature
    
```

```

    A L A R M !
    Ext.      : xx.xx°C
    Low Temperature!
    
```

Press **OK** for help on the LCD

```

    Actual temperature
    above high tempera-
    ture value.
    Check limits!
    
```

```

    Actual temperature
    below low tempera-
    ture value.
    Check limits!
    
```



**8.0.1. Early warning system, low level protection**

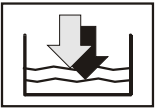

**DBGM: 20306059.8**

This low level protection is independent of the control circuit and is divided into two sections:

1. Switch in stage 1 recognizes a critical fluid level 😊.

An audible warning (interval tone) sounds and a message appears on the VFD COMFORT-DISPLAY.

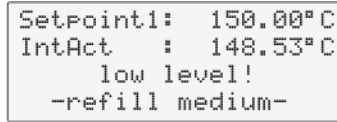

Refill bath fluid!

2. Switch in stage 2 recognizes a low fluid level ☹️.

If stage 2 of the low level protection device (according to IEC 61010-2-010) is triggered, a complete shutdown of the heater and circulating pump is effected.

A continuous alarm tone sounds and a message >ALARM< >CODE 01< appears on the VFD COMFORT-DISPLAY.



Press **OK** for help on the LCD ↓

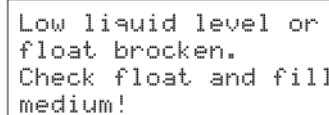

Turn off the unit with the mains switch, refill bath fluid and turn the unit on again!

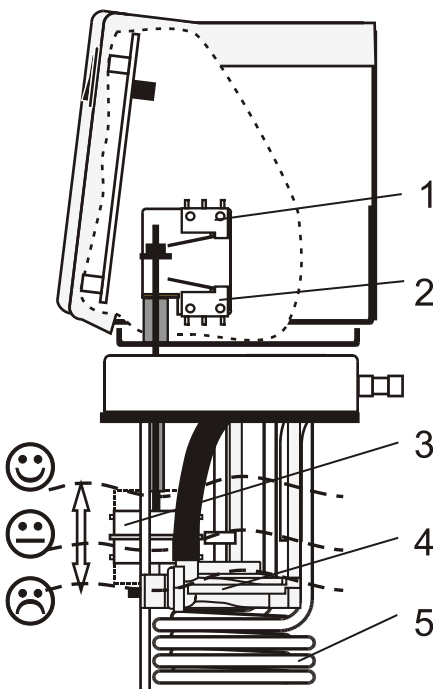

3. Float
4. Circulating pump
5. Heater



**Warning:**

For refill always use the same bath fluid type that is already in the bath. Bath oils must not contain any water contaminants and should be pre-heated to the actual bath temperature! Explosion hazard at higher temperatures!

## 9. MENU Menu functions



The term „menu functions“ refers to adjustments such as



```

1 MAIN MENU
-----
→Start Program
▼Manage Programs
  Pump
  Configuration
  Control
  Interface serial
  ATCalibration
  Limits
  Inputs/Outputs
-----
    
```

### Menu level 1

<pre> 1 MAIN MENU ----- →Start Program ▼Manage Programs     </pre>	<p>Start program <span style="float: right;">Page 36</span></p> <p>This menu will start a previously set program.</p>
<pre> 1 MAIN MENU →Start Program →Manage Programs ▼Pump     </pre>	<p>Administration and creation of programs <span style="float: right;">Page 41</span></p>
<pre> 1 MAIN MENU ▲Manage Programs →Pump ▼Configuration     </pre>	<p>Electronically adjustable pump capacity <span style="float: right;">Page 45</span></p> <p>The capacity of the circulating pump is set by adjusting the motor speed.</p>
<pre> 1 MAIN MENU ▲Pump →Configuration ▼Control     </pre>	<p>Configuration of the unit <span style="float: right;">Page 46</span></p> <ul style="list-style-type: none"> <li>Remote – on / off (remote control via RS232)</li> <li>Setpoint ext - Switch over external setpoint setting</li> <li>Autostart – AUTOSTART on / off</li> <li>Off-Mode – Pump on / off</li> <li>ACTVAR - Switch over input variable</li> <li>Time / Date – setting time and date</li> <li>Language – english / deutsch</li> <li>Unit – Temperature values can be displayed in °C or °F.</li> <li>Program Type – Time or Gradient (grad)</li> <li>Reset – factory settings</li> </ul>
<pre> 1 MAIN MENU ▲Configuration →Control ▼Interface serial     </pre>	<p>Control characteristics and parameters <span style="float: right;">Page 53</span></p> <ul style="list-style-type: none"> <li>ControlType - Control internal or external</li> <li>Selftuning</li> <li>Dynamic - internal</li> <li>CoSpeed – external</li> <li>Control parameters - XP-, TN-, TV- internal</li> <li>Control parameters - XP-, TN-, TV- XPU-, external</li> </ul>

Menu level 1

<pre> 1 MAIN MENU +Control +Interface serial +ATCalibration         </pre> 	<p>Adjustable interface parameters BAUDRATE, PARITY, HANDSHAKE</p>	<p>Page 59</p>
<pre> 1 MAIN MENU +Interface serial +ATCalibration +Limits         </pre> 	<p>ATC - Absolute Temperature Calibration, Sensor calibration internal sensor, Sensor calibration external sensor 3-point calibration</p>	<p>Page 60</p>
<pre> 1 MAIN MENU +ATCalibration +Limits +Inputs/Outputs         </pre> 	<p>Limitations of temperature and capacity Setpoint Max / Min - Maximum and minimum setpoint Heating Max – Set maximum heating Cooling Max – Set maximum cooling Internal Max / Min – Limitation of the temperature range Upper band / Lower band – Band limit</p>	<p>Page 67</p>
<pre> 1 MAIN MENU +Limits +Inputs/Outputs -----         </pre>	<p>Analog inputs/outputs Recorder output – CHANNEL 1, 2, 3 EPROG – External programmer input Ext-StBy - Stand-By input ALARM - output</p>	<p>Page 69</p>

### 9.1. Start of a program

```

2 START PROGRAM
-----
->Program Number  0
▼at Step         0
Runs             1
Program End      StdBy
Run              now
-----
    
```

The start menu of the integrated programmer allows one of six previously stored temperature programs to be called up and started. The profiles are started manually or via the integrated timer.

**① Requirements:**

1. Create a program. (refer to next chapter)
2. Return to the Start-MENU and confirm the desired setting of each MENU item with the key **OK**
3. Set a start time (>TIME< >DATE< >YEAR<) if the program is to be started by the internal timer.

>Program Number< Select the program that should be started.  
0 ... 5

> at Step< Select the Step at which the program should be started. 0 ... 59

> Runs < Select the number of program repetitions. 1 ... 99

> Program End< Status at program end .  
StdBy, PSetp, Setp 1, Setp 2, Setp 3

> RUN < Start time (now / time)









**MENU** ↓

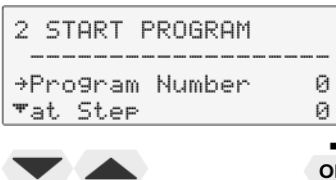



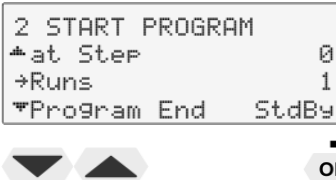

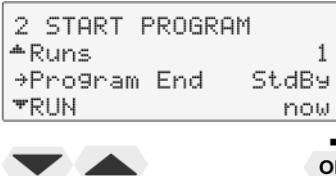
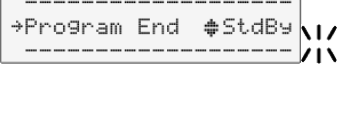

```

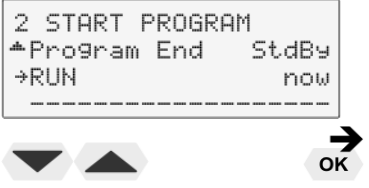
1 MAIN MENU
-----
->Start Program
▼Manage Programs
    
```

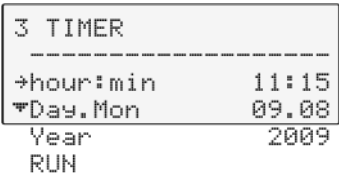
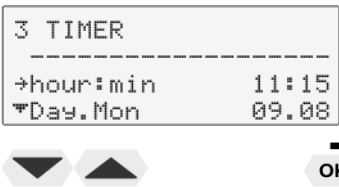
**OK** ↓

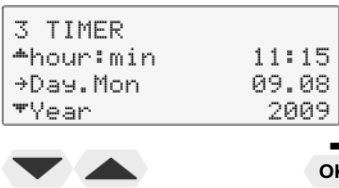
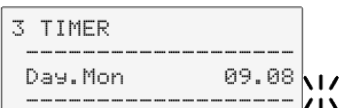
**①** Press the  key if a parameter is to be retained. (prior to OK)

Level 2	Parameter /Value	
		<ul style="list-style-type: none"> <li>Set a parameter using the numeric keypad and confirm by pressing <b>OK</b> .</li> </ul> Possible parameters: 0 ...5
		<ul style="list-style-type: none"> <li>Set a parameter using the numeric keypad and confirm by pressing <b>OK</b> .</li> </ul> Possible parameters: 0 ... 59
		<ul style="list-style-type: none"> <li>Set a parameter using the numeric keypad and confirm by pressing <b>OK</b> .</li> </ul> Possible parameters: 1 ... 99
		<ul style="list-style-type: none"> <li>Set desired parameters with   and <b>OK</b> .</li> </ul> Possible parameters: StdBy , PSetp, Setp 1, Setp 2 , Setp 3

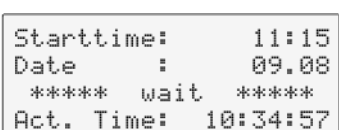
Level 2	Parameter /Value	
	 <p>or</p> 	<ul style="list-style-type: none"> <li>Set desired parameters with   and  .</li> </ul> <p>Confirm &gt;now&lt; with the  key and the program will start immediately  <b>or</b>  start at the set time under parameter (time ).  Set time in the example below:  09. August 2009, 11:15 hrs</p>
<p>Submenu TIMER</p> 		<p>If the parameter <b>time</b> is selected, a further submenu opens for setting the start time.</p> <p>Set the time for the start of the program in the submenu &gt;3 TIMER&lt;.</p>
		<ul style="list-style-type: none"> <li>Set starting time using the numeric keypad and confirm by pressing  .</li> </ul> <p>Example: (hh:mm)  </p>
		<ul style="list-style-type: none"> <li>Set day and month using the numeric keypad and confirm by pressing  .</li> </ul> <p>Example: (TT/MM)  </p>
		<ul style="list-style-type: none"> <li>Set year using the numeric keypad and confirm by pressing  .</li> </ul> <p>Example: (JJJJ)  </p>
		<p>Confirm &gt;Starten/Start?&lt; by pressing  and the program starts at the set time.</p>
	<p>Display of waiting time until start:  The unit switches to waiting mode and a flashing line “wait” appears on the LCD DIALOG-DISPLAY. The start time and current time are permanently indicated on the display.</p> <p>It might be necessary to check the correct setting of the internal real time clock  (see MENU configuration)</p>	

9.1.1. Status at the end of a program



```
Setpoint3: 80.00°C
IntAct : 80.00°C
Power : 3 %
Control : internal
```

```
T SETPOINTS
+Setpoint1 = 25.00°C
→Setpoint2 = 58.00°C
↵Setpoint3 = 85.00°C
```

```
Setpoint2: 58.00°C
IntAct : 60.00°C
Power : 0 %
Control : intern
```



**Program end StdBy , PSetp, Setp 1, Setp 2 , Setp 3**

This parameter is used to determine if the unit switches to the -OFF- condition at the end of a profile or if temperature control is continued, and the working temperature setpoint that is to be used if temperature control is continued.

**StdBy** – If the end of the profile is reached, the circulator switches to the -OFF- condition. The VFD display indicates the working temperature setpoint that was displayed in line 2 before the program was started (example: S 25.00 °C ).

**PSetp** –(Setpoint of the ProGrammer) At the end of the program, the setpoint of the last program step is written to the position of setpoint 3 (example: 80.00 °C) and indicated in line 1 of the LCD display. The circulator operates and controls to this temperature until the key **OK** is pressed or a new profile is started.

**Setp 1, Setp 2, Setp 3** – (“Setp” short for **Setpoint**)

Before starting the programmer, a temperature value is set for one of the three setpoints in the **T** menu.

(example: setpoint 2 58.00 °C)

The circulator operates and controls to this temperature at the end of the profile until the key **OK** is pressed or a new program is started.

9.1.2. Indication after successful start

The started programmer displays the currently calculated setpoint in line 1. The value changes until the final temperature of the section is reached (temperature ramp).

1<sup>st</sup> line: Setpoint of the programmer

2<sup>nd</sup> line: Actual temperature value  
 for **internal control** = IntAct: xxx.xx  
 for **external control** = ExtAct: xxx.xx

3<sup>rd</sup> line: Selected profile and the current section (step).

4<sup>th</sup> line: With the **▼▲** keys, the following information can be displayed in line 4.

- Remaining time of the current section (standard display)
- Total remaining time: profile x number of repetitions  
**(All: Days/hours:minutes:seconds)**

**Particularities :**

1. If a total time of more than 999 days is calculated, only the hours are displayed by the unit.  
**(All: hours:minutes:seconds)**
2. If the time period of a section is edited after the start, then the remaining total time can no longer be displayed.

Examples:

```
Set : XX.XX°C
IntAct : XX.XX°C
ProgNr.:2 Step: 2
Remain : 03:32:25
```

```
Set : XX.XX°C
IntAct : XX.XX°C
ProgNr.:2 Step: 2
All : ttt/hh:mm:ss
```

### 9.1.3. Editing after Start

The programmer allows a running program to be edited.

#### Initiation and exit of the editing function:

```
3 EDITOR >PrgNr.2
SP : ---,---C xxx.xx°C
TI : --,--% xx.xx%
ST : -- # 0
```

- After the start enter the submenu „3 EDITOR“.by pressing the key **MENU**  
See chapter „program administration, creation“ page 41
- Exit the editing modus anytime by pressing the key  .

#### Particularity for changes in a section that is currently in process.

- ① If the target temperature is changed, the slope of the ramp is automatically calculated based on the remaining time of the section.
- ① If the time period is changed, the slope of the ramp is automatically calculated based on the new total time of the section.
- ① The “remaining total time” (profile x number of repetitions) as described on page 38 can no longer be displayed.

### 9.1.4. Interrupting a program

```
Set : XX.XX°C
IntAct : XX.XX°C
ProgNr.:2 Step: 2
*** Pause ***
```

- ① Press the  key to interrupt or continue a profile.  
The setpoint and time period set for the corresponding section are thus stopped at the values presently achieved.  
The instrument is put on hold and the message “pause” flashes on the LCD DIALOG DISPLAY.

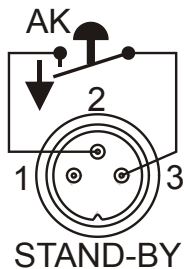

- ① A program can be interrupted or restarted by an external shut-off.

#### Important:

For this, in the >Inputs/Outputs< menu, the menu item >Ext. StBy< must be set to >active< and in the >Configuration< menu, >Autostart< needs to be set

```
Set : XX.XX°C
IntAct : XX.XX°C
ProgNr.:2 Step: 2
***** StandBy *****
```

- ① Setpoint control and timer are interrupted by breaking the contact “AK”.  
The instrument is put on hold and the message “Stand-By” flashes on the LCD DIALOG-DISPLAY.



**Notice: This is not an actual emergency switch-off.**



#### Warning:

Following a power interruption, it would be possible in this condition for the instrument to restart automatically. The safety and warning functions of the instrument should always be used to their fullest capacity.  
Refer to **Warning** page 50 .

**9.1.5. Interruption after a power failure**

It is possible to operate the programmer safely in case of a power failure.

**Important:**

For this, >Autostart< needs to be set in the >Configuration< menu.

- ❗ If the AUTOSTART function is activated, the programmer starts again at a point approx. 20 seconds before the interruption took place. However, an uncontrolled change of the bath temperature has occurred.
- ❗ Power failure when the instrument is on hold if start is effected via the built-in timer:  
 If the starting time is not yet reached, the programmer is put on hold again.  
 If the starting time is exceeded, the programmer starts immediately.

```
Starttime: 11:15
Date : 09.08
***** wait *****
Act. Time: 10:34:57
```

**9.1.6. Termination of a program**

```
Set : XX.XX°C
IntAct : XX.XX°C
ProgNr.:2 Step: 2
Remain : 03:32:25
```

- ❗ A program can be terminated by pressing . The programmer switches back to the Start menu.

Further procedures are defined in the MENU >START PROGRAM<, menu item >Program End <.

Example: >Program End - StdBy<

```
2 START PROGRAM
-----
+Program Number 0
▼at Step 0
Runs 1
Program End StdBy
Run now
-----
```

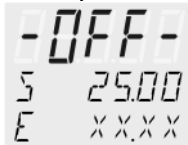

The VFD COMFORT-DISPLAY displays "OFF".

**Interruption after a power failure**

In case of a power failure, the reaction of the circulator is the same as when switched off and on again with the mains switch.

The VFD COMFORT-DISPLAY displays "OFF".



## 9.2. Program administration, creation

2 MANAGE PROGRAMS	
→Edit	PrgNr.
▼Delete	PrgNr.
Print	PrgNr.

The integrated programmer permits fast and easy programming of setpoint temperature sequences. This temperature sequence is called program. A program is composed of individual sections (Step). The sections are defined by duration (t) or Gradient (°/t) and target temperature. The target temperature is the setpoint (SP), which is achieved at the end of a section. The programmer calculates the temperature ramp from the difference in time and temperature.

### Create programs

A flashing segment indicates that a number needs to be entered. Under the submenu "Edit", enter a program number. Six programs may be stored (numbers 0 to 5).

When the program is running, only sections with complete information for the target temperature and time period are considered. It makes sense to skip section numbers in the profile in order to use them later for corrections to the profile.

### **Important:**

If a time of 00:00 is set for a profile, the profile is continued with the next section only after the setpoint temperature ( $\pm 0.2$  °C) is reached.

Example:

Step	(Nr.)	1	3	5	6	9	11	14
Setpoint	(°C)	50	50	100	100	80	80	20
Time	(h:m)	00:08	00:02	00:10	01:05	00:10	00:05	00:30

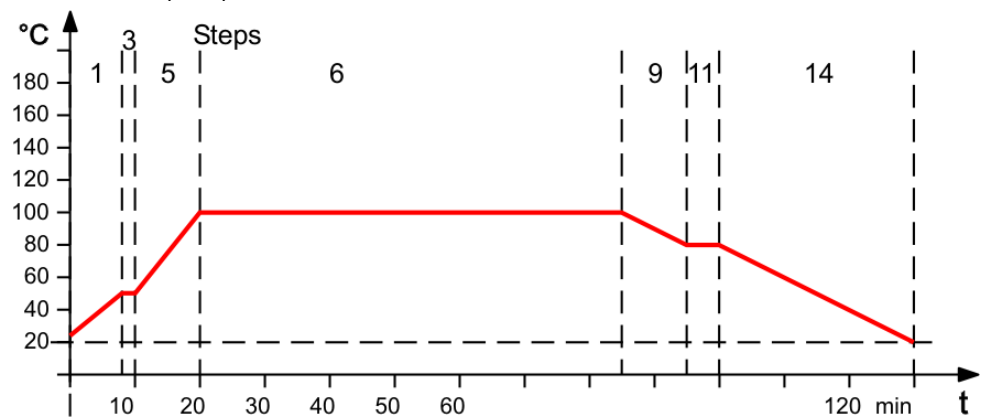

**Editing**

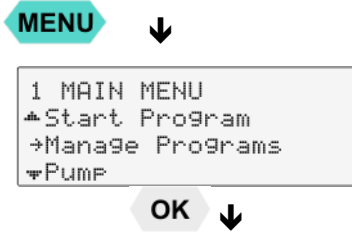

- PrgNr: Set the program you wish to create. 0 ... 5
- SP : Setpoint
- TI : Time [hh:mm] or
- GRD: Gradient [°/t] = [°/min]  
Change type of program in MENU >configuration<, menu item >Programmtyp/program type< .
- ST: Step 0 ... 59

**i** Press the key if a parameter is to be retained. (prior to OK)

<p>Level 2</p>	
<pre> 2 MANAGE PROGRAMS ----- +Edit          PrgNr. +Delete       PrgNr. Print         PrgNr. ----- OK     </pre>	<p>Example: Program (PrgNr.) 2 is to have a target temperature with a set point (SW) of 100.00 °C in section t (ABS) 3. Duration (ZI) 1 hour.</p>
<pre> 2 MANAGE PROGRAMS ----- Edit          # PrgNr.2 -----     </pre>	<p>Select the program number.</p> <ul style="list-style-type: none"> <li>• Set the desired &gt;PrgNr.&lt; by pressing   and  .</li> </ul>
<p>Level 3</p>	<p><b>i</b> For the selected section &gt;ST&lt; a setpoint &gt;SP&lt; and the duration &gt;TI&lt; or the gradient &gt;GRD&lt; are entered in the right half of the input window.</p>
<pre> 3 EDITOR &gt;PrgNr.2 SP : ---.---C 100.00C TI : --.---T 1.00T ST : 2 # 3     </pre> <p>or</p> <pre> 3 EDITOR &gt;PrgNr.2 SP : ---.---C ---.---C GRD: --.---% --.---% ST : -- # 0     </pre>	<p>Input window for &gt;ST&lt;, &gt;SP&lt; and &gt;TI&lt; / &gt;GRD&lt;</p> <ol style="list-style-type: none"> <li>1. Set the desired Step &gt;ST &lt; by pressing   and  .</li> <li>2. Set set point &gt;SP&lt; by using the numeric keypad and confirm by pressing  .</li> <li>3. Set the time &gt;TI&lt; or a gradient &gt;GRD&lt; using the numeric keypad and confirm by pressing  .</li> </ol>
<pre> 3 EDITOR &gt;PrgNr.2 SP : 100.00C ---.---C TI : 1.00T --.---T ST : 3 # 4     </pre>	<p><b>i</b> By confirming time or GRD the values on the left side of the input window are moved.</p> <ul style="list-style-type: none"> <li>• The values for the next section are entered in the right half of the input window. See above 1. / 2. / 3.</li> </ul>

### Delete









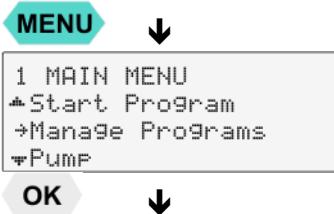





It is possible to delete an entire program or consecutive sections

Delete PrgNr:           Set the program you wish to delete  
                                  0 ... 5

Delete from Step X to Step X - (0 ... 59)

Press the  key if a parameter is to be retained. (prior to OK)



Level 2	Submenu >Delete<
<pre> 2 MANAGE PROGRAMS ▲Edit          PrgNr. →Delete       PrgNr. ▼Print        PrgNr.                 </pre>	<ul style="list-style-type: none"> <li>Set menu item &gt;Delete PrgNr.&lt; by pressing  and .</li> </ul>
<pre> 2 MANAGE PROGRAMS ----- Delete      ⌘ PrgNr.0                 </pre>	<ul style="list-style-type: none"> <li>Set desired PrgNr with ,  and .</li> </ul> <p>Example: PrgNr. 0</p>
Level 3	Input window: delete sections.
<pre> 3 DELETE  &gt;PrgNr. 0 ----- →from Step      0 ▼to Step       59 delete                 </pre>	<ul style="list-style-type: none"> <li>Select menu items &gt; ⌘ from Step&lt; and &gt; ⌘ to Step&lt; one after the other by pressing  and .</li> <li>Select the desired section for every menu item by using the numeric keypad and confirm by pressing .</li> </ul> <p>Example: &gt;from 0&lt; &gt;to 59&lt;</p>
<pre> 3 DELETE  &gt;PrgNr. 0 ----- from Step      0                 </pre>	<p></p>
<pre> 3 DELETE  &gt;PrgNr. 0 ----- to Step      59                 </pre>	<p></p>
<ul style="list-style-type: none"> <li>Select menu item &gt;delete&lt; by pressing  and .</li> </ul>	
<pre> 3 DELETE  &gt;PrgNr. 0 ----- delete?                 </pre>	<ul style="list-style-type: none"> <li>Confirm &gt;Delete?&lt; by pressing .</li> </ul> <p></p>
<pre> 3 DELETE  &gt;PrgNr. 0 ----- ! delete !                 </pre>	<p> The delete procedure is confirm by indication of the message &gt;delete&lt; on the LCD display.</p>

**MENU** ↓







```
1 MAIN MENU
↳Start Program
→Manage Programs
⇐PUMP
```

**OK** ↓

**Print**

Every program can be printed via the serial interface for control and documentation purposes.

ⓘ Press the  key if a parameter is to be retained. (prior to OK)

Level 2	Submenu >Print<
<pre>2 MANAGE PROGRAMS ↳Delete      PrgNr. →Print       PrgNr. -----</pre>	<ul style="list-style-type: none"> <li>Set menu item &gt;Print PrgNr.&lt; by pressing  and <b>OK</b>.</li> </ul>
<pre>2 MANAGE PROGRAMS ----- Print      ↳ PrgNr.4</pre> 	<ul style="list-style-type: none"> <li>Set desired &gt;PrgNr.&lt; by pressing   and <b>OK</b>.</li> </ul> <p>Example: 4</p>
Level 3	
<pre>3 PRINT      PrgNr.4 ----- →Print</pre>	<ul style="list-style-type: none"> <li>Confirm  &gt; Print&lt; by pressing <b>OK</b>.</li> </ul>
<pre>3 PRINT      PrgNr.4 ----- Print?</pre> 	<ul style="list-style-type: none"> <li>Confirm &gt;Print?&lt; by pressing <b>OK</b>.</li> </ul>
<pre>3 PRINT      PrgNr.4 ----- ! Print !</pre>	<p>ⓘ Printing and end of printing are confirmed by successive messages on the LCD display as shown on the left.</p>
<pre>3 PRINT      PrgNr.4 ----- done !</pre>	

### 9.3. Setting the pump pressure



**MENU** ↓

```
1 MAIN MENU
+Manage Programs
+Pump
+Configuration
```

OK ↓

The capacity of the circulating pump is set by adjusting the motor speed

① Press the  key if a parameter is to be retained. (prior to OK)

Level 2	Submenu >Pump<
<pre>2 PUMP ----- +Pumpe stage 1</pre>	<p>The set pump stage is displayed. Example: 1</p> <ul style="list-style-type: none"> <li>Confirm by pressing <b>OK</b>.</li> </ul>
<pre>2 PUMP ----- +Pumpe stage 3</pre>	<p>① Set required pump stage by pressing   and <b>OK</b>.</p> <p>Example: 3</p>

Example:  
Adjusted      Effective

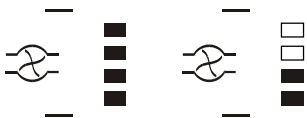

Adjustable pump capacity      stage 1 ... 4

Illuminated display:  for pump pressure

- ① Indication of the adjusted pump pressure stage in the –OFF- mode.
- ① Indication of the effective pump pressure stage (rotational speed) after start.

To protect the pump motor, the rotational speed changes with the load applied, for example, depending on the viscosity of the bath fluid at different working temperatures.

Flow rate:                      22 ... 26 l/min

Pump capacity stage		1	2	3	4
Pump pressure	[bar]	0.4	0.5	0.6	0.7
Suction pump	[bar]	0.2	0.26	0.33	0.4
Total capacity in a loop circuit	[bar]	0.6	0.76	0.93	1.1

## 9.4. Configuration









**MENU** ↓





















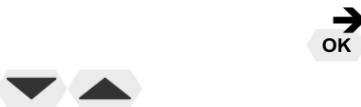



```
1 MAIN MENU
+Pump
→Configuration
▽Control
```

**OK** ↓



```
2 CONFIGURATION
-----
→Remote          off
Setpoint ext     off
Autostart        off
Off-Mode         P. off
ActVar           control
Time/Date
Language         english
Unit             °C
Program Type     Grad
Reset
C-Fühler         no
-----
```









ⓘ Press the  key if a parameter is to be retained. (prior to OK)

Level 2	Parameter level	
<pre>2 CONFIGURATION ----- →Remote          off ▽Setpoint ext   off</pre> <p>↓ ↑</p> <p><b>OK</b> →</p>	<pre>2 CONFIGURATION ----- Remote (RS232)  off</pre> <p>or</p> <pre>2 CONFIGURATION ----- Remote (RS485)  off</pre>	<p>Remote control via serial interface.</p> <p>Possible parameters: <b>off / on</b></p> <ul style="list-style-type: none"> <li>ⓘ Switch on and off remote control by pressing   and <b>OK</b></li> <li>ⓘ First set the &gt;type&lt; of interface (RS232 or RS485) in the MENU &gt;INTERFACE SERIAL&lt; and then switch &gt;Remote&lt; to &gt;on&lt;.</li> <li>ⓘ Control display in the top line <b>R</b> for Remote</li> <li>ⓘ  Connect SERIAL with PC.</li> </ul>
<pre>2 CONFIGURATION +Remote          off →Setpoint ext   off ▽Autostart      off</pre> <p>↓ ↑</p> <p><b>OK</b> →</p>	<pre>2 CONFIGURATION ----- Setpoint ext    off</pre> <ul style="list-style-type: none"> <li>• Switch over setpoint setting by pressing   and <b>OK</b></li> </ul>	<p>External setpoint setting</p> <p>Possible parameters: <b>off / Eprog / PT100</b></p> <ul style="list-style-type: none"> <li>• Switch over setpoint setting by pressing   and <b>OK</b></li> </ul> <p>off – Setpoint setting with the keys or Setpoint setting via the analog socket „ext. Pt100 or analog socket &gt;REG+EPROG&lt;</p>
<pre>2 CONFIGURATION +Setpoint ext   off →Autostart      off ▽Off-Mode       P. off</pre> <p>↓ ↑</p> <p><b>OK</b> →</p>	<pre>2 CONFIGURATION ----- Autostart       off</pre>	<p>Autostart</p> <p>Possible parameters: <b>on / off</b></p> <ul style="list-style-type: none"> <li>• Switch on and off Autostart by pressing   and <b>OK</b></li> </ul>

Level 2	Parameter level	
<pre>2 CONFIGURATION ^Autostart      off →Off-Mode      P. off ▽ActVar        control</pre> 	<pre>2 CONFIGURATION ----- Off-Mode  # P. off</pre> 	<p>Pump-Mode</p> <p>Possible parameters: <b>P. on / P. off</b></p> <ul style="list-style-type: none"> <li>Switch on and off &gt;Off-Mode by pressing   and </li> </ul> <p>P.on continuous operation of circulating pump</p> <p>P.off circulating pump is linked to Start/Stop</p>
<pre>2 CONFIGURATION ^Off-Mode      P. off →ActVar        control ▽Time/Date</pre> 	<pre>2 CONFIGURATION ----- ActVar        # control</pre> 	<p>ActVar - actuating variable</p> <p>Possible parameters: <b>control, Eprog, serial</b></p> <p>① Set desired parameters with   and .</p> <p>① Programming of variables for the parameters &gt; <b>serial</b> &lt; or &gt; EPROG &lt; is only accepted, if the unit is in Start mode</p>
<pre>2 CONFIGURATION ^ActVar        control →Time/Date ▽Language      english</pre> 		<p>Time, Date, Year see next page</p>
<pre>2 CONFIGURATION ^Time/Date →Language      english ▽Unit          °C</pre> 	<pre>2 KONFIGURATION ----- Language      # english</pre> 	<p>Language</p> <p>Possible parameters: <b>deutsch / english</b></p> <ul style="list-style-type: none"> <li>Set desired parameters with   and .</li> </ul>
<pre>2 CONFIGURATION ^Language      english →Unit          °C ▽Program type  time</pre> 	<pre>2 KONFIGURATION ----- Unit          # °C</pre> 	<p>Unit</p> <p>Possible parameters: <b>°C / °F</b></p> <ul style="list-style-type: none"> <li>Set desired parameters with   and .</li> </ul>
<pre>2 CONFIGURATION ^Unit          °C →Program type  time ▽Reset</pre> 	<pre>2 KONFIGURATION ----- Program type  # time</pre> 	<p>Program type</p> <p>Possible parameters: <b>time / grad</b></p> <ul style="list-style-type: none"> <li>Set desired parameters with   and .</li> </ul>

## Menu functions

Level 2	Parameter level	
<pre>2 CONFIGURATION *Program type  time →Reset -----</pre> 	<pre>2 CONFIGURATION ----- Reset? -----</pre>  <pre>2 CONFIGURATION ----- Reset: Running... -----</pre>	<p><b>Reset</b></p> <ul style="list-style-type: none"> <li>Return to factory settings by pressing <b>OK</b></li> <li><b>i</b> &gt;Reset?&lt; returns all set values to the factory setting except for date and time.</li> <li><b>i</b> A RESET can be effected only in the – OFF- mode.</li> <li><b>i</b> During the message &gt;Running &lt; all parameters are reset to factory settings.</li> </ul>

Level 2	Level 3	Parameter / Value
<pre>2 CONFIGURATION *ActVar      control →Time/Date *Language    english -----</pre> 	<pre>3 SET TIME/DATE ----- →hour:min    11:50 Day.Mon      07.07</pre>  <pre>3 SET TIME/DATE hour:min     11:50 →Day.Mon     07.07 Year         2009</pre>  <pre>3 SET TIME/DATE Day.Mon      07.07 →Year        2009 CURRENT:     12:05:16</pre>  <pre>3 SET TIME/DATE Year         2009 →CURRENT:    12:05:16</pre> 	<p>Possible parameters: Time &gt;hour:min Date &gt;Day:Mon Year</p> <ul style="list-style-type: none"> <li>Successively set time, date and year using the numeric keypad and confirm by pressing <b>OK</b>.</li> </ul>  <p><b>Example:</b> 1 1 - 5 0 <b>OK</b></p> <pre>3 SET TIME/DATE ----- hour:min     11:50 -----</pre>  <pre>3 SET TIME/DATE ----- Day.Mon      07.07 -----</pre>  <pre>3 SET TIME/DATE ----- Year         2009 -----</pre>  <p>Only the actual time is displayed.</p> <pre>3 SET TIME/DATE ----- CURRENT:     12:05:16 -----</pre>



The internal real time clock allows starting a program any time. The clock is set to the local mean time (MEZ) at the factory.

- i** If the unit is operated in a different time zone, the clock can be adjusted in this menu.
- i** Change summer/winter time in this menu



### 9.4.1. Remote control via the serial interface

Factory setting: off

```
RS232 : 25.00°C
IntAct : 27.00°C
Power : 0 %
Control : intern
```

```
RS485 : 25.00°C
IntAct : 27.00°C
Power : 0 %
Control : intern
```

Setpoint is set via the serial RS232/RS485 interface through a PC or superordinated data system.

In the header of the VFD COMFORT-DISPLAY, an “**R**” illuminates. It indicates that remote control mode is active.

← The selected setting is shown on the LCD DIALOG-DISPLAY.



**IMPORTANT:** additional measures for remote control

- ① RS232 or RS485:  
First set >type< of interface in the MAIN MENU > Interface serial < the switch >Remote< to >on<.
- ① Connect the circulator to the PC using an interface cable.
- ① Check the interface parameters of both interfaces (circulator and PC) and make sure they match.  
(Refer to 12.1. Setup for remote control page 85)

### 9.4.2. Keypad control or setpoint setting via the analog input

Factory setting: off

```
2 CONFIGURATION
-----
Setpoint ext  #off
-----
```

The selected mode is indicated on standard display.

```
Setpoint1: 152.00°C
IntAct : 50.64°C
Power : 100 %
Control : intern
```

```
Pt100 : 85.00°C
IntAct : 83.00°C
Power : 60 %
Control : external
```

```
Eprog : 50.00°C
IntAct : 27.40°C
Power : 80 %
Control : internal
```

In addition to the serial interface via remote control the circulator offers the possibility to adjust the setpoint via analog interface >ext. Pt100< or >REG+E-PROG<.

Possible parameters:

**off** - Setpoint is set via the keypad or via the integrated programmer.  
(factory setting)

**Pt100** - Setpoint setting via the analog socket „ext. Pt100“ using an external temperature sensor or an appropriate voltage/current source.

**Eprog** - Can only be adjusted when an electronic module with analog connections is used (option).  
Setpoint setting via the analog interface REG+E-PROG connection with an external voltage or current source or a programmer.

**Important:**

- ① Connect the external voltage or current source or a programmer to the circulator via the socket REG+E-PROG (see page 75).  
In the menu >MENU Inputs/Outputs< set the parameter >Erog-INPUT< and the input variables >Eprog-signal< (see page 75).
- ① The E-Prog input can only be used either under menu item >Setpoint ext < or under menu item >ActVar<

```
2 CONFIGURATION
-----
→Remote      off
Setpoint ext  Eprog
Autostart    off
Off-Mode     P. off
ActVar       Eprog
Time/Date
```

### 9.4.3. Autostart

```
2 CONFIGURATION
^Setpoint ext    off
→Autostart      off
▼Off-Mode       P. off
```

Possible parameters:

- on** - Autostart on
- off** - Autostart off (Factory setting)

**Note:**

The circulator has been configured and delivered by JULABO according to N.A.M.U.R. recommendations. This means for the start mode that the unit must enter a safe operating state after a power failure (non-automatic start mode). This safe operating state is indicated by “**OFF**” or “**R OFF**” on the VFD-COMFORT-DISPLAY. A complete shutdown of the main functional elements such as the heater and circulating pump is effected simultaneously.

The values set on the circulator remain stored, and the unit is returned to operation by pressing the start/stop key (in manual control mode). In remote control mode, the values need to be reset by the PC via the interface.

Should such a safety standard not be required, the AUTOSTART function (automatic start mode) may be activated, thus allowing the unit to be started directly by pressing the mains power switch or using a timer.

ⓘ The AUTOSTART function can be used only if the setpoint is set via >keyboard<, >eprog<, or >ext. Pt100<.



**Warning**

For supervised or unsupervised operation with the “AUTOSTART” function avoid any hazardous situation to persons or property

Take care to fully observe the safety and warning functions of the circulator.

### 9.4.4. Off-Mode

```
2 CONFIGURATION
^Autostart      off
→Off-Mode       P. off
▼ActVar         control
```

OFF-Mode

Normally the circulating pump is switched via the start/stop signal. However, if circulation should be maintained even in the -off- condition, the parameter >**pump on**< needs to be set.

Possible parameters:

- P.on Circulating pump in continuous operation
- P.off Circulating pump linked to Start/Stop (factory setting)

### 9.4.5. ActVar - actuating variable

```
2 CONFIGURATION
+Off-Mode      P. off
+ActVar        control
+Time/Date
```

The variable (*ACTuating VARIable*) corresponds to the extent to which the heater or cooling unit of the circulator is controlled. Heat or cold is applied to the bath according to this variable. If this happens with the control electronics of the circulator, called > control < in this particular case, the bath temperature is exactly heated and maintained constant at the adjusted setpoint.

**i** Programming of variables for the parameters > SERIAL < or > EPROG < is only accepted, if the unit is in Start mode.

```
2 CONFIGURATION
-----
ActVar  + control
-----
```

#### Possible parameters:

**control** – The internal control electronics of the circulator controls the heater and the connected cooling unit. Self-tuning is possible.. (factory setting)

**serial** – – The heater or the connected cooling unit receives the control signal via the serial interface. Self-tuning is not possible.

**Eprog** - The heater or the connected cooling unit receives the control signal via the E-Prog input. Self-tuning is not possible.  
- Setting requires electronic module.

```
2 CONFIGURATION
-----
ActVar  + serial
-----
```

```
2 CONFIGURATION
-----
ActVar  + Eprog
-----
```

#### **Important:**

Set the parameter >Eprog< and the input variables also in the menu >Inputs/Outputs< (see page 75).

#### **Note:**

The E-Prog input can only be used either under menu item >Setpoint ext< or under menu item > ActVar <.

```
2 CONFIGURATION
-----
+Remote      off
Setpoint ext Eprog
Autostart    off
Off-Mode     P. off
ActVar       Eprog
Time/Date
```



#### **Warning:**

The working temperature range of the circulator is determined during configuration. If set to >Control<, this range cannot be exceeded.

If set to > Serial < and > Eprog <, heat or cold is applied to the bath without control. The permissible maximum temperature can be exceeded. The user has to take adequate precautions for temperature control.

Materials, such as gaskets or insulations for example, may be damaged or destroyed, if the permissible maximum temperature is exceeded.

The safety and warning functions >  < of the instrument must always be used to their fullest capacity.

### 9.4.6. Setting of clock and date



```
2 CONFIGURATION
^ActVar      control
→Time/Date
▽Language    english
```

The internal real time clock allows starting a program any time. The clock is set to the local mean time (MEZ) at the factory.

- ❗ If the unit is operated in a different time zone, the clock can be adjusted in this menu.
- ❗ Change summer/winter time in this menu

### 9.4.7. Language

```
2 CONFIGURATION
^Time/Date
→Language    english
▽Unit        °C
```

There are two options for the language of the LCD DIALOG-DISPLAY: German and English.

Possible parameters:

**deutsch / english**

### 9.4.8. Unit

```
2 CONFIGURATION
^Language     english
→Unit        °C
▽Program typ  Zeit
```

Temperature values can be displayed in °C or °F.

With this change, all adjusted temperature values are converted and displayed in the new unit.

Possible parameters:

**°C** (factory setting)

**°F**

### 9.4.9. Program type

```
2 CONFIGURATION
^Unit        °C
→Program typ  time
▽Reset
```

A program can be created with the parameters time or gradient.

Possible parameters:

**time** (factory setting)

**Grd** (Gradient) [°/t] = [°/min]

### 9.4.10. Reset

```
2 CONFIGURATION
^Program typ  time
→Reset
-----
```

A Reset will return all values to factory setting except for date and time.

- ❗ A Reset can be effected in the >OFF< mode only.

## 9.5. Control

The circulator is designed for internal and external temperature control. This can be switched in this submenu. Only the set of parameters corresponding to the particular setting is displayed.

Control internal

```

2 CONTROL
-----
->ControlType  intern
vSelftuning9  always
Dynamic       aperio
Xp            1.0K
Tn            100s
Tv            5s
-----
    
```

Control external

```

2 CONTROL
-----
->ControlType  extern
vSelftuning9  always
CoSpeed       0.0
Xp            0.7K
Tn            720s
Tv            55s
Xpu           2.9K
-----
    
```

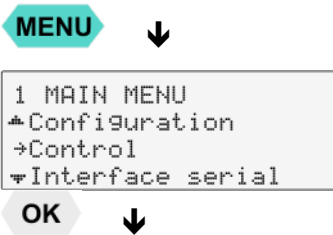

ⓘ For external temperature control and measurement connect a Pt100 external sensor to the socket at the rear of the circulator.

ⓘ Press the key if a parameter is to be retained. (prior to OK)

Level 2	Parameter-Level	
<pre> 2 CONTROL ----- -&gt;ControlType  intern vSelftuning9  always                 </pre>	<pre> 2 CONTROL ----- ControlType #intern                 </pre> <p>or</p> <pre> 2 CONTROL ----- ControlType #extern                 </pre>	<ul style="list-style-type: none"> <li>Switch over control type by pressing   and </li> <li>Possible parameters: <b>intern / extern</b></li> </ul> <p>ⓘ The control type can be adjusted in the <b>-OFF-</b> mode only.</p>
<pre> 2 CONTROL +ControlType  intern -&gt;Selftuning9  always vDynamic      aperio                 </pre>	<pre> 2 CONTROL ----- Selftuning9  always                 </pre>	<p>ⓘ The parameter flashes, switch by pressing   and </p> <p>Possible parameters: <b>off / once / always.</b></p>

Control Type internal	Parameter-Level	
<pre> 2 CONTROL +Selftuning9  always -&gt;Dynamic      aperio vXp           1.0K                 </pre>	<pre> 2 CONTROL ----- Dynamic      aperio                 </pre>	<p>ⓘ The parameter flashes, switch by pressing   and </p> <p>Possible parameters: <b>aperio / normal</b></p> <p>ⓘ This parameter affects the temperature sequence in case of internal control.</p>

Menu functions

Control Type internal	Parameter-Level	
		<ul style="list-style-type: none"> <li>The value flashes. Set by using the numeric keypad and confirm by pressing <b>OK</b>.</li> </ul> <p>Example: <b>1</b> <b>-</b> <b>0</b> <b>OK</b></p> <p>Setting range: 0.1 ... 99.9 K</p>
		<ul style="list-style-type: none"> <li>The value flashes. Set by using the numeric keypad and confirm by pressing <b>OK</b>.</li> </ul> <p>Setting range: 3 ... 9999 s</p>
		<ul style="list-style-type: none"> <li>The value flashes. Set by using the numeric keypad and confirm by pressing <b>OK</b>.</li> </ul> <p>Setting range: 0 ... 999 s</p>
Control Type external	Parameter-Level	
		<ul style="list-style-type: none"> <li>The value flashes. Set by using the numeric keypad and confirm by pressing <b>OK</b>.</li> </ul> <p>Example: <b>0</b> <b>-</b> <b>0</b> <b>OK</b></p> <p>Setting range: 0.0 ... 5.0</p>
		<ul style="list-style-type: none"> <li>The value flashes. Set by using the numeric keypad and confirm by pressing <b>OK</b>.</li> </ul> <p>Setting range: 0.1 ... 99.9 K</p>
		<ul style="list-style-type: none"> <li>The value flashes. Set by using the numeric keypad and confirm by pressing <b>OK</b>.</li> </ul> <p>Setting range: 3 ... 9999 s</p>
		<ul style="list-style-type: none"> <li>The value flashes. Set by using the numeric keypad and confirm by pressing <b>OK</b>.</li> </ul> <p>Setting range: 0 ... 999 s</p>
		<ul style="list-style-type: none"> <li>The value flashes. Set by using the numeric keypad and confirm by pressing <b>OK</b>.</li> </ul> <p>Setting range: 0.1 ... 99.9 K</p>

### 9.5.1. Control internal / external



① The control type can be adjusted in the **-OFF-** mode only.

Possible parameters:

**intern** internal temperature control

**extern** external temperature control with external Pt100 sensor



ext.  
Pt100

#### IMPORTANT:

Additional measures for external temperature control.

① Connect a Pt100 sensor to the socket on the rear of the circulator.

① Sensor calibration of the external Pt100 sensor is performed in the >ATCalibration< menu.

① Suggested adjustments for external temperature control:  
Upper band / Lower band and IntMax / IntMin  
see Section >Limits<.

① External temperature control does not allow the setpoint to be set via the "ext. Pt100" socket.



#### Notice:

Place the external sensor into the temperature-controlled medium and securely fix the sensor.

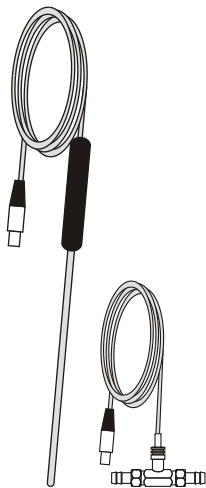

Pt100

M+R

#### Accessory: Pt100 external sensor

Order No.	Description	Material	Cable
8981003	200x6 mm Ø,	stainless steel	1.5 m
8981005	200x6 mm Ø,	glass	1.5 m
8981006	20x2 mm Ø,	stainless steel	1.5 m
8981010	300x6 mm Ø,	stainless steel	1.5 m
8981015	300x6 mm Ø,	stainless steel / PTFE coated	3 m
8981013	600x6 mm Ø,	stainless steel / PTFE coated	3 m
8981016	900x6 mm Ø,	stainless steel / PTFE coated	3 m
8981014	1200x6 mm Ø,	stainless steel / PTFE coated	3 m
8981103	Extension cable for Pt100 sensor		3.5 m
8981020	M+R in-line Pt100 sensor		

The M+R in-line Pt100 sensor is a flow sensor and can be installed loop circuit

### 9.5.2. Selftuning

When performing a selftuning for the controlled system (temperature application system), the control parameters  $X_p$ ,  $T_n$  and  $T_v$  are automatically determined and stored.

Possible parameters:

**off** - no selftuning

The control parameters ascertained during the last identification are used for control purposes.

**once** - single selftuning (factory setting)

The instrument performs a single selftuning of the controlled system after each start with the **OK** key or after receiving a start command via the interface.

**always** - continual selftuning

The instrument performs a selftuning of the controlled system whenever a new setpoint is to be reached.

Use this setting only when the temperature application system changes permanently.

### 9.5.3. Dynamik intern

This parameter affects the temperature sequence only in case of internal control.

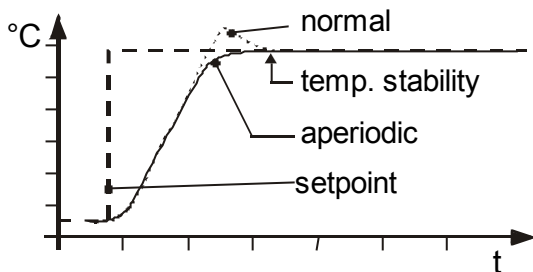

Factory setting: APER (aperiodic)

Possible parameters:

**normal** Allows for reaching the setpoint faster – with setpoint change or ramp function – but overshooting of up to 5 % is possible.

**aperio** Ramp function: the increase of temperature occurs temporally offset and achieves the target temperature without overshooting.  
Setpoint change: The temperature increases at the same rate, the target temperature is achieved without overshooting.

ⓘ With both settings constant temperature is achieved after approximately the same time.

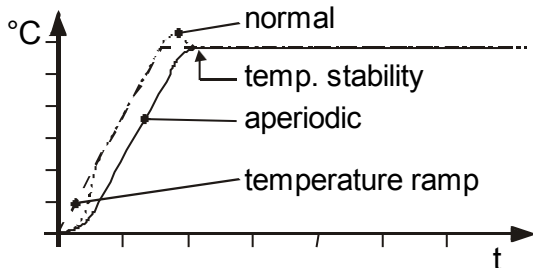



### 9.5.4. CoSpeed - extern

#### **CoSpeed:**

This parameter affects the temperature pattern only in case of **external** control.

Possible parameters: 0 ... 5

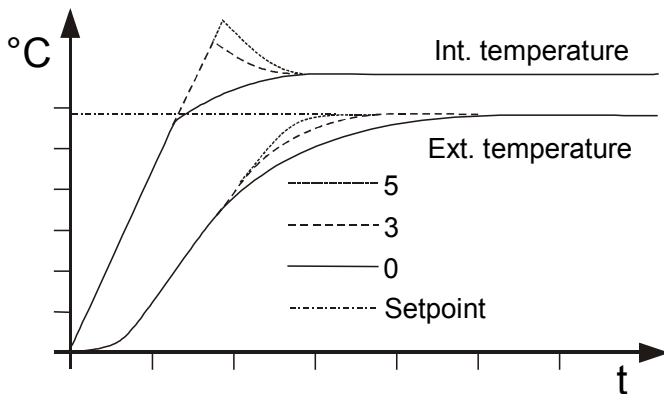

During selftuning, the control parameters  $X_p$ ,  $T_n$ , and  $T_v$  of a controlled system are automatically determined and stored. The time required for tuning may vary depending on the controlled system. This controller design allows protection of sensitive objects requiring temperature control. As soon as a co-speed factor is set, it is considered in calculating the control parameters. As shown in the diagram, tuning times are shorter the higher the co-speed factor is, but overshoot can occur in the internal system.

### 9.5.5. Control parameters – internal/external

#### **Control parameters – internal/external**

The control parameters preset at the factory are in most cases adequate to achieve an optimal temperature pattern in the samples requiring temperature control.

Each parameter may be manually set via the keypad if necessary to allow optimal control performance.

Setting range:  
internal / external  
0.1 ... 99.9 K

#### **Proportional range >Xp<**

The proportional range is the temperature range below the setpoint temperature value in which the control circuit reduces the heating power from 100% to 0%.

Setting range:  
internal / external  
3 ... 9999 s

#### **Resetting time >Tn< (Integral component)**

Compensation of the remaining control deviation due to proportional control. An insufficient resetting time may cause instabilities to occur. An excessive resetting time will unnecessarily prolong compensation of the control difference.

Setting range:  
internal / external  
0 ... 999 s

#### **Lead time >Tv< (Differential component)**

The differential component reduces the control settling time. An insufficient lead time will prolong the time required to compensate for disturbance effects and cause high overshoot during run-up. An excessive lead time could cause instabilities (oscillations) to occur.

Setting range:  
0.1 ... 99.9 K

#### **Proportional range >Xpu<**

The proportional range  $X_{pu}$  of the cascaded controller is only needed for external control.

**Optimization instructions for the PID control parameters:**

The heat-up curve reveals inappropriate control settings.

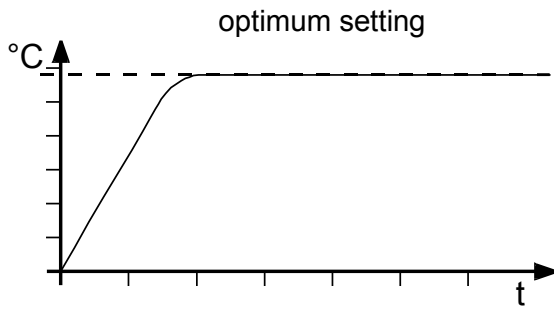

**Inappropriate settings may produce the following heat-up curves:**

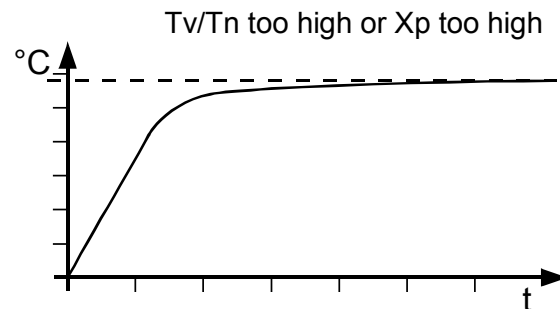
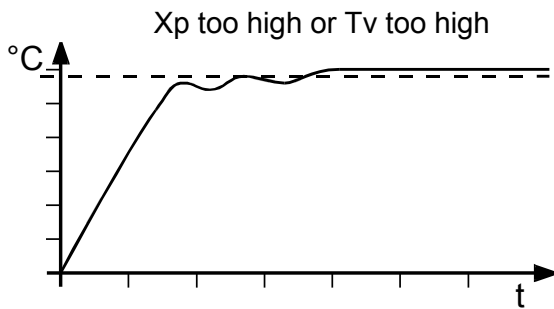
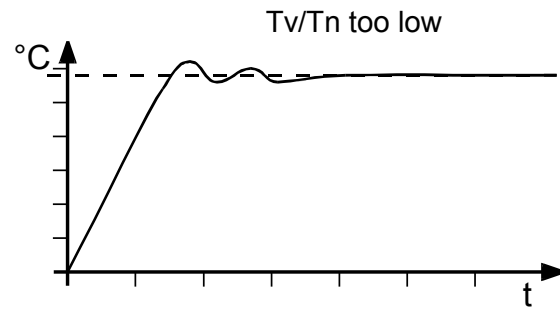
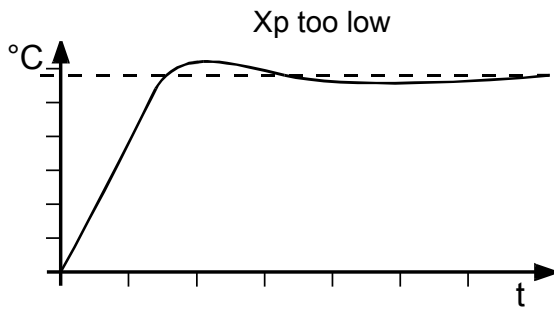

## 9.6. Serial Interface

Factory settings:  
 4800 Baud  
 even  
 hardware handshake

For communication between the circulator and a PC or a superordinated process system, the interface parameters of both units must be identical. The adjustment is usually carried out one time only in the >Interface serial< menu.

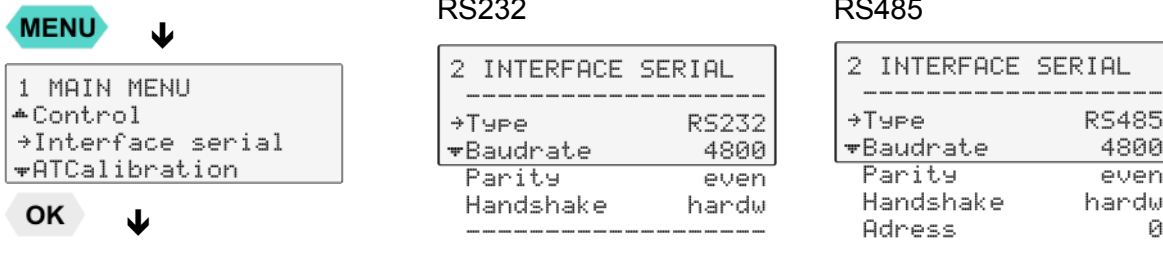

Level 2	Parameter-level	ⓘ Press the  key if a parameter is to be retained. (prior to OK)
<pre> 2 INTERFACE SERIAL ----- →Type          RS232 ▼Baudrate      4800                     </pre> <p> →</p> <p> </p>	<pre> 2 INTERFACE SERIAL ----- Type          ⚡ RS232                     </pre>	<ul style="list-style-type: none"> <li>The parameter flashes, switch by pressing   and </li> </ul> <p>Possible parameters: <b>RS232 / RS485</b></p> <p><b>Address RS485:</b> 0 to 127</p>
<pre> 2 INTERFACE SERIAL ----- ▲Type          RS232 →Baudrate      4800 ▼Parity        even                     </pre> <p> →</p> <p> </p>	<pre> 2 INTERFACE SERIAL ----- Baudrate      ⚡ 4800                     </pre>	<ul style="list-style-type: none"> <li>The parameter flashes, switch by pressing   and </li> </ul> <p>Possible parameters:  <b>4800 / 9600 / 19200 / 38400</b></p>
<pre> 2 INTERFACE SERIAL ----- ▲Baudrate      4800 →Parity        even ▼Handshake     hardw                     </pre> <p> →</p> <p> </p>	<pre> 2 INTERFACE SERIAL ----- Parity        ⚡ even                     </pre>	<ul style="list-style-type: none"> <li>The parameter flashes, switch by pressing   and </li> </ul> <p>Possible parameters: <b>no/even/odd</b></p> <p>even: Data bits = 7; Stop bits = 1                      odd: Data bits = 7; Stop bits = 1                      no: Data bits = 8; Stop bits = 1</p>
<pre> 2 INTERFACE SERIAL ----- ▲Parity        even →Handshake     hardw                     </pre> <p> →</p>	<pre> 2 SERIELLES INTERF. ----- Handshake     ⚡ hardw                     </pre>	<ul style="list-style-type: none"> <li>The parameter flashes, switch by pressing   and </li> </ul> <p>Possible parameters: <b>hardw / softw</b></p> <p>Xon/Xoff-protocol (Software handshake)                      Protocol RTS/CTS (Hardware handshake)</p>

### 9.7. ATC Absolute Temperature Calibration, 3-point calibration

ATC is used to compensate for a temperature difference between the circulator and a defined measuring point in the bath tank that may develop for physical reasons.

ATC

internal

```

2 ATCalibration
-----
→Sensor      intern
▼Status      no
Type         3-Point
TmpValue1   : xx.xx° C
CalValue1   : xx.xx° C
TmpValue2   : xx.xx° C
CalValue2   : xx.xx° C
TmpValue3   : xx.xx° C
CalValue3   : xx.xx° C
-----
    
```

external

```

2 ATCalibration
-----
→Sensor      extern
▼Status      no
Type         3-Point
TmpValue1   : xx.xx° C
CalValue1   : xx.xx° C
TmpValue2   : xx.xx° C
CalValue2   : xx.xx° C
TmpValue3   : xx.xx° C
CalValue3   : xx.xx° C
-----
    
```

Example:  
1-point calibration

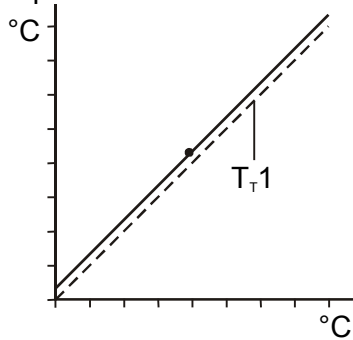

3-point calibration

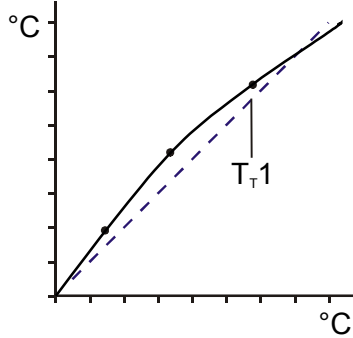







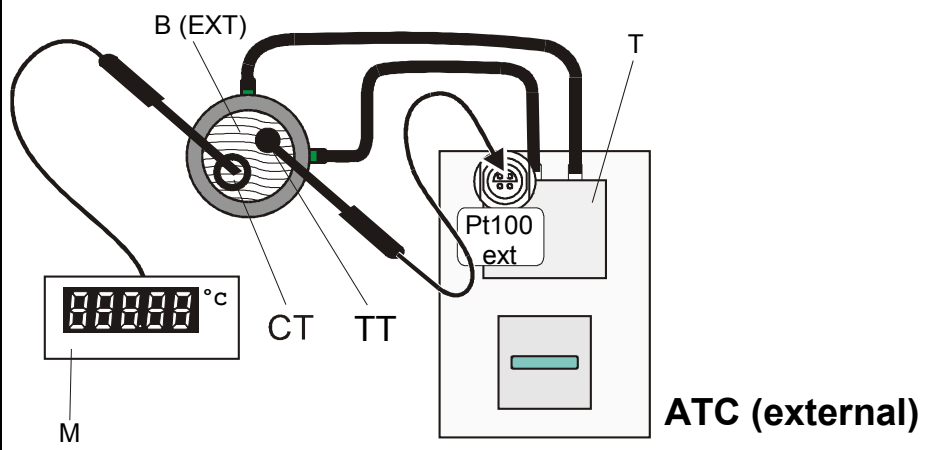
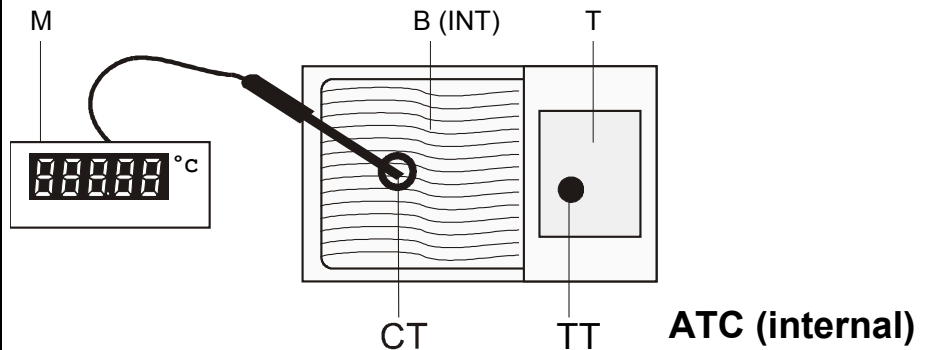











T<sub>T</sub> 1 = Original curve

**Principle:**







For ATC calibration, in steady state the bath temperature at the location of the temperature sensor (CT) is determined at the respective adjusted working temperature. This value is then set on the circulator in the menu >ATCalibration< under menu item >CTEMP X<. This can be a 1-point, 2-point or 3-point calibration.



- M = Temperature measuring instrument with temperature sensor
- B = Bath tank (INTernal or EXTernal)
- T = circulator
- CT = Temperature on measuring point
- TT = Temperature on circulator

<p><b>MENU</b> ↓</p> <pre> 1 MAIN MENU +Interface serial +ATCalibration +Limits OK ↓         </pre>	<p>① Press the  key if a parameter is to be retained. (prior to OK)</p>	
<p>Level 2</p>	<p>Parameter-Level</p>	
<pre> 2 ATCalibration ----- +Sensor          intern +Status          no Type             no OK →         </pre> <p> </p>	<pre> 2 ATCalibration ----- Sensor           intern -----                 </pre> <p>or</p> <pre> 2 ATCalibration ----- Sensor           extern -----                 </pre>	<ul style="list-style-type: none"> <li>• The parameter flashes, switch by pressing   and <b>OK</b></li> </ul>
<pre> 2 ATCalibration +Sensor          intern +Status          no Type             3-point OK →         </pre> <p> </p>	<pre> 2 ATCalibration ----- Status           yes -----                 </pre> <p>or</p> <pre> 2 ATCalibration ----- Status           no -----                 </pre>	<p>① The parameter flashes, switch by pressing   and <b>OK</b></p> <p>① <b>&gt;no&lt;</b> Carry out an ATC calibration</p> <p>① <b>&gt;yes&lt;</b> return to standard operation after calibration.</p>
<pre> 2 ATCalibration +Status          no Type             3-point TmpValue1 : xx.xx°C OK →         </pre> <p> </p>	<pre> 2 ATCalibration ----- Type             1-point -----                 </pre> <p>or</p> <pre> 2 ATCalibration ----- Type             2-point -----                 </pre> <p>or</p> <pre> 2 ATCalibration ----- Type             3-point -----                 </pre>	<ul style="list-style-type: none"> <li>• The parameter flashes, switch by pressing   and <b>OK</b></li> <li>① A <b>&gt;1-point&lt;</b>, <b>&gt;2-point&lt;</b> or <b>&gt;3-point&lt;</b> calibration can be carried out.</li> </ul>
<pre> 2 ATCalibration +Type            3-Point +TmpValue1 : 80.00°C +CalValue1 : 79.70°C OK →         </pre> <p> </p> <pre> 2 ATCalibration +TmpValue1 : xx.xx°C +CalValue1 : xx.xx°C +TmpValue2 : xx.xx°C OK →         </pre> <p> </p>	<pre> 2 ATCalibration ----- TmpValue1 : xx.xx°C -----                 </pre> <p></p> <pre> 2 ATCalibration ----- CalValue1 : xx.xx°C -----                 </pre>	<p>The value <b>&gt;TmpValue&lt;</b> is only indicated</p> <p>① In addition the measured temperature value <b>&gt;CalValue X&lt;</b> is saved during the next step.</p> <ul style="list-style-type: none"> <li>• The value flashes. Set by using the numeric keypad and confirm by pressing <b>OK</b> .</li> </ul>
	<p>① If only a 1-point calibration is carried out, the following menu items are not indicated anymore</p>	

Menu functions

<pre>2 ATCalibration +CalValue1 : xx.xx° C →TmpValue2 : xx.xx° C ▽CalValue2 : xx.xx° C</pre> <p>OK →</p> 	<pre>2 ATCalibration ----- TmpValue2 : xx.xx° C</pre> 	<p>The value &gt;TmpValue&lt; is only indicated</p> <p>① In addition the measured temperature value &gt;CalValue X&lt; is saved during the next step.</p>
<pre>2 ATCalibration +TmpValue2 : xx.xx° C →CalValue2 : xx.xx° C ▽TmpValue3 : xx.xx° C</pre> <p>OK →</p> 	<pre>2 ATCalibration ----- CalValue2 : xx.xx° C</pre> 	<ul style="list-style-type: none"> <li>The value flashes. Set by using the numeric keypad and confirm by pressing <b>OK</b>.</li> </ul>
<p>① If only a 2-point calibration is carried out, the following menu items are not indicated anymore</p>		
<pre>2 ATCalibration +CalValue2 : xx.xx° C →TmpValue3 : xx.xx° C ▽CalValue3 : xx.xx° C</pre> <p>OK →</p> 	<pre>2 ATCalibration ----- TmpValue3 : xx.xx° C</pre> 	<p>The value &gt;TmpValue&lt; is only indicated.</p> <p>① In addition the measured temperature value &gt;CalValue X&lt; is saved during the next step..</p>
<pre>2 ATCalibration +TmpValue3 : xx.xx° C →CalValue3 : xx.xx° C -----</pre> <p>OK →</p>	<pre>2 ATCalibration ----- CalValue3 : xx.xx° C</pre> 	<ul style="list-style-type: none"> <li>The value flashes. Set by using the numeric keypad and confirm by pressing <b>OK</b>.</li> </ul>

### 9.7.1. ATC Fühler - intern / extern

```

2 ATCalibration
-----
→Sensor      intern
▼Status      no

```

In the first submenu the ATC function is set for the >intern< internal or the >extern< external temperature sensor.

Calibration can be carried out for the internal temperature sensor and for the external temperature sensor connected to the socket „ext. Pt100“. The circulator is able to save both parameter sets. However only the one which has been set under menu item > sensor < is displayed.

### 9.7.2. ATC Status - yes / no

```

2 ATCalibration
-----
▲Sensor      intern
→Status      no
▼Type        3-point

```

In the second submenu the ATC function for the temperature sensor selected above is activated >yes< or deactivated >no<.

>yes< (factory setting) The controller of the circulator uses the original curve of the temperature sensor or the new curve measured during the ATC calibration.

**Important:** Set to >NO< during the calibration process

>no< An ATC calibration is to be carried out.

**Important:** Set to >yes< after calibration.

❗ In the > Status < >yes< the ATC calibration always affects the current working temperature; also the one set via interface.

### 9.7.3. Type 1 - / 2 - / 3 point

```

2 ATCalibration
-----
Type          1-point
-----

```

```

2 ATCalibration
-----
Type          2-point
-----

```

```

2 ATCalibration
-----
Type          3-point
-----

```

A >1-point<, >2-point< or >3-point< **calibration** can be carried out.

First geometrically define the location for calibration (measuring point CT), then determine the temperature values of the calibration points.

The type of calibrations also determines the number of the following pairs of values indicated on the LCD DIALOG-DISPLAY.

**Pairs of values:**

**TmpValue X:** Circulator temperature 1 or 2 or 3 (actual value TT )

The actual temperature of the bath is simultaneously saved with the “calibration value“ >CalValue< and can be indicated for control purposes (value does not flash).

```

2 ATCalibration
-----
TmpValue1 : xx.xx°C
-----

```

```

2 ATCalibration
-----
CalValue1 : xx.xx°C
-----

```

**CalValue X:** Calibration temperature 1 or 2 or 3 (actual value CT )

The „calibration value“ is determined with a temperature measuring device and saved under menu item >CalValue<.

(value flashes  $\overline{\text{X}}$ )

**9.7.4. Example: 3-point calibration for internal control**

In the temperature range from 80 °C to 160 °C the calibration curve of the temperature sensor (TT) is to be adjusted to the actual temperatures at measuring point (CT).

**1. Set circulator to internal control:**

The type of control can be set only in the –OFF- mode.

```
2 CONTROL
-----
->ControlType  intern
  Selftuning    always
```



```
2 CONTROL
-----
ControlType #intern
```



80.00 °C  
120.00 °C  
160.00 °C

```
Setpoint1: 80.00°C
IntAct    : 24.64°C
Power     : 0 %
Control   : internal
```



**2. Set working temperature setpoint**

See standard display line 1

- Example 80.00 °C  
Press the keys **8** and **0** and confirm by pressing **OK**.
- The bath is heated up.  
Wait for approx. 5 minutes until the temperature is constant.

**3. Reading of temperature measuring device**

Read the value of measuring point CT on the device and enter under menu item > CalValue X< by using the keypad.

- CalValue 1< (79.70 °C)
- CalValue 2< (119.50 °C)
- CalValue 3< (159.30 °C)



**MENU** ↓

```
1 MAIN MENU
  Interface serial
  ATCalibration
  Limits
```

**OK** ↓

**4. Calibration**

- Press the key if a parameter is to be retained. (prior to OK)
- Setting is required only for the first calibration point.

Level 2

Parameter-Level

```
2 ATCalibration
-----
->Sensor      intern
  Status      no
```

↓ ↑ **OK** →

```
2 ATCalibration
-----
Sensor      intern
```

Set sensor: >intern<.

- The parameter flashes, switch by pressing and **OK**

```
2 ATCalibration
  Sensor      intern
->Status      no
  Type        3-point
```

↓ ↑ **OK** →

```
2 ATCalibration
-----
Status      no
```

Set to >no<

- The parameter flashes, switch by pressing and **OK**

```
2 ATCalibration
  Status      no
->Type        3-point
  TempValue1 : xx.xx°C
```

↓ ↑ **OK** →

```
2 ATCalibration
-----
Type        3-point
```

A >3-point< calibration is carried out.

- The parameter flashes, switch by pressing and **OK**



<pre> 2 ATCalibration ^Type      3-Point →TmpValue1 : 80.00°C ▼CalValue1 : 79.70°C OK →  ▼ ▲  2 ATCalibration ^TmpValue1 : 80.00°C →CalValue1 : 79.70°C ▼TmpValue2 : 120.00°C OK →  ▼ ▲ </pre>	<pre> 2 ATCalibration ----- TmpValue1 : 80.00°C -----  2 ATCalibration ----- CalValue1 : 79.70°C ----- </pre>	<p>The value &gt;TmpValue&lt; is only indicated.</p> <p>① In addition the measured temperature value &gt;CalValue X&lt; is saved during the next step.</p> <ul style="list-style-type: none"> <li>The value flashes. Set by using the numeric keypad and confirm by pressing <b>OK</b>.</li> </ul>
Return to 2. Set working temperature value: 120.00 °C		
<pre> 2 ATCalibration ^CalValue1 : 79.70°C →TmpValue2 : 120.00°C ▼CalValue2 : 119.50°C OK →  ▼ ▲ </pre>	<pre> 2 ATCalibration ----- TmpValue2 : 120.00°C ----- </pre>	<p>The value &gt;TmpValue&lt; is only indicated.</p> <p>① In addition the measured temperature value &gt;CalValue X&lt; is saved during the next step.</p>
<pre> 2 ATCalibration ^TmpValue2 : 120.00°C →CalValue2 : 119.50°C ▼TmpValue3 : 160.00°C OK →  ▼ ▲ </pre>	<pre> 2 ATCalibration ----- CalValue2 : 119.50°C ----- </pre>	<ul style="list-style-type: none"> <li>The value flashes. Set by using the numeric keypad and confirm by pressing <b>OK</b>.</li> </ul>
Return to 2. Set working temperature value: 160.00 °C		
<pre> 2 ATCalibration ^CalValue2 : 119.50°C →TmpValue3 : 160.00°C ▼CalValue3 : 159.30°C OK →  ▼ ▲ </pre>	<pre> 2 ATCalibration ----- TmpValue3 : 160.00°C ----- </pre>	<p>The value &gt;TmpValue&lt; is only indicated.</p> <p>① In addition the measured temperature value &gt;CalValue X&lt; is saved during the next step.</p>
<pre> 2 ATCalibration ^TmpValue3 : 160.00°C →CalValue3 : 159.30°C ----- OK → </pre>	<pre> 2 ATCalibration ----- CalValue3 : 159.30°C ----- </pre>	<ul style="list-style-type: none"> <li>The value flashes. Set by using the numeric keypad and confirm by pressing <b>OK</b>.</li> </ul>
<b>5. Return to standard operation</b>		
<pre> 2 ATCalibration ^Sensor    intern →Status    no ▼Type      3-point OK → </pre>	<pre> 2 ATCalibration ----- Status     yes ----- </pre>	<p>Set &gt;YES&lt; after calibration. (Standard operation)</p> <ul style="list-style-type: none"> <li>The parameter flashes, switch by pressing ▲ ▼ and <b>OK</b></li> </ul>

## 9.8. Limits

The >Limits< menu allows the minimum and maximum values to be set for all important setting ranges and capacity variables.

Control internal









```

2 LIMITS
-----
→SetMax    300.00°C
▼SetMin    -94.99°C
HeatingMax 100%
CoolingMax  0%
-----
    
```

Control external

```

2 LIMITS
-----
→SetMax    300.00°C
▼SetMin    -94.99°C
HeatingMax 100%
CoolingMax  0%
IntMax     300.00°C
IntMin     -94.99°C
Upper band 200K
Lower band 200K
-----
    
```

<p><b>MENU</b> ↓</p> <pre> 1 MAIN MENU ▲ATCalibration →Limits ▼Inputs/Outputs     </pre> <p><b>OK</b> ↓</p>	<p>ⓘ Press the  key if a parameter is to be retained. (prior to OK).</p>	
<p>Level 2</p>	<p>Parameter-level</p>	
<pre> 2 LIMITS ----- →SetMax    300.00°C ▼SetMin    -94.99°C     </pre> <p>⏴ ⏵ <b>OK</b> →</p>	<pre> 2 LIMITS ----- SetMax     300.00°C     </pre> <p> </p>	<ul style="list-style-type: none"> <li>• The parameter flashes. Set by using the numeric keypad and confirm by pressing <b>OK</b> ..</li> </ul>
<pre> 2 LIMITS ▲SetMax    300.00°C →SetMin    -94.99°C ▼HeatingMax 100%     </pre> <p>⏴ ⏵ <b>OK</b> →</p>	<pre> 2 LIMITS ----- SetMin     -94.99°C     </pre> <p> </p>	<ul style="list-style-type: none"> <li>• The parameter flashes. Set by using the numeric keypad and confirm by pressing <b>OK</b> ..</li> </ul>
<pre> 2 LIMITS ▲SetMin    -94.99°C →HeatingMax 100% ▼CoolingMax  0%     </pre> <p>⏴ ⏵ <b>OK</b> →</p>	<pre> 2 LIMITS ----- HeatingMax 100%     </pre> <p> </p>	<ul style="list-style-type: none"> <li>• The parameter flashes. Set by using the numeric keypad and confirm by pressing <b>OK</b> .</li> </ul>
<pre> 2 LIMITS ▲HeatingMax 100% →CoolingMax 100% ▼IntMax     300.00°C     </pre> <p>⏴ ⏵ <b>OK</b> →</p>	<pre> 2 LIMITS ----- CoolingMax  0%     </pre> <p> </p>	<ul style="list-style-type: none"> <li>• The parameter flashes. Set by using the numeric keypad and confirm by pressing <b>OK</b> .</li> </ul>

<pre> 2 LIMITS ▲CoolingMax      0% →IntMax          300.00°C ▼IntMin          -94.99°C           </pre> <p>▼ ▲ OK →</p>	<pre> 2 LIMITS ----- IntMax          300.00°C           </pre>	<ul style="list-style-type: none"> <li>The parameter flashes. Set by using the numeric keypad and confirm by pressing <b>OK</b>.</li> </ul>
<pre> 2 LIMITS ▲IntMax          300.00°C →IntMin          -94.99°C ▼Upper band      200K           </pre> <p>▼ ▲ OK →</p>	<pre> 2 LIMITS ----- IntMin          -94.99°C           </pre>	<ul style="list-style-type: none"> <li>The parameter flashes. Set by using the numeric keypad and confirm by pressing <b>OK</b>.</li> </ul>
<pre> 2 LIMITS ▲IntMin          -94.99°C →Upper band      200K ▼Lower band      200K           </pre> <p>▼ ▲ OK →</p>	<pre> 2 LIMITS ----- Upper band      200K           </pre>	<ul style="list-style-type: none"> <li>The parameter flashes. Set by using the numeric keypad and confirm by pressing <b>OK</b>.</li> </ul>
<pre> 2 LIMITS ▲Upper band      200K →Lower band      200K           </pre> <p>▼ ▲ OK →</p>	<pre> 2 LIMITS ----- Lower band      200K           </pre>	<ul style="list-style-type: none"> <li>The parameter flashes. Set by using the numeric keypad and confirm by pressing <b>OK</b>.</li> </ul>

### 9.8.1. Limits for internal control and external control

```

2 LIMITS
-----
SetMax          300.00°C
          
```

```

2 LIMITS
-----
SetMin          -94.99°C
          
```

**Set Max / Min**– Maximum and minimum setpoint  
Restriction of the adjustable temperature range.

The limitation of the operating temperature range effects the temperature setting in the menu with the key **T**.

Only setting of working temperatures which lie within the determined limits is possible

Existing settings for Setpoint 1, -2, -3, as well as those for >OverTemp< and > SubTemp <, are automatically deferred into the limit range.

Setting range: -94,90 °C ... +300,0 °C

#### Set maximum heating / cooling

The heating and cooling capacity of the unit are adjustable. 100 % corresponds to the technical specification of the equipment.

Setting range:

**Heating Max** – 0 to 100 % in 1 % steps

**Cooling Max** – 0 to 100 % in 1 % steps

```

2 LIMITS
-----
HeatingMax      100%
          
```

```

2 LIMITS
-----
CoolingMax      0%
          
```

9.8.2. Limits for external control

**INTERN MAX / MIN**

**Restriction for the temperature range of the internal bath.**

Setting range: -94,9 °C ... +300,0 °C

The limits IntMax and IntMin are only active in external control. IntMax and IntMin determine fixed limits for the temperature within the internal bath. The temperature controller cannot exceed these limits even if it would be necessary for achieving the temperature in an external system. Therefore it is possible that the external setpoint cannot be achieved.

Sense of limit setting:

- Protects the bath fluid from overheating.
- Prevents an undesired alarm shutdown by the excess temperature protection - >ALARM CODE 14<. Set the value of > Int Max at least 5 °C below the value of >SafeTemp<.
- Protects the pump motor from high viscosity of the bath fluid at low temperatures.
- For refrigerated circulators. Freezing protection when using water as bath fluid.

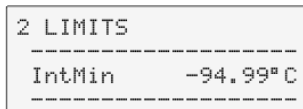

**Upper band: and Lower band:**

The band limitation is active during external control. Varied, practice-oriented setting are feasible for heat-up and cool-down phases.

Setting range: 0 °C ... 200 °C

**Upper band: and Lower band** allow for the limitation of the difference between the temperatures in the internal bath and the external system to any maximum value for the heat-up and cool-down phase. During the heat-up phase this difference value is always added to the actual external temperature. During the cool-down phase the difference value is subtracted.

Sense of a band limitation:

- Protection of objects and samples by gentle temperature control
- Protection of e.g. glass reactors from thermal shock.

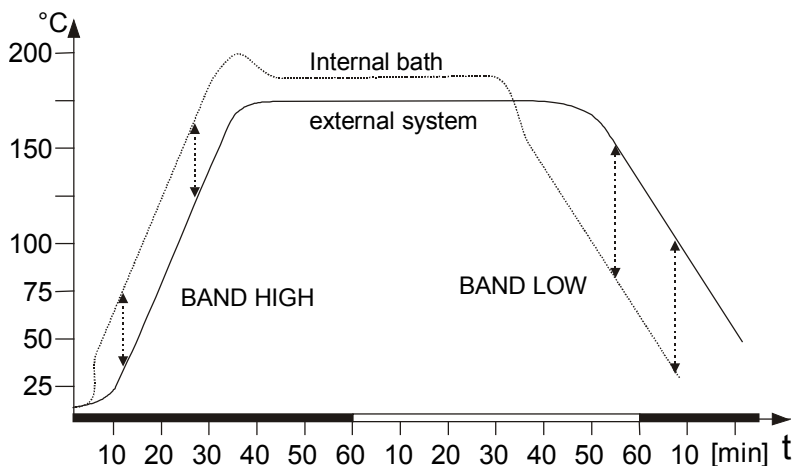
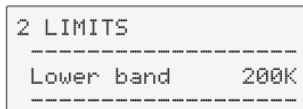

## 9.9. Analog inputs/outputs

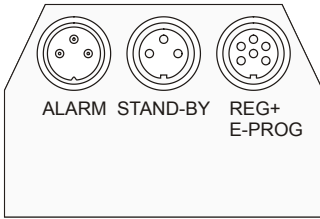

**i** In order to use the analog inputs and outputs, the circulator must be equipped with the electronic module, which is available as option. Order No. 8 900 100 Electronic module

This submenu enables the input and output values to be set for the programmer input and the temperature recorder outputs of the REG+E-PROG socket.

The >STAND-BY< input and the >ALARM< output are configurable.

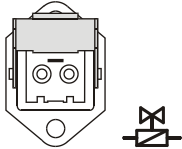

← If the electronic module is not installed, this menu can be used only to switch the control of the solenoid valve (SV).

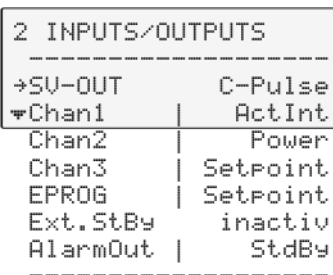

- SV-Output** Control connector (14) 230 V max. 1.25 A
- Channel 1** voltage output for recorder (V)
- Channel 2** voltage output for recorder (V)
- Channel 3** current output for recorder (mA)
- EPROG** external programmer input
- External standby** Standby input (for external switch-off)
- Alarm output** Output for external alarm signal

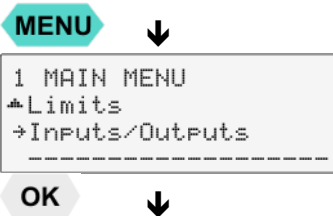

**NOTE:**

Channel 2 is pre-configured for the connection of an HST Booster Heater.

**i** Press the key if a parameter is to be retained. (prior to OK)

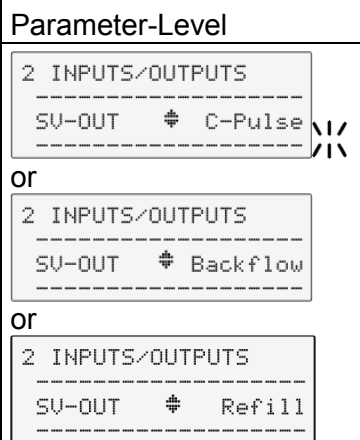
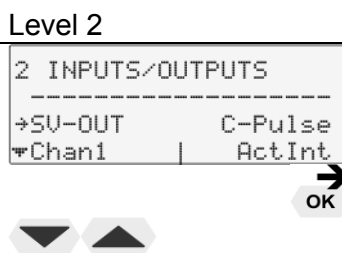

Control output (14) 230 V max. 1,25 A:

Possible parameters:

















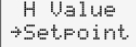

**C-Pulse, Backflow, Refill**

- The parameter flashes, switch by pressing and





Level 2	Level 3	Parameter-level
<pre> 2 INPUTS/OUTPUTS ^SV-OUT      C-Pulse -&gt;Chan1        ActInt vChan2        Power                 </pre> <p style="text-align: right;">OK →</p> <p>▼ ▲</p>	<pre> 3 Channel1 ----- -&gt;Output      ActInt v0V          = -99.90°C 10V          = 400.00°C                 </pre> <p style="text-align: right;">OK →</p> <pre> 3 Channel1 ----- -&gt;Output      ActInt v0V          = -99.90°C                 </pre> <p>▼ ▲</p>	<p>Define the output value for channel 1</p> <p>Possible parameters: <b>ActInt, ActExt, Power, Setpoint</b></p> <ul style="list-style-type: none"> <li>The parameter flashes, switch by pressing ▲ ▼ and OK</li> </ul> <pre> 3 Channel1 ----- Output      # ActInt                 </pre>
<p>▼ ▲</p>	<pre> 3 Channel1 ----- ^Output      ActInt -&gt;0V         = -99.90°C v10V        = 400.00°C                 </pre> <p style="text-align: right;">OK →</p> <p>▼ ▲</p>	<p>Select the scale for channel 1.</p> <ul style="list-style-type: none"> <li>The value flashes. Set by using the numeric keypad and confirm by pressing OK</li> </ul> <pre> 3 Channel1 ----- 0V          = -99.90°C                 </pre>
<p>▼ ▲</p>	<pre> 3 Channel1 ----- ^0V          = -99.90°C -&gt;10V        = 400.00°C                 </pre> <p style="text-align: right;">OK →</p>	<ul style="list-style-type: none"> <li>The value flashes. Set by using the numeric keypad and confirm by pressing OK</li> </ul> <pre> 3 Channel1 ----- 10V         = 400.00°C                 </pre>
<pre> 2 INPUTS/OUTPUTS ^Chan1        ActInt -&gt;Chan2        Power vChan3        Setpoint                 </pre> <p style="text-align: right;">OK →</p> <p>▼ ▲</p>	<pre> 3 Channel2 ----- -&gt;Output      Power v0V          = 0.00 % 10V          = 100.00 %                 </pre> <p style="text-align: right;">OK →</p> <pre> 3 Kanal2 ----- -&gt;Output      Power v0V          = 0.00 %                 </pre> <p>▼ ▲</p>	<p>Define the output value for channel 2.</p> <p>Possible parameters: <b>ActInt, ActExt, Power, Setpoint</b></p> <ul style="list-style-type: none"> <li>The parameter flashes, switch by pressing ▲ ▼ and OK</li> </ul> <pre> 3 Channel2 ----- Output      # Power                 </pre>
<p>▼ ▲</p>	<pre> 3 Channel2 ----- ^Output      Power -&gt;0V         = 0.00 % v10V        = 100.00 %                 </pre> <p style="text-align: right;">OK →</p> <p>▼ ▲</p>	<p>Select the scale for channel 2.</p> <ul style="list-style-type: none"> <li>The value flashes. Set by using the numeric keypad and confirm by pressing OK</li> </ul> <pre> 3 Channel2 ----- 0V          = 0.00 %                 </pre>
<p>▼ ▲</p>	<pre> 3 Channel2 ----- ^0V          = 0.00 % -&gt;10V        = 100.00 %                 </pre> <p style="text-align: right;">OK →</p>	<ul style="list-style-type: none"> <li>The value flashes. Set by using the numeric keypad and confirm by pressing OK</li> </ul> <pre> 3 Channel2 ----- 10V         = 100.00 %                 </pre>

Level 2	Level 3	Parameter-level
<div data-bbox="130 248 464 367" style="border: 1px solid black; padding: 5px;">                     2 INPUTS/OUTPUTS                      ▲ Chan2   Power                      → Chan3   Setpoint                      ▼ EPROG   Setpoint                 </div> <div data-bbox="130 439 272 477" style="margin-top: 20px;"> </div> <div data-bbox="416 376 464 421" style="margin-top: 10px;"> </div>	<div data-bbox="491 206 828 394" style="border: 1px solid black; padding: 5px;">                     3 Channel3                      -----                      →Output      Setpoint                      ▼0mA      =    -99.90°C                      20mA      =    400.00°C                      Region      0-20mA                      -----                 </div> <div data-bbox="491 412 775 546" style="border: 1px solid black; padding: 5px; margin-top: 10px;">                     3 Channel3                      -----                      →Output      Setpoint                      ▼0mA      =    -99.90°C                      -----                 </div> <div data-bbox="491 510 633 546" style="margin-top: 10px;"> </div> <div data-bbox="786 454 834 499" style="margin-top: 10px;"> </div>	<p>Define the output value for channel 3</p> <p>Possible parameters:  <b>ActInt, ActExt, Power, Setpoint</b></p> <ul style="list-style-type: none"> <li>The parameter flashes, switch by pressing   and </li> </ul> <div data-bbox="863 472 1182 566" style="border: 1px solid black; padding: 5px; margin-top: 20px;">                     3 Channel3                      -----                      Output      ◆ Setpoint                      -----                 </div>
	<div data-bbox="491 624 828 723" style="border: 1px solid black; padding: 5px;">                     3 Channel3                      -----                      ▲Output      Setpoint                      →0mA      =    -99.90°C                      ▼20mA      =    400.00°C                      -----                 </div> <div data-bbox="491 734 633 770" style="margin-top: 10px;"> </div> <div data-bbox="786 667 834 712" style="margin-top: 10px;"> </div>	<p>Select the scale for channel 3.</p> <ul style="list-style-type: none"> <li>The value flashes. Set by using the numeric keypad and confirm by pressing .</li> </ul> <div data-bbox="863 763 1182 860" style="border: 1px solid black; padding: 5px; margin-top: 20px;">                     3 Channel3                      -----                      0mA      =    -99.90°C                      -----                 </div>
	<div data-bbox="491 916 828 1014" style="border: 1px solid black; padding: 5px;">                     3 Channel3                      -----                      ▲0mA      =    -99.90°C                      →20mA      =    400.00°C                      ▼Region      0-20mA                      -----                 </div> <div data-bbox="491 1025 633 1061" style="margin-top: 10px;"> </div> <div data-bbox="786 958 834 1003" style="margin-top: 10px;"> </div>	<ul style="list-style-type: none"> <li>The value flashes. Set by using the numeric keypad and confirm by pressing .</li> </ul> <div data-bbox="863 1003 1182 1099" style="border: 1px solid black; padding: 5px; margin-top: 20px;">                     3 Channel3                      -----                      →20mA      =    400.00°C                      -----                 </div>
	<div data-bbox="491 1158 828 1256" style="border: 1px solid black; padding: 5px;">                     3 Channel3                      -----                      ▲20mA      =    400.00°C                      →Region      0-20mA                      -----                 </div> <div data-bbox="491 1267 633 1303" style="margin-top: 10px;"> </div> <div data-bbox="786 1200 834 1245" style="margin-top: 10px;"> </div>	<p>Possible parameters: <b>0-20 mA, 4-20 mA</b></p> <ul style="list-style-type: none"> <li>The parameter flashes, switch by pressing   and </li> </ul> <div data-bbox="863 1261 1145 1357" style="border: 1px solid black; padding: 5px; margin-top: 20px;">                     3 Channel3                      -----                      Region      ◆ 0-20mA                      -----                 </div> <div data-bbox="1193 1261 1476 1357" style="border: 1px solid black; padding: 5px; margin-top: 20px;">                     3 Channel3                      -----                      Region      ◆ 4-20mA                      -----                 </div>
<div data-bbox="130 1458 464 1576" style="border: 1px solid black; padding: 5px;">                     2 INPUTS/OUTPUTS                      Chan3   Setpoint                      →EPROG   Setpoint                      Ext.StBy   inactiv                 </div> <div data-bbox="130 1648 272 1686" style="margin-top: 20px;"> </div> <div data-bbox="416 1581 464 1626" style="margin-top: 10px;"> </div>	<div data-bbox="491 1370 828 1581" style="border: 1px solid black; padding: 5px;">                     3 EPROG                      -----                      →Input      Setpoint                      Signal      Voltage                      L Value    -99.90°C                      H Value    400.00°C                      Setpoint : -xx.xx°C                      -----                 </div> <div data-bbox="491 1599 775 1733" style="border: 1px solid black; padding: 5px; margin-top: 10px;">                     3 EPROG                      -----                      →Input      Setpoint                      Signal      Voltage                      -----                 </div> <div data-bbox="491 1697 633 1733" style="margin-top: 10px;"> </div> <div data-bbox="786 1653 834 1697" style="margin-top: 10px;"> </div>	<p>Possible parameters:  <b>Setpoint, variable, flow rate, pressure</b></p> <ul style="list-style-type: none"> <li>The parameter flashes, switch by pressing   and </li> </ul> <div data-bbox="863 1552 1182 1648" style="border: 1px solid black; padding: 5px; margin-top: 20px;">                     3 EPROG                      -----                      Input      ◆ Setpoint                      -----                 </div> <div data-bbox="863 1659 1145 1756" style="border: 1px solid black; padding: 5px; margin-top: 10px;">                     3 EPROG                      -----                      Input      ◆ Variable                      -----                 </div> <div data-bbox="863 1767 1145 1863" style="border: 1px solid black; padding: 5px; margin-top: 10px;">                     3 EPROG                      -----                      Input      ◆ Flowrate                      -----                 </div> <div data-bbox="863 1874 1145 1971" style="border: 1px solid black; padding: 5px; margin-top: 10px;">                     3 EPROG                      -----                      Input      ◆ Pressure                      -----                 </div>

Menu functions

Level 2	Level 3	Parameter-level
	<pre> 3 EPROG Input      Setpoint →Signal    Voltage L Value    -99.90°C           </pre> 	<p>Possible parameters: <b>voltage, current</b></p> <ul style="list-style-type: none"> <li>The parameter flashes, switch by pressing   and </li> </ul> <pre> 3 EPROG ----- Signal  ⚡ Voltage -----           </pre> <pre> 3 EPROG ----- Signal  ⚡ Current -----           </pre>
	<pre> 3 EPROG Signal    Voltage →L Value  -99.90°C H Value   400.00°C           </pre> 	<ul style="list-style-type: none"> <li>The value flashes. Set by using the numeric keypad and confirm by pressing  .</li> </ul> <pre> 3 EPROG ----- L Value  -99.90°C -----           </pre>
	<pre> 3 EPROG L Value   -99.90°C →H Value  400.00°C Setpoint : -xx.xx°C           </pre> 	<ul style="list-style-type: none"> <li>The value flashes Set by using the numeric keypad and confirm by pressing  .</li> </ul> <pre> 3 EPROG ----- H Value  400.00°C -----           </pre>
	<pre> 3 EPROG H Value   400.00°C →Setpoint : -xx.xx°C           </pre> 	<p> The value &gt;setpoint&lt; is only indicated.</p> <pre> 3 EPROG ----- Setpoint : -xx.xx°C -----           </pre>
<pre> 2 INPUTS/OUTPUTS EPROG     Setpoint →Ext.StBy   inactiv AlarmOut   StdBy           </pre> 	<p>(Parameter Level)</p> <pre> 2 INPUTS/OUTPUTS ----- →Ext.StBy ⚡ activ -----           </pre> <pre> 2 INPUTS/OUTPUTS ----- →Ext.StBy ⚡ inactiv -----           </pre> 	<p>Possible parameters: <b>inactive, active</b></p> <ul style="list-style-type: none"> <li>The parameter flashes, switch by pressing   and </li> </ul>
<pre> 2 INPUTS/OUTPUTS Ext.StBy    inactiv →AlarmOut   StdBy           </pre>	<pre> 3 ALARM OUTPUT ----- →Function StdBy TYPE      normal           </pre> 	<p>Possible parameters: <b>Alarm, Stand By, Alarm+ Stand By</b></p> <ul style="list-style-type: none"> <li>The parameter flashes, switch by pressing   and </li> </ul> <pre> 3 ALARM OUTPUT ----- →Function ⚡ Alarm -----           </pre> <pre> 3 ALARM OUTPUT ----- →Function ⚡ StdBy -----           </pre> <pre> 3 ALARM OUTPUT ----- →Function ⚡ Al+StdBy -----           </pre>



Level 2	Level 3	Parameter-level
	<pre> 3 ALARM OUTPUT Function      StdBy -&gt;TYPE        normal -----           </pre> 	<p>Possible parameters: <b>normal, inverse</b></p> <ul style="list-style-type: none"> <li>The parameter flashes, switch by pressing   and </li> </ul> <pre> 3 ALARM OUTPUT ----- TYPE      ⚡ normal -----           </pre>  <pre> 3 ALARM OUTPUT ----- TYPE      ⚡ invers -----           </pre>

### 9.9.1. Control connector

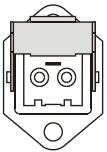

#### Control connector (14):

##### SV-Out >Backflow< or >C-Pulse< or >Refill<

The control output (14) can be adapted to solenoid valves for different tasks.

>**Backflow**< In the OFF condition, the control output (14) is not powered.

See – Backflow safety device- on page 25

>**C-Pulse**< The control output (14) can be used to emit a cooling pulse. For the pulsing period, the output is powered.

(only used with Heating Circulators)

>**Refill**< Control of a - Automatic Refill Device - (Accessories)

9.9.2. Outputs of the connector - REG+E-PROG

Outputs of the connector

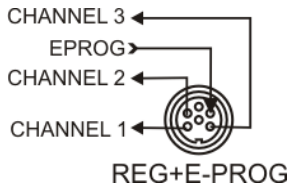

1. First define the desired output value for channels 1 to 3:

**ActInt** internal actual temperature value (bath temperature)  
**ActExt** external actual temperature value (external sensor)  
**Power** periodic or intermittent heating or cooling  
**Setpoint** active setpoint temperature  
 (setpoint 1, 2, 3/integr. programmer/external programmer)

2. Then select the scale for channels 1 to 3:

**Voltage outputs channels 1 and 2**

Assign the voltage values of 0 V to the lowest and 10 V to the highest necessary temperature or power rating required as an output value (°C/%).

**Current output channel 3**

Assign the current values 0 mA or 4 mA to the lowest and 20 mA to the highest temperature or power rating required as an output value (°C/%).

3. The current output (channel 3) offers 2 ranges for selection:  
 0 to 20 mA or 4 to 20 mA

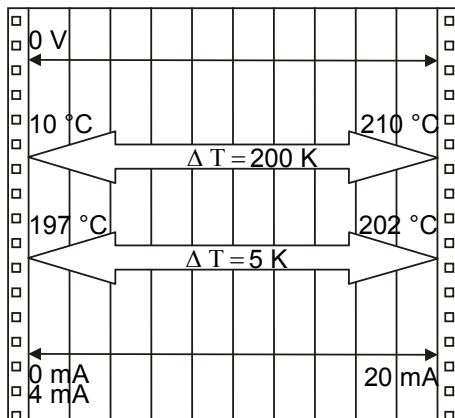

```

3 Channel1
*Output      ActInt
→0V          =    10.00°C
↔10V         =   210.00°C
    
```

Examples:

lowest temperature value: 10 °C  
 highest temperature value 210 °C  
 Fig. shows 200 °C scaled to paper width  
 slope: 50 mV/°C

lowest temperature value: 197 °C  
 highest temperature value: 202 °C  
 Fig. shows 5 °C scaled to paper width  
 slope: 2000 mV/°C

### 9.9.3. Input of the connector - REG+E-PROG

Menu >Configuration<

```

2 CONFIGURATION
+Remote          off
+Setpoint ext    Eprog
-Autostart       off

```

1.

```

2 CONFIGURATION
+Off-Mode        P. off
+ActVar          Eprog
-Time/Date

```

2.

Menu >Inputs/Outputs<

```

2 INPUTS/OUTPUTS
Chan3 | Setpoint
+EPROG | Flowrate
Ext.StBy | inactiv

```

3.

2 CONFIGURATION

```

-----
+Remote          off
Setpoint ext    Eprog
Autostart       off
Off-Mode        P. off
ActVar          Eprog
Time/Date

```

#### E-PROG - Input

Setting is necessary if

1. the Setpoint is to be set via an external voltage or current source or programmer  
For this, in the menu >Configuration<, first set the menu item >Setpoint< to >Eprog<.
2. the heater variable should be controlled via an external control pulse.  
For this, in the menu >Configuration<, set the menu item >ActVar.< to >Eprog<.
3. the signal of an external flow meter should be registered.

❗ The E-Prog input can only be used either under menu item >Setpoint< or under menu item > Actvar <. If the input is occupied neither by >Setpoint< or > ActVar <, the signal of a flow meter can be connected.

❗ First set menu >Configuration<, then menu >Inputs/Outputs<.

- Connect the external voltage or current source or programmer to the REG+E-PROG socket (12) of the circulator.

#### Selecting the signal:

The programmer (E-PROG) input of the circulator can be matched to the output signal of the external voltage or current source.

**Voltage**            voltage input  
**Current**            current input

Example:

```

3 EPROG
-----
+Input          Setpoint
Signal          Current
L Value         0.00°C
H Value         300.00°C
Setpoint :     50.00°C
-----

```

#### “L Value” - Setting the LOW value: (See below ↻)

First adjust and set the lowest voltage or current on the external voltage or current source (e.g., 0 V or 0 mA).

Then after approx. 30 seconds, enter the corresponding temperature value (e.g., 20.00°C) on the circulator by pressing the appropriate keys on the keypad and press **OK** to set.

#### “H Value” - Setting the HIGH value: (See below ↻)

First adjust and set the highest voltage or current on the external voltage or current source (e.g., 10 V or 20 mA).

Then after approx. 30 seconds, enter the corresponding temperature value (e.g., 300 °C) on the circulator by pressing the appropriate keys on the keypad and press **OK** to set.

#### Example:

- ❗ Set the external voltage or current source output for the equivalent of a 50 °C temperature setpoint.  
The value adjusted and set on the external programmer is displayed in line 4 of the LCD DIALOG-DISPLAY for inspection.



Menu functions

```
Setpoint1: 50.00°C
IntAct : 24.64°C
Power : 0 %
Control : intern
```

ⓘ After returning the LCD display to standard display by pressing the key , the temperature value adjusted and set on the external voltage or current source is displayed in line 1 (Example: Eprog 50.00 °C).

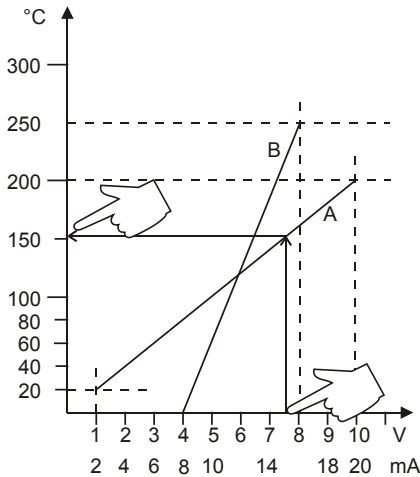
This EPROG input enables the use of different voltage and current values as program parameters.



- **“L Value” - Setting the Low value:** (See below )
  - 1) Adjust and set the lowest desired value on the voltage or current source (Example A: 1 V). Wait approximately 30 seconds.
  - 2) Assign a lower temperature threshold value to this adjusted voltage/current value by pressing the appropriate keys on the keypad of the instrument (Example A: 20 °C) and set by pressing **OK**.
- **“H Value” - Setting the High value:** (See below )
  - 1) Adjust and set the highest desired value on the voltage or current source (Example A: 10 V). Wait approximately 30 seconds.
  - 2) Assign an upper temperature threshold value to this adjusted voltage/current value by pressing the appropriate keys on the keypad of the instrument (Example A: 200 °C) and set by pressing **OK**.

ⓘ Example B in the diagram illustrates that the end point values are freely selectable (e.g., 8 mA and 16 mA).

```
3 EPROG
-----
+Input Setpoint
Signal Voltage
L Value 20.00°C
H Value 000.00°C
Setpoint : 152.00°C
-----
```



```
Setpoint1: 152.00°C
IntAct : 50.64°C
Power : 100 %
Control : intern
```

**Example out of diagram A:**

- Adjusting the voltage source for an output of 7.6 V!

Line 5 of the LCD DIALOG-DISPLAY shows the externally set setpoint value. The instrument calculates this value from the slope of the two specified end points (in example A, 7.6 V corresponds to an external setpoint temperature of 152.0 °C).

After returning the LCD display to standard display by pressing , this value is displayed in line 1 (Example: EPROG 152.00 °C).



**Notice:**

If this adjustment is not correctly performed at two different points, the setpoint setting will be incorrect.



**Important:**

The usable temperature range between > **L Value** < and > **H Value** < is limited to the configured working temperature range of the circulator or unit combination. For the working temperature range, see technical specifications.

### 9.9.4. External Stand-by input

```

2 INPUTS/OUTPUTS
EPROG   | Setpoint
→Ext.StBy | inactiv
AlarmOut | StdBy

```

#### Ext. StBy (External STAND-BY input)

Stand-By input for external switch-off.

#### Possible parameters:

**inactive** - Stand-By input is ignored

**active** - Stand-By input is active

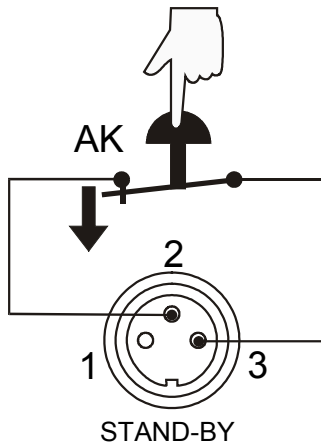

```

Setpoint : XX.XX° C
IntAct   : XX.XX° C
Power    : 0 %
Stand-By

```

```

E OFF
S XXXX
I XXXX

```

#### Activate the standby input:

1. Under menu item **>Ext. StBy<**, set the parameter to **>active<**.
2. Connect an external contact "AK" (e.g., for external switch-off) or an alarm contact of the superordinated system.

If the connection between pin 2 and pin 3 is interrupted by opening the contact "AK", a complete shutdown of the circulating pump and heater is effected, and the unit enters the condition "E OFF".

As long as the contact remains open, line 4 of the LCD DIALOG-DISPLAY flashes and displays the message "Stand-By".

If the contact is reclosed, the instrument returns to the standby state and "E OFF" is displayed. Press **OK** to start.

#### **ⓘ Additional tips for using the STAND-BY input:**

The standby function can be used in conjunction with the AUTOSTART feature.

1. If the Autostart function is NOT turned ON, the standby input is used as described above.
2. If the Autostart function is enabled, the instrument will revert back to the original method of entering the setpoint (i.e., keypad, RS232, analog input, etc.).

#### Entering the setpoint with the keypad. e.g., **T**

As described above, a complete shutdown is accompanied by the "Stand-By" display and the OFF state. The programmable controller starts again when the contact is reclosed. The temperature of the bath fluid changed during the Stand-By state.

#### Entering the setpoint with the programmer.

The display "StandBy" appears. The setpoint value and the time are both held at the current value. The temperature of the bath fluid will be held constant at this temperature. The programmer continues once the contact is reclosed.



**Notice: this is not an actual emergency switch-off.**

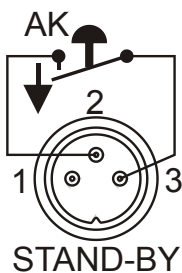

```

Set      : XX.XX° C
IntAct   : XX.XX° C
ProgNr.:2 Step: 2
***** StandBy *****

```

9.9.5. Alarm-output

```

2 INPUTS/OUTPUTS
Ext.StBy   inactiv
→AlarmOut |   StdBy
-----
    
```

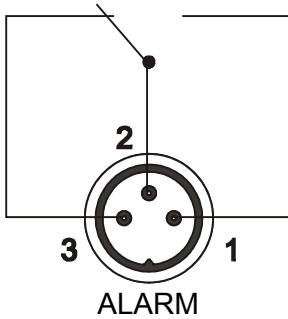

**Alarm output (10)**

(for external alarm signal)

This socket is a potential-free change-over contact. With the adjustments in the menu >Inputs/Outputs<, all operating conditions can be signaled without having to change the pin assignments.

```

3 ALARM OUTPUT
Function   StdBy
→TYPE     normal
-----
    
```

```

3 ALARM OUTPUT
TYPE      ⚡ normal
-----
    
```

```

3 ALARM OUTPUT
TYPE      ⚡ invers
-----
    
```

Meaning of the terms under menu item >Function< :

The circulator is in condition

```

3 ALARM OUTPUT
-----
→Function ⚡ StdBy
-----
    
```

```

3 ALARM OUTPUT
-----
→Function ⚡ Alarm
-----
    
```

>StandBy< or

>Alarm<

```

- OFF -
S  50.00
I  2464
    
```

```

- OFF -
ALARM
CODE 14
    
```

For >Type: normal<, pins 2 and 3 are connected in any case according to the selected >Function<.

For >Type: inverse<, pins 2 and 1 are connected in any case according to the selected >Function<.

- Switching capacity max. 30 W/40 VA
- Switching voltage max. 125 V~/-
- Switching current max. 1 A

## 10. Troubleshooting guide / Error messages

**-OFF-**  
ALARM  
CODE 01



00.000  
WARNING  
CODE 40

### Alarm with complete shutdown:

If one of the following failures occur a complete, all-pole shutdown of the heater and circulating pump is effected.

„“ lights up and a continuous signal sounds.

The code for the cause of alarm is indicated on the VFD COMFORT-DISPLAY.

### Alarm without shutdown:

The code for the cause of alarm is indicated on the VFD COMFORT-DISPLAY. The warning signal sounds in regular intervals. The messages appear every 10 seconds.



- Press the key **OK** to stop the signal
- Press **OK** to indicate the help text in the LCD DIALOG-DISPLAY when alarm messages appear.

ALARM  
CODE 01

Low liquid level or float broken. Check float and fill medium!

The circulator is operated without bath fluid, or the liquid level is insufficient. Replenish the bath tank with the bath fluid.

Tube breakage has occurred (insufficient filling level due to excessive bath fluid pumped out). Replace the tubing and replenish the bath tank with the bath fluid.

The float is defect (e. g., because damaged in transit). Repair by authorized JULABO service personnel.

ALARM  
CODE 02

Control cable of the cooling machine is defective. Check connection!

During the self-test after switch-on a short-circuit is registered between pin 2 and pin 4 of the control cable or the control cable is interrupted during operation.

Reconnect the cable or eliminate the short-circuit.

WARNING  
CODE 03

ALARM  
CODE 03

Actual temperature above high temperature value. Check limits!

- Excess temperature warning or Excess temperature alarm

**Warn-Type:** Set to >Warning< or >Alarm<

WARNING  
CODE 04

ALARM  
CODE 04

Actual temperature below low temperature value. Check limits!

- Low temperature warning or Low temperature alarm.

**Warn-Type:** Set to >Warning< or >Alarm<

ALARM  
CODE 05

Internal working sensor is shorted or interrupted. Call service!

The cable of the working temperature sensor is disconnected or short-circuited.

ALARM  
CODE 06

Sensor difference b. working- and safety-temp. Check PUMP stage and viscosity!

Defect of the working or excess temperature sensor.  
The working temperature and excess temperature sensors report a temperature difference of more than 35 K.

---

ALARM  
CODE 07

Internal hardware error.  
Call service!

Other errors (I<sup>2</sup>C-BUS errors)

---

ALARM  
CODE 12

Error in A/D converter of the measuring system.  
Call service!

Error in A/D converter

---

ALARM  
CODE 14

Temperature exceeds the adjusted safety-temperature.  
Check adjustment!

Excess temperature sensor is defective.  
The safety temperature is below the working temperature setpoint. Set the safety temperature to a higher value.

---

ALARM  
CODE 15

External sensor is not connected or broken. Check the external sensor!

External control selected, but external Pt100 sensor is not connected or is defective.

---

WARNING  
CODE 20

Cooling of the condenser is impaired. Clean the air-cooled condenser.  
For a water-cooled condenser, check the flow rate and temperature of the cooling water.

---

WARNING  
CODE 21

The first-stage compressor does not work.  
After a short cooling interval, the compressor motor will be automatically reconnected and the message "CODE 21" will no longer appear.

---

WARNING  
CODE 22

The second-stage compressor does not work.  
Cooling compressor overload protection  
The motor of the cooling compressor is equipped with an overload protector, which will be activated in case of excessive temperature in the capsule or excessive current draw.  
Causes of motor shut-off:  
- poor air circulation  
- short distance to walls  
- dirt accumulated on condenser  
- high ambient temperature  
- compressor switched off and on at short intervals

---

WARNING  
CODE 23

Excess temperature in the first-stage compressor.

---

WARNING  
CODE 24

Excess temperature in the second-stage compressor.

---



WARNING  
CODE 25

Short-circuit in the control cable for the cooling machine during self-test.

ALARM  
CODE 33

Cable of the excess temperature sensor disconnected or short-circuited.

Internal safety-  
temperature sensor  
shorted/interrupted.  
Call service!

ALARM  
CODE 38

Ext. Pt100 sensor input without signal, but setpoint programming set to external Pt100.

Ext. sensor input  
without signal but  
setpoint programming  
set to ext. Pt100!

WARNING  
CODE 40

The early warning system for low level signals a critical fluid level.  
Replenish the bath tank with bath fluid.

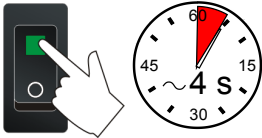

After eliminating the malfunction, turn the mains power switch off and on again to cancel the alarm state.  
If the unit cannot be returned to operation, contact an authorized JULABO service center.

CONFIGURATION  
ERROR  
CONFIRM BY  
PRESSING : <OK>

Special message "CONFIGURATION ERROR"  
The configuration of the circulator does not correspond to its present use.  
Press **OK** to automatically perform a one-time modification of the configuration.  
Then contact an authorized JULABO service center.

**Disturbances that are not indicated.**

The electronic pump motor is protected against overload by an electronic current limiter. If the viscosity of the bath fluid is or becomes too high, the motor stops running.

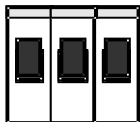

Cooling machine: Mains circuit breakers (resettable) 16 A

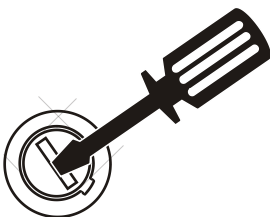

**Fuses:**

The mains fuses on the rear of the unit may easily be replaced as shown at left.

Circulator: Fine fuses (15)– T 1.25 A, 250 V~ , D 5 x 20 mm

Circulator: Fine fuses (16a)– T 16 A, 250 V~ , D5 x 20 mm



**Warning:**

Before exchanging the fuses, turn off the mains power switch and disconnect the power plug from the mains socket!

Only use fine fuses with a nominal value as specified.

Example:

Manufacturer	Supplier	Type	Order-No.
Schurter	Schurter	G-fuse link SPT T16A 5x20mm	No. 0001.2516
Wickmann	Wickmann	G-fuse link T1,25A 5x20 mm	No. 19195

## 11. Electrical connections



**Notice:**

Use shielded cables only.  
 The shield of the connecting cable is electrically connected to the plug housing.  
 The unit ensures safe operation if connecting cables with a maximum length of 3 m are used. The use of longer cables does not affect proper performance of the unit, however external interferences may have a negative impact on safe operation (e.g. cellular phones).

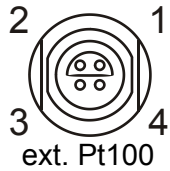

**Socket for external Pt100 sensor**

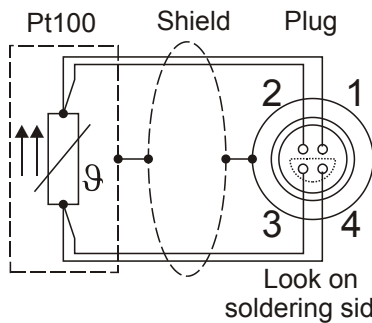

Pin assignment:

Pin	Signal
1	I+
2	U+
3	U-
4	I-

The shield of the connecting cable is electrically connected to the plug housing and the sensor tube.



**RS232/RS485 serial interface**

This port can be used to connect a computer with an RS232 or RS485 cable for remote control of the circulator.

**Pin assignments RS232:**

Pin 2	RxD	Receive Data
Pin 3	TxD	Transmit Data
Pin 5	0 V	Signal GND
Pin 7	RTS	Request to send
Pin 8	CTS	Clear to send

Pin 1; 4; 6, 9 Reserved - do not use!

**Pin assignments RS485:**

Pin 3	B
Pin 5	0 V                      Signal GND
Pin 6	+5 V (max. 50 mA)
Pin 8	A

Pin 1; 2; 4; 7; 9 Reserved - do not use!



**Notice: RS485 serial interface**

The max. load current between pin 5 and pin 6 is 50 mA.

RS232 interface cable

Circulator (9-pol)		PC (9-pol)	
Pin 2 RxD	↔	Pin 3 TxD	
Pin 3 TxD	↔	Pin 2 RxD	
Pin 5 GND	↔	Pin 5 GND	
Pin 7 RTS	↔	Pin 8 CTS	
Pin 8 CTS	↔	Pin 7 RTS	

Accessories:	Order No.	Description
	8 980 073	RS232 interface cable 9-pol./9-pol. , 2,5 m
	8 900 110	USB interface adapter cable

 / Control output

The connector may only be used for control of a JULABO refrigerated circulator or JULABO MVS Solenoid valve controller for cooling water.

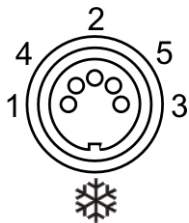

Pin assignment:

Pin	Signal (only with attached JULABO equipment)
1	+24 V (I max. current 25 mA)
2	0 V
3	Alarm relay
4	Reserved - do not use!
5	Cooling pulse

**Alarm output**

(for external alarm signal)

This potential-free change-over contact is activated in case of an alarm when pins 2 and 3 are connected.

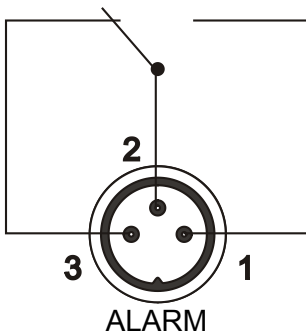

Switching capacity	max.	30 W / 40 VA
Switching voltage	max.	125 V~/–
Switching current	max.	1 A

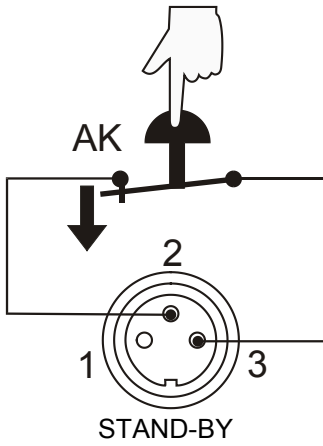

**Stand-by input**  
(for external switch-off)

Pin assignment:	Pin	Signal
	1	not connected
	2	5 V / DC
	3	0 V

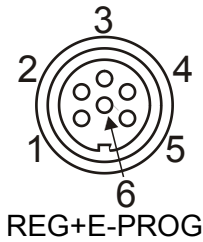

**Programmer input / temperature recorder output**

Pin	Signal
1 Voltage output Channel 1	0 ... 10 V
2 Voltage output Channel 2	0 ... 10 V
3 GND for outputs	0 V
4 Programmer input EPROG	0 to 10 V / 0 to 20 mA
5 Current output Channel 3	0 to 20 mA / 4 to 20 mA
6 GND for Programmer	0 V

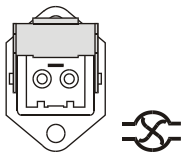

**Control connectors (13, 14)**

The control output (13) is not powered in the OFF condition.  
An external pump motor can be connected.  
Output voltage: 230 V~ / max. 1.25 A

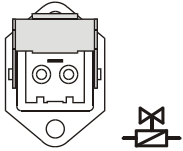

The control output (14) can be adapted to solenoid valves for different tasks.

## 12. Remote control

### 12.1. Setup for remote control

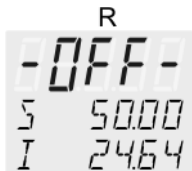

1. Check the interface parameters for both interfaces (on the circulator and PC) and make sure they match.  
In the >Interface< menu, set the menu item >Type< to >RS232< or >RS485<.
2. In the >Configuration< menu, set the menu item >Setpoint< to >RS232< or >RS485<.
3. Connect both units with an interface cable.



Like all parameters that can be entered through the keypad, interface parameters are stored in the memory even after the circulator is turned off.

### 12.2. Communication with a PC or a superordinated data system

If the circulator is put into remote control mode via the configuration level, the VFD COMFORT-DISPLAY will read "R -OFF-" = REMOTE STOP. The circulator is now operated via the computer.  
In general, the computer (master) sends commands to the circulator (slave). The circulator sends data (including error messages) only when the computer sends a query.



In remote control mode, the start command and all values to be set must be resent by the PC via the interface in case of a power interruption.  
AUTOSTART is not possible.

A transfer sequence consists of:

- address (RS485 interface only)
  - command
  - space (↔; Hex: 20)
  - parameter (decimal separation with a period)
  - end of file (↵; Hex: 0D)
- The response (data string) after an **IN** command is always followed by a line feed (LF, Hex: 0A).

The commands are divided into **in** or **OUT** commands.

**IN** commands: retrieve parameters

**OUT** commands: set parameters



**Important times for a command transmission:**

To ensure secure data transfer, the time gap between two commands should be at least 250 ms.

The circulator automatically responds to an **in** command with a data string followed by an LF (Line Feed). The next command should be sent only after 10 ms.



The **OUT** commands are valid only in remote control mode.

Examples:

When the RS485 interface is used, the three-digit instrument address precedes each command.

(example: address Ad32 = **A032**)

Command to set the working temperature >Setpoint1< to 55.5 °C

**OUT\_SP\_00 ↔ 55.5↵**

**A032\_OUT\_SP\_00 ↔ 55.5↵**

Command to retrieve the working temperature >Setpoint1<

**IN\_SP\_00↵**

**A032\_IN\_SP\_00↵**

Response from the circulator:

**55.5↵ LF**

**A032\_55.5↵ LF**



**Notice: OUT commands**

Temperature values can be displayed on the circulator in °C or °F.

The settings sent via the interface must also be made in the selected unit according to this setting.

**12.3. List of commands**

**OUT commands: Setting parameters or temperature values.**

Command	Parameter	Response of circulator
<b>OUT_MODE_01</b>	0	Use working temperature >Setpoint1<
<b>OUT_MODE_01</b>	1	Use working temperature >Setpoint2<
<b>OUT_MODE_01</b>	2	Use working temperature >Setpoint3<
<b>OUT_MODE_02</b>	0	Selftuning “off”. Temperature control using the stored parameters.
<b>OUT_MODE_02</b>	1	Selftuning “once” Single selftuning of the controlled system after the next start.
<b>OUT_MODE_02</b>	2	Selftuning “always” Continual selftuning of the controlled system whenever a new setpoint is to be reached.

Command	Parameter	Response of circulator
OUT_MODE_03	0	Set external programmer input to voltage. Voltage 0 V ... 10 V
OUT_MODE_03	1	Set external programmer input to current. Current 0 mA ... 20 mA
OUT_MODE_04	0	Temperature control of internal bath.
OUT_MODE_04	1	External control with Pt100 sensor.
OUT_MODE_05	0	Stop the unit = R -OFF-.
OUT_MODE_05	1	Start the unit.
OUT_MODE_08	0	Set the control dynamics - aperiodic
OUT_MODE_08	1	Set the control dynamics - standard
OUT_SP_00	xxx.xx	Set working temperature. "Setpoint 1"
OUT_SP_01	xxx.xx	Set working temperature. "Setpoint 2"
OUT_SP_02	xxx.xx	Set working temperature. "Setpoint 3"
OUT_SP_03	xxx.xx	Set high temperature warning limit "OverTemp"
OUT_SP_04	xxx.xx	Set low temperature warning limit "SubTemp"
OUT_SP_06	xxx.xx	Set manipulated variable for heater via serial interface -100 ... +100 [%]
OUT_SP_07	x	Set the pump pressure stage. (1 ... 4)
OUT_PAR_04	x.x	CoSpeed for external control 0 ... 5.0.
OUT_PAR_06	xxx	Xp control parameter of the internal controller. 0.1 ... 99.9
OUT_PAR_07	xxx	Tn control parameter of the internal controller. 3 ... 9999
OUT_PAR_08	xxx	Tv control parameter of the internal controller. 0 ... 999
OUT_PAR_09	xxx	Xp control parameter of the cascade controller. 0.1 ... 99.9
OUT_PAR_10	xxx	Proportional share of the cascade controller. 1 ... 99.9
OUT_PAR_11	xxx	Tn control parameter of the cascade controller. 3 ... 9999
OUT_PAR_12	xxx	Tv control parameter of the cascade controller. 0 ... 999
OUT_PAR_13	xxx	Maximum internal temperature of the cascade controller.
OUT_PAR_14	xxx	Minimum internal temperature of the cascade controller.
OUT_PAR_15	xxx	Band limit (upper) 0 ... 200 °C
OUT_PAR_16	xxx	Band limit (lower) 0 ... 200 °C
OUT_HIL_00	-xxx	Set the desired maximum cooling power (0% to 100%). <b>Note:</b> Enter the value with a preceding negative sign! This setting is meaningful only for FP cooling machines.
OUT_HIL_01	xxx	Set the desired maximum heating power (10% to 100%).

**IN commands:** Asking for parameters or temperature values to be displayed.

Command	Parameter	Response of circulator
VERSION	None	Version number of the software (V X.xx)
STATUS	none	Status message, error message (see page 90)
IN_PV_00	none	Current bath temperature.
IN_PV_01	none	Heating power being used (%).
IN_PV_02	none	Temperature value registered by the external Pt100 sensor.
IN_PV_03	none	Temperature value registered by the safety sensor.
IN_PV_04	none	Setpoint temperature ("SafeTemp") of the excess temperature protection
IN_SP_00	none	Working temperature "Setpoint 1"
IN_SP_01	none	Working temperature "Setpoint 2"
IN_SP_02	none	Working temperature "Setpoint 3"
IN_SP_03	none	High temperature warning limit "OverTemp"
IN_SP_04	none	Low temperature warning limit "SubTemp"
IN_SP_05	none	Setpoint temperature of the external programmer (REG+E-PROG).
IN_SP_06	none	Temperature indication in °C or °F
IN_SP_07	none	1. Adjusted pump stage in the -OFF- condition. 2. Pump stage corresponding to the effective rotational speed after start.
IN_SP_08	none	Value of a flow rate sensor connected to the E-Prog input
IN_SP_09	none	Value of a pressure sensor connected to the E-Prog input
IN_PAR_00	none	Temperature difference between working sensor and safety sensor
IN_PAR_01	none	Te - Time constant of the external bath.
IN_PAR_02	none	Si - Internal slope
IN_PAR_03	none	Ti - Time constant of the internal bath.
IN_PAR_04	none	CoSpeed - Band limit (max. difference between the temperatures in the internal bath and external system).
IN_PAR_05	none	Factor pk/ph0: Ratio of max. cooling capacity to max. heating capacity
IN_PAR_06	none	Xp control parameter of the internal controller.
IN_PAR_07	none	Tn control parameter of the internal controller.
IN_PAR_08	none	Tv control parameter of the internal controller.
IN_PAR_09	none	Xp control parameter of the cascade controller.
IN_PAR_10	none	Proportional share of the cascade controller.
IN_PAR_11	none	Tn control parameter of the cascade controller.



<b>Command</b>	<b>Parameter</b>	<b>Response of circulator</b>
<b>IN_PAR_12</b>	none	Tv control parameter of the cascade controller.
<b>IN_PAR_13</b>	none	Adjusted maximum internal temperature of the cascade controller.
<b>IN_PAR_14</b>	none	Adjusted minimum internal temperature of the cascade controller.
<b>IN_PAR_15</b>	none	Band limit (upper)
<b>IN_PAR_16</b>	none	Band limit (lower)
<b>IN_MODE_01</b>	none	Selected setpoint: 0 = Setpoint 1 1 = Setpoint 2 2 = Setpoint 3
<b>IN_MODE_02</b>	none	Selftuning type: 0 = Selftuning "off" 1 = Selftuning "once" 2 = Selftuning "always"
<b>IN_MODE_03</b>	none	Type of external programmer input: 0 = Voltage 0 V to 10 V 1 = Current 0 mA to 20 mA
<b>IN_MODE_04</b>	none	Internal/external temperature control: 0 = Temperature control with internal sensor. 1 = Temperature control with external Pt100 sensor.
<b>IN_MODE_05</b>	none	Circulator in stop/start condition: 0 = stop 1 = start
<b>IN_MODE_08</b>	none	Adjusted control dynamics 0 = aperiodic 1 = standard
<b>IN_HIL_00</b>	none	Max. cooling power (%).
<b>IN_HIL_01</b>	none	Max. heating power (%).

## 12.4. Status messages

Status messages	Description
<b>00 MANUAL STOP</b>	Circulator in „OFF“ state.
<b>01 MANUAL START</b>	Circulator in keypad control mode.
<b>02 REMOTE STOP</b>	Circulator in „r OFF“ state.
<b>03 REMOTE START</b>	Circulator in remote control mode.

## 12.5. Error messages

Error messages	Description
<b>-01 LOW LEVEL ALARM</b>	Low liquid level alarm
<b>-02 REFRIGERATOR ALARM</b>	Control cable of the refrigerated circulator or MVS solenoid valve controller short-circuited or disconnected.
<b>-03 EXCESS TEMPERATURE WARNING</b>	High temperature warning
<b>-04 LOW TEMPERATURE WARNING</b>	Low temperature warning.
<b>-05 WORKING SENSOR ALARM</b>	Working temperature sensor short-circuited or disconnected.
<b>-06 SENSOR DIFFERENCE ALARM</b>	Sensor difference alarm. Working temperature and safety sensors report a temperature difference of more than 35 K.
<b>-07 I<sup>2</sup>C-BUS ERROR</b>	Internal error when reading or writing the I <sup>2</sup> C bus.
<b>-08 INVALID COMMAND</b>	Invalid command.
<b>-09 COMMAND NOT ALLOWED IN CURRENT OPERATING MODE</b>	Invalid command in current operating mode.
<b>-10 VALUE TOO SMALL</b>	Entered value too small.
<b>-11 VALUE TOO LARGE</b>	Entered value too large.
<b>-12 TEMPERATURE MEASUREMENT ALARM</b>	Error in A/D converter.
<b>-13 WARNING : VALUE EXCEEDS TEMPERATURE LIMITS</b>	Value lies outside the adjusted range for the high and low temperature warning limits. But the value is stored.
<b>-14 EXCESS TEMPERATURE PROTECTOR ALARM</b>	Excess temperature protector alarm
<b>-15 EXTERNAL SENSOR ALARM</b>	External control selected, but external Pt100 sensor not connected.

Error messages	Description
<b>-20 WARNING: CLEAN CONDENSOR OR CHECK COOLING WATER CIRCUIT OF REFRIGERATOR</b>	Cooling of the condenser is impaired. Clean air-cooled condenser. Check the flow rate and cooling water temperature for a water-cooled condenser.
<b>-21 WARNING: COMPRESSOR STAGE 1 DOES NOT WORK</b>	First-stage compressor does not work.
<b>-22 WARNING: COMPRESSOR STAGE 2 DOES NOT WORK</b>	Second-stage compressor does not work.
<b>-23 WARNING: HIGH TEMPERATURE ON COMPRESSOR STAGE 1</b>	Excess temperature at first-stage compressor.
<b>-24 WARNING: HIGH TEMPERATURE ON COMPRESSOR STAGE 2</b>	Excess temperature at second-stage compressor.
<b>-25 REFRIGERATOR WARNING</b>	Error in the cooling machine.
<b>-26 WARNING: STAND-BY PLUG IS MISSING</b>	External standby contact is open.
<b>-30 CONFIGURATION ERROR: CONFIRM BY PRESSING &lt;OK&gt; ON CIRCULATOR</b>	The configuration of the circulator does not correspond to its present use. Press OK to automatically perform a one-time modification of the configuration.
<b>-33 SAFETY SENSOR ALARM</b>	Excess temperature sensor short-circuited or disconnected.
<b>-38 EXTERNAL SENSOR SETPOINT PROGRAMMING ALARM</b>	Ext. Pt100 sensor input without signal and setpoint programming set to external Pt100.
<b>-40 NIVEAU LEVEL WARNING</b>	Low liquid level warning in the internal reservoir.

### 13. Installation of electronic module with analog connectors



#### **Caution:**

Always turn off the unit and disconnect the mains cable from the power source before performing any service or maintenance procedures, or before moving the unit. Configuration, installation, maintenance, and repairs on the circulator may be performed only by qualified personnel.

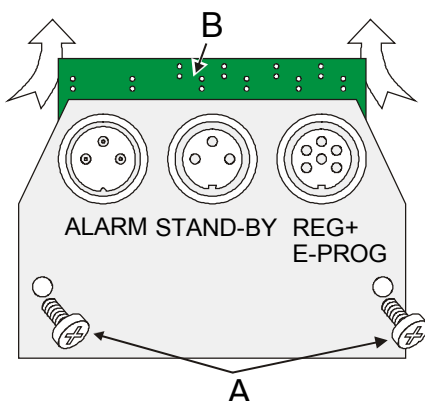

- Turn off the unit with the mains switch and disconnect the power plug.
- Remove the screws (A) and remove the dummy plate.
- Carefully insert the upper edge (B) into the rear panel from below, align the electronic module at the top and bottom, and connect the 15-pin connector by applying light pressure.
- Attach the electronic module using the screws (A).
- The circulator is ready for use. It automatically recognizes the installed electronic module.

## 14. JULABO Service – Online remote diagnosis

JULABO circulators of the HighTech series are equipped with a black box. This box is implemented in the controller and records all significant data for the last 30 minutes.

In case of a failure, this data can be read out from the unit by using special software. This software is available as a **free** download from [www.julabo.com](http://www.julabo.com) \ EasyBlackBox.

- Installation is easy and is performed step by step.  
Please observe the instructions.
- Data read-out is possible in the conditions “OFF”, “R OFF” or “ALARM”.
- Connect the circulator to the computer using an interface cable.
- Start the EasyBlackBox program.  
The program asks for the port used (COM1, .....)  
and the baud rate of the unit.  
You do not have this information on hand?  
Simply try it out!  
The program continues to send the request until the correct settings are made.

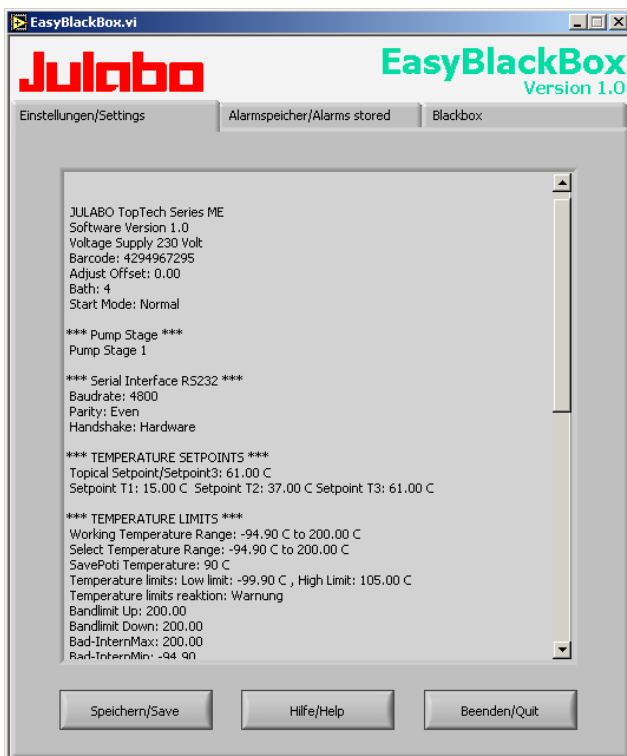

- Data is read out and shown on the monitor divided into the sections  
>Einstellungen/Settings<,  
>Alarmspeicher/Alarms stored<,  
>Blackbox<  
  
← see example
- After pressing >Speichern/Save<, a text file is created. The program suggests a filename - >C:\model description and barcode no.<. Modifications are possible.
- E-mail this file to [service.de@julabo.com](mailto:service.de@julabo.com), JULABO's service department. JULABO is thus able to provide rapid support.

## 15. Cleaning / repairing the unit



### Caution:

- Always turn off the unit and disconnect the mains cable from the power source before cleaning the unit.
- Prevent humidity from entering into the circulator.
- Electrical connections and any other work must be performed by qualified personnel only.

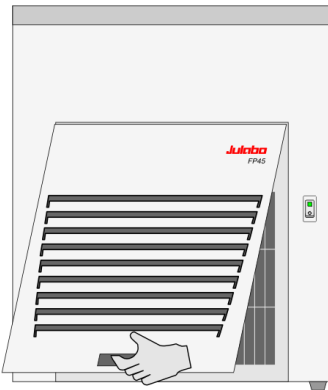

To maintain the full cooling performance, clean the condenser from time to time.

- Switch off the unit, disconnect mains power cable.
- Hold the venting grid, pull out and remove.
- Clean the ribbed condenser with a vacuum cleaner.
- Replace the venting grid.
- Switch on the unit.

### Cleaning:

For cleaning the bath tank and the immersed parts of the circulator, use low surface tension water (e.g., soap suds).

Clean the outside of the unit using a wet cloth and low surface tension water.

The circulator is designed for continuous operation under normal conditions. Periodic maintenance is not required.

The tank should be filled only with a bath fluid recommended by JULABO. To avoid contamination, it is essential to change the bath fluid from time to time.

### Repairs

**Before asking for a service technician or returning a JULABO instrument for repair, please contact an authorized JULABO service station.**

When returning the unit:

- Clean the unit in order to avoid any harm to the service personnel.
- Attach a short fault description.
- During transport the unit has to stand upright. Mark the packing correspondingly.
- When returning a unit, take care of careful and adequate packing.
- JULABO is not responsible for damages that might occur from insufficient packing.



JULABO reserves the right to carry out technical modifications with repairs for providing improved performance of a unit.

## 16. WARRANTY PROVISIONS

The following Warranty Provisions shall apply to products sold in North America by Julabo (“**Seller**”) to the entity shown as buyer (“**Buyer**”) on Seller’s invoice.

1. **Initial Warranty.** Upon Seller’s receipt of payment in full for the products and subject to Buyer’s compliance with the terms of sale and any other agreement with Seller relating to the products, Seller warrants to the Buyer that the products manufactured by the Seller are free from defects in material and workmanship for a period not to exceed two (2) years or ten thousand (10,000) hours of operation, whichever comes first, from the date the product is shipped by Seller to Buyer (the “**Initial Warranty**”).

2. **EXCLUSION OF ALL OTHER EXPRESS WARRANTIES; EXCLUSION OF ALL IMPLIED WARRANTIES.** OTHER THAN THE INITIAL WARRANTY, NO OTHER EXPRESS WARRANTIES ARE MADE. ALL IMPLIED WARRANTIES OF EVERY TYPE AND KIND, INCLUDING BUT NOT LIMITED TO ANY IMPLIED WARRANTY OF MERCHANTABILITY OR FITNESS FOR A PARTICULAR PURPOSE OR USE, ARE EXCLUDED IN ALL RESPECTS AND FOR ALL PURPOSES. SELLER DISCLAIMS AND MAKES NO IMPLIED WARRANTIES WHATSOEVER.

3. **Exclusions.** The Initial Warranty does not include damage to the product resulting from accident, misuse, improper installation or operation, unauthorized or improper repair, replacement or alteration (including but not limited to repairs, replacements, or alterations made or performed by persons other than Seller’s employees or authorized representatives), failure to provide or use of improper maintenance, unreasonable use or abuse of the product, or failure to follow written installation or operating instructions. Buyer must return the product’s record of purchase to the Seller or one of Seller’s authorized representatives within thirty (30) days of the date the product is shipped by Seller to Buyer in order to make a claim under the Initial Warranty. Notwithstanding anything contained herein to the contrary, all glassware, including but not limited to reference thermometers, are expressly excluded from the Initial Warranty.

4. **Buyer’s sole remedies; Limitations on Seller’s Liability.** Buyer’s sole and exclusive remedy under the Initial Warranty is strictly limited, in Seller’s sole discretion, to either: (i) repairing defective parts; or (ii) replacing defective parts. In either case, the warranty period for the product receiving a repaired or replaced part pursuant to the terms of the Initial Warranty shall not be extended. All repairs or replacements performed by Seller pursuant to these Warranty Provisions shall be performed at Seller’s facility in Allentown, Pennsylvania, U.S.A. or at the facility of an authorized representative of Seller, which location shall be determined by Seller in its sole discretion; provided, however, that Seller may, in its sole discretion perform such repairs or replacements at Buyer’s facility in which case Buyer shall pay Seller’s travel, living and related expenses incurred by Seller in performing the repairs or replacements at Buyer’s facility. As a condition precedent to Seller’s obligation to repair or replace a product part under the Initial Warranty, Buyer shall (i) promptly notify Seller in writing of any such defect; (ii) shall have returned the product’s record of purchase to Seller or to one of Seller’s authorized representatives within thirty (30) days of the date the product is delivered to Buyer; and (iii) assist Seller in all respects in its attempts to determine the legitimacy and basis of any claims made by or on behalf of Buyer including but not limited to providing Seller with access to the product to check operating conditions. If Buyer does not provide such written notice to Seller within the Initial Warranty period or fails to return the product’s record of purchase as set forth above, Seller shall have no further liability or obligation to Buyer therefore. In no event shall Seller’s liability under the Initial Warranty exceed the original purchase price of the product which is the subject of the alleged defect.

5. **THE REMEDIES PROVIDED IN THE INITIAL WARRANTY ARE THE SOLE AND EXCLUSIVE REMEDIES AVAILABLE TO THE BUYER. NOTWITHSTANDING ANYTHING TO THE CONTRARY CONTAINED HEREIN, AND EVEN IF THE SOLE AND EXCLUSIVE REMEDIES FAIL OF THEIR ESSENTIAL PURPOSE FOR ANY REASON WHATSOEVER, IN NO EVENT SHALL SELLER BE LIABLE FOR BUYER’S MANUFACTURING COSTS, LOST PROFITS, GOODWILL, OR ANY OTHER SPECIAL, INDIRECT, PUNITIVE, INCIDENTAL OR**

**CONSEQUENTIAL DAMAGES TO BUYER OR ANY THIRD PARTY AND ALL SUCH DAMAGES ARE HEREBY DISCLAIMED.**

6. **Assignment.** Buyer shall not assign any of its rights or obligations hereunder without the prior written approval of Seller; provided, however, that if Buyer is a distributor of Seller, the rights and obligations of Buyer under these Warranty Provisions shall inure to the benefit of and be binding upon Buyer's customers who provide the product's proof of purchase to Seller pursuant to the terms set forth herein. Seller may assign any or all of its rights or obligations hereunder without Buyer's prior consent.

7. **Governing Law.** The Warranty Provisions and all questions relating to their validity, interpretation, performance, and enforcement shall be construed in accordance with, and shall be governed by, the substantive laws of the Commonwealth of Pennsylvania without regard to its principles of conflicts of law.

8. **Waiver.** Any failure of the part of Seller to insist on strict compliance with the Warranty Provisions shall no way constitute a waiver of such right. No claim or rights arising out of a breach of the Warranty Provisions by Buyer may be discharged in whole or in part by a waiver of the claim or right, unless the waiver is in writing signed by an authorized representative of Seller. Seller's waiver or acceptance of any breach by Buyer of any provisions of the Warranty Provisions shall not constitute a waiver of or an excuse for nonperformance as to any other provision of the Warranty Provisions nor as to any prior or subsequent breach of the same provision.

9. **Freight.** Buyer will arrange and pay for shipping and handling charges for the unit to be returned to the Seller. Seller will arrange and pay for shipping and handling for the return of the unit to the Buyer.