

Operating Manual

High Temperature Circulator

HT60-M2

HT60-M3

C.U.-cooling unit



Forte HT with cooling unit

1.953.3727-V4 us 02/16

Version: V 4.01-J

JULABO USA, Inc.

884 Marcon Boulevard ▪ Allentown, PA 18109

Phone: +1(610) 231-0250 ▪ Fax: +1(610) 231-0260 ▪ info.us@julabo.com ▪ www.julabo.com

Congratulations!

You have made an excellent choice.

JULABO thanks you for the trust you have placed in us.

This operating manual has been designed to help you gain an understanding of the operation and possible applications of our circulators. For optimal utilization of all functions, we recommend that you thoroughly study this manual prior to beginning operation.

The JULABO Quality Management System



Temperature control devices for research and industry are developed, produced, and distributed according to the requirements of ISO 9001 and ISO 14001. Certificate Registration No. 01 100044846

Unpacking and inspecting

Unpack the instrument and accessories and inspect them for possible transport damage. Damage should be reported to the responsible carrier, railway, or postal authority, and a damage report should be requested. These instructions must be followed fully for us to guarantee our full support of your claim for protecting against loss from concealed damage. The form required for filing such a claim will be provided by the carrier.

Printed in Germany

Changes without prior notification reserved

Important: keep original operating manual for future use

TABLE OF CONTENTS

OPERATING MANUAL	5
1. INTENDED USE	5
1.1. Description	5
2. OPERATOR RESPONSIBILITY – SAFETY INSTRUCTIONS	6
2.1. Disposal	7
2.2. Technical specifications	8
2.3. Cooling water connection	11
3. OPERATING CONTROLS AND FUNCTIONAL ELEMENTS	12
M2 or M3 – control electronic	12
HT60 High Temperature Circulator with C.U.-cooling unit (option)	15
4. SAFETY NOTES FOR THE USER	17
4.1. Explanation of safety notes	17
4.2. Explanation of other notes	17
4.3. Safety instructions	17
5. PREPARATIONS	20
5.1. Setup	20
5.2. Installation	21
5.3. Bath fluids	24
5.4. Tubing	25
5.5. Power connection	26
5.6. Filling / draining	26
5.7. Degasifying	28
5.8. Countercooling	30
6. OPERATING PROCEDURES	31
6.1. Switching on / Selecting the language	31
7. MANUAL OPERATION	32
7.1. Start - Stop	32
7.2. Setting the temperatures	32
7.3. Warning functions	33
7.4. Setting the safety temperature (with shutdown function)	34
7.5. Internal / external control	35
8. MENU FUNCTIONS	36
8.1. Configuration	37
8.2. Control parameters	40
8.3. Start of a profile	43
8.3.1. Interrupting a profile	45
8.4. Integrated programmer	46
8.5. Analog inputs/outputs	49
8.6. Limits	52
8.7. Interface	53
8.8. Sensors	53

9. TROUBLESHOOTING GUIDE / ERROR MESSAGES	55
10. ELECTRICAL CONNECTIONS.....	57
11. REMOTE CONTROL	59
11.1. Setup for remote control.....	59
11.2. Communication with a PC or a superordinated data system	60
11.3. List of commands	61
11.4. Status messages / error messages.....	64
12. CLEANING / REPAIRING THE UNIT	66
13. WARRANTY PROVISIONS	67

Operating manual

1. Intended use

The High Temperature Circulators HT60-M2 and HT60-M3 are to be employed especially for closed tempering circuits in the laboratory, the technical institution or the production, like e.g. for distillation plants, reaction vessels, autoclaves, injection moulding tools.



JULABO circulators are not suitable for direct temperature control of foods, semi-luxury foods and tobacco, or pharmaceutical and medical products. Direct temperature control means unprotected contact of the object with the bath medium (bath fluid).

1.1. Description

The structure of the **High Temperature Circulator HT60** is sub-divided in three zones:

- The cold zone (on top) with the electronics for controlling and monitoring, the temperature control and the pump motor.
- The cooling zone with the cooling coil, the float for the level indication, a temperature sensor for monitoring the temperature, the connection for inert-gas, the connection for the expansion vessel as well as an overflow nozzle. At this place the temperature monitoring is independant from the other safety devices.
- The heating zone (down) with the heating element, the pump, the temperature sensors and the flow nozzle

The **C.U.-cooling unit** can be installed firmly and fulfills two tasks.

- The temperature of the tempering liquid in the cooling zone is supervised. If it is necessary the cooling water is led through the integrated cooling coil in order to reduce the temperature (without C.U.-cooling unit the cooling coil can be connected directly to the cooling water).
- With a separate cooling circuit through the C.U.-cooling unit a rapid cooling of the tempering liquid becomes possible.

The **M2 or M3 control electronics** is connected to the HT60-circulator via a control cable.

- The local operation of the control electronics M2 / M3 is effected via a splash-water protected keypad. The Microprocessor technology allows to set three different temperature values, to store and to indicate them via the digital display LCD – the working temperature and the values for the excess and lower temperature warning functions.
- With the integrated programmer the instructions for setpoint and time for six different temperature profiles can be stored and called in.
- Via an analog interface REG+E-PROG an analog programmer can be connected for the setpoint.
- At the same time this interface is provided with three analog outputs for the recorder. For the best resolution the output settings can be adjusted via the menu delete surface - should just be Menu.
The remote control via the digital RS232/RS485 interface according to NAMUR allows the most modern process technology without additional interface.
- The excess temperature protection is a safety equipment which does not depend on the control circle. Its safety value is shown and can be adjusted by the MULTI-DISPLAY (LED).
- The level of liquid is acquired in the cooling zone, indicated to the control electronics via the control cable. There they are made visible by an 8-grade level indication.

2. Operator responsibility – Safety instructions

The products of JULABO ensure safe operation when installed, operated, and maintained according to common safety regulations. This section explains the potential dangers that may arise when operating the circulator and also specifies the most important safety precautions to preclude these dangers as far as possible.

The operator is responsible for the qualification of the personnel operating the units.

- The personnel operating the units should be regularly instructed about the dangers involved with their job activities as well as measures to avert these dangers.
- Make sure all persons tasked with operating, installing, and maintaining the unit have read and understand the safety information and operating instructions.
- When using hazardous materials or materials that could become hazardous, the circulator may be operated only by persons who are absolutely familiar with these materials and the circulator. These persons must be fully aware of possible risks.

If you have any questions concerning the operation of your unit or the information in this manual, please contact us!

Contact	JULABO USA, Inc. 884 Marcon Boulevard Allentown, PA 18109	Phone: +1(610) 231-0250 Fax: +1(610) 231-0260 info.us@julabo.com www.julabo.com
----------------	---	--

Safety instructions for the operator:

- Avoid strikes to the housing, vibrations, damage to the operating-element panel (keypad, display), and contamination.
- Make sure the product is checked for proper condition regularly (depending on the conditions of use). Regularly check (at least every 2 years) the proper condition of the mandatory, warning, prohibition and safety labels.
- Make sure that the mains power supply has low impedance to avoid any negative effects on the instruments being operated on the same mains.
- This unit is designed for operation in a controlled electromagnetic environment. This means that transmitting devices (e.g., cellular phones) should not be used in the immediate vicinity.
- Magnetic radiation may affect other devices with components sensitive to magnetic fields (e.g., monitors). We recommend maintaining a minimum distance of 1 m.
- Permissible ambient temperature: max. 40 °C, min. 5 °C.
- Permissible relative humidity: 50% (40 °C).
- Do not store the unit in an aggressive atmosphere. Protect the unit from contamination.
- Do not expose the unit to sunlight.

Appropriate operation

Only qualified personnel is authorized to configure, install, maintain, or repair the circulator.

Persons who operate the circulator must be trained in the particular tasks by qualified personnel. The summarized user guidance (short manual) and the specification table with information on individual parameters are sufficient for this.

Use

The bath can be filled with flammable materials. Fire hazard!

There might be chemical dangers depending on the bath medium used.



Observe all warnings for the used materials (bath fluids) and the respective instructions (safety data sheets).

Insufficient ventilation may result in the formation of explosive mixtures. Only use the unit in well ventilated areas.

Only use recommended materials (bath fluids). Only use non-acid and non corroding materials.

When using hazardous materials or materials that could become hazardous, **the operator must** affix the enclosed safety labels to the front of the unit so they are highly visible:

If this unit is intended for use within the United States of America, all 3 warning labels **must** be affixed to the housing of the unit prior to use. Directions for the positioning of the individual warning labels are enclosed with the warning labels included in the delivery. Warning labels must be easily visible to users.

1		Warning label W00: Colors: yellow, black Danger area. Attention! Observe instructions. (operating manual, safety data sheet)
2 or		Mandatory label M018: Colors: blue, white Carefully read the user information prior to beginning operation. Scope: EU
2		Semi S1-0701 Table A1-2 #9 Carefully read the user information prior to beginning operation. Scope: USA, NAFTA
3	WARNING: This product contains chemicals known to the state of California to cause cancer, birth defects or other reproductive harm.	Warning label Proposition 65

Particular care and attention is necessary because of the wide operating range.

There are thermal dangers: Burn, scald, hot steam, hot parts and surfaces that can be touched.

	Warning label W26: Colors: yellow, black Hot surface warning. (The label is put on by JULABO)
---	---

Observe the instructions in the manuals for instruments of a different make that you connect to the circulator, particularly the corresponding safety instructions. Also observe the pin assignment of plugs and technical specifications of the products.

2.1. Disposal

The product may be used with oil as bath fluid. These oils fully or partially consist of mineral oil or synthetic oil. For disposal, follow the instructions in the material safety data sheets.

2.2. Technical specifications

			HT60-M2	HT60-M2 & C.U.
Working temperature range	°C		70 ... 400	40 ... 400
Temperature stability external	°C		±0,01 ... ±0.1	
Display accuracy	%		±0.5 ±1Digit	
Temperature selection			digital	
via keypad			indication on LCD DIALOG-DISPLAY (°C/°F)	
remote control via PC			indication on monitor	
Temperature indication			Multi-Display (LED)	
			DIALOG-Display (LCD)	
Resolution	°C		0.01	
Absolute Temperature Calibration				
(ATC 1)	°C		±9.99	
(ATC 2)	°C		±9.99	
Temperature control			ICC - Intelligent Cascade Control,	
self-optimizing			Cascade, parameter can be called-in and modified	
Heater wattage (at 3x400 V)	kW		7.0	
C.U.-cooling unit:				
Temperature	<IntAct>	°C	----	<u>350</u> <u>250</u> <u>150</u> <u>75</u>
Cooling capacity		kW	----	12 8 4 1
at 2 l/min flow of cooling water				
Pressure pump:				
Max. pressure	max. at 0 liters	bar	0.8 ... 1.2	
Flow rate	max. at 0 bar	l/min	14 ... 18	
Electrical connections:			See page 10	
Filling volume		liter	2	
Overall dimensions (WxDxH)	M2 / M3	Cm	25x25x18	25x25x18
Overall dimensions (WxDxH)	HT60	Cm	23x23x58	43x23x58
Weight		kg	29	37
Ambient temperature		°C	5 ... 40	
Mains power connection		V / Hz	400/3PNPE/50	400/3PNPE/50
Current draw		A	12	12

All measurements have been carried out at:
 rated voltage and frequency ambient temperature: 20 °C
 Technical changes without prior notification reserved.

		HT60-M3	HT60-M3 & C.U.				
Working temperature range	°C	70 ... 400	40 ... 400				
Temperature stability external	°C	±0,01 ... ±0.1					
Display accuracy	%	±0.5 ±1Digit					
Temperature selection		digital					
via keypad		indication on LCD DIALOG-DISPLAY (°C/°F)					
remote control via PC		indication on monitor					
Temperature indication		Multi-Display (LED)					
		DIALOG-Display (LCD)					
Resolution	°C	0.01					
Absolute Temperature Calibration							
(ATC 1)	°C	±9.99					
(ATC 2)	°C	±9.99					
Temperature control		ICC - Intelligent Cascade Control,					
self-optimizing		Cascade, parameter can be called-in and modified					
Heater wattage (at 3x400 V)		kW	6.0				
C.U.-cooling unit:							
Temperature	<IntAct>	°C	----	350	250	150	75
Cooling capacity		kW	----	12	8	4	1
at 2 l/min flow of cooling water							
Pressure pump:							
Max. pressure	max. at 0 liters	bar	0.8 ... 1.2				
Flow rate	max. at 0 bar	l/min	14 ... 18				
Electrical connections:		See page 10					
Filling volume		liter	2				
Overall dimensions (WxDxH)	M2 / M3	Cm	25x25x18		25x25x18		
Overall dimensions (WxDxH)	HT60	Cm	23x23x58		43x23x58		
Weight		kg	29		37		
Ambient temperature		°C	5 ... 40				
Mains power connection		V / Hz	208/3PPE/60		208-230/50-60		
Current draw		A	19		19		

All measurements have been carried out at:
rated voltage and frequency ambient temperature: 20 °C
Technical changes without prior notification reserved.

Electrical connections:

Computer interface	RS232 or RS485
Programmer input	0 - 10 V / 0 - 20 mA
Temperatur recorder outputs	Channel 1 / 2 0 - 10 V / Channel 3 0 - 20 mA / 4 - 20 mA
Stand-by input	
External alarm device	Switching capacity max. 30 W / 40 VA Switching voltage max. 125 V~/– Switching current max. 1 A
External measurement and controlsensor	Pt100, 4-lead technique

Safety installations according to IEC 61010-2-010:

Excess temperature protection	adjustable from 0 °C to 420 °C
Low liquid level protection	float switch
Liquid level indication	optical 8-graded
Rèpartition par classe selon DIN 12876-1	Classe III FL

Supplementary safety installations

High temperature warning function	optical + audible (in intervals)
Low temperature warning function	optical + audible (in intervals)
Supervision of the working sensor	plausibility control
Reciprocal sensor monitoring between working and safety sensors	difference >100 °C
Alarm indication	optical + audible (permanent)

Environmental conditions according to IEC 61 010-1:

- Use only indoor.
- Altitude up to 2000 m - normal zero.
- Ambient temperature: see Technical specifications
- Air humidity:
Max. rel. humidity 80 % for temperatures up to +31 °C,
linear decrease down to 50 % relative humidity at a temperature of +40 °C
- Max. mains fluctuations of ±10 % are permissible.
- Overvoltage category II
- Pollution degree 2



Caution:

The unit is not for use in explosive environment

Protection class according to IEC 60 529: IP21
The unit corresponds to Class I

Standards for interference resistance according to EN 61326-1

This unit is an ISM device classified in Group 1 (using high frequency for internal purposes) Class A (industrial and commercial range).

2.3. Cooling water connection

Cooling water pressure (IN / OUT)	max.	4.5 bar
Difference pressure (IN - OUT)		2.0 to 4.5 bar
Rate of flow	typical	2 l/min
Cooling water temperature		<20 °C



Notice:

Danger of corrosion of heat exchanger due to unsuitable quality of cooling water.

- Due to its high content of lime, hard water is not suitable for cooling and causes scale in the heat exchanger.
- Ferrous water or water containing ferrous particles will cause formation of rust even in heat exchangers made of stainless steel.
- Chlorinated water will cause pitting corrosion in heat exchangers made of stainless steel.
- Due to their corrosive characteristics, distilled water and deionized water are unsuitable and will cause corrosion of the bath.
- Due to its corrosive characteristics, sea water is not suitable.
- Due to its microbiological (bacterial) components, which settle in the heat exchanger, untreated and unpurified river water and water from cooling towers is unsuitable.
- Avoid particulate matter in cooling water.
- Avoid putrid water.







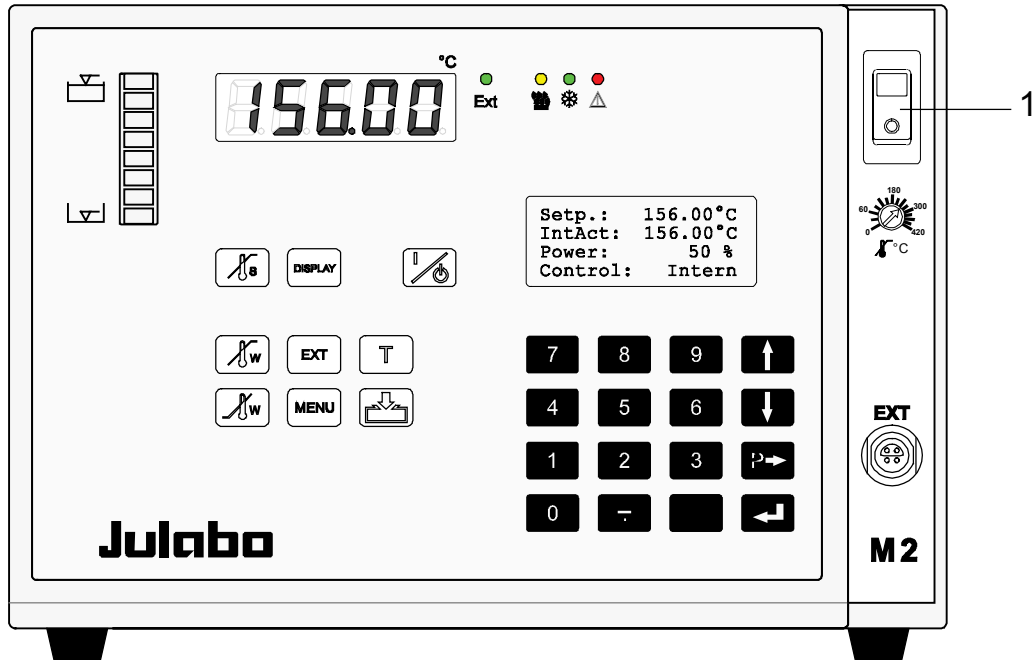

Recommended quality of cooling water:















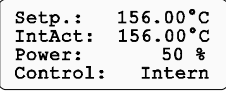





pH	7.5 to 9.0
Sulfate [SO ₄ ²⁻]	< 100 ppm
Hydrocarbonate [HCO ₃ ⁻]/sulfate [SO ₄ ²⁻]	> 1 ppm
Hardness [Ca ²⁺ , Mg ²⁺]/[HCO ₃ ⁻]	> 0.5 °dH
Alkalinity	60 ppm < [HCO ₃ ⁻] < 300 ppm
Conductivity	< 500 µS/cm
Chloride (Cl ⁻)	< 50 ppm
Phosphate (PO ₄ ³⁻)	< 2 ppm
Ammonia (NH ₃)	< 0.5 ppm
Free chlorine	< 0.5 ppm
Trivalent iron ions (Fe ³⁺)	< 0.5 ppm
Manganese ions (Mn ²⁺)	< 0.05 ppm
Carbon dioxide (CO ₂)	< 10 ppm
Hydrogen sulfide (H ₂ S)	< 50 ppm
Content of oxygen	< 0.1 ppm
Algae growth	impermissible
Suspended solids	impermissible

3. Operating controls and functional elements

M2 or M3 – control electronic



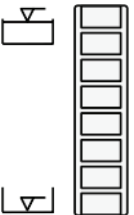

- | | | |
|---|---|---|
| 1 | | Mains power switch, illuminated |
| 2 |  | Start / stop key |
| 3 |  | Working temperature T |
| 4 |  | Key for automatic filling and aeration |
| 5 |  | High temperature warning limit |
| 6 |  | Low temperature warning limit |
| 7 |  | Safety temperature |
| 8 |  | Adjustable excess temperature protection (safety temperature) |
| 9 |  | Control type: internal/external control |

- 10  MULTI-DISPLAY (LED) temperature indication
- 11  Display of internal/external actual value
- EXT**
 /  /  Indicator lights:
 Temperature indication - external actual value
 Alarm / Cooling / Heating
- 12  DIALOG-DISPLAY (LCD) for indication of:
 Line 1: Setpoint  or  or 
 Line 2: Internal or external actual value 
 Line 3: Heating power in %
 Line 4: Control type: internal /  external control
- 13  MENU key - for selecting the menu functions
- 14   Cursor keys - Select menu items
- 15  P-key Selecting parameters
- 16    Numeral keypad: numerals 0 to 9; minus / decimal point
- 17  Enter key 1) Store value / parameter
 2) Next lower menu level
- 18  Escape key 1) Cancel entries
 2) Return to a higher menu level
- 19  Socket for external measurement and control sensor Pt100
- 20  8-grade liquid level indication

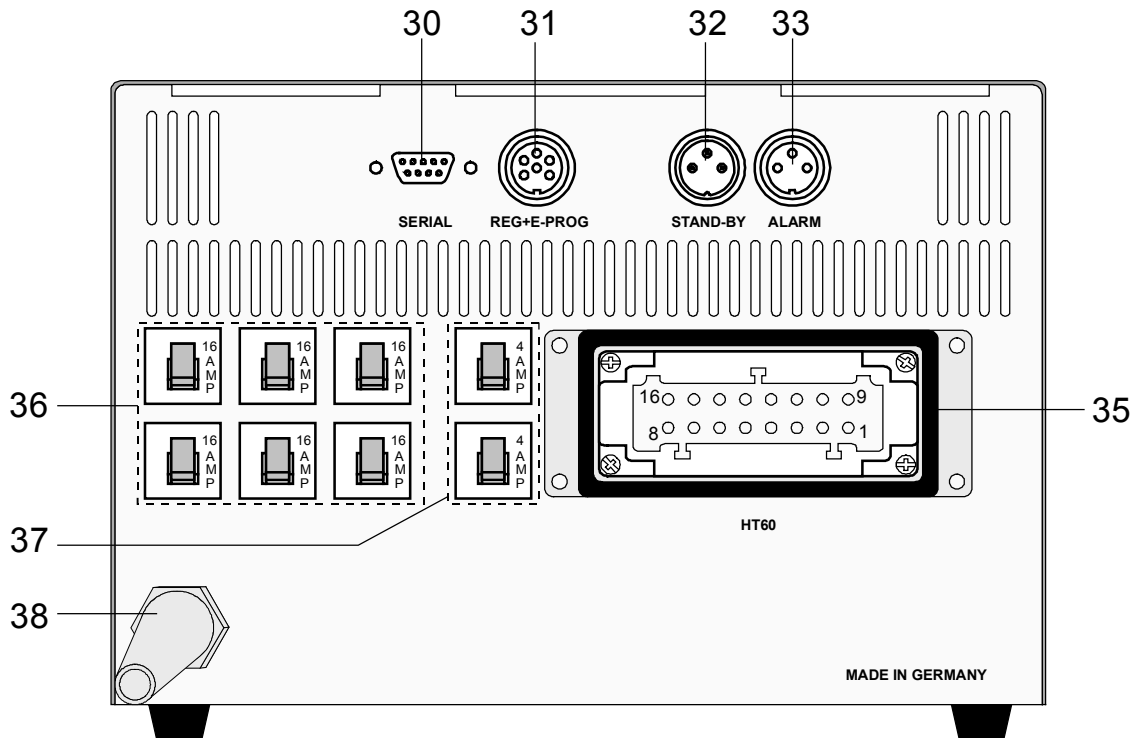
Rear view

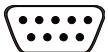



- 30  SERIAL Interface RS232/RS485

- 31  REG+E-PROG Programmer input and temperature recorder output

- 32  STAND-BY Stand-by input (for external emergency switch-off)

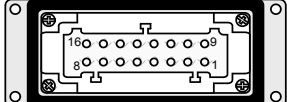
- 33  ALARM Alarm output (for external alarm signal)

- 35  Control exit Connector for control cable of circulator HT60

- 36   M2 – Mains circuit breakers (resettable): 3x Mains fuses 16 A, or
M2 – 3x fuse holder with fein-wire fuses T16A, 5x20 mm

- 37  M3 – Mains circuit breakers (resettable): 6x Mains fuses 16 A,
Mains circuit breakers (resettable): Fuses 4 A, for C.U.-cooling unit

- 38 Mains power cable with plug

HT60 High Temperature Circulator with C.U.-cooling unit (option)

Front view:

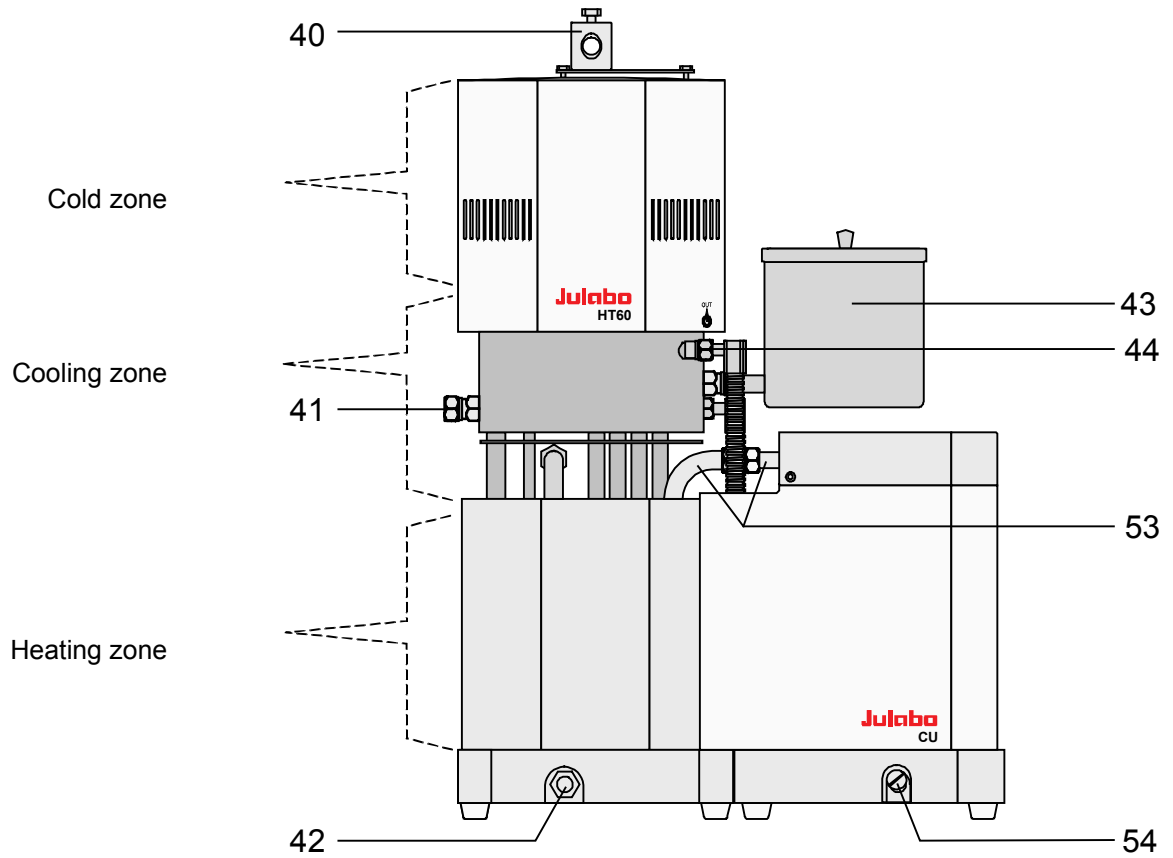

Rear view:

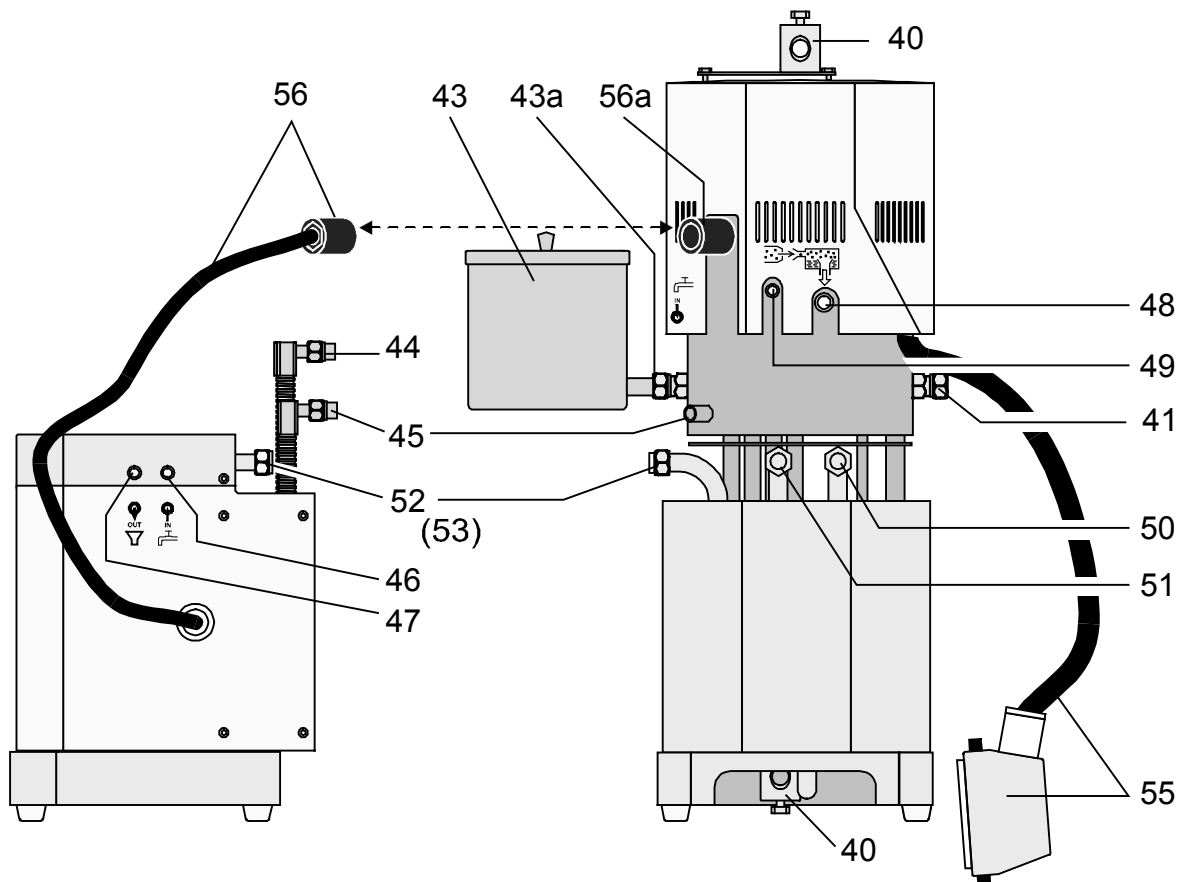



Presentation: Cooling unit

divided from

HT60

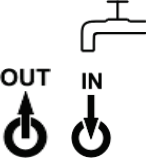
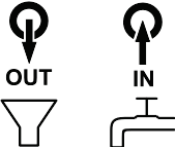
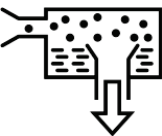
Operating controls and functional elements

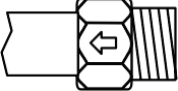
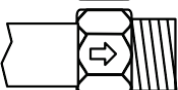
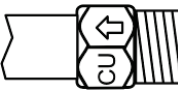
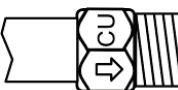
40		Stand rod attachment with mouting screw; $\varnothing 12$; M8
41		Connector for liquid level indicator or second expansion vessel; M16x1 / $\angle 37^\circ$
42		Drain plug for bath liquid; M16x1
43/43a		Expansion vessel / Connector for expansion vessel; M16x1 (When filling it serves as funnel)
44/45		<p>Cooling water connectors at the HT60, M12 / $\angle 37^\circ$ OUT – outlet (44), IN – inlet (45)</p> <ul style="list-style-type: none"> • Connection for cooling water or • Connection for clocked cooling water with magnetic valve or • Connection for clocked cooling water out of the CU-unit •
46/47		<p>Cooling water connectors at the C.U.-cooling unit; $\varnothing 10$ IN –inlet, OUT – outlet</p>
48		<p>Overflow connector $\varnothing 15,5$ / G $\frac{1}{4}$ " Internal thread</p>
49		<p>Inert gas connector $\varnothing 10$; M8x1 Internal thread</p>
50		<p>Pump connector for external temperatur application Return; M16x1</p>
51		<p>Pump connector for external temperatur application Feed ; M16x1</p>
52		<p>Pump connector for C.U.-cooling unit - Return; M16x1 (Cooling circuit)</p>
53		<p>Pump connector for C.U.-cooling unit - Feed; M16x1 (Cooling circuit)</p>
54		Drain plug for cooling water; M10x1
55		Control cable with 16-channel plug for connection of the M2 or M3 control electronics
56		Control cable with 6-channel plug for connection of the C.U.-cooling unit
56a		Control exit for C.U.-cooling unit
		or
56a		Control exit for magnetic valve (for clocked cooling water)

4. Safety notes for the user

4.1. Explanation of safety notes



In addition to the safety warnings listed above, warnings are posted throughout the manual. These warnings are designated by an exclamation mark inside an equilateral triangle. "Warning of a dangerous situation (Attention! Please follow the documentation)." The danger is classified using a signal word. Read and follow these important instructions.



Warning:

Describes a possibly highly dangerous situation. If these instructions are not followed, serious injury and danger to life could result.



Caution:

Describes a possibly dangerous situation. If this is not avoided, slight or minor injuries could result. A warning of possible property damage may also be contained in the text.



Notice:

Describes a possibly harmful situation. If this is not avoided, the product or anything in its surroundings can be damaged.

4.2. Explanation of other notes



Note!

Draws attention to something special.



Important!

Indicates usage tips and other useful information.

4.3. Safety instructions

Follow the safety recommendations to prevent damage to persons or property. Further, the valid safety instructions for working places must be followed.



- Only connect the unit to a power socket with earthing contact (PE – protective earth)!
- The power supply plug serves as safe disconnecting device from the line and must be always freely accessible.
- Place the instrument on an even surface on a pad made of **non-flammable** material.
- Do not stay in the area below the unit.
- Make sure you read and understand all instructions and safety precautions listed in this manual before installing or operating your unit.
- Set the safety temperature.
- Never operate the unit without bath fluid in the bath.
- Pay attention to the thermal expansion of bath oil during heating to avoid overflowing of the fluid.
- Prevent water from penetrating into the hot bath oil.
- Do not drain the bath fluid while it is hot!
Check the temperature of the bath fluid prior to draining (by switching the unit on for a short moment for example).

- Employ suitable connecting tubing.
- Avoid sharp bends in the tubing, and maintain a sufficient distance from surrounding walls.
- Make sure that the tubing is securely attached.
- Regularly check the tubing for material defects (e.g. for cracks).
- Never operate damaged or leaking equipment.
- Always turn off the unit and disconnect the mains cable from the power source before performing any service or maintenance procedures, or before moving the unit.
- Always turn off the unit and disconnect the mains cable from the power source before cleaning the unit.
- Transport the unit with care.
- Sudden jolts or drops may cause damages in the interior of the unit.
- Observe all warning labels.
- Never remove warning labels.
- Never operate equipment with damaged mains power cables.
- Repairs are to be carried out only by qualified service personnel.



Some parts of the bath cover and the pump connections may become extremely warm during continuous operation. Therefore, exercise particular caution when touching these parts.



Caution:

The temperature controlling i.e. of fluids in a reactor constitutes normal temperature system practice.

We do not know which substances are contained within these vessels.

Many substances are:

- inflammable, easily ignited or explosive
- hazardous to health
- environmentally unsafe

i.e.: **dangerous**

The user alone is responsible for the handling of these substances!

The following questions shall help to recognize possible dangers and to reduce the risks to a minimum.

- Are all tubes and electrical cables connected and installed?
Note:
sharp edges, hot surfaces in operation, moving machine parts, etc.
- Do dangerous steams or gases arise when heating?
Is an exhaust needed when working?
- What to do when a dangerous substance was spilled on or in the unit?
Before starting to work, obtain information concerning the substance and determine the method of decontamination.



Notice:

When you have finished the application, it is recommended to keep on circulating the liquid in the bath or the external system for some time. Simultaneously set the working temperature to +20 °C to allow the temperature in the system to decrease slowly. Thus fractional over-heating of the bath liquid is prevented.

**Notice:****Check the safety installations at least twice a year!**

- Excess temperature protection according to IEC 61010-2-010
With a screw driver turn back the adjustable excess temperature protection until the shut-down point (actual temperature).
- Low level protection
To check the function of the float of this unit it cannot be operated manually.
The 5-graded level display should therefore be observed whenever refilling.
If the bath liquid thickens or cracks, the instrument should be cleaned and checked by qualified personnel.

**Caution: Escape of vapors / gas**

The necessity of degassing requires that a closed system is not entirely sealed. Especially at increased working temperatures vapor / gas may escape.

Ensure sufficient ventilation at the place of installation!

**WARNING**

This product contains chemicals known to the state of California to cause cancer, birth defects or other reproductive harm.

5. Preparations

5.1. Setup

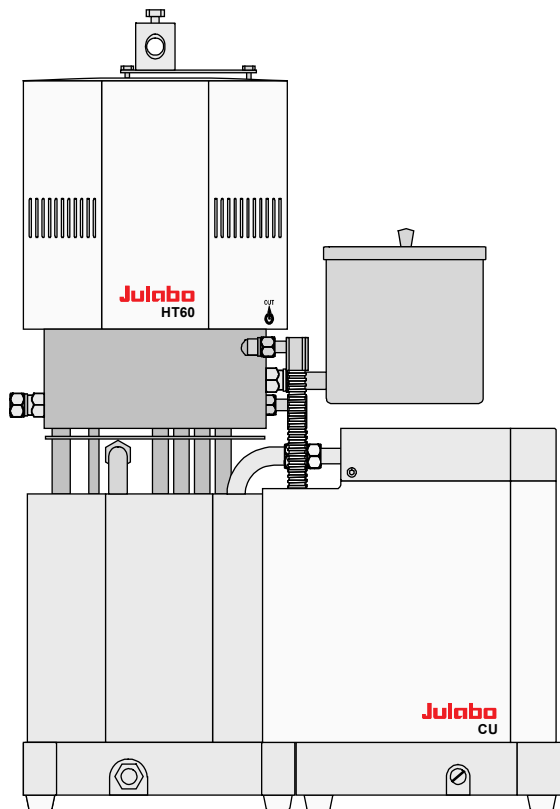

High temperature circulator HT60 as well as High temperature circulator HT60 with CU cooling unit:

as a desktop unit

- Place the circulator on an even surface on a pad made of **non-flammable** material.

as a stand-mounted unit

- Place the unit in an vertical position.
- A wall distance of at least 15 cm must be maintained for ventilation, allowing internal heat to be conducted away from the unit.

JULABO Order-No.
9790100

C.U. cooling unit

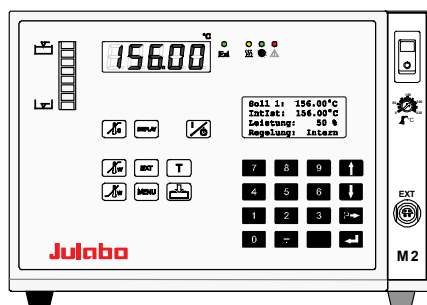

M2 or M3 remote control electronics:

- The unit should be set up at a dry location.
- Place the unit in an upright position and do not obstruct the ventilation. Ambient temperatures above 40 °C result in a failure of the unit.
- Do not set up the unit in the immediate vicinity of heat sources and do not expose to sun light.

5.2. Installation



Caution:

Installation of the C.U.-unit / Installation of the magnetic valve

- Always turn off the unit and disconnect the mains cable (38) from the power source before installing the unit.
- The control cable with plug (56) of the C.U.-cooling unit or the magnetic valve always have to be connected or disconnected in absence of current.



Control of the C.U.-cooling unit or the magnetic valve.

- With the C.U.-cooling unit or the magnetic valve the menupoint **-CoolingMax-** has to be adjusted to a value of > 0 (Recommendation: 100%). So the automatical control of the cooling can become active (see 8.6. Limits).

Installation of the C.U.-unit

JULABO Order-No. 9790100 C.U. cooling unit

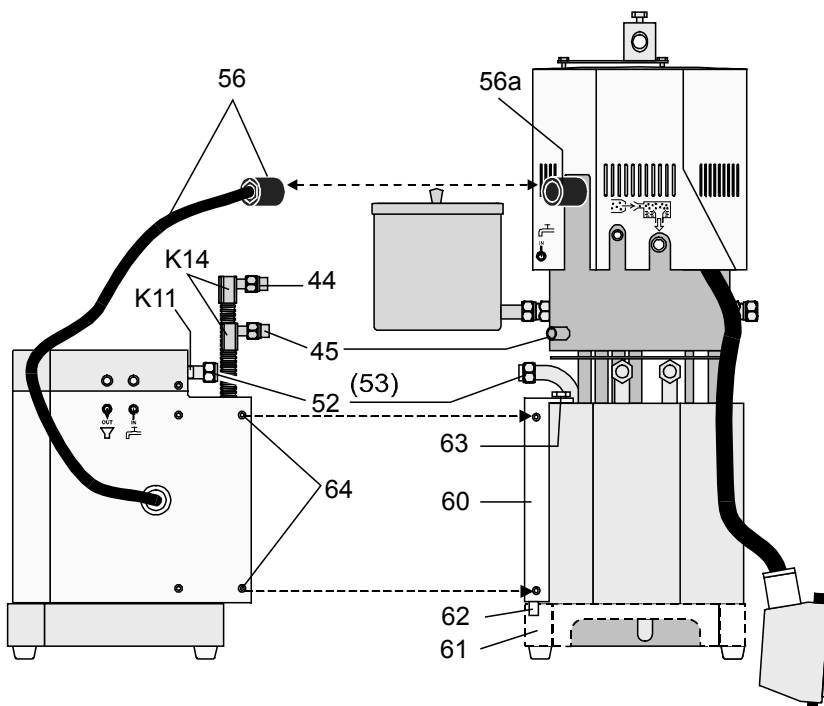

- Use the leader pins (62) to fix the assembly sheet (60) into the base (61) of the circulator and fasten with hexagon screws (63).
- Push the C.U.-cooling unit to the circulator and screw it tightly at the points (64).
- Connect the cooling circulation for the oil (52, 53) (open end wrench SW19). When doing this hold the tube at position K11 with an open end wrench SW21.

- Connect the cooling water (44, 45) (open end wrench SW15) When doing this hold the tube at position (K14) with an open end wrench (SW14)
- Fix the control cable (56) at the control exit (56a) and screw it tightly.

Cooling capacity at 2 l/min flow of cooling water.

Temperature <IntAct>	[°C]	350	250	150	75
Cooling capacity	[kW]	12	8	4	1

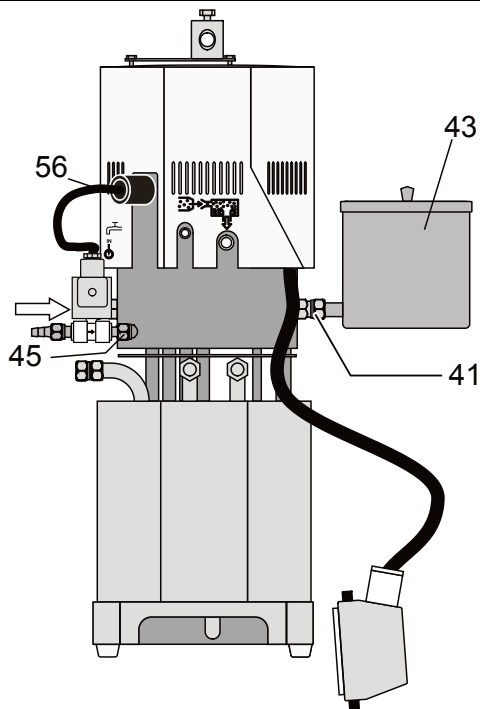

Installation of the magnetic valve

JULABO Order-No. 8 980 704 3

Magnetic valve

- Fix the expansion tank (43) to the connection (41) (open end wrench SW19)
- Screw the magnetic valve to the entry for cooling water (45). Respect the flow direction (arrow)
Connect the cooling water to the magnetic valve and to the outflow of cooling water (44) by means of tubes 8 mm ID.
- Fix the control cable (56) at the control exit (56a) and screw tightly.

Adapter to reduce the pump pressure

JULABO Order-No. 8 970 802

With this adapter the pump pressure at the pump connection (51) can be reduced from 1,2 bar to 0,8 bar^{-0,1}.

Assembly

- Fix the adapter to reduce the pump pressure to the pump connections (50, 51) (open end wrench SW19).

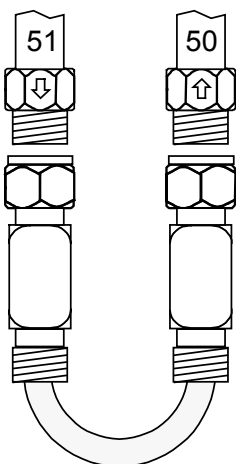

Notice:

When using pressure sensitive glass vessels, it is absolutely necessary to work with an adapter to reduce the pump pressure.



Caution:

Securely attach all tubing to prevent slipping.

5.3. Inert gas superimposition



Warning:

Gas leakage

Danger of asphyxiation

Due to the system design, the cooling zone of circulator is not hermetically sealed since the cooling zone is also used as an expansion vessel for the expanding heat carrier medium in heating mode.

The superimposed inert gas escapes as a result of the overpressure in the ambient air of the circulator.

Inert gases displace oxygen.

In the event of inert gas superimposition, ensure adequate ventilation of the installation site.

The oxygen concentration in the respiratory air must be given due consideration when designing the ventilation system at the installation site.

Effects of oxygen deficiency on the human body:

% oxygen	Effects
20.9	Normal
19.5	Statutory minimum concentration in the USA
15 – 19.5	Capacity to work falls, initial symptoms including cardiac, pulmonary or circulation problems
17	Statutory minimum concentration in Germany
12 – 15	Pulse and respiration rate increased, judgment impaired
10 – 12	Further increase in pulse and respiration rate, dizziness, judgment impaired, blue lips
8 – 10	Nausea, unconsciousness, vomiting
6 - 8	After 6 minutes: -50% death rate, after 8 minutes -100% death rate
< 6	Coma within 40 seconds, cramp, respiratory arrest, death

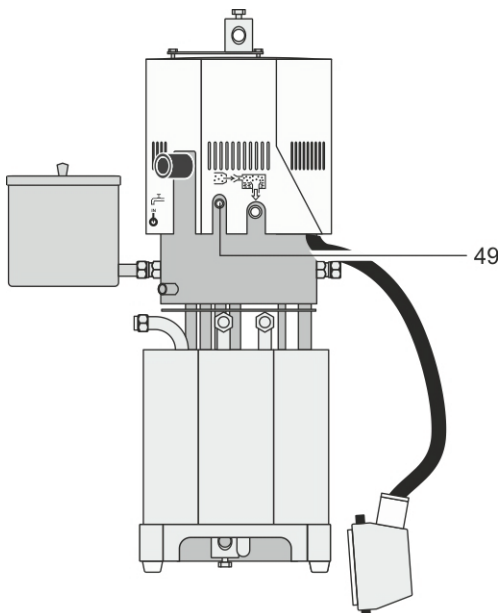

The heat carrier medium in the cooling zone of the circulator may be superimposed with an inert gas with a slight overpressure compared to the ambient pressure via the connection (49) to prevent the oxidation of the heat carrier medium. This increases the service life of the carrier medium.

A gas delivery rate of 0.5 standard liters/hour is adequate for the superimposition.

5.4. Bath fluids



Caution:

Carefully read the safety data sheet of the bath liquid used, particularly with regard to the fire point!
If a bath fluid with a fire point of ≤ 65 °C is used, only supervised operation is possible.

Recommended bath fluids



See website for list of recommended bath fluids.

Contact: see page 6



Caution:

Fire or other dangers when using bath fluids that are not recommended:

Please contact JULABO before using other than recommended bath liquids.
JULABO assumes no liability for damage caused by the selection of an unsuitable bath fluid.
Unsuitable bath fluids are fluids which, e.g.,

- are highly viscous
(much higher than $30 \text{ mm}^2 / \text{s}$ at the respective working temperature)
- have a low viscosity and have creep characteristics
- have corrosive characteristics or
- tend to crack.

No liability for use of other bath fluids!

ATTENTION: The maximum permissible viscosity is $30 \text{ mm}^2 / \text{s}$.



Caution:

The use of water in purified or unpurified form is not allowed.
Examples: Tap water, distilled water, water-glycol mixture, CaCl_2 -brine



Important notice

Tempering liquid

The circulator can only be operated in closed tempering circuits. The contact of the tempering liquid with atmospheric oxygen only takes place in the not-flowed cooling zone. A safety equipment with definitely adjusted temperature value ($170^\circ\text{C} \pm 5^\circ\text{C}$) works independently from the control circuit and supervises the temperature in the cooling zone. From 160°C on the warning >hot cooling zone< is shown in line 4 of the DIALOG-DISPLAY (LCD).

If the temperature of the liquid reaches the safety temperature (170°C), a complete shutdown of the controlled heating device is effected. So it becomes possible to use tempering liquids with a flashpoint from 190°C on.

From a working temperature of 200°C on always work with counter-cooling.

```
Setp.: xxx.xx°C
IntAct: xx.xx°C
Power   xx %
Control: intern
```

hot cooling zone

5.5. Tubing

Recommended tubing:

Metal tubing, triple insulated, M16x1, Temperature range -100 °C ... +350 °C

Order No.	Length
8 930 209	0.5 m
8 930 210	1.0 m
8 930 211	1.5 m
8 930 214	3.0 m

Metal tubing, insulated, M16x1, Temperature range -50 °C ... +200 °C

Order No.	Length
8 930 220	0.5 m
8 930 221	1.0 m
8 930 222	1.5 m
8 930 223	3.0 m

Pressure max.	6.0 bar	at	+20 °C
	4.6 bar	at	+200 °C
	3.8 bar	at	+350 °C



Warning:

Tubes:

At high working temperatures the tubing used for temperature application and cooling water supply represents a danger source.

A failure of the counter-cooling, e.g. through broken tubes can cause higher temperatures in the cooling zone. Due to a damaged tempering tube hot tempering liquid can be pumped out within a short time.

These are possible results:

- Danger of fire
- Danger of explosion
- Burning of people's skin
- Difficulties in breathing due to hot atmosphere

JULABO supplies the metal tubes with assembly instructions (No. 1.950.0013). There all the instruction for assembly are indicated. They absolutely have to be respected.

Safety recommendations

- Employ suitable connecting tubing.
- Make sure that the tubes are securely attached.
- Avoid sharp bends in the tubing, and maintain a sufficient distance from surrounding walls.
- Regularly check the tubing for material defects (e.g. for cracks)..

5.6. Power connection



Caution:

1. Connect control cable (55) with control exit (35) of the control electronics M2 / M3 and latch the safety loop.
Lengthening piece for control cable, 5 m - JULABO Order-No. 8 980 125
 2. If available screw the C.U.-cooling unit tightly to the control exit (56a) of the HT60 by means of the control cable (56).
 3. Connect the mains plug (38) of the control electronics to a power socket with earthing contact (PE – protective earth)!
- The available supply voltage and the power frequency have to be compared with the specifications on the type plate.
Voltage differences of $\pm 10\%$ are allowed.
 - The power supply plug serves as a safe disconnecting device from the line and must always be easily accessible.
 - Never operate the unit with a damaged mains power cable.
 - Regularly check the mains power cables for damage.
 - We disclaim all liability for damage caused by incorrect line voltages!

5.7. Filling / draining



Caution:

- The lines of the external system should be well cleaned in order to avoid soil particles (sand, metal chips) from being rinsed into the circulator. Danger for magnetic valves and the pump.
- The tempering liquid must not contain water!
Preparing the tempering liquid:
Heat the oil up to 110°C in an open bath to boil off any water. Tempering time approximately 1 hour.

In case of high temperatures water parts in the tempering liquid can cause damages in the HT circulator!

Recommendation :

After each refilling a degasifying of the tempering liquid should be made.

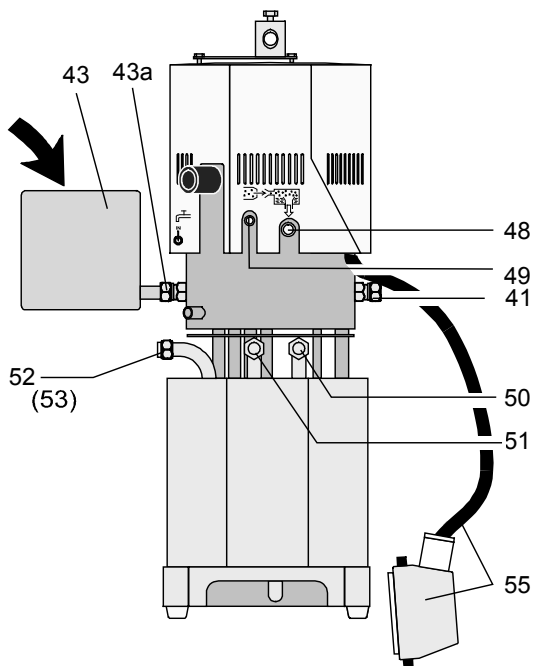

Filling

1. Attach a tube at the overflow nozzle (48) and lead it into a suitable vessel.
2. Remove the screw plugs from the pump connection (50, 51) and connect it to the external system by means of metal tubes (open end wrench SW19)
3. Remove the screw plug from the connection (43a) and screw on the expansion tank (43)
4. Always close tightly the connections which have not been used (e.g. 41 or 52, 53) with screw plugs, the drain plug (42) is also important.
5. Connect the mains supply (see above) and switch on the mains switch (1).
6. Fill the unit by pouring the fluid into the expansion tank, which is connected to the cooling zone.
7. Operate key  Internally a valve opens the passage to the heating zone. With a reduced no. of rotations the pump motor pumps the tempering liquid into the externally connected consumer.

8. Slowly refill tempering liquid until two or three segments of the level indication light up. The necessary quantity of liquid then is in the tempering system.
9. If the minimum level liquid remains under, a low level alarm E01 can be caused. By a short switching-off and switching-on again at the mains switch (1) the alarm status is cancelled.

Afterwards again refill the tempering liquid and operate the key  until two or three segments of the level indication lighten.

10. Operate key  in order to finish the filling process.

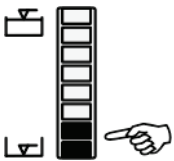

Notice

- Do not drain the bath fluid while it is hot or cold !
Check the temperature of the bath fluid prior to draining (by switching the unit on for a short moment, for example).
- Store and dispose the used bath fluid according to the laws for environmental protection.

Draining

1. Cool the fluid below 40C and then turn off the mains switch.
2. Place the circulator to the table edge and put under a suitable vessel to uptake the used tempering liquid.
3. For emptying unscrew the drain nut (42) on the front of the HT30 and have the tempering liquid run into a suitable vessel.

5.8. Degasifying

During the filling process the pump fluidizes air bubbles into the tempering liquid. In the automatic degasifying mode those and other light solvent substances are slowly drained from the oil via the breather tube.

Notice:

In the automatic degasifying mode the breather tube between heating and cooling zone is opened again and again. Hot gases and self-extending tempering liquid therefore get into the cooling zone. Therefore in case of a target temperature which is higher than 150°C a counter-cooling in the cooling zone should be possible.

(See 5.8. Countercooling)

- Switch on the control electronics by the mains switch (1)
- With key **EXT** switch to „internal control“.
- Operate the following keys one after the other as described in order to get into the degasifying mode or to leave it. On the DIALOG-DISPLAY (LCD) the different actions can be followed-up.

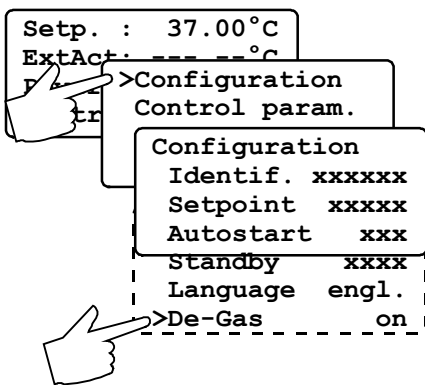

1. MENEUE-key **MENU** 1x
2. Enter-key 1x
3. Cursor-key 5x
4. P-key **P→** 1x
5. Enter-key 1x

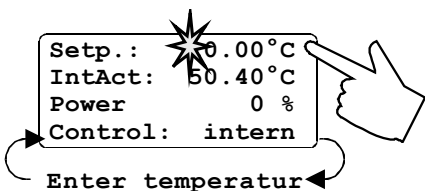

6. Now in line 4 of the DIALOG-DISPLAY there is the demand to set a temperature value („Enter temperature“)
Example: 250°C

For this operate the following keys



With the Enter-key the value is stored
and

at the same time the degasifying mode is started.
(Also see „Temperature setting“ page 20)

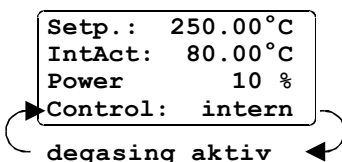

7. The temperature is automatically increased step by step by 2°C. Each time there is a standstill of approximately one minute. In line 4 of the DIALOG-DISPLAY (LCD) the degasifying mode is indicated by blinking.

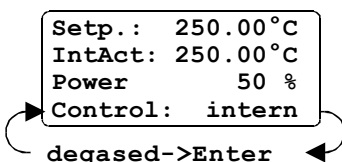

8. When the target temperature is reached, the degasifying mode is finished.
A signal tone sounds in intervals and in line 4 of the DIALOG-DISPLAY there is the demand to operate the Enter-key.

```

Setp.: 250.00°C
IntAct: 250.00°C
Power  50 %
Control: intern



```

9. The DIALOG-DISPLAY (LCD) shows the standard indication, the circulator regulates to the last adjusted setpoint (in the example 250 °C) with the last adjusted control parameters.

The circulator is ready for use!





Stopping the degasifying:

- By operating the Start/Stop-key  the degasifying mode can be stopped at any time.
- The degasifying mode can also be left via the menu level . Proceeding as point 1 – 5.

Important !

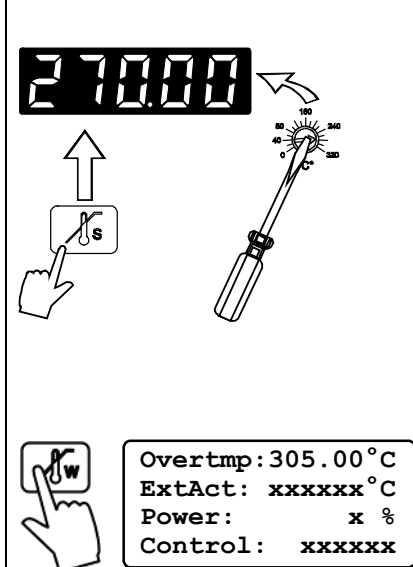
To avoid switching-off due to the excess temperature protection or – warning both settings should be checked and, if necessary, adjusted.



- Operate the setpoint-key . The MULTI-DISPLAY (LED) shows the present setpoint temperature (Example: 270.00°C). („Safety temperature“ see page 34)
- Operate the setpoint key . The DIALOG-DISPLAY (LCD) shows the present setpoint temperature (Examples: 305.00°C) („Warning functions“ see page 33)

5.9. Countercooling



Caution:

Securely attach all tubing to prevent slipping.
From a working temperature of 200°C on always work with counter-cooling.

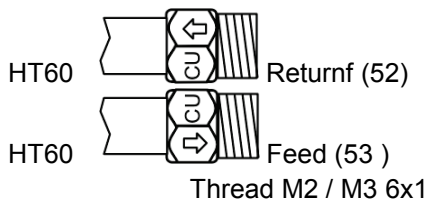
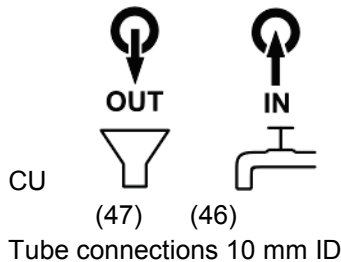
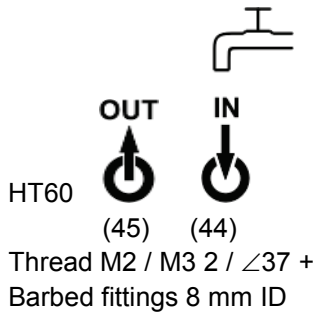

On the HT60-circulator we distinguish two different cooling devices:
(Cooling water see page 11)

1. A cooling coil in the cooling zone for cooling water.

Without C.U.-cooling unit

The cooling water is directly connected to the connections (44, 45).

Flow of cooling water: app. 2 l/min at T >150 °C.

or

A magnetic valve for clogged cooling water is connected to the connection (44)

When required the control exit opens and closes the magnetic valve.

JULABO Order no.. 8 980 704 Magnetic valve

With assembled C.U.-cooling unit

the cooling water is connected to the connections (47, 46)

The flow of cooling water is controlled automatically.

2. A cooling coil in the C.U.-cooling unit for rapid cool-down of the tempering liquid

Via the pump connections (52, 53) the tempering liquid is led through the CU-unit.

The heat is drained via the cooling water (47).

Comments:

- With an assembled C.U.-cooling unit the menu-point CoolingMax has to be set to a value of >0. So, the automatic control of the cooling can become active.
- In the C.U.-unit water and oil temperature are supervised at each outflow.
The oil flow-through is interrupted when the oil temperature is app. 150 °C and the water temperature is app. 80 °C.

C.U.-cooling unit:

Cooling capacity at 2 l/min flow of cooling water.

Temperature <IntAct>	[°C]	350	250	150	75
Cooling capacity	[kW]	12	8	4	1

6. Operating procedures

6.1. Switching on / Selecting the language



```
JULABO
HT-30/60
Controller
V 4.01-J
```

```
-OFF-
```

Switching on:

Turn on the mains power switch.

The unit performs a self-test.

All segments of the 5-digit MULTI-DISPLAY (LED), all indicator lights and the DIALOG-DISPLAY (LCD) will illuminate.

Then the software version (example: V 4.01-J) appears. The display "OFF" indicates the unit is ready to operate (standby mode).

The high temperature circulator enters the operating mode activated before switching the programmable controller off:





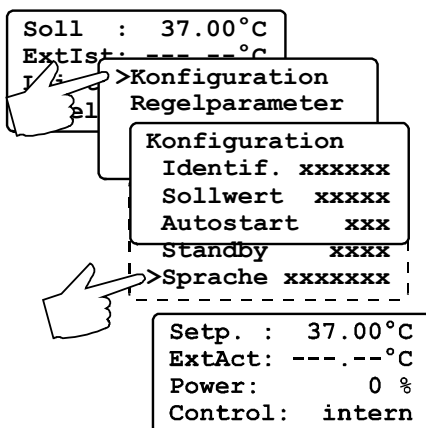

keypad control mode (manual operation) or
remote control mode (operation via personal computer).

Selecting the language:

There are two options for the language of the DIALOG-DISPLAY (LCD): German or English. Select the desired language in the MENUE level under the configuration submenu.



Press the respective keys in the following order:

1. MENUE key  1 x
2. Enter key  1 x
3. Cursor key  4 x
4. P key  1 x
5. Enter key  1 x
6. Escape key  2 x

The DIALOG-DISPLAY (LCD) helps to follow up the individual settings. (example: swap the language from German to English.)

7. Manual operation

7.1. Start - Stop



21.03

Start:

- Press the start/stop key .
The MULTI-DISPLAY (LED) indicates the actual bath temperature.
(example: 21.03 °C)

-OFF-

Stop:

- Press the start/stop key .
The MULTI-DISPLAY (LED) indicates the message "OFF".



The unit also enters the safe operating state "OFF" or "r OFF" after a mains power interruption. The temperature values entered via the keypad remain in memory. With the programmable controller in keypad control mode, press the start/stop key to restart operation. With the programmable controller in remote control mode, the personal computer must first resend the parameters set via the interface before the circulator may be restarted.



7.2. Setting the temperatures

This setting may be carried out with the high temperature circulator being in operating state Start or Stop!



Setp.: 50.00°C
ExtAct: xxxxxx°C
Power xx %
Control: xxxxxx

Setting the working temperature "T":

- Press the setpoint key .
The value previously set appears on the DIALOG-DISPLAY (LCD)
(example: 50.00°C).
A flashing segment indicates that a value needs to be entered.
- Use the keypad to enter the new value (example: 230.00 °C).
- Press enter  to store the selected value.

2 3 0 ↵

Setp.: 230.00°C
ExtAct: xxxxxx°C
Power xx %
Control: xxxxxx

2 5 - 5 ↵

(example 2: 25.50 °C).



Warning:

In case of high temperatures some parts of the High Temperature Circulators can get high surface temperatures when working continuously.

Attention when touching !

During operation do not touch the heating and the cooling zone.



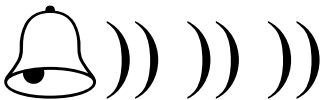

7.3. Warning functions

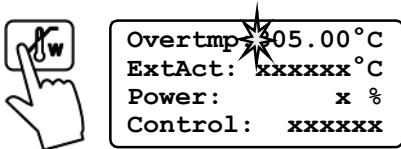

More protection for your samples in the bath!
An audible signal sounds in intervals when the actual temperature value exceeds one of the set limits (patented).



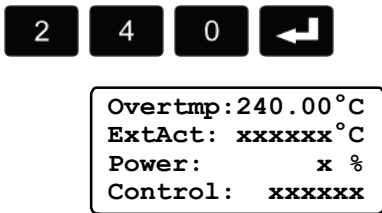

Setting the high temperature limit:

- ① Press the key .
The value previously set appears on the DIALOG-DISPLAY (LCD) (example: 305.00°C). A flashing segment indicates that a value needs to be entered.
- ② Use the keypad to enter the new value (example: 240.00 °C).
- ③ Press enter  to store the value.



Setting the low temperature limit:

- ① Press the key .
- ② Follow the instructions
- ③ for  (example: 220.00 °C).

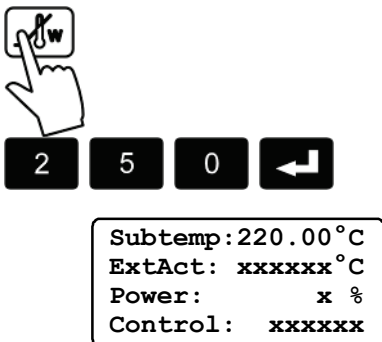

Note:

The warning functions will only be triggered when the actual bath temperature, after start from the „OFF“ or „rOFF“ mode, lies within the set limits for 3 seconds.

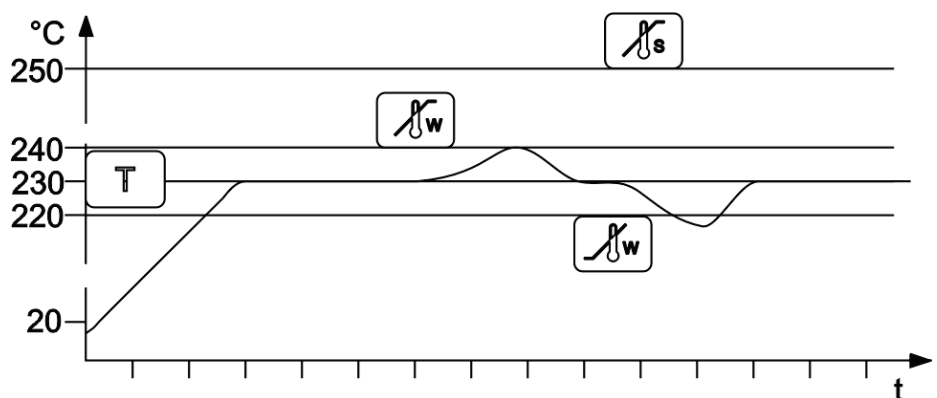

7.4. Setting the safety temperature (with shutdown function)

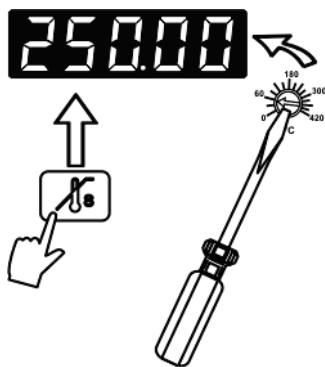

(excess temperature protection)

- Press the key to indicate the safety temperature value on the MULTI-DISPLAY and using a screwdriver simultaneously turn the setting screw to the desired value (example: 250 °C).

Setting range: 0 °C to 420 °C
in 2 °C steps

Safety device in the heating zone:

The safety device works independently from the control circuit and supervises the temperature in the heating zone.

If the temperature of the bath liquid reaches the safety temperature, a complete shutdown of the controlled heating device is effected.

The alarm is indicated by optical and audible signals (continuous tone).

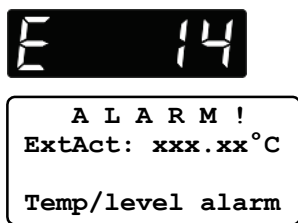
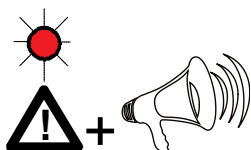

On the MULTI-DISPLAY (LED) and DIALOG-DISPLAY (LCD) appears the error message "E 14".

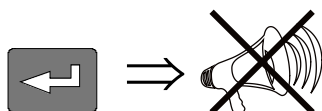

Cancel the alarm state (see page 56)

Recommendation:

- Set the safety temperature at 20 °C above the working temperature setpoint.
- From time to time the safety device has to be checked.
With a screw driver turn back the adjustable overtemperature protection until the shut-down point (actual temperature).

Safety device in the cooling zone:

See „Important notice“ page 24

7.5. Internal / external control

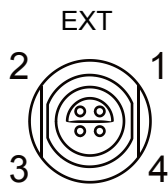

The High Temperature Circulator offers the possibility of internal temperature control in a primary bath vessel or external control directly in an external system.

Setup for external control:

Connect a Pt100 sensor to the socket „EXT“ of the programmable controller, if necessary perform a calibration using the „ATC Ext:“ function (see 8.8. Sensors) and then securely fix the sensor in the external system.

Switching from internal to external control:

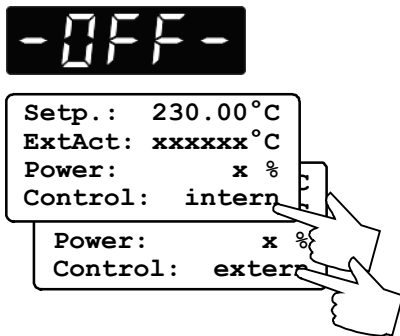

- Press the key **EXT** in operating state “OFF” to select the control type.
- The DIALOG-DISPLAY (LCD) indicates the effective control type.



- Press the start/stop key .

Temperature indication:

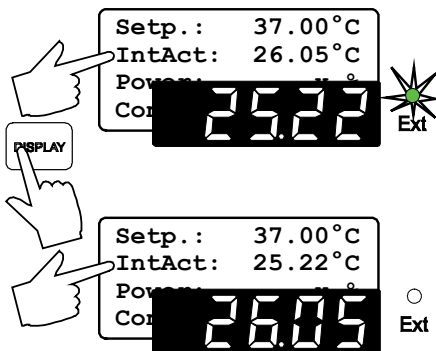

- Both actual temperatures are indicated at the same time:
 - 1) on the MULTI-DISPLAY (LED)
 - 2) on the DIALOG-DISPLAY (LCD).
- Press the key **DISPLAY** to swap the values on the displays. The indicator light „Ext“ refers to the indication on the MULTI-DISPLAY (LED).



Caution:

Place the external sensor into the bath medium and securely fix the sensor.

8. Menu functions



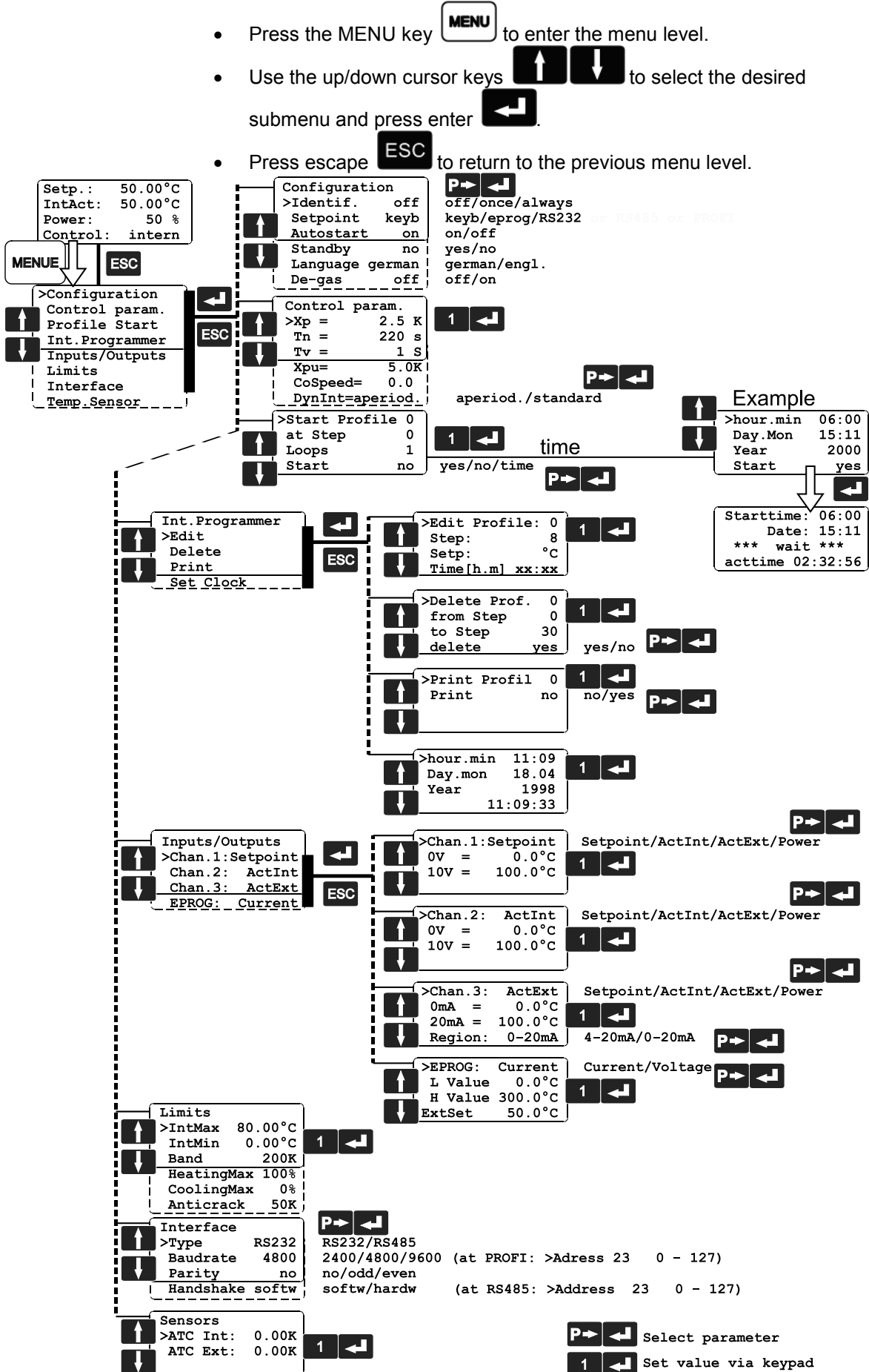



- Press the MENU key **MENU** to enter the menu level.
- Use the up/down cursor keys **↑** **↓** to select the desired submenu and press enter **↵**.
- Press escape **ESC** to return to the previous menu level.

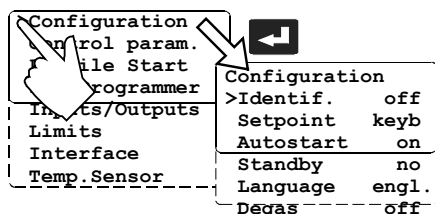

8.1. Configuration

By means of the configuration functions, operation of the High Temperature Circulator can be optimized for the current application.



- Press enter  to select the configuration submenu.
- Use the up/down cursor keys   to select the desired option. A flashing line indicates that a value needs to be entered.
- Press the P-key  to select the parameter and press enter .
- Press escape  to return the previous menu level.

Identification

When performing an identification for the controlled system (temperature application system), the control parameters Xp, Tn and Tv will be automatically determined and stored.

Possible parameters:

off - no identification.

The control parameters ascertained during the last identification are used for control purposes.

once - single identification

The High Temperature Circulator performs a single identification of the controlled system after start.

After the identification process the parameter is automatically set to "off".

always - continual identification

The High Temperature Circulator performs an identification of the controlled system whenever a new setpoint is to be reached.

NOTE: Use this setting only when the temperature application system changes permanently.

Note:

Requirement for an identification of the controlled system:

- The High Temperature Circulator must heat to a setpoint temperature at least 10 °C above the previous setpoint using the adjusted heating power.

- When the adjusted control parameters Xp, Tn and Tv are too high, this requirement may not be given with respect to on how much the setpoint temperature has to change. In this case, prior to carrying out an identification in the „OFF“ state, set the control parameters to lower values.

Recommended setting for internal control:

Xp = 1.0 °C

Tn = 80 s

Tv = 8 s

Setpoint

The programmable controller provides three possibilities for the setpoint selection. The selected mode is indicated on the DIALOG-DISPLAY (LCD).

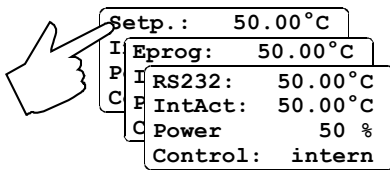

Possible parameters:

keyb- via keypad (working temperature T) or via the integrated programmer.

eprog - via the analog interface REG+E-PROG (31) through an external programmer.

RS232 - via the serial RS232/RS485 interface (30) through a PC or superordinated data system.



Autostart

Note:

The M2 / M3 control electronic has been configured and supplied by JULABO according to N.A.M.U.R. recommendations. This means for the start mode, that the unit must enter a safe operating state after a power failure (non-automatic start mode). This safe operating state is indicated by „OFF“ or „rOFF“, resp. on the MULTI-DISPLAY (LED). A complete shutdown of the main functional elements such as heater and circulation pump is effected simultaneously.

Should such a safety standard not be required, the AUTOSTART function (automatic start mode) may be activated, thus allowing the start of the programmable controller directly by pressing the mains power switch or using a timer.

Possible parameters:

on - AUTOSTART on

off - AUTOSTART off

**Warning:**

For supervised or unsupervised operation with the AUTOSTART function, avoid any hazardous situation to persons or property.

The High Temperature Circulator does no longer conform to N.A.M.U.R. recommendations.

Take care you fully observe the safety and warning functions of the programmable controller.



STAND-BY

Stand-by input

External stand-by for emergency switch-off
(connector - see page 57)

Possible parameters:

no - stand-by input is ignored

yes - stand-by input is active

Language

There are two options for the language of the DIALOG-DISPLAY (LCD):
German or English.

Possible parameters:

German (deutsch)

English (engl.)

Degasifying

During the filling process the pump fluidizes air bubbles into the tempering liquid. In an automatic degasifying mode those and other light solvent substances are let out via a breather tube.

Adjustable parameters:

off – Degasifying mode switched off

on – Degasifying mode switched on

(Also see page 28)

8.2. Control parameters

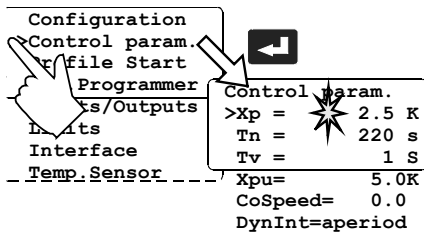

When performing an identification for the controlled system (temperature applications system) (see page 37), the control parameters X_p , T_n , and T_v will be automatically determined and stored.

Each parameter may be manually set via the keypad if necessary, to allow optimum control performance.

- Press enter to select the submenu „control parameters“.
- Use the up/down cursor keys to select the desired option. A flashing segment indicates that a new value needs to be entered.
- Use the numeral keypad to set the value and then set with enter (example: $X_p = 2.5 \text{ }^\circ\text{C}$).

- or at $>\text{DynInt}<$
Press the P-key to select the parameter and press enter .

- Press escape to return to the previous menu level.

Proportional range $>X_p<$

The proportional range is the range below the selected temperature value in which the the control circuit reduces the heating power from 100 % to 0 %.

Resetting time $>T_n<$ (Integral component)

Compensation of the remaining control deviation due to proportional regulation. An insufficient resetting time may cause instabilities to occur. Excessive resetting time will unnecessarily prolong compensation of the control difference.

Lead time $>T_v<$ (Differential component)

The differential component reduces the control settling time. An insufficient lead time will prolong the time required to compensate for disturbance effects and cause high overshooting during run-up. An excessive lead time could cause instabilities (oscillations) to occur.



JULABO
HT-30/60
Controller
V 4.01-J

Note:

The parameters >Xpu<, >CoSpeed< and >Dynamik< are only supported from the programme version V4 xx.

If the control electronics (V 4.xx) M2 respectively M3 is combined with an older version of the HT60 circulators, these parameters are not available. They are not indicated in the menu.

Proportional range >Xpu<

The proportional range Xpu of the cascaded controller is only needed for external control.

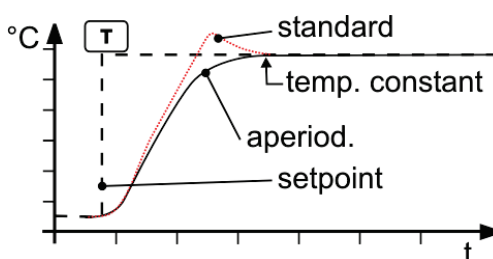

>DynInt< - Dynamics

This parameter affects the march of temperature only in case of internal control (see page 35).

Adjustable parameter:

standard The temperature rises quicker, however can overshoot up to 5%. If a ramp is defined, the march of temperature often follows this ramp.

aperiod. The temperature rises chronologically without overshoot.

With both adjustments a sufficient temperature stability is reached after approximately the same time.

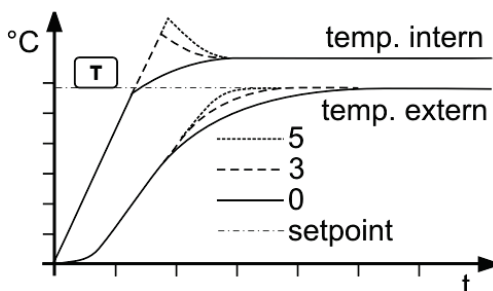
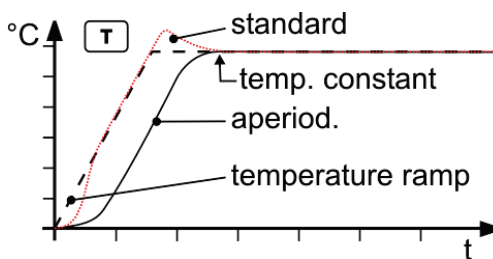

>CoSpeed< 0 up to 5

This parameter affects the march temperature only in case of external control (see page 35).

The adjustment affects the calculation of the control parameter when identifying and so the control course.

Optimization instructions for the PID control parameters:

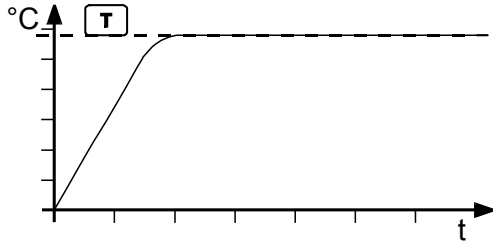

The heat-up curve reveals inappropriate control settings.
(example: working temperature T)

optimum setting

Inappropriate settings may produce the following heat-up curves:

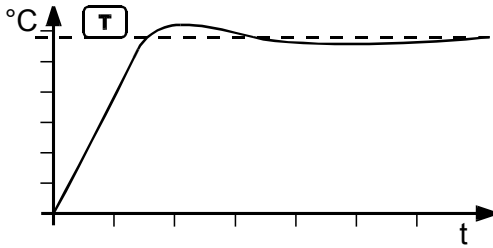

Xp too low

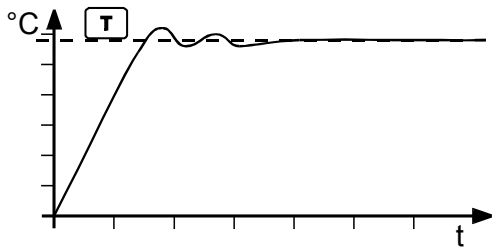

Tv/Tn too low

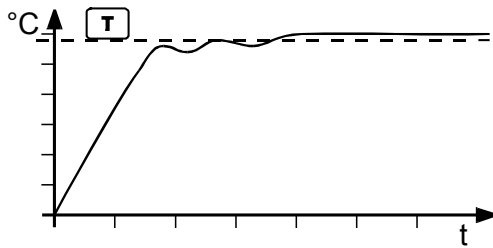

Xp too high
or
Tv too high

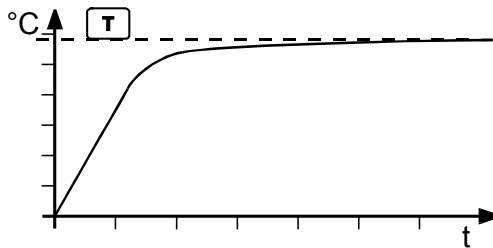

Tv/Tn too high
or
Xp too high

8.3. Start of a profile

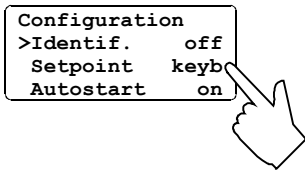

The start menu of the High Temperature Circulator allows calling up and defined starting of one of six previously stored temperature profiles. This start can be effected manually or be released by an integrated timer.

Important:

In the menu configuration under menu point „setpoint“ operation has to be set via „key“.

There are two possibilities for manually starting a program:

1. Starting a program from the OFF status:



The programmer switches back to the OFF status at the end of the program.



2. Starting a program from the operating status.

The programmer is started with the Start key , and the bath is heated to the desired temperature, for example 100 °C. At the end of the program, the programmer switches to the operating status and holds the bath temperature stable at 100.00 °C.



- Press enter  to select the submenu „Profile Start“.
- Use the up/down cursor keys   to select the desired option.

A flashing segment indicates that a number needs to be entered.

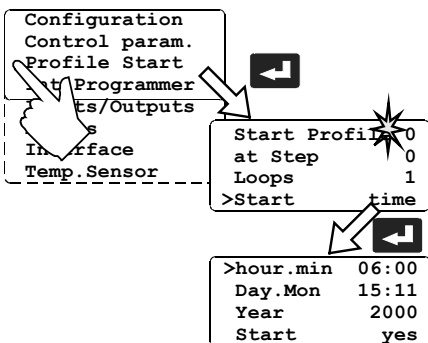

Start Profile 0 to 5
at Step 0 to 60
Loops 1 to 99



Enter the desired number and set each entry with enter .

Start no / yes ⇒ (manual start)
 or
time ⇒ (via integrated timer)

A flashing line indicates that a parameter needs to be entered.

Press the P-key  to select the respective parameter and press enter .

Example: hour.min 6:00 h



```
>hour.min 06:00
Day.Mon 15:11
Year 2000
Start yes
```

```
Starttime: 06:00
Date: 15:11
*** wait ***
acttime 02:32:56
```

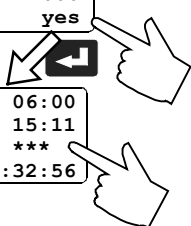

- When selecting the parameter **time**, a new menu level is called up for entry of the start time.

A flashing segment indicates that a start time needs to be entered.

hour.min Start time
Day.Mon day and month
Year year

Set each entry with enter

Start no / yes

A flashing line indicates that the parameter „yes“ needs to be entered.

Press the P-key to select the parameter and press enter



- The High Temperature Circulator switches to waiting mode and a flashing line „wait“ appears on the DIALOG-DISPLAY (LCD). The start time and actual time are permanently indicated on the display.

```
Setp. : xx.xx°C
IntAct: xx.xx°C
Prof. : x Stp: x
Remain: xx:xx:xx
```

```
Setp. : xx.xx°C
ExtAct: xx.xx°C
Prof. : x Stp: x
Remain: xx:xx:xx
```



Indication after starting the profile:

DIALOG-DISPLAY (LCD)

- 1st line: Setpoint of the programmer
- 2nd line: Actual temperature value
 at **internal control** = IntAct: xxx.xx
 at **external control** = ExtAct: xxx.xx
- 3rd line: Selected profile and the actual section
- 4th line: Remaining time of the actual section

MULTI-DISPLAY (LED)

If the circulator is operated through the **integrated programmer** the MULTI-DISPLAY (LED) swaps between the two actual values (internal and external)

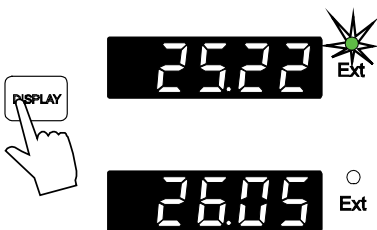

8.3.1. Interrupting a profile

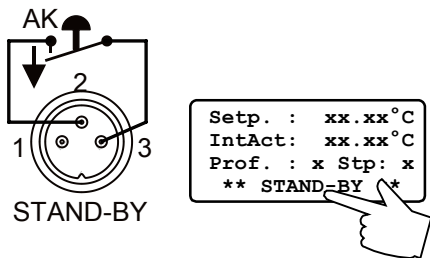
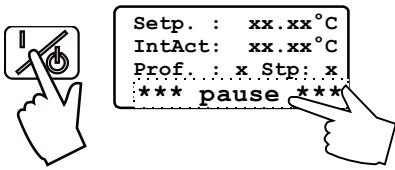

Interrupting a profile:

Press the start/stop key  to interrupt or restart a profile. The setpoint and time period set for the corresponding section are thus stopped at the values presently achieved. The programmable controller is put on hold and the message „pause“ flashes on the DIALOG DISPLAY (LCD).

- A profile can be interrupted or restarted by an external emergency shut-off.(see page 57).



CAUTION: This is not an actual emergency shut-off!

- The setpoint control and the timer are interrupted by breaking the contact “AK”. The programmer switches to the waiting position, while displaying this condition with a blinking LCD display.

Important:

To achieve this, the Stand-by condition must first be activated and the Autostart function turned on. (see page 39).



Warning:

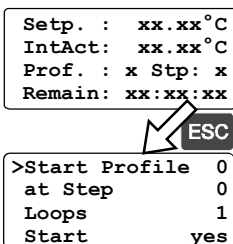

Following a power interruption, it would be possible in this condition for the programmer to restart automatically. The safety and warning functions of the programmer should always be used to their fullest capacity.

See warning page 39



Termination of a profile:

A profile can be terminated by pressing the escape key . The programmer switches back to the Start menu.

- Press escape  again to leave the menu or use the cursor keys   to remain in the Start menu.

The execution of another temperature profile can now be prepared if necessary.

8.4. Integrated programmer

The integrated programmer allows any desired temperature program sequences to be realized. Such a temperature sequence is called profile. A profile consists of individual sections defined by duration (t:) and target temperature. Target temperature is the setpoint (T:), that is achieved at the end of a section. The programmer uses time and temperature difference values within a section to calculate a temperature ramp.

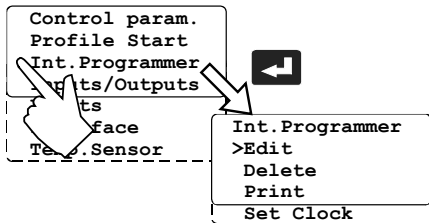

- Press enter to select the submenu „Int. Programmer“.
 - Use the up/down cursor keys to select the desired option. Then press enter to open.
- A flashing segment indicates that a number or value needs to be entered.

Edit	Compile profiles Display sections
Delete	Delete sections
Print	Print a programmed profile
Set clock	Set the real time on the programmable controller

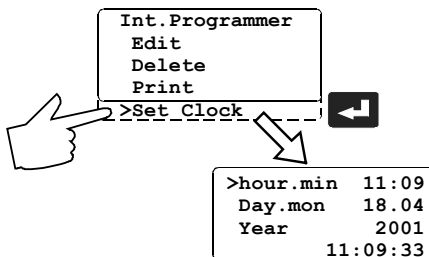

Setting the clock

The integrated clock provides the flexibility to start a profile at any date and time. The clock is preset at the JULABO factory.

- Lines 1 to 3:
Check for correctness of the preset date and time and correct if necessary.

The time is displayed permanently in line 4.

Examples:



- Use the numerals to set time, date and year and set each entry with enter .
- Press escape to return to the previous menu level.

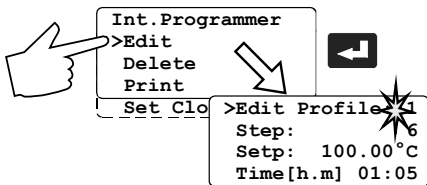

Examples:

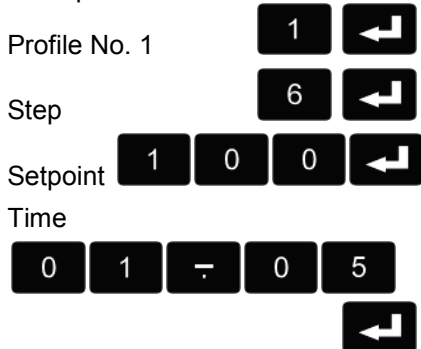

Edit

Compile profiles:

- A flashing segment indicates that a number needs to be entered. Under submenu „Edit Profile“ enter a profile number. Six profiles may be stored (nos. 0 to 5).
- Then programme the desired values for each section. Use the keypad to set section number, target temperature and time period. Set each entry with enter

When the program is running, only sections having complete information for target temperature and time period are considered. It makes sense, to leave out section numbers in the profile, in order to use them later for corrections in the profile.

Important:

If a time of 00:00 is set for a profile, the profile is continued with the next section only after the setpoint temperature (± 0.2 °C) is reached.

- Press escape to return to the previous menu level.

Example:

Step	(No.)	1	3	5	6	9	11	14
Setpoint	(°C)	50	50	100	100	80	80	20
Time	(h:m)	00:08	00:02	00:10	01:05	00:10	00:05	00:30

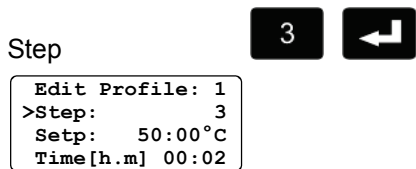
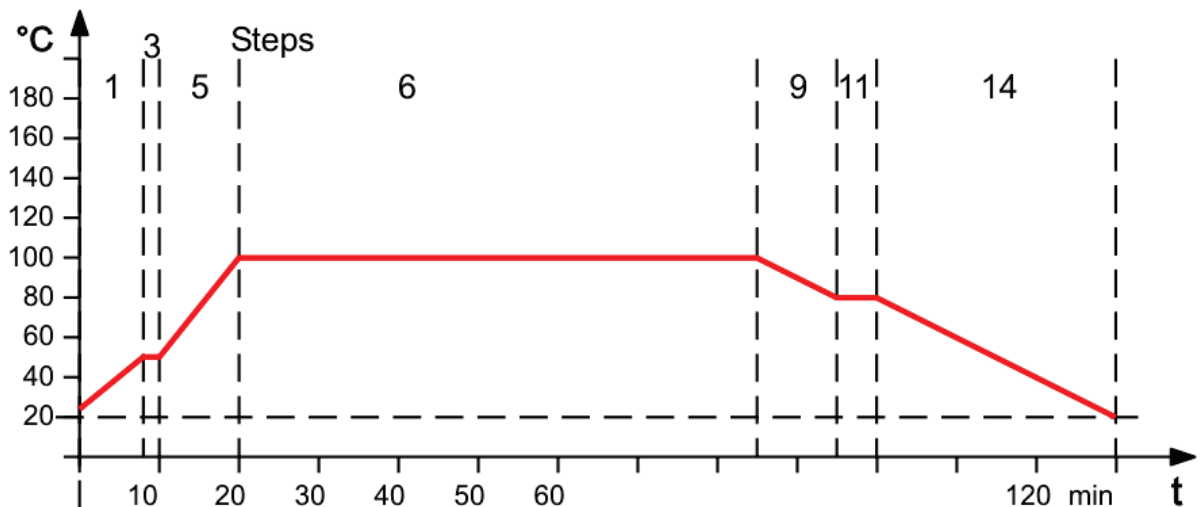

Display sections:

- Use the cursor keys to select the submenu „Step“, enter the desired number and press enter .
- The values previously set are displayed.

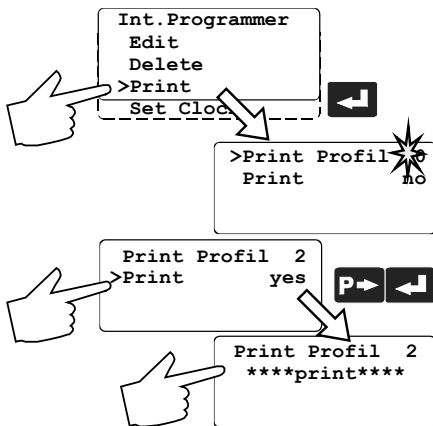
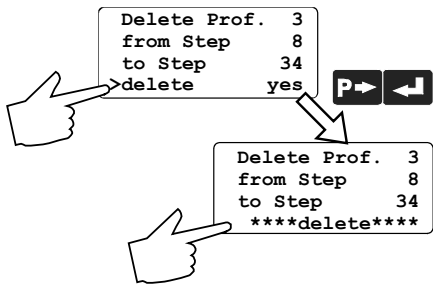
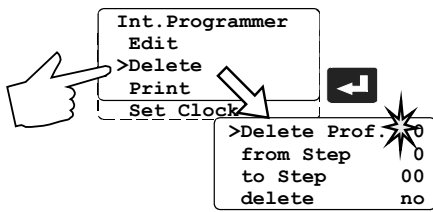

Profile 1

Step 0	not defined!	
Step 1	50	00:08
Step 2	not defined!	
Step 3	50	00:02
Step 4	not defined!	
Step 5	100	00:10
Step 6	100	01:05
Step 7	not defined!	
Step 8	not defined!	
Step 9	80	00:10
Step 10	not defined!	
Step 11	80	00:05
Step 12	not defined!	
Step 13	not defined!	
Step 14	20	00:30
Step 15	not defined!	
	etc.	

Delete

- A flashing segment indicates that the respective profile number needs to be entered in which one or more consecutive sections are to be deleted.
- In lines 2 and 3 of the DIALOG DISPLAY (LCD) enter the numbers of the sections to be deleted. Press enter

- **delete no / yes**

Press the P-key to select the parameter „yes“ and press enter

Line 4 indicates the deletion.

Example:

Delete section 8 to section 34 in profile 3.

- Press escape to return to the previous menu level.

Print

Each profile may be printed via the serial interface for control or documentation.

- A flashing segment indicates that the number of the profile to be printed needs to be entered.

- **Print no / yes**

Press the P-key to select the parameter „yes“ and press enter

Printing is indicated in line 2.

This printing example shows the profile given as example on page 47.

8.5. Analog inputs/outputs

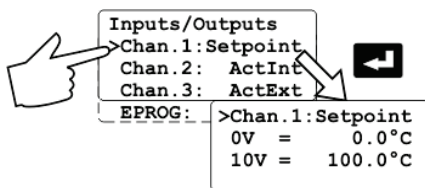
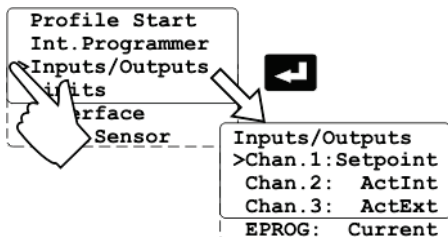
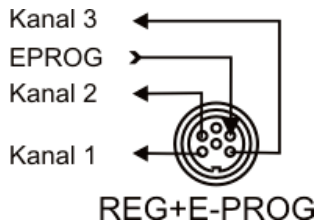

This submenu enables setting of the input and output values for the programmer input and the temperature recorder outputs of socket REG+E-PROG (31).

- Press enter to select the inputs/outputs submenu.
- Use the up/down cursor keys to select the desired option and press enter to open.

Chan.1 voltage output for recorder (V)
Chan.2 voltage output for recorder (V)
Chan.3 current output for recorder (mA)
EPROG external programmer input

First define the desired output value for channels 1 to 3:

Press the P-key to select the desired output value and set with enter .

Setpoint active setpoint temperature
(T, integr. programmer/ext. programmer)
ActInt internal actual temperature value
(bath temperature)
ActExt external actual temperature value
(external sensor)
Power periodic or intermittent heating or cooling

- Then select the display size for channels 1 to 3:

```
>Chan.2: ActInt
0V = x.x°C
10V = xxx.x°C
```

or

```
>Chan.2: Power
0V = x.x%
10V = xxx.x%
```

```
>Chan.3: ActExt
0mA = x.x°C
20mA = xxx.x°C
Region: 0-20mA
```

```
>Chan.3: ActExt
4mA = x.x°C
20mA = xxx.x°C
Region: 4-20mA
```

Channel 1 and 2 voltage outputs

Assign the voltage values of 0 V to the lowest and 10 V to the highest necessary temperature or power rating required as an output value (°C or %).

Current output channel 3

Assign the current values 0 mA or 4 mA to the lowest and 20 mA to the highest temperature or power rating required as an output value (°C or %).

The current output offers 2 ranges for selection: 0 to 20 mA and 4 to 20 mA.

Select the desired range by pressing the P-key

and set with enter

The LCD display changes automatically.

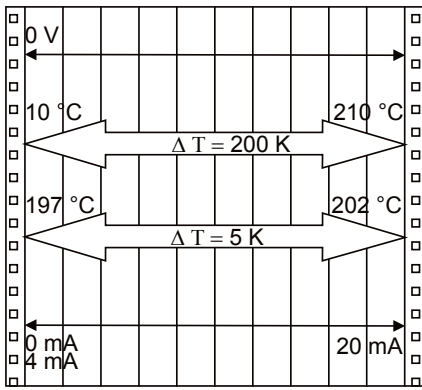

Examples:

lowest temperature value: 10 °C
 highest temperature value 210 °C
 Fig. shows 200 °C scaled to paper width
 rise: 50 mV/°C

lowest temperature value: 197 °C
 highest temperature value: 202 °C
 Fig. shows 5 °C scaled to paper width
 rise: 2000 mV/°C

```
>EPROG: Current
L Value 0.0°C
H Value 300.0°C
ExtSet 50.0°C
```

EPROG - Input

This input is necessary when the nominal value is to be determined and set by an external programmer.

Connect the external programmer to socket (31) REG+E-PROG of the programmable controller.

- The programmer input of the programmable controller can be matched to the output signal of the external programmer.

Voltage voltage input
Current current input

Select the desired input value with the P-key  and set with enter



- **„L Value“ - Setting the LOW value:**
 Adjust and set the lowest desired working temperature on the programmer (e.g. 0 °C).
 Enter this same temperature on the programmable controller by pressing the appropriate buttons on the keypad and press enter



to set.

- **„H Value“ - Setting the HIGH value:**
 Adjust and set the highest desired working temperature on the programmer (e.g. 300 °C).
 Enter this same temperature on the programmable controller by pressing the appropriate buttons on the keypad and press enter



to set.

- Return to the standard display by pressing escape 

```
>EPROG: Current
L Value  0.0°C
H Value  300.0°C
ExtSet   50.0°C
```

ESC 3x

```
EPROG : 50.00°C
IntAct: 50.00°C
Power:  50 %
Control: intern
```

Example:

- Setting a temperature of 50 °C on the external programmer!

The value adjusted and set on the external programmer is displayed in line 4 of the DIALOG-DISPLAY (LCD) for control purposes (Example: ExtSet: 50.0 °C).

After returning the LCD display to standard display by pressing escape

ESC („Setpoint“ - see page 38) this value is displayed in line 1 (Example: EPROG 50.00 °C).

This EPROG input enables the use of different voltage and current values as program parameters.

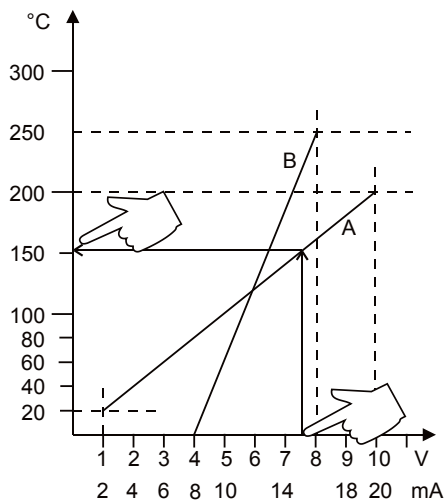

- „L Value“ - **Setting the LOW value:**

1) Adjust and set the lowest desired value on the voltage or current source resp. (Example A: 1 V).

2) Assign a lower temperature threshold value to this adjusted voltage/current value by pressing the appropriate buttons on the keypad of the programmable controller (Example A: 20 °C) and set

by pressing enter .

- „H Value“ - **Setting the HIGH value:**

1) Adjust and set the highest desired value on the voltage or current source resp. (Example A: 10 V).

2) Assign an upper temperature threshold value to this adjusted voltage/current value by pressing the appropriate buttons on the keypad of the programmable controller

(Example A: 200 °C) and set by pressing enter .

- Return to the standard display by pressing escape **ESC**.

Example B in the diagram serves to illustrate that the end point values are freely selectable.

Example out of diagram A:

- Adjusting the voltage source for an output of 7.6 V!

Line 4 of the DIALOG-DISPLAY (LCD) shows the externally set setpoint value. The programmable controller calculates this value from the rise angle of the two predecided end points (in example A: 7.6 V correspond to an external setpoint temperature of 152.0 °C).

After returning the LCD display to standard display by pressing escape

ESC, this value is displayed in line 1 (Example: EPROG 152.00 °C).

```
>EPROG: Current
L Value  20.0°C
H Value  200.0°C
ExtSet   152.0°C
```

ESC 3x

```
EPROG : 152.00°C
IntAct: 50.00°C
Power:  100 %
Control: intern
```

**Notice:**

If this adjustment is not correctly performed at two different points, the setpoint setting will be incorrect.

8.6. Limits

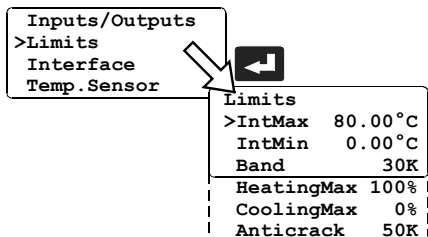

The limits IntMax and IntMin are only valid under external control (see 7.5. Internal / external control) They restrict the temperature of the internal bath to the desired maximum/minimum, also if the controller would require a higher/lower temperature for the external system. As a result the external setpoint may thus not be reached.

When operating the programmable controller under external control, band limiting is active. The preset value determines the maximum temperature difference between the internal bath and the external load. This adjustment possibility prevents sensitive equipment and temperature devices from damage.

The limitation „Crack protection“ shall avoid a partial overheating of the still thick-flowing temperature liquid after switching on the circulator.

Heating and cooling power of the programmable controller are adjustable.

100 % corresponds to the values in the technical specifications of the equipment.

- Select the submenu „Limits“ with enter
- Select the desired option with the up/down cursor keys . A flashing digit indicates that a value needs to be entered.

IntMax	see working temperature range page 8
IntMin	see working temperature range
Band	0 to 200 °C
HeatingMax	0 to 100 % in steps of 1 %
CoolingMax	0 to 100 % in steps of 1 %
Anticrack	30 K to 100 K

Factory settings:	
Band	200 K
HeatingMax	100 %
CoolingMax	0
Anticrack	30 K

- To set the newly entered value press enter
- To return to the previous menu level press escape



Notice: - CoolingMax -

The assembled C.U.-cooling unit the menu point CoolingMax has to be set to a value >0 (Recommendation: 100%). So the automatic control of the cooling can become active.



Notice:

The parameters >IntMax< and >IntMin< are only supported from programme version V°4.xx on. If the control electronics (V 4.xx) M2 / M3 is combined with an older version of the HT60 circulator, these parameters are not available. They will not be indicated in the menu.

8.7. Interface

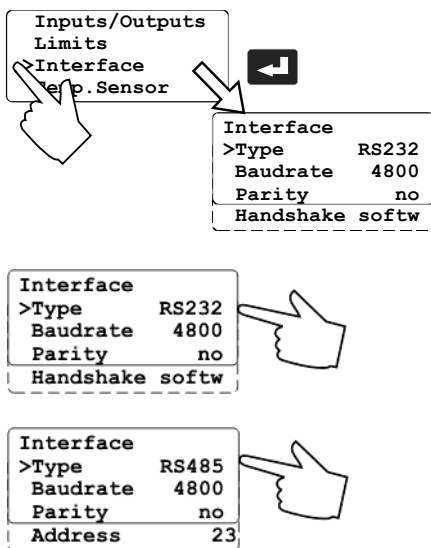

The interface parameters are set by selecting the submenu „Interface“ on the programmable controller. Normally, this is a one-time-only adjustment.

- Press enter to select the submenu „Interface“.
- Select the desired option with the up/down cursor keys . Enter the desired value for the flashing digit.
Type RS232 / RS485
Baudrate 2400/4800/9600
Parity none/even/odd
Handshake software handshake/hardware handshake
Address 0 to 127
- Press the P-key to select the desired parameter and set with enter .
- Return to the previous menu level with escape .

Factory settings
see - 11.1.

8.8. Sensors

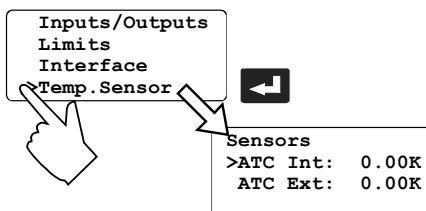

ATC - Absolute Temperature Calibration

- Select the submenu „Temp.Sensor“ with enter .
- Select the desired option with the up/down cursor keys . A flashing digit indicates that a value needs to be entered i.e. set.
ATC Int: internal sensor
ATC Ext: external sensor

Maximum setting ± 9.99 K

- Enter the desired compensating value and set this value by pressing ENTER .

Circulator (T_T)



Measuring point (T_M)

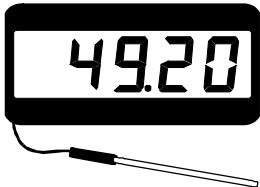

```
Sensors
>ATC Int: -0.80K
ATC Ext: 0.00K
```

ATC Int:

ATC serves to compensate a temperature difference that might occur between circulator and a defined measuring point in the bath tank because of physical properties.

- The difference temperature ($\Delta T = T_M - T_T$) is determined and stored as compensating value (example $\Delta T = -0.8 \text{ }^\circ\text{C}$).
- Use the keypad to enter the desired compensating value (e.g. -0.80) and set with enter

- The temperature on the measuring point rises to a temperature of 50.0 °C and is indicated on the MULTI-DISPLAY (LED).



Note:

The compensating factor always affects the actual working temperature, even when set via the interface connection.



ext. Pt100

Circulator (T_T)



```
Setp.: 50.00°C
ExtAct: 51.22°C
Power: 100 %
Control: intern
```

External sensor (T_{Pt100})

```
Sensors
>ATC Int: -0.80K
ATC Ext: 1.22K
```

ATC Ext:

serves calibration of an external Pt100 sensor.

- Immerse the Pt100 sensor in the circulator bath tank and allow the bath temperature to stabilize at 50 °C, for example.
- Read the temperatures of the factory calibrated circulator (T_T) and the external Pt100 sensor (T_{Pt100}) in their respective displays.
- Calculate the temperature difference and enter and set this difference value as the ATC external compensating parameter. (Example: $\Delta T = T_{Pt100} - T_T = 1.22 \text{ }^\circ\text{C}$)
- Use the keypad to enter the desired compensating value (e.g. 1.22 °C) and set with enter



Notice:

The ATC function remains active until reset to 00.00 °C.

9. Troubleshooting guide / Error messages

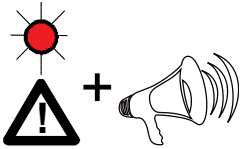

E 01

E 02

E 05

E 06

E 07

E 12

E 14

E 15

E 19

E 31

E 33

E 34

E 35

Whenever the microprocessor electronics registers a failure, a complete shutdown of the circulator is performed. The alarm light "▲" illuminates and a continuous signal tone sounds.

- The circulator is operated without bath liquid, or the liquid level is insufficient. Replenish the bath tank with the bath liquid.
- Tube breakage has occurred (insufficient filling level due to excessive bath liquid pumped out). Replace the tubing and replenish the bath tank with the bath liquid.
- The float is defect (e. g., because damaged in transit). Repair by authorized JULABO service personnel.
- Failure of one or both temperature sensors of the CU-unit.
- Cable of the working temperature sensor interrupted or short-circuited.
- Defect of the working or safety temperature sensor.
Working temperature and safety sensors report a temperature difference of more than 100 K.
- Other errors (I²C-BUS errors)
- Error in A/D converter.
- Safety sensor defect.
 - The safety temperature value lies below the working temperature setpoint. Set the safety temperature to a higher value.
- External control selected, but external Pt100 sensor not connected.
- Error in the measuring system of the external temperature sensor „EXT“.
- Error at the internal Interface
- Safety sensor 1:
Cable of the safety sensor 1 interrupted or short-circuited.
- Safety sensor 2:
Cable of the safety sensor 2 interrupted or short-circuited.
- Safety sensor 3:
Cable of the safety sensor 3 interrupted or short-circuited.



- Safety sensor in the cooling zone:
Cable of the safety sensor interrupted or short-circuited.



- Safety sensor in the cooling zone: The temperature in the cooling zone has exceeded 170 °C. See „Important notice“ Page 24.

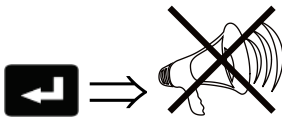

- Press enter  to quit the audible signal.

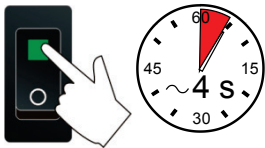

After eliminating the malfunction, press the mains power switch off and on again to cancel the alarm state.

- If the unit cannot be returned to operation, contact an authorized JULABO service station.

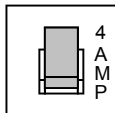
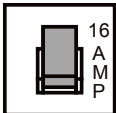

Mains Fuses M2, M3:

- Mains circuit breakers (resettable) for the circulator (16 A) and the CU-unit (4 A) on the rear of the housing are safety machines.

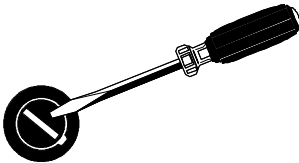

Mains Fuses M2:

The mains fuses (36) on the rear of the unit may easily be exchanged as shown on the left – T 16 A.



Warning:

Before exchanging the fuses, turn off the mains power switch and disconnect the power plug from the mains socket!

Only use fine fuses with a nominal value as specified.

Example:

Manufacturer	Supplier	Type	Order No.
Schurter	Schurter	G-fuse insert SPT T16A 5x20mm	No. 0001.2516

10. Electrical connections

Notice:

Use shielded cables only.

The shield of the connecting cable is electrically connected to the plug housing.

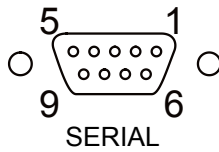

RS232/RS485 serial interface (30)

This port can be used to connect a computer with an RS232 or RS485 cable for remote control of the circulator.

Pin assignments RS232:

Pin 2	RxD	Receive Data
Pin 3	TxD	Transmit Data
Pin 5	0 V	Signal GND
Pin 7	RTS	Request to send
Pin 8	CTS	Clear to send

Pin 1; 4; 6, 9 Reserved - do not use!

Pin assignments: RS485

Pin 3	A	
Pin 5	0 VD	Signal GND
Pin 8	B	
Pins 1, 2, 4, 6, 7, 9		Reserved - do not use!

Accessories:

Order No.	Description
8 980 073	RS232 interface cable 9-pol./9-pol. , 2,5 m
8 900 110	USB interface adapter cable

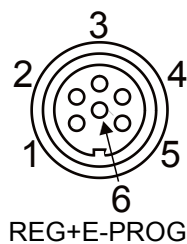

Programmer input / temperature recorder output (31)

Analog inputs / outputs see page 49

Pin		Signal
1	Voltage output	Channel 1 0 ... 10 V
2	Voltage output	Channel 2 0 ... 10 V
3	GND for outputs	0 V
4	Programmer input	EPROG 0 to 10 V / 0 to 20 mA
5	Current output	Channel 3 0 to 20 mA / 4 to 20 mA
6	GND for Programmer	0 V

Alarm output (33)

(for external alarm signal)

This potential-free change-over contact is activated in case of an alarm when pins 2 and 3 are connected.

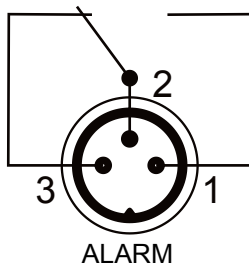

Switching capacity	max.	30 W / 40 VA
Switching voltage	max.	125 V~/-
Switching current	max.	1 A

STAND-BY input (32)

(for external emergency switch-off)

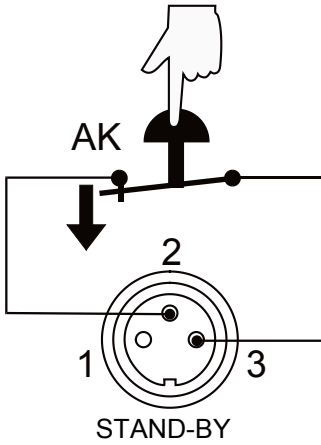

Pin assignment:	Pin	Signal
	1	not connected
	2	5 V / DC
	3	0 V

Use shielded cables only.

Activate the stand-by input:

- Under menu item Stand-by, set the parameter to „yes“ (see page 39).
- Connect an external contact 'AK' (e.g. for emergency switch-off) or an alarm contact of the superordinated system.

In case the connection between Pin 2 and Pin 3 is interrupted by opening the contact 'AK', a complete shutdown of the circulating pump and heater is effected, and the unit enters the condition "OFF".

As long as the contact remains open, line 4 of the DIALOG-DISPLAY (LCD) flashes and displays the message „STAND-BY“.

If the contact is reclosed, the circulator returns to the stand-by status and „OFF“ is displayed.

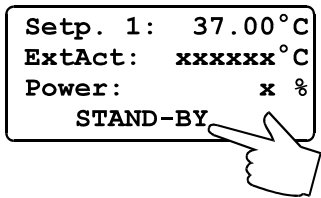

Additional tips for using the STAND-BY input:

The Stand-by function can be used in conjunction with the AUTOSTART feature (see page 38)

1. If the Autostart function is NOT turned ON, the Stand-by input should be used as described above.
2. If the Autostart function is enabled, the instrument will revert back to the original method of entering the setpoint (i.e. keypad, RS232, Analog input, etc.).

- Entering the setpoint with the keypad, for example T. As described above, an bipolar shut-down is accompanied by the "STAND-BY" display and the OFF status. The programmable controller starts again when the contact is reclosed. The temperature of the bath liquid changed during the STAND-BY status.
- Entering the setpoint with the programmer (see pages 43 and 45). The display „STAND-BY“ appears. The setpoint value and the time are both held at the current value. The temperature of the bath fluid will be held constant at this temperature. The programmer continues once the contact is reclosed.

⚠ Warning: this is not an actual shutoff feature

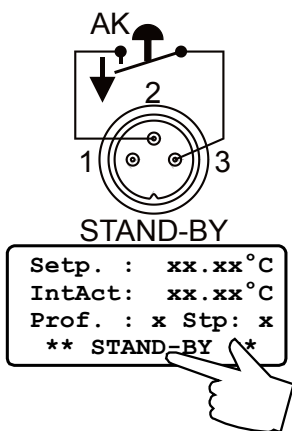

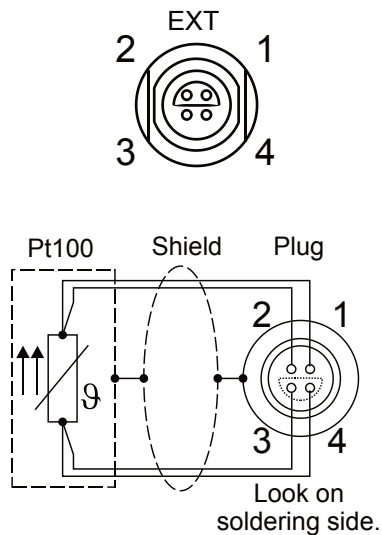

Socket for external Pt100 sensor (19)

Pin assignment:

Pin	Signal
1	I+
2	U+
3	U-
4	I-

The shield of the connecting cable is electrically connected to the plug housing and the sensor tube.

11. Remote control

11.1. Setup for remote control

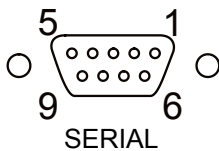

Select the „Configuration“ submenu and select the option „Setpoint“ to define the interface (see page 38).

The interface parameters are set by selecting the submenu „Interface“ on the circulator. Normally, this is a one-time-only adjustment. (Selecting and setting menu items, see page 53.)

Factory settings:

RS232

BAUDRATE 4800 bauds

PARITY even parity

HANDSHAKE Protocol RTS/CTS
(hardware handshake)

Data bits 7

Stop bit 1



Like all parameters which can be entered through the keypad, interface parameters are stored in memory even after the circulator is turned off.

11.2. Communication with a PC or a superordinated data system

Suitable terminal programs for communicating with a PC are:

- MS-Windows - TERMINAL.EXE (included with MS-Windows).
- **Easy Temp** control software – allows programming, viewing, and recording of temperature and time dependent processes when using a single JULABO instrument.
Download free of charge from www.julabo.com or Julabo Order No. 8 901 102.



If the circulator is put into remote control mode via the configuration level, the display will read "r OFF" = REMOTE STOP.

The circulator is now operated via the computer.

In general, the computer (master) sends commands to the circulator (slave). The circulator sends data (including error messages) only when the computer sends a query.

A transfer sequence consists of:

- address (RS485 interface only)
- command
- space (↔ Hex: 20)
- parameter (the character separating decimals in a group is the period)
- end of file (↵; Hex: 0D)

The commands are divided into **in** or **out** commands.

in commands: asking for parameters to be displayed

out commands: setting parameters

The **out** commands are valid only in remote control mode.



When the RS485 interface is used, the three-digit instrument address stands in front of each command.

(example: address Ad32 = **A032**)

Examples:

Command to set the working temperature T to 55.5 °C

out_sp_00 ↔ 55.5↵

A032_out_sp_00 ↔ 55.5↵

Command to ask for the working temperature T:

in_sp_00↵

A032_in_sp_00↵

Response from the circulator:



55.5↵

A032_55.5↵

11.3. List of commands

When the RS485 interface is used, the instrument address stands in front of each command (Axxx_).



in-commands: Asking for parameters or temperature values to be displayed.

Command	Parameter	Response of circulator
version	none	Number of software version (V X.xx)
status	none	Status message, error message (see page 64)
in_pv_00	none	Actual bath temperature.
in_pv_01	none	Heating power being used (%).
in_pv_02	none	Temperature value registered by the external Pt100 sensor.
in_pv_03	none	Temperature value registered by the safety sensor.
in_pv_04	1 8	Liquid level indication.
in_pv_05	none	Temperature value registered by the safety sensor 1
in_pv_06	none	Temperature value registered by the safety sensor 2 (only HT60)
in_pv_07	none	Temperature value registered by the safety sensor 3 (only HT60)
in_sp_00	none	Working temperature "T"
in_sp_03	none	High temperature warning limit "  ".
in_sp_04	none	Low temperature warning limit "  ".
in_sp_05	none	Setpoint temperature of the external programmer (socket 31 - REG+E-PROG) .
in_hil_00	none	Max. cooling power (%).
in_hil_01	none	Max. heating power (%).
in_mode_01	none	Type of setpoint setting 0 = via keypad  2 = via the analog interface E-PROG
in_mode_02	none	Identification type: 0 = no identification 1 = single identification 2 = continual identification

in-commands: Asking for parameters or temperature values to be displayed.
--

Command	Parameter	Response of circulator
in_mode_03	none	Type of the programmer input: 0 = Voltage 0 V to 10 V 1 = Current 0 mA to 20 mA
in_mode_04	none	Internal/external temperature control: 0 = Temperature control in the circulator bath. 1 = Temperature control with external Pt100 sensor.
in_mode_05	none	Circulator in Stop/Start condition: 0 = Stop 1 = Start
in_mode_08	none	Adjusted control dynamics 0 = aperiodic 1 = standard
in_par_01	none	Time constant of the external bath.
in_par_02	none	Internal slope.
in_par_03	none	Time constant of the internal bath.
in_par_04	none	Band limiting (max. difference between the temperatures in the internal bath and external system).
in_par_06	none	Xp control parameter of the internal controller.
in_par_07	none	Tn control parameter of the internal controller.
in_par_08	none	Tv control parameter of the internal controller.
in_par_09	none	Xp control parameter of the cascade controller.
in_par_10	none	Proportional portion of the cascade controller.
in_par_11	none	Tn control parameter of the cascade controller.
in_par_12	none	Tv control parameter of the cascade controller.
in_par_13	none	Adjusted maximum internal temperature in case of cascade control
in_par_14	none	Adjusted minimum internal temperature in case of cascade control

out commands: Setting parameters or temperature values.
--

Command	Parameter	Response of circulator
out_mode_02	0	No identification. Temperature control by using the stored parameters.
out_mode_02	1	Single identification of controlled system after the next start.
out_mode_02	2	Continual identification of controlled system whenever a new setpoint is to be reached.
out_mode_04	0	Temperature control of internal bath.
out_mode_04	1	External control with Pt100 sensor.
out_mode_05	0	Stop the circulator = r OFF.
out_mode_05	1	Start the circulator.
out_mode_08	0	Control dynamics aperiodic
out_mode_08	1	Control dynamics standard
out_sp_00	xxx.x	Set working temperature "T".
out_sp_03	xxx.x	Set high temperature warning limit 
out_sp_04	xxx.x	Set low temperature warning limit 
out_hil_00	xxx	Set the desired maximum cooling power (0 % to 100 %). This adjustment is required only for proportionally controlled refrigerated circulators.
out_hil_01	xxx	Set the desired maximum heating power (10 % to 100 %).
out_par_04	xxx	Band limiting during external control. Setting the maximum difference between the temperatures in the internal bath and external system.
out_par_06	xxx	Xp control parameter of the internal controller. (**
out_par_07	xxx	Tn control parameter of the internal controller. (**
out_par_08	xxx	Tv control parameter of the internal controller. (**
out_par_09	xxx	Xp control parameter of the cascade controller. (**
out_par_10	xxx	Proportional portion of the cascade controller. (**
out_par_11	xxx	Tn control parameter of the cascade controller. (**
out_par_12	xxx	Tv control parameter of the cascade controller. (**
out_par_13	xxx.xx	Maximum internal temperature in case of cascade control

Remote control

Command	Parameter	Response of circulator
out_par_14	xxx.xx	Minimum internal temperature in case of cascade control

```

Configuration
>Identif.    off
Setpoint    RS232
Autostart   off
    
```





(**

An adjustment of these values via a serial interface only makes sense, if the parameter for the identification is on >off<.

If the identification is adjusted (see page 37), the control parameters Xp, Tn and Tv of a control course are determined and stored automatically. Therefore the adjusted values are overwritten.

11.4. Status messages / error messages

The circulator sends data (including error messages) only when the computer sends a query.

Status messages	Description
00 MANUAL STOP	Circulator in "OFF" state.
01 MANUAL START	Circulator in keypad control mode.
02 REMOTE STOP	Circulator in "r OFF" state.
03 REMOTE START	Circulator in remote control mode.
Error messages	Description
-01 LOW LEVEL ALARM	Low liquid level alarm
-02 COOLING UNIT ALARM	Failure of one or both temperature sensors of the C.U. cooling unit.
-03 EXCESS TEMPERATURE WARNING	High temperature warning "  ".
-04 LOW TEMPERATURE WARNING	Low temperature warning "  ".
-05 WORKING SENSOR ALARM	Working temperature sensor short-circuited or interrupted.
-06 SENSOR DIFFERENCE ALARM	Sensor difference alarm. Working temperature and safety sensors report a temperature difference of more than 100 K.
-07 I²C-BUS ERROR	Internal error when reading or writing the I ² C bus.
-08 INVALID COMMAND	Invalid command.
-09 COMMAND NOT ALLOWED IN CURRENT OPERATING MODE	Invalid command in current operating mode.
-10 VALUE TOO SMALL	Entered value too small.
-11 VALUE TOO LARGE	Entered value too large.

Error messages	Description
-12 TEMPERATURE MEASUREMENT ALARM	Error in A/D converter.
-13 WARNING : VALUE EXCEEDS TEMPERATURE LIMITS	Value lies outside the adjusted range for the high and low temperature warning limits. But value is stored.
-14 TEMPERATURE/LEVEL ALARM	Safety temperature alarm
-15 EXTERNAL SENSOR ALARM	External control selected, but external Pt100 sensor not connected.
-19 TEMPERATUR MEASUREMENT ALARM	Error in the measuring system of the external temperature sensor „EXT“
-26 STAND-BY PLUG IS MISSING	External stand-by contact is open.
-31 INTERNAL COMMUNICATION ERROR	Communication between circulator HTxx and the control electronics Mx.
-33 SAFETY SENSOR 1 ALARM	Safety sensor 1: Cable of the safety sensor 1 interrupted or short-circuited.
-34 SAFETY SENSOR 2 ALARM	Safety sensor 2: Cable of the safety sensor 2 interrupted or short-circuited.
-35 SAFETY SENSOR 3 ALARM	Safety sensor 3: Cable of the safety sensor 3 interrupted or short-circuited.
-36 SENSOR COOLING ZONE ALARM	Safety sensor in the cooling zone: Cable of the safety sensor interrupted or short-circuited.
-37 INTERNAL ALARM	Safety sensor in the cooling zone: The temperature in the cooling zone has exceeded 170 °C! See „ Important notice Page 24

12. Cleaning / repairing the unit



Caution:

- Always turn off the unit and disconnect the mains cable from the power source before cleaning the unit.
- Prevent humidity from entering into the circulator.
- Electrical connections and any other work must be performed by qualified personnel only.

Cleaning the unit outside

Clean the outside of the unit using a wet cloth and low surface tension water (e.g., soap suds).

Before applying a cleaning or decontamination method different from the one recommended by JULABO, the user has to make sure with the manufacturer, that the planned method does not damage the unit.

The circulator is designed for continuous operation under normal conditions. Periodic maintenance is not required.

Repairs

Before asking for a service technician or returning a JULABO circulator for repair, please contact an authorized JULABO service station.

When returning the unit:

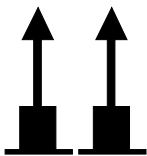

- Empty completely, remove the expansion tank, close tightly the connections with nuts and closing caps.
- Careful and appropriate packing is important.
- During transport the unit has to stand upright. Mark the packing correspondingly.
- When returning a unit, take care of careful and adequate packing. JULABO is not responsible for damages that might occur from insufficient packing.



JULABO reserves the right to carry out technical modifications with repairs for providing improved performance of a unit.

13. WARRANTY PROVISIONS

The following Warranty Provisions shall apply to products sold in North America by Julabo (“**Seller**”) to the entity shown as buyer (“**Buyer**”) on Seller’s invoice.

1. **Initial Warranty.** Upon Seller’s receipt of payment in full for the products and subject to Buyer’s compliance with the terms of sale and any other agreement with Seller relating to the products, Seller warrants to the Buyer that the products manufactured by the Seller are free from defects in material and workmanship for a period not to exceed two (2) years or ten thousand (10,000) hours of operation, whichever comes first, from the date the product is shipped by Seller to Buyer (the “**Initial Warranty**”).

2. **EXCLUSION OF ALL OTHER EXPRESS WARRANTIES; EXCLUSION OF ALL IMPLIED WARRANTIES. OTHER THAN THE INITIAL WARRANTY, NO OTHER EXPRESS WARRANTIES ARE MADE. ALL IMPLIED WARRANTIES OF EVERY TYPE AND KIND, INCLUDING BUT NOT LIMITED TO ANY IMPLIED WARRANTY OF MERCHANTABILITY OR FITNESS FOR A PARTICULAR PURPOSE OR USE, ARE EXCLUDED IN ALL RESPECTS AND FOR ALL PURPOSES. SELLER DISCLAIMS AND MAKES NO IMPLIED WARRANTIES WHATSOEVER.**

3. **Exclusions.** The Initial Warranty does not include damage to the product resulting from accident, misuse, improper installation or operation, unauthorized or improper repair, replacement or alteration (including but not limited to repairs, replacements, or alterations made or performed by persons other than Seller’s employees or authorized representatives), failure to provide or use of improper maintenance, unreasonable use or abuse of the product, or failure to follow written installation or operating instructions. Buyer must return the product’s record of purchase to the Seller or one of Seller’s authorized representatives within thirty (30) days of the date the product is shipped by Seller to Buyer in order to make a claim under the Initial Warranty. Notwithstanding anything contained herein to the contrary, all glassware, including but not limited to reference thermometers, are expressly excluded from the Initial Warranty.

4. **Buyer’s sole remedies; Limitations on Seller’s Liability.** Buyer’s sole and exclusive remedy under the Initial Warranty is strictly limited, in Seller’s sole discretion, to either: (i) repairing defective parts; or (ii) replacing defective parts. In either case, the warranty period for the product receiving a repaired or replaced part pursuant to the terms of the Initial Warranty shall not be extended. All repairs or replacements performed by Seller pursuant to these Warranty Provisions shall be performed at Seller’s facility in Allentown, Pennsylvania, U.S.A. or at the facility of an authorized representative of Seller, which location shall be determined by Seller in its sole discretion; provided, however, that Seller may, in its sole discretion perform such repairs or replacements at Buyer’s facility in which case Buyer shall pay Seller’s travel, living and related expenses incurred by Seller in performing the repairs or replacements at Buyer’s facility. As a condition precedent to Seller’s obligation to repair or replace a product part under the Initial Warranty, Buyer shall (i) promptly notify Seller in writing of any such defect; (ii) shall have returned the product’s record of purchase to Seller or to one of Seller’s authorized representatives within thirty (30) days of the date the product is delivered to Buyer; and (iii) assist Seller in all respects in its attempts to determine the legitimacy and basis of any claims made by or on behalf of Buyer including but not limited to providing Seller with access to the product to check operating conditions. If Buyer does not provide such written notice to Seller within the Initial Warranty period or fails to return the product’s record of purchase as set forth above, Seller shall have no further liability or obligation to Buyer therefore. In no event shall Seller’s liability under the Initial Warranty exceed the original purchase price of the product which is the subject of the alleged defect.

5. **THE REMEDIES PROVIDED IN THE INITIAL WARRANTY ARE THE SOLE AND EXCLUSIVE REMEDIES AVAILABLE TO THE BUYER. NOTWITHSTANDING ANYTHING TO THE CONTRARY CONTAINED HEREIN, AND EVEN IF THE SOLE AND EXCLUSIVE REMEDIES FAIL OF THEIR ESSENTIAL PURPOSE FOR ANY REASON WHATSOEVER, IN NO EVENT SHALL SELLER BE LIABLE FOR BUYER’S MANUFACTURING COSTS, LOST PROFITS, GOODWILL, OR ANY OTHER SPECIAL, INDIRECT, PUNITIVE,**

WARRANTY PROVISIONS

INCIDENTAL OR CONSEQUENTIAL DAMAGES TO BUYER OR ANY THIRD PARTY AND ALL SUCH DAMAGES ARE HEREBY DISCLAIMED.

6. **Assignment.** Buyer shall not assign any of its rights or obligations hereunder without the prior written approval of Seller; provided, however, that if Buyer is a distributor of Seller, the rights and obligations of Buyer under these Warranty Provisions shall inure to the benefit of and be binding upon Buyer's customers who provide the product's proof of purchase to Seller pursuant to the terms set forth herein. Seller may assign any or all of its rights or obligations hereunder without Buyer's prior consent.

7. **Governing Law.** The Warranty Provisions and all questions relating to their validity, interpretation, performance, and enforcement shall be construed in accordance with, and shall be governed by, the substantive laws of the Commonwealth of Pennsylvania without regard to its principles of conflicts of law.

8. **Waiver.** Any failure of the part of Seller to insist on strict compliance with the Warranty Provisions shall no way constitute a waiver of such right. No claim or rights arising out of a breach of the Warranty Provisions by Buyer may be discharged in whole or in part by a waiver of the claim or right, unless the waiver is in writing signed by an authorized representative of Seller. Seller's waiver or acceptance of any breach by Buyer of any provisions of the Warranty Provisions shall not constitute a waiver of or an excuse for nonperformance as to any other provision of the Warranty Provisions nor as to any prior or subsequent breach of the same provision.

9. **Freight.** Buyer will arrange and pay for shipping and handling charges for the unit to be returned to the Seller. Seller will arrange and pay for shipping and handling for the return of the unit to the Buyer.