

OPERATING MANUAL

ME

Refrigerated and Heating Circulators

F25-ME

F26-ME

F32-ME

F33-ME

F34-ME

FP40-ME

FP50-ME

water-cooled

FPW50-ME

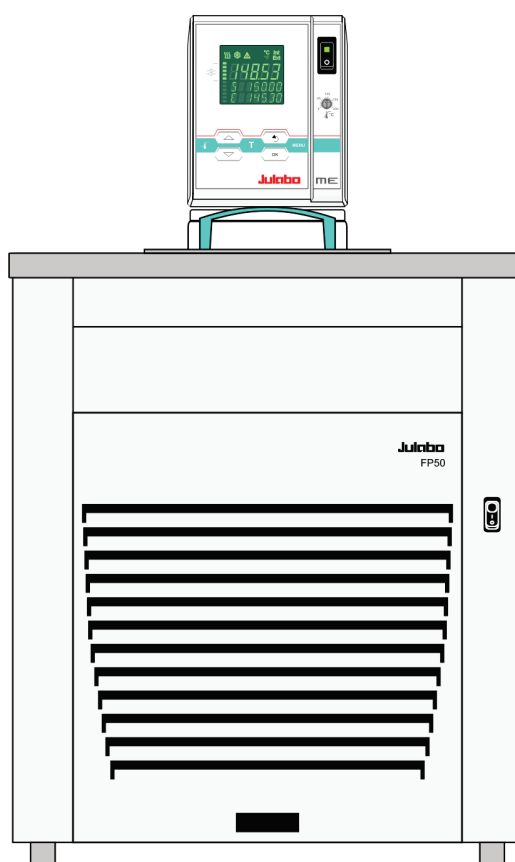

Translation of the Original Operating Manual



JULABO USA, Inc.
884 Marcon Boulevard
Allentown, PA 18109
Phone: +1(610) 231-0250
Fax: +1(610) 231-0260
info.us@julabo.com
www.julabo.com

Congratulations!

You have made an excellent choice.

JULABO thanks you for the trust you have placed in us.

This operating manual has been designed to help you gain an understanding of the operation and possible applications of our circulators. For optimal utilization of all functions, we recommend that you thoroughly study this manual prior to beginning operation.

The JULABO Quality Management System



Temperature control devices for research and industry are developed, produced, and distributed according to the requirements of ISO 9001 and ISO 14001. Certificate Registration No. 01 100044846

Unpacking and inspecting

Unpack the circulator and accessories and inspect them for possible transport damage. Damage should be reported to the responsible carrier, railway, or postal authority, and a damage report should be requested. These instructions must be followed to the full extent for us to guarantee our full support of your claim for protection against loss from concealed damage. The form required for filing such a claim will be provided by the carrier



1.953.0512-V3 03/16

Printed in Germany

Changes without prior notification reserved

Important: keep operating manual for future use

TABLE OF CONTENTS

Operating manual.....	5
1. Intended use.....	5
1.1. Description.....	5
2. Operator responsibility – Safety recommendations.....	6
2.1. Disposal.....	8
2.2. Technical specifications.....	9
2.3. Cooling water connection.....	13
Operating instructions.....	14
3. Safety notes for the user.....	14
3.1. Explanation of safety notes.....	14
3.2. Explanation of other notes.....	14
3.3. Safety recommendations.....	15
4. Operating controls and functional elements.....	17
4.1. Circulator.....	17
4.2. Cooling Machine.....	19
5. Preparations.....	20
5.1. Installation.....	20
5.2. Bath fluids.....	20
5.3. Temperature application to external systems.....	21
5.3.1. Tubing.....	22
5.4. Filling / draining.....	23
6. Operating procedures.....	24
6.1. Power connection.....	24
6.2. Switching on / Start - Stop.....	24
6.2.1. Switching on the circulator.....	24
6.2.2. Switching on the Cooling Machine.....	25
7.  Setting of temperatures.....	26
7.1. Using the pre-settings in the  menu.....	26
7.2. Direct setting of temperatures.....	27
8.  Safety installations, warning functions.....	28
8.1. Excess temperature protection.....	28
8.1.1. Early warning system, low level protection.....	29
8.2. Switch-over from warning to shutdown function.....	30

8.3. Over and Sub temperature warning function	31
9. MENU Menu functions.....	32
9.1. MENU PROGRAM – START	33
9.2. MENU PROGRAM – creation, administration.....	35
9.3. MENU PUMP – Setting of pump pressure.....	37
9.4. MENU CONFIG – Configuration of unit.....	38
9.4.1.REMOTE	39
9.4.2.AUTOSTART.....	39
9.4.3.OFF-MODE	40
9.4.4.Setting of clock and date	40
9.4.5.RESET – Factory settings	40
9.5. MENU CONTROL – Control characteristics and parameters	41
9.5.1.CONTROL – Control INTERNAL / EXTERNAL.....	42
9.5.2.Dynamic internal.....	43
9.5.3.Control parameters – XPU-, XP-, TN-, TV- EXTERNAL.....	43
9.5.4.Control parameters– XP-, TN-, TV- INTERNAL	44
9.6. MENU SERIAL - BAUDRATE, HANDSHAKE, PARITY.....	45
9.7. MENU ATC - Absolut Temperature Calibration	46
9.7.1.ATC SENSOR - INTERNAL / EXTERNAL.....	48
9.7.2.ATC STATUS - YES / NO.....	48
9.7.3.CALIBRATION TYPE: 1 -/ 2 -/ 3 POINT	49
9.7.4.Example: 3-point calibration for internal control	50
9.8. MENU LIMITS.....	52
9.8.1.Limits for internal control.....	53
9.8.2.Limits for external control.....	53
10. Troubleshooting guide / error messages.....	55
11. Electrical connections	58
12. Remote control	59
12.1. Setup for remote control.....	59
12.2. Communication with a PC or a superordinated data system	60
12.3. List of commands	61
12.4. Status messages	63
12.5. Error messages.....	63
13. JULABO Service – Online remote diagnosis.....	65
14. Cleaning / repairing the unit.....	66
15. WARRANTY PROVISIONS	67

Operating manual

1. Intended use

JULABO circulators have been designed to control the temperature of specific fluids in a bath tank. The units feature pump connections for temperature control of external systems (loop circuit).



JULABO circulators are not suitable for direct temperature control of foods, semi-luxury foods and tobacco, or pharmaceutical and medical products. Direct temperature control means unprotected contact of the object with the bath medium (bath fluid).

1.1. Description

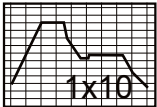
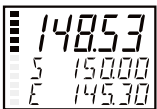

PID3

ATC3

RS232

Pt100

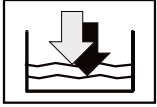
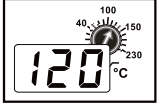

SMART PUMP

- The circulators are operated via the splash-proof keypad. The microprocessor technology allows different values to be set, stored, and displayed on the VFD COMFORT-DISPLAY. Three menu keys facilitate the adjustment of setpoints, warning and safety functions, and menu functions.
- Temperature- and time-dependent processes can be stored and executed using the integrated programmer.
- The adjustable PID cascade temperature control automatically adjusts the heat supply to the thermal requirements of the bath.
- Absolute Temperature Calibration (ATC3) provides high temperature stability at all points in the bath. With the 3-point calibration, an offset is adjusted at three temperatures to ensure an accurate temperature pattern at the selected spot in the bath over the entire temperature range.
- Electrical connections:
 RS232 interface for modern process technology without an additional interface. Connection for external Pt100 sensor for external temperature measurement and control.
 Alarm output for external alarm message or control of JULABO refrigerating baths or solenoid valve (cooling water).
- The excess temperature protection according to IEC 61010-2-010 is a safety device independent from the control circuit. Its safety value can be displayed and adjusted on the VFD COMFORT-DISPLAY.
- The early warning system for low level signals that bath fluid needs to be refilled before the low level protection according to IEC 61010-2-010 triggers a safety shutdown of the main functional elements.
- Intelligent pump system: the pump capacity (electronically adjustable via the motor speed) can be adapted to different conditions for internal and external temperature-control applications.

2. Operator responsibility – Safety recommendations

The products of JULABO ensure safe operation when installed, operated, and maintained according to common safety regulations. This section explains the potential dangers that may arise when operating the circulator and also specifies the most important safety precautions to preclude these dangers as far as possible.

- The operator is responsible for the qualification of the personnel operating the units.
- The personnel operating the units should be regularly instructed about the dangers involved with their job activities as well as measures to avert these dangers.
- Make sure all persons tasked with operating, installing, and maintaining the unit have read and understand the safety information and operating instructions.
- When using hazardous materials or materials that could become hazardous, the circulator may be operated only by persons who are absolutely familiar with these materials and the circulator. These persons must be fully aware of possible risks.

If you have any questions concerning the operation of your unit or the information in this manual, please contact us!

Contact

JULABO USA, Inc.
884 Marcon Boulevard
Allentown, PA 18109

Phone: +1(610) 231-0250
Fax: +1(610) 231-0260
info.us@julabo.com
www.julabo.com

Safety instructions for the operator:

- You have received a product designed for industrial use. Nevertheless, avoid strikes to the housing, vibrations, damage to the operating-element panel (keypad, display), and contamination.
- Make sure the product is checked for proper condition regularly (depending on the conditions of use). Regularly check (at least every 2 years) the proper condition of the mandatory, warning, prohibition and safety labels.
- Make sure that the mains power supply has low impedance to avoid any negative effects on instruments being operated on the same mains.
- This unit is designed for operation in a controlled electromagnetic environment. This means that transmitting devices (e.g., cellular phones) should not be used in the immediate vicinity. Magnetic radiation may affect other devices with components sensitive to magnetic fields (e.g., monitors). We recommend maintaining a minimum distance of 1 m.
- Permissible ambient temperature: max. 40 °C, min. 5 °C.
- Permissible relative humidity: 50% (40 °C).
- Do not store the unit in an aggressive atmosphere.
- Protect the unit from contamination.
- Do not expose the unit to sunlight.

Appropriate operation

Only qualified personnel is authorized to perform configuration, installation, maintenance and repairs of the circulator.

Routine operation can also be carried out by untrained personnel who should however be instructed by trained personnel.

Use:

The bath can be filled with flammable materials. Fire hazard!

There might be chemical dangers depending on the bath medium used.

Observe all warnings for the used materials (bath fluids) and the respective instructions (safety data sheets).



Insufficient ventilation may result in the formation of explosive mixtures. Only use the unit in well ventilated areas.

Only use recommended materials (bath fluids). Only use non-acid and non corroding materials.

When using hazardous materials or materials that could become hazardous, **the operator must** affix the enclosed safety labels to the front of the unit so they are highly visible:

If this unit is intended for use within the United States of America, all 3 warning labels **must** be affixed to the housing of the unit prior to use.

Directions for the positioning of the individual warning labels are enclosed with the warning labels included in the delivery. Warning labels must be easily visible to users.

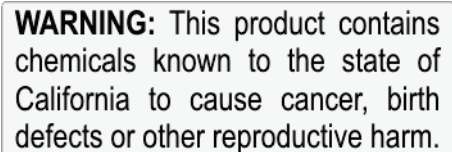
1		Warning label W00: Colors: yellow, black Danger area. Attention! Observe instructions. (operating manual, safety data sheet)
2		Mandatory label M018: Colors: blue, white Carefully read the user information prior to beginning operation. Scope: EU
or		
2		Semi S1-0701 Table A1-2 #9 Carefully read the user information prior to beginning operation. Scope: USA, NAFTA
3		Warning label Proposition 65

Particular care and attention is necessary because of the wide operating range.

There are thermal dangers: Burn, scald, hot steam, hot parts and surfaces that can be touched.

	Warning label W26: Colors: yellow, black Hot surface warning. (The label is put on by JULABO)
---	---

Observe the instructions in the manuals for instruments of a different make that you connect to the circulator, particularly the respective safety recommendations. Also observe the pin assignment of plugs and technical specifications of the products.

2.1. Disposal

The circulator contains a back-up battery that supplies voltage to memory chips when the unit is switched off. Do not dispose of the battery with household waste!

Depending on battery regulations in your country, you might be obliged to give back used or defect batteries to gathering places.

The product may be used with oil as bath fluid. These oils fully or partially consist of mineral oil or synthetic oil. For disposal, observe the instructions in the safety data sheets.

These units contains refrigerants– at this time considered not to have any negative effects on the ozone layer. However, during the long operating period of the unit, disposal prescriptions may change. So only qualified personnel should take care of disposal.

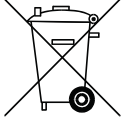

Contact an authorized waste management company in your country.
Disposal with household waste (unsorted waste) or similar collections of municipal waste is not permitted!

2.2. Technical specifications

			F25-ME
Working temperature range		°C	-28 ... 200
Temperature stability		°C	±0,01
Cooling capacity		°C	<u>+20 0 -20</u>
Medium ethanol		kW	0.26 0.2 0.06
Refrigerant			R134a
Overall dimensions	(WxDxH)	cm	23x42x61
Bath opening	(WxL)	cm	12x14
Bath depth		cm	14
Filling volume	from ... to	liters	3 ... 4,5
Weight		kg	31
Mains power connection		V/ Hz	230 / 50
Current draw	(at 230 V)	A	12
Current draw	(at 230 V) CH	A	<9 + 2>
Mains power connection		V/ Hz	208-230 / 60
Current draw	(at 230 V)	A	12
Mains power connection		V/ Hz	115 / 60
Current draw	(at 115 V)	A	13
Mains power connection		V/ Hz	100 / 50/60
Current draw	(at 100 V)	A	13

			F26-ME	F32-ME
Working temperature range		°C	-28 ... 200	-30 ... 200
Temperature stability		°C	±0,01	±0,01
Cooling capacity		°C	<u>+20 0 -20</u>	<u>+20 0 -20 -30</u>
Medium ethanol		kW	0.26 0.2 0.06	0.45 0.39 0.15 0.05
Refrigerant			R134a	R134a
Overall dimensions	(WxDxH)	cm	42x42x42	31x42x64
Bath opening	(WxL)	cm	12x14	18x12
Bath depth		cm	14	15
Filling volume	from ... to	liters	3 ... 4,5	5,5 ... 8
Weight		kg	31	37
Mains power connection		V/ Hz	230 / 50	230 / 50
Current draw	(at 230 V)	A	12 (CH: 2)	12
Mains power connection		V/ Hz	208-230 / 60	208-230 / 60
Current draw	(at 230 V)	A	-----	12
Current draw	(at 208 V)	A	-----	10
Mains power connection		V/ Hz	115 / 60	115 / 60
Current draw	(at 115 V)	A	13	14
Mains power connection		V/ Hz	100 / 50/60	100 / 50/60
Current draw	(at 100 V)	A	13	14

All measurements have been carried out at:
 rated voltage and frequency ambient temperature: 20 °C
 Technical changes without prior notification reserved.

Operator responsibility – Safety recommendations

			F33-ME	F34-ME
Working temperature range		°C	-30 ... 200	-30 ... 150
Temperature stability		°C	±0,01	±0,01
Cooling capacity		°C	<u>+20 0 -20 -30</u>	<u>+20 0 -20 -30</u>
Medium ethanol		kW	0.5 0.32 0.12 0.03	0.45 0.32 0.14 0.3
Refrigerant			R134a	R134a
Overall dimensions	(WxDxH)	cm	36x46x69	38x58x62
Bath opening	(WxL)	cm	23x14	24x30
Bath depth		cm	20	15
Filling volume	from ... to	liters	12 ... 16	14 ... 20
Weight		kg	44	42
Mains power connection	230 V/50 Hz	V/ Hz	230 / 50	230 / 50
Current draw	(at 230 V)	A	12	12
Current draw	GB, CH (at 230 V)	A	<9 / 2>	<9 / 2>
Mains power connection		V/ Hz	208...230 / 60	208...230 / 60
Current draw	(at 208 V / 230 V)	A	12	13
Mains power connection		V/ Hz	115 / 60	115 / 60
Current draw	(at 115 V)	A	15	14
Mains power connection		V/ Hz	100 / 60	----
Current draw	(at 100 V)	A	15	----

			FP40-ME	FP50-ME FPW50-ME
Working temperature range		°C	-40 ... 200	-50 ... 200
Temperature stability		°C	±0,01	±0,01
Cooling capacity		°C	<u>+20 0 -20 -30</u>	<u>+20 0 -20 -30 -40</u>
Medium ethanol		kW	0.68 0.5 0.32 0.04	0.9 0.8 0.5 0.32 0.16
Refrigerant			R404A	R404A or R507
Overall dimensions	(WxDxH)	cm	37x46x69	42x49x70
Bath opening	(WxL)	cm	23x14	18x12
Bath depth		cm	20	15
Filling volume	from ... to	liters	9 ... 16	5.5 ... 8
Weight		kg	48	55
Mains power connection		V/ Hz	230 / 50	230 / 50
Current draw	(at 230 V)	A	13	14
Current draw	GB, CH (at 230 V)	A	<9 / 3>	<9 / 4>
Mains power connection		V/ Hz	230 / 60	230 / 60
Current draw	(at 230 V)	A	13	14

All measurements have been carried out at:
 rated voltage and frequency ambient temperature: 20 °C
 Technical changes without prior notification reserved.

ME			
Temperature selection			digital
via keypad			indication on VFD COMFORT-Display
remote control via personal computer			indication on monitor
Temperature indication			VFD COMFORT-DISPLAY
Resolution		°C	0.01
Absolute Temperature Calibration	INT/EXT	°C	±3 / ±9
Temperature control			PID3 cascade temperatur control
Heater wattage (at 230 V)		kW	2,0
Heater wattage (at 115 V)		kW	1,0
Electronically adj. pump capacity		stages	1 ... 4
Flow rate	at 0 bar	l/min	11 ... 16
Pressure max.	at 0 liter	bar	0.22 ... 0.45
Electrical connections:			
External alarm device		Vdc/mA	24-0 / max. 25
Computer interface			RS232
External temperature sensor			Pt100
Ambient temperature		°C	5 ... 40

Safety installations according to IEC 61010-2-010:

Excess temperature protection	adjustable from 0 °C ... 230 °C
Low liquid level protection	float switch
Classification according to DIN 12876-1	class III

Supplementary safety installations

Early warning system for low level	float switch
High temperature warning function	optical + audible (in intervals)
Low temperature warning function	optical + audible (in intervals)
Supervision of working sensor	plausibility control
Reciprocal sensor monitoring between working and safety sensors	difference >35 K
Alarm message	optical + audible (permanent)
Warning message	optical + audible (in intervals)

Environmental conditions according to IEC 61 010-1:

Use only indoor.

Altitude up to 2000 m - normal zero.

Ambient temperature: +5 ... +40 °C

Air humidity:

Max. rel. humidity 80 % for temperatures up to +31 °C,

linear decrease down to 50 % relative humidity at a temperature of +40 °C

Max. mains fluctuations of ±10 % are permissible.

Protection class according to IEC 60 529	IP21
The unit corresponds to Class I	
Overvoltage category	II
Pollution degree	2



Caution:

The unit is not for use in explosive environment

Standards for interference resistance according to EN 61326-1

This unit is an ISM device classified in Group 1 (using high frequency for internal purposes) Class A (industrial and commercial range).

2.3. Cooling water connection

Cooling water pressure (IN/OUT)	max.	6 bar
Pressure difference (IN - OUT)		3.5 to 6 bar
Cooling water temperature		< 20 °C



Notice: Cooling water circuit

Risk of oil leaking from the refrigeration system (compressor) of the recirculating cooler into the cooling water in case of a fault in the cooling water circuit!
Observe the laws and regulations of the water distribution company valid in the location where the unit is operated.



Notice:

Danger of corrosion of heat exchanger due to unsuitable quality of cooling water.

- Due to its high content of lime, hard water is not suitable for cooling and causes scale in the heat exchanger.
- Ferrous water or water containing ferrous particles will cause formation of rust even in heat exchangers made of stainless steel.
- Chlorinated water will cause pitting corrosion in heat exchangers made of stainless steel.
- Due to their corrosive characteristics, distilled water and deionized water are unsuitable and will cause corrosion of the bath.
- Due to its corrosive characteristics, sea water is not suitable.
- Due to its microbiological (bacterial) components, which settle in the heat exchanger, untreated and unpurified river water and water from cooling towers is unsuitable.
- Avoid particulate matter in cooling water.
- Avoid putrid water.

Recommended quality of cooling water:

pH	7.5 to 9.0
Sulfate [SO ₄ 2-]	< 100 ppm
Hydrocarbonate [HCO 3-]/sulfate [SO ₄ 2-]	> 1 ppm
Hardness [Ca 2+, Mg 2+]/[HCO 3-]	> 0.5 °dH
Alkalinity	60 ppm < [HCO 3-] < 300 ppm
Conductivity	< 500 µS/cm
Chloride (Cl -)	< 50 ppm
Phosphate (PO ₄ 3-)	< 2 ppm
Ammonia (NH ₃)	< 0.5 ppm
Free chlorine	< 0.5 ppm
Trivalent iron ions (Fe 3+)	< 0.5 ppm
Manganese ions (Mn 2+)	< 0.05 ppm
Carbon dioxide (CO ₂)	< 10 ppm
Hydrogen sulfide (H ₂ S)	< 50 ppm
Content of oxygen	< 0.1 ppm
Algae growth	impermissible
Suspended solids	impermissible

Operating instructions

3. Safety notes for the user

3.1. Explanation of safety notes



In addition to the safety warnings listed, warnings are posted throughout the operating manual. These warnings are designated by an exclamation mark inside an equilateral triangle. "Warning of a dangerous situation (Attention! Please follow the documentation)."

The danger is classified using a signal word.

Read and follow these important instructions for averting dangers.



Warning:

Describes a **possibly** highly dangerous situation. If these instructions are not followed, serious injury and danger to life could result.



Caution:

Describes a **possibly** dangerous situation. If this is not avoided, slight or minor injuries could result. A warning of possible property damage may also be contained in the text.



Notice:

Describes a **possibly** harmful situation. If this is not avoided, the product or anything in its surroundings can be damaged.

3.2. Explanation of other notes



Note!

Draws attention to something special.



Important!

Indicates usage tips and other useful information.



This icon is used in the operating instructions to indicate flashing values or parameters which have to be set or confirmed.

3.3. Safety recommendations

Follow the safety instructions to avoid personal injury and property damage. Also, the valid safety instructions for workplaces must be followed.



- Only connect the unit to a power socket with an earthing contact (PE – protective earth)!
- The power supply plug serves as a safe disconnecting device from the line and must always be easily accessible.
- Place the unit on an even surface on a base made of nonflammable material.
- Do not stay in the area below the unit.
- Make sure you read and understand all instructions and safety precautions listed in this manual before installing or operating your unit.
- Set the excess temperature safety installation at least 25 °C below the fire point of the bath fluid.
- Observe the limited working temperature range when using plastic bath tanks.
- Never operate the unit without bath fluid in the bath.
- Pay attention to the thermal expansion of bath oil during heating to avoid overflowing of the fluid.
- Prevent water from entering the hot bath oil.
- Do not drain the bath fluid while it is hot!
Check the temperature of the bath fluid prior to draining (e.g., by switching the unit on for a short moment).
- Use suitable connecting tubing.
- Avoid sharp bends in the tubing, and maintain a sufficient distance from surrounding walls.
- Make sure that the tubing is securely attached.
- Regularly check the tubing for material defects (e.g., for cracks).
- Never operate damaged or leaking units.
- Always turn off the unit and disconnect the mains cable from the power source before performing any service or maintenance procedures, or before moving the unit.
- Always turn off the unit and disconnect the mains cable from the power source before cleaning the unit.
- Always empty the bath before moving the unit.
- Transport the unit with care.
- Sudden jolts or drops may cause damage in the interior of the unit.
- Observe all warning labels.
- Never remove warning labels.
- Never operate units with damaged mains power cables.
- Repairs are to be carried out only by qualified service personnel.



- Some parts of the bath tank and the pump connections may become extremely hot during continuous operation. Therefore, exercise particular caution when touching these parts.



Caution:

The temperature controlling i.e. of fluids in a reactor constitutes normal circulator practice.

We do not know which substances are contained within these vessels.

Many substances are:

- inflammable, easily ignited or explosive
- hazardous to health
- environmentally unsafe

i.e.: **dangerous**

The user alone is responsible for the handling of these substances!

The following questions shall help to recognize possible dangers and to reduce the risks to a minimum.

- Are all tubes and electrical cables connected and installed?
Note:
sharp edges, hot surfaces in operation, moving machine parts, etc.
- Do dangerous steams or gases arise when heating?
Is an exhaust needed when working?
- What to do when a dangerous substance was spilled on or in the unit?
Before starting to work, obtain information concerning the substance and determine the method of decontamination.



Notice:

Check the safety installations at least twice a year!

- Excess temperature protection according to IEC 61010-2-010.
With a screwdriver turn back the adjustable excess temperature protection until the shut-down point (actual temperature).
- Low level protection according to IEC 61010-2-010.
To check the function of the float, it can be manually lowered with a screwdriver for example.



WARNING

This product contains chemicals known to the state of California to cause cancer, birth defects or other reproductive harm.

4. Operating controls and functional elements

4.1. Circulator

Front view

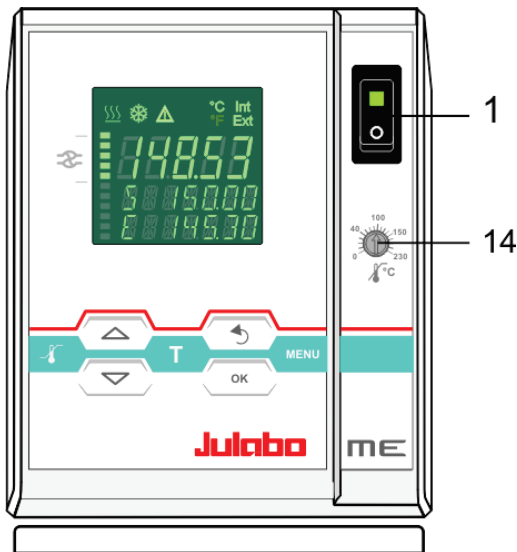

Rear view

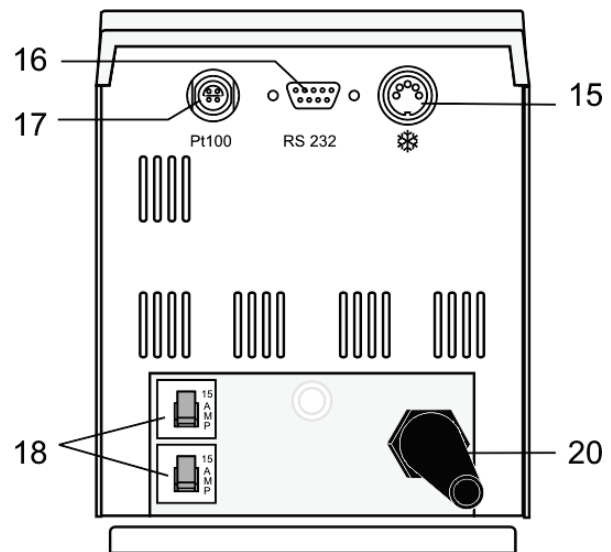

- 1  Mains power switch, illuminated

Navigation keys

- 2  1. Key: >OK< Start / Stop (pump / heater)
 2. >OK< in the menu Menu item / select submenu for setting
 Save set value
 Save selected parameter
 A beep signals the end of setting





After the actions Start, Stop and change from VFD Display to standard display the key **OK** is locked for a short time.
 The above graph "front side" shows an example for standard display.



- 3  1. Key: >Return< Stop (pump / heater)
 2. >Return< in the menu one menu level down
 Correction function for parameters or values (prior to OK)



immediately back to standard display



OK  -  icon for „keep key pressed down“.

- 4  1. Key: >Up / Down <temperature – increase/decrease setpoint
 Push key quickly for single steps,
 Keep key pressed for fast change.

 2. >Up/Down< in the menu selection of menu items / parameters

Menu keys

5  Key: start the menu > warning and safety values<

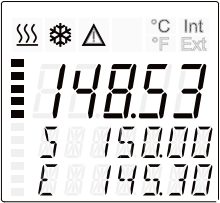

6  Key: start the menu >temperature setpoints<

7  Key: display of MENU structure

10  **VFD COMFORT-DISPLAY**
 Header: Control indicators see sections 11 and 12
 Line 1: Actual value internal or external
 The display is depending on the selected control mode in the menu > Control < (internal or external).
 Line 2: Working temp. setpoint, constantly S xxx.xx
 Line 3: Actual value (E = external or I = internal)
 Alternating with the display in line 1

11  Control indicators in the header:
 Heating / Cooling / Alarm /
R Remote control

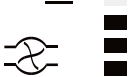
12  Control indicators in the header:
 Temperature indication **I**nternal or **E**xternal actual value
 Temperature indication in °C (°F not possible on this unit)

13  Display of set pump pressure stage
 Four stages, can be set via the key  , under >MENU - PUMP<.

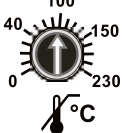
14  Adjustable excess temperature protection according to IEC 61010-2-010

15  Socket: control cable of JULABO refrigerated circulator
 or output for alarm messages

16  Interface RS232: remote control via personal computer

17  Socket for external measurement and control sensor
 or external setpoint programming

18  Mains circuit breakers (resettable) 15 A

20 Mains power cable with plug

4.2. Cooling Machine

Front view

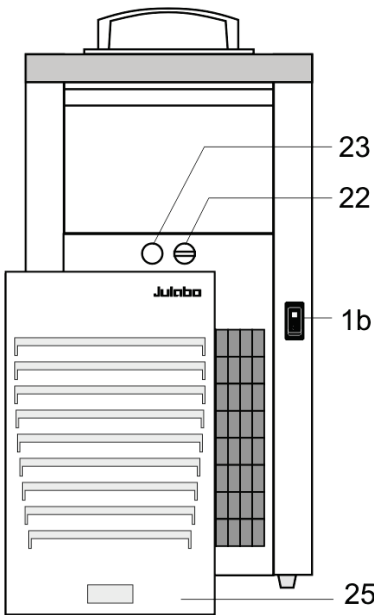

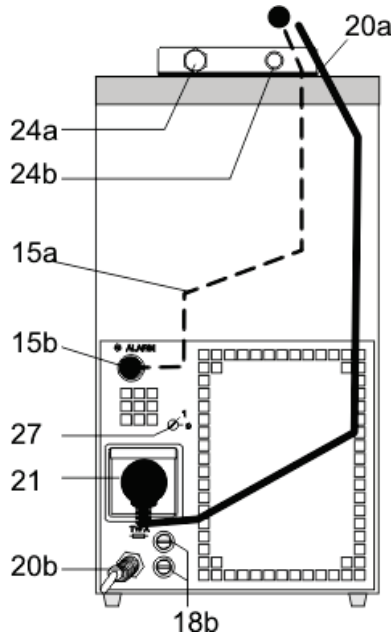

Rear view

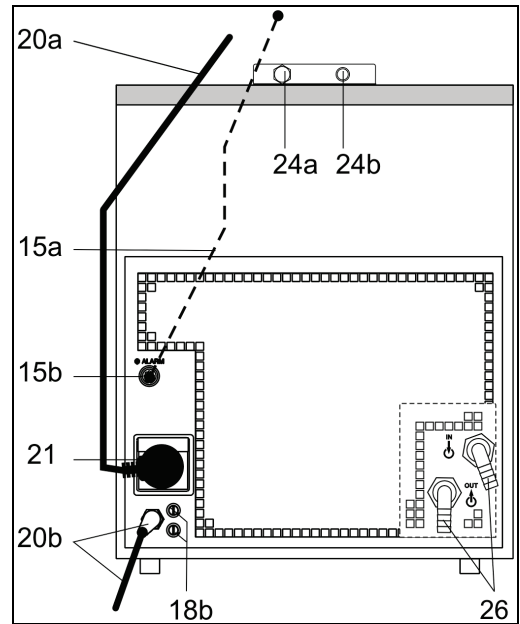

Rear view FPW unit



1b  Mains power switch, illuminated for cooling machine

15a  Socket: control cable of JULABO refrigerated circulator

15b

18b  Mains fuses for cooling machine, T10A, D5 x 20 mm

20a Mains power cable with plug for circulator

20b Mains power cable with plug cooling machine

21 Built-in mains outlet for connection of circulator

22 Drain tap

23 Drain port

24a Pump connector: feed

24b Pump connector: return

25 Venting grid, removable

26  Cooling water OUTLET and INLET. $\frac{3}{4}$ "

27  Selector dial for cooling machine (only F25, F26, F34)
Position "1" for operation with ME circulator.

5. Preparations

5.1. Installation

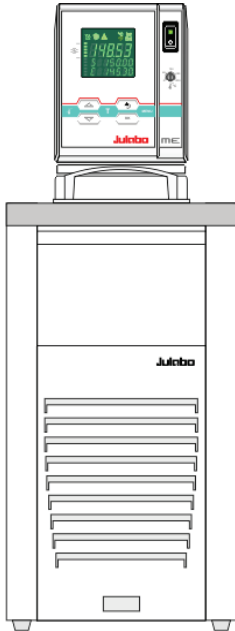

- Place the unit on an even surface on a pad made of **non-flammable** material.
F34: The circulator fitted with a stainless steel bridge is placed on on the back of the bath tank leaving the bath open on the front side.

- The place of installation should be large enough and provide sufficient air ventilation to ensure the room does not warm up excessively because of the heat the instrument radiates to the environment. (Max. permissible ambient temperature: 40 °C). With regard to a disturbance in the cooling loop (leakage), the guideline EN 378 prescribes a certain room space to be available for each kg of refrigerant.

The necessary amount of refrigerant is specified on the type plate.

> For 0.25 kg of refrigerant R134a, a room space of 1 m³ is required.

> For 0.52 kg of refrigerant R404A, a room space of 1 m³ is required.

> For 0.49 kg of refrigerant R507, a room space of 1 m³ is required.

- Set selector dial for cooling machine (19) in position "1" for operation with ME circulator.  (only F25, F26, F34)

- Keep at least 20 cm of open space on the front and rear venting grid.
- Do not set up the unit in the immediate vicinity of heat sources and do not expose to sun light
- Before operating the unit after transport, wait about one hour after setting it up. This will allow any oil that has accumulated laterally during transport to flow back down thus ensuring maximum cooling performance of the compressor.

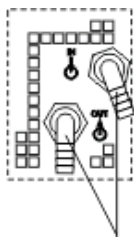

FPW 26

- Ensure circulation of cooling water by connecting the tubing to cooling water inlet and outlet on the rear of the refrigerated circulator.

Cooling water see page 13

5.2. Bath fluids



Caution:

Carefully read the safety data sheet of the bath fluid used, particularly with regard to the fire point!

If a bath fluid with a fire point of ≤ 65 °C is used, only supervised operation is possible.

Water: The quality of water depends on local conditions.

- Due to the high concentration of lime, hard water is not suitable for temperature control because it leads to calcification in the bath.
- Ferrous water can cause corrosion - even on stainless steel.

- Chloric water can cause pitting corrosion.
- Distilled and deionized water is unsuitable. Their special properties cause corrosion in the bath, even in stainless steel.

Recommended bath fluids:

Bath fluid	Temperature range
soft/decalcified water	5 °C to 80 °C
mixture water/glycol, mixture 1:1	-20°C to 50°C



See website for list of recommended bath fluids.

ATTENTION: The maximum permissible viscosity is 50 mm² /s.



Caution:

Fire or other dangers when using bath fluids that are not recommended:

Please contact JULABO before using other than recommended bath fluids.

Use only nonacidic and noncorrosive bath fluids.

JULABO assumes no liability for damage caused by the selection of an unsuitable bath liquid.

Unsuitable bath fluids are fluids which, e.g.,

- are highly viscous
(much higher than recommended at the respective working temperature)
- have a low viscosity and have creep characteristics
- have corrosive characteristics or
- tend to crack.
- **No liability for use of other bath fluids!**

5.3. Temperature application to external systems



Caution:

Securely attach all tubing to prevent slipping.

If the circulator is operated without external system, close the pump connector (24a) with the cap nut.

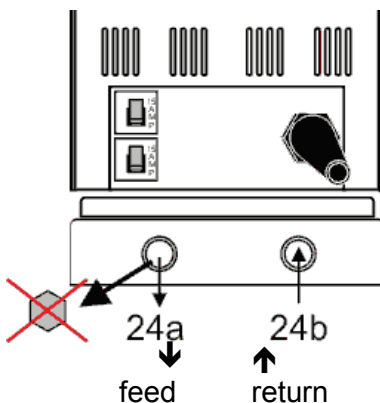

The circulator is used for temperature application to external, closed systems (loop circuit) with simultaneous temperature application in the circulator bath.

Connecting the external system

- Unscrew the collar nuts from the pump connector (24a).
- Slide the tubing onto the pump connector for feed (24a) and return flow (24b) and secure with hose clamps.

5.3.1. Tubing

Recommended tubing:

Order No.	Length		Temperature range
8 930 008	1 m	CR [®] tubing 8 mm inner dia.	-20 °C to 120 °C
8 930 010	1 m	CR [®] tubing 10 mm inner dia.	-20 °C to 120 °C
8 930 108	1 m	Viton tubing 8 mm inner dia.	-50 °C to 200 °C
8 930 110	1 m	Viton tubing 10 mm inner dia.	-50 °C to 200 °C
8 930 410	1 m	Insulation for tubing 8 mm or 10 mm inner dia.	-50 °C to 100 °C
8 970 480		2 tubing clamps. size 1, tubing 8 mm inner dia.	
8 970 481		2 tubing clamps. size 2, tubing 10 or 12 mm inner dia.	
8 930 209	0.5 m	Metal tubing, triple insulated, M16x1 *	-100 °C to +350 °C
8 930 210	1.0 m		
8 930 211	1.5 m		
8 930 214	3.0 m		
8 930 220	0.5 m	Metal tubing, insulated, M16x1 *	-50 °C to +200 °C
8 930 221	1.0 m		
8 930 222	1.5 m		
8 930 223	3.0 m		

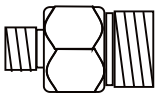

*) Adapter for metal tubing M10x1 on M16x1

Order No. 8 970 444



Warning: Tubing:

At high working temperatures the tubing used for temperature application and cooling water supply represents a danger source.

A damaged tubing line may cause hot bath fluid to be pumped out within a short time. This may result in:

- Burning of skin
- Difficulties in breathing due to hot atmosphere

Safety recommendations

- Employ suitable connecting tubing.
- Make sure that the tubing is securely attached.
- Avoid sharp bends in the tubing, and maintain a sufficient distance from surrounding walls.
- Regularly check the tubing for material defects (e.g. for cracks).
- Preventive maintenance: Replace the tubing from time to time.

5.4. Filling / draining



Notice:

- Pay attention to the thermal expansion of bath oil during heating to avoid overflowing of the liquid.
Do not drain the bath fluid while it is hot!
Check the temperature of the bath fluid prior to draining (by switching the unit on for a short moment, for example).
- Always turn off the unit and disconnect the mains cable from the power source before cleaning the unit, or before moving the unit.
- Store and dispose the used bath fluid according to the laws for environmental protection.

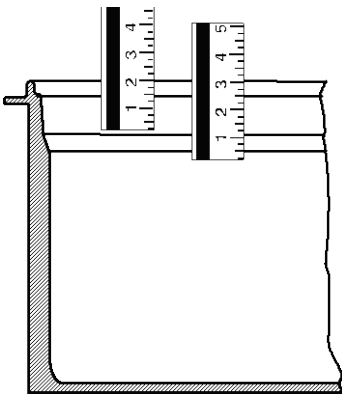

Filling

Take care that no liquid enters the interior of the circulator.

- Recommended maximum filling level with water as bath fluid:
30 mm below the tank rim
- Recommended maximum filling level with bath oils:
40 mm below the tank rim

- ⓘ After filling, immerse the samples in the bath or place the lid on the bath, in case the opening is not to be used.
- ⓘ The circulator provides an early warning system for low level that may be triggered when changing samples in the bath.

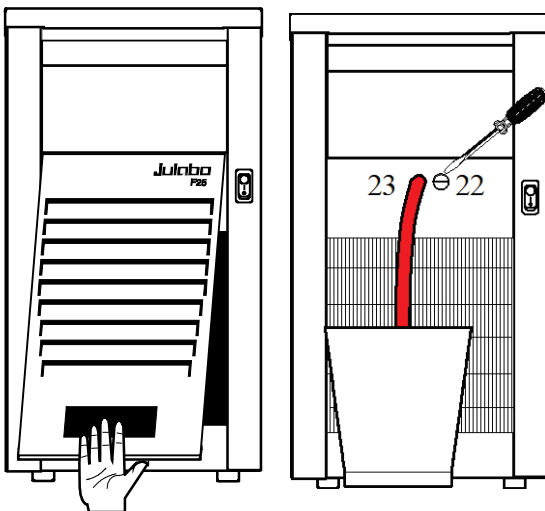

Draining

- Turn the unit off with the mains switch.
- Place the heating circulator near the rim of the table. Use a suitable vessel as recipient for the bath fluid.
- Unscrew the drain plug on the front of the bath tank to drain the bath.

6. Operating procedures

6.1. Power connection



Caution:

- Only connect the unit to a power socket with earthing contact (PE – protective earth)!
- The power supply plug serves as safe disconnecting device from the line and must be always easily accessible.
- Never operate equipment with damaged mains power cables.
- Regularly check the mains power cables for material defects (e.g. for cracks).
- We disclaim all liability for damage caused by incorrect line voltages!

Check to make sure that the line voltage matches the supply voltage specified on the identification plate. Deviations of $\pm 10\%$ are permissible.

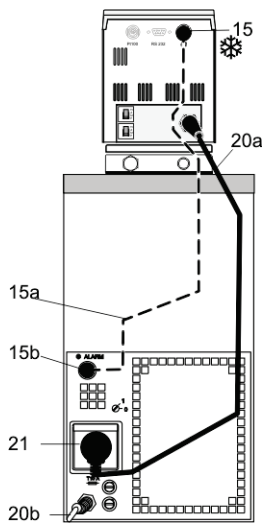

- Connect the circulator with mains power cable (20a) to the mains outlet (21).
- Connect the control cable (15a) between the connectors * (15, 15b).
- Connect the refrigerated circulator with mains power cable (20b) to the mains socket.

6.2. Switching on / Start - Stop

6.2.1. Switching on the circulator

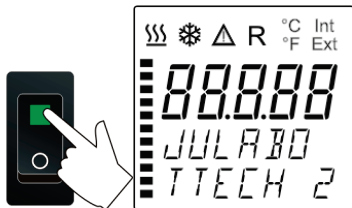

Switching on:

- Turn on the mains power switch (1).
- ⓘ The unit performs a self-test. Then the software version (example: V 1.xx) appears. The display „OFF“ or „R OFF“ indicates the unit is ready to operate.
- ⓘ The circulator enters the operating mode activated before switching the circulator off:
- keypad control mode** (manual operation)
or
remote control mode (operation via personal computer).

**Start:**

- Press **OK** key.
The actual bath temperature is displayed on the VFD COMFORT-DISPLAY. The circulating pump starts with a slight delay.

Stop:

- Press **OK** key.
or
Keep  key pressed.
The VFD COMFORT-DISPLAY indicates the message "OFF".

6.2.2. Switching on the Cooling Machine

Switching on:

- Switch on the cooling machine using the switch (1b) .

**ⓘ Control of the cooling machine:**

With the mains switch (1b) turned on, the circulator automatically switches the cooling machine off and on.

- It is switched off, if:
 - the actual working temperature is increased by >30 °C (cooling is not required).
 - the heater operates at full power (>800 W) for longer than 5 minutes.
- It is switched on, if:
 - cooling is necessary for maintaining the bath temperature.
 After switch-off, the cooling machine automatically switches on only after a delay of 5 minutes for protecting the cooling compressor.



- ⓘ To save energy, turn off the cooling machine with the mains switch (1b) whenever cooling is not required.



7. Setting of temperatures

7.1. Using the pre-settings in the menu





Press the  key to call up the menu for temperature selection.

3 different working temperatures can be adjusted. Their values are freely selectable within the operating temperature range.

 The temperatures can be set in start or stop mode.

 Press  key if a value is to be retained

Setting of working temperature in the menu









1. Press the key . The value flashes .
2. Select SETPOINT 1 or 2 or 3 using the key  or .

Werkseinstellungen:
 SETPNT 1 25 °C
 SETPNT 2 37 °C
 SETPNT 3 70 °C

3. Confirm by pressing the  key.



 The circulator uses the new working temperature value for temperature control.

Example: Adjustment/modification of the pre-setting of "SETPOINT 3"

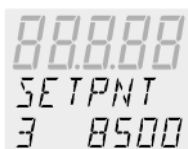
1. Press the  key.
2. Select SETPOINT 3 by pressing the  key.
Example: SETPNT 3 / 70.00 °C
3. Keep the  key pressed until the integer digits flash .
4. Adjust value by pressing the  key and the  key to 85.00 °C and confirm by pressing the  key.
The decimal digits flash  and can be adjusted if desired.
Confirm once more by pressing the  key.
Example on the left: SETPNT 3 / 85.00.



 If the active setpoint (SETPNT) is changed, the new value is immediately used for the control of the working temperature. The heater control indicator flashes.

 If the other two setpoints (not activated for control) are changed the  MENU has to be left by pressing the  key after the decimal digits have been confirmed



Notice: Refer to SETPOINT MAX / MIN in chapter 9.8. MENU LIMITS

7.2. Direct setting of temperatures

The circulator uses the setpoint of SETPNT 1 or 2 or 3 for temperature control

The indicated setpoint temperature can be changed directly any time.

Example: change 25.00 °C to 50.00 °C

1. By pressing the key the circulator switches to the active SETPOINT< example on the left: >SETPNT / 1 25.00°C<. The integer digits flash (example: <25>).

2. By pressing the keys and the value is changed to 50.00 °C and

is confirmed by pressing the **OK** key.

The decimal digits flash and can be adjusted if desired.

Confirm once more by pressing the **OK** key.

≡

- ① The circulator uses the new working temperature value for temperature control.
- ① The temperatures can be set in start or stop mode.

8. Safety installations, warning functions



Check the safety installations at least twice a year! Refer to (page 16)

SECVAL
(Security Values)

- SAFETMP
- AL-TYPE
- OVERTMP
- SUBTEMP

Settings for the excess temperature protection > **SAFETMP**< and for the warning functions for high > **OVERTMP**< and low > **SUBTEMP**< temperature are made in a menu which is called up by pressing the key .

Menu item > **AL-TYPE**< allows choosing between a warning and an alarm cut-off for the menu items > **OVERTMP**< and > **SUBTEMP**<.

8.1. Excess temperature protection



Warning:

The excess temperature protection **must** be set at least 25 °C below the fire point of the bath fluid used!
In case of wrong setting there is a fire hazard!
We disclaim all liability for damage caused by wrong settings!

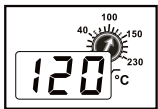

This excess temperature protection is independent of the control circuit. When activated heater and circulating pump are completely shut down. The alarm is indicated by optical and audible signals (continuous tone) and the error message "ALARM-CODE 14" appears on the VFD COMFORT-DISPLAY together with the ticker:
> EXCESS TEMPERATURE PROTECTOR ALARM-CHECK
ADJUSTMENT <

Setting range: 20 °C ... 230 °C

① Rough setting can be effected by using the temperature scale.

Exact setting:

1. Press the key  to display menu >SAFETMP<.
2. Press the **OK** key and the set shutdown value is indicated.
3. Set the new shutdown value within 30 seconds using a screwdriver. The value is indicated on the VFD COMFORT-DISPLAY
Example: SAFETMP / 100 °C



Recommendation:

Set the excess temperature protection at 5 °C to 10 °C above the working temperature setpoint.

8.1.1. Early warning system, low level protection

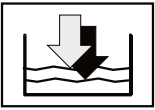

This low level protection is independent of the control circuit and is divided into two sections:

1. Switch in stage 1 recognizes a defined fluid level 😊.
An audible warning sounds (interval tone) and together with the ticker: *> LOW LEVEL WARNING-FILL MEDIUM <* a message appears on the VFD COMFORT-DISPLAY:

```
888.88
WARNING
CODE 40
```

Refill the bath fluid!

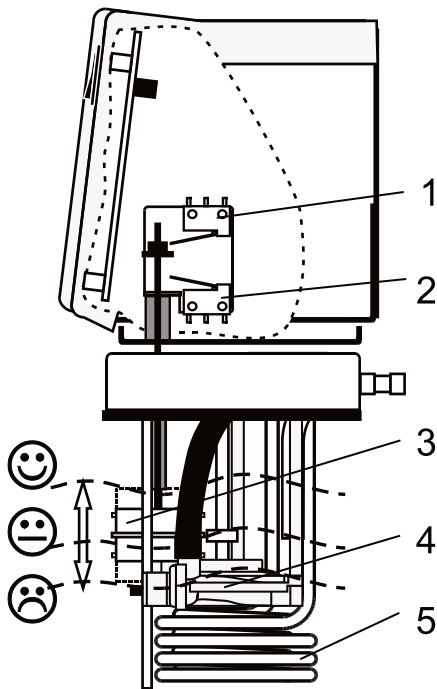

2. Switch in stage 2 recognizes a low fluid level 😞.
If stage 2 of the low level protection according to IEC 61010-2-010 is triggered, a complete, all-pole shutdown of heater and circulating pump is effected
A continuous alarm sounds and together with the ticker: *> LOW LEVEL ALARM-FILL MEDIUM <* a message appears on the VFD COMFORT-DISPLAY:

```
-OFF-
ALARM
CODE 1
```

Turn off the unit with the mains switch, refill bath fluid and turn the unit on again!

3. Float
4. Circulating pump
5. Heater



Warning:

When adding bath fluid, always use the type of fluid which is identical with the fluid in the bath.

Bath oils must not contain any water and should be pre-heated approximately to the current bath temperature! Explosion hazard at high temperatures!

8.2. Switch-over from warning to shutdown function





SECVAL
AL-TYPE

If a shutdown of functional elements (e.g. heater, circulating pump) is required when the limit values are exceeded or undercut the circulator can be changed over from warning function >WARNING< to shutdown function >ALARM<.

Factory setting:
>WARNING<

AL-TYPE
WARNING ✱

AL-TYPE
ALARM

1. Press the key .
2. Select the menu >SECVAL -AL-TYPE< by pressing the  key.
3. Press the **OK** key and the set parameter will flash ✱.
(Example: WARNING)
4. Change the parameter by pressing the  key and confirm by pressing the **OK** key.
or
press the  key if the parameter is to be retained.

ⓘ Setting >WARNING<

A mere warning function with optical and audible warning signal (interval tone) A message appears on the VFD COMFORT-DISPLAY:

<p>88888 WARNING CODE 03 OVERTMP</p>	or	<p>88888 WARNING CODE 04 SUBTEMP</p>
--	----	--

• Setting >ALARM<

Temperature limit with shutdown of heater and circulating pump. An audible alarm sounds (continuous tone) and a message appears on the VFD COMFORT-DISPLAY:

<p>-0FF- ALARM CODE 03 OVERTMP</p>	or	<p>-0FF- ALARM CODE 04 SUBTEMP</p>
--	----	--

8.3. Over and Sub temperature warning function

Over temperature





```
OVERTMP
200.00
```

Sub temperature

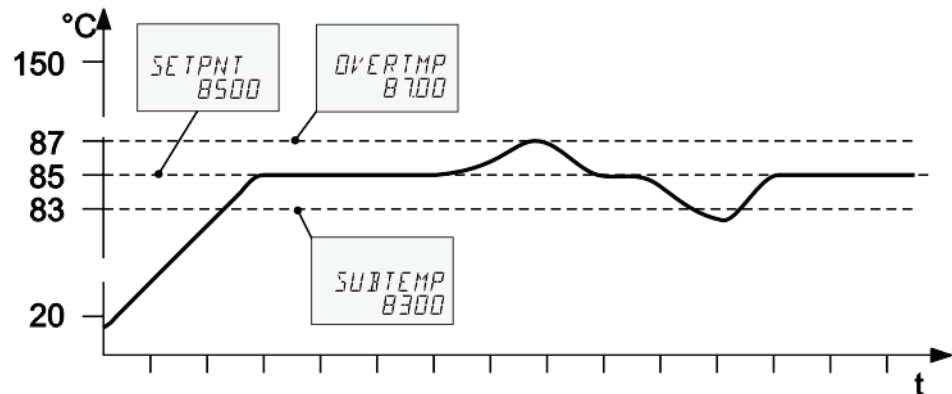
```
SUBTEMP
-99.00
```

If the observance of a working temperature value >SETP< has to be supervised for a sensitive temperature application, then set over and sub temperature warning values. In the example below the SETPOINT 85 °C is surrounded by the values OVERTMP 87 °C and SUBTEMP 83 °C. The electronics immediately register if the actual temperature breaches one of the set limit values. The resulting reaction is defined in a further menu item. (See chapter 8.2.)



1. Press the key .
2. By pressing the  or  key select the menu >OVERTMP< or >SUBTEMP<.
3. Press the **OK** key. The integer digits flash
4. Change the values to 87. °C and/or 83. °C by pressing the  and  key and confirm with the **OK** key. The decimal digits flash and can be adjusted if desired. Confirm once more by pressing the **OK** key. See above examples.

 The warning functions are only activated if the actual bath temperature remains within the set limit values for 3 seconds after switch-on.



Recommendation:

Set the over temperature warning value >OVERTMP< 5 °C to 10 °C above the working temperature setpoint.









Set the sub temperature warning value >SUBTMP< 5 °C to 10 °C below the working temperature setpoint.





9. Menu functions

↓

The term „Menu functions“ refers to settings such as

Menu level 1

	Start program  →	Page 33
	Administration and creation of programs	Page 35
	Electronically adjustable pump capacity	Page 37
	Configuration of the unit REMOTE – on / off (remote control via RS232) AUTOST – AUTOSTART on / off OFF-MODE – pump on / off TIME / DATE – setting time and date RESET – factory settings	Page 38
	Control characteristics and parameters C-TYPE – Internal or external control DYNAMICS - internal Control parameter - XP-, TN-, TV- INTERNAL Control parameter - XP-, TN-, TV- XPU-, EXTERNAL	Page 41
	Adjustable interface parameters BAUD RATE, PARITY, HANDSHAKE	Page 45
	ATC - Absolute Temperature Calibration, Sensor calibration INTERNAL SENSOR, Sensor calibration EXTERNAL SENSOR 3-point calibration	Page 46
	Limitations of temperature and capacity SETPOINT MAX / MIN - Maximum and minimum setpoint HEAT MAX – Set maximum heating COOLING MAX – Set maximum cooling INTERN MAX / MIN – Limitation of the temperature range BAND HIGH / LOW – Band limit	Page 52

1. Open the menu by pressing the  key.
2. Use the   keys to scroll in menu level 1.
3. Press the  key to change to menu level 2.
Press the  key if settings are to be retained.

9.1. MENU PROGRAM – START

Start-Menu

This menu will start a previously set program.

Requirements:

1. Create a program. (refer to next chapter)
2. Return to the Start-MENU and confirm the desired setting of each MENU item with the key **OK**
3. Set a start time (>TIME< >DATE< >YEAR<) if the program is to be started by the internal timer.

Menu level 1

MENU
P-START

OK ↓

- > STEP< Program start at section 1 ... 10
- > RUNS < Number of repetitions 1 ... 99
- > END< Status at end of program (STDBY/SETPNT)
Standby or last setpoint
- > GO < Time of start (NOW/TIMER)



Level 2

Parameter level

i Press the  key if a parameter is to be retained. Correction function for parameters or values (prior to OK)



P-START
STEP OK →
▼ ▲

STEP
1

- Set program step with   and **OK**
example: STEP 1

P-START
RUNS OK →
▼ ▲

RUNS
1



- Set number of runs with   and **OK**
example: 1 run

P-START
END OK →
▼ ▲

END
STDBY

or

END
SETPNT

- Set desired parameters with   and **OK**.
- i** (STDBY / SETPNT)
Parameter **STanDBY**: the circulator switches to – OFF-.
Parameter **SETPoiNT**: the circulator constantly keeps the temperature at the value of the last step.

P-START
GO OK →
▼

GO
NOW

or











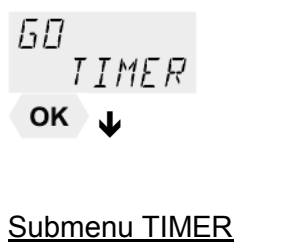
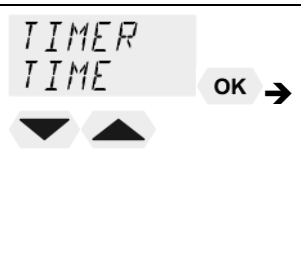
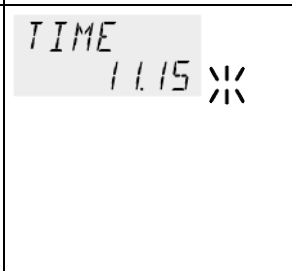





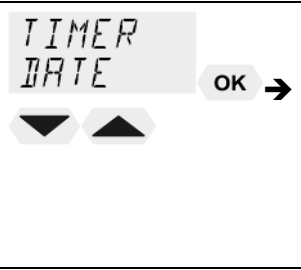



▼

- Confirm >NOW< with the **OK** key and the program will start immediately
- i** or
start at the set time under parameter (TIMER).
Set time in the example below:
09. August 2009, 11:15 hrs

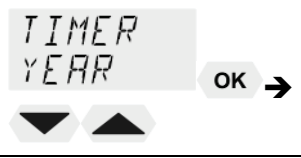
↙

GO
TIMER

Menu functions

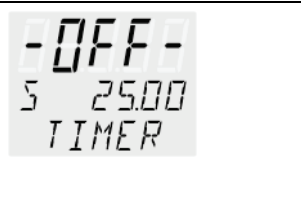
		<p>① set the time for the start of the program in the submenu >TIMER<.</p>
<p>Submenu <u>TIMER</u></p> 	<p>Parameter level</p> 	<p>>TIME< hours/minutes (hh:mm), set both values one after the other and confirm</p> <ul style="list-style-type: none"> hours flash, set by pressing   +  minutes flash, set by pressing   + 
		<p>>DATE< day/months (TT/MM), set both values one after the other and confirm.</p> <ul style="list-style-type: none"> day flashes, set by pressing   +  month flashes, set by pressing   + 
		<p>>YEAR< year</p> <ul style="list-style-type: none"> Set the year with   and .
		<p>① The program starts at the set time.</p>
	<p>① Display of time until start: In line 3 the notice >TIMER< and the set values for „TIME“ and „DATE/YEAR“ are alternately indicated</p> <p>① Check the correct setting of the internal real time clock if required (see MENU CONFIG)</p>	

The started program



After the start the program will indicate the currently calculated setpoint in line 2
S XX.XX. The value increases within the time period >TSLICE< until the target temperature >SETPNT< of the section is reached.
If the time period in a section is set to „0“, the next section will not begin until the target temperature has been reached.

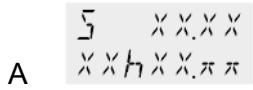

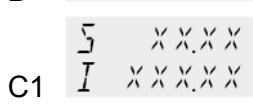

A 

B 

C1 

Use the edit keys   to scroll to line 3. The display changes approximately every 4 seconds between the current section (STEP XX) and the



A remaining time of the section
B remaining time of the program
C current bath temperature
I xxx.xx - internal actual value or

C2	S x x . x x E x x x . x x	E xxx.xx – external actual value
D1	S x x . x x RUN	D RUN – the program has started or PAUSE – the progress of the program has been interrupted by pressing the  key. While the time is stopped the temperature will constantly remain at the last calculated setpoint
D2	S x x . x x PAUSE	Continue with the  key.

-OFF-

S x x . x x
I x x . x x

Termination / Interruption of a program

- ❶ The program can be terminated any time by pressing the key  .
- ❷ In case of power failure the program is interrupted. The circulator switches to -OFF- .
- ❸ If the AUTOSTART-function is activated the programmer starts again at the point in time approx. 5 minutes prior to the interruption. However, an uncontrolled change of the bath temperature has occurred.

9.2. MENU PROGRAM – creation, administration

Menu level 1

MENU
PROGRAM

1 program

10 sections

The integrated programmer permits fast and easy programming of setpoint temperature sequences. This temperature sequence is called program. A program is composed of individual sections (STEP). The sections are defined by duration (TSLICE) and target temperature. The target temperature is the setpoint (SETPNT), which is achieved at the end of a section. The programmer calculates the temperature ramp from the difference in time and temperature.

STEP	(Nr.)	1	2	4	6	8
SETPNT	(°C)	100	180	180	75	75
TIME	(hh.mm)	00:20	00:10	00:20	00:50	00:20

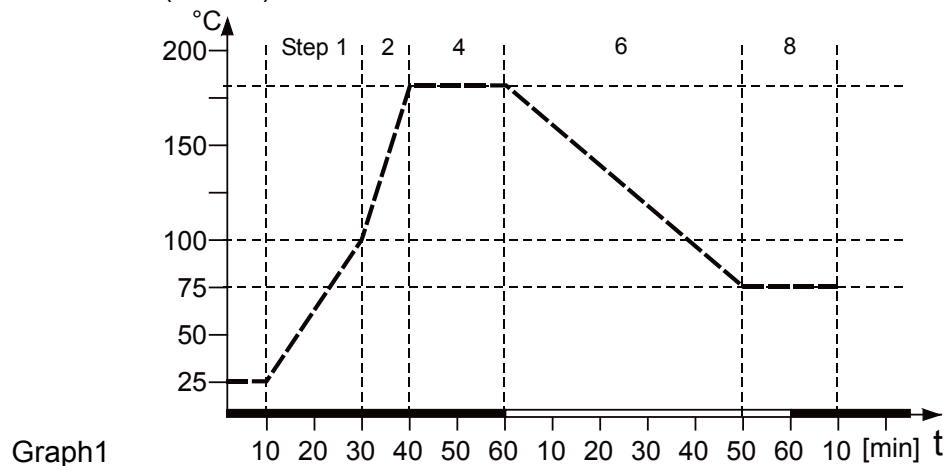

- ❶ Sections without set value and time are skipped. They can be defined retroactively and the integrated into the program.

Menu functions

<p>Menu level 1</p> <p>▼ ▲</p> <p>MENU PROGRAM</p> <p>OK ↓</p>	<p>>EDIT< Create, administer program</p> <p>> STEP< Program step (1 ... 10)</p> <p>>SETPNT < Temperature setpoint of step ...</p> <p>>TSLICE< Duration of step ...</p> <p>> DELETE< delete program step (01 ... 10, ALL)</p> <p>① Press ↶ key, if a parameter is to be retained. Correction function for parameters or values (prior to OK)</p>	
<p>Level 2</p>	<p>Level 3</p>	<p>Parameter level</p>
<p>PROGRAM EDIT</p> <p>OK →</p> <p>▼</p>	<p>EDIT STEP</p> <p>OK →</p> <p>EDIT 01 STEP ←</p> <p>▼ ▲</p>	<p>STEP</p> <p>1 ✖ (STEP 1 ... 10)</p> <ul style="list-style-type: none"> Set program step with ▲ ▼ and OK <p>← (Example: EDIT STEP 01)</p> <p>① For STEP 01 the values for SETPOINT 01 and TSLICE 01 are set one after the other</p>
<p>EDIT 01 SETPNT</p> <p>OK →</p> <p>▼ ▲</p>	<p>EDIT 01 SETPNT</p> <p>OK →</p> <p>▼ ▲</p>	<p>SETPNT</p> <p>10000 ✖ (values within working temp. range)</p> <ul style="list-style-type: none"> Integer digits flash, set by pressing ▲ ▼ + OK Decimal digits flash, set by pressing ▲ ▼ + OK
<p>EDIT 01 TSLICE</p> <p>OK →</p> <p>(time slice)</p>	<p>EDIT 01 TSLICE</p> <p>OK →</p> <p>(time slice)</p>	<p>TSLICE</p> <p>00.10 ✖</p> <ul style="list-style-type: none"> Set duration by pressing ▲ ▼ and OK
<p>▲</p> <p>PROGRAM DELETE</p> <p>OK →</p>	<p>DELETE STEP -- ✖</p>	<p>① Delete program Program steps can be deleted individually or entirely. (STEP 01, 02,... 10, ALL).</p> <ul style="list-style-type: none"> Set parameters by pressing ▲ ▼ and OK

9.3. MENU PUMP – Setting of pump pressure



The capacity of the circulating pump is set by adjusting the motor speed

Settings: stage / LEVEL 1 ... 4



Display: with illuminated indicator

Flow rate: 11 ... 16 l/m

Pump pressure: 0,22 ... 0,45 bar

Factory setting:
stage 1



1. Press the **MENU** key.
2. Select the menu >PUMP< pressing the key and confirm by pressing the **OK** key
The set parameter flashes (example: >LEVEL 2<)
3. Change the parameter by pressing and confirm by pressing the **OK** key.
or
Press the key if the parameter is to be retained.

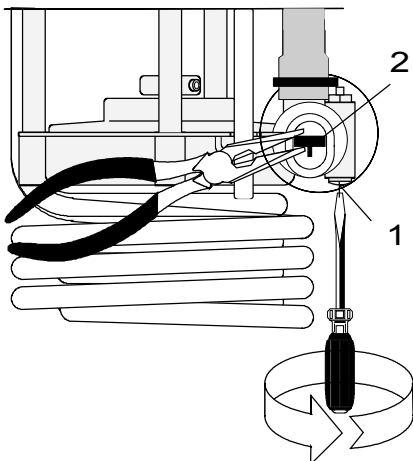

The pump flow is pre-adjusted in the factory and can be modified to suit user requirements.

- Using a screwdriver turn the screw (1) anti-clockwise by 360 °.
- Using flat pliers turn the marking of the slide (2) to the desired position.
- Tighten the screw.

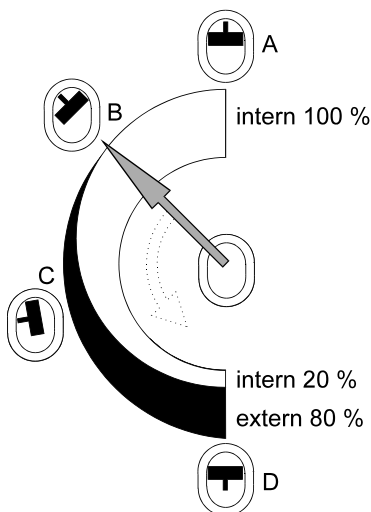

Examples:













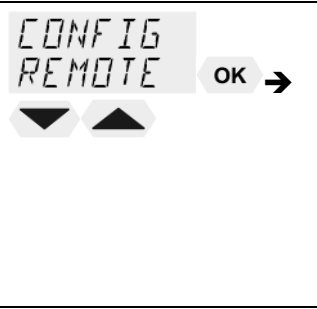
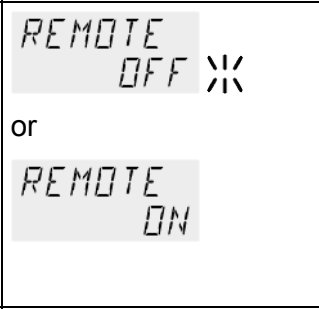



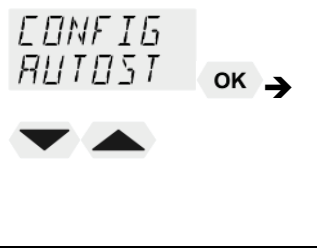
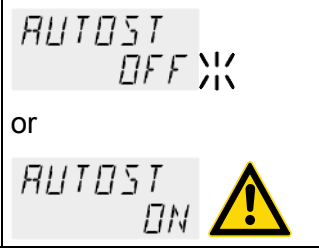

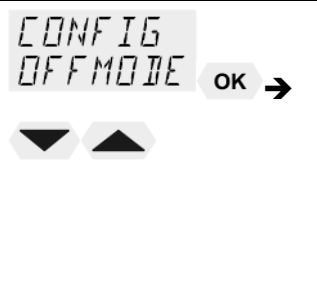
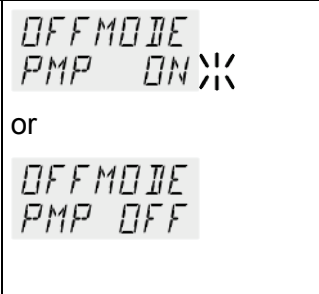





Internal applications in the bath









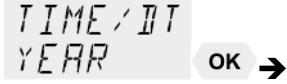
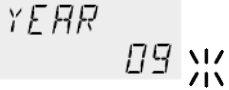

- A 100 % internal bath circulation
(for large bath tanks)
- B Reduced internal bath circulation
(for smooth surface of bath fluid)

External/internal applications

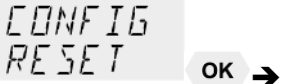
- C 40 % external discharge,
60 % internal circulation
(for large bath tanks)
- D 80 % external discharge,
20 % internal circulation
(for small bath tanks)

9.4. MENU CONFIG – Configuration of unit

<p>Menu level 1</p> 	 <p>① A RESET can be effected only in the >OFF< mode. Switch off circulator by pressing the OK key and call up the menu CONFIGURATION.</p>	
<p>Level 2</p>	<p>Parameter level</p>	<p>① Press the key  if a parameter is to be retained. Correction function for parameters and values (prior to OK).</p>
		<ul style="list-style-type: none"> • Switch on and off remote control by pressing   and OK ① Control display in the topline R for Remote ① For remote control refer to 59 ①   Connect RS232 with PC.
		<ul style="list-style-type: none"> • Switch on and off autostart by pressing   and OK AUTOSTART on = on AUTOSTART off = off See WARNING page 39
		<ul style="list-style-type: none"> • Switch on and off OFFMODE by pressing   and OK PUMP ON continuous operation of circulating pump PUMP OFF circulating pump is linked to Start/Stop
<p>Level 3</p>		<p>Parameter level</p>
		 <ul style="list-style-type: none"> • Hours flash, set by pressing   + OK • Minutes flash, set by pressing   + OK
		 <ul style="list-style-type: none"> • Day flashes, set by pressing   + OK • Month flashes, set by pressing   + OK

	Level 3	Parameter level
		 <ul style="list-style-type: none"> Year flashes, set by pressing   + 
	  	<ul style="list-style-type: none"> Return to factory settings by pressing  <p>RESET returns all set values to the factory setting except for date and time.</p> <ul style="list-style-type: none">  A RESET can be effected only in the –OFF- mode.  During the message –RUN- all parameters are reset to factory settings.

9.4.1. REMOTE

Factory setting: OFF



The control electronics offer two ways of adjusting a setpoint.

- Adjustment of setpoint using the keypad or the integrated programmer.
- Adjustment of setpoint via the serial interface RS232 using a PC or a superordinated process control system.

 The topline of the VFD-DISPLAY shows a bright „R“ for remote control; - remote control discontinued.

 RS232

IMPORTANT: additional measures for remote control

-  Connect the circulator to the PC using an interface cable.
-  Check the interface parameters of both interfaces (circulator and PC) and make sure they match.
(refer to 12.1. Setup for remote control page 59)

9.4.2. AUTOSTART



Warning

For supervised or unsupervised operation with the “AUTOSTART“ function avoid any hazardous situation to persons or property

Take care to fully observe the safety and warning functions of the circulator.

Factory settings: OFF

Notice:

The circulator has been configured and delivered by JULABO in accordance with the NAMUR recommendations. This means for the start mode that the unit must enter a safe operating status after a power failure. This safe operating status is indicated by the message „OFF“ or „R OFF“ on the VFD COMFORT-DISPLAY.

A complete, all-pole shutdown of the main functional elements such as heater and pump motor is effected.

The values set on the circulator remain saved and the unit is restarted by pressing the start/stop key in manual control.

In remote control mode the values need to be resent by the PC via the

interface.

If such a safety standard is not required, the NAMUR recommendations can be bypassed with the AUTOSTART function thus allowing a direct start of the circulator by pressing the mains switch or using a timer.

9.4.3. OFF-MODE

Factory setting:
PMP OFF

Usually the circulating pump is controlled with the key **OK** or the start/stop command. If the circulating pump is to work in the –OFF- mode, the adjustment can be set in a sub-menu.

ⓘ The pump motor will be shutdown in case of alarm anyhow.

9.4.4. Setting of clock and date



The internal real time clock allows starting a program any time. The clock is set to the local mean time (MEZ) at the factory.

ⓘ If the unit is operated in a different time zone, the clock can be adjusted in this menu.

ⓘ Change summer/winter time in this menu

9.4.5. RESET – Factory settings



A Reset will return all values to factory setting except for date and time.

ⓘ A RESET can be effected in the >OFF< mode only.

Switch off the circulator by pressing the key **OK** and call up the menu CONFIGURATION.

9.5. MENU CONTROL – Control characteristics and parameters

Menu level 1



The circulator is qualified for internal and external temperature control
The switchover is carried out in the menu >C-TYPE< .(INT or EXT).



- ① For external temperature control and measurement connect a Pt100 external sensor to the socket at the rear of the circulator.
- ① Press the  key if a parameter is to be retained. Correction function for parameters or values (prior to OK)

Level 2



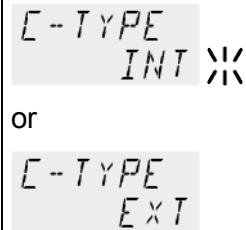



Parameter level

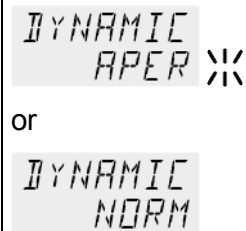

- Switchover of control type by pressing   and 
- ① The control type can be adjusted in the **-OFF-** mode only.
- ① Depending on the adjustment only the active parameters are displayed.

C-TYPE INTERNAL



- The parameter flashes, switch by pressing   and 
- ① This parameter affects the temperature sequence in case of internal control.

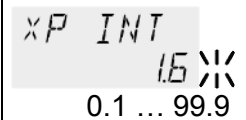

- The parameter flashes, set by pressing   + 

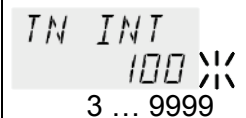
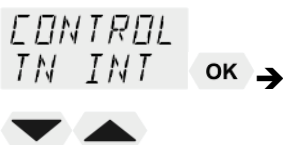

- The parameter flashes, set by pressing   + 

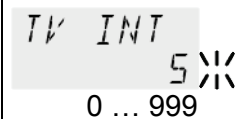

- The parameter flashes, set by pressing   + 

C-TYPE EXTERNAL

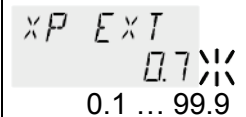
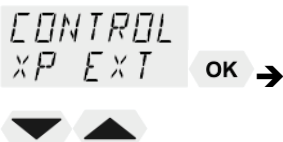



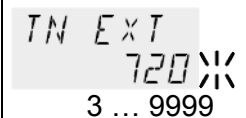



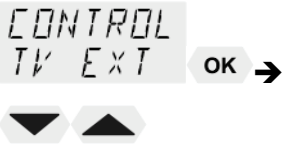
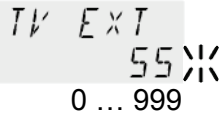

- The parameter flashes, set by pressing   + 

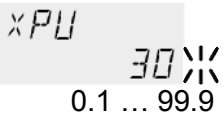

- The parameter flashes, set by pressing   + 

Menu functions

Level 2	Parameter level	
		<ul style="list-style-type: none"> The parameter flashes, set by pressing   + 
		<ul style="list-style-type: none"> The parameter flashes, set by pressing   + 

9.5.1. CONTROL – Control INTERNAL / EXTERNAL

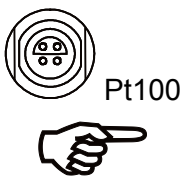

ⓘ Switchover can only be effected if a Pt100 external sensor is connected.
Factory setting: INT

IMPORTANT: Additional measures for external temperature control

ⓘ Suggested settings for external temperature control:
BAND HIGH / LOW and INTERN MAX / MIN
see chapter >LIMITS< page 52.

ⓘ Sensor calibration of the Pt100 external sensor is carried out in the menu >ADJUST<, submenu >ATC SENOR - EXT<; set ATC STATUS< to >OFF<
(See page 46).



Attention:

Place the external sensor into the temperature-controlled medium and securely fix the sensor.

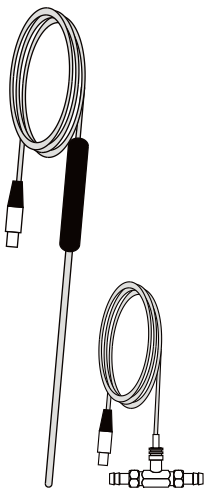

Pt100

M+R

Accessory: Pt100 external sensor

Order No.	Description	Material	Cable
8981003	200x6 mm Ø,	stainless steel	1.5 m
8981005	200x6 mm Ø,	glass	1.5 m
8981006	20x2 mm Ø,	stainless steel	1.5 m
8981010	300x6 mm Ø,	stainless steel	1.5 m
8981015	300x6 mm Ø,	stainless steel / PTFE coated	3 m
8981013	600x6 mm Ø,	stainless steel / PTFE coated	3 m
8981016	900x6 mm Ø,	stainless steel / PTFE coated	3 m
8981014	1200x6 mm Ø,	stainless steel / PTFE coated	3 m
8981103	Extension cable for Pt100 sensor		3.5 m
8981020	M+R in-line Pt100 sensor		

The M+R in-line Pt100 sensor is a flow sensor and can be installed loop circuit

9.5.2. Dynamic internal

```
CONTROL
DYNAMIC
```

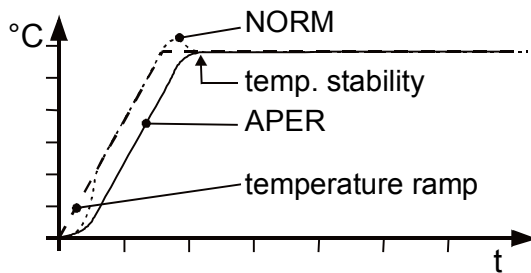
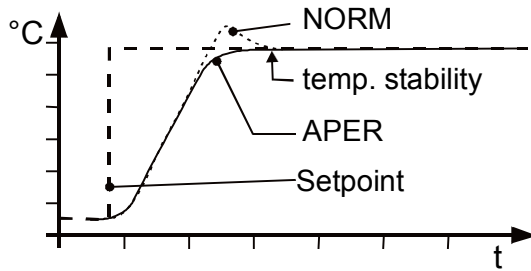

This parameter affects the temperature sequence only in case of internal control.

Factory setting: APER (aperiodic)

Possible parameters:

NORM Allows for reaching the setpoint faster – with setpoint change or ramp function – but overshooting of up to 5 % is possible.

APER Ramp function: the increase of temperature occurs temporally offset and achieves the target temperature without overshooting. Setpoint change: The temperature increases at the same rate, the target temperature is achieved without overshooting.

❗ With both settings constant temperature is achieved after approximately the same time.

9.5.3. Control parameters – XPU-, XP-, TN-, TV- EXTERNAL

```
xP EXT
  0.7
```

Setting range: 0.1 ...99.9

```
TN EXT
  720
```

Setting range: 3 ...9999

```
TV EXT
  55
```

Setting range: 0 ... 999

```
xPU
  30
```

Setting range: 0.1 ... 99.9

In most cases the control parameters preset in the factors are adequate for achieving an optimum temperature sequence.

The control parameters allow adjustment to special control processes.

Proportional range >Xpu<

The proportional range Xpu of the cascaded controller is only needed for external control.

9.5.4. Control parameters– XP-, TN-, TV- INTERNAL

In most cases the control parameters preset in the factory are adequate for achieving an optimum temperature sequence. The control parameters allow adjustment to special control processes..

```
XP INT
  15
```

Setting range: 0.1 ... 99.9

Proportional range >Xp<

The proportional range is the range below the setpoint in which the control circuit reduces the heating capacity from 100% to 0 %

```
TN INT
  100
```

Setting range: 3 ...9999

Reset time >Tn< (Integral component)

Compensation of the remaining control deviation due to proportional regulation. An insufficient reset time may cause instabilities. Excessive reset times will result in unnecessary prolongation of compensation of the control difference.

```
TV INT
  5
```

Setting range: 0 ... 999

Lead time >Tv< (Differential component)

The differential component reduces the transient time. An insufficient lead time will prolong the time required for compensation of disturbance effects and cause high overshooting during run-up. An excessive lead time could cause instabilities (oscillations)

Optimization instructions for the PID control parameters

Optimum setting

Control parameters XP-, TN-, TV- INTERNAL as well as -EXTERNAL

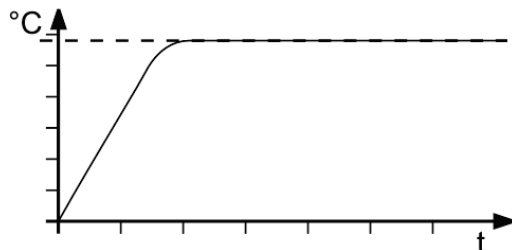

The heat-up curve reveals possible faulty settings of the control parameter.

Inappropriate settings may produce the following heat-up curves:

Xp too low

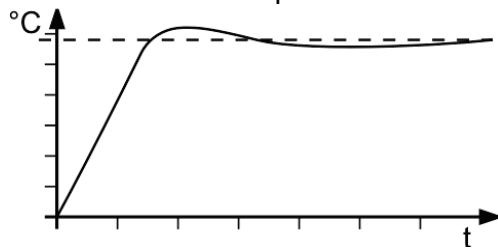

Tv/Tn too low

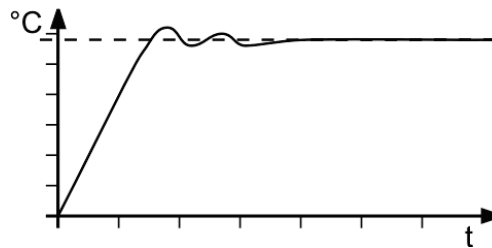



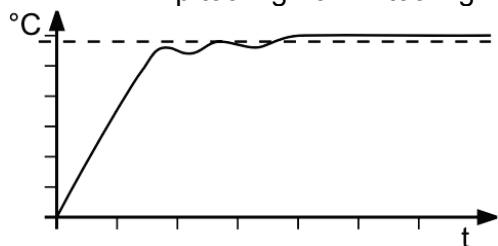



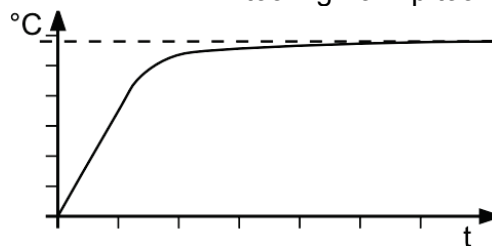









Xp too high or Tv too high

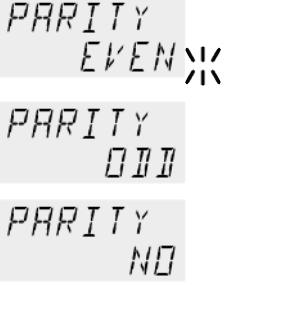

Tv/Tn too high or Xp too high

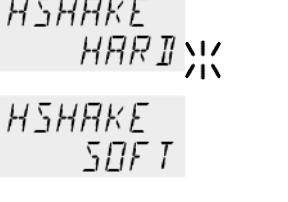

9.6. MENU SERIAL - BAUDRATE, HANDSHAKE, PARITY

<p>Menu level 1</p> 	<p>For communication between circulator and a PC or a superordinated process control system the interface parameters of both units must be identical.</p> <p>① For remote control refer to page 59</p> <p>Factory settings: 4800 Baud even hardware handshake</p>	
<p>Level 2</p>	<p>Parameter level</p>	<p>① Press the  key if a parameter is to be retained.</p>
		<ul style="list-style-type: none"> The parameter flashes, switch by pressing   and 
		<ul style="list-style-type: none"> The parameter flashes, switch by pressing   and  <p>even: Data bits = 7; Stop bits = 1 odd: Data bits = 7; Stop bits = 1 no: Data bits = 8; Stop bits = 1</p>
		<ul style="list-style-type: none"> The parameter flashes, switch by pressing   and  <p>Xon/Xoff-protocol (Software handshake) Protocol RTS/CTS (Hardware handshake)</p>

9.7. MENU ATC - Absolut Temperature Calibration

MENU
ATC

ATC serves to compensate a temperature difference that might occur between circulator and a defined measuring point in the bath tank because of physical properties.

Example:
1-point calibration

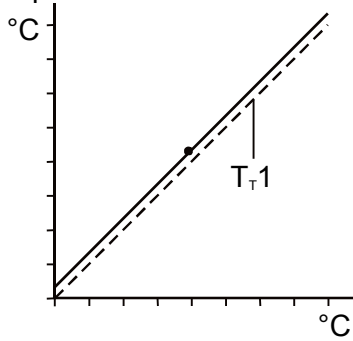

3-point calibration

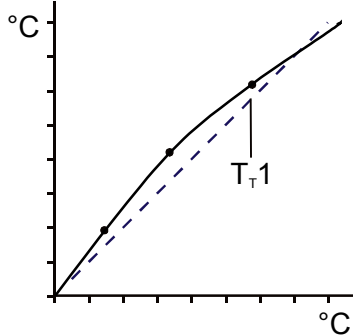

$T_T 1$ = Original curve



Principle:

For ATC calibration, in steady state the bath temperature at the location of the temperature sensor (CT) is determined at the respective adjusted working temperature. This value is then set on the circulator in the menu >ATCalibration< under menu item >CTEMP X<.

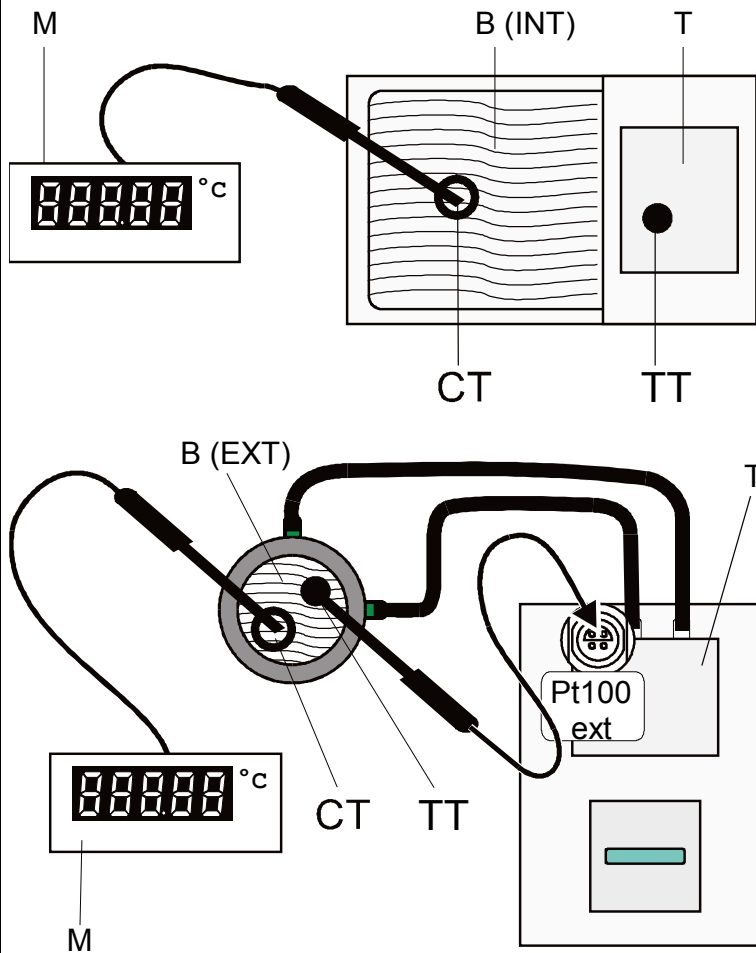
This can be a 1-point, 2-point or 3-point calibration.



- M = Temperature measuring instrument with temperature sensor
- B = Bath tank (INTERNAL or EXTERNAL)
- T = circulator
- CT = Temperature on measuring point
- TT = Temperature on circulator

<p>Menu level 1</p> <p>▼ ▲</p> <p>MENU ATC</p> <p>OK ↓</p>		
<p>Level 2</p>	<p>Parameter level</p>	<p>① Press the  key if parameter is to be retained. Correction function for parameters or values (prior to OK).</p>
<p>ATC SENSOR</p> <p>▼ ▲</p> <p>OK →</p>	<p>SENSOR INTERN ✱</p> <p>or</p> <p>SENSOR EXTERN</p>	<ul style="list-style-type: none"> • The parameter flashes, switch by pressing ▲ ▼ and OK ① On level 2 a (I) is indicated for internal or an (E) for external. <p>Example: ATC (I) ATC (E)</p>
<p>ATC (I) STATUS</p> <p>▼ ▲</p> <p>OK →</p>	<p>STATUS YES ✱</p> <p>or</p> <p>STATUS NO</p>	<ul style="list-style-type: none"> • The parameter flashes, switch by pressing ▲ ▼ and OK ① >NO< Carry out an ATC calibration ① >YES< return to standard operation after calibration.
<p>ATC (I) TYPE</p> <p>▼ ▲</p> <p>OK →</p>	<p>TYPE I-POINT ✱</p> <p>TYPE 2-POINT</p> <p>TYPE 3-POINT</p>	<ul style="list-style-type: none"> • The parameter flashes, switch by pressing ▲ ▼ and OK ① A >1-point<, >2-point< or >3-point< calibration can be carried out. <p>The selected calibration is indicated on level 2 by 1 or 2 or 3.</p>
<p>ATC (I) TMPVALI</p> <p>▼ ▲</p> <p>OK →</p> <p>ATC (I) CALVALI</p> <p>▼ ▲</p> <p>OK →</p>	<p>TMPVALI 8000 </p> <p>CALVALI 79.70 ✱</p>	<p>The value >TMPVAL< is only indicated</p> <ul style="list-style-type: none"> ① In addition the measured temperature value >CALVAL X< is saved during the next step. • Integer digits flash, set by pressing ▲ ▼ + OK • Decimal digits flash, set by pressing ▲ ▼ + OK
		<p>① If only a 1-point calibration is carried out, the following menu items are not indicated anymore</p>

Menu functions

<pre>ATC <I> TMPVAL2 OK → ▼ ▲</pre>	<pre>TMPVAL2 120.00 ↻</pre>	<p>The value is only indicated</p>
<pre>ATC <I> CALVAL2 OK → ▼ ▲</pre>	<pre>CALVAL2 119.50 ✖</pre>	<ul style="list-style-type: none"> • Integer digits flash, set by pressing ▲ ▼ + OK • Decimal digits flash, set by pressing ▲ ▼ + OK
<p>ⓘ If only a 2-point calibration is carried out, the following menu items are not indicated anymore</p>		
<pre>ATC <I> TMPVAL3 OK → ▼ ▲</pre>	<pre>TMPVAL3 160.00 ↻</pre>	<p>The value is only indicated</p>
<pre>ATC <I> CALVAL3 OK → ▼ ▲</pre>	<pre>CALVAL3 159.30 ✖</pre>	<ul style="list-style-type: none"> • Integer digits flash, set by pressing ▲ ▼ + OK • Decimal digits flash, set by pressing ▲ ▼ + OK

9.7.1. ATC SENSOR - INTERNAL / EXTERNAL

```
ATC
SENSOR
SENSOR
  INTERN
SENSOR
  EXTERN
```

In the first submenu the ATC function is set for the >INTERN< internal or the >EXTERN< external temperature sensor.

Calibration can be carried out for the internal temperature sensor and for the external temperature sensor connected to the socket „ext. Pt100“. The circulator is able to save both parameter sets. However only the one which has been set under menu item >ATC SENSOR < is displayed.

9.7.2. ATC STATUS - YES / NO

```
ATC <I>
STATUS
STATUS
  YES
STATUS
  NO
```

In the second submenu the ATC function for the temperature sensor selected above is activated >YES< or deactivated >NO<.

>YES< (factory setting) The controller of the circulator uses the original curve of the temperature sensor or the new curve measured during the ATC calibration.

Important: Set to >NO< during the calibration process

>NO< An ATC calibration is to be carried out.

Important: Set to >YES< after calibration.

ⓘ In the > ATC STATUS < >YES< the ATC calibration always affects the current working temperature; also the one set via interface.

9.7.3. CALIBRATION TYPE: 1 -/ 2 -/ 3 POINT

```
ATC (I)
TYPE
```

```
TYPE
I-POINT
```

```
TYPE
2-POINT
```

```
TYPE
3-POINT
```

A >1-point<, >2-point< or >3-point< calibration can be carried out.

First geometrically define the location for calibration (measuring point CT), then determine the temperature values of the calibration points.

The type of calibrations also determines the number of the following pairs of values indicated on the LCD DIALOG-DISPLAY.

```
TMPVAL1 CALVAL1
8000 79.70
```

```
TMPVAL2 CALVAL2
12000 119.50
```

```
TMPVAL3 CALVAL3
16000 159.30
```

Pairs of values:

TMPVAL X: Circulator temperature 1 or 2 or 3 (actual value TT)

The actual temperature of the bath is simultaneously saved with the "calibration value" >CALVAL< and can be indicated for control purposes (value does not flash).

CALVAL X: Calibration temperature 1 or 2 or 3 (actual value CT)

The „calibration value“ is determined with a temperature measuring device and saved under menu item >CALVAL<.

(value flashes \overline{X})

9.7.4. Example: 3-point calibration for internal control

In the temperature range from 80 °C to 160 °C the calibration curve of the temperature sensor (TT) is to be adjusted to the actual temperatures at measuring point (CT).

Menu level 1

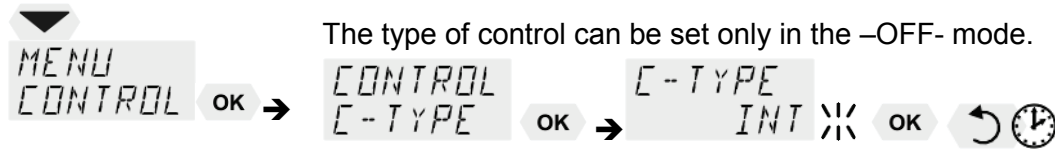

1. Set circulator to internal control: MENU CONTROL page 41

The type of control can be set only in the -OFF- mode.

2. Set working temperature setpoint – SETPNT:

Refer to „Direct temperature setting “ page 27



- By pressing the key the circulator switches to the active >SETPNT< see example on the left: >SETPNT / 1 25.00°C<. The integer digits flash (Example: <25>).
- Change the value to 80.00 °C by pressing the keys and and confirm by pressing the key . The decimal digits flash. Confirm once more by pressing the key .
- The bath is heated up. Wait for approx. 5 minutes until the temperature is constant.

3. Reading of temperature measuring device

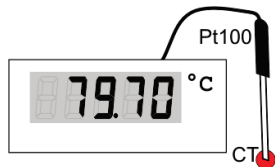

Read the value of measuring point CT on the device and enter under menu item >CALVAL X< by using the keypad.

- >CALVAL 1< (79.70 °C)
- >CALVAL 2< (119.50 °C)
- >CALVAL 3< (159.30 °C)

4. Calibration

Menu level 1



- ① Press the key if parameter is to be retained. Correction function for parameters or values (prior to OK).
- ① Setting is required only for the first calibration point.

Level 2



Parameter level



Set SENSOR INTERN:

- The parameter flashes, switch by pressing and .

<pre>ATC <I> STATUS OK → ▼ ▲</pre>	<pre>STATUS NO ✖ 👁</pre>	<p>An ATC calibration is to be carried out. Set to >NO<</p> <ul style="list-style-type: none"> The parameter flashes, switch by pressing ▲ ▼ and OK .
<pre>ATC <I> TYPE OK → ▼ ▲</pre>	<pre>TYPE 3-POINT ✖ 👁</pre>	<ul style="list-style-type: none"> The parameter flashes, switch by pressing ▲ ▼ and OK . <p>A >3-point< calibration is carried out.</p>
<pre>ATC <I> TMPVAL1 OK → ▼ ▲ ATC <I> CALVAL1 OK → ▼ ▲</pre>	<pre>TMPVAL1 8000 ↻ CALVAL1 79.70 ✖</pre>	<p>The value >TMPVAL< is only indicated In addition the measured value >CALVAL X< is saved during the following step</p> <ul style="list-style-type: none"> Integer digits flash, set by pressing ▲ ▼ (79) + OK Decimal digits flash, set by pressing ▲ ▼ (70) + OK <p>The first of 3 points is calibrated.</p>
Return to 2. Set working temperature value SETPNT: 120.00 °C		
<pre>ATC <I> TMPVAL2 OK → ▼ ▲</pre>	<pre>TMPVAL2 12000 ↻</pre>	<p>The value is only indicated</p>
<pre>ATC <I> CALVAL2 OK → ▼ ▲</pre>	<pre>CALVAL2 119.50 ✖</pre>	<ul style="list-style-type: none"> Integer digits flash, set by pressing ▲ ▼ (119) + OK Decimal digits flash, set by pressing ▲ ▼ (50) + OK <p>The second of 3 points is calibrated.</p>
Return to 2. set working temperature value SETPNT: 160.00 °C		
<pre>ATC <I> TMPVAL3 OK → ▼ ▲</pre>	<pre>TMPVAL3 16000 ↻</pre>	<p>The value is only indicated.</p>
<pre>ATC <I> CALVAL3 OK → ▼ ▲</pre>	<pre>CALVAL3 159.30 ✖</pre>	<ul style="list-style-type: none"> Integer digits flash, set by pressing ▲ ▼ (159) + OK Decimal digits flash, set by pressing ▲ ▼ (30) + OK <p>The 3-point calibration is completed</p>
<p>5. Return to standard operation</p>		
<pre>ATC <I> STATUS OK → ▼ ▲</pre>	<pre>STATUS YES ✖ OK</pre>	<ul style="list-style-type: none"> Set >YES< after calibration. (Standard operation)

9.8. MENU LIMITS

Menu level 1		
Level 2	Parameter level	Press the key if parameter is to be retained. Correction function for parameters or values (prior to OK).
		<ul style="list-style-type: none"> Integer digits flash, set by pressing + Decimal digits flash, set by pressing +
		<ul style="list-style-type: none"> Integer digits flash, set by pressing + Decimal digits flash, set by pressing +
		<ul style="list-style-type: none"> The value flashes, set by pressing +
		<ul style="list-style-type: none"> The value flashes, set by pressing mit +
In case of external control these menu items are additionally indicated.		
		<ul style="list-style-type: none"> Integer digits flash, set by pressing + Decimal digits flash, set by pressing +
		<ul style="list-style-type: none"> Integer digits flash, set by pressing + Decimal digits flash, set by pressing +
		<ul style="list-style-type: none"> The value flashes, set by pressing +
		<ul style="list-style-type: none"> The value flashes, set by pressing +

9.8.1. Limits for internal control

C-TYPE
INT

SETPOINT MAX / MIN – Maximum and minimum setpoint
Restriction of the adjustable temperature range

The limitation of the operating temperature range effects the temperature setting in the menu with the key .

SETMAX
20000

Only setting of working temperatures which lie within the determined limits is possible

SETMIN
-5000

Existing settings for SETPNT 1, -2, -3, as well as those for >OVERTMP< and > SUBTMP < (refer to page 31), are automatically deferred into the limit range.

Setting range: -94,90 °C ... +200,0 °C

 SET MAX > SET MIN
Interchange of values is not possible.

Set maximum heating / cooling

The heating and cooling capacity of the unit are adjustable. 100 % corresponds to the technical specification of the equipment.

Setting range:

HEAT MAX – 0 to 100 % in 1 % steps
COOLING MAX – 0 to 100 % in 1 % steps

HEATMAX
100

COOLMAX
0

9.8.2. Limits for external control

INTERN MAX / MIN

Restriction for the temperature range of the internal bath.

Setting range: -94,9 °C ... +200,0 °C

The limits INT MAX and INT MIN are only active in external control. INT MAX and INT MIN determine fixed limits for the temperature within the internal bath. The temperature controller cannot exceed these limits even if it would be necessary for achieving the temperature in an external system. Therefore it is possible that the external setpoint cannot be achieved.

Sense of limit setting:

- Protects the bath fluid from overheating.
- Prevents an undesired alarm shutdown by the excess temperature protection - >ALARM CODE 14<.
Set the value of > INT MAX at least 5 °C below the value of >SAFETMP<.
- Protects the pump motor from high viscosity of the bath fluid at low temperatures.
- For refrigerated circulators. Freezing protection when using water as bath fluid.

INTMAX
20000

INTMIN
-5000



BAND HIGH / LOW – Band limitation

BAND-H
200

BAND-L
200

The band limitation is active during external control. Varied, practice-oriented settings are feasible for heat-up and cool-down phases.

Setting range: 0 °C ... 200 °C

BAND HIGH and **BAND LOW** allow for the limitation of the difference between the temperatures in the internal bath and the external system to any maximum value for the heat-up and cool-down phase. During the heat-up phase this difference value is always added to the actual external temperature. During the cool-down phase the difference value is subtracted.

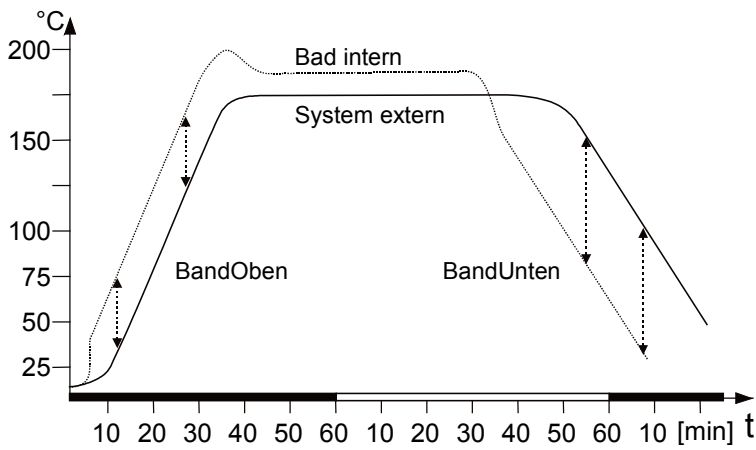

Sense of a band limitation:

- Protection of objects and samples by gentle temperature control
- Protection of e.g. glass reactors from thermal shock.

10. Troubleshooting guide / error messages

-OFF-
ALARM
CODE 01

Alarm with complete shutdown:

If one of the following failures occur a complete, all-pole shutdown of the heater and circulating pump is effected.

„“ lights up and a continuous signal sounds.

The code for the cause of alarm is indicated on the VFD COMFORT-DISPLAY.



00.000
WARNING
CODE 40

Alarm without shutdown:

The code for the cause of alarm is indicated on the VFD COMFORT-DISPLAY. The warning signal sounds in regular intervals. The messages appear every 10 seconds.



Press the key **OK** to stop the signal

ALARM
CODE 01

Error message with ticker: >LOW LEVEL ALARM-FILL MEDIUM <
Low level alarm

The circulator is operated without or insufficient bath fluid.

Switch the unit off with the mains switch, refill bath fluid and switch on!

Tube breakage has occurred (insufficient filling level of bath fluid caused by pumping-out)

Replace the tubing and refill bath liquid.

The float is defect (e.g. transport damage).

Repair by authorized JULABO service personnel.

ALARM
CODE 02

Error message with ticker:

> REFRIGERATOR ALARM-CHECK CONNECTION <

During the self-test after switch-on a short –circuit is detected between pin 2 and pin 4 of the control line or the control line was disconnected during operation.

Reconnect the control line or repair short-circuit.

WARNING
CODE 03

Error message with ticker:

> EXCESS TEMPERATURE WARNING-CHECK LIMITS <

Excess temperature warning

or

Excess temperature alarm

Type of warning: set to >warning< or >alarm< (refer to page 30)

ALARM
CODE 03

WARNING
CODE 04

Error message with ticker:

> LOW TEMPERATURE WARNING-CHECK LIMITS <

Low temperature warning

or

Low temperature alarm.

Typ of warning: set to >warning< or >alarm< (refer to page 30)

ALARM
CODE 04

ALARM
CODE 05

Error message with ticker:

> WORKING SENSOR ALARM-CALL SERVICE <

Cable of working temperature sensor is disconnected or short-circuited.

<p>ALARM CODE 06</p>	<p>Error message with ticker: >SENSOR DIFFERENCE ALARM-CHECK VISCOSITY AND PUMP STAGE< Defect of working or excess temperature protector. Working temperature sensor and excess temperature protector report a temperature difference of more than 35 K.</p>
<p>ALARM CODE 07</p>	<p>Error message with ticker: > INTERNAL HARDWARE ERROR-CALL SERVICE < Other errors</p>
<p>ALARM CODE 12</p>	<p>Error in A/D converter</p>
<p>ALARM CODE 14</p>	<p>Error message with ticker: > EXCESS TEMPERATURE PROTECTOR ALARM-CHECK ADJUSTMENT < Excess temperature protector defect. The protection temperature is below the set working temperature setpoint. Set the protection temperature to a higher value.</p>
<p>ALARM CODE 15</p>	<p>Error message with ticker: > EXTERNAL SENSOR ALARM-CHECK EXTERNAL SENSOR < External control was set but the Pt100 external sensor was not connected or is defect.</p>
<p>WARNING CODE 20</p>	<p>Error message with ticker: > CLEAN CONDENSER OR CHECK COOLING WATER < Insufficient cooling of condenser. Clean the air-cooled condenser. Check the flow and the temperature of the cooling water of a water-cooled condenser.</p>
<p>WARNING CODE 21</p>	<p>Error message with ticker: > COMPRESSOR FAILURE-CHECK REFRIGERATOR < Stage 1 of the compressors does not work. Automatic restart after short cool-down, message E 21 goes off.</p>
<p>WARNING CODE 22</p>	<p>Stage 2 of the compressor does not work. <u>Cooling machine – overload protection</u> The driving motor of the cooling compressor is equipped with an overload protection which is triggered by increased internal temperatures or excessive current consumption. Shutdown can be caused by - insufficient ventilation, - insufficient wall distance, - soiled condenser, - high room temperature - switching off and on in short sequence</p>
<p>WARNING CODE 23</p>	<p>Excess temperature in stage 1 of the compressor.</p>
<p>WARNING CODE 24</p>	<p>Excess temperature in stage 2 of the compressor.</p>
<p>WARNING CODE 25</p>	<p>Short circuit of control line to cooling machine during self-test.</p>

ALARM
CODE 33

Error message with ticker:
> SAFETY SENSOR ALARM-CALL SERVICE <

The cable of the excess temperature protector has been disconnected or short-circuited

WARNING
CODE 40

Error message with ticker:
> LOW LEVEL WARNING-FILL MEDIUM <

The early warning system for low level reports a critical fluid level. Refill bath fluid.

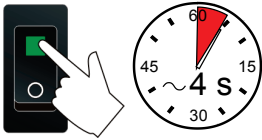

By quickly switching off and restarting the unit the alarm is cancelled.
If the error occurs once more after the restart, a remote diagnosis is required.

C-Err
PRESS
OK

Error message with ticker:
> CONFIGURATION ERROR-PRESS OK<

The configuration of the circulator does not correspond with its current application.

Press the **OK** key for a non-recurring, automatic change of the configuration.

In this case please call the JULABO Technical Service or an authorized dealer.

Disturbances that are not indicated.

The electronic pump motor is overload-protected by an electronic current limiter. If viscosity of the bath fluid is or becomes too high, the motor stops running.

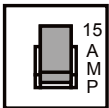

Mains circuit breakers (resettable) 15 A

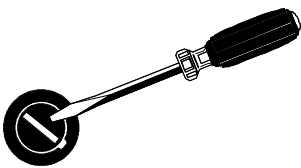

Cooling machine: Fuse T 10.0 A, dia.5 x 20 mm

The mains fuses (8b) on the rear of the unit may easily be exchanged as shown on the left.



Warning:

Before exchanging the fuses, turn off the mains power switch and disconnect the power plug from the mains socket!

Only use fine fuses with a nominal value as specified.

Example:

Manufacturer	Supplier	Type	Order No.
Wickmann	Wickmann	G- fuse insert T10,0A 5x20 mm	No. 19195

11. Electrical connections



Notice:

Use shielded cables only.

The shield of the connecting cable is electrically connected to the plug housing.

The unit ensures safe operation if connecting cables with a maximum length of 3 m are used. The use of longer cables does not affect proper performance of the unit, however external interferences may have a negative impact on safe operation (e.g. cellular phones).

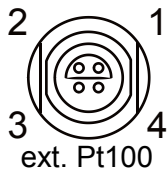

Socket for external Pt100 sensor

Pin assignment:

Pin	Signal
1	I+
2	U+
3	U-
4	I-

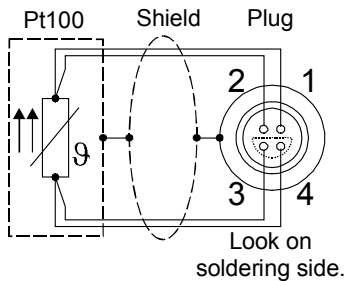

The shield of the connecting cable is electrically connected to the plug housing and the sensor tube.

RS232 serial interface

This port can be used to connect a computer with an RS232 cable for remote control of the circulator.

Pin assignments RS232:

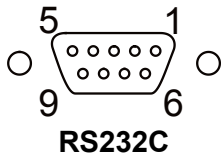

Pin 2	RxD	Receive Data
Pin 3	TxD	Transmit Data
Pin 5	0 V	Signal GND
Pin 7	RTS	Request to send
Pin 8	CTS	Clear to send

Pin 1; 4; 6, 9 Reserved - do not use!

RS232 interface cable

Circulator (9-pol)		PC (9-pol)
Pin 2 RxD	↔	Pin 3 TxD
Pin 3 TxD	↔	Pin 2 RxD
Pin 5 GND	↔	Pin 5 GND
Pin 7 RTS	↔	Pin 8 CTS
Pin 8 CTS	↔	Pin 7 RTS

Accessories:

Order No.

Description

8 980 073	RS232 interface cable 9-pol./9-pol. , 2,5 m
8 900 110	USB interface adapter cable

❄ / Control output

The ❄ connector may be used for control of JULABO refrigerated circulators or as output for alarm messages.

Circuit: Operation = relay powered
 Alarm = relay not powered

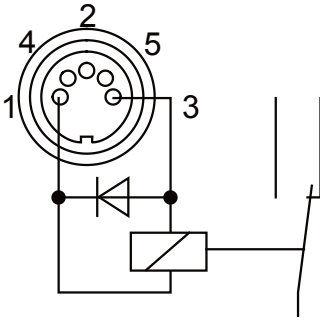

Pin assignment:

Pin	Signal
1	+24 V (I max. current 25 mA)
2	0 V
3	Alarm relay
4	Reserved - do not use!
5	Cooling pulse

12. Remote control

12.1. Setup for remote control

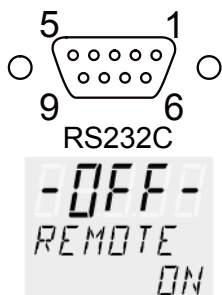

1. Check the interface parameters for both interfaces (on circulator and PC) and make sure they match.
(Serial interface refer to page 45)
2. In the menu > MENU CONFIG < set the menu item > REMOTE < to > ON < .
3. Connect both units with an interface cable..



Like all parameters which can be entered through the keypad, interface parameters are stored in memory even after the circulator is turned off.

12.2. Communication with a PC or a superordinated data system

If the circulator is put into remote control mode via the configuration level, the VFD COMFORT-DISPLAY will read "R -OFF-" = REMOTE STOP. The circulator is now operated via the computer.

In general, the computer (master) sends commands to the circulator (slave). The circulator sends data (including error messages) only when the computer sends a query.



In remote control mode, the start command and all values to be set must be resent by the PC via the interface in case of a power interruption. AUTOSTART is not possible.

A transfer sequence consists of:

- command
- space (↔; Hex: 20)
- parameter (decimal separation with a period)
- end of file (↵; Hex: 0D)

The commands are divided into **in** and **out** commands.

in commands: retrieve parameters

out commands: set parameters

Important times for a command transmission:



To ensure a safe data transfer, the time gap between two commands should be at least 250 ms.

The circulator automatically responds to an **in** command with a data string followed by a LF (Line Feed). The next command should only be sent after 10 ms.



The out commands are valid only in remote control mode.

Command to set the working temperature > SETPNT 1< 55.5 °C
out_sp_00 ↔ 55.5↵

Command to retrieve the working temperature > SETPNT 1< in_sp_00↵

Response from the circulator: 55.5↵

12.3. List of commands

out commands: Setting temperature values or parameters.

Command	Parameter	Response of circulator
out_mode_01	0	Use working temperature > SETPNT 1<
out_mode_01	1	Use working temperature > SETPNT 2<
out_mode_01	2	Use working temperature > SETPNT 3<
out_mode_04	0	Temperature control of internal bath.
out_mode_04	1	External control with Pt100 sensor.
out_mode_05	0	Stop the unit = R –OFF-.
out_mode_05	1	Start the unit.
out_mode_08	0	Set the control dynamics - aperiodic
out_mode_08	1	Set the control dynamics - standard
out_sp_00	xxx.xx	Set working temperature. „SETPNT 1“
out_sp_01	xxx.xx	Set working temperature. „SETPNT 2“
out_sp_02	xxx.xx	Set working temperature. „SETPNT 3“
out_sp_03	xxx.xx	Set high temperature warning limit „OVERTMP“
out_sp_04	xxx.xx	Set low temperature warning limit „SUBTMP“
out_sp_07	x	Set the pump pressure stage. (1 ... 4)
out_par_04	x.x	CoSpeed 0 ... 5.0 Band limit during external control. Setting the maximum difference between the temperatures in the internal bath and external system.
out_par_06	xxx	Xp control parameter of the internal controller. 0.1 ... 99.9
out_par_07	xxx	Tn control parameter of the internal controller. 3 ... 9999
out_par_08	xxx	Tv control parameter of the internal controller. 0 ... 999
out_par_09	xxx	Xp control parameter of the cascade controller. 0.1 ... 99.9
out_par_10	xxx	Proportional portion of the cascade controller. 1 ... 99.9
out_par_11	xxx	Tn control parameter of the cascade controller. 3 ... 9999
out_par_12	xxx	Tv control parameter of the cascade controller. 0 ... 999
out_par_13	xxx	Maximum internal temperature of the cascade controller.
out_par_14	xxx	Minimum internal temperature of the cascade controller.
out_par_15	xxx	Band limit (upper) 0 ... 200 °C
out_par_16	xxx	Band limit (lower) 0 ... 200 °C

in commands: Asking for parameters or temperature values to be displayed.

Command	Parameter	Response of circulator
version	none	Number of software version (V X.xx)
status	none	Status message, error message (see page 63)
in_pv_00	none	Actual bath temperature.
in_pv_01	none	Heating power being used (%).
in_pv_02	none	Temperature value registered by the external Pt100 sensor.
in_pv_03	none	Temperature value registered by the safety sensor.
in_pv_04	none	Setpoint temperature of the excess temperature protection
in_sp_00	none	Working temperature „SETPNT 1“
in_sp_01	none	Working temperature „SETPNT 2“
in_sp_02	none	Working temperature „SETPNT 3“
in_sp_03	none	High temperature warning limit „OVERTEMP“
in_sp_04	none	Low temperature warning limit „SUBTEMP“
in_sp_07	none	Pump pressure stage
in_par_01	none	Te - Time constant of the external bath.
in_par_02	none	Si - Internal slope
in_par_03	none	Ti - Time constant of the internal bath.
in_par_04	none	CoSpeed - Band limit (max. difference between the temperatures in the internal bath and external system).
in_par_05	none	Factor pk/ph0: Ratio of max. cooling capacity versus max. heating capacity
in_par_06	none	Xp control parameter of the internal controller.
in_par_07	none	Tn control parameter of the internal controller.
in_par_08	none	Tv control parameter of the internal controller.
in_par_09	none	Xp control parameter of the cascade controller.
in_par_10	none	Proportional portion of the cascade controller.
in_par_11	none	Tn control parameter of the cascade controller.
in_par_12	none	Tv control parameter of the cascade controller.
in_par_13	none	Adjusted maximum internal temperature of the cascade controller.
in_par_14	none	Adjusted minimum internal temperature of the cascade controller.
in_par_15	none	Band limit (upper)
in_par_16	none	Band limit (lower)

Command	Parameter	Response of circulator
in_mode_01	none	Selected setpoint: 0 = SETPNT 1 1 = SETPNT 2 2 = SETPNT 3 3 = Last setpoint setting was carried out through an external programmer
in_mode_04	none	Internal/external temperature control: 0 = Temperature control with internal sensor. 1 = Temperature control with external Pt100 sensor.
in_mode_05	none	Circulator in Stop/Start condition: 0 = Stop 1 = Start
in_mode_08	none	Adjusted control dynamics 0 = aperiodic 1 = standard

12.4. Status messages

Status messages	Description
00 MANUAL STOP	Circulator in „OFF“ state.
01 MANUAL START	Circulator in keypad control mode.
02 REMOTE STOP	Circulator in „r OFF“ state.
03 REMOTE START	Circulator in remote control mode.

12.5. Error messages

Error messages	Description
-01 LOW LEVEL ALARM	Low liquid level alarm.
-02 REFRIGERATOR ALARM	Control cable of the refrigerated circulator or MVS solenoid valve controller short-circuited or interrupted.
-03 EXCESS TEMPERATURE WARNING	High temperature warning.
-04 LOW TEMPERATURE WARNING	Low temperature warning.
-05 WORKING SENSOR ALARM	Working temperature sensor short-circuited or interrupted.

Error messages	Description
-06 SENSOR DIFFERENCE ALARM	Sensor difference alarm. Working temperature and safety sensors report a temperature difference of more than 35 K.
-07 I²C-BUS ERROR	Internal error when reading or writing the I ² C bus.
-08 INVALID COMMAND	Invalid command.
-09 COMMAND NOT ALLOWED IN CURRENT OPERATING MODE	Invalid command in current operating mode.
-10 VALUE TOO SMALL	Entered value too small.
-11 VALUE TOO LARGE	Entered value too large.
-12 TEMPERATURE MEASUREMENT ALARM	Error in A/D converter.
-13 WARNING : VALUE EXCEEDS TEMPERATURE LIMITS	Value lies outside the adjusted range for the high and low temperature warning limits. But value is stored.
-14 EXCESS TEMPERATURE PROTECTOR ALARM	Excess temperature protector alarm
-15 EXTERNAL SENSOR ALARM	External control selected, but external Pt100 sensor not connected.
-20 WARNING: CLEAN CONDENSOR OR CHECK COOLING WATER CIRCUIT OF REFRIGERATOR	Cooling of the condenser is affected. Clean air-cooled condenser. Check the flow rate and cooling water temperature on water-cooled condenser.
-21 WARNING: COMPRESSOR STAGE 1 DOES NOT WORK	Compressor stage 1 does not work.
-22 WARNING: COMPRESSOR STAGE 2 DOES NOT WORK	Compressor stage 2 does not work.
-23 WARNING: HIGH TEMPERATURE ON COMPRESSOR STAGE 1	Excess temperature on compressor stage 1.
-24 WARNING: HIGH TEMPERATURE ON COMPRESSOR STAGE 2	Excess temperature on compressor stage 2.
-25 REFRIGERATOR WARNING	Error in the cooling machine.
-30 CONFIGURATION ERROR: CONFIRM BY PRESSING <OK> ON CIRCULATOR	The configuration of the circulator does not conform to its present use. Press OK to automatically perform a single modification of the configuration.
-33 SAFETY SENSOR ALARM	Excess temperature sensor short-circuited or interrupted.
-40 NIVEAU LEVEL WARNUNG	Low liquid level warning in the internal reservoir.

13. JULABO Service – Online remote diagnosis

JULABO circulators of the HighTech series are equipped with a black box. This box is implemented in the controller and records all significant data for the last 30 minutes.

In case of a failure, this data can be read out from the unit by using special software. This software is available as a **free** download from www.julabo.com \ EasyBlackBox.

- Installation is easy and is performed step by step. Please observe the instructions.
- Data read-out is possible in the conditions “OFF”, “R OFF” or “ALARM”.
- Connect the circulator to the computer using an interface cable.
- Start the EasyBlackBox program. The program asks for the port used (COM1,) and the baud rate of the unit. You do not have this information on hand? Simply try it out! The program continues to send the request until the correct settings are made.

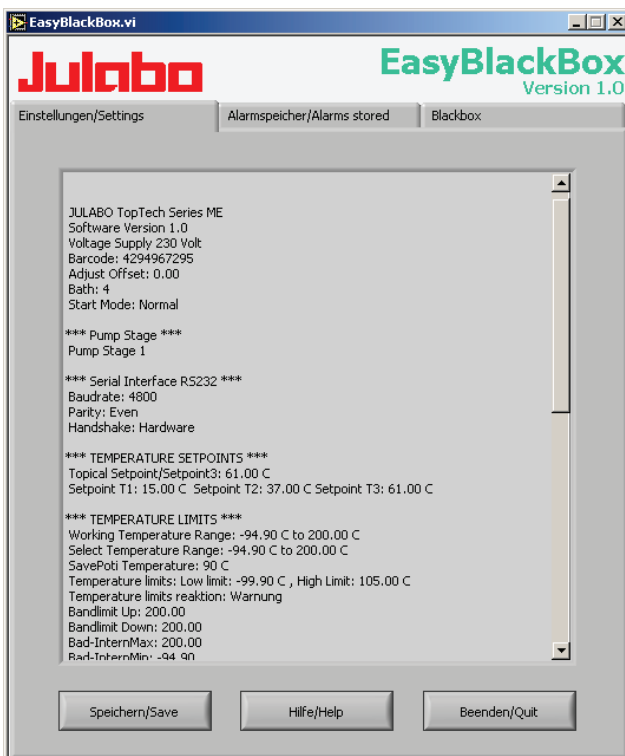

- Data is read out and shown on the monitor divided in the sections >Einstellungen/Settings<, >Alarmspeicher/Alarms stored<, >Blackbox<
- ← see example
- After pressing >Speichern/Save< a text file is compiled. The program proposes a filename - >C:\model description and barcode no.<. Modifications are possible.
- E-mail this file to ServiceUSA@Julabo.com, JULABO's service department. JULABO is thus able to provide rapid support.

14. Cleaning / repairing the unit



Caution:

- Always turn off the unit and disconnect the mains cable from the power source before cleaning the unit.
- Prevent humidity from entering into the circulator.
- Electrical connections and any other work must be performed by qualified personnel only.

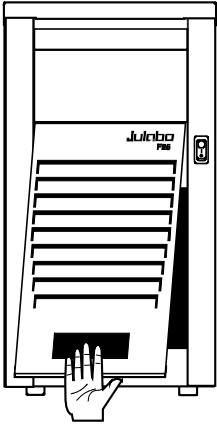

Maintaining the cooling performance

To maintain the full cooling performance, clean the condenser from time to time.

- Switch off the unit, disconnect mains power cable.
- Hold the venting grid, pull out and remove.
- Clean the ribbed condenser with a vacuum cleaner.
- Replace the venting grid.
- Switch on the unit.

Cleaning:

For cleaning the bath tank and the immersed parts of the circulator, use low surface tension water (e.g., soap suds).
Clean the outside of the unit using a wet cloth and low surface tension water.

The circulator is designed for continuous operation under normal conditions. Periodic maintenance is not required.

The tank should be filled only with a bath fluid recommended by JULABO. To avoid contamination, it is essential to change the bath fluid from time to time.

Repairs

Before asking for a service technician or returning a JULABO instrument for repair, please contact an authorized JULABO service station.

When returning the unit:

- Clean the unit in order to avoid any harm to the service personnel.
- Attach a short fault description.
- During transport the unit has to stand upright. Mark the packing correspondingly.
- When returning a unit, take care of careful and adequate packing.
- JULABO is not responsible for damages that might occur from insufficient packing.



JULABO reserves the right to carry out technical modifications with repairs for providing improved performance of a unit.

15. WARRANTY PROVISIONS

The following Warranty Provisions shall apply to products sold in North America by Julabo (“**Seller**”) to the entity shown as buyer (“**Buyer**”) on Seller’s invoice.

1. **Initial Warranty.** Upon Seller’s receipt of payment in full for the products and subject to Buyer’s compliance with the terms of sale and any other agreement with Seller relating to the products, Seller warrants to the Buyer that the products manufactured by the Seller are free from defects in material and workmanship for a period not to exceed two (2) years or ten thousand (10,000) hours of operation, whichever comes first, from the date the product is shipped by Seller to Buyer (the “**Initial Warranty**”).

2. **EXCLUSION OF ALL OTHER EXPRESS WARRANTIES; EXCLUSION OF ALL IMPLIED WARRANTIES. OTHER THAN THE INITIAL WARRANTY, NO OTHER EXPRESS WARRANTIES ARE MADE. ALL IMPLIED WARRANTIES OF EVERY TYPE AND KIND, INCLUDING BUT NOT LIMITED TO ANY IMPLIED WARRANTY OF MERCHANTABILITY OR FITNESS FOR A PARTICULAR PURPOSE OR USE, ARE EXCLUDED IN ALL RESPECTS AND FOR ALL PURPOSES. SELLER DISCLAIMS AND MAKES NO IMPLIED WARRANTIES WHATSOEVER.**

3. **Exclusions.** The Initial Warranty does not include damage to the product resulting from accident, misuse, improper installation or operation, unauthorized or improper repair, replacement or alteration (including but not limited to repairs, replacements, or alterations made or performed by persons other than Seller’s employees or authorized representatives), failure to provide or use of improper maintenance, unreasonable use or abuse of the product, or failure to follow written installation or operating instructions. Buyer must return the product’s record of purchase to the Seller or one of Seller’s authorized representatives within thirty (30) days of the date the product is shipped by Seller to Buyer in order to make a claim under the Initial Warranty. Notwithstanding anything contained herein to the contrary, all glassware, including but not limited to reference thermometers, are expressly excluded from the Initial Warranty.

4. **Buyer’s sole remedies; Limitations on Seller’s Liability.** Buyer’s sole and exclusive remedy under the Initial Warranty is strictly limited, in Seller’s sole discretion, to either: (i) repairing defective parts; or (ii) replacing defective parts. In either case, the warranty period for the product receiving a repaired or replaced part pursuant to the terms of the Initial Warranty shall not be extended. All repairs or replacements performed by Seller pursuant to these Warranty Provisions shall be performed at Seller’s facility in Allentown, Pennsylvania, U.S.A. or at the facility of an authorized representative of Seller, which location shall be determined by Seller in its sole discretion; provided, however, that Seller may, in its sole discretion perform such repairs or replacements at Buyer’s facility in which case Buyer shall pay Seller’s travel, living and related expenses incurred by Seller in performing the repairs or replacements at Buyer’s facility. As a condition precedent to Seller’s obligation to repair or replace a product part under the Initial Warranty, Buyer shall (i) promptly notify Seller in writing of any such defect; (ii) shall have returned the product’s record of purchase to Seller or to one of Seller’s authorized representatives within thirty (30) days of the date the product is delivered to Buyer; and (iii) assist Seller in all respects in its attempts to determine the legitimacy and basis of any claims made by or on behalf of Buyer including but not limited to providing Seller with access to the product to check operating conditions. If Buyer does not provide such written notice to Seller within the Initial Warranty period or fails to return the product’s record of purchase as set forth above, Seller shall have no further liability or obligation to Buyer therefore. In no event shall Seller’s liability under the Initial Warranty exceed the original purchase price of the product which is the subject of the alleged defect.

5. **THE REMEDIES PROVIDED IN THE INITIAL WARRANTY ARE THE SOLE AND EXCLUSIVE REMEDIES AVAILABLE TO THE BUYER. NOTWITHSTANDING ANYTHING TO THE CONTRARY CONTAINED HEREIN, AND EVEN IF THE SOLE AND EXCLUSIVE REMEDIES FAIL OF THEIR ESSENTIAL PURPOSE FOR ANY REASON WHATSOEVER, IN NO EVENT SHALL SELLER BE LIABLE FOR BUYER’S MANUFACTURING COSTS, LOST PROFITS, GOODWILL, OR ANY OTHER SPECIAL, INDIRECT, PUNITIVE,**

WARRANTY PROVISIONS

INCIDENTAL OR CONSEQUENTIAL DAMAGES TO BUYER OR ANY THIRD PARTY AND ALL SUCH DAMAGES ARE HEREBY DISCLAIMED.

6. **Assignment.** Buyer shall not assign any of its rights or obligations hereunder without the prior written approval of Seller; provided, however, that if Buyer is a distributor of Seller, the rights and obligations of Buyer under these Warranty Provisions shall inure to the benefit of and be binding upon Buyer's customers who provide the product's proof of purchase to Seller pursuant to the terms set forth herein. Seller may assign any or all of its rights or obligations hereunder without Buyer's prior consent.

7. **Governing Law.** The Warranty Provisions and all questions relating to their validity, interpretation, performance, and enforcement shall be construed in accordance with, and shall be governed by, the substantive laws of the Commonwealth of Pennsylvania without regard to its principles of conflicts of law.

8. **Waiver.** Any failure of the part of Seller to insist on strict compliance with the Warranty Provisions shall no way constitute a waiver of such right. No claim or rights arising out of a breach of the Warranty Provisions by Buyer may be discharged in whole or in part by a waiver of the claim or right, unless the waiver is in writing signed by an authorized representative of Seller. Seller's waiver or acceptance of any breach by Buyer of any provisions of the Warranty Provisions shall not constitute a waiver of or an excuse for nonperformance as to any other provision of the Warranty Provisions nor as to any prior or subsequent breach of the same provision.

9. **Freight.** Buyer will arrange and pay for shipping and handling charges for the unit to be returned to the Seller. Seller will arrange and pay for shipping and handling for the return of the unit to the Buyer.