

Operating Manual

SemiChill Recirculating Coolers

Professional Series

SC 2500a
air cooled

SC 2500w
water cooled

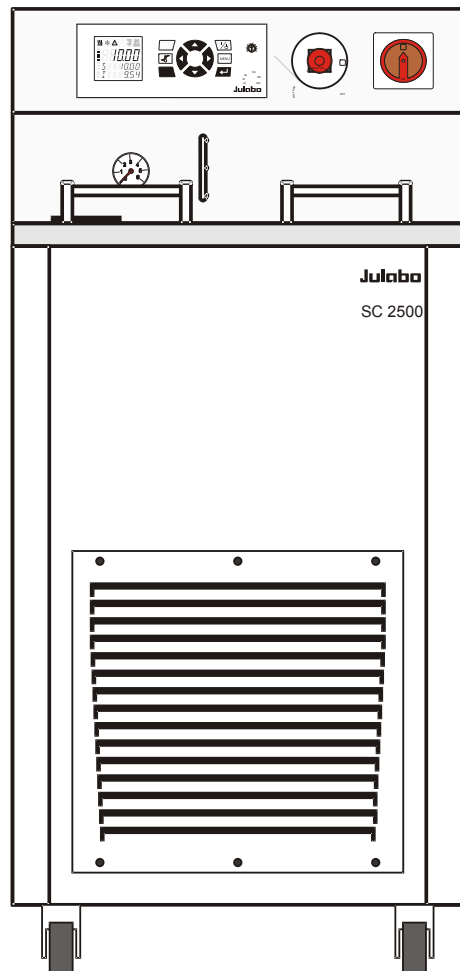

Julabo
THE TEMPERATURE CONTROL COMPANY

JULABO GmbH
77960 Seelbach / Germany
Tel. +49 (0) 7823 / 51-0
Fax +49 (0) 7823 / 24 91
info.de@julabo.com
www.julabo.com

Congratulations!

You have made an excellent choice.

JULABO thanks you for the trust you have placed in us.

This operating manual has been designed to help you gain an understanding of the operation and possible applications of our circulators. For optimal utilization of all functions, we recommend that you thoroughly study this manual prior to beginning operation.

The JULABO Quality Management System



Temperature control devices for research and industry are developed, produced, and distributed according to the requirements of ISO 9001 and ISO 14001. Certificate Registration No. 01 100044846

Unpacking and inspecting



Unpack the circulator and accessories and inspect them for possible transport damage. Damage should be reported to the responsible carrier, railway, or postal authority, and a damage report should be requested. These instructions must be followed fully for us to guarantee our full support of your claim for protecting against loss from concealed damage. The form required for filing such a claim will be provided by the carrier.

Printed in Germany

Changes without prior notification reserved

Important: keep original operating manual for future use

TABLE OF CONTENTS

Operating manual.....	5
1. Intended use.....	5
1.1. Description.....	5
2. Operator responsibility – Safety instructions.....	6
2.1. Disposal.....	8
2.2. EC Conformity.....	9
2.3. Warranty conditions.....	10
2.4. Technical specifications.....	11
2.5. Cooling water connection.....	15
Operating instructions.....	16
3. Operating controls and functional elements.....	16
4. Safety notes for the user.....	19
4.1. Explanation of safety notes.....	19
4.2. Explanation of other notes.....	19
4.3. Safety instructions.....	19
5. Preparations.....	21
5.1. Installation.....	21
5.2. Connecting the external system.....	22
5.2.1. Tubing.....	23
5.2.2. Bath fluids.....	23
5.3. Filling.....	24
5.4. Draining.....	25
6. Operating procedures.....	26
6.1. Power connection.....	26
6.2. Switching on / Start - Stop.....	26
7.  Setting the temperatures.....	27
8.  Safety installations, warning functions.....	28
8.1. Excess temperature protection.....	28
8.1.1. Early warning system, low level protection.....	29
8.2. Over and Sub temperature warning functions.....	30
8.2.1. Change-over of the warning function to shutdown function.....	31

9.	MENU Menu functions.....	32
9.1.	MENU PUMP - Setting the pump pressure	33
9.2.	MENU CONTROL – Control parameters.....	34
9.2.1.	CONTROL – internal / external control	34
9.2.2.	SELFTUNING.....	36
9.2.3.	DYN INT - Dynamic internal.....	37
9.2.4.	Control parameters – XP, TN, TV internal.....	37
9.2.5.	COSPEED - external	39
9.2.6.	Control parameters – XPU, XP, TN, TV external	40
9.3.	MENU CONFIG - configuration	40
9.3.1.	SETPOINT – Keypad control or remote control	41
9.3.2.	A-START – Autostart.....	42
9.3.3.	OFF-MODE – Pump motor on / off	43
9.3.4.	RESET – Factory settings	43
9.3.5.	ACTVAR - actuating variable	44
9.3.6.	TIME / DATE – setting time and date.....	45
9.4.	MENU SERIAL - BAUDRATE, HANDSHAKE, PARITY.....	46
9.5.	MENU LIMITS.....	47
9.6.	MENU PROGRAM – Integrated programmer.....	49
9.7.	MENU ADJUST – ATC Absolute Temperature Calibration.....	53
9.8.	MENU ANALOG – Analog inputs/outputs.....	57
10.	Troubleshooting guide / Error messages	63
11.	Electrical connections	65
12.	Remote control	67
12.1.	Setup for remote control.....	67
12.2.	Communication with a PC or a superordinated data system	67
12.3.	List of commands	68
12.4.	Status messages	72
12.5.	Error messages.....	72
13.	JULABO Service – Online remote diagnosis.....	73
14.	Cleaning / repairing the unit.....	74

Operating manual

1. Intended use

JULABO recirculating coolers have been designed to control the temperature of specific fluids in a bath tank. The units feature pump connections for temperature control of external systems (loop circuit).



JULABO recirculating coolers are not suitable for direct temperature control of foods, semi-luxury foods and tobacco, or pharmaceutical and medical products. Direct temperature control means unprotected contact of the object with the bath medium (bath fluid).

1.1. Description

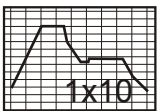
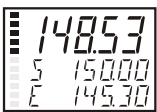

ICC

TCF

ATC³

RS232

Pt100

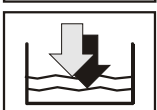
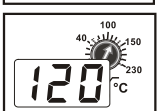

SMART PUMP

- The recirculating coolers are operated via the splash-proof keypad. The implemented microprocessor technology allows to set and to store different values that can be indicated on the VFD COMFORT-DISPLAY. Three menu keys facilitate adjusting setpoints, warning and safety functions and menu functions.
- The integrated programmer allows storing and running temperature and time-dependent processes.
- “ICC - Intelligent Cascade Control“ represents the supreme solution temperature control. ICC offers perfect temperature control with self-optimizing PID control parameters.
- The TCF - **T**emperature **C**ontrol **F**eatures allow the user to have access to all important temperature control parameters. This means: Full control on the control mode and the chance to manually adjust or adapt control to the specific application.
- Absolute Temperature Calibration (ATC³) provides a high temperature stability in the bath. With the 3-point calibration an offset is adjusted at three temperatures to ensure an accurate temperature pattern at the selected spot in the bath over the full temperature range.
- Electrical connections:
 The serial interface, switchable from RS232 to RS485, allows modern process technology without additional interface.
 Connection for Pt100 external sensor for external temperature measurement and control.
 The electronic module (option) provides 3 further analog connections (alarm input, standby input, recorder output, programmer input).
- The excess temperature protection conforming to IEC 61010-2-010 is a safety installation independent from the control circuit. This protection can be indicated and set on the VFD COMFORT-DISPLAY.
- The early warning system for low level signals that bath fluid needs to be refilled before the low level protection conforming to IEC 61010-2-010 causes a complete shutdown of the main functional elements.
- Intelligent pump system: The pump capacity (electronically adjustable via the motor speed) enables to adapt to varying conditions for internal and external temperature applications.

2. Operator responsibility – Safety instructions

The products of JULABO ensure safe operation when installed, operated, and maintained according to common safety regulations. This section explains the potential dangers that may arise when operating the circulator and also specifies the most important safety precautions to preclude these dangers as far as possible.

The operator is responsible for the qualification of the personnel operating the units.

- The personnel operating the units should be regularly instructed about the dangers involved with their job activities as well as measures to avert these dangers.
- Make sure all persons tasked with operating, installing, and maintaining the unit have read and understand the safety information and operating instructions.
- When using hazardous materials or materials that could become hazardous, the circulator may be operated only by persons who are absolutely familiar with these materials and the circulator. These persons must be fully aware of possible risks.

If you have any questions concerning the operation of your unit or the information in this manual, please contact us!

Contact:	JULABO GmbH Gerhard-Juchheim-Strasse 1 77960 Seelbach / Germany	Tel. +49 (0) 7823 / 51-0 Fax +49 (0) 7823 / 24 91	info.de@julabo.com www.julabo.com
-----------------	---	--	--

Safety instructions for the operator:

- Avoid strikes to the housing, vibrations, damage to the operating-element panel (keypad, display), and contamination.
- Make sure the product is checked for proper condition regularly (depending on the conditions of use). Regularly check (at least every 2 years) the proper condition of the mandatory, warning, prohibition and safety labels.
- Make sure that the mains power supply has low impedance to avoid any negative effects on the instruments being operated on the same mains.
- This unit is designed for operation in a controlled electromagnetic environment. This means that transmitting devices (e.g., cellular phones) should not be used in the immediate vicinity.
- Magnetic radiation may affect other devices with components sensitive to magnetic fields (e.g., monitors). We recommend maintaining a minimum distance of 1 m.
- Permissible ambient temperature: max. 40 °C, min. 5 °C.
- Permissible relative humidity: 50% (40 °C).
- Do not store the unit in an aggressive atmosphere. Protect the unit from contamination.
- Do not expose the unit to sunlight.

Appropriate operation

Only qualified personnel is authorized to configure, install, maintain, or repair the circulator. Persons who operate the circulator must be trained in the particular tasks by qualified personnel. The summarized user guidance (short manual) and the specification table with information on individual parameters are sufficient for this.

Use

The bath can be filled with flammable materials. Fire hazard!



There might be chemical dangers depending on the bath medium used.

Observe all warnings for the used materials (bath fluids) and the respective instructions (safety data sheets).

Insufficient ventilation may result in the formation of explosive mixtures. Only use the unit in well ventilated areas.

Only use recommended materials (bath fluids). Only use non-acid and non corroding materials.

When using hazardous materials or materials that could become hazardous, **the operator must** affix the enclosed safety labels (**1 + 2**) to the front of the unit so they are highly visible:

1		Danger area. Attention! Observe instructions. (operating manual, safety data sheet)
2 or		Carefully read the user information prior to beginning operation. Scope: EU
2		Carefully read the user information prior to beginning operation. Scope: USA, NAFTA

Particular care and attention is necessary because of the wide operating range.

There are thermal dangers: Burn, scald, hot steam, hot parts and surfaces that can be touched.

	Hot surface warning. (The label is put on by JULABO)
---	---

Observe the instructions in the manuals for instruments of a different make that you connect to the circulator, particularly the corresponding safety instructions. Also observe the pin assignment of plugs and technical specifications of the products.

2.1. Disposal

The recirculating cooler contains a back-up battery that supplies voltage to the memory chips when the unit is switched off. Do not dispose of the battery with household waste!

Depending on battery regulations in your country, you may be obligated to return used or defective batteries to collection sites.

The product may be used with oil as bath fluid. These oils fully or partially consist of mineral oil or synthetic oil. For disposal, follow the instructions in the material safety data sheets.

This unit contains the refrigerant R452A, which at this time is not considered harmful to the ozone layer. However, over the long operating period of the unit, disposal rules may change. Therefore, only qualified personnel should handle the disposal.



Valid in EU countries

See the current official journal of the European Union – WEEE directive.

Directive of the European Parliament and of the Council on waste electrical and electronic equipment (WEEE).

This directive requires electrical and electronic equipment marked with a crossed-out trash can to be disposed of separately in an environmentally friendly manner. Contact an authorized waste management company in your country.

Disposal with household waste (unsorted waste) or similar collections of municipal waste is not permitted!

2.2. EC Conformity

EG-Konformitätserklärung nach EG Maschinenrichtlinie 2006/42/EG, Anhang II A EC-Declaration of Conformity to EC Machinery Directive 2006/42/EC, Annex II A

Hersteller / Manufacturer:

JULABO GmbH
Gerhard-Juchheim-Strasse 1
77960 Seelbach / Germany
Tel: +49(0)7823 / 51 - 0



Hiermit erklären wir, dass das nachfolgend bezeichnete Produkt
We hereby declare, that the following product

Produkt / Product: Umlaufkühler / Recirculating Cooler

Typ / Type: SC2500a; SC2500w

Serien-Nr. / Serial-No.: siehe Typenschild / see type label

aufgrund seiner Konzipierung und Bauart in der von uns in Verkehr gebrachten Ausführung den grundlegenden Sicherheits- und Gesundheitsanforderungen den nachfolgend aufgeführten EG-Richtlinien entspricht.
due to the design and construction, as assembled and marketed by our Company – complies with fundamental safety and health requirements according to the following EC-Directives.

Maschinenrichtlinie 2006/42/EG; Machinery Directive 2006/42/EC
EMV-Richtlinie 2014/30/EU; EMC-Directive 2014/30/EU
RoHS-Richtlinie 2011/65/EU; RoHS-Directive 2011/65/EU

Angewandte harmonisierte Normen und techn. Spezifikationen:

The above-named product is in compliance with the following harmonized standards and technical specifications:

EN 50581 : 2012

Technische Dokumentation zur Beurteilung von Elektro- und Elektronikgeräten hinsichtlich der Beschränkung gefährlicher Stoffe
Technical documentation for the assessment of electrical and electronic products with respect to the restriction of hazardous substances

EN ISO 12100 : 2010

Sicherheit von Maschinen - Allgemeine Gestaltungsleitsätze - Risikobeurteilung und Risikominderung (ISO 12100:2010)
Safety of machinery - General principles for design - Risk assessment and risk reduction (ISO 12100:2010)

EN 61010-1 : 2010

Sicherheitsbestimmungen für elektrische Mess-, Steuer-, Regel- und Laborgeräte, Teil 1: Allgemeine Anforderungen
Safety requirements for electrical equipment for measurement, control, and laboratory use, Part 1: General requirements

EN 61010-2-010 : 2014

Sicherheitsbestimmungen für elektrische Mess-, Steuer-, Regel- und Laborgeräte, Teil 2-010: Besondere Anforderungen an Laborgeräte für das Erhitzen von Stoffen
Safety requirements for electrical equipment for measurement, control, and laboratory use, Part 2-010: Particular requirements for laboratory equipment for the heating of materials

EN 61326-1 : 2013

Elektrische Mess-, Steuer-, Regel- und Laborgeräte- EMV-Anforderungen- Teil 1: Allgemeine Anforderungen
Electrical equipment for measurement, control, and laboratory use - EMC requirements - Part 1: General requirements

EN 378-1 : 2016

Kälteanlagen und Wärmepumpen – Sicherheitstechnische und umweltrelevante Anforderungen – Teil 1: Grundlegende Anforderungen, Begriffe, Klassifikationen und Auswahlkriterien
Refrigerating systems and heat pumps - Safety and environmental requirements - Part 1: Basics requirements, definitions, classification and selection criteria

EN 378-2 : 2016

Kälteanlagen und Wärmepumpen – Sicherheitstechnische und umweltrelevante Anforderungen – Teil 2: Konstruktion, Herstellung, Prüfung, Kennzeichnung und Dokumentation
Refrigerating systems and heat pumps - Safety and environmental requirements - Part 2: Design, construction, testing, marking and documentation

EN 378-3 : 2016

Kälteanlagen und Wärmepumpen – Sicherheitstechnische und umweltrelevante Anforderungen – Teil 3: Aufstellungsort und Schutz von Personen
Refrigerating systems and heat pumps - Safety and environmental requirements - Part 3: Installation site and personal protection

EN 378-4 : 2016

Kälteanlagen und Wärmepumpen – Sicherheitstechnische und umweltrelevante Anforderungen – Teil 4: Betrieb, Instandhaltung, Instandsetzung und Rückgewinnung
Refrigerating systems and heat pumps - Safety and environmental requirements - Part 4: Operation, maintenance, repair and recovery

Bevollmächtigter für die Zusammenstellung der techn. Unterlagen:

Authorized representative in charge of administering technical documentation:

Hr. Torsten Kauschke, im Hause / on the manufacturer's premises as defined above

Die Konformitätserklärung wurde ausgestellt

The declaration of conformity was issued and valid of

Seelbach, 20.10.2017

M. Juchheim, Geschäftsführer / Managing Director

2.3. Warranty conditions

JULABO GmbH warrants its products against defects in material or in workmanship, when used under appropriate conditions and in accordance with appropriate operating instructions

for a period of ONE YEAR.

Extension of the warranty period – free of charge



With the '1PLUS warranty' the user receives a free of charge extension to the warranty of up to 24 months, limited to a maximum of 10 000 working hours.

To apply for this extended warranty the user must register the unit on the JULABO web site www.julabo.com, indicating the serial no. The extended warranty will apply from the date of JULABO GmbH's original invoice.

JULABO GmbH reserves the right to decide the validity of any warranty claim. In case of faults arising either due to faulty materials or workmanship, parts will be repaired or replaced free of charge, or a new replacement unit will be supplied.

Any other compensation claims are excluded from this guarantee.

2.4. Technical specifications

Professional Series		SC 2500a	SC 2500w
Working temperature ranges:			
Standard unit	°C	+5 ... +35	+5 ... +35
Option Low Temp	°C	-20 ... +35	-20 ... +35
Option Low /HighTemp I	°C	-20 ... +80	-20 ... +80
Temperature stability	°C	0.1	0.1
Absolute Temperature Calibration	INT/EXT	±3 / ±9	±3 / ±9
Heater wattage (at 230 V) Option H1	kW	1.0	1.0
Cooling capacity	°C	<u>+20</u> 0 -10	<u>+20</u> 0 -10
Medium ethanol	kW	2.5 1.5 0.9	2.5 1.5 0.9
Refrigerant		R452A	R452A
Pump capacity P3 see table 1 page 12			
Flow rate P3	l/min at 0 bar	33	33
Pressure max. P3	bar at 0 liters	3.5	3.5
Overall dimensions (WxDxH)	cm	49x62/105	49x62/105
Filling volume	liters	21 ... 33	21 ... 33
Weight	kg	123	123
Ambient temperature	°C	5 ... 40	5 ... 40
Mains power connection	V/ Hz	230 / 50	230 / 50
Current consumption without heater	A	11 (at 230 V)	11 (at 230 V)
Current consumption 1 kW heater	A	15 (at 230 V)	15 (at 230 V)
Mains power connection	V/ Hz	208-230 / 60	208-230 / 60
Current consumption without heater	A	11 (at 230 V)	11 (at 230 V)
Current consumption 1 kW heater	A	15 (at 230 V)	15 (at 230 V)

All measurements have been carried out at: rated voltage and frequency
 ambient temperature: 20 °C Technical changes without prior notification reserved.

* Pump P3- reduces cooling capacity by 0.3 kW

Professional series	
Temperature selection	digital
via keypad	indication on VFD COMFORT-DISPLAY
remote control via personal computer	indication on monitor
Temperature indication	°C VFD COMFORT-DISPLAY
Resolution	°C 0.1
Temperature control	ICC - Intelligent Cascade Control

Electrical connections:

Computer interface RS232

External Pt100 sensor

Optional	
Programmer input	-100 °C to 400 °C = 0 - 10 V or 0 - 20 mA or 4 - 20 mA
Input for the signal of a flow meter or external manipulated variable	
Temperature recorder outputs	0 - 10 V (0 V = -100 °C, 10 V = 400 °C) 0 - 20 mA (0 mA = -100 °C, 20 mA = 400 °C) 4 - 20 mA (4 mA = -100 °C, 20 mA = 400 °C)
Standby input	for external emergency switch-off
Alarm output	for external alarm signal

Table 1

Pump capacity Bath fluid: Water, Silicone -oil	XX . XX <i>PUMP</i> 1	XX . XX <i>PUMP</i> 2	
Circulating pump:	P3	P3	
Flow rate max. Lpm at 0 bar	30	33	
Pressure max. bar at 0 liter	1.8	3.5	
Bath fluid: Galden® eg. Fluorinert® 3283			
Pressure max. bar at 0 liter	3.5		



Notice:

If Galden® or Fluorinert® is used the the charge of the motor increases. Wrong adjustment causes overheating and eventually destruction of the motor.

- With the circulation pump P3 a maximum pump pressure stage >PUMP 1< may be adjusted..

The pump type can be recognized in the order no. on the name plate.

95 xx xxx _ xx **PX** xx

Safety installations according to IEC 61010-2-010:

Excess temperature protection	adjustable from 0 °C ... 220 °C
Low liquid level protection	float switch
Classification according to DIN 12876-1	class III

Supplementary safety installations

Early warning system for low level	float switch
High temperature warning function	optical + audible (in intervals)
Low temperature warning function	optical + audible (in intervals)
Supervision of working sensor	plausibility control
Reciprocal sensor monitoring between working and safety sensors	difference >35 °C
Alarm message	optical + audible (permanent)
Warning message	optical + audible (in intervals)

Environmental conditions according to IEC 61 010-1:

Use indoors only.

Altitude up to 2000 m - normal zero.

Ambient temperature: see Technical specifications

Humidity:

Max. relative humidity 80% for temperatures up to +31 °C,

linear decrease down to 50% relative humidity at a temperature of +40 °C

Max. mains voltage fluctuations of ±10% are permissible.

Protection class according to IEC 60 529	IP21
The unit corresponds to Class I	
Overvoltage category	II
Pollution degree	2



Caution:

The unit is not for use in explosive environment.

EMC requirements

The device is an ISM device of group 1 per CISPR 11 (uses HF for internal purposes) and is classified in class A (industrial and commercial sector).

Notice:

- Devices of class A are intended for the use in an industrial electromagnetic environment.
- When operating in other electromagnetic environments, their electromagnetic compatibility may be impacted.

Information about the used refrigerants

The **Regulation (EU) No. 517/2014 on fluorinated greenhouse gases** applies to all systems which contain fluorinated refrigerants and replaces (EC) 842/2006.

The aim of the Regulation is to protect the environment by reducing emissions of fluorinated greenhouse gases.

Among other things it regulates the emission limits, use and recovery of these substances. It also contains requirements for operators of systems which require / contain these substances to function.

Under Regulation 517/2014, the operator of a system of this nature has the following duties:

- The operator must ensure that the equipment is checked at regular intervals for leaks.
- These intervals depend on the CO₂ equivalent of the system. This is calculated from the refrigerant fill volume and type of refrigerant. The CO₂ equivalent of your system is shown on the model plate.
- The operator undertakes to have maintenance, repair, service, recovery and recycling work carried out by certified personnel who have been authorized by JULABO.
- All such work must be documented. The operator must keep records and archive them for at least five years. The records must be submitted to the relevant authority on request.

Refer to the text of the Regulation for further information.

2.5. Cooling water connection

Cooling water pressure (IN/OUT)	max.	6 bar
Pressure difference (IN - OUT)		3.5 to 6 bar
Cooling water consumption (IN with 15 °C)		5 l/min
Cooling water temperature		< 20 °C



Notice: Cooling water circuit

Risk of oil leaking from the refrigeration system (compressor) of the recirculating cooler into the cooling water in case of a fault in the cooling water circuit!

Observe the laws and regulations of the water distribution company valid in the location where the unit is operated.



Notice:

Danger of corrosion of heat exchanger due to unsuitable quality of cooling water.

- Due to its high content of lime, hard water is not suitable for cooling and causes scale in the heat exchanger.
- Ferrous water or water containing ferrous particles will cause formation of rust even in heat exchangers made of stainless steel.
- Chlorinated water will cause pitting corrosion in heat exchangers made of stainless steel.
- Due to their corrosive characteristics, distilled water and deionized water are unsuitable and will cause corrosion of the bath.
- Due to its corrosive characteristics, sea water is not suitable.
- Due to its microbiological (bacterial) components, which settle in the heat exchanger, untreated and unpurified river water and water from cooling towers is unsuitable.
- Avoid particulate matter in cooling water.
- Avoid putrid water.

Recommended quality of cooling water:

pH	7.5 to 9.0
Sulfate [SO ₄ 2-]	< 100 ppm
Hydrocarbonate [HCO 3-]/sulfate [SO ₄ 2-]	> 1 ppm
Hardness [Ca 2+, Mg 2+]/[HCO 3-]	> 0.5 °dH
Alkalinity	60 ppm < [HCO 3-] < 300 ppm
Conductivity	< 500 µS/cm
Chloride (Cl -)	< 50 ppm
Phosphate (PO ₄ 3-)	< 2 ppm
Ammonia (NH ₃)	< 0.5 ppm
Free chlorine	< 0.5 ppm
Trivalent iron ions (Fe 3+)	< 0.5 ppm
Manganese ions (Mn 2+)	< 0.05 ppm
Carbon dioxide (CO ₂)	< 10 ppm
Hydrogen sulfide (H ₂ S)	< 50 ppm
Content of oxygen	< 0.1 ppm
Algae growth	impermissible
Suspended solids	impermissible

Operating instructions

3. Operating controls and functional elements

Front view

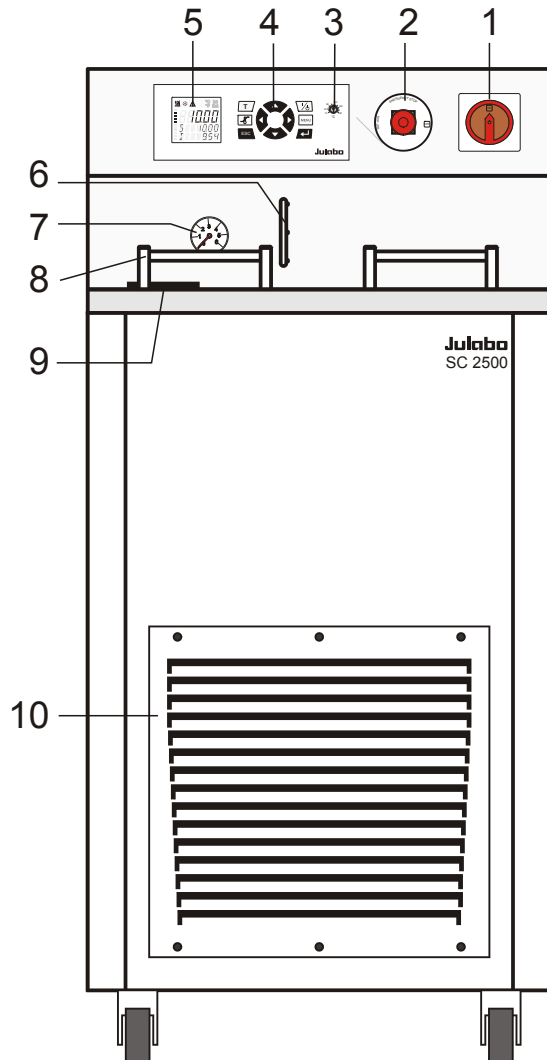

Rear view

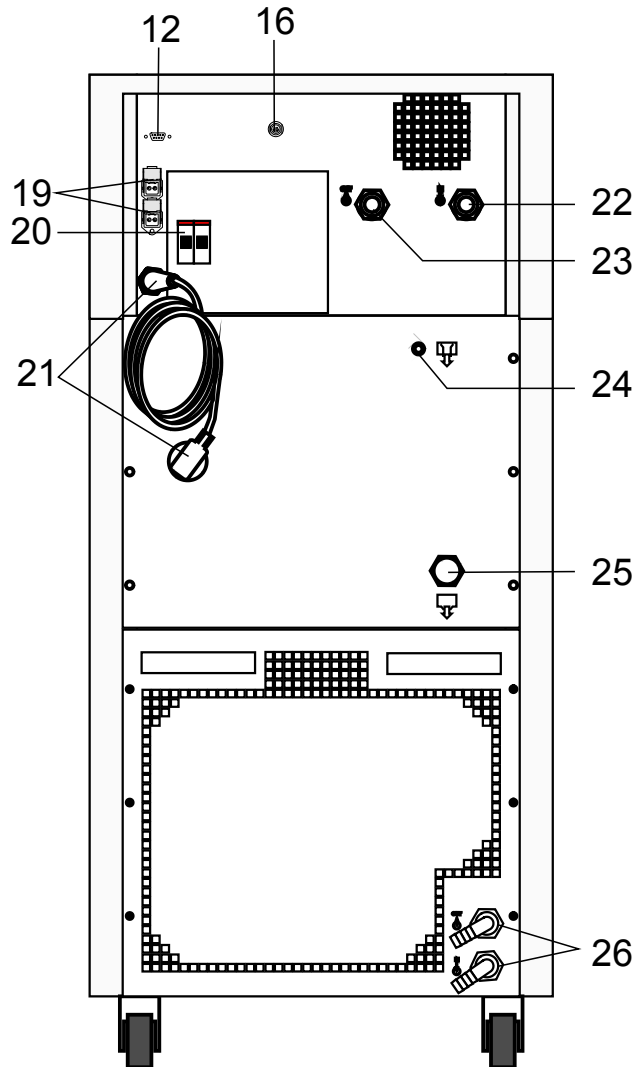

1	Mains power switch	
2	Emergency stop switch	
3		Adjustable excess temperature protection according to IEC 61010-2-010
4	Keypad	
		Start / stop key
		Key for selecting the working temperature - Setpoint 1, 2, 3
		Key for selecting the warning and safety values
		MENU button - for selecting the menu functions
		Cursor keys (left or right)
		Edit keys (increase or decrease)



Enter key
 1) Store value / parameter
 2) Next lower menu level



Escape key
 1. Cancel entries
 2. Return to a higher menu level

5

VFD COMFORT-DISPLAY

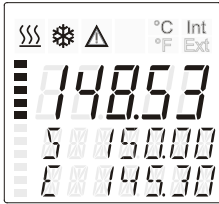

Header: Control indicators see sections 2.1 and 2.2
 Line 1: Actual value internal or external
 The display is depending on the selected control mode in the menu > Control < (internal or external).
 Line 2: Working temp. setpoint, constantly S xxx.xx
 Line 3: Actual value (E = external or I = internal)
 Alternating with the display in line 1

Use the keys ▼▲ to indicate further values in line 3. However, the functions of these keys are different with the programmer started.

PI Capacity in % - with manipulated variable set to >control<*

or
 PS Capacity in % - with manipulated variable set to >SERIAL<* or >EPROG<*

F Flow rate in liters/minute
 (providing EPROG input set to >FLOWRATE<)
 *see 9.3.5. ACTVAR - page 44

FL Status indication for flow >GOOD< = Pump switched on

R Resistivity measurement and actual value display in the range from 0.5 ... 5 MOhm/cm

Press **ESC** to return to actual value (E = external or I = internal)

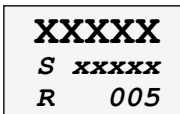
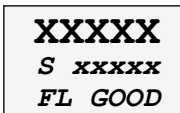

5.1



Control indicators in the header:

Heating / Cooling / Alarm /

Remote control

5.2



Control indicators in the header:

Temperature indication **I**nternal or **E**xternal actual value

Temperature indication in °C (°F not possible on this unit)

5.3

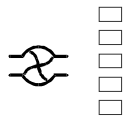

Display for the adjusted pump pressure stage.

Adjustable via the **MENU** button, in the menu >PUMP<.

6

Filling level indication

7



Manometer (feed pressure)

8

Handle

9

Filling opening

10

Venting grid, removable 
 (only air cooled recirculating cooler)

Operating controls and functional elements

Rear view

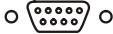
12  Interface RS232: remote control via personal computer
RS232

Option: Electronic module

13  Alarm output (for external alarm signal)
ALARM

14  Standby input (for external emergency switch-off)
STAND-BY

15  Programmer input and temperature recorder output
REG+E-PROG

16  Socket for external measurement and control sensor
or external setpoint programming
ext Pt100

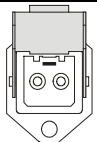
19  2 Connectors for solenoid valve. 230 V / max. 0.1 A
No control voltage in the **-OFF-** condition

20  2 Safety cutouts: Mains fuses 16 A



Motor protection circuit breaker for compressor motor

21 Mains power cable with plug

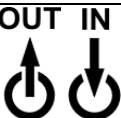
22  Pump connectors: 3/4" NPT male
23 OUT / Feed IN / Return

24  Overflow connector, M10x1 female
Order-No. 8 970 460 Barbed fitting for tubing 8 mm inner dia.

 Closable when using e.g. 3M Fluorinert[®] as temperature liquid.

25  Discharge nozzle with cap nut, Connection: 1/2" male
Recommendation:
Before filling please install a drain cock at the discharge nozzle.
(not included in delivery)

Order-No. 8 920 100 Drain cock, stainless steel

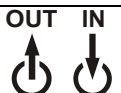
26  Only for water cooled models: Cooling water OUTLET and INLET

4. Safety notes for the user

4.1. Explanation of safety notes



In addition to the safety warnings listed above, warnings are posted throughout the manual. These warnings are designated by an exclamation mark inside an equilateral triangle. "Warning of a dangerous situation (Attention! Please follow the documentation)."

The danger is classified using a signal word.
Read and follow these important instructions.



Warning:

Describes a possibly highly dangerous situation. If these instructions are not followed, serious injury and danger to life could result.



Caution:

Describes a possibly dangerous situation. If this is not avoided, slight or minor injuries could result. A warning of possible property damage may also be contained in the text.



Notice:

Describes a possibly harmful situation. If this is not avoided, the product or anything in its surroundings can be damaged.

4.2. Explanation of other notes



Note!

Draws attention to something special.



Important!

Indicates usage tips and other useful information.

4.3. Safety instructions

Follow the safety instructions to avoid personal injury and property damage. Also, the valid safety instructions for workplaces must be followed.



- Only connect the unit to a power socket with an earthing contact (PE – protective earth)!
- The power supply plug serves as a safe disconnecting device from the line and must always be easily accessible.
- Place the unit on an even surface on a base made of nonflammable material.
- Do not stay in the area below the unit.
- Make sure you read and understand all instructions and safety precautions listed in this manual before installing or operating your unit.
- Set the excess temperature safety installation at least below the flash point of the bath fluid.
- Never operate the unit without bath fluid in the bath.
- Pay attention to the thermal expansion of bath oil during heating to avoid overflowing of the fluid.
- Prevent water from entering the hot bath oil.

- Do not drain the bath fluid while it is hot!
Check the temperature of the bath fluid prior to draining (e.g., by switching the unit on for a short moment).
- Use suitable connecting tubing.
- Avoid sharp bends in the tubing, and maintain a sufficient distance from surrounding walls.
- Make sure that the tubing is securely attached.
- Regularly check the tubing for material defects (e.g., for cracks).
- Never operate damaged or leaking units.
- Always turn off the unit and disconnect the mains cable from the power source before performing any service or maintenance procedures, or before moving the unit.
- Always turn off the unit and disconnect the mains cable from the power source before cleaning the unit.
- Always empty the bath before moving the unit.
- Transport the unit with care.
- Sudden jolts or drops may cause damage in the interior of the unit.
- Observe all warning labels.
- Never remove warning labels.
- Never operate units with damaged mains power cables.
- Repairs are to be carried out only by qualified service personnel.



- Some parts of the bath tank and the pump connections may become extremely hot during continuous operation. Therefore, exercise particular caution when touching these parts.



Caution:

The unit may be used, for example, to control the temperature of fluids in a reactor.

We do not know what substances are contained in these vessels.

Many substances are:

- inflammable, easily ignited, or explosive
- hazardous to health
- environmentally hazardous

i.e.: **dangerous**

The user alone is responsible for the handling of these substances!

The following questions should help to recognize possible dangers and to reduce the risks to a minimum.

- Are all tubes and electrical cables connected and layed?
Note:
sharp edges, hot surfaces in operation, moving machine parts, etc.
- Do dangerous vapors or gases develop during heating?
Must the work be done in a fume hood?
- What to do when a dangerous substance was spilled on or in the unit?
Before starting to work, obtain information concerning the substance and determine the method of decontamination.

**Notice:**

Check the safety installations at least twice a year!

- Excess temperature protection according to IEC 61010-2-010
With a screwdriver, turn back the adjustable excess temperature protection until the shutdown point (actual temperature).
- Low level protection according to IEC 61010-2-010
To check the function of the float, it can be manually lowered with a screwdriver, for example.

5. Preparations

5.1. Installation

- Place the unit in an upright position.
For better stability, apply the holding brakes on the front casters.
- The place of installation should be large enough and provide sufficient air ventilation to ensure the room does not warm up excessively because of the heat the instrument rejects to the environment. (Max. permissible ambient temperature: 35 °C).
For a fault (leakage) in the refrigeration system, the standard EN 378 prescribes a certain room space to be available for each kg of refrigerant.
The refrigerant quantity is specified on the type plate.
> For 0.423 kg of refrigerant R452A, 1 m³ of space is required.
- Keep at least 20 cm of open space on the front and rear venting grids.
- Do not set up the unit in the immediate vicinity of heat sources and do not expose to sun light
- Before operating the unit after transport, **wait about one hour after installation**. This will allow any oil that has accumulated laterally during transport to flow back down, thus ensuring that the compressor can develop its maximum capacity.

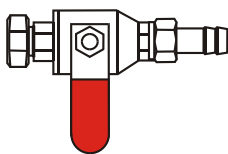
**Recommendation:**

Before filling please install a drain cock at the discharge nozzle. (25)
Connection: ½ " male (not included in delivery)

Order-No. 8 920 100 Drain cock, stainless steel

Cooling water connection (26)**Only for water cooled models:**

Ensure circulation of cooling water by connecting the tubing to cooling water inlet and outlet on the rear of the recirculating cooler.

Cooling water connectors G3/4" male

Cooling water temperature <20 °C

Cooling water see page 15

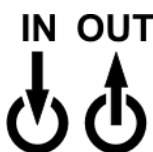

5.2. Connecting the external system

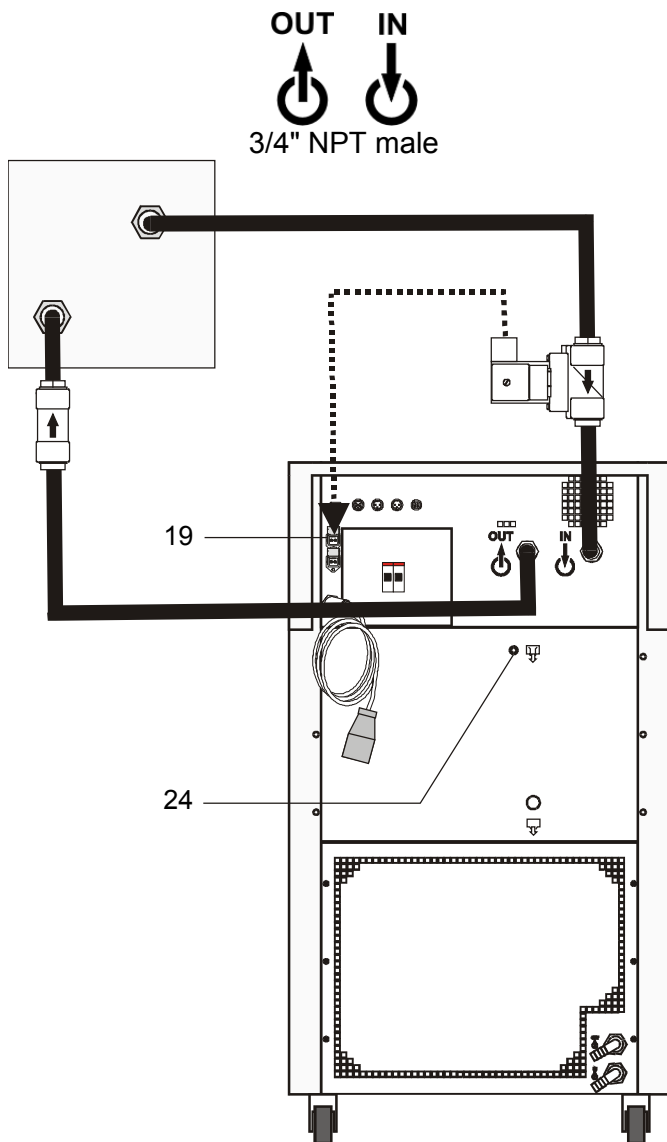

- Connect the tubing for cooling the external system to the pump connectors (22, 23) for feed and return on the rear of the recirculating cooler.
- In case the system to be cooled is located at a higher level than the recirculating cooler, take note of bath liquid flowing back when the unit is switched off. Should the filling volume of the bath tank not be sufficient, prevent the liquid from flowing back by using shut-off valves.



Flood hazard!

For this reason, solenoid valves for loop circuit or shut-off valves can be integrated in the loop circuit.

- ① Connect the valve to the connector (19).

Order No.	Description
8980705	Solenoid valve set 230V/50-60Hz

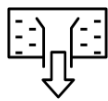

- Unscrew the collar nut from the overflow connector (24). Connect a piece of tubing to the overflow connector and drain into a suitable vessel.
Order-No. 8 970 460 Barbed fitting for tubing 8 mm inner dia.

- If easily volatile temperature liquids are used, as e.g. 3M Fluorinert[®], the overflow should remain closed.

Attention Flood hazard!

Then the level indication (6) should get more attention.



Caution:

Securely attach all tubing to prevent slipping.

5.2.1. Tubing

Recommended tubing:

	Maximum pressure
Textile-reinforced tubing	> 4.5 bar



Warning: Tubing:

At high working temperatures, the tubing used for temperature control and for the cooling water supply represents a danger source.

A damaged tubing line may allow a large amount of hot bath fluid to be pumped out within a short time.

This may result in:

- Burning of skin
- Breathing difficulties due to hot atmosphere

Safety instructions

- Use suitable connecting tubing.
- Make sure that the tubing is securely attached.
- Avoid sharp bends in the tubing and maintain a sufficient distance from surrounding walls.
- Regularly check the tubing for material defects (e.g., for cracks), at least once a year.
- Preventive maintenance: replace the tubing from time to time.

5.2.2. Bath fluids



Caution:

Carefully read the material safety data sheet of the bath fluid used, particularly with regard to the fire point!

If a bath fluid with a fire point of ≤ 65 °C is used, only supervised operation is possible.

Water:

The quality of water depends on local conditions.

- Due to the high concentration of lime, hard water is not suitable for temperature control because it leads to scale in the bath
- Ferrous water can cause corrosion, even on stainless steel.
- Chlorinated water can cause pitting corrosion.
- Distilled water and deionized water are unsuitable. Their special properties cause corrosion in the bath, even on stainless steel.

Recommended bath fluids:

Bath fluid	Temperature range
soft/decalcified water	5 °C to 80 °C



See website for list of recommended bath fluids.
Contact: see page 6



Caution:

Fire or other dangers when using bath fluids that are not recommended:

Please contact JULABO before using other than recommended bath liquids. JULABO assumes no liability for damage caused by the selection of an unsuitable bath fluid.

Unsuitable bath fluids are fluids which, e.g.,

- are highly viscous (much higher than $30 \text{ mm}^2 \times \text{s}^{-1}$ at the respective working temperature)
- have a low viscosity and have creep characteristics
- have corrosive characteristics or
- tend to crack.

No liability for use of other bath fluids!

ATTENTION: The maximum permissible viscosity is $30 \text{ mm}^2/\text{s}$

5.3. Filling



Notice:

- Pay attention to the thermal expansion of bath oil during heating to avoid overflowing of the liquid.

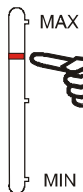

Liquid level

- Connect the tubing from the external system to the pump connectors and check for leaks.
- Check to make sure that the drain port (25) is closed.
- Remove the cap from the filling opening (9).
- Fill the bath tank using a funnel while monitoring the filling level (6).

Filling of the external system.

- Turn the mains switch (1) on
- Press the key  for filling the cooling loop for the external system. Make sure that air can evacuate from the system..
- Check the filling level (6) and keep on filling the bath liquid using the funnel.
- After having finished the filling process, the liquid level should be below "MAX".
- Close the filling opening.

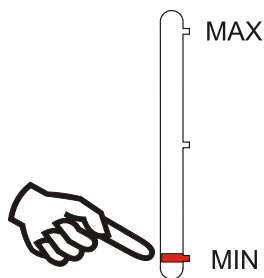

5.4. Draining

**Notice:**

- Do not drain the bath fluid while it is hot or cold! Check the temperature of the bath fluid prior to draining (by switching the unit on for a short moment, for example).
- Store and dispose of the used bath fluid according to the environmental protection laws.

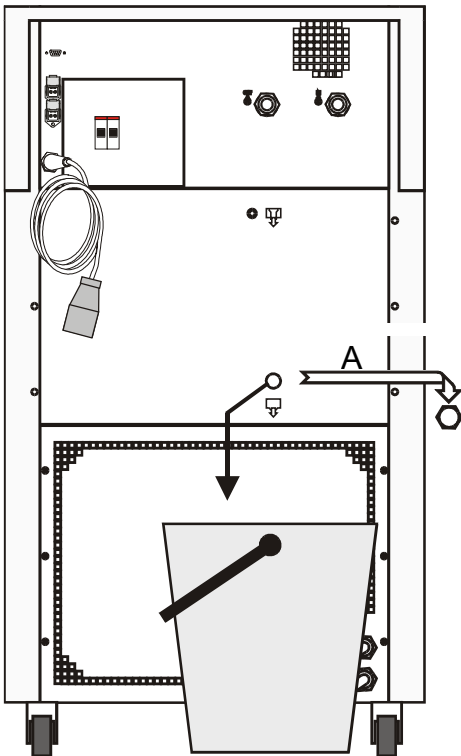

- Turn the mains switch (1) off.
- Place a suitable vessel for accepting the used bath liquid underneath the drain.
- Unscrew the cup nut (A) from the drain port (25) and empty the unit completely.
- Close the drain port.

6. Operating procedures

6.1. Power connection



Caution:

- Only connect the unit to a power socket with an earthing contact (PE – protective earth)!
- The power supply plug serves as a safe disconnecting device from the line and must always be easily accessible.
- Never operate the unit with a damaged mains power cable.
- Regularly check the mains power cables for damage.
- We disclaim all liability for damage caused by incorrect line voltages!

Make sure that the line voltage and frequency match the supply voltage specified on the type plate.

Deviations of $\pm 10\%$ are permissible.

6.2. Switching on / Start - Stop

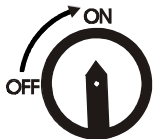

Switching on:

- Turn on the mains power switch (1).

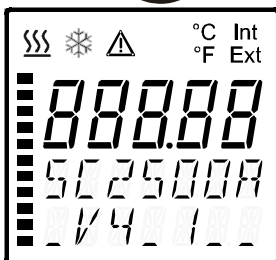

- ① During the self-test all segments of the VFD-Info-Display light up. Then the software version number (example: V 4x.1x) and the order number of the recirculating cooler appears. (Example: [95 20 025 03 P3H1]).

The display „OFF“ or „R OFF“ indicates the unit is ready to operate.

XXXXX
95xxxxx
-xxPxHx

- ① The recirculating cooler enters the operating mode activated before switching the recirculating cooler off:
keypad control mode (manual operation)
or
remote control mode (operation via personal computer).

R

-OFF-	-OFF-
S 150.0	S xxx.x
I 24.6	I xx.x

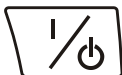

Start: Press the start/stop key .

The actual bath temperature is displayed on the VFD COMFORT-DISPLAY.

24.6
S 150.0
E -----

Stop: Press the start/stop key .

The VFD COMFORT-DISPLAY indicates the message „OFF“.

Autostart: see chapter 9.3.2. A-START – Autostart

The Autostart function enables the start of the recirculating cooler directly by pressing the mains switch or using a timer.

7. Setting the temperatures



Factory settings:

SETP 1 25 °C
SETP 2 37 °C
SETP 3 70 °C

Press the  key to call up the menu for temperature selection.

3 different working temperatures are adjustable. Their values are freely selectable within the operating temperature range.



i This setting may be carried out with the recirculating cooler being in the Start or Stop condition!



Example: Setting working temperature "SETPoint 3"

```
XXXXXX
SETP 3
70.0
```

1. Press the  key until the desired menu window is indicated on the VFD COMFORT-DISPLAY
Example: SETP 3 / 70.0 °C (last digit blinks)

2. **Change the value to 85 °C.**

Use the cursor keys   to move left or right on the display until the numeral you wish to change blinks.

Use the increase/decrease arrows   to change the selected numeral (-, 0, 1, 2, 3, ... 9).
see example left: SETP 3 / 85.0.

```
XXXXXX
SETP 3
85.0
```

3. Press enter  to store the value.

i In the >Start< condition this value is immediately used for controlling the working temperature.
The indication on the VFD COMFORT-DISPLAY is updated.
The heater control indicator blinks.

```
SSS
70.7
S 85.0
E ----
```

Notice: See SETMAX and SETMIN in chapter 9.5. MENU LIMITS



Example: Selecting the working temperature



SETP 1
SETP 2
SETP 3

1. Press the  key until the desired menu item is indicated on the VFD COMFORT-DISPLAY.

2. Press enter .

i The recirculating cooler uses the new working temperature value for temperature control.

8. Safety installations, warning functions



Check the safety installation at least twice a year! See page 21

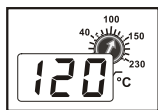

Settings for the excess temperature protection > SAFETMP< according to IEC 61010-2-010 and for the high > OVERTMP< and low > SUBTMP< temperature warning functions are made in a menu that is called up with the key .

- SAFETMP
- OVERTMP
- SUBTMP
- LIMITSR

Menu item > LIMITSR <: „Warning“ or „Alarm“

For the two menu items > OVERTMP< and >SUBTMP< choose between a warning message being signalled or a complete shutdown of the main functional elements such as heater and circulating pump being effected.

8.1. Excess temperature protection



This safety installation is independent of the control circuit. When the temperature of the bath fluid has reached the safety temperature, a complete shutdown of the heater and pump is effected.





The alarm is indicated by optical and audible signals (continuous tone) and on the VFD COMFORT-DISPLAY appears the error message "ALARM-CODE 1".

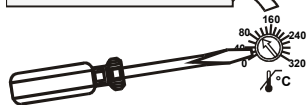

Setting range: 20 °C ... 220 °C



1. Press the  button until the menu item > SAFETMP < is displayed.
2. Set the new cut-out value using a screwdriver via the VFD COMFORT-DISPLAY (Example: 100 °C)
3. Press **ESC** to update the display immediately, or the unit automatically returns to the effective display after about 30 seconds .

Recommendation:

Set the excess temperature protection at 5 to 10 °C above the working temperature setpoint.



Warning:



The excess temperature protection >SafeTemp< should be set at least below the flash point of the bath fluid used.

There is a risk of fire in the event of a wrong setting!

We disclaim all liability for damage caused by wrong settings!

8.1.1. Early warning system, low level protection

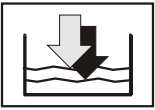

(patented)

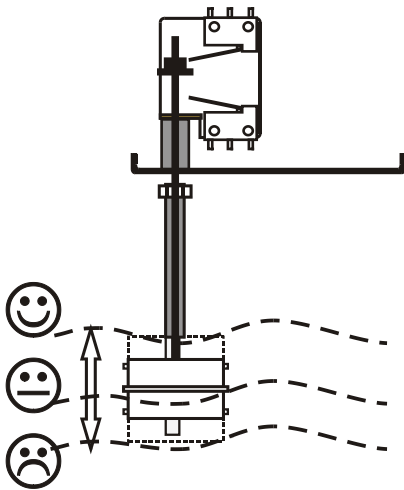

This low level protection is independent of the control circuit and is divided in two sections.

1. Switch in stage 1 recognizes a critical fluid level 😊.
An audible warning (interval tone) sounds and a message appears on the VFD COMFORT-DISPLAY.

XXXXXX
WARNING
CODE 40

Refill bath fluid!

2. Switch in stage 2 recognizes a low fluid level 😞.
If stage 2 of the low level protection device (according to IEC 61010-2-010) is triggered, a complete shutdown of the heater and circulating pump is effected.
A continuous alarm tone sounds and a message >ALARM< >CODE 01< appears on the VFD COMFORT-DISPLAY.

XXXXXX
ALARM
CODE 1

Turn off the unit with the mains switch, refill bath fluid and turn the unit on again!

Important: Check the safety installations from time to time.
See page 21



Warning:

When adding bath fluid, always use the same bath fluid type that is already in the bath.
Bath oils must not contain any water and should be pre-heated approximately to the current bath temperature! Explosion hazard at high temperatures!

8.2. Over and Sub temperature warning functions

Over temperature

```

XXX . X
OVERTMP
  200.0
    
```

Sub temperature

```



XXXXXX
SUBTMP
  -94.9
    
```

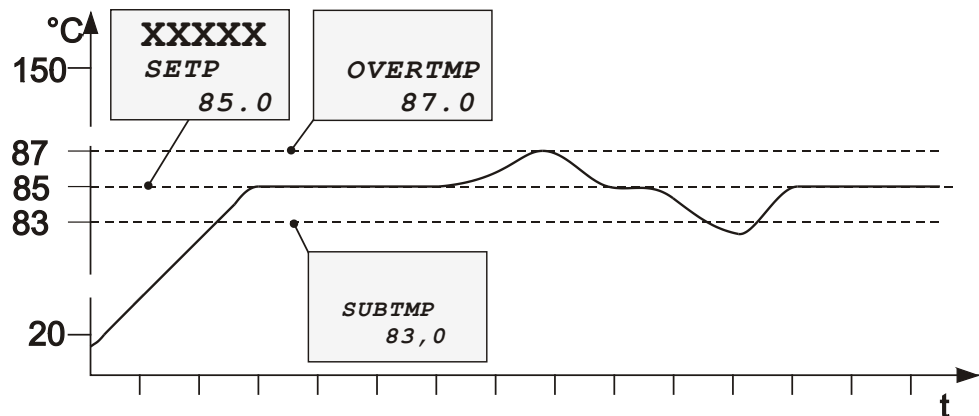

If for a sensitive temperature application task adherence to a working temperature value $> \text{SETP} <$ is to be supervised, then set over and sub temperature warning values.

In the example below, the $> \text{SETP} <$ of $85\text{ }^{\circ}\text{C}$ is surrounded by the values $> \text{OVERTMP} <$ $87\text{ }^{\circ}\text{C}$ and $> \text{SUBTMP} <$ $83\text{ }^{\circ}\text{C}$. The electronics immediately registers when the actual temperature attains a temperature out of the limits and it follows a reaction according to what is set in the menu item $> \text{LIMITSR} <$.

(see chapter 8.2.1. Change-over of the warning function to shutdown function)



1. Press the  button until the menu item $> \text{OVERTMP} <$ or $> \text{SUBTMP} <$ is displayed.
2. Set value:
 Use the cursor keys   to move left or right on the display until the numeral you wish to change blinks.

 Use the increase/decrease arrows   to change the selected numeral (-, 0, 1, 2, 3, ... 9).
3. Press enter  to store the value.

i The warning functions are only triggered when the actual bath temperature, after start from the „OFF“ or „rOFF“ mode, lies within the set limits for 3 seconds.

Recommendation:

Set the high temperature warning value $> \text{OVERTMP} <$ at $5\text{ }^{\circ}\text{C}$ to $10\text{ }^{\circ}\text{C}$ above the working temperature setpoint.

Set the low temperature warning value $> \text{SUBTMP} <$ at $5\text{ }^{\circ}\text{C}$ to $10\text{ }^{\circ}\text{C}$ below the working temperature setpoint.

8.2.1. Change-over of the warning function to shutdown function

For the two menu items > OVERTMP< and >SUBTMP< choose between a warning message being signalled or a complete shutdown of the main functional elements such as heater and circulating pump being effected (see page 30).

XXX.X
LIMITSR
WARNING

XXX.X
LIMITSR
ALARM

Factory setting:
>WARNING<

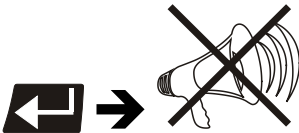

- Setting >WARNING<
An audible warning (**interval tone**) sounds and a message appears on the VFD COMFORT-DISPLAY.

XXXXXX
WARNING
CODE 03

or

XXXXXX
WARNING
CODE 04

OVERTMP

SUBTMP

- Setting >ALARM<
A complete shutdown of heater and circulating pump is effected. An audible alarm (**continuous tone**) sounds and a message appears on the VFD COMFORT-DISPLAY.



XXXXXX
ALARM
CODE 03

oer

XXXXXX
ALARM
CODE 04

OVERTMP









SUBTMP

1. Press the  button until the menu item >LIMITSR< is displayed.
2. Select the parameter with the keys ▼ ▲.
(>WARNING< or >ALARM<)
3. Press enter  to store the selected parameter.

9. Menu functions



The term „menu functions“ refers to adjustments such as

➤ PUMP		Electronically adjustable pump capacity	page 33
➤ CONTROL		Intelligent Cascade Control, control parameters CONTROL - internal or external control ELFTUNING DYNAMIC - internal COSPEED - external Control parameters - XP, TN, TV internal Control parameters - XP, TN, TV, XPU external	page 34
➤ CONFIG		Configurationen of the unit SET (Setpoint) – keypad control or remote control A-START – Autostart OFF MODE – Motor on / off RESET – Factory settings ACTVAR – actuating variable TIME / DATE – Setting time and date	page 40
➤ SERIAL		Adjustable interface parameters BAUDRAT, H-SHAKE, PARITY (Baud rate, Handshake, Parity)	page 46
➤ LIMITS		Limits to temperature or capacity SET MAX / MIN - Maximum and minimum setpoint HEAT MAX - Adjusted maximum heating COOL MAX - Adjusted maximum cooling INTERN MAX / MIN – Limitation of the working temperature range BAND HIGH / LOW – Band limit	page 47
➤ PROGRAM		Integrated programmer	page 49
➤ ADJUST		ATC - Absolute Temperature Calibration, Sensor calibration, 3-point calibration	page 53
➤ ANALOG		Analog inputs/outputs F-ALARM – Function at Alarm A-ALARM – Type of Alarm EX-STBY - STAND-BY input CHANNEL – Output 1, 2, 3 EPROG – External programmer input	page 57

Indication only when the Analog Interface Modul is mounted.

Example:
Menu level 1



Continue: Press to quit the menu.

• **Menu level 1:**

Press the button to scroll in menu level 1.
If the desired (>) menu item is indicated on the VFD COMFORT-DISPLAY, press enter to change to menu level 2.

• **Menu level 2:**

Press the button to scroll in the selected menu item, line 3 of the display blinks.
If a value is set or a parameter selected, press enter to confirm.

Each input can be cancelled with the . The cursor then returns to the next higher menu level.

Legend:



The display remains visible for approx. 30 seconds . Start to set a value within this period,
or press the button to scroll in the menu level
or press to return to the next higher menu level.

9.1. MENU PUMP - Setting the pump pressure



Examples:



The pressure of the circulating pump is adjustable in stages. After setting, the VFD COMFORT-DISPLAY indicates the corresponding value.

Adjustable pump capacity stage 1 ... 3

Illuminated display: for pump pressure

Display for the adjusted pump pressure stage.

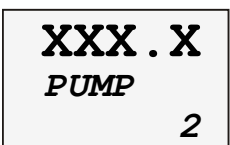

1. Press the button until the menu item > MENU / PUMP < is displayed.

2. Press enter to indicate the parameter.

3. Select the parameter with the keys (1 ... 3).

4. Press enter to store the selected parameter.

Continue: Press or .



Notice:

Pump capacity: See Table 1 page 12

9.2. MENU CONTROL – Control parameters

XXXXX
MENU
CONTROL

MENU

CONTROL: Press enter  to switch to menu level 2

MENU >CONTROL< (INT / EXT)
 MENU >SELFTUN< (ALWAYS / OFF / ONCE)
 MENU >DYNINT< (APER / NORM)
 MENU >XP INT< (0.1 ... 99.9)
 MENU >TN INT< (3 ... 9999)
 MENU >TV INT< (0 ... 999)

or

MENU >CONTROL< (INT / **EXT**)
 MENU >SELFTUN< (ALWAYS / OFF / ONCE)
 MENU >COSPEED< (0 ... 5)
 MENU >XP EXT< (0.1 ... 99.9)
 MENU >TN EXT< (3 ... 9999)
 MENU > TV EXT (0 ... 999)
 MENU >XPU EXT< (0.1 ... 99.9)

9.2.1. CONTROL – internal / external control

XXX . X
CONTROL
INT







Factory setting:
INT

The recirculating cooler is conceived for internal and external temperature control. Switching is carried out in this submenu. Depending on what is set, only the respective set of parameters is indicated.

Possible parameters:

INT internal temperature control
EXT external temperature control with external Pt100 sensor

 The control type can only be adjusted in the -OFF- condition

1. Press the  button until the submenu >CONTROL< is displayed.
 2. Select the parameter with the keys   (INT / EXT).
 3. Press enter  to store the selected parameter.
- Continue: Press  or 



Notice:



Place the external sensor into the bath medium and securely fix the sensor.



Pt100

IMPORTANT:

Additional measures for external temperature control.

-  For external control and temperature measurement an external Pt100 sensor must be connected to the socket (17) on the rear of the recirculating cooler.
-  .Suggested adjustments for external temperature control:
BAND HIGH / LOW and INTERN MAX / MIN
see chapter > LIMITS < on page 47.
-  Sensor calibration of the external Pt100 sensor is carried out in the >MENU / ADJUST<, in the submenu >ATC SEN / EXT< (see page 53).

Accessory: Pt100 external sensor

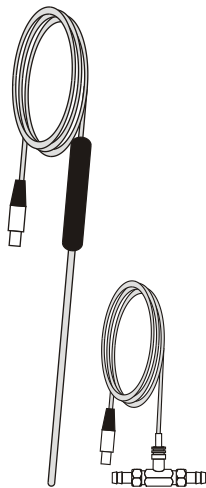

Pt100

M+R

Order No.	Description	Material	Cable
8981003	200x6 mm Ø,	stainless steel	1.5 m
8981005	200x6 mm Ø,	glass	1.5 m
8981006	20x2 mm Ø,	stainless steel	1.5 m
8981010	300x6 mm Ø,	stainless steel	1.5 m
8981015	300x6 mm Ø,	stainless steel / PTFE coated	3 m
8981013	600x6 mm Ø,	stainless steel / PTFE coated	3 m
8981016	900x6 mm Ø,	stainless steel / PTFE coated	3 m
8981014	1200x6 mm Ø,	stainless steel / PTFE coated	3 m
8981103	Extension cable for Pt100 sensor		3.5 m
8981020	M+R in-line Pt100 sensor		

The M+R in-line Pt100 sensor is a flow sensor and can be installed loop circuit

9.2.2. SELFTUNING



Factory setting:
ONCE

Selftuning:

When performing a selftuning for the controlled system (temperature application system), the control parameters X_p , T_n and T_v are automatically determined and stored.

Possible parameters:

OFF - no selftuning

The control parameters ascertained during the last identification are used for control purposes.





ONCE - single selftuning (factory setting)

The instrument performs a single selftuning of the controlled system after each start with the start/stop key  or after receiving a start command via the interface.

ALWAYS - continual selftuning

The instrument performs a selftuning of the controlled system whenever a new setpoint is to be reached.

Use this setting only when the temperature application system changes permanently.

1. Press the  button until the submenu > SELFTUN < is displayed.
2. Select the parameter with the keys  .
3. Press enter  to store the selected parameter.

Continue: Press  or 

9.2.3. DYN INT - Dynamic internal

```
XXXXXX
DYN INT
APER
```

Factory setting: APER (aperiodic)

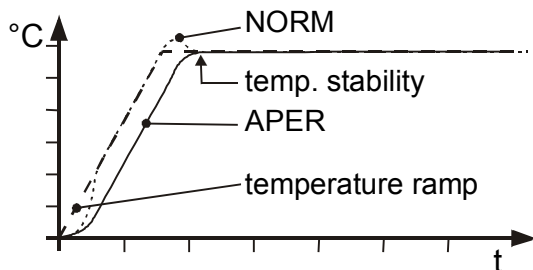
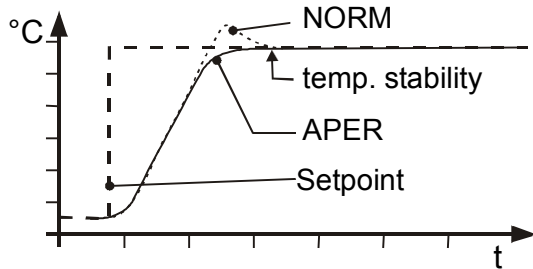

This parameter affects the temperature pattern only in case of **internal** control.

Possible parameters:

NORM Allows for reaching the setpoint faster, but overshooting of up to 5 % is possible.

APER Target temperature is attained without overshooting.

ⓘ With both adjustments an adequate temperature stability is reached after approximately the same time.

1. Press the MENU button until the submenu > DYN INT < is displayed.
2. Select the parameter with the keys ▼ ▲ (NORM / APER)
3. Press enter ↵ to store the selected parameter.
Continue: Press ESC or

9.2.4. Control parameters – XP, TN, TV internal

The control parameters preset in factory are in most cases adequate for achieving an optimum temperature pattern for the samples requiring temperature application.

Each parameter may be manually set via the keypad if necessary, to allow optimum control performance.

```
XXXXXX
XP INT
1.0
```

Setting range: 0.1 ... 99.9

```
XXXXXX
TN INT
100
```

Setting range: 1 ... 9999

Proportional range >Xp<

The proportional range is the range below the selected temperature value in which the control circuit reduces the heating power from 100 % to 0 %.

Resetting time >Tn< (Integral component)

Compensation of the remaining control deviation due to proportional regulation. An insufficient resetting time may cause instabilities to occur. Excessive resetting time will unnecessarily prolong compensation of the control difference.



Setting range: 0 ... 999

Lead time >Tv< (Differential component)

The differential component reduces the control settling time. An insufficient lead time will prolong the time required to compensate for disturbance effects and cause high overshooting during run-up. An excessive lead time could cause instabilities (oscillations) to occur.

1. Press the button until the desired submenu is displayed - XP INT, TN INT, TV INT.

2. Set value:

Use the cursor keys to move left or right on the display until the numeral you wish to change blinks.

Use the increase/decrease arrows to change the selected numeral (-, 0, 1, 2, 3, ... 9).

3. Press enter to store the value.

Continue: Press / or

Optimization instructions for the PID control parameters:

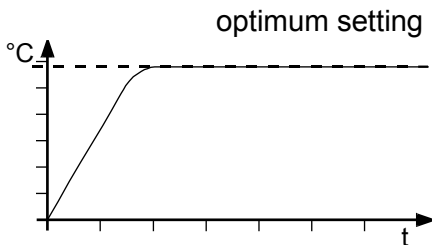

The heat-up curve reveals inappropriate control settings.

Inappropriate settings may produce the following heat-up curves:

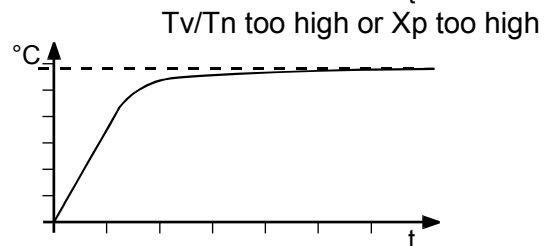
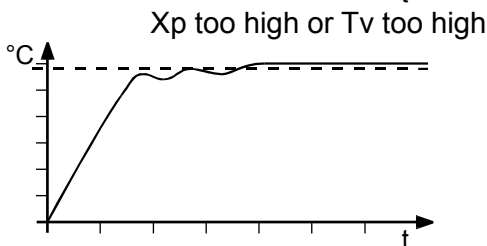
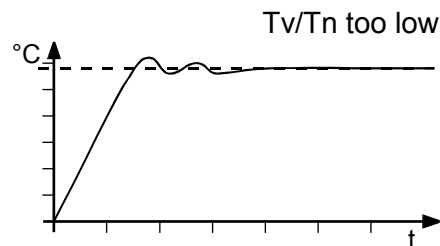
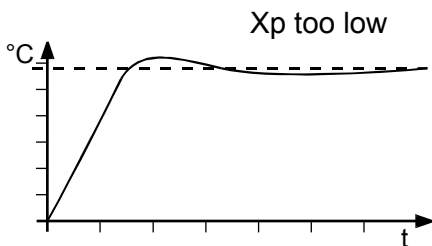

9.2.5. COSPEED - external

```

XXXXXXXX
COSPEED
0.1



```

This parameter affects the temperature pattern only in case of **external** control.

Possible parameters: 0.0 ... 5.0

1. Press the  button until the submenu > COSPEED < is displayed.

2. Set value:

Use the cursor keys   to move left or right on the display until the numeral you wish to change blinks.

Use the increase/decrease arrows   to change the selected numeral (-, 0, 1, 2, 3, ... 9).

3. Press enter  to store the value.

Continue: Press  /  or 

During selftuning, the control parameters X_p , T_n and T_v of a controlled system are automatically determined and stored. Depending on the controlled system, time for tuning can be unequally longer. This controller layout allows protection of sensitive objects requiring temperature application.

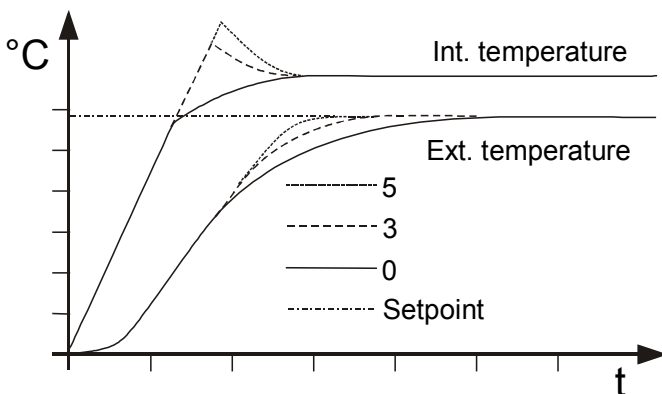

As soon as a co-speed factor is set, it is considered for calculating the control parameters. As shown in the diagram, tuning times become shorter the higher the co-speed factor is, but overshooting can happen in the internal system.

9.2.6. Control parameters – XPU, XP, TN, TV external

XXXXXX
XP EXT
0.7

Setting range: 0.1 ... 99.9

XXXXXX
TN EXT
720

Setting range: 1 ...9999

XXXXXX
TV EXT
55

Setting range: 0 ... 999

XXXXXX
XPU EXT
5.0





Setting range: 0.1 ... 99.9

The control parameters preset in factory are in most cases adequate for achieving an optimum temperature pattern for the samples requiring temperature application.

Each parameter may be manually set via the keypad if necessary, to allow optimum control performance.

1. Press the  button until the desired submenu is displayed - XP EXT, TN EXT, TV EXT, XPU EXT.

2. Set value:

- Use the cursor keys   to move left or right on the display until the numeral you wish to change blinks.
- Use the increase/decrease arrows   to change the selected numeral (-, 0, 1, 2, 3, ... 9).

3. Press enter  to store the value.

Continue: Press  /  or 

Proportional range >Xpu<

The proportional range Xpu of the cascaded controller is only needed for external control.

9.3. MENU CONFIG - configuration

XXXXXX
MENU
CONFIG



CONFIG: Press enter  to switch to menu level 2

 >SETP<

(KEY / SERIAL / PT100 / EPROG*)
Keypad control or remote control

 >A-START<

(OFF / ON)
Autostart on / off

 >OFFMODE<

(PMP OFF / PMP ON)
Motor on / off

 >RESET<

(NO / YES) Factory settings

 >ACTVAR<

(CONTROL / SERIAL / EPROG*)
ACTuating VARIABLE

 >TIME<

(hh : mm) Setting time

 >DATE<

(TT/MM.JJ) Setting date

EPROG* Indication only when electronic module is mounted.

9.3.1. SETPOINT – Keypad control or remote control



Factory setting: KEY

The selected mode is indicated on the VFD COMFORT-DISPLAY

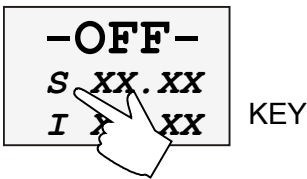

KEY

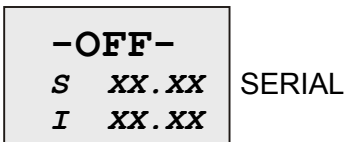

SERIAL

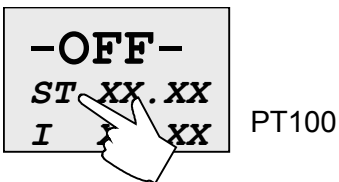

PT100

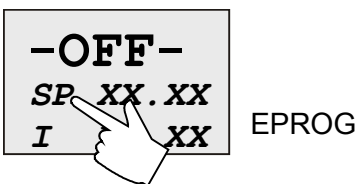

EPROG

The recirculating cooler provides four possibilities for setpoint setting.

1. Press the button until the submenu > SETP < is displayed.
2. Select the parameter with the keys (KEY / SERIAL / PT100 / EPROG)
3. Press enter to store the selected parameter.

Continue: Press / or

KEY – Setpoint setting with the keys and or the integrated programmer.

SERIAL - Setpoint setting via the serial RS232 interface through a PC or superordinated data system.

Important:

Connect the recirculating cooler to a PC using an interface cable. Check the interface parameters of both interfaces (on recirculating cooler and PC) and make sure they match. (see chapter 12.1. Setup for remote control page 67)

PT100 - Setpoint setting via the analog socket „ext. Pt100“ using an external temperature sensor or an appropriate voltage/current source.

EPROG - Can only be adjusted when an electronic module with analog connections is used (option). Setpoint setting via the analog interface REG+E-PROG connection with an external voltage or current source or a programmer.

Important:

Connect the external voltage or current source or a programmer to the circulator via the socket REG+E-PROG (see page 60). In the menu >MENU ANALOG< set the parameter >EPROG< and the input variables (see page 61).





The E-Prog input can only be used either under menu item > **SETP** < or under menu item > **ACTVAR** < (see page 44).

9.3.2. A-START – Autostart



Factory setting: OFF

The AUTOSTART function (automatic start mode) is allowing the start of the instrument directly by pressing the mains power switch or using a timer.

1. Press the  button until the submenu > A-START < is displayed.
2. Select the parameter with the keys   (OFF / ON).
3. Press enter  to store the selected parameter.

Continue: Press  /  or 

Possible parameters:

ON - AUTOSTART on

OFF - AUTOSTART off

Note:

The temperature system has been configured and supplied by JULABO according to N.A.M.U.R. recommendations. This means for the start mode, that the unit must enter a safe operating state after a power failure (non-automatic start mode). This safe operating state is indicated by **OFF**, resp. **R OFF** on the VFD COMFORT-DISPLAY. A complete shutdown of the main functional elements such as heater and circulating pump is effected simultaneously.

The values set on the recirculating cooler remain stored, and the unit is returned to operation by pressing the start/stop key (in manual control mode).

In remote control mode, the values need to be reset by the PC via the interface.

Should such a safety standard not be required, the AUTOSTART function (automatic start mode) may be activated, thus allowing the start of the instrument directly by pressing the mains power switch or using a timer.

The AUTOSTART function can only be used, if setpoint setting is carried out via > KEY <, > EPROG < or >PT100<.



Warning:

For supervised or unsupervised operation with the AUTOSTART function, avoid any hazardous situation to persons or property.

The instrument does no longer conform to N.A.M.U.R. recommendations.

The safety and warning functions of the instrument should always be used to their fullest capacity.

9.3.3. OFF-MODE – Pump motor on / off

XXXXXX
OFFMODE
PMP OFF



Factory setting:
PMP OFF

Normally the circulating pump is switched via the start/stop signal. However, if circulation should be maintained also for the -OFF- condition, the parameter >**PMP ON**< needs to be set.

Possible parameters:

PMP ON Pump motor on

PMP OFF Pump motor off

1. Press the  button until the submenu > OFFMOD < is displayed.
2. Select the parameter with the keys ▼ ▲.
(PMP ON / PMP OFF)
3. Press enter  to store the selected parameter.

Continue: Press  /  or 

- ⓘ In case of an alarm state, a shutdown of the pump motor is still effected.

9.3.4. RESET – Factory settings



XXXXXX
RESET
NO

Factory setting:
NO

Use this to reset all values to factory setting (except date and time). A RESET can only be carried out in the -OFF- condition.

Possible parameters:

NO / YES

1. Press the  button until the submenu > RESET < is displayed.
2. Select the parameter with the keys ▼ ▲ (NO / YES).
3. Press enter  to store the selected parameter.

XXXXXX
RESET
-RUN.-

- ⓘ As long as the message -RUN- appears all parameters a reset to factory settings.







9.3.5. ACTVAR - actuating variable

```
XXXXX
ACTVAR
CONTROL
```

Factory setting:
CONTROL

The variable (*ACTuating VARiable*) corresponds to the extent to which the heater or cooling machine of the recirculating cooler is controlled. Heat or cold is applied to the bath according to this variable. If this happens with the control electronics of the recirculating cooler, called > CONTROL < in this particular case, the bath temperature is exactly heated and maintained constant at the adjusted setpoint.

ⓘ Programming of variables for the parameters > SERIAL < or > EPROG < is only accepted, if the unit is in Start mode.

1. Press the  button until the submenu > ACTVAR < is displayed.
2. Select the parameter with the keys  
(CONTROL / SERIAL / EPROG)
3. Press enter  to store the selected parameter
Continue: Press  /  or 

Possible parameters:

CONTROL – The internal control electronics of the recirculating cooler controls the heater and cooling machine. Self-tuning is possible.

SERIAL – The heater or cooling machine receives the control signal via the serial interface. Self-tuning is not possible.

EPROG - The heater or cooling machine receives the control signal via the E-Prog input. Self-tuning is not possible.

Important:

Under >MENU ANALOG< set the input variable to >EPROG x / ACTVAR< (see page 61).

```
XXXXX
ACTVAR
SERIAL
```

```
XXXXX
ACTVAR
EPROG
```

```
XXXXX
EPROG U
ACTVAR
```

← Example: EPROG U / ACTVAR

Note:

The E-Prog input can only be used either under menu item > **SETP** < (page 41) or under menu item > **ACTVAR** <.

**Warning:**

The working temperature range of the recirculating cooler is determined during configuration. If set to >CONTROL<, this range cannot be exceeded. If set to > **SERIAL** < and > **EPROG** <, heat or cold is applied to the bath without control. The permissible maximum temperature can be exceeded. The user has to take adequate precautions for temperature control.

Materials, such as gaskets or insulations for example, may be damaged or destroyed, if the permissible maximum temperature is exceeded.

The safety and warning functions of the instrument should always be used to their fullest capacity.

8.  Safety installations, warning functions page 28

9.3.6. TIME / DATE – setting time and date



The integrated clock allows starting a profile at any date and time. The clock is preset in the factory.

XXXXXX
TIME
16h43.17

hh mm

1. Press the  button until the submenu > TIME < or > DATE < is displayed.

2. Setting time / date:

Use the cursor keys   to move left or right on the display until the numeral you wish to change blinks.

Use the increase/decrease arrows   to change the selected numeral (-, 0, 1, 2, 3, ... 9).

3. Press enter  to store the value.

Continue: Press  /  or 

XXXXXX
DATE
10/12.03

TT/MM.JJ

-  Clock: Only hours and minutes are set. Settings are checked for plausibility.

9.4. MENU SERIAL - BAUDRATE, HANDSHAKE, PARITY

```

XXXXXXXX
MENU
SERIAL
    
```

MENU SERIAL: Press enter  to switch to menu level 2





MENU >BAUDRAT<

MENU >PARITY<

MENU >H-SHAKE<

Factory settings:
 4800 Bauds
 even
 hardware handshake

For communication between recirculating cooler and a PC or a superordinated process system the interface parameters of bath units must be identical.

1. Press the  button until the desired menu item is displayed.
2. Select the parameter with the keys  .
3. Press enter  to store the selected parameter.

Continue: Press  /  or 

Adjustable interface parameters

```

XXXXXXXX
BAUDRAT
4800
    
```

BAUDRATE 4800 bauds
 9600 bauds

```

XXXXXXXX
PARITY
EVEN
    
```

PARITY no
 odd
 even

```

XXXXXXXX
H-SHAKE
HARD
    
```

HANDSHAKE
 SOFT = software handshake
 HARD = hardware handshake

Data bits = 7; Stop bits = 1

9.5. MENU LIMITS

```
XXXXXX
MENU
LIMITS
```



MENU **LIMITS:** Press enter  to switch to menu level 2

```
MENU >SET MAX<
MENU >SET MIN<
MENU >HEATMAX<
MENU >COOLMAX<
MENU >INT MAX<
MENU >INT MIN<
MENU >BAND H<
MENU >BAND L<
```

In case of external control these menu items are additionally indicated.

1. Press the  button until the desired submenu is displayed

2. Set value:

Use the cursor keys   to move left or right on the display until the numeral you wish to change blinks.

Use the increase/decrease arrows   to change the selected numeral (-, 0, 1, 2, 3, ... 9).

3. Press enter  to store the value.

Continue: Press  /  or 

SETPOINT MAX / MIN - Maximum and minimum setpoint
Restriction for the adjustable temperature range.

The limitation of the operating temperature range effects the temperature setting under the menu called up with the  key.

It is possible to adjust only working temperatures that lie within the limit range set here.

Existing settings for SETP 1, 2, 3 and also for >OVERTEMP< and >SUBTEMP< (see page 30) are automatically deferred within the limit range.

Setting range:: -94.99 °C ... +300.0 °C

Factory settings

```
XXXXXX
SET MAX
300.00
```

```
XXXXXX
SET MIN
-94.99
```

Factory settings

XXXXX
HEATMAX
100

XXXXX
COOLMAX
0

Adjusted maximum heating / cooling.

Heating and cooling powers of the recirculating cooler are adjustable. 100 % corresponds to the values in the technical specifications of the equipment.

Setting range:

HEAT MAX – 0 to 100 % in steps of 1 %

COOLING MAX – 0 to 100 % in steps of 1 %

Factory settings

XXXXX
INT MAX
300.00

XXXXX
INT MIN
-94.99

INTERNAL MAX / MIN Limit setting

Setting range: -94.9 °C ... +300.0 °C

The limits INT MAX and INT MIN are only valid for external control. INT MAX and INT MIN are used to limit the expected internal bath temperatures to any upper and lower values. The temperature controller cannot exceed these limits even if it would be required for reaching the temperature in the external system. Consequently the external setpoint may thus not be reached.

Sense of a limit setting:

- Protects the bath fluid from overheating.
- Prevents an undesired alarm shutdown by the excess temperature protection - >ALARM CODE 14<.
Set >INTMAX:< to a value at least 5 °C below the >SAFETEMP:< value.
- Protects the pump motor from high viscosity of the bath fluid at low temperatures.
For recirculating coolers: Freezing protection when using water as bath fluid.



Factory settings:

XXXXX
BAND H
200

XXXXX
BAND L
200

BAND HIGH / LOW - Band limit

For the heat-up and cool-down phases different settings to conform to the requirements of the particular application are possible.

Setting range: 0 ... 200 °C

Using **BAND HIGH** and **BAND LOW**, the difference between the temperatures in the internal bath and the external system can be limited to any maximum value for the heat-up or the cool-down phase. During the heat-up phase the difference value always adds to the actual external temperature. During the cool-down phase, the difference value is subtracted.

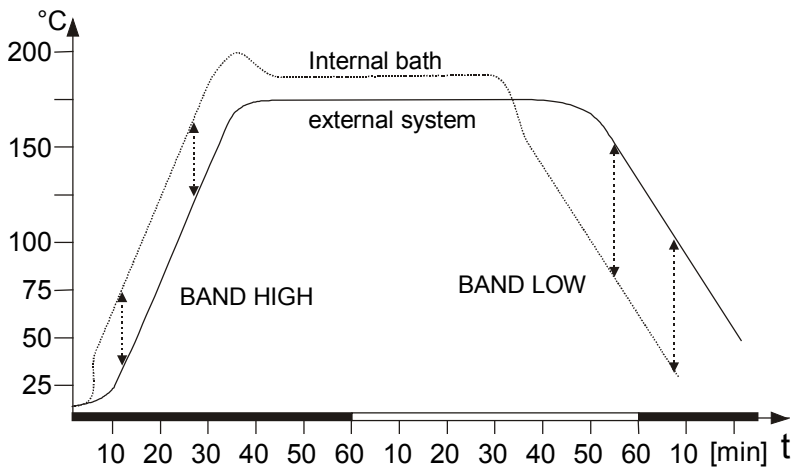

Sense of a band limit:

- Ensures gentle heating for the objects requiring temperature application.
- Protects glass reactors, for example, from thermal shock.

The **INTMAX:** and **INTMIN:** values are superordinated to this band limit.

9.6. MENU PROGRAM – Integrated programmer

XXXXXX
MENU
PROGRAM

- 1 Profil
- 10 Sections (STEP)
- 99 Repetitions

MENU

PROGRAM: Press enter  **to switch to menu level 2**

- MENU >PS STEP< Program start at section ...
- MENU > PS RUNS < Number of profile repetitions 1 ... 99
- MENU > PS GO < Start type (NOW/TIME)
- MENU > P TIME < Start time (hh:mm)
- MENU >P DATE< Start date (TT/MM.JJ)
- MENU >PS END< Status at the end of the profile (STBY/SETP)
(Standby or last setpoint)
- MENU > PE STEP< Edit profile (1 ... 10)
- MENU >Px SEP < Target temperature of section ...
- MENU >Px TIM< Time period of section ...
- MENU >Px DEL< Delete a section (STEP) (YES/NO)
- MENU > PE DEL< Delete a profile (YES/NO)

The integrated programmer allows any desired temperature program sequences to be realized. Such a temperature sequence is called profile. A profile consists of individual sections defined by duration (t:) and target temperature. Target temperature is the setpoint (T:), that is achieved at the end of a section. The programmer uses time and temperature difference values within a section to calculate a temperature ramp.

PE STEP (No.)	1	2	4	6	8
Px SEP (°C)	100	180	180	75	75
Px TIM (hh.mm)	00:20	00.10	00:20	00:50	00:20

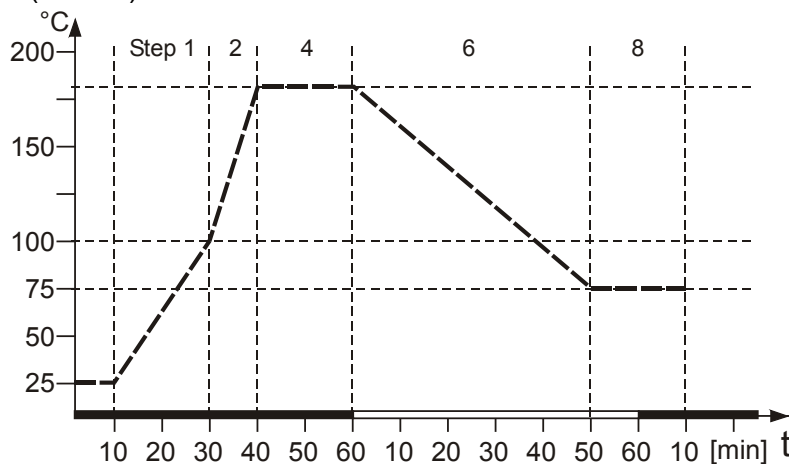

Example:

1. Press the button until the desired submenu is displayed.

2. Set value:

Use the cursor keys to move left or right on the display until the numeral you wish to change blinks.

Use the increase/decrease arrows to change the selected numeral (-, 0, 1, 2, 3, ... 9).

or

select the parameter with the keys .

3. Press enter to store the value / parameter

Continue: Press / or

Starting a profile

If a profile is stored, the programmer can be started with one of the 3 menu items.

```
XXXXXX
PS STEP
  1
```

>PS STEP< (1 ... 10)

Select the section with which the profile should be started. (STEP)

Example: STEP 1

```
XXXXXX
PS RUNS
  10
```

>PS RUNS< (1 ... 99)

Select the number of profile repetitions. Example: RUNS 10

The profile is repeated 10 times.

```
XXXXXX
PS GO
  TIME
```

>PS GO<

The profile can be started immediately with the parameter (NOW), or at the set time with the parameter (TIME).

Example below: 19 December 2003 14:25 hrs

The started programmer

The started programmer indicates the actually calculated setpoint S XX.X in line 2. This value increases within the time period >Px TIM< until the target temperature >Px SEP< of the section is reached.

If time in a section is set to „0“, the next section starts only as soon as the target temperature is reached.

Use the edit keys ▼ ▲ to scroll in line 3. The display changes in intervals of approx. 4 seconds between the valid section (STEP X) and

	XXXXXX S XX.X STEP X
A	S XX.X XXhXXxx
B	S XX.X XXhxx
C1	S XX.X I xxx.x
C2	S XX.X E xxx.x
D1	S XX.X RUN
D2	S XX.X PAUSE

A Remaining time of the valid section or

B Remaining total time: Profile x number of repetitions or

C Actual bath temperature

I xxx.x – internal actual value or

E xxx.x – external actual value

D RUN – the programmer is started or

PAUSE – the profile was interrupted with the key . Time is stopped and the temperature is maintained constant at the last calculated setpoint value.

Continue: Press 

Interrupting / Termination of a profile

① A profile can be terminated by pressing .

① Power failure with the programmer started:

– The reaction of the circulator is the same as when switched off and on again with the mains switch. The VFD COMFORT-DISPLAY indicates "OFF".

– If the AUTOSTART function is activated, the programmer starts again at a point approx. 20 seconds before the interruption took place. However, an uncontrolled change of the bath temperature happened.

-OFF-
S xxx.x
I xx.x

Setting time/date for the start

>TIME<

Enter the start time. Example: 14:25 hrs

>DATE<

Enter the start date. Example: 19 December 2003

① Check the setting of the internal real time clock (see page 45).

XXXXXX
TIME
14h25ss

XXXXXX
DATE
19/1203

Status at the end of the profile

>PS END< (STBY / SETP)

Set the status for the end of the profile.

With the parameter **ST**and**BY** the circulator enters the –OFF– state.





With the parameter **SETP**oint the circulator maintains the temperature at the value of the last section.

XXXXXX
PS END
SETP

Compiling profiles, indicating sections

Example: Section 2





```
XXXXXX
PE STEP
  2
```

- 1 Press the  button until the submenu >PE STEP x< is displayed.
 - 1.1 Use the increase/decrease arrows   to set the number of the desired section (1, 2, 3, ... 10).
 - 1.2 Press  to enter menu level 3.

Menu level 3:





```
XXXXXX
P2 SEP
180.0
```

- 2 Submenu >Px SEP< (SETPOINT)
Set a temperature value: Example: 180 °C

- 2.1 Use the cursor keys   to move left or right on the display until the numeral you wish to change blinks.
- 2.2 Use the increase/decrease arrows   to change the selected numeral (-, 0, 1, 2, 3, ... 9).
- 2.3 Press enter  to store new the value.

```
XXXXXX
P2 TIM
00h10
```

- 2.4 Continue: Press 
- 3 Submenu >Px TIM< (TIME)
Set a time. Example: 10 minutes.

- 3.1 Use the cursor keys   to move left or right on the display until the numeral you wish to change blinks.
- 3.2 Use the increase/decrease arrows   to change the selected numeral (-, 0, 1, 2, 3, ... 9).
- 3.3 Press enter  to store new the value.

```
XXXXXX
P2 DEL
NO
```

- 3.4 Continue: Press 
- 4 Submenu >Px DEL< (DELETE)
Standard setting (NO)
Set the parameter to YES to delete the values in this section.

- 4.1 If necessary, use the arrows   to set the parameter to YES and press .

- 5 Press  to return to submenu >Px SEP< in menu level 3.
Or

- 6 Press  to return to submenu >PE STEP x< in menu level 2.

```
XXXXXX
P1 xxx
  ---.
```



-  Sections without value or time indication (including the value 0) are skipped. But they can be integrated in the profile at a later time.
Example: Section 1

Deleting a profile

```
XXXXXX
PE DEL
YES
```

- >PE DEL< (YES/NO)
Set the parameter to YES to delete **all sections** >PE STEP / 1 to 10<.

9.7. MENU ADJUST – ATC Absolute Temperature Calibration

ATC serves to compensate a temperature difference that might occur between recirculating cooler and a defined measuring point in the bath tank because of physical properties.

XXXXXX
MENU
ADJUST

MENU

ADJUST: Press enter  to switch to menu level 2

MENU >ATC SEN <
 (INT) **or** (EXT)

MENU > ATCSTAT <
 (ON or OFF)

MENU > ATCSTAT <
 (ON or OFF)

MENU >C ART
 >1- point <-, >2- point <- or >3- point < - calibration

MENU >C ART
 >1- point <-, >2- point <- or >3- point < - calibration

MENU > TTEMP 1<
MENU > CTEMP 1<

MENU > TTEMP 1<
MENU > CTEMP 1<



MENU > TTEMP 2<
MENU > CTEMP 2<

MENU > TTEMP 2<
MENU > CTEMP 2<



MENU > TTEMP 3<
MENU > CTEMP 3<

MENU > TTEMP 3<
MENU > CTEMP 3<

1. Press the MENU button until the desired submenu is displayed.
2. Set value /parameter:

Use the cursor keys   to move left or right on the display until the numeral you wish to change blinks.

Use the increase/decrease arrows   to change the selected numeral (-, 0, 1, 2, 3, ... 9).

or
 select the parameter with the keys  .

3. Press enter  to store the value / parameter

Continue: Press MENU / **ESC** or 

<p>XXX . X ACT SEN INT</p>	<p>ATC SENSOR - INTERNAL / EXTERNAL</p> <p>In the first submenu the ATC function is set for the >INT< internal or >EXT< external temperature sensor.</p> <p>Calibration can be carried out for the internal temperature sensor and for the external temperature sensor connected to the socket „ext. Pt100“.</p>
<p>XXX . X ACT SEN EXT</p>	<p>The recirculating cooler is able to store both parameter sets. However, only the one set under this menu item is indicated.</p>

<p>XXX . X ATCSTAT OFF</p>	<p>ATC STATUS - ON / OFF</p> <p>In the second submenu the ATC function for the temperature sensor selected above is activated >ON< or deactivated >OFF<.</p> <p>>OFF< The controller of the recirculating cooler uses the original curve of the temperature sensor.</p> <p>Important: During the calibration process > OFF < needs to be set.</p> <p>>ON< The controller of the recirculating cooler uses the new calibration curve.</p> <p>❗ In the ATC STATUS > ON<, the ATC calibration curve always affects the effective working temperature (also the one set via the interface).</p>
<p>XXX . X ATCSTAT ON</p>	

<p>Calibration type</p> <p>XXX . X C ART x POINT</p>	<p>CALIBRATION ART: 1, 2, 3-point calibration</p> <p>A >1-point<, >2-point < or >3-point < calibration can be carried out.</p> <p>First geometrically define the location for calibration (measuring point CT), then determine the temperature values of the calibration points. The calibration type also determines the number of pairs of values indicated on the VFD COMFORT-DISPLAY.</p>
---	---

<p>XXX . X TTEMP 1 x 80.00</p>	<p>XXX . X CTEMP 1 x 79.73</p>	<p>2 values per calibration point</p> <p>TTEMP X: Temperature on circulator (actual value TT) 1 or 2 or 3 Defined temperature value of the calibration point. This value is simultaneously stored with > CTEMP < and can be indicated for control purposes.</p> <p>CTEMP X: Calibration temperature (actual value CT) 1 or 2 or 3 The „Calibration value“ is determined with a temperature measuring device and stored under menu item > CTEMP <.</p>
<p>XXX . X TTEMP 2 x120.00</p>	<p>XXX . X CTEMP 2 x119.51</p>	
<p>XXX . X TTEMP 3 x160.00</p>	<p>XXX . X CTEMP 3 x159.34</p>	

Example:

1-point calibration

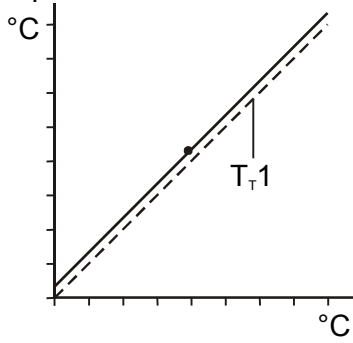

3-point calibration

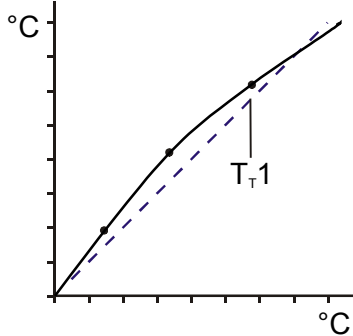

T_T 1 = Original curve

Principle:

For ATC calibration, in steady state the bath temperature at the location of the temperature sensor (CT) is determined at the respective adjusted working temperature. This value is then set on the recirculating cooler in the menu >ATCalibration< under menu item >CTEMP X<. This can be a 1-point, 2-point or 3-point calibration.

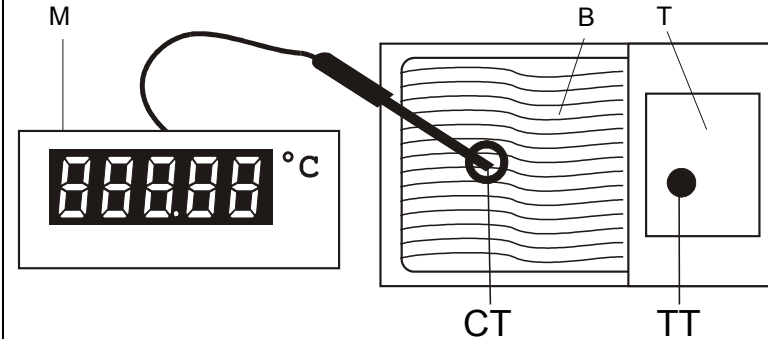

- M = Temperature measuring instrument with temperature sensor
- B = Bath tank with T = recirculating cooler
- CT = Temperature on measuring point
- TT = Temperature on recirculating cooler

Example:

3-point calibration for internal control.

In the temperature range of 80 °C to 160 °C the calibration curve of the temperature sensor (TT) should be assimilated to the actual temperatures on the measuring point (CT).

Set controller to internal control:

ⓘ The control type can only be adjusted in the -OFF- condition

1. Press the **MENU** button until the menu item > MENU / CONTROL< is displayed and press enter **↵**.
 - 1.1. Under the menu >CONTROL< set the parameter to > INT < and press enter **↵** (see page 34).
Continue: Press **ESC**.
2. Press the start/stop key **⏻**.

XXXXXX
MENU
CONTROL

XXX.X
CONTROL
INT

XXX . X
SETP 1
80.00

XXXXX
MENU
ADJUST

XXX . X
ACT SEN
INT

XXX . X
ATCSTAT
OFF

XXX . X
C ART
3 POINT

XXX . X
CTEMP 1
I 79.73

XXX . X
TTMP 1
I 80.00

↑ „I“ for internal control

Setting working temperature SETP:

3. Press **T** and set the first temperature value under > SETPoint 1 < for example (example 1st value = 80 °C).
 - 3.1. Wait until this temperature is maintained constant in the bath for about 5 minutes.

Calibration procedure:

4. Press the **MENU** button until the menu item > MENU / ADJUST < is displayed and press enter **↵**.
 - 4.1. Set menu item >ATC SEN< to >INT< ,
 - 4.2. Set menu item >ATCSTAT< to >OFF< ,
 - 4.3. Set menu item >C ART< to >3 POINT < .

ⓘ These 3 settings are maintained for the length of the 3-point calibration procedure.
5. Read the value of CT on the temperature measuring device and enter the respective value under menu item > CTEMP 1<
 - 5.1. Set value: (79.73 °C)

Use the cursor keys **◀▶** to move left or right on the display until the numeral you wish to change blinks.
 Use the increase/decrease arrows **▼▲** to change the selected numeral (-, 0, 1, 2, 3, ... 9).
 - 5.2. Press enter **↵** and the recirculating cooler also stores the value of TT as value for >TTMP 1< (80.00 °C) .
 The first of the 3 points is now calibrated.
 Continue: Press **ESC**.
6. Repeat the calibration procedure for 120 °C and 160 °C. (point 3. to 5.).

Examples:

TT = 80.00 °C	TT = 120.00 °C	TT = 160.00 °C
CT = 79.73 °C	CT = 119.51 °C	CT = 159.34 °C

9.8. MENU ANALOG – Analog inputs/outputs

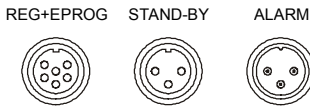

i In order to use the analog inputs and outputs, the recirculating cooler must be equipped with the Analog Interface Modul available as option.

This submenu enables setting of the input and output values for the programmer input and the temperature recorder outputs of socket REG+E-PROG.

The >STAND-BY< input and the >ALARM< output are configurable.



ANALOG: Press enter  to switch to menu level 2

F-ALARM
Function at alarm

 >F-ALARM< (STANDBY / ALARM / AL-STBY)



A-ALARM
Type of alarm

 >A-ALARM< (NORMAL / INVERS)



EX-STBY
STAND-BY input

 >EX-STBY < (INACTIV / ACTIV)



ACTINT [°C]
internal actual
temperature value
(bath temperature)

 >CHANNEL < (1 / 2 / 3)
 >CH1 < (ACTINT/ ACTEXT/ POWER/ S-POINT)

ACTEXT [°C]
external actual
temperature value
(external sensor)





 >CH1 0V< (-99.90)
 >CH1 10V< (300.00)

or

 >CH2 < (POWER/ S-POINT/ ACTINT/ ACTEXT)
 >CH2 0V< (0.00)
 >CH2 10V< (100.00)

S-POINT [°C]
active setpoint
temperature

or

 >CH3 < (S-POINT/ ACTINT/ ACTEXT/ POWER)
 >CH3 < (0-20MA / 4-20MA)
 >CH3 0MA< (-99.90)
 >CH3 20MA< (300.00)

SETP [°C]
Setpoint

 >EPROG < (VOLTAGE (U) / CURRENT (I))

FLOWRAT [L/M]

 > EPROG U< (SETP / FLOWRAT / ACTVAR)

ACTVAR [%]
Actuating variable

 > UW °C< (-99.90)

 > OW °C< (300.00)

- or
- MENU >EPROG < (VOLTAGE (U) / **CURRENT** (I))
 - MENU > EPROG I< (**SETP** / FLOWRAT / ACTVAR)
 - MENU > UW °C< (-99.90)
 - MENU > OW °C< (300.00)

1. Press the MENU button until the desired submenu is displayed.
2. Set value/parameter:

Use the cursor keys to move left or right on the display until the numeral you wish to change blinks.

Use the increase/decrease arrows to change the selected numeral (-, 0, 1, 2, 3, ... 9).

or

select the parameter with the keys .

3. Press enter to store the value / parameter

Continue: Press MENU / ESC or

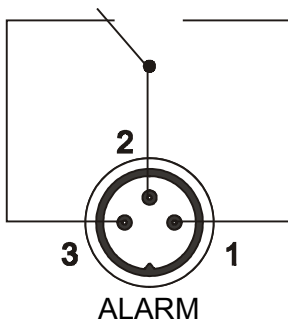

Alarm output

(for external alarm signal)

Possible parameters:

>F-ALARM< (STANDBY or ALARM or AL-STBY)

>A-ALARM< (NORMAL or INVERS)

This socket is a potential-free change-over contact. With the adjustments in the menu item > Funktion-**ALARM** < all operating conditions can be signaled without having to change the pin assignments.

Signification of the terms under menu item >Function< :

The recirculating cooler is in condition
>STANDBY< or >ALARM<

-OFF-
S xx.xx
E -----

XXXXXX
ALARM
CODE xx

or >AL-STBY< - both conditions are signaled.

XXXXXX
F-ALARM
STANDBY

XXXXXX
A-ALARM
NORMAL

Type of alarm

For > **A-ALARM** / **NORMAL** < pins 2 and 3 are connected in any case according to the selected > **Function-ALARM** <.

For > **A-ALARM** / **INVERS** < pins 2 and 1 are connected in any case according to the selected >Function<.

Switching capacity max. 30 W / 40 VA
 Switching voltage max. 125 V~/–
 Switching current max. 1 A

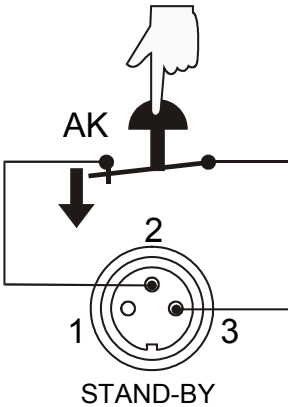

XXXXXX
EX-STBY
ACTIV

E OFF
S xx.xx
E -----

EX-STBY: External Stand-by input
 (for external emergency switch-off)
 (Connector see page 66)

Possible parameters: >EX-STBY <

INACTIV - standby input is ignored

ACTIV - standby input is active

Activate the standby input:

1. Under menu item > EXT-STBY <, set the parameter to >**ACTIV**<.
2. Connect an external contact ‚AK‘ (e.g. for emergency switch-off) or an alarm contact of the superordinated system.

In case the connection between Pin 2 and Pin 3 is interrupted by opening the contact ‚AK‘, a complete shutdown of the circulating pump and heater is effected, and the unit enters the condition „**E OFF**“.

If the contact is reclosed, the instrument returns to the standby state and „**E OFF**“ is displayed. Press  to start.

ⓘ Additional tips for using the STANDBY input:

The standby function can be used in conjunction with the AUTOSTART feature (see page 42)

1. If the Autostart function is NOT turned ON, the standby input is used as described above.
2. If the Autostart function is enabled, the instrument will revert back to the original method of entering the setpoint (i.e. keypad, RS232, Analog input, etc.).

Entering the setpoint with the keypad. e.g. 

As described above, a bipolar shutdown is accompanied by displaying the „**E OFF**“ state. The recirculating cooler starts again when the contact is reclosed. The temperature of the bath fluid changed during the „**E OFF**“ state.

Entering the setpoint with the programmer (see pages 49). The display **E OFF** appears. The setpoint value and the time are both held at the current value. The temperature of the bath fluid will be held constant at this temperature. The programmer continues once the contact is reclosed.

Notice: This is not an actual shutoff feature.

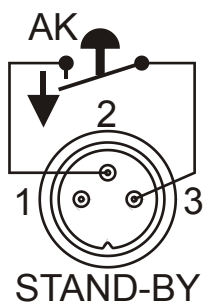

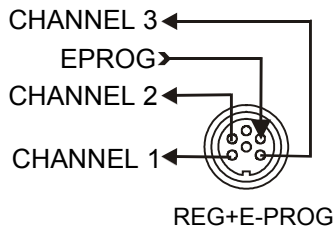

REG+E-PROG :

Outputs of the connector REG+E-PROG

1. Select CHANNEL 1, 2 or 3

2. First define the desired output value for CHANNELs 1 to 3:

- ACTINT** internal actual temperature value (bath temperature)
- ACTEXT** external actual temperature value (external sensor)
- POWER** periodic or intermittent heating or cooling
- S-POINT** active setpoint temperature
(SETPoint 1, 2, 3,/ integr. programmer /external programmer)

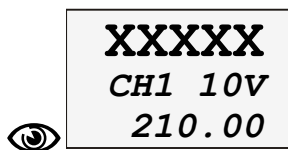

3. Then select the display size for CHANNELs 1 to 3:

Voltage outputs CHANNELs 1 and 2

Assign the voltage values of 0 V to the lowest and 10 V to the highest necessary temperature (°C) or power rating (%) required as an output value.

Current output CHANNEL 3

The current output (channel 3) offers 2 ranges for selection:

- 0 mA to 20 mA** or
- 4 mA to 20 mA**

Assign the current values 0 mA or 4 mA to the lowest and 20 mA to the highest temperature (°C) or power rating (%) required as an output value.

XXXXXX CH3 ACTINT	XXXXXX CH3 0-20MA	XXXXXX CH3 0MA xx.xx	XXXXXX CH3 20A xx.xx	or
XXXXXX CH3 ACTINT	XXXXXX CH3 4-20MA	XXXXXX CH3 4MA xx.xx	XXXXXX CH3 20A xx.xx	

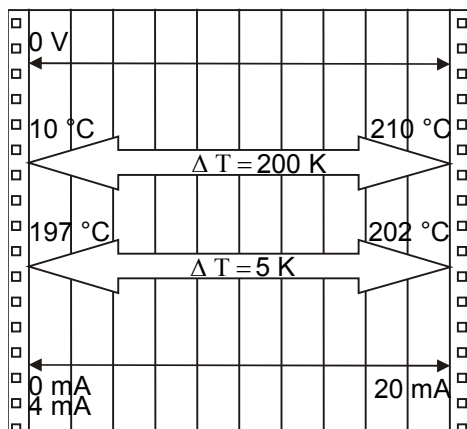

Example 1:

- lowest temperature value: 10 °C
 - highest temperature value: 210 °C
- Fig. shows 200 °C scaled to paper width
rise: 50 mV/°C

Example 2:

- lowest temperature value: 197 °C
 - highest temperature value: 202 °C
- Fig. shows 5 °C scaled to paper width
rise: 2000 mV/°C

XXXXXX
MENU
CONFIG

1. XXXXXX
SETP
EPROG

2. XXXXXX
ACTVAR
EPROG

-OFF-
S XX.XX
F X.XL



>FLOWRAT<
Indication on display

XXXXXX
MENU
ANALOG

Example:

2. XXXXXX
EPROG
VOLTAGE

3. XXXXXX
EPROG U
SETP

4. XXXXXX
UW °C
20.00

5. XXXXXX
OW °C
300.00

XXXXXX
SP 50.00
I XX.XX



E-PROG - input

Setting needs to be carried out, if

1. setpoint programming is to be made via an external voltage or current source or programmer.
For this, in the menu > MENU / CONFIG < first set the menu item > SETP < to >EPROG<.
2. the heater variable should be controlled via an external control pulse.
For this, in the menu > MENU / CONFIG < set the menu item >ACTVAR< to >EPROG<.
3. the signal of an external flow meter should be registered.

① The E-Prog input can only be used either under menu item > SETP < or under menu item > ACTVAR <.
If the input is neither occupied by > SETP < or > ACTVAR <, the signal of a flow meter can be connected.

① First set > **MENU / CONFIG** <, then > **MENU / ANALOG** <.

1. Connect the external voltage or current source or programmer to socket (12) REG+E-PROG of the circulator.
2. Selecting the signal:
The programmer (E-PROG) input of the circulator can be matched to the output signal of the external voltage or current source.
VOLTAGE voltage input = U
CURRENT current input = I
3. Define the input variable:
SETP Setpoint programmed by external voltage or current
FLOWRAT Signal of an external flow sensor
ACTVAR Manipulated (ACTuated) variable for the heater with an external control pulse
4. **UW – Setting the LOW value:** (See below ↻)
First adjust and set the lowest voltage or current on the external voltage or current source (e.g. 0 V or 0 mA).
Then after approx. 30 secs enter the corresponding temperature value (e.g. 20.00°C).on the circulator by pressing the appropriate buttons
(◀▶▼▲) on the keypad and press enter  to set.
5. **OW – Setting the HIGH value:** (See below ↻)
First adjust and set the highest voltage or current on the external voltage or current source (e.g. 10 V or 20 mA).
Then after approx. 30 secs enter the corresponding temperature value (e.g. 300 °C).on the circulator by pressing the appropriate buttons (◀▶▼▲) on the keypad and press enter  to set.

Example: SP 50.00 °C

- Set the external voltage or current source output for the equivalent of 50 °C temperature setpoint.

SP = **S**etpoint **P**rogrammer

- Press **ESC**.

The temperature value adjusted and set on the external voltage or current source is displayed in line 2 of the VFD COMFORT-DISPLAY for control purposes.

This EPROG input enables the use of different voltage and current values as program parameters.

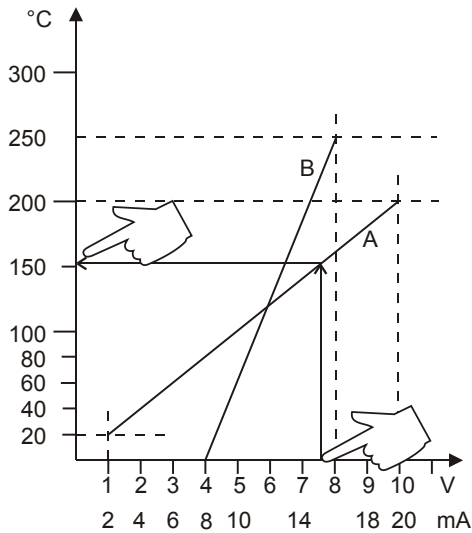

UW – Setting the LOW value:: (See below ↻)

1. Adjust and set the lowest desired value on the voltage or current source resp. (Example A: 1 V).
Wait appr. 30 seconds.
2. Assign a lower temperature threshold value to this adjusted voltage/current value by pressing the appropriate buttons on the keypad of the instrument (Example A: 20 °C) and set by pressing enter

OW – Setting the HIGH value: (See below ↻)

1. Adjust and set the highest desired value on the voltage or current source resp. (Example A: 10 V).
Wait appr. 30 seconds.
2. Assign an upper temperature threshold value to this adjusted voltage/current value by pressing the appropriate buttons on the keypad of the instrument (Example A: 200°C) and set by pressing enter

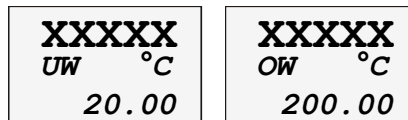

ⓘ Example B in the diagram serves to illustrate that the end point values are freely selectable (Ex: 8 mA and 16 mA).

Example out of diagram A:

- Adjusting the voltage source for an output of 7.6 V!

The instrument calculates this value from the rise angle of the two predecided end points (in example A: 7.6 V correspond to an external setpoint temperature of 152.0 °C).

After returning the VFD display to standard display by pressing **ESC**, this value is displayed in line 2 (Example: SP 152.00 °C).

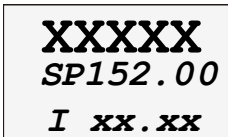

Notice:

If this adjustment is not correctly performed at two different points, the setpoint setting will be incorrect.



Important:

The usable temperature range between > **UW** < and > **OW** < is limited to the configured working temperature range of the circulator resp. of the unit combination (working temperature range see technical specifications on page 11)

10. Troubleshooting guide / Error messages

XXXXXX
ALARM
CODE 01

Alarm with a complete shutdown of the unit

Whenever the microprocessor electronics registers a failure, a complete shutdown of the heater and circulating pump is performed. The alarm light „“ illuminates and a continuous signal tone sounds.

The VFD COMFORT-DISPLAY indicates the cause for the alarm in form of a code.



XXXXXX
WARNING
CODE 40

Warning without a complete shutdown of the unit

The VFD COMFORT-DISPLAY indicates the cause for the warning in form of a code and an acoustic signal sounds in regular intervals.

These messages appear every 10 seconds.



Press enter  to quit the audible signal.

ALARM
CODE 01

- The recirculating cooler is operated without bath fluid, or the liquid level is insufficient. Replenish the bath tank with the bath fluid.
- Tube breakage has occurred (insufficient filling level due to excessive bath fluid pumped out). Replace the tubing and replenish the bath tank with the bath fluid.
- The float is defect (e. g., because damaged in transit). Repair by authorized JULABO service personnel.
- Excess temperature sensors defect.
- The excess temperature value lies below the working temperature setpoint. Set the excess temperature to a higher value.

WARNING
CODE 03

- Excess temperature warning
or
Excess temperature alarm

ALARM
CODE 03

Warning type: Set to >Warning< or >Alarm< (see page 31)

WARNING
CODE 04

- Low temperature warning
or
Low temperature alarm.

ALARM
CODE 04

Warning type: Set to >Warning< or >Alarm< (see page 31)

ALARM
CODE 05

- Cable of the working temperature sensor interrupted or short-circuited.

ALARM
CODE 06

- Defect of the working or excess temperature sensor.
Working temperature and excess temperature sensors report a temperature difference of more than 35 K.

ALARM
CODE 07

- Other errors (I²C-BUS errors)

ALARM
CODE 12

- Error in A/D converter
-

ALARM
CODE 14

- Excess temperature sensors defect.
 - The excess temperature value lies below the working temperature setpoint. Set the excess temperature to a higher value.
-

ALARM
CODE 15

- External control selected, but external Pt100 sensor not connected or defect.
-

ALARM
CODE 33

- Cable of the excess temperature sensor interrupted or short-circuited.
-

ALARM
CODE 38

- Ext. Pt100 sensor input without signal, but setpoint programming set to external Pt100.
-

WARNING
CODE 40

- The early warning system for low level signals a critical fluid level. Replenish the bath tank with the bath fluid.
-



After eliminating the malfunction, press the mains power switch off and on again to cancel the alarm state.

If the unit cannot be returned to operation, contact an authorized JULABO service station.



Mains circuit breakers (resettable) – 16A.

11. Electrical connections



Notice:

Use shielded cables only.
 The shield of the connecting cable is electrically connected to the plug housing.
 The unit ensures safe operation if connecting cables with a maximum length of 3 m are used. The use of longer cables does not affect proper performance of the unit, however external interferences may have a negative impact on safe operation.

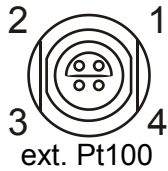

Socket for external Pt100 sensor

Pin assignment:

Pin	Signal
1	I+
2	U+
3	U-
4	I-

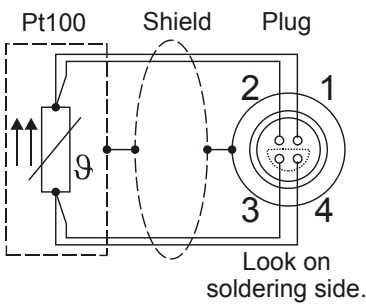

The shield of the connecting cable is electrically connected to the plug housing and the sensor tube.



RS232 serial interface

This port can be used to connect a computer with an RS232 cable for remote control of the circulator.

Pin assignments RS232:

Pin 2	RxD	Receive Data
Pin 3	TxD	Transmit Data
Pin 5	0 V	Signal GND
Pin 7	RTS	Request to send
Pin 8	CTS	Clear to send

Pin 1; 4; 6, 9 Reserved - do not use!

Accessories:	Order No.	Description
	8 980 073	RS232 interface cable 9-pol./9-pol. , 2.5 m
	8 900 110	USB interface adapter cable

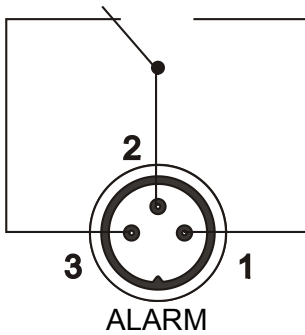

Alarm output

(for external alarm signal)

This potential-free change-over contact is activated in case of an alarm when pins 2 and 3 are connected.

Switching capacity max. 30 W / 40 VA
 Switching voltage max. 125 V~/–
 Switching current max. 1 A

Functional description see page 58

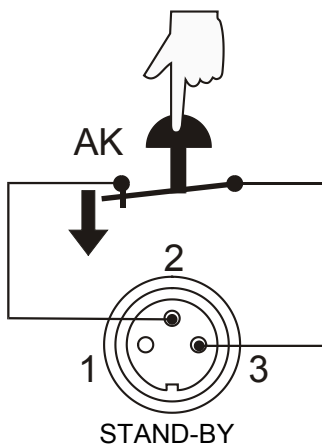

STAND-BY input

(for external emergency switch-off)

Pin assignment:	Pin	Signal
	1	not connected
	2	5 V / DC
	3	0 V

Functional description see page 6

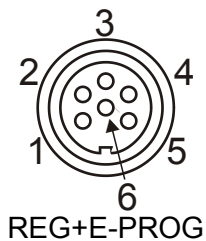

Programmer input / temperature recorder output

Pin	Signal	
1	Voltage output	Channel 1 0 ... 10 V
2	Voltage output	Channel 2 0 ... 10 V
3	GND for outputs	0 V
4	Programmer input	EPROG 0 to 10 V / 0 to 20 mA
5	Current output	Channel 3 0 to 20 mA / 4 to 20 mA
6	GND for Programmer	0 V

Functional description see page 60

Control connector

Return flow safety device.

If the liquid levels in the recirculating cooler and the external system are at different heights, overflowing must be prevented after the power has been turned off. For this reason, solenoid valves for loop circuit can be integrated in the loop circuit.

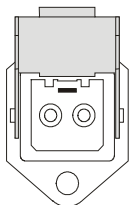

- ⓘ The control output is not powered in the OFF condition.
 Output voltage: 230 V~/ max. 0.1 A

12. Remote control

12.1. Setup for remote control

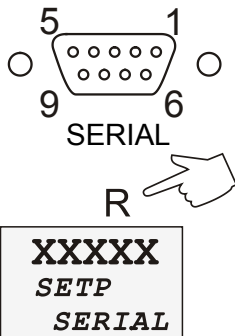

1. Check the interface parameters for both interfaces (on recirculating cooler and PC) and make sure they match. (Serial interface see page 46)
2. In the menu > MENU / CONFIG < set the menu item > SETPoint < to > SERIAL < . (see 9.3.1.SETPOINT – Keypad control or remote control on page 41)
3. Connect both units with an interface cable..



Like all parameters which can be entered through the keypad, interface parameters are stored in memory even after the recirculating cooler is turned off.

12.2. Communication with a PC or a superordinated data system

If the recirculating cooler is put into remote control mode via the configuration level, the VFD COMFORT-DISPLAY will read „R -OFF-„ = REMOTE STOP. The recirculating cooler is now operated via the computer. In general, the computer (master) sends commands to the recirculating cooler (slave). The recirculating cooler sends data (including error messages) only when the computer sends a query.



In remote control mode: After a power interruption the order to start and all values which have to be adjusted must be resent from the personal computer via the interface. AUTOSTART is not possible.

A transfer sequence consists of:

- command
- space (↔; Hex: 20)
- parameter (the character separating decimals in a group is the period)
- end of file (↵; Hex: 0D)
- The response (data string) after an **in** command is always followed by a line feed (LF, Hex: 0A).

The commands are divided into **in** or **out** commands.

in commands: asking for parameters to be displayed

out commands: setting parameters



Important times for a command transmission:

To ensure a safe data transfer, the time gap between two commands should be at least 250 ms.

The circulator automatically responds to an **in** command with a data string followed by a LF (Line Feed). The next command should only be sent after 10 ms.



The **out** commands are valid only in remote control mode.

Examples:

Command to set the working temperature >Setpoint1< to 55.5 °C

out_sp_00 ↔ 55.5↵

Command to ask for the working temperature >Setpoint1<

in_sp_00↵

Response from the circulator:

55.5↵ LF

12.3. List of commands

out commands: Setting temperature values or parameters.

Command	Parameter	Response of recirculating cooler
out_mode_01	0	Use working temperature > SETP 1<
out_mode_01	1	Use working temperature > SETP 2<
out_mode_01	2	Use working temperature > SETP 3<
out_mode_02	0	Selftuning „OFF“. Temperature control by using the stored parameters.
out_mode_02	1	Selftuning „ONCE“ Single selftuning of controlled system after the next start.
out_mode_02	2	Selftuning „ALWAYS“ Continual selftuning of controlled system whenever a new setpoint is to be reached.
out_mode_03	0	Set external programmer input to voltage. Voltage 0 V ... 10 V
out_mode_03	1	Set external programmer input to current. Current 0 mA ... 20 mA
out_mode_04	0	Temperature control of internal bath.
out_mode_04	1	External control with Pt100 sensor.
out_mode_05	0	Stop the unit = R –OFF–.

Command	Parameter	Response of recirculating cooler
out_mode_05	1	Start the unit.
out_mode_08	0	Set the control dynamics - aperiodic
out_mode_08	1	Set the control dynamics - standard
out_sp_00	xxx.xx	Set working temperature. „SETP 1“
out_sp_01	xxx.xx	Set working temperature. „SETP 2“
out_sp_02	xxx.xx	Set working temperature. „SETP 3“
out_sp_03	xxx.xx	Set high temperature warning limit „OVERTEMP“
out_sp_04	xxx.xx	Set low temperature warning limit „SUBTEMP“
out_sp_06	xxx.xx	Set manipulated variable for the heater via serial interface -99.99 ... +100 [%]
out_sp_07	x	Set the pump pressure stage. (1 ... 4)
out_par_04	x.x	CoSpeed 0 ... 5.0 Band limit during external control. Setting the maximum difference between the temperatures in the internal bath and external system.
out_par_06	xxx	Xp control parameter of the internal controller. 0.1 ... 99.9
out_par_07	xxx	Tn control parameter of the internal controller. 0 ... 9999
out_par_08	xxx	Tv control parameter of the internal controller. 0 ... 999
out_par_09	xxx	Xp control parameter of the cascade controller. 0.1 ... 99.9
out_par_10	xxx	Proportional portion of the cascade controller. 1 ... 99.9
out_par_11	xxx	Tn control parameter of the cascade controller. 0 ... 9999
out_par_12	xxx	Tv control parameter of the cascade controller. 0 ... 999
out_par_13	xxx	Maximum internal temperature of the cascade controller.
out_par_14	xxx	Minimum internal temperature of the cascade controller.
out_par_15	xxx	Band limit (upper) 0 ... 200 °C
out_par_16	xxx	Band limit (lower) 0 ... 200 °C

in commands: Asking for parameters or temperature values to be displayed.

Command	Parameter	Response of recirculating cooler
version	none	Number of software version (V X.xx)
status	none	Status message, error message (see page 72)
in_pv_00	none	Actual bath temperature.
in_pv_01	none	Heating power being used (%).
in_pv_02	none	Temperature value registered by the external Pt100 sensor.
in_pv_03	none	Temperature value registered by the safety sensor.
in_pv_04	none	Setpoint temperature of the excess temperature protection
in_sp_00	none	Working temperature „SETP 1“
in_sp_01	none	Working temperature „SETP 2“
in_sp_02	none	Working temperature „SETP 3“
in_sp_03	none	High temperature warning limit „OVERTEMP“
in_sp_04	none	Low temperature warning limit „SUBTEMP“
in_sp_05	none	Setpoint temperature of the external programmer (REG+E-PROG) .
in_sp_07	none	Adjusted pump stage
in_sp_08	none	Value of a flowrate sensor connected to the E-Prog input
in_par_00	none	Temperature difference between working sensor and safety sensor
in_par_01	none	Te - Time constant of the external bath.
in_par_02	none	Si - Internal slope
in_par_03	none	Ti - Time constant of the internal bath.
in_par_04	none	CoSpeed - Band limit (max. difference between the temperatures in the internal bath and external system).
in_par_05	none	Factor pk/ph0: Ratio of max. cooling capacity versus max. heating capacity
in_par_06	none	Xp control parameter of the internal controller.
in_par_07	none	Tn control parameter of the internal controller.
in_par_08	none	Tv control parameter of the internal controller.
in_par_09	none	Xp control parameter of the cascade controller.
in_par_10	none	Proportional portion of the cascade controller.

Command	Parameter	Response of recirculating cooler
in_par_11	none	Tn control parameter of the cascade controller.
in_par_12	none	Tv control parameter of the cascade controller.
in_par_13	none	Adjusted maximum internal temperature of the cascade controller.
in_par_14	none	Adjusted minimum internal temperature of the cascade controller.
in_par_15	none	Band limit (upper)
in_par_16	none	Band limit (lower)
in_mode_01	none	Selected setpoint: 0 = SETP 1 1 = SETP 2 2 = SETP 3 3 = Last setpoint setting was carried out through an external programmer
in_mode_02	none	Selftuning type: 0 = Selftuning „OFF“ 1 = Selftuning „ONCE“ 2 = Selftuning „ALWAYS“
in_mode_03	none	Type of the external programmer input: 0 = Voltage 0 V to 10 V 1 = Current 0 mA to 20 mA
in_mode_04	none	Internal/external temperature control: 0 = Temperature control with internal sensor. 1 = Temperature control with external Pt100 sensor.
in_mode_05	none	Recirculating cooler in Stop/Start condition: 0 = Stop 1 = Start
in_mode_08	none	Adjusted control dynamics 0 = aperiodic 1 = standard
in_hil_00	none	Max. cooling power (%).
in_hil_01	none	Max. heating power (%).

12.4. Status messages

Status messages	Description
00 MANUAL STOP	Recirculating cooler in „OFF“ state.
01 MANUAL START	Recirculating cooler in keypad control mode.
02 REMOTE STOP	Recirculating cooler in „r OFF“ state.
03 REMOTE START	Recirculating cooler in remote control mode.

12.5. Error messages

Error messages	Description
-01 LOW LEVEL ALARM	Low liquid level alarm or Excess temperature protector alarm
-03 EXCESS TEMPERATURE WARNING	High temperature warning.
-04 LOW TEMPERATURE WARNING	Low temperature warning.
-05 WORKING SENSOR ALARM	Working temperature sensor short-circuited or interrupted.
-06 SENSOR DIFFERENCE ALARM	Sensor difference alarm. Working temperature and safety sensors report a temperature difference of more than 35 K.
-07 I²C-BUS ERROR	Internal error when reading or writing the I ² C bus.
-08 INVALID COMMAND	Invalid command.
-09 COMMAND NOT ALLOWED IN CURRENT OPERATING MODE	Invalid command in current operating mode.
-10 VALUE TOO SMALL	Entered value too small.
-11 VALUE TOO LARGE	Entered value too large.
-12 TEMPERATURE MEASUREMENT ALARM	Error in A/D converter.
-13 WARNING : VALUE EXCEEDS TEMPERATURE LIMITS	Value lies outside the adjusted range for the high and low temperature warning limits. But value is stored.
-14 EXCESS TEMPERATURE PROTECTOR ALARM	Excess temperature protector alarm 
-15 EXTERNAL SENSOR ALARM	External control selected, but external Pt100 sensor not connected.
-33 SAFETY SENSOR ALARM	Excess temperature sensor short-circuited or interrupted.
-38 EXTERNAL SENSOR SETPOINT PROGRAMMING ALARM	Ext. Pt100 sensor input without signal and setpoint programming set to external Pt100.
-40 NIVEAU LEVEL WARNUNG	Low liquid level warning in the internal reservoir.

13. JULABO Service – Online remote diagnosis

JULABO circulators of the HighTech series are equipped with a black box. This box is implemented in the controller and records all significant data for the last 30 minutes.

In case of a failure, this data can be read out from the unit by using special software. This software is available as a **free** download from www.julabo.com\EasyBlackBox.

- Installation is easy and is performed step by step. Please observe the instructions.
- Data read-out is possible in the conditions “OFF”, “R OFF” or “ALARM”.
- Connect the circulator to the computer using an interface cable.
- Start the EasyBlackBox program. The program asks for the port used (COM1,) and the baud rate of the unit. You do not have this information on hand? Simply try it out! The program continues to send the request until the correct settings are made.

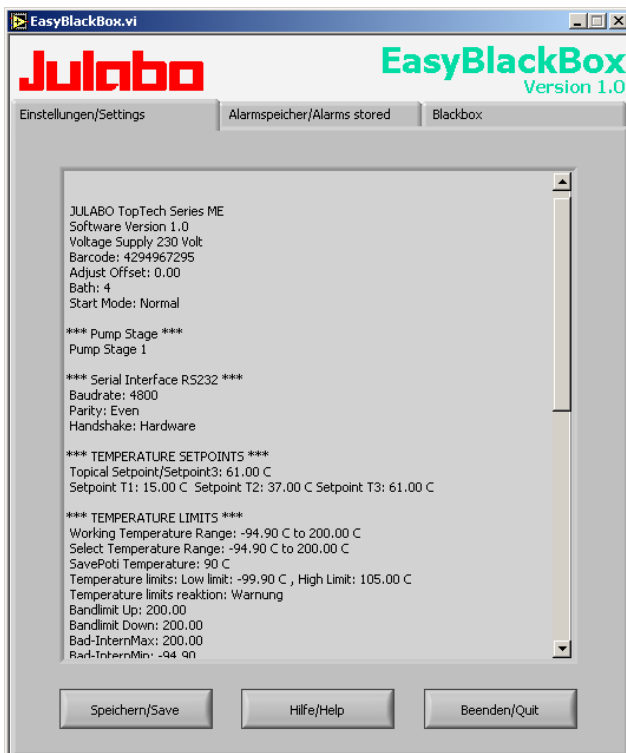

- Data is read out and shown on the monitor divided into the sections >Einstellungen/Settings<, >Alarmspeicher/Alarms stored<, >Blackbox<
- ← see example
- After pressing >Speichern/Save<, a text file is created. The program suggests a filename - >C:\model description and barcode no.<. Modifications are possible.
- E-mail this file to service.de@julabo.com, JULABO's service department. JULABO is thus able to provide rapid support.

14. Cleaning / repairing the unit



Caution:

- Always turn off the unit and disconnect the mains cable from the power source before cleaning the unit.
- Prevent humidity from entering into the circulator.
- Service and repair work may be performed only by authorized electricians.

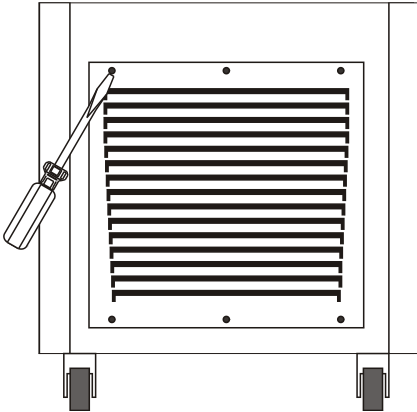

Air cooled recirculating coolers:

To maintain the full cooling performance, clean the condenser from time to time.

- Switch off the unit, disconnect mains power cable.
- Remove the venting grid.
- Clean the ribbed condenser with a vacuum cleaner.
- Replace the venting grid.
- Switch on the unit.

Cleaning:

For cleaning the bath tank and the immersed parts of the recirculating cooler, use low surface tension water (e.g., soap suds). Clean the outside of the unit using a wet cloth and low surface tension water.

The recirculating cooler is designed for continuous operation under normal conditions. Periodic maintenance is not required.

The tank should be filled only with a bath fluid recommended by JULABO. To avoid contamination, it is essential to change the bath fluid from time to time.

Repairs

Before asking for a service technician or returning a JULABO instrument for repair, please contact an authorized JULABO service station.

When returning the unit:

- Clean the unit in order to avoid any harm to the service personnel.
- Attach a short fault description.
- During transport the unit has to stand upright. Mark the packing correspondingly.
- When returning a unit, take care of careful and adequate packing.
- JULABO is not responsible for damages that might occur from insufficient packing.

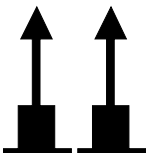

JULABO reserves the right to carry out technical modifications with repairs for providing improved performance of a unit.