



KANOMAX
The Ultimate Measurements

IAQ Monitor

MODEL 2212

User's Manual

List of Components

■ Standard

Item	Model	Qty.	Features
Main Body	2212-00	1	—
Probe	2212-01	1	CO, CO ₂ , Temperature, Humidity Sensor
Carrying Case	2211-02	1	
Probe Stand	2211-03	1	Used to hold and stabilize a probe
Gas Calibration Cap	2211-04	1	Used for gas calibration
Tube	—	1	Used to connect the above gas calibration cap to a calibration gas cylinder
Operation Manual	—	1	—
Manganese AA Batteries	—	6	—
Software CD-ROM	2212-41	1	Data Acquisition Software (for Windows)
RS232C Cable	6000-02	1	Used to connect the instrument and PC

■ Options

Item	Model	Features
ZERO Gas	2211-05	Zero Point Calibration for CO and CO ₂
CO Span Gas	2211-06	CO Span Calibration (Approx. 35ppm)
CO ₂ Span Gas	2211-07	CO ₂ Span Calibration (Approx. 1000ppm)
Gas Valve	2211-08	Valve for the gas cylinders listed above
Spare Probe	2212-01	Spare Probe
Analog Output	2212-09	Analog Output Terminal
AC Adapter	6113-02	Power Supply
Printer (Recommended)	DPU-S245	For printing out calculation results
Printer Cable	6000-03	Printer cable for connecting the instrument with the printer.

Table of Contents

1. Part Names and Functions	1
1.1 Main Body.....	1
1.2 Operation Panel.....	2
1.3 Probe	3
2. Getting Started	4
2.1 Installing Batteries	4
2.2 Connecting Probe.....	5
2.3 Disconnecting Probe	5
2.4 Turning ON/OFF the Power	6
2.5 Precautions for Measurement.....	7
2.5.1 CO and CO ₂ Measurement Precautions	7
2.5.2 Temperature Measurement Precautions	8
2.5.3 Humidity Measurement Precautions	8
3. Measurement (NORMAL MODE)	9
3.1 Changing the Measurement Mode	9
3.2 Hold the Reading	10
4. Measuring MAX, AVG and MIN Value (CALUCULATION MODE)	11
5. Measuring Percent Outdoor Air (%OA MODE)	14
6. Data Output	18
6.1 Stored Data Item	18
6.2 To Redisplay Stored Data	18
6.3 Printing out Measurement Data	20
6.3.1 Preparation for Print Out.....	20
6.3.2 Printing from the NORMAL (Measurement) Mode	20
6.3.3 Printing from CALCULATION mode.....	21
6.3.4 Printing from %OA (Percent Outdoor Air) mode	21
6.3.5 Printing out Stored Data.....	22
6.4 Digital Output	24
6.4.1 Preparation for Digital Output	24
6.5 Entering Commands from PC to Output Data	25
6.5.1 Transmission of Raw Data (data measured every 1 sec).....	25
6.5.2 Transmission of Stored Data (data stored in memory).....	26
6.6 Analog Output (Optional)	27

7. Other Settings	29
7.1 Changing Date and Time	29
7.2 Changing Measurement Unit and Baud Rate.....	30
7.3 Deleting Data	31
7.3.1 To Delete Certain Pages of Data.....	31
7.3.2 To Delete All Data	32
7.4 Contrast Adjustment	33
8. Calibrating CO/CO₂ Sensor	34
8.1 Preparation for Calibration.....	34
8.2 Calibration Procedure – ZERO Calibration.....	35
8.3 Calibration Procedure – SPAN Calibration	38
9. Specifications	41
10. Calculation Result: DT, WB, AH and HR.....	42
10.1 What is DT?	42
10.2 What is WB?	42
10.3 What is AH?.....	43
10.4 What is HR?.....	43
11. Troubleshooting.....	44
11.1 Battery Check.....	44
11.2 Initial Operation Check.....	44
11.3 Check While Measuring.....	44
11.4 Printer Check.....	44
11.5 Digital Output Check	45
11.6 Analog Output Check.....	45
11.7 Calibration Check	45
12. Warranty and After-sales Service	46
13. Contact Information	48

1. Part Names and Functions

1.1 Main Body

Unit: mm

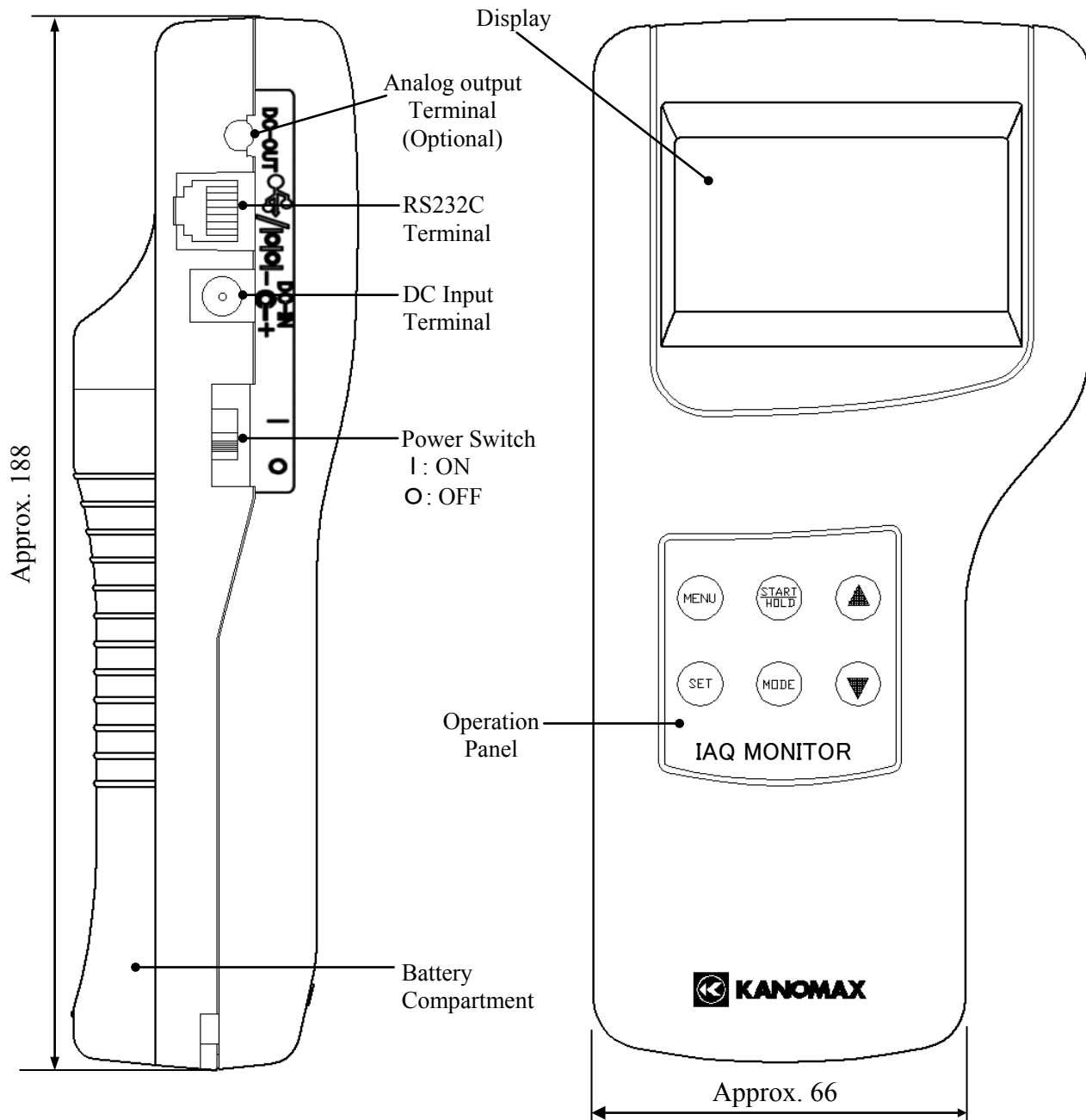
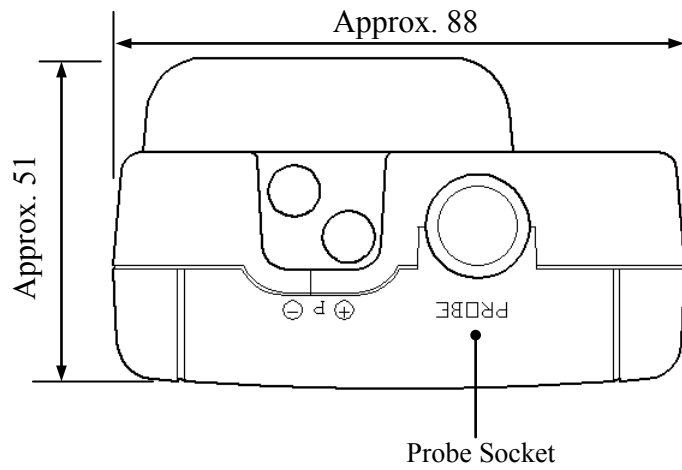

1.2 Operation Panel

MENU KEY

Press once to access the MENU screen to select the desired feature.

* If pressing this key while measuring or configuring the settings, whatever the operation being conducted will be cancelled and you will go back to the MENU screen.

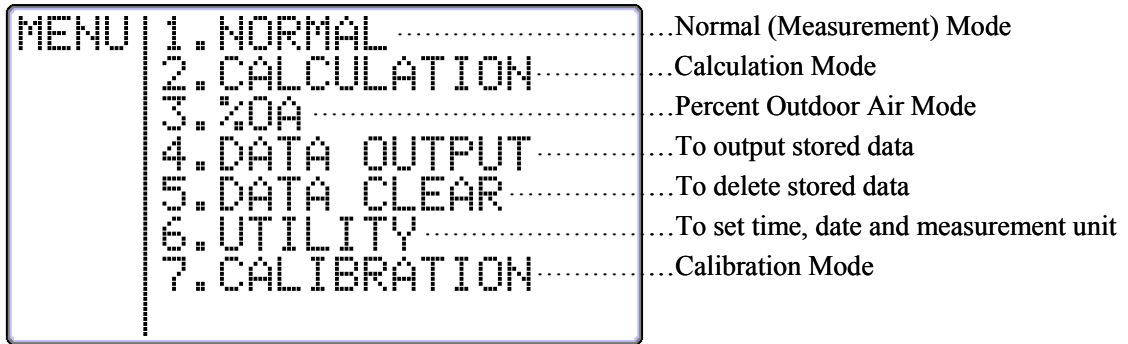

START/HOLD KEY

- To start and stop calculation and/or measurement.
- To put displayed reading on hold, and press this key again to release hold.

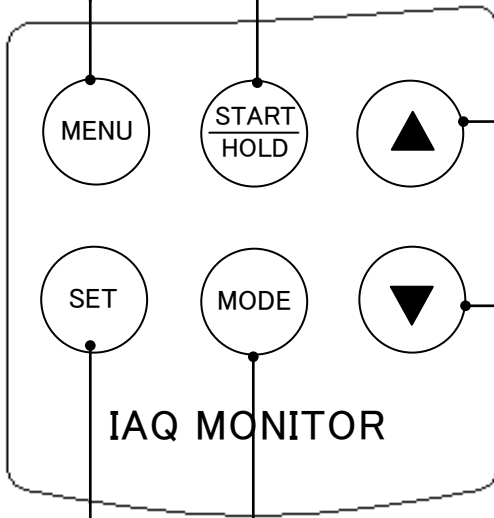

▲,▼ NAVIGATION KEY

1. In the Normal (Measurement) Mode, this key is used to change the display item relating to humidity. (See P.9)

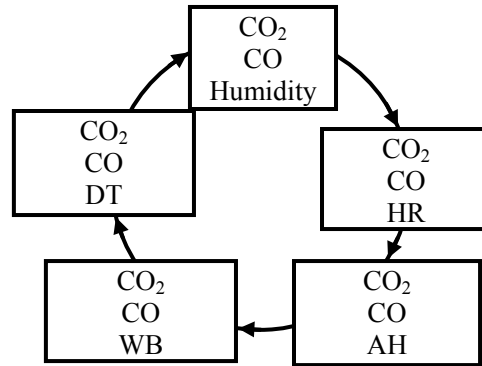

SET KEY

To execute the selected item.

2. In the MENU screen, this key is used to select a desired item or to set a numeric value.

MODE KEY

To change measurement mode between temperature and humidity.

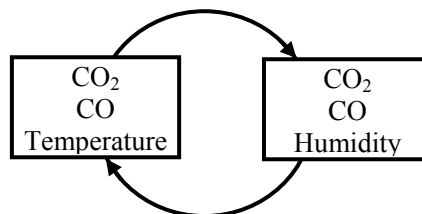

1.3 Probe

Unit: mm

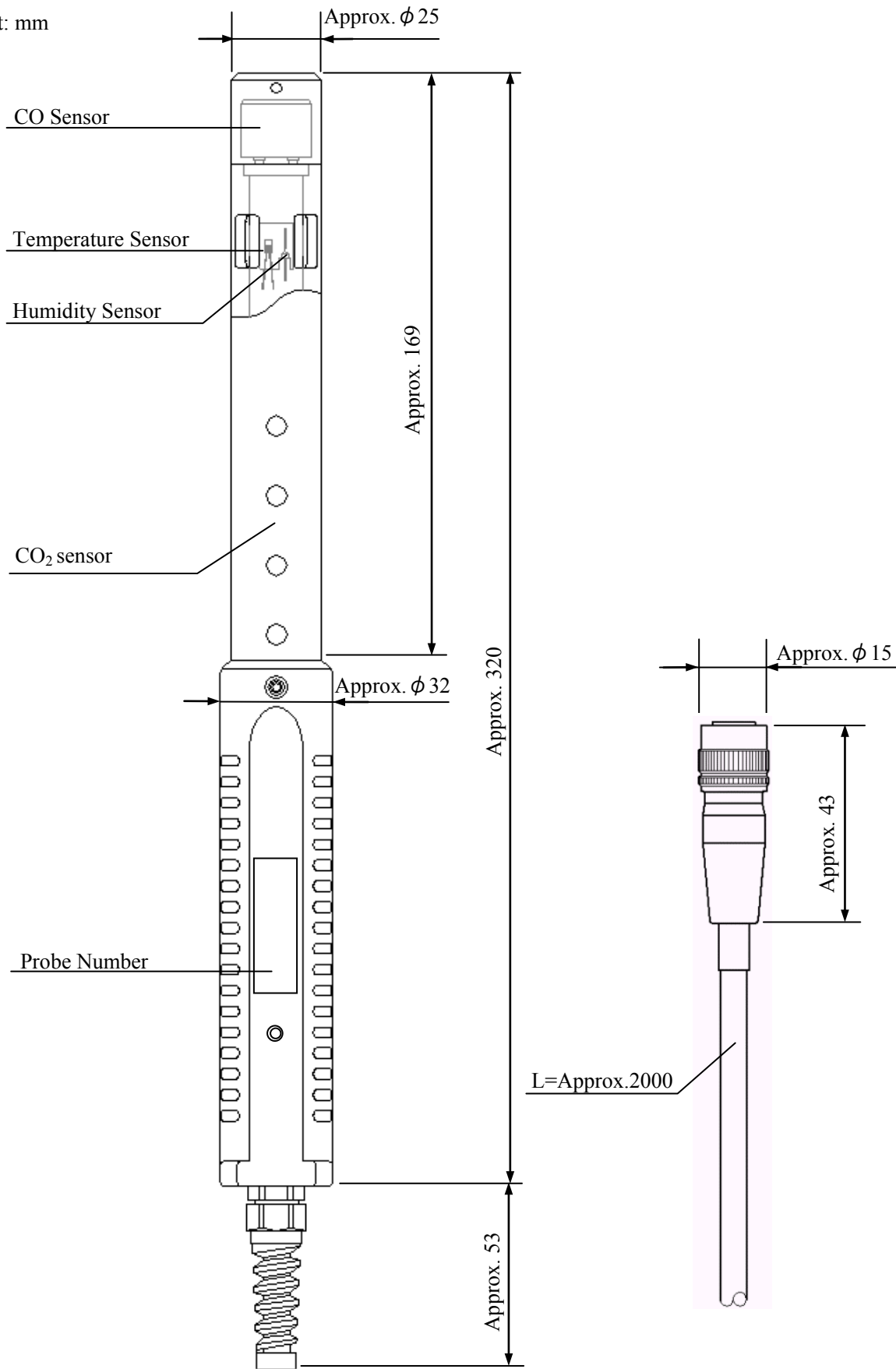

2. Getting Started

2.1 Installing Batteries

Backside of the instrument

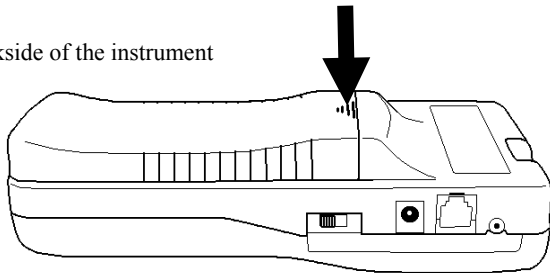

1. Press down the battery cover with your finger as shown left.

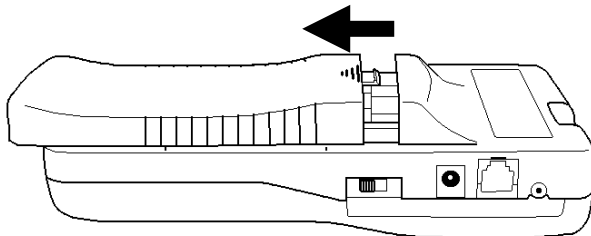

2. Slide the cover toward the bottom of the instrument.

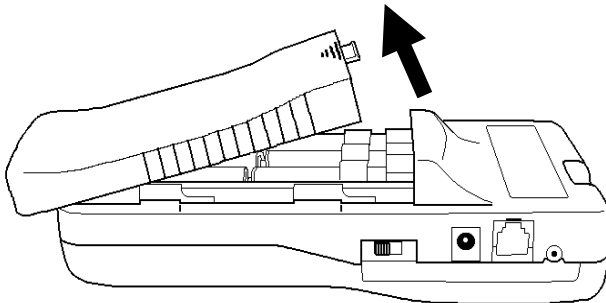

3. Lift the cover away from the instrument.

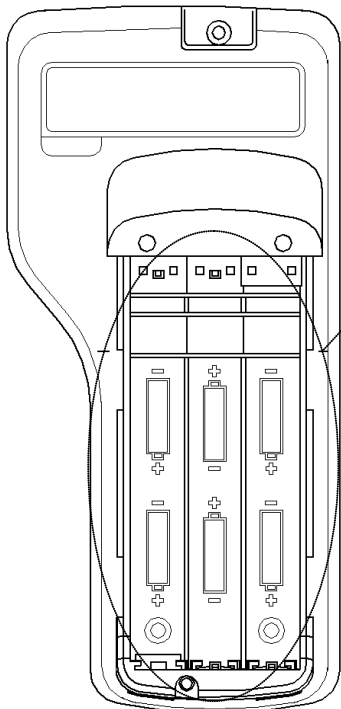

Types of batteries that can be used

- Manganese (R6), AA batteries
- Alkaline (LR6), AA batteries
- Ni-Cd, AA batteries

4. Insert batteries ensuring the battery polarity is correct. This instrument requires six (6) AA size batteries. Types of batteries that can be used are: **Manganese (R6), Alkaline (LR6) or Ni-Cd batteries.**

The six (6) batteries must be of the same type. Do NOT mix different types of batteries. Mixing different types of batteries or incorrect battery polarity may cause battery leakage or damage to the instrument.

* Batteries CANNOT be recharged by the (optional) AC adapter.

5. Put the cover back on by reversing the above procedure.

2.2 Connecting Probe

CAUTION
 * **Make sure that the power is OFF when connecting or disconnecting the probe.**

1. Put the probe's connector on the main body's probe socket.
2. Push the connector in until you hear a click.

CAUTION
 * **DO NOT squeeze the probe into the main body or twist the probe when it is attached, as it may cause a serious damage to the instrument.**

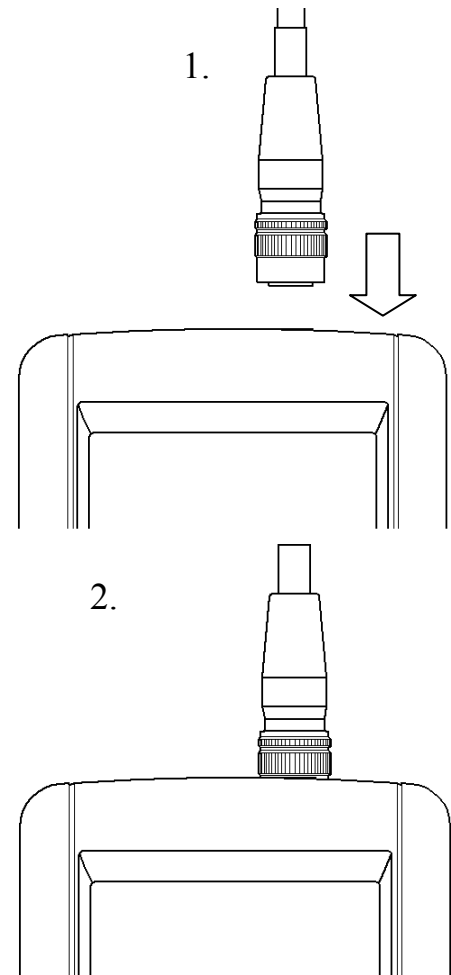
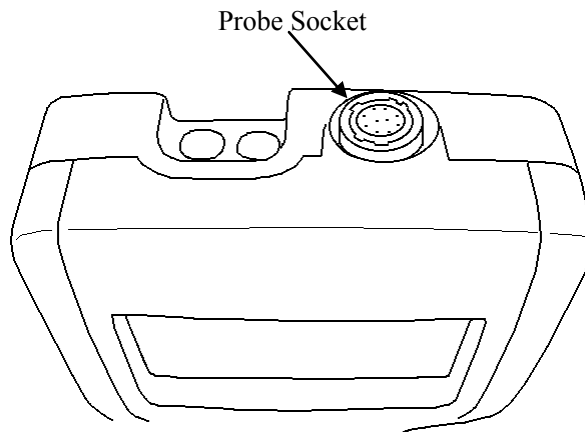

2.3 Disconnecting Probe

CAUTION
 * **Make sure that the power is OFF when connecting or disconnecting the probe.**

1. Pull up the probe's connector (See chart 1-A).
2. Pull out the connector from the main body with the connector up (See below chart 2).

CAUTION
 * **DO NOT twist the probe when it is connected, as it may cause a serious damage to the instrument.**

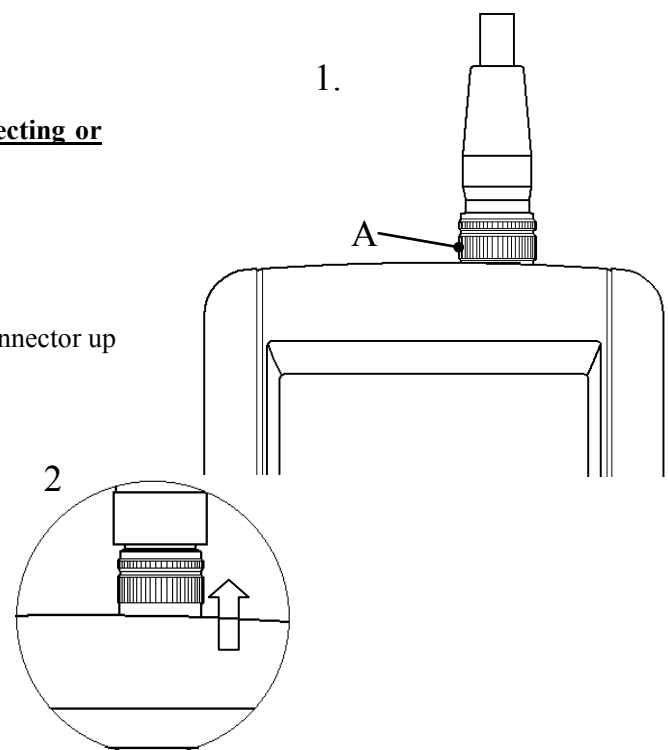

2.4 Turning ON/OFF the Power

The power switch for turning ON/OFF the instrument is located at the side of the instrument. When powered up after a probe is connected, the KANOMAX logo, its model name and software version will be displayed for a few seconds before the measurement mode screen shows up.

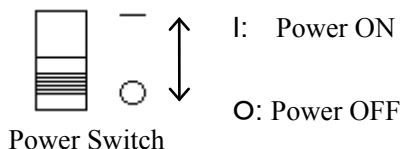

NO PROBE !

CONNECTING PROBE
AND RESTART !

The above warning will be displayed when a probe is not properly connected or not connected at all. If this warning shows up, turn off the instrument and check if a probe is connected properly.

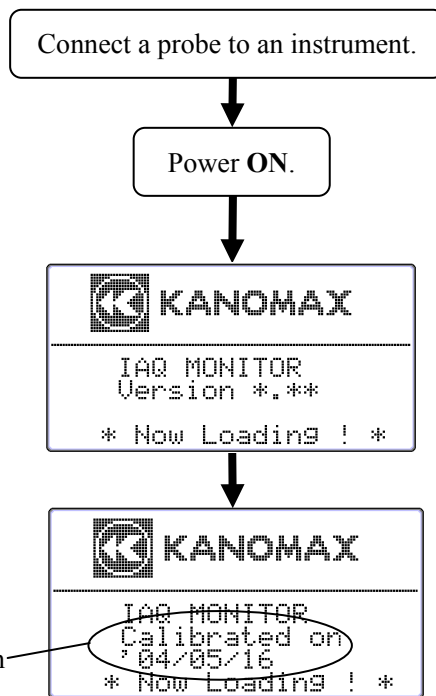

User Calibration Date

Display Icons: (NORMAL Mode: For more details, see P.9)

- | | |
|----------------------------------|----------------------------|
| 1. Date and Time | 4. Temperature (Humidity) |
| 2. CO ₂ Concentration | 5. Battery Level Indicator |
| 3. CO Concentration | |

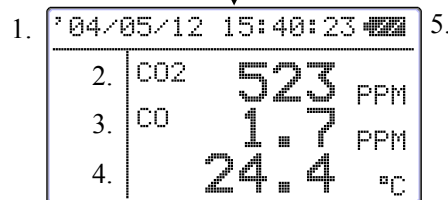

Measurement Screen (NORMAL Mode)

Battery Level Indicator

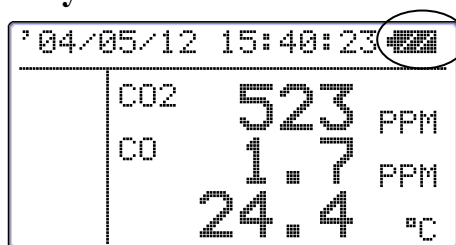

Check the “Battery Level Indicator” in the upper right corner to confirm the remaining battery level. When the battery level drops to a level requiring replacement, the indicator starts blinking. Since each battery has different battery life, it is recommended to replace them ahead.

The below shows how the indicator changes as the batteries are running low:

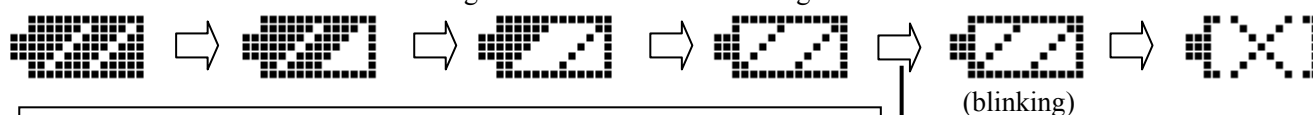

(blinking)

Time to replace batteries

--LOCK--

When [X] is displayed, the instrument will become inoperable even in the middle of measurement. Also please note that the measurement data will NOT be saved in this situation.

2.5 Precautions for Measurement

2.5.1 CO and CO₂ Measurement Precautions

- ◆ Air diffusion condition (flow condition) affects the response time of CO and CO₂ sensor. In order to obtain an accurate measurement result, perform a measurement in the place which has the flow of air as much as possible.
- ◆ Mechanism of CO and CO₂ sensor has a limitation in accuracy when a measurement takes place under drastic thermal change. When the sensor and the measuring object have apparent thermal discrepancy, leave the probe in open air for at least 20 minutes before starting a measurement.
- ◆ After turning the power ON, sensor circuit requires some time to stabilize a detecting circuit. For an accurate measurement result, leave the instrument for about 5 minutes after turning the power ON.
- ◆ Keep this sensor away from expiratory air; exhaled air contains more than 10,000ppm of CO₂ and exhaled air of smokers contains several ppm of CO. In order to perform an accurate measurement it is recommended to use the provided probe stand and to place the probe away from you while measuring.

<How to use the Probe Stand>

Lightly push the grip part of the probe into the probe stand's holder as shown in the below figure 1.

- * Make sure to place the probe stand on a stable flat surface. Placing the probe on an unstable surface may cause the probe stand to fall and damage the probe.

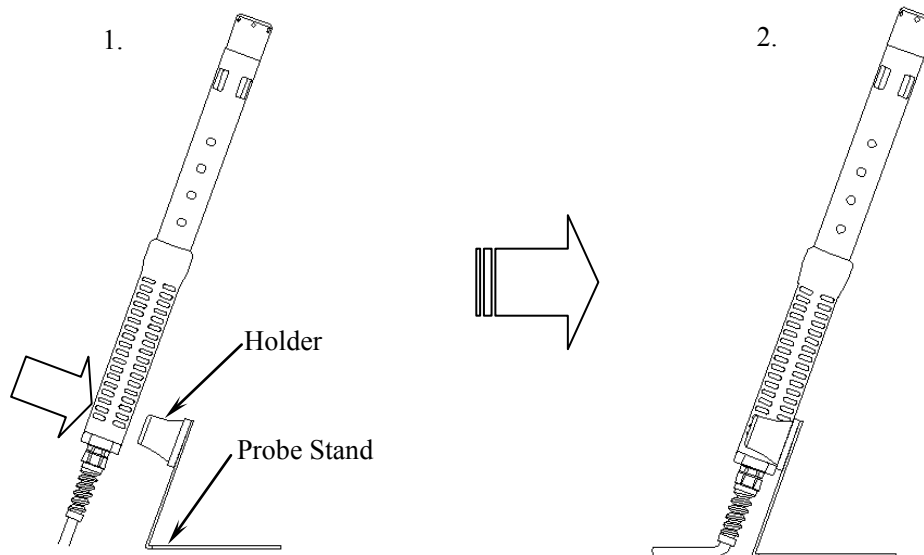

<Precaution for Storing the Main Unit and Probe>

- * Our CO detection sensor inside the probe uses an electrochemical sensor. As this sensor uses electrochemical reaction, it reacts to not only CO but also the similar types of gas. If the sensor is used or stored in an environment containing organic solvents, paint, medical agents, oil or corrosive gas, the CO sensor will show an abnormal reaction causing zero-point drift, sensitivity variations or damage to the sensor.
- ◆ Typical Reactive Gas
Hydrogen Sulfide, Sulphur Dioxide, Nitric Oxide, Nitrogen Dioxide, Chlorine, Hydrogen and Ethanol



CAUTION

- * **DO NOT use or store the instrument in the environment containing organic solvents, paint, medical agents, oil or corrosive gas.**

<Atmospheric Pressure Correction>

- ◆ When atmospheric pressure at a measuring site is abnormal (such as at high altitude), follow steps below to set atmospheric pressure (default setting: 1013hPa).
- ◆ Since the change of weather does not significantly affect the atmospheric pressure as long as the measuring site is same (excluding the case of typhoon), once you set atmospheric pressure, you do not need to set it every time.

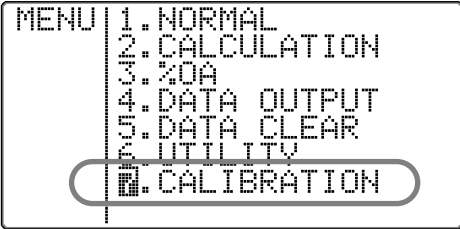
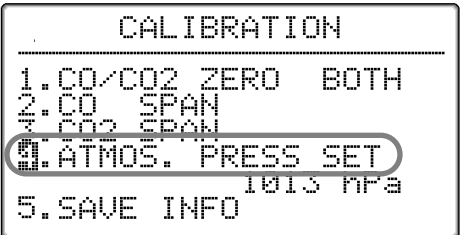
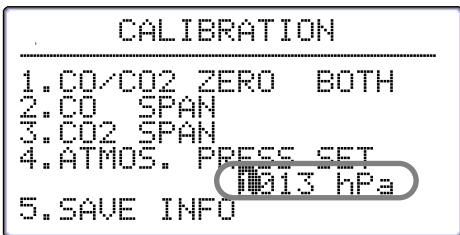
Display	Procedure
 <pre> MENU 1.NORMAL 2.CALCULATION 3.ZOA 4.DATA OUTPUT 5.DATA CLEAR 6.UTILITY 7.CALIBRATION </pre>	<p>Press MENU key to bring up the MENU screen.</p> <p>Use ▼▲ key to select “7.CALIBRATION”, and press SET key.</p>
 <pre> CALIBRATION ----- 1.CO/CO2 ZERO BOTH 2.CO SPAN 3.CO2 SPAN 4.ATMOS. PRESS SET 5.SAVE INFO </pre>	<p>Use ▼▲ key to select “4. ATMOS. PRESS SET”, and press SET key.</p>
 <pre> CALIBRATION ----- 1.CO/CO2 ZERO BOTH 2.CO SPAN 3.CO2 SPAN 4.ATMOS. PRESS SET 5.SAVE INFO </pre>	<p>Use ▼▲ key to set atmospheric pressure value, and press SET key.</p> <p>Use ▼▲ key to select “5. SAVE INFO”, and press SET key to go back to the MENU screen and the setting is completed.</p>

2.5.2 Temperature Measurement Precautions

- ◆ The response time for temperature measurement improves as the air flow increases. Wait for the reading to become stable before taking the data.
- ◆ When a measurement is performed in a no-airflow condition, the air temperature reading may become higher than the actual due to the heat generated by the lamp. It is recommended that the measurement is performed in an environment with at least 0.1m/s airflow to obtain accurate readings.

2.5.3 Humidity Measurement Precautions

- ◆ If a measurement is performed in the place where the humidity is high for a long period of time or temperature changes rapidly, humidity reading may become exceedingly high due to dew condensation. When dew condensation is built up, leave the probe in the atmosphere of less than 40%RH for 24 hours to dry it out.

-- Comparison with Assman Aspiration Psychrometer --

The quality and accuracy of IAQ Monitor’s humidity measurement function is ensured by strict calibration with traceability in Japanese National Standards of JEMIC (Japan Electric Meters Inspection Corporation). This instrument provides stable measurement as an electronic hygrometer, so it can be used as Assman Aspiration Psychrometer. Assman Psychrometer sometimes reads higher humidity comparing to the IAQ Monitor since handling methods such as how to wrap the wet bulb by gauze or how to handle the dirt affect Assman Psychrometer. Assman Psychrometer shall be handled with care. For more details on handling Assman Psychrometer, refer to the Japanese Industrial Standard (JIS) Z 8806 Humidity - Measurement Method.

3. Measurement (NORMAL MODE)



This is the mode that you will see when you turn on the instrument.
In this mode you cannot store any data.

Any displayed readings are updated every 1 second.



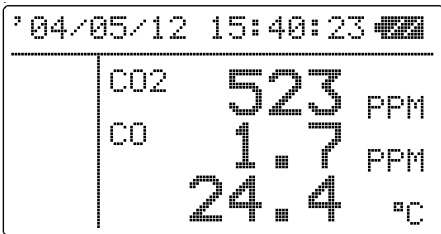
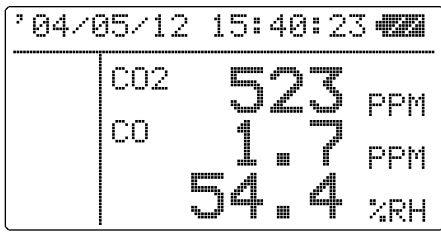
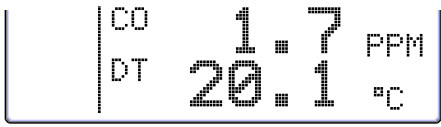
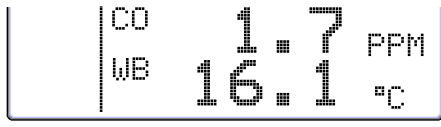

To move to NORMAL Mode from other measurement mode,
press **MENU** key to bring up the MENU screen,
select "1. NORMAL" and press **SET** key.

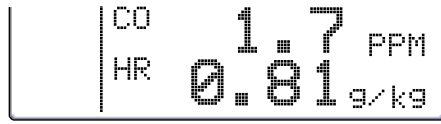
```
MENU 1. NORMAL
      2. CALCULATION
      3. %O2
      4. DATA OUTPUT
      5. DATA CLEAR
      6. UTILITY
      7. CALIBRATION
```



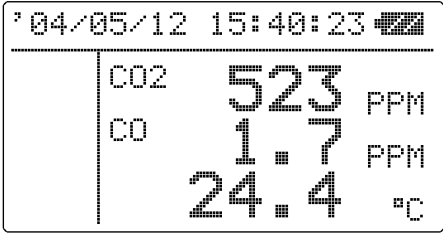

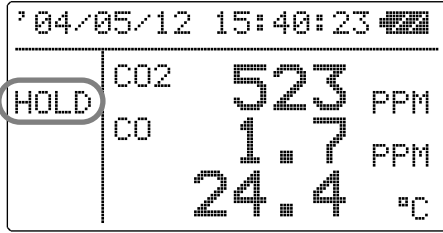

3.1 Changing the Measurement Mode

Display	Procedure
1. 	Press MODE key when the NORMAL (Measurement) mode screen shown in the left is displayed. As MODE key is pressed, the measurement mode will be switched between 2. (CO ₂ , CO, Temperature) → 1. (CO ₂ , CO, Humidity).
2. 	<CO ₂ , CO and Humidity Measurement Screen> Press ▼ ▲ key when the screen in the left is displayed to change the humidity related display mode in the sequence of Humidity, 3. Dew-point Temperature [DT], 4. Wet-bulb Temperature [WB], 5. Absolute Humidity [AH] and 6. Humidity Ratio [HR]. See P.42 for detailed information on each item.
3. 	<Dew-point Temperature Measurement Screen>
4. 	<Wet-bulb Temperature Measurement Screen>
5. 	<Absolute Humidity Measurement Screen>
6. 	<Humidity Ratio Measurement Screen>

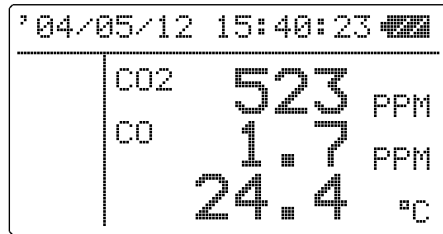
3.2 Hold the Reading

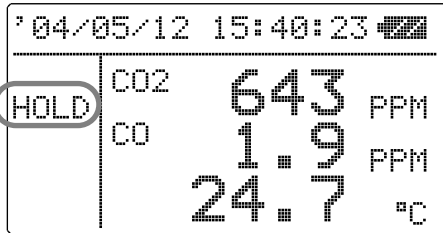
Display	Procedure
	<p>When the NORMAL (Measurement) mode screen is displayed, press  key (also available on Humidity measurement mode).</p>
	<p>“HOLD” indicator appears on the left side of the display to indicate that the reading shown is kept on hold on the display. Press  key again to recover from the HOLD mode.</p>

Maximum Value Hold How to Hold the Maximum Value

Display	Procedure
	<p>When the NORMAL (Measurement) mode screen is displayed, keep pressing  key.</p>
	<p>While  is being pressed, “HOLD” indicator keeps appearing on the left side of the display and the maximum values of each parameter (CO, CO₂, Humidity or Temperature) are shown on the screen. Release  key to keep the maximum value on hold on the display. Press  again to recover from the HOLD mode.</p>

4. Measuring MAX, AVG and MIN Value (CALUCULATION MODE)

In Calculation Mode measurement data is stored and maximum, mean and minimum values will be calculated.

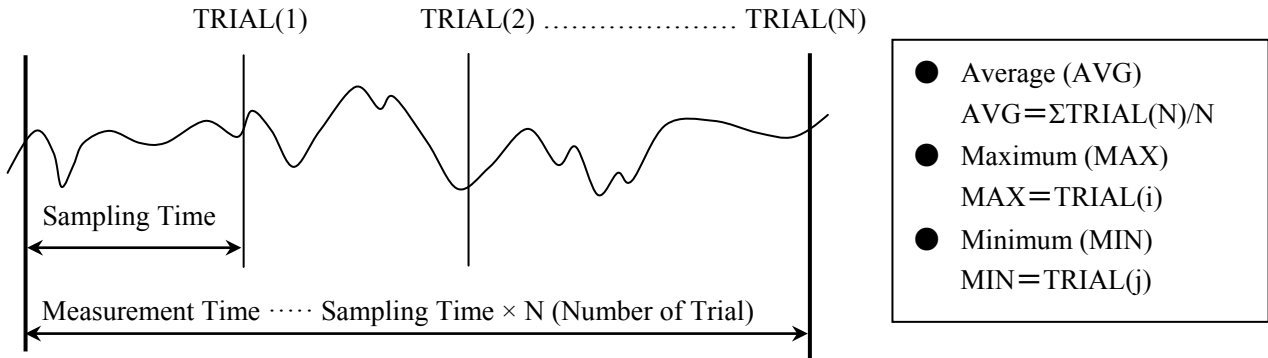

Display	Procedure
---------	-----------

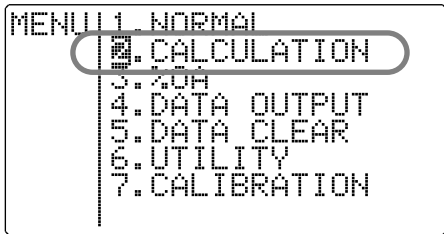

Press **(MENU)** key to bring up the MENU screen.
 Use **(▼)** **(▲)** key to select "2. CALCULATION" and press **(SET)** key.

CALCULATION MODE SETTING SCREEN

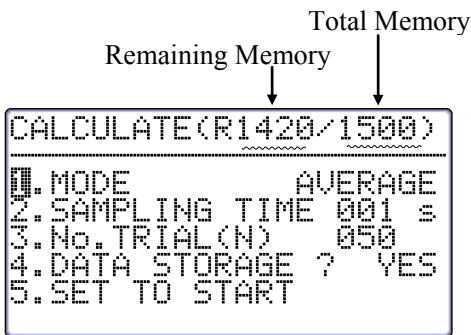

1. CALCULATION MODE

AVERAGE: Average every second's data during sampling time, and make it as one measurement data.

INSTANT: Make an instantaneous value per each sampling time as one measurement data.

2. SAMPLING TIME (1 ~ 999 sec.)

Set the length of sampling time.





























3. No. TRIAL (1 ~ 999)

Set how many data to read every sampling time that has been set.

4. DATA STORAGE (YES or NO)

5. SET TO START

Save the setting and return to the standby screen.

Display	Procedure
<pre> CALCULATE(R1500/1500) 1.MODE AVERAGE 2.SAMPLING TIME 001 s 3.No. TRIAL(N) 050 4.DATA STORAGE ? YES 5.SET TO START </pre>	<p><To set CALCULATION MODE></p> <p>Use   key to select “1. MODE”, and press  key.</p> <p>Use   key to select either “AVERAGE” or “INSTANT” and press  key.</p>
<pre> CALCULATE(R1500/1500) 1.MODE AVERAGE 2.SAMPLING TIME 001 s 3.No. TRIAL(N) 050 4.DATA STORAGE ? YES 5.SET TO START </pre>	<p><To set SAMPLING TIME></p> <p>Use   key to select “2. SAMPLING TIME”, and press  key.</p> <p>Use   key to set SAMPLING TIME (1-999sec) and press  key.</p>
<pre> CALCULATE(R1500/1500) 1.MODE AVERAGE 2.SAMPLING TIME 001 s 3.No. TRIAL(N) 045 4.DATA STORAGE ? YES 5.SET TO START </pre>	<p><To set the number of measurement data></p> <p>Use   key to select “3. No. TRIAL (N)”, and press  key.</p> <p>Use   key to set the number of TRIALS (1-999 times) and press  key.</p> <p>Data for the number of TRIALS set here will be saved as raw data.</p>
<pre> CALCULATE(R1500/1500) 1.MODE AVERAGE 2.SAMPLING TIME 001 s 3.No. TRIAL(N) 050 4.DATA STORAGE ? YES 5.SET TO START </pre>	<p><DATA STORAGE YES/NO></p> <p>Use   key to select “4. DATA STORAGE ?”, and press  key.</p> <p>Use   key to select YES or NO and press  key.</p> <p>* You CANNOT store more than what is left in the memory. If you set the number more than the number of remaining data locations, it automatically adjusts to the amount of remaining memory. (For example, if the remaining memory is R0020/1500, you can only measure 20 times at the most.)</p>
<pre> CALCULATE(R1500/1500) 1.MODE AVERAGE 2.SAMPLING TIME 001 s 3.No. TRIAL(N) 050 4.DATA STORAGE ? YES 5.SET TO START </pre>	<p><To save the settings></p> <p>Use   key to select “5. SET TO START”, and press  key. (The display shown in the left indicates that it takes 50 measurements every 1 second (50 seconds in total).)</p>
<pre> '04/05/12 15:40:23 RDY. CO2 523 PPM N 1 CO 1.7 PPM / 50 24.4 °C </pre>	<p><Standby Screen></p> <p>This is a standby screen before measurement starts. Press  key to start measuring.</p>

Display

*04/05/12 15:44:13			
SMP.	CO2	583	PPM
N 3	CO	1.9	PPM
/ 50		24.5	°C

Procedure

<While Measuring>

Press **START HOLD** key to stop measuring.

(If “YES” is selected for “4. DATA STORAGE ?”, the measured data will be stored.)

You can also stop measuring by pressing **MENU** key. However, any measured data will not be stored.

CALCULATION

MAX	CO2	598	PPM
AVG	CO2	557	PPM
MIN	CO2	523	PPM

<Calculation Result Display>

After all the measurements are finished, the calculation result will be displayed.

Use **▼▲** key to check each parameter in the sequence of CO₂ -> CO -> Temperature -> Humidity -> Dew-point Temperature (DT) -> Wet-bulb Temperature (WB) -> Absolute Humidity (AH) -> Humidity Ratio (HR).

CALCULATION

	DT	22.8	°C
	WB	23.7	°C
	AH	35.3	g/m ³

As for Dew-point Temperature, Wet-bulb Temperature, Absolute Humidity, and Humidity Ratio, only average values will be displayed.

Press **MENU** key to return to the MENU screen. Calculation data will be stored when “4.DATA STORAGE” is set to “YES”.

Related Functions:

- If a printer is connected: press **MODE** key to print out calculation result.
- To redisplay stored data -- P.18
- To print out measured data -- P.20
- What is DT, WB, AH, HR? -- P42

5. Measuring Percent Outdoor Air (%OA MODE)

%OA MODE is a measurement mode to calculate Percent Outdoor Air either with temperature or CO₂.

The calculation is based on below formula:

$$\%OA = (R_A - S_A) / (R_A - O_A) \times 100$$

* %OA: Percent Outdoor Air

R_A: Temperature or CO₂ concentration of Return Air

S_A: Temperature or CO₂ concentration of Supply Air

O_A: Temperature or CO₂ concentration of Outdoor Air

A measurement takes place in the following sequence;

Return Air -> Supply Air -> Outdoor Air

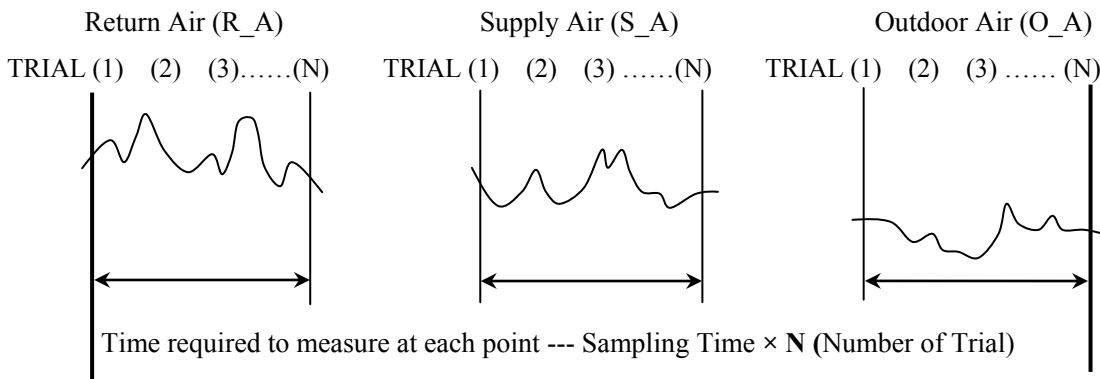
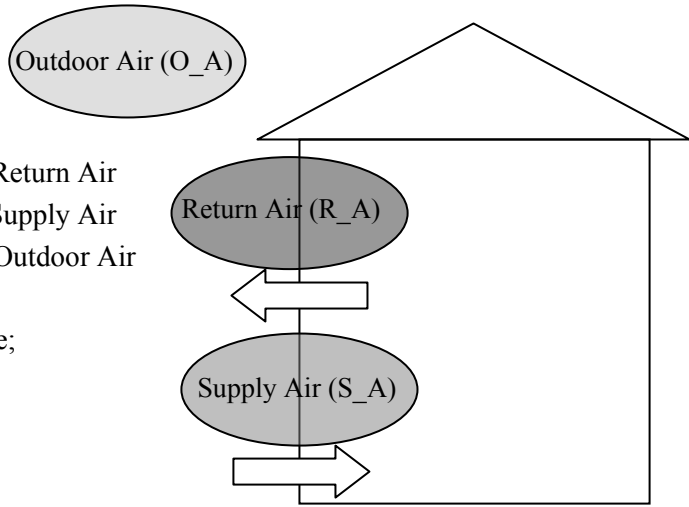

Return Air : $R_A = \sum TRIAL(N) / N$
 Supply Air : $S_A = \sum TRIAL(N) / N$
 Outdoor Air : $O_A = \sum TRIAL(N) / N$



<Calculation Result>
 * Percent Outdoor Air (%OA)
 $\%OA = (R_A - S_A) / (R_A - O_A) \times 100$

Average value in each point is used to calculate percent outdoor air.

Temperature or CO₂ concentration data at each point (TRIAL(1) ~ TRIAL(N)) will be also stored in the memory.

Display	Procedure
---------	-----------

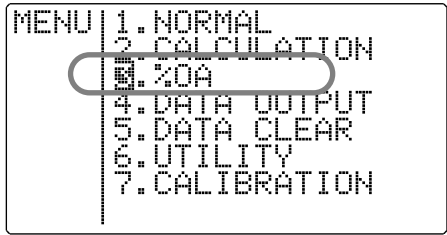

Press **(MENU)** key to bring up the MENU screen.

Use **(▼)****(▲)** key to select “3. %OA”, and press **(SET)** key.



<To set SAMPLING TIME >

Use **(▼)****(▲)** key to select “1.MODE”, and press **(SET)** key.

Use **(▼)****(▲)** key to select “TMP.” or “CO2”, and press **(SET)** key.

PERCENT OUTDOOR AIR (%OA) MEASUREMENT MODE SETTING SCREEN

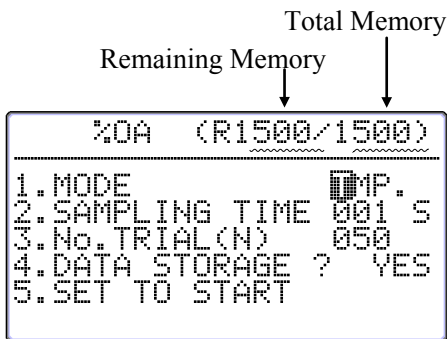

- 1. CALCULATION MODE**
TMP.: To read temperature value and perform calculation.
CO2: To read CO₂ concentration value and perform calculation.
- 2. SAMPLING TIME (1-999 sec.)**
 Set the length of sampling time/
 (instantaneous value).
- 3. No. TRIAL(N) (1-999 times)**
 Set how many data to read every sampling time that has been set.
- 4. DATA STORAGE (YES/NO)**
- 5. SET TO START**
 Save the setting and return to the standby screen.

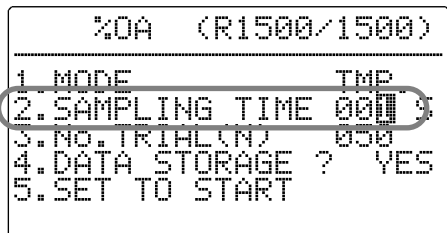

<To set SAMPLING TIME>

Use **(▼)****(▲)** key to select “2.SAMPLING TIME”, and press **(SET)** key.

Use **(▼)****(▲)** key to set sampling time (1-999sec), and press **(SET)** key.

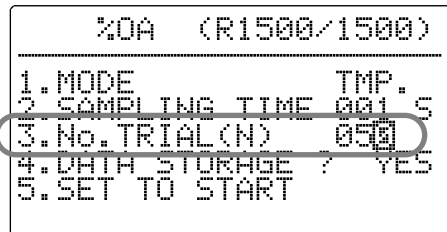

<To set Number of Trials>

Use **(▼)****(▲)** key to select “3.No.TRIAL”, and press **(SET)** key.

Use **(▼)****(▲)** key to select the number of trials (1-999 times), and press **(SET)** key.

Display

Procedure



<DATA STORAGE>

Use key to select “4.DATA STORAGE ?”, and press key.

Use key to select “YES” or “NO” for data storage, and press key.



<To save the settings>

Use key to select “5.SET TO START”, and press key.

* If pressing key before completing the settings, you will return to the MENU screen without that the changes are saved.

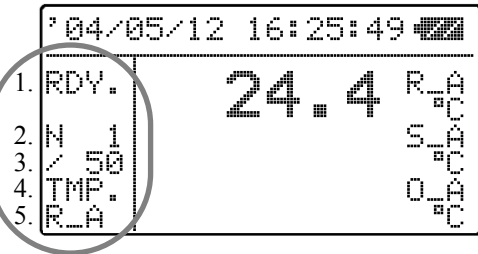

<Standby Screen>

This is a standby screen before a measurement starts.

Press key to start measuring.

Display Icons:

- 1. RDY.: Current Status (READY/SAMPLE)
- 2. N 1: Current number of data measured
- 3. / 50: Total number of data to be measured according to the setting.
- 4. TMP.: Indicates that temperature value will be read to perform calculations.
(When CO₂ Mode is selected, “CO₂” will be displayed.)
- 5. R_A: Displays what measuring point will be used.
(R_A: Return Air, S_A: Supply Air, O_A: Outdoor Air).

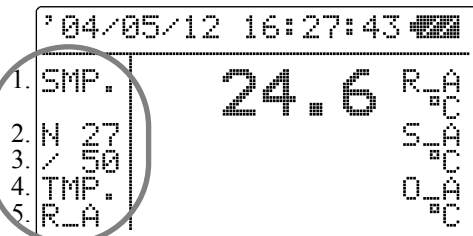

<While Measuring>

Press key to pause measuring, and press key again to resume.

* You can stop measuring by pressing key. However, any measured data will not be saved.

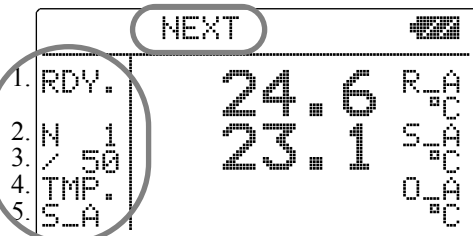

<Waiting for the next measurement point>

After Return Air (R_A) measurement is completed, “NEXT” will show up at the top to indicate that it is waiting for the next Supply Air (S_A) measurement to be started.

After that, Supply Air (S_A) measurement and Outdoor Air (O_A) measurement will be performed respectively.

Display

Procedure

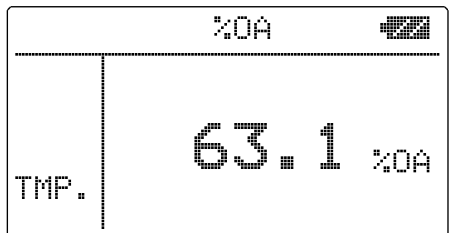

<Calculation Result>

After all the measurements are finished, the calculation result will be displayed.

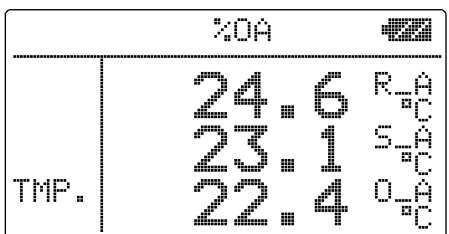

Press  key to display average values of Return Air (R_A), Supply Air (S_A), and Outdoor Air (O_A) at each point.

Press  key to return to the MENU screen.

When "YES" is selected for "DATA STORAGE", the calculation result will be stored.

Related Functions:

- When printer is connected, press  key to print out the calculation result.
- To redisplay stored data – P.18
- To print out measured data – P.20

6. Data Output

6.1 Stored Data Item

The measurement data that can be stored in the instrument in the each measurement mode and measurement screen is listed in the table below.

Measurement Mode	Measurement Display	Stored Parameters
CALCULATION Mode (CALCULATION)	All measurement display	CO ₂ , CO, Temperature, Humidity (including all items related to humidity)
Percent Outdoor Air Measurement Mode (%OA mode)	Temperature.	%OA, Temperature of R_A, S_A, and O_A
	CO ₂	%OA, CO ₂ concentration of R_A, S_A, and O_A

6.2 To Redisplay Stored Data

Display	Procedure
---------	-----------

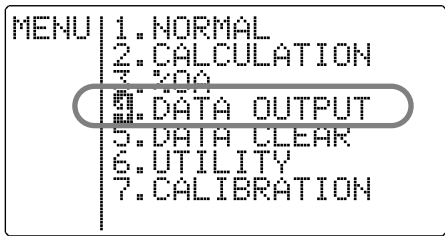

Press **(MENU)** key to bring up the MENU screen.
 Use **(▼)****(▲)** key to select “4.DATA OUTPUT”, and press **(SET)** key.

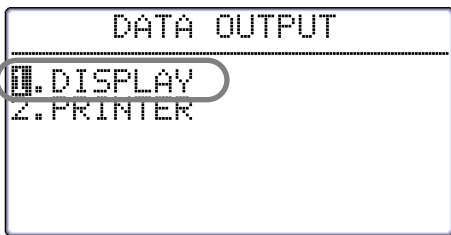

Use **(▼)****(▲)** key to select “1.DISPLAY”, and press **(SET)** key.

<To set page>

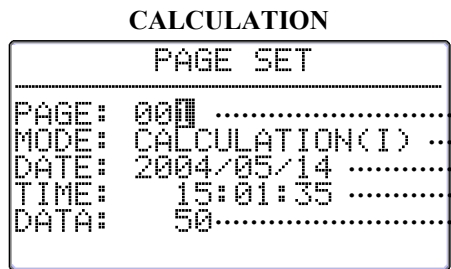

Use **(▼)****(▲)** key to select the page that you want to display, and press **(SET)** key.

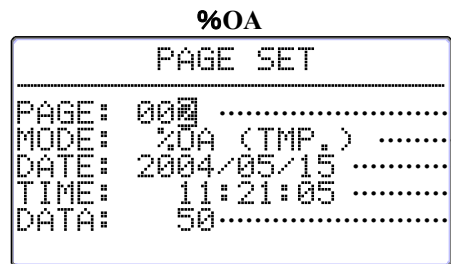

.....Page number to be output
Measurement Mode (Calculation (A): AVERAGE / (I): INSTANT)
Measurement Date (Year/Month/Day)
Measurement Time (Hour/Minute/Second)
Number of Trial in the selected page

.....Page number to be output
Measurement Mode (%OA (TMP.): Temperature or (CO2): CO₂)
Measurement Date (Year/Month/Day)
Measurement Time (Hour/Minute/Second)
Number of Trial in the selected page

Display	Procedure
---------	-----------

CALCULATION

START:001		END:050	
NUM.	CO2PPM	CO	Temp
001	1003	1.1	23.5
002	1001	1.1	23.5
003	1005	1.1	23.6
004	1003	1.0	23.6
005	1006	1.0	23.6
006	1009	1.0	23.6

Data No. CO₂ CO Temp.

<Measurement data display screen>

Measurement data of the specified page will be displayed.

Use key to scroll the data.

When a measurement is performed in the CALCULATION mode, press key to switch to display between Temperature and Humidity.

%OA (Temperature)

START:001		END:050	
NUM.	CR_A	CS_A	CO_A
001	23.4	22.7	22.5
002	23.4	22.8	22.5
003	23.5	22.7	22.6
004	23.5	22.8	22.6
005	23.5	22.7	22.6
006	23.4	22.8	22.6

Data No. Return Air Temp. Supply Air Temp. Outdoor Air Temp.

<To display calculation result>

You can specify the data range for calculation.

(When data range does not need to be changed, press key to display the calculation result of the data range shown.)

Press key to show a cursor on "START" No.

Use key to select data number where to start calculation (START), and press key. The cursor will move to "END" No.

Use key to select data number where to end the calculation (END), and press key.

Press key to display the calculation result of the data range selected.

* You cannot select more than one range.

%OA (CO₂)

START:001		END:050	
NUM.	PPMRA	PPMSA	PPMOA
001	1003	623	425
002	1001	626	435
003	1005	653	420
004	1003	663	429
005	1006	639	424
006	1009	629	415

Data No. Return Air CO₂ Supply Air CO₂ Outdoor Air CO₂

CALCULATION

CALCULATION		
MAX	CO2	598 PPM
AUG	CO2	557 PPM
MIN	CO2	523 PPM

<In CALCULATION mode >

Press key to display calculation result in the sequence of CO2 -> CO -> Temperature -> Humidity -> DT, WB, AH -> HR.

Only average value is displayed for DT, WB, AH, and HR.

%OA

%OA	
TMP.	63.1 %OA

< In %OA mode >



Press key to display the average value of each point in the sequence of %OA -> R_A -> S_A -> O_A.

Press key to return to the screen for data output page setting screen.

Press key to return to the MENU screen.

6.3 Printing out Measurement Data

To print out stored measurement data, a printer cable must be connected to the RS232C terminal located at the side of the instrument.

Note 1 : Although you can see both RS232c mark () and USB mark () near the terminal, only RS232c is available for this instrument.

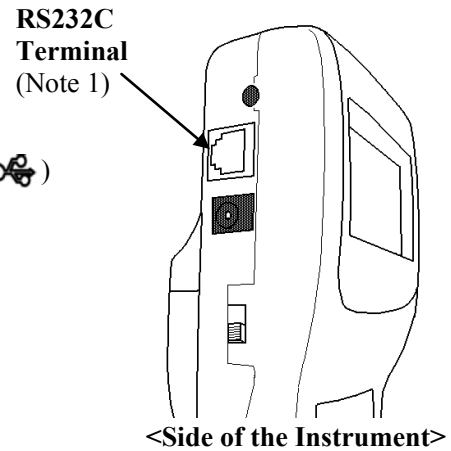

6.3.1 Preparation for Print Out

<Need to prepare>

- Printer (optional)...recommended model: DPU-H245 (Seiko Instruments)
- Printer Cable (optional)

<Baud rate setting>

The baud rate setting of the instrument and printer must be consistent.

List of communication protocol for IAQ Monitor:

Data Bit Length	8 bit
Parity	None
Stop Bit	1
Delimiter	CRLF
Baud Rate	Based on the set value*





* As for setting BAUD RATE, refer to “7.2 Changing Measurement Unit and Baud Rate” (Page 30).

* As for setting the printer, refer to the printer’s operation manual.

<Connecting the instrument with a printer >

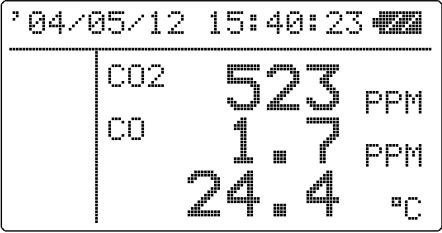
1. Connect a printer to the instrument by inserting a connecting cable into RS232 terminal located at the side of the instrument.
2. Turn ON the power of the instrument first, and then turn ON the printer.
3. Make sure that the instrument is in NORMAL Mode.

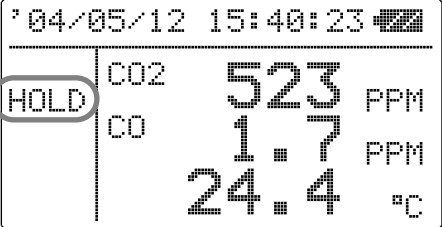
6.3.2 Printing from the NORMAL (Measurement) Mode

Display	Procedure
	<p>When a NORMAL mode screen is displayed, press  key to HOLD the readings that you want to print out.</p>
	<p>Press  key to print out the display which is on hold at the time.</p> <p>If a printer is not connected properly, “PERR” will be displayed in lower left of the display.</p>

Examples of Data Printout

<NORMAL Mode>

2004/05/12 15:40:45	
CO2 523 PPMCO ₂
CO 1.7 PPMCO
Temperature 24.4 °CTemperature
Humidity 52.7 %RHHumidity

6.3.3 Printing from CALCULATION mode

Display	Procedure												
<div style="border: 1px solid black; padding: 5px;"> <p style="text-align: center;">CALCULATION</p> <table border="1" style="width: 100%; border-collapse: collapse;"> <tr> <td style="width: 10%;">MAX</td> <td style="width: 15%;">CO2</td> <td style="width: 15%; text-align: center;">598</td> <td style="width: 15%;">PPM</td> </tr> <tr> <td>AVG</td> <td>CO2</td> <td style="text-align: center;">557</td> <td>PPM</td> </tr> <tr> <td>MIN</td> <td>CO2</td> <td style="text-align: center;">523</td> <td>PPM</td> </tr> </table> </div>	MAX	CO2	598	PPM	AVG	CO2	557	PPM	MIN	CO2	523	PPM	<p>After the calculation measurement is completed and the calculation result is shown, press MODE key to print out the measurement result.</p>
MAX	CO2	598	PPM										
AVG	CO2	557	PPM										
MIN	CO2	523	PPM										







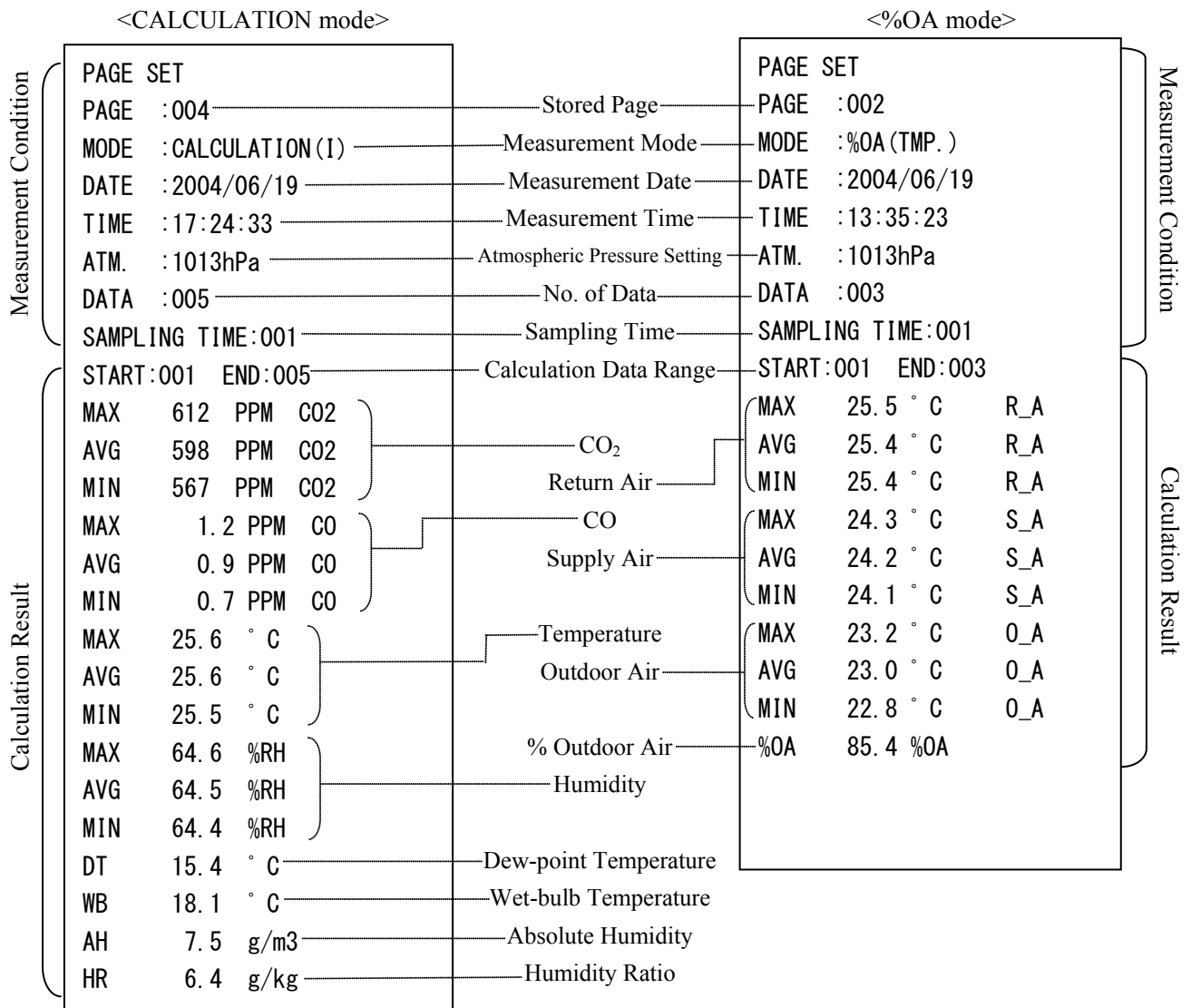



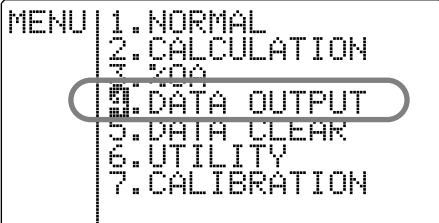



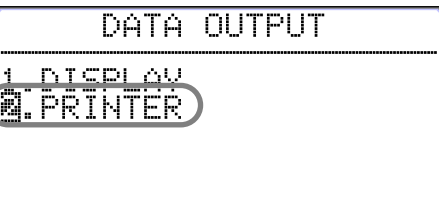



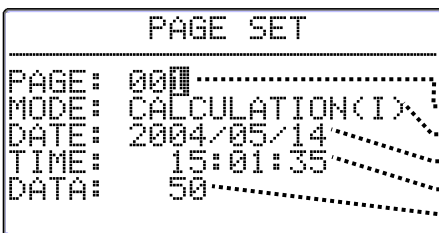



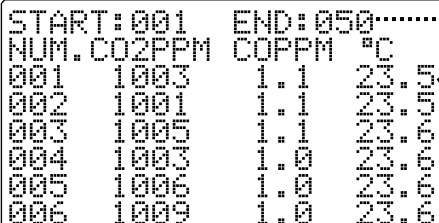

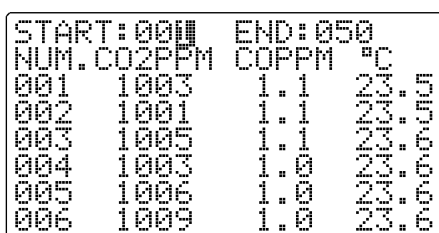

6.3.4 Printing from %OA (Percent Outdoor Air) mode

Display	Procedure
<div style="border: 1px solid black; padding: 5px;"> <p style="text-align: center;">%OA [Icon]</p> <hr/> <p style="text-align: center;">63.1 %OA</p> <p>TMP.</p> </div>	<p>After %OA measurement is completed and the calculation result is shown, press MODE key to print out the measurement result.</p>

Examples of Printout

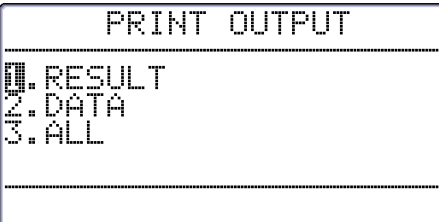

6.3.5 Printing out Stored Data

Display	Procedure
	<p>Press  key to bring up the MENU screen.</p> <p>Use   key to select “4.DATA OUTPUT”, and press  key.</p>
	<p>Use   key to select “2.PRINTER”, and press  key.</p>
	<p>Use   key to select the page that you want to display, and press  key.</p> <p>Page No. to be output Measurement Mode (Calculation (A): AVERAGE / (I): INSTANT) Measurement Date (Year/Month/Day) Measurement Time (Hour/Minute/Second) The number of trials in the specified page number</p>
	<p>The data in the selected page will be displayed. Press  key to scroll down.</p> <p>Data Range for calculation Data No. CO₂ CO Temperature</p> <p>When a measurement was performed in CALCULATION mode, press  key to switch to display between temperature and humidity.</p>
	<p><To specify the data range for calculation> You can specify the data range for calculation. (When data range does not need to be changed, skip this step.)</p> <p>Press  key to show a cursor at “START” No. Use   key to select data number (START) where to start calculation, and press  key.</p> <p>The cursor will move to “END” No. Use   key to select data number (END) where to end the calculation, and press  key.</p>
	<p>Press  key to bring up the PRINT OUTPUT screen to select what to print out.</p> <p>Use   key to select 1, 2 or 3, and press  key to print out.</p> <p>1. RESULT: Print out measurement condition and calculation result 2. DATA: Print out measurement condition and measurement data. 3. ALL: Print out measurement condition, calculation result and measurement data.</p>

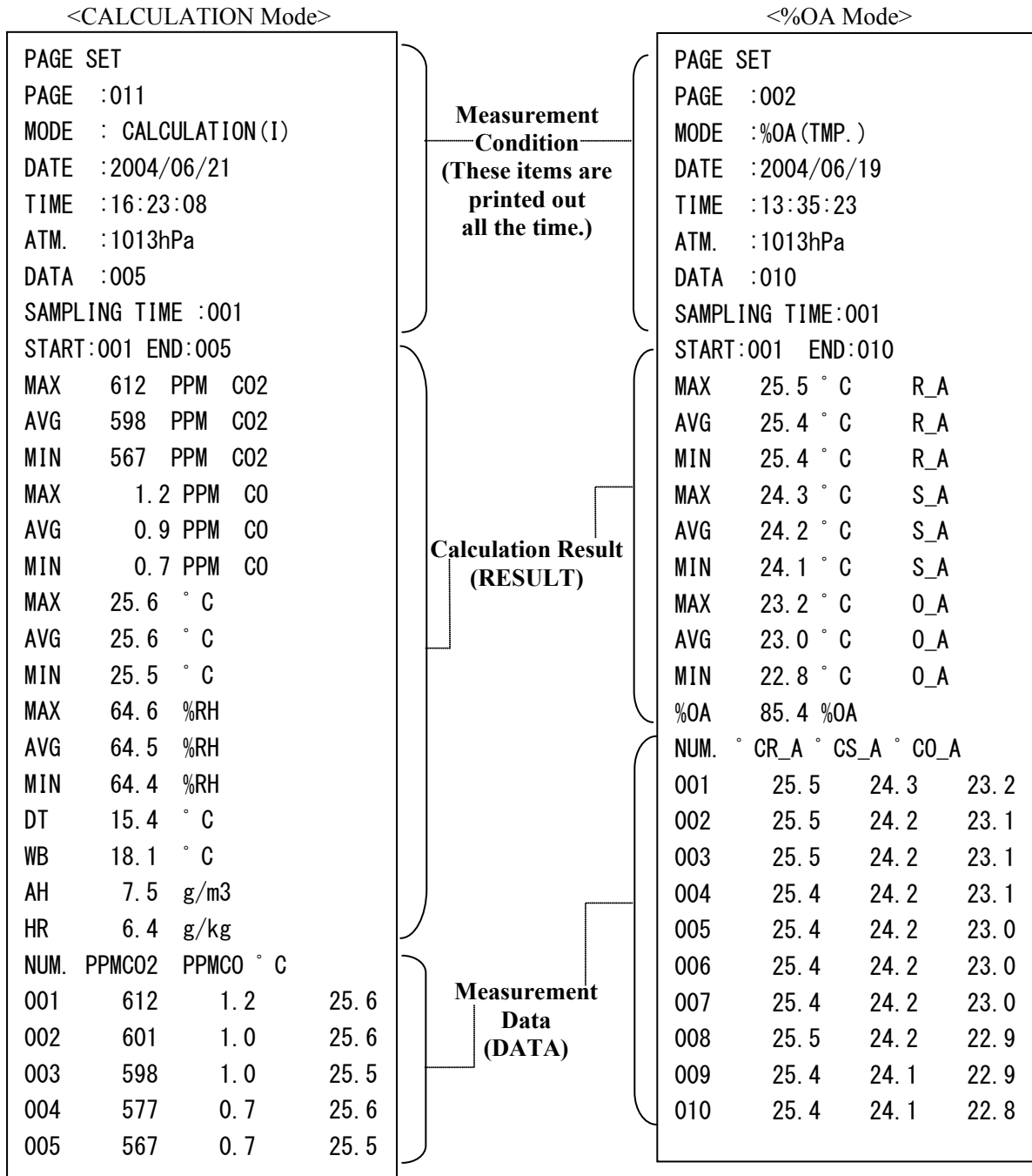

Example of Printout



6.4 Digital Output

6.4.1 Preparation for Digital Output

For digital-outputting stored measurement data, RS232C cable must be connected to the RS232C terminal located at the side of the instrument.

Note1 : Although you can see both RS232c mark () and USB mark () near the terminal, only RS232c is available for this instrument.

<Need to prepare>

- Computer
- RS-232C cable (provided)
- Communication Software (Measurement Software (CD-ROM) for Windows is provided)

RS232C Terminal
(Note 1)

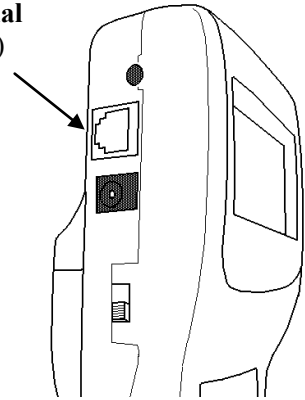

<Side of the Instrument>

< Baud rate setting >

The baud rate setting of the instrument and computer must be consistent.

List of communication protocol for IAQ Monitor:

Data Bit Length	8 bit
Parity	None
Stop Bit	1
Delimiter	CRLF
Baud Rate	Based on the set value*

* As for setting BAUD RATE, refer to “7.2 Changing Measurement Unit and Baud Rate” (Page 30).

* As for setting the computer, refer to the computer’s operation manual.

<Connecting the instrument with a computer>

1. Connect a computer to the instrument with the RS232 cable.
2. Turn ON the power of the instrument.
3. Make sure that the instrument is in NORMAL Mode.

RS232C Cable Wiring Diagram

PC (D-Sub9 pin)		Connection	IAQ Monitor (MODEL2212)			
Signal	Pin No.		Pin No.	Signal	Description of Signal	Signal Direction
NC	1		1	GND	Signal Ground	
RXD	2		2	TXD	Transmit Data	Output
TXD	3		3	RXD	Receive Data	Input
NC	4		4	CTS	Clear to Send	Input
GND	5		5	RTS	Request to Send	Output
NC	6		6	NC		
RTS	7					
CTS	8					
NC	9					

6.5 Entering Commands from PC to Output Data

As for connecting your PC to the instrument, refer to “6.4.1 Preparation for Digital Output” (Page 24).

----Icon and its meaning----

- ␣: Space
- ↵: Line Break or to Press [Enter] key
- *: To enter any number

* Enter all commands in capitals.

Command	Function
D * * * * ↵	To set how many data to read
N ↵	Receive Interrupt
S ↵	To output measurement condition
U ↵	To output measurement unit
F ↵	To set to output humidity related data
G ↵	To cancel outputting humidity related data
P ↵	To output stored number of the page
T * * * * ↵	To output stored data
M * * * * ↵	To output measurement condition
B ↵	To output measurement condition of all the pages

6.5.1 Transmission of Raw Data (data measured every 1 sec)

Display	Procedure
<p>Example: When entering “D0005↵” in Measurement Mode.</p> <div style="border: 1px solid black; padding: 5px;"> <p>AD↵</p> <p>0.9; 576; 23.4; 63.4↵</p> <p>0.8; 556; 23.4; 63.3↵</p> <p>0.8; 534; 23.5; 63.2↵</p> <p>0.9; 540; 23.5; 63.2↵</p> <p>0.9; 561; 23.4; 63.3↵</p> </div>	<p><To set number of data to be read> Enter “D * * * * ↵”. (Enter the number of data to be read in 4 digit number.) After the command is received, “AD” will be returned. Then the raw data which is displayed on the instrument’s screen every one second will be output. The maximum number of data which can be set is 9999. When to read more than 9999 data, send another command.</p> <p>What will be output? CO; CO2; Temperature; Humidity</p>
<div style="border: 1px solid black; padding: 5px; width: fit-content; margin: 0 auto;"> <p>AN↵</p> </div>	<p><Receive Interrupt> Enter “N↵”. After the command is received, “AN” will be returned and the reception will be interrupted</p>
Display	Procedure
<div style="border: 1px solid black; padding: 5px; width: fit-content; margin: 0 auto;"> <p>AS↵</p> <p>CTH; 00:00; 1013↵</p> </div>	<p><To output measurement condition> Enter “S↵”. After the command is received, “AS” will be returned. The display range of measurement items shown on the screen and configured atmospheric pressure will be output.</p> <p>What will be output? CTH: CO measurement range; temperature measurement range; configured atmosphere pressure CO measurement range: 00:0~50PPM / 01:0~500PPM Temperature measurement range: 00:0~60 °C / 01:-20~60 °C</p>
Display	Procedure
<div style="border: 1px solid black; padding: 5px; width: fit-content; margin: 0 auto;"> <p>AU↵</p> <p>ppm; ppm; °C; %RH; °C; °C; g/m3; g/kg; %↵</p> </div>	<p><To output measurement unit > Enter “U↵”. After the command is received, “AU” will be returned. Configured measurement unit at the time will be output.</p> <p>What will be output? CO Unit; CO2 Unit; Temperature Unit; Humidity Unit; Dew-point Temperature Unit; Wet-bulb Temperature Unit; Absolute Humidity Unit; Humidity Ratio Unit; Percent Outdoor Air Unit</p>

6.5.2 Transmission of Stored Data (data stored in memory)

Display	Procedure
AF	<p><To set humidity related data output> Enter “F”. After the command is received, “AF” will be returned and humidity related data such as DT, WB, AH, and HR will be added in the subsequent data output.</p>
AG	<p><To release humidity related data output > Enter “G”. After the command is received, “AG” will be returned and humidity related data such as DT, WB, AH and HR will not be added in the subsequent data output.</p>
AP P0011	<p><To output stored page number > Enter “P”. After the command is received, “AP” will be returned and the stored page number will be output.</p>
AT 2004/05/19;13:32:26 001;0.9;576;23.4;63.4 002;0.8;556;23.4;63.3 003;0.8;534;23.5;63.2 004;0.9;540;23.5;63.2 005;0.9;561;23.4;63.3	<p><To output stored data > Enter “T * * * *”. (Enter the page number of the stored data you want to output in 4 digit number.) After the command is received, “AT” will be returned. The raw data stored in the specified page will be output. *Any calculation data such as min, average and max value, will not be output. (As for %OA, only the average value in a page will be output. *The measurement unit in the output data depends on the current measurement unit setting.</p>
<p>What will be output? - CALCULATION Mode (Before sending [F] command) Data No.; CO; CO₂; Temperature; Humidity - CALCULATION Mode (After sending [F] command) Data No.; CO; CO₂; Temperature; Humidity; DT; WB; AH; HR - Percent Outdoor Air (%OA) Mode Data No.; %OA; R_A; S_A; O_A</p>	
<p style="text-align: right;">* YY/MM/DD format is configured as the date format in the output. Therefore, the date setting on the instrument will not be reflected in the output.</p>	
Display	Procedure
AM CTH:000;001;003;AVG;1013 1. 2. 3. 4. 5.	<p><To output measurement condition> Enter “M * * * *”. (Enter the page number of the measurement condition to be output in 4 digit number.) After the command is received, “AM” will be returned and the measurement condition of the specified page will be output.</p>
<p>What will be output? 1. Measurement Mode 000: CALCULATION Mode 001: %OA Mode 2. Sampling Time</p>	<p>3. Number of Data 4. Calculation Mode CALCULATION Mode-- AVG: average/ INS: Instant %OA Mode -- TMP: Temperature/ CO2: CO₂ 5. Configured Atmosphere Pressure</p>
Display	Procedure
AB CTH:000;001;003;AVG;1013 CTH:001;001;005;TMP;1013	<p><To output measurement condition of all pages> Enter “B”. After the command is received, “AB” will be returned and the measurement condition of all pages will be output. (Output items are the same as when to output measurement condition.)</p>
Display	Procedure
ED	<p><Error Message> If the page number is entered incorrectly, “ED” will be returned.</p>

6.6 Analog Output (Optional)

1. Data Update Interval 1 second
2. Load Impedance..... 5KΩ and above
3. Output Voltage.....DC 0-1V

As For the analog output, you can select one output range from the table below.





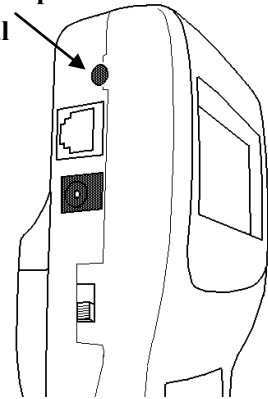





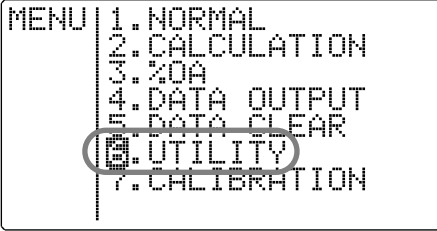



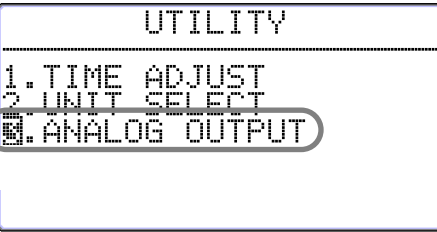



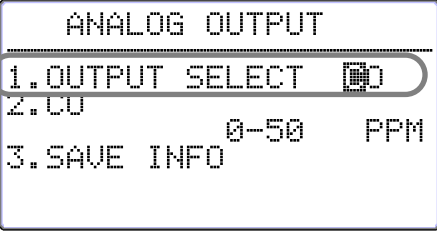







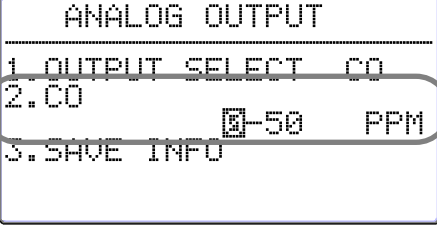

	Output Range	Conversion Formula (Voltage: V)
CO (C)	0 ~ 50 ppm	$C = 50 \times V \text{ ppm}$
	0 ~ 100 ppm	$C = 100 \times V \text{ ppm}$
	0 ~ 250 ppm	$C = 250 \times V \text{ ppm}$
	0 ~ 500 ppm	$C = 500 \times V \text{ ppm}$
CO₂ (M)	0 ~ 500 ppm	$M = 500 \times V \text{ ppm}$
	0 ~ 1000 ppm	$M = 1000 \times V \text{ ppm}$
	0 ~ 2500 ppm	$M = 2500 \times V \text{ ppm}$
	0 ~ 5000 ppm	$M = 5000 \times V \text{ ppm}$
Temperature (T)	0 ~ 50 °C	$T = 50 \times V \text{ °C}$
	0 ~ 100 °C	$T = 100 \times V \text{ °C}$
	-20 ~ 30 °C	$T = 50 \times V - 20 \text{ °C}$
	-20 ~ 80 °C	$T = 100 \times V - 20 \text{ °C}$
Temperature (F)	32 ~ 122 °F	$F = 90 \times V + 32 \text{ °F}$
	32 ~ 212 °F	$F = 180 \times V + 32 \text{ °F}$
	-4 ~ 86 °F	$F = 90 \times V - 4 \text{ °F}$
	-4 ~ 176 °F	$F = 180 \times V - 4 \text{ °F}$
Humidity (H)	0 ~ 50 %RH	$H = 50 \times V \text{ %RH}$
	0 ~ 100 %RH	$H = 100 \times V \text{ %RH}$

Analog Output Terminal



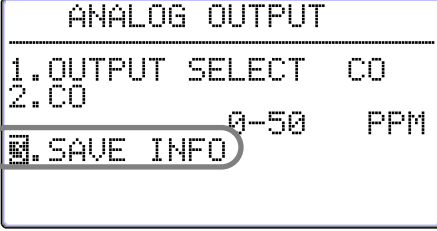









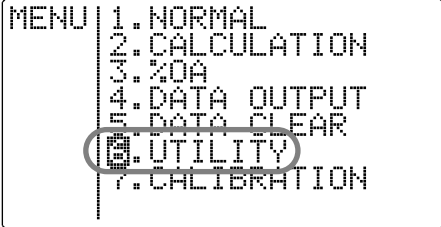



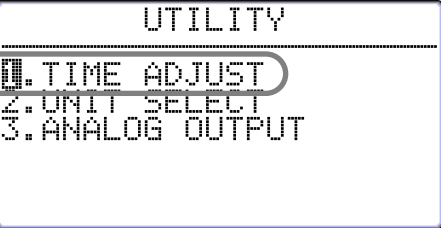



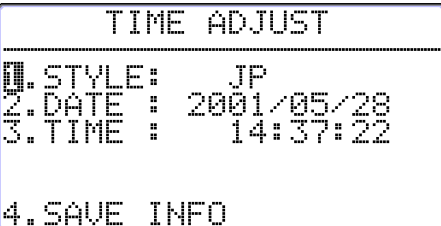

It is linear output whose minimum value is 0V and maximum value is 1V.
Output data is output every 1 sec constantly.

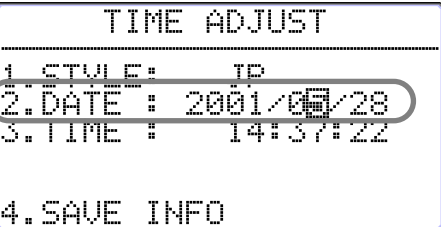
How to Output Measurement Data (Analog Output)	Explanation
	<p>Take data every 1 second, and output the value every 1 second.</p>

Display	Procedure
 <pre> MENU 1.NORMAL 2.CALCULATION 3.%DA 4.DATA OUTPUT 5.DATA CLEAR 6.UTILITY 7.CALIBRATION </pre>	<p>Press  key to bring up the MENU screen.</p> <p>Use   key to select “6.UTILITY”, and press  key.</p>
 <pre> UTILITY ----- 1.TIME ADJUST 2.UNIT SELECT 3.ANALOG OUTPUT </pre>	<p>Use   key to select “3.ANALOG OUTPUT”, and press  key.</p>
 <pre> ANALOG OUTPUT ----- 1.OUTPUT SELECT  2.CO 0-50 PPM 3.SAVE INFO </pre>	<p><To select measurement item to output ></p> <p>Use   key to Select “1.OUTPUT SELECT”, and press  key.</p> <p>Use   key to switch in the sequence of “CO”, “CO2”, “TMP.” (Temperature) and “HUM.” (Humidity).</p> <p>Select the measurement item to output, and press  key.</p>
 <pre> ANALOG OUTPUT ----- 1.OUTPUT SELECT CO 2.CO -50 PPM 3.SAVE INFO </pre>	<p><To set output range></p> <p>Use   key to select “2.”, and press  key.</p> <p>Use   key to select the output range, and press  key.</p>
 <pre> ANALOG OUTPUT ----- 1.OUTPUT SELECT CO 2.CO 0-50 PPM 3.SAVE INFO </pre>	<p><To save the setting></p> <p>Use   key to select “3.SAVE INFO”, and press  key to save the setting.</p> <p>* If pressing  key before completing the setting, you will return to the MENU screen without that the changes are saved.</p>

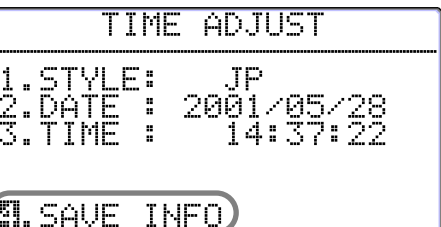
7. Other Settings

7.1 Changing Date and Time

Display	Procedure
	<p>Press  key to bring up the MENU screen.</p> <p>Use   key to select “6. UTILITY”, and press  key.</p>
	<p>Use   key to select “1. TIME ADJUST”, and press  key.</p>
	<p>Use   key to select the item that you want to change (“1.STYLE”, “2.DATE” or “3.TIME”), and press  key.</p> <p>1.STYLE: Select from among JP, US and EU JP (Japanese) style YYYY/MM/DD US style MM/DD/YYYY EU style DD/MM/YYYY</p> <p>2.DATE: Date 3.TIME: Hour/Minute/Second</p>
	<p><To change date></p> <p>Use  key to move a cursor to the item that you want to change, and use   key to change the value. Press  key to fix the value and the cursor will move to the next item.</p>
	<p><To save the changes></p> <p>Use   key to select “4. SAVE INFO” and press  key to save the changes and go back to the MENU screen.</p> <p>* After changing the date, the date of the measurement data stored before the change will also be altered accordingly.</p> <p>* If pressing  key before completing the setting, you will return to the MENU screen without that the changes are saved.</p>

* The date format set here is used on the instrument’s screen and on printout.

However, for digital output (RS232C Communication), the Japanese style (YYYY/MM/DD) is always used.

7.2 Changing Measurement Unit and Baud Rate

<Unit Conversion Table>	
Temperature	$T(^{\circ}\text{F}) = 1.8 \times T(^{\circ}\text{C}) + 32$
Absolute Humidity	$1(\text{g}/\text{m}^3) = 6.24 \times 10^{-5}(\text{lb}/\text{ft}^3)$
Humidity Ratio	$1(\text{g}/\text{kg}) = 9.9999 \times 10^{-4}(\text{lb}/\text{lb})$

Display	Procedure
---------	-----------

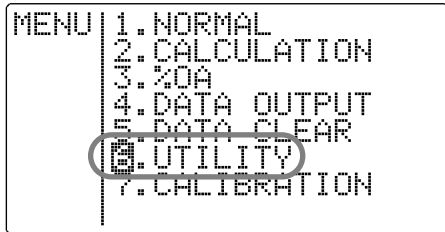

Press key to bring up the MENU screen.
 Use key to select "6. UTILITY", and press key.

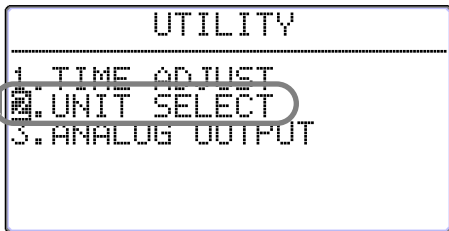

Use key to select "2. UNIT SELECT", and press key.

<To change measurement unit and baud rate>

Use key to select the item (1 ~ 4) that you want to change, and press key.

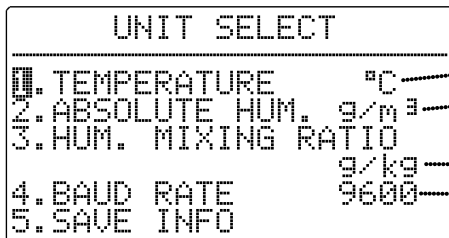

Temperature Unit: $^{\circ}\text{C}$, $^{\circ}\text{F}$
 Absolute Humidity Unit: g/m^3 , lb/ft^3
 Humidity Ratio: g/kg , lb/lb
 Baud Rate: 4800, 9600, 19200, 38400bps

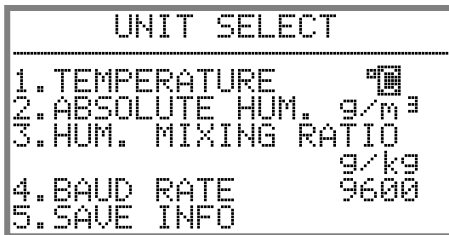

Use key to change the setting. Press key to fix the changes.

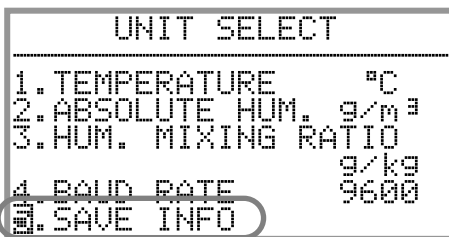

<To save changes>

Use key to select "5. SAVE INFO", and press key to store the changes and return to the MENU screen.

* If pressing key before completing the setting, you will return to the MENU screen without that the changes are saved.

7.3 Deleting Data

7.3.1 To Delete Certain Pages of Data

When data is deleted partially, data is deleted per page. One measurement taken in CALCULATION MODE or % OUTDOOR AIR (%OA) MODE is stored in one page.

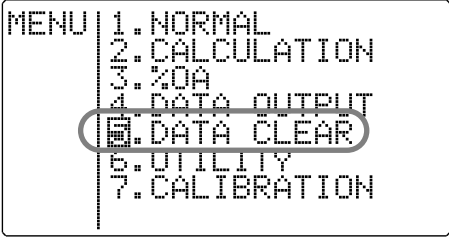
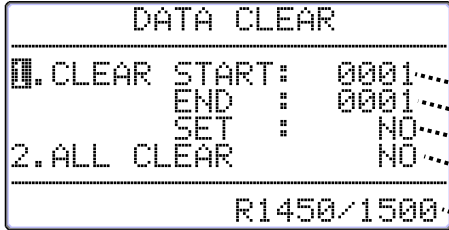
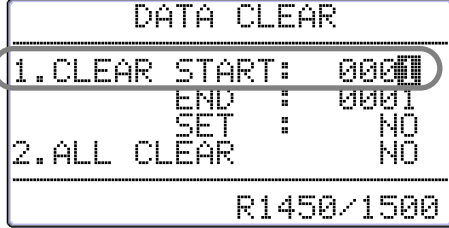
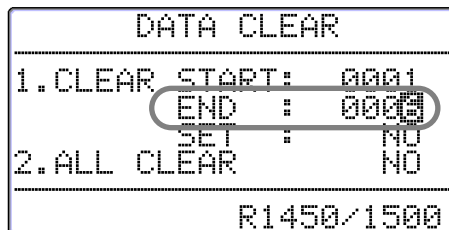
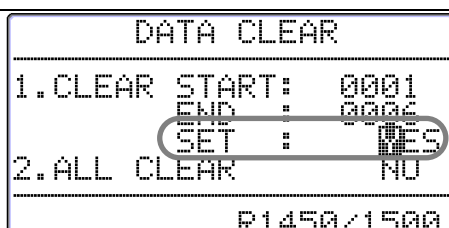
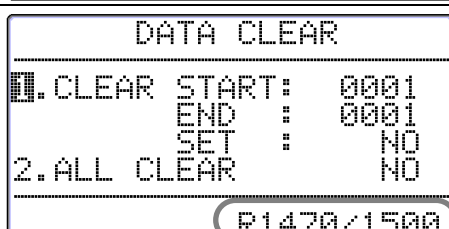
Display	Procedure
	<p>Press MENU key to bring up the MENU screen.</p> <p>Use ▼▲ key to select “5. DATA CLEAR” and press SET key.</p>
	<p>Use ▼▲ key to select “1. CLEAR” (to delete only the specified data), and press SET key.</p> <ul style="list-style-type: none"> The first page to be deleted The last page to be deleted Delete partially (YES or NO) Delete all (YES or NO) <p>Remaining Memory/Total Memory (It shows the number of measurement data.)</p>
	<p>Use ▼▲ key to select the first page to be deleted, and press SET key.</p>
	<p>Use ▼▲ key to select the last page to be deleted, and press SET key.</p>
	<p>Use ▼▲ key to select “YES” to delete the selected pages, and press SET key.</p>
	<p>The selected page will be deleted and the subsequent page number will be shifted up.</p> <p>EX) There are data from page 1 to page 4. If the 3rd page is deleted, the data in the 4th page will be shifted up to the 3rd and the data from page1 to page3 will be remained.</p>

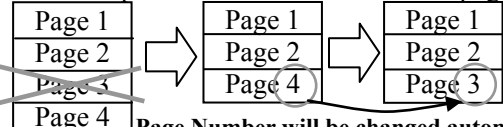



Page Number will be changed automatically

7.3.2 To Delete All Data

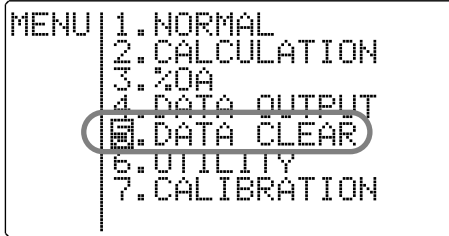

Display

Procedure



Press  key to bring up the MENU screen.

Use   key to select “5. DATA CLEAR, and press  key.

Use   key to select “2. ALL CLEAR” (to delete all), and press  key.

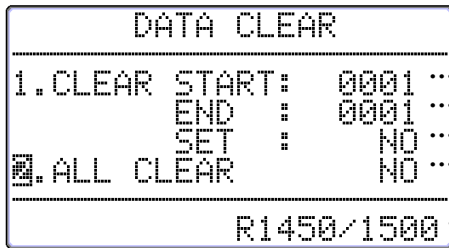

.....The first page to be deleted

.....The last page to be deleted



.....Delete partially (YES or NO)

.....Delete all (YES or NO)

.....Remaining Memory / Total Memory

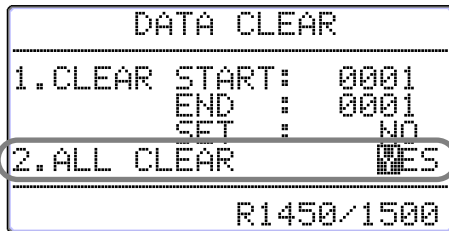
(It shows that the number of measurement data.)



Use   key to select “YES” to delete all data, and press  key.

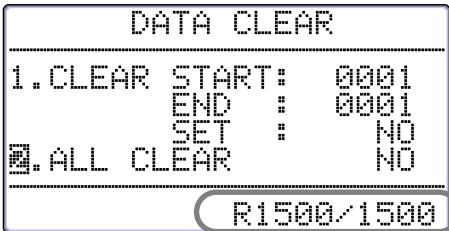

After all the data is deleted, the Remaining Memory will become 1500.

7.4 Contrast Adjustment

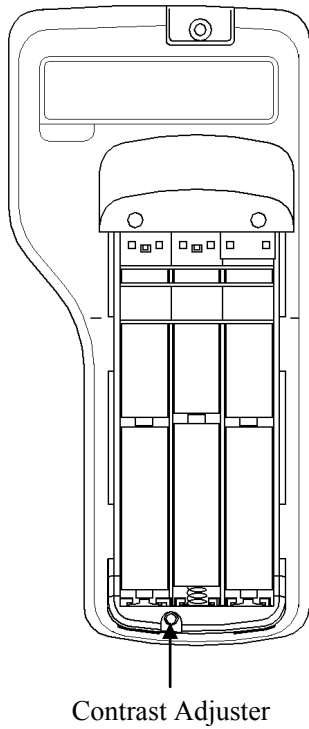

There is a contrast adjuster inside the battery cover located at the rear side of the main body.

The contrast of the screen can be adjusted by using a flat-blade precision screwdriver (0.9 ~ 1.5mm).

As described in the picture below, turn it clockwise to darken and vice versa.

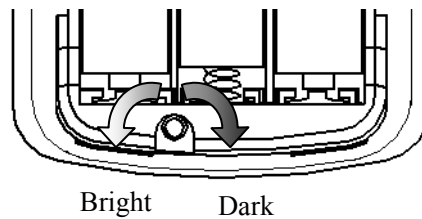

8. Calibrating CO/CO₂ Sensor

When calibrating the IAQ Monitor on site, follow the instruction below.

It is recommended to calibrate the IAQ Monitor's CO/CO₂ measurement every 2-3 months to ensure accurate readings.

In addition, it is still recommended to send your IAQ monitor to KANOMAX for annual calibration.

* It is recommended to exchange the CO sensor annually and it is a consumable.

8.1 Preparation for Calibration

Fully warm up the instrument (for about 20 minutes) before performing a calibration.

Normally calibrate ZERO gas first then Span gas.

(It is also acceptable if you calibrate either ZERO gas or Span gas.)

1. Confirm if the valve of the regulator is closed

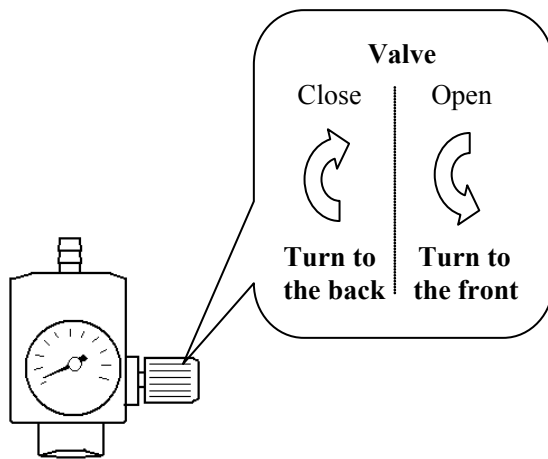

2. Attach the regulator to a ZERO gas cylinder.

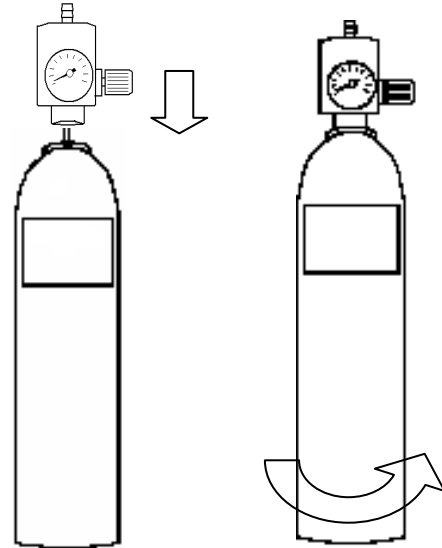

3. Connect the regulator to the calibration cap by using a tube. Connect them firmly in order to prevent the gas-leaking.

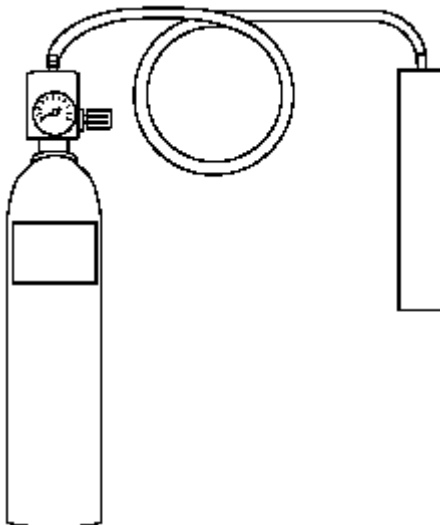

4. Put the calibration cap on the probe. Insert it firmly in order to prevent the gas-leaking.

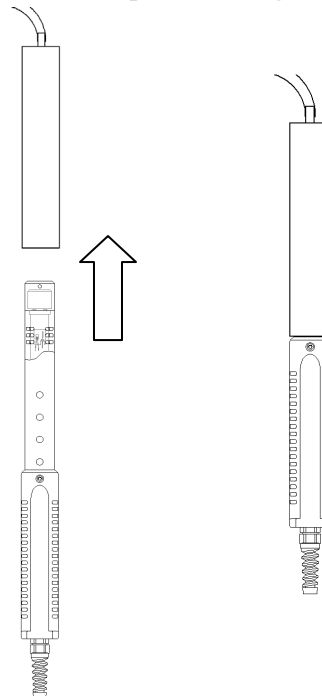

8.2 Calibration Procedure – ZERO Calibration

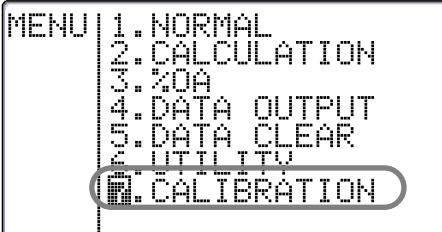
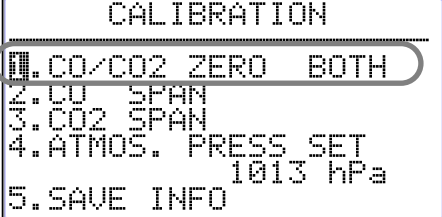
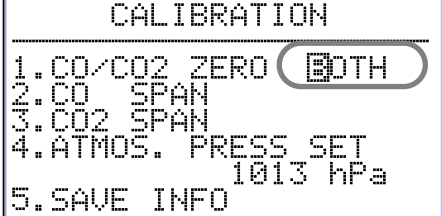
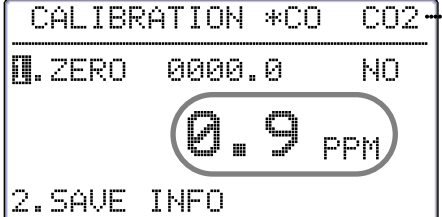
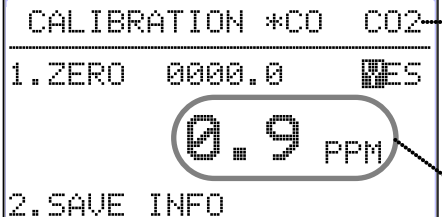
Display	Procedure
	<p>Connect a ZERO gas cylinder to the IAQ Monitor as described in the previous page.</p> <p>Press (MENU) key to bring up the MENU screen.</p> <p>Use (▼) (▲) key to select “7. CALIBRATION”, and press (SET) key.</p>
	<p>Use (▼) (▲) key to select a sensor that you want to calibrate (“1.CO/CO2 ZERO”, “2. CO SPAN” or “3. CO2 SPAN”), and press (SET) key.</p> <p>(“CO/CO2 ZERO” is selected in this example.)</p>
	<p>Decide whether to perform ZERO calibration for CO, CO2 or both at the same time.</p> <p>Use (▼) (▲) key to select “BOTH”, “CO” or “CO2”, and press (SET) key.</p> <p>(“BOTH” is selected in this example.)</p>
	<p>It indicates the type of a sensor whose data is displayed on the screen. (This is only applicable when selecting “BOTH”.) The data of the one with “*” symbol is selected. In the left picture, CO’s status is shown at the moment. When either CO or CO2 is selected in the previous step, only the selected type will be displayed.</p> <p>To switch to display the sensor, press (MODE) key.</p>
<p>Press (SET) key.</p>	
<p>Use (▼) (▲) key to select “YES”, and press (SET) key. Now it is ready for calibration.</p>	
	<p>It indicates the type of a sensor whose data is displayed on the screen. (This is only applicable when selecting “BOTH”.) The data of the one with “*” symbol is selected. In the left picture, CO’s status is shown at the moment. When either CO or CO2 is selected in the previous step, only the selected type will be displayed.</p> <p>Reading before calibration</p>

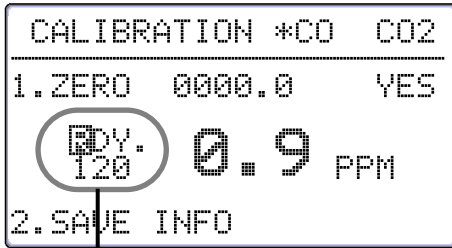

Fully open the regulator valve to emit gas. Press **START HOLD** key to start calibration.

Ready to start calibration:

Countdown initial value is displayed here.

When selecting CO only, the countdown initial value is 90 seconds. When selecting CO₂ only, it is 120 seconds. When selecting BOTH, it is 120 seconds.

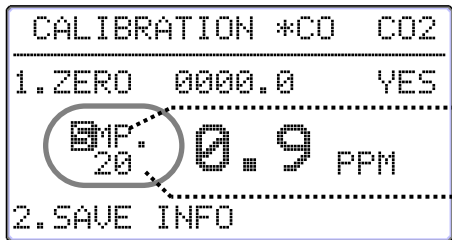

Calibrating right now.

It indicates that it is calibrating now.

The remaining time before calibration completes.

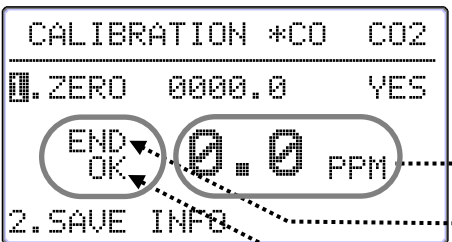

If the calibration result is OK

Calibration is completed.

Reading after calibration

It shows that calibration is ended.

It shows a calibration result.

Result of ZERO Calibration:

CO calibration fails when...

1. CO concentration maintains above 10ppm in 30 seconds after calibration starts.
2. the calibration value's deviation (Max value-Min value) does not fall within 6ppm for 20 seconds before calibration ends.

CO₂ calibration fails when...

1. CO concentration maintains above 200ppm in 30 seconds after calibration starts.
2. the calibration value's deviation (Max value-Min value) does not fall within 100ppm for 20 seconds before calibration ends.

Operation

When "END" is displayed, close the valve of the regulator to turn off the gas.

Press **SET** key to return to the MENU screen where all the changes are stored.

* If pressing **MENU** key before completing the setting, you will return to the MENU screen without that the changes are saved.

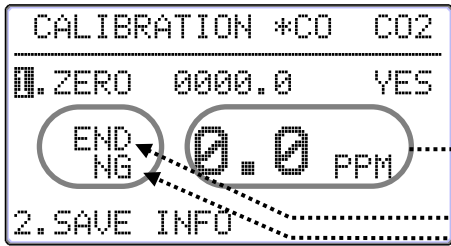

If the calibration result is NG

Calibration will be terminated.

Reading after calibration

It shows that calibration is ended.

It shows the result of calibration (when calibration fails.)

Operation

When "END" is displayed, close the valve of the regulator to turn off the gas.

* If the calibration result is "NG", "2.SAVE INFO" will not be able to be selected. Select "YES" to retry calibration.

Press **(MENU)** key to go back to the MENU screen.

* If "--ERR--" (Error) is displayed during calibration, please check the cause, and return to the MENU screen for retrying calibration.

When selecting "CO" or "CO₂", the procedure will be the same.

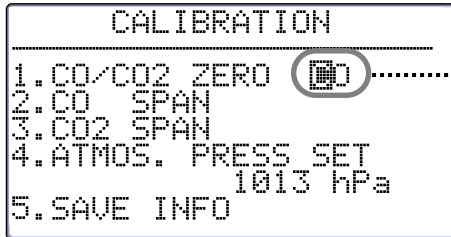



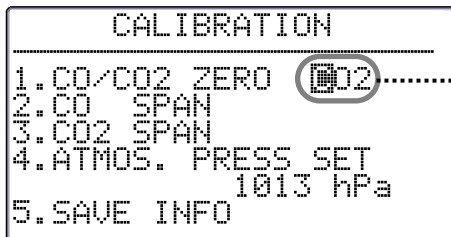

Indicates the selected sensor type.



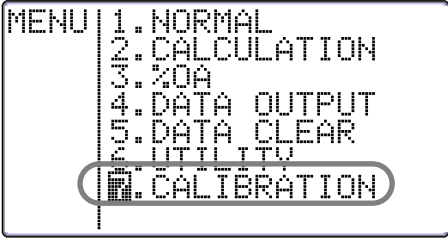
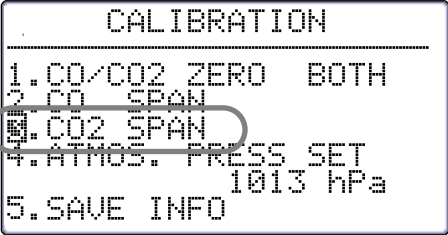

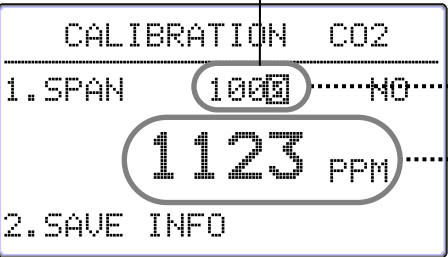
Indicates the selected sensor type.

8.3 Calibration Procedure – SPAN Calibration

Display	Procedure
	<p>Connect a Span gas cylinder to the IAQ Monitor as described in the previous page.</p> <p>Press MENU key to bring up the MENU screen.</p> <p>Use ▼▲ key to select “7.CALIBRATION”, and press SET key.</p>
	<p>Use ▼▲ key to select the sensor that you want to calibrate (“2.CO” or “3.CO2”), and press SET key. (CO2 is selected in this example.)</p>
	<p>Perform a calibration by using span gas.</p> <p>Press SET key.</p>
<p>*Concentration Setting Range CO: 20-550ppm, CO₂: 800-5500ppm</p>	<p>Use ▼▲ key to enter a concentration value displayed on the SPAN gas cylinder, and press SET key.</p>
	<p>Enter the concentration value shown on SPAN gas cylinder label.</p> <p>Reading before calibration</p>
	<p>After setting the concentration, select “YES” by using ▼▲ key and press SET key.</p>



Press  key to start calibration.

It shows that gas is emitted and it is waiting for  key to be entered.

It shows countdown initial value. (unit: second)
(CO Calibration: 90sec / CO₂ Calibration: 120sec)

Operation

Replace the ZERO gas cylinder that is connected to the instrument with a SPAN gas cylinder. Then fully open the regulator valve to pass the gas flow, and press  key to start calibration.



Calibrating right now.

It indicates that it is calibrating now.

The remaining time before calibration completes.

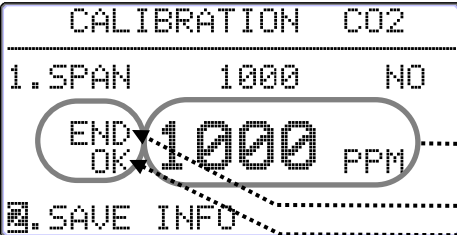

If the calibration result is OK

Calibration is completed.



Reading after calibration

It shows that calibration is ended.

It shows a calibration result.

Operation

When “END” is displayed, close the valve of the regulator to turn off the gas.

Use   key to select “2.SAVE INFO”, and press  key to return to the MENU screen where all the changes are stored.

* If pressing  key before completing the setting, you will return to the MENU screen without the changes are saved.

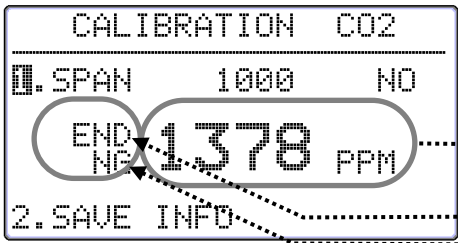

If the calibration result is NG

Calibration will be terminated.

.....Reading after calibration

.....It shows that calibration is ended.

.....It shows a calibration result.

Result of SPAN Calibration:

CO₂ calibration fails when...

1. CO₂ concentration does not reach 60% of the configured value of standard concentration in 30 seconds after calibration starts.
2. the calibration value's deviation (Max value-Min value) does not fall 6% or 100ppm (the greater value will be applied.) of the configured value of standard concentration for 20 seconds before calibration completes.

Operation

When "END" is displayed, close the valve of the regulator to turn off the gas.

- * If the calibration result is NG, "2.SAVE INFO" will not be able to be selected. Select "YES" to retry the calibration.
Press **(MENU)** key to return to the MENU screen.
- * If "--ERR--" (error) is displayed during calibration, please check the cause, and then return to the MENU for retrying a calibration.

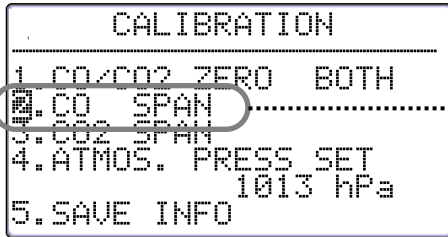

When you select "CO₂ SPAN, the procedure is the same.

..... Select CO SPAN calibration.

Result of SPAN Calibration:

CO calibration fails when...

1. CO concentration does not reach 60% of the configured value of standard concentration in 30 seconds after calibration starts.
2. the calibration value's deviation (Max value-Min value) does not fall within 6% or 6ppm (the greater value will be applied) of the configured value of standard concentration for 20 seconds before calibration completes.

9. Specifications

Product		IAQ Monitor
Model		2212
Measuring Object		Clean Air flow
CO	Measuring Method	Electrochemical
	Measuring Range	0.1~500ppm
	Resolution	0.1~99.9ppm: 0.1ppm, 100-500ppm: 1ppm
	Accuracy	±3% of the reading or ±3ppm; greater value is applied. (@20 °C)
	Temperature Dependence	±0.125 %FS/ °C (within -20~40 °C: standard is 20 °C)
	Air Pressure Dependence	±0.02 %FS/hPa (within 700-1200hPa: the standard is 1013hPa)
	Response Time	Approx. 60sec. (90% responsive when calibration cap is used.)
CO ₂	Measuring Method	Nondispersive Infrared (NDIR)
	Measuring Range	0~5000ppm
	Resolution	1ppm
	Accuracy	±3% of the reading or ±50ppm; greater value is applied. (@20 °C)
	Temperature Dependence	±0.34 %FS/ °C (within -20~40 °C: the standard is 20 °C)
	Air Pressure Dependence	±0.02 %FS/hPa (within 700~1200hPa: the standard is 1013hPa)
Temperature	Measuring Method	Platinum Resistance Thermometer
	Measuring Range	-4~140 °F (-20.0~60.0 °C)
	Resolution	0.1 °C
	Accuracy	±0.5 °C
	Response Time	Approx. 60sec. and below (air velocity: 1m/s, 90% responsive)
Humidity	Measuring Method	Electric Capacity
	Measuring Range	2.0~98.0 %RH
	Resolution	0.1 %RH
	Accuracy	2~80%RH: ±2.0%RH, 80~98%RH: ±3.0%RH
	Response Time	Approx. 15sec. (90% responsive)
Measuring Function		Hold the reading, Hold the MAX reading, Remaining battery level indicator (5 levels), Time display function, Barometric pressure correction, Selection of measuring units (Temp/DT/WB: °C or °F, AH:g/m ³ or lb/ft ³ , Humidity Ratio: g/kg or lb/lb), Max/Min/Average value measurement (measurement interval: 1-999sec., No of Measurement: 1-999 times, Max memory: 1500 data), OA%, Gas calibration
Output		Digital output: RS-232C (Baud rate: 4800, 9600, 19200, 38400bps) for outputting to a printer and/or PC Analog Output*: DC0~1V (Output 1CH among CO, CO ₂ , Temperature, or Humidity)
Power Supply		Manganese AA Batteries x 6 (Alkaline can be used as well) AC Adaptor*: AC100~240V (50/60Hz)
Battery Life		Approx. 10hours (When RS-232C is not being used at 20°C and not using Alkaline)
Operating Environment	Main Unit	5~40 °C (No condensation)
	Probe	-20~60 °C (No condensation)
	Storage Temperature	-20~60 °C (No condensation)
Weight		Main unit: Approx. 400g (including batteries) Probe: Approx. 250g
Standard Accessories		Carrying case, Operation manual, Manganese AA batteries x 6, A set of calibration cap and tube, Probe stand, Software for Windows, RS232C cable
Optional Accessories		Spare probe, analog output, printer, ZERO gas, SPAN gas for CO, SPAN gas for CO ₂ , flow control valve, AC adaptor

* Optional

10. Calculation Result: DT, WB, AH and HR

10.1 What is DT?

DT -- Dew Point Temperature

Warmer air contains much water vapor. As the air gets cooled, it reaches saturation at a certain temperature (Relative Humidity: 100%). As the temperature continues to get lowered, water vapor starts condensing into water. The condensed water is called dew. This temperature is called Dew Point Temperature.

There are many formulas to calculate the Dew Point Temperature. In this manual calculation in conformity with JIS standard Z8806 is used.

$$\ln(e_w) = -6096.9385 \times T^{-1} + 21.2409642 - 2.711193 \times (10^{-2}) \times T \\ + 1.673952 \times (10^{-5}) \times T^2 + 2.433502 \times \ln(T)$$

$$e = U/100 \times e_w$$

$$y = \ln(e/611.213)$$

In case of $y \geq 0$;

$$td = 13.715 \times y + 8.4262 \times (10^{-1}) \times y^2 \\ + 1.9048 \times (10^{-2}) \times y^3 \\ + 7.8158 \times (10^{-3}) \times y^4$$

In case of $y < 0$;

$$td = 13.7204 \times y + 7.36631 \times (10^{-1}) \times y^2 \\ + 3.32136 \times (10^{-2}) \times y^3 \\ + 7.78591 \times (10^{-3}) \times y^4$$

e_w : Saturated Vapor Pressure (Pa)

T: Absolute Temperature (K) = $t(^{\circ}\text{C}) + 273.15$

T: Dry-bulb Temperature ($^{\circ}\text{C}$)

E: Water Vapor Pressure (Pa)

U: Relative Humidity

Td: Dew-point Temperature ($^{\circ}\text{C}$)

10.2 What is WB?

WB: Wet-bulb Temperature

Wet-bulb temperature is measured using a wet-bulb thermometer that has its bulb wrapped in cloth that is kept wet with water.

To calculate wet-bulb temperature without using a wet-bulb thermometer, existing dry-bulb temperature and relative humidity are normally used on the aspirated psychrometer humidity table that is JIS standard Z8806 compliant. In this manual, however, we use Newtonian approximation based on the assumption of a temperature measured on a wet-bulb thermometer being lower than a dry-bulb thermometer.

$$\ln(e_{tw}) = -6096.9385 \times T_w^{-1} + 21.2409642 - 2.711193 \times (10^{-2}) \times T_w + 1.673952 \times (10^{-5}) \times T_w^2 + 2.433502 \times \ln(T_w)$$

$$A = e_{tw}$$

$$f'(tw) = 4030.183 / ((235 + tw)^2) \times A + P/2/755$$

$$tw1 = tw - (A - P \times (t - tw) / 2 / 755 - E \times U / 100) / f'(tw)$$

tw: Wet-bulb temperature ($^{\circ}\text{C}$)

e_{tw} : Saturated Water Vapor Pressure at tw (Pa)

T_w : Absolute Temperature (k) = (tw + 273.15)

P: Barometric Pressure (Pa)

E: Saturated Water Vapor Pressure at t (Pa)

U: Relative Humidity

T: Dry-bulb Temperature ($^{\circ}\text{C}$)

10.3 What is AH?

AH: Absolute Humidity

Absolute humidity is the quantity of water per 1kg of dry air. To calculate absolute humidity, apply temperature and relative humidity on below formula.

$$\ln(e_w) = -6096.9385 \times T^{-1} + 21.2409642 - 2.711193 \times (10^{-2}) \times T + 1.673952 \times (10^{-5}) \times T^2 + 2.433502 \times \ln(T)$$

$$e = U/100 \times e_w$$

$$D(\text{g/m}^3) = 0.794 \times (10^{-2}) \times e / (1 + 0.00366 \times t)$$

e_w : Saturated Water Vapor Pressure (Pa)

T: Absolute Temperature (K) = t ($^{\circ}\text{C}$) + 273.15

t: Dry-bulb Temperature ($^{\circ}\text{C}$)

e: Water Vapor Pressure (Pa)

U: Relative Humidity

D: Absolute Humidity (g/m³)

10.4 What is HR?

HR: Humidity Mixing Ratio

Humidity Ratio (or Mixing Ratio) is the mass ratio between water vapor and dry air.

Temperature and relative humidity are used on below formula.

$$R = \epsilon \times e / (p - e) \times 1000$$

ϵ : Molar Mass Ratio = 0.62198

e: Water Vapor Pressure (Pa)

p: Barometric Pressure (Pa)

r: Humidity Ratio (g/kg)

11. Troubleshooting

11.1 Battery Check

Symptom	Possible Cause(s) / Solution(s)	Refer To (Page No.)
Display does not appear when power is turned ON.	The battery is exhausted. → Turn OFF the power and replace the batteries.	4, 6
Nothing appears on the display Even after new batteries are inserted.	The contrast of the display is not adjusted properly. → Adjust the contrast with the contrast adjuster.	33
Battery indicator “  ” is blinking.	The battery is exhausted. → Turn OFF the power and replace the batteries.	4, 6

11.2 Initial Operation Check



Symptom	Possible Cause(s) / Solution(s)	Refer To (Page No.)
Display is too dark/light	The contrast of the display is not adjusted properly. → Adjust the contrast with the contrast adjuster.	33
“NO PROBE!” is displayed on the screen.	Probe is not connected. → Turn off the power and connect a probe into the instrument.	5
Incorrect measurement unit	Set appropriate unit of temperature (°C, °F), absolute humidity (g/m ³ , lb/ft ³), and humidity ratio (g/kg, lb/lb).	30

11.3 Check While Measuring

Symptom	Possible Cause(s) / Solution(s)	Refer To (Page No.)
Reading is displayed as “**.*”.	Measurement range is exceeded. → The instrument must be used in the specified measurement range.	41
Reading is displayed as “----”. Or it is kept showing as “0”.	Probe may not be connected property. → Check the connection.	5
	Probe wire disconnection or sensor damage. → Contact your local distributor for repair.	
CO and CO2 readings are not correct.	Probe sensor may be too close to expiratory air. → Keep a sensor away from expiratory air as much as possible.	7
Temperature reading is high.	Correct reading cannot be obtained when there is not airflow. → Gently move probe	8
Humidity reading is lower than Assman Psychrometer.	Assman Psychrometer is an intricate instrument and there are great differences between each psychrometer. Check the measurement method.	8

11.4 Printer Check

Problem	Possible Cause(s) / Solution(s)	Refer To (Page No.)
Printing Failure	Confirm that the printer cable is connected properly.	20
	Confirm that the Baud Rate is set properly. → Check the instrument and printer settings.	20

	Printer may not be compatible (DPU-H245 and DPU-201GS are recommended). → Check your printer type.	20
	Printer may not be connected in the right order. → After connecting the printer, turn on the instrument first, and then turn on the printer.	20
Unable to printout the display.	Display is not frozen. → Press  key to hold the display, and then press  key to print out.	20
Unable to cancel printing.	You cannot cancel printing.	20

11.5 Digital Output Check

Problem	Possible Cause(s) / Solution(s)	Refer To (Page No.)
Data Transfer Failure	Confirm that the RS232C cable is connected properly. Make sure that it is not confused with the printer cable.	24
	Confirm that the Baud Rate is set properly. → Check the instrument and printer settings.	24
	Communication command may not be correct.	25

11.6 Analog Output Check

Problem	Possible Cause(s) / Solution(s)	Refer To (Page No.)
Output Failure	Confirm that the polarity of the output terminal is correct.	27
	The reading may be in HOLD mode.	27
Output appears in tiered pattern.	Output is set per second.	27
Incorrect Output Value	Analog output setting may be incorrect.	27
	Output value range setting may be incorrect.	27
	Load impedance may be set lower than the specified value. → Load impedance must be set to 5K Ω and over.	27

11.7 Calibration Check

Problem	Possible Cause(s) / Solution(s)	Refer To (Page No.)
[-ERR] appears during the CO SPAN calibration.	Output level of CO sensor may be exceeded the normal range or the sensor is damaged. Contact your local distributor for repair. * The sensor life is 1-1.5 year. (Although SPAN calibration is not available when output level is low, it is possible to take a measurement using existing calibration value.)	38
[-ERR] appears during the CO ₂ SPAN calibration.	Output level of CO ₂ sensor may be exceeded the normal range or the sensor is damaged. Contact your local distributor for repair. (Although SPAN calibration is not available when output level is low, it is possible to take a measurement using existing calibration value.)	38

12. Warranty and After-sales Service

Kanomax Limited Warranty

The limited warranty set below is given by KANOMAX with respect to the KANOMAX brand IAQ Monitor, its attachment parts including Probe and other accessories (hereafter referred to as “PRODUCT”) that you have purchased. PRODUCT you have purchased shall be the only one that the limited warranty stated herein applies to.

Your PRODUCT, when delivered to you in new condition in its original container, is warranted against defects in materials or workmanship as follows: for a period of one (1) year from the date of original purchase, defective parts or a defective PRODUCT returned to your sales representative, as applicable, and proven to be defective upon inspection, will be exchanged for a new or comparable rebuilt parts, or a refurbished PRODUCT as determined by your sales representative. Warranty for such replacements shall not extend the original warranty period of the defective PRODUCT.

This limited warranty covers all defects encountered in normal use of the PRODUCT, and does not apply to the following cases:

- (1) Use of parts or supplies other than the PRODUCT sold by your sales representative, which cause damage to the PRODUCT or cause abnormally frequent service calls or service problems.
- (2) If any PRODUCT has its serial number or date altered or removed.
- (3) Loss of damage to the PRODUCT due to abuse, mishandling, improper packaging by the owner, alteration, accident, electrical current fluctuations, failure to follow operating, maintenance or environmental instructions prescribed in the PRODUCT's instruction manual provided by KANOMAX, or service performed by other than KANOMAX.

NO IMPLIED WARRANTY, INCLUDING ANY IMPLIED WARRANTY OF MERCHANTABILITY OR FITNESS FOR A PARTICULAR PURPOSE, APPLIES TO THE PRODUCT AFTER THE APPLICABLE PERIOD OF THE EXPRESS LIMITED WARRANTY STATED ABOVE, AND NO OTHER EXPRESS WARRANTY OR GUARANTY, EXCEPT AS MENTIONED ABOVE, GIVEN BY ANY PERSON OR ENTITY WITH RESPECT TO THE PRODUCT SHALL BIND KANOMAX. KANOMAX SHALL NOT BE LIABLE FOR LOSS OF STORAGE CHARGES, LOSS OR CORRUPTION OF DATA, OR ANY OTHER SPECIAL, INCIDENTAL OR CONSEQUENTIAL DAMAGES CAUSED BY THE USE OR MISUSE OF, OR INABILITY TO USE, THE PRODUCT, REGARDLESS OF THE LEGAL THEORY ON WHICH THE CLAIM IS BASED, AND EVEN IF KANOMAX HAS BEEN ADVISED OF THE POSSIBILITY OF SUCH DAMAGES. IN NO EVENT SHALL RECOVERY OF ANY KIND AGAINST KANOMAX BE GREATER IN AMOUNT THAN THE PURCHASE PRICE OF THE PRODUCT SOLD BY KANOMAX AND CAUSING THE ALLEGED DAMAGE. WITHOUT LIMITING THE FOREGOING, THE OWNER ASSUMES ALL RISK AND LIABILITY FOR LOSS, DAMAGE OF, OR INJURY TO THE OWNER AND THE OWNER'S PROPERTY AND TO OTHERS AND THEIR PROPERTY ARISING OUT OF USE OR MISUSE OF, OR INABILITY TO USE, THE PRODUCT NOT CAUSED DIRECTLY BY THE NEGLIGENCE OF KANOMAX. THIS LIMITED WARRANTY SHALL NOT EXTEND TO ANYONE OTHER THAN THE ORIGINAL PURCHASER OF THE PRODUCT, OR THE PERSON FOR WHOM IT WAS PURCHASED AS A GIFT, AND STATES THE PURCHASER'S EXCLUSIVE REMEDY.

After Service

Whenever the PRODUCT is malfunctioning, please check with “Troubleshooting” to find possible cause first.

Repair parts are retained for a minimum period of five (5) years after production cessation of the PRODUCT. This storage period of repair parts is considered as the period during which KANOMAX can provide repair service.

For more information, please contact your sales representative. When you make a call, please have the following information of your PRODUCT at hand:

- (1) PRODUCT name;
- (2) Model number;
- (3) Serial number;
- (4) Probe number;
- (5) Description of Symptom, and;
- (6) Date of purchase

13. Contact Information



JAPAN & ASIA

KANOMAX JAPAN INC.

2-1 Shimizu, Suita City, Osaka, 565-0805, Japan

TEL: 81-6-6877-0183 **FAX:** 81-6-6879-5570

URL: <http://www.kanomax.co.jp/>

E-Mail: sales@kanomax.co.jp

USA & EUROPE

KANOMAX USA INC.

PO Box 372, 219 Route 206, Andover, NJ 07821, U.S.A.

TEL: (800)-247-8887 / (973)-786-6386 **FAX:** (973)-786-7586

URL: <http://www.kanomax-usa.com/>

E-Mail: info@kanomax-usa.com

CHINA

Shenyang Kano Scientific Instrument Co., Ltd

No. 12, 4 Jia Wencui Road Heping District

Shenyang City, PRC

TEL: 86-24-23845309 **FAX:** 86-24-23898417

URL: <http://www.kanomax.com.cn/>

E-mail: sales@kanomax.com.cn

Copyright © Kanomax Japan Inc. All rights reserved.

2014

No copying, distribution, publication, modification, or incorporation of this document, in whole or part, is permitted for commercial purposes without the express written permission of Kanomax.

The contents of this document may be changed without prior notice.

05001/14.10



KANOMAX
The Ultimate Measurements