



KANOMAX
The Ultimate Measurements

ANEMOMASTER™

Professional/Standard

MODEL 6036/6035

Handheld Anemometer

User's Manual

List of Components

■ Standard

Items	MODEL	QTY	Functions	
ANEMOMASTER Standard Main Body	6035-00	One of these	Straight Probe To measure air velocity, air temp, and volumetric flow rate.	-
	6035-A0			With analog output function
	6035-B0			With pressure sensor
	6035-C0			With analog output function and pressure sensor
ANEMOMASTER Professional Main Body	6036-00		Articulating Probe To measure air velocity, air temp, and volumetric flow rate.	-
	6036-A0			With analog output function
	6036-B0			With pressure sensor
	6036-C0			With analog output function and pressure sensor
Operation Manual	-	1	This manual	
*USB Cable	-	1	To connect a printer to the main body	
*Measurement Software CD-ROM	-	1	Data acquisition software (6036-41) PC-LINK software (6036-42)	
Carrying Case	-	1	To store the main body and accessories	
AA Batteries	-	6	Alkaline batteries, 1.5V	

*Available on MODEL6036 only

■ Available Accessories

Items	MODEL	Functions
AC Adapter	6113-02	Power source
*Printer	DPU- S245	To print out stored data
*Printer Cable	6000-31	To connect a printer to the main body
Hands-free Case	6000-61	For hands-free measurement

*Available on MODEL6036 only

Important Safety Information

The symbols for the warnings used in this manual are defined below.

Classifications



Danger: To Prevent Serious Injury or Death

Warnings in this classification indicate danger that may result in serious injury or death if not observed.



Caution: To Prevent Damage to the Product

Warnings in this classification indicate risks of damage to the product that may void the product warranty if not observed.

Description of Symbols



△ This symbol indicates a condition that requires caution. The subject of each caution (including danger) is illustrated inside the triangle (e.g. the high temperature caution symbol is shown on the left).



⊘ This symbol indicates a prohibition. Do not take the prohibited action shown inside or near this symbol (e.g. the disassembly prohibition symbol is shown on the left).



● This symbol indicates a mandatory action. A specific action is given near the symbol.



Danger



Forbidden

Never bring the probe close to a flammable gas atmosphere. The heated sensor may cause a fire or explosion.



Don't touch



Hot surface

Never touch the sensor.

The sensor is heated during operation. Touching the heated sensor may cause burns, and may also damage the sensor itself.



Use properly



Explosive

Do not disassemble or heat the batteries, or put them into a fire.

This may cause burns and the batteries may burst.



Caution

If abnormal noises, smells or smoke occur, or if liquid enters the instrument, turn off the instrument immediately, and remove the batteries or pull out the plug.

There is possibility of malfunction, electric shock, and/or fire. Please contact your local distributor or our service center for repair.



Caution



Use properly



Always unplug the instrument from the electrical outlet when the instrument is not in use.

Failure to do so may cause an electrical shock, fire or circuit damage.



Forbidden

Do not use the instrument in a water vapor atmosphere.

Condensed steam on the sensor will change the heat dissipation rate, resulting in inaccurate measurements. It may also cause damage to the sensor.



Forbidden

This instrument is designed to be used in an environment with a clean air stream without any dust or foreign materials.

Foreign materials may cause damage to the sensor. Also dust or foreign materials on the sensor will impede accurate measurements.



Forbidden

Do not apply force to the sensor.

If the sensor is deformed, the accuracy of the sensor may be affected.



Set up properly

When measuring, ensure that the direction mark is facing into the airflow.

Otherwise, the measurement may be inaccurate, as some sensors (uni-directional probes) have a specific directivity.



Forbidden

Do not use or leave the instrument in a high temperature, high humidity or dusty environment. Do not leave this instrument under direct sunlight for a prolonged period.

The instrument may not function properly out of the specified operating conditions.



Forbidden

Do not subject the instrument or the probe to strong impacts.

Dropping the unit or placing heavy objects on it may cause damage or malfunction to the instrument.



Do not remodel/
disassemble

Never disassemble, modify or repair the product.

Failure to observe the above may cause short circuit and/or other failure that will affect the performance.



Forbidden

Do not pick up or carry the instrument by the probe cable.

It may cause a malfunction or the wire may break.



Use properly

Remove the batteries from the battery compartment when storing the instrument for a long period. Do not leave exhausted batteries in the battery compartment. When inserting batteries be sure to insert them with the polarity facing the correct direction.

Failure to do so may cause battery leakage.



Forbidden

Do not wipe the instrument with a volatile solvent.

The body may deform or deteriorate. Use a soft dry cloth to remove stains. If stains persist, soak the cloth in a neutral detergent and wipe the instrument with the soft cloth. Never use volatile solvents such as thinner or benzene.



Forbidden



Electrified

Discharge any built-up static electricity from your body before touching the instrument.

The built-up static electricity may influence the readings and cause damage to the circuit.



Forbidden



Use properly

Regularly check the head of the probe for contamination.

Impurities (such as dust) on the sensor may affect the accuracy of the measurements.

To get rid of dust, use a blow blush for cameras to blow it off, or you can rinse it with water and allow it to air-dry completely.

*Be sure to turn the power off before you clean it.

*Never dry the probe with heat. (Heat may cause permanent damage to the sensor.)



Forbidden

Do not move the main unit and the probe from a cold place to a warm place quickly. It will cause dew condensation.

Even when used in an environment within the specified operating temperature and humidity, a sudden temperature change may cause condensation. Condensation generated on the sensor may cause inaccurate measurements. Condensation on metal parts may cause rusting and lead to a malfunction.



Forbidden

Do not touch the LCD screen with a sharp-pointed object or with excessive pressure.

It may cause distortion of the screen or a malfunction. Also a rapid temperature change may cause a malfunction of the screen.



Use properly

When storing the instrument, put the instrument in the carrying case and keep it in a place with an ambient temperature of -10 to 50°C and no condensation.



Forbidden

Do not dispose of the instrument as a household waste.

Please note that the disposal of the instrument and the batteries should be in line with your local or national legislation. For details, please contact your local distributor.

Table of Contents

§ 1	Part Names and Functions	7
	Overview	7
	Main Body	8
	Touch Panel	9
	Probe.....	10
§ 2	Getting Started	11
	Installing Batteries	11
	Turning ON/OFF the Power	12
	Precautions for Measurements	14
	Duct Shape / Size Input	14
§ 3	Measurement	16
	Setting the Time Constant	17
§ 4	Data Storage and Statistical Calculation	18
	Storing Measured Data.....	18
	Data Storage and Statistical Calculation Procedure	18
	Viewing and Deleting Stored Data	20
§ 5	Setting the Measurement Unit and Baud Rate	21
§ 6	Data Output	22
	Printing Out the Measurement Data (MODEL6036)	22
	Analog Output	25
	USB Serial Communication	25
§ 7	Cleaning the Probe	26
	Method of Cleaning.....	26
§ 8	Specifications	27
§ 9	Measurement Principles	28
§ 10	Air Velocity Compensation	30
	Influence of Air Temperature	30
	Influence of Atmospheric Pressure.....	30
	Influence of Air Composition	30
§ 11	Probe Directivity (Air Velocity)	31
§ 12	Troubleshooting	32
	Various Status Displays	33
§ 13	Warranty and After Service	34
	Kanomax Limited Warranty.....	34
§ 14	Contact Information	35

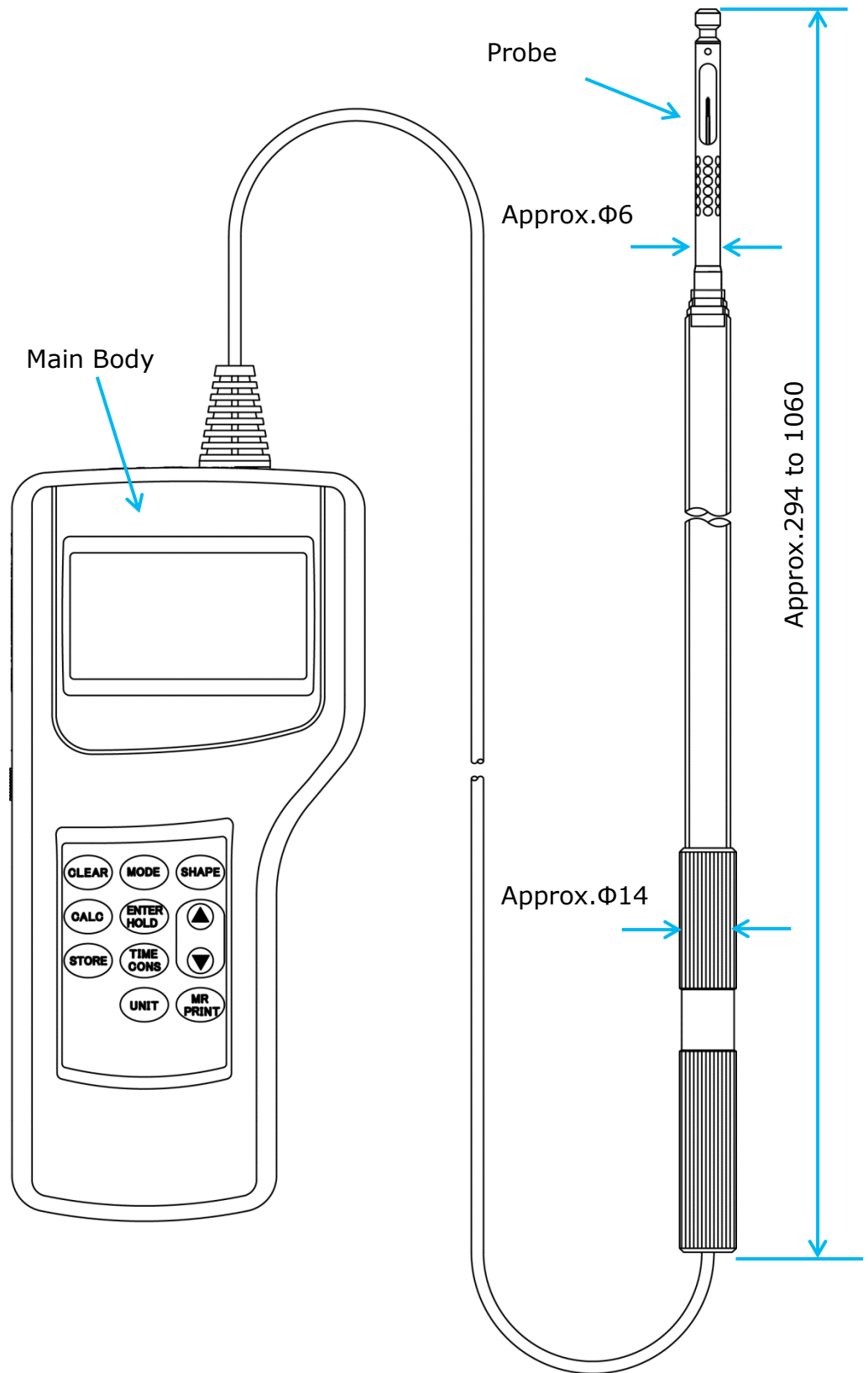

Main Body

Unit: mm

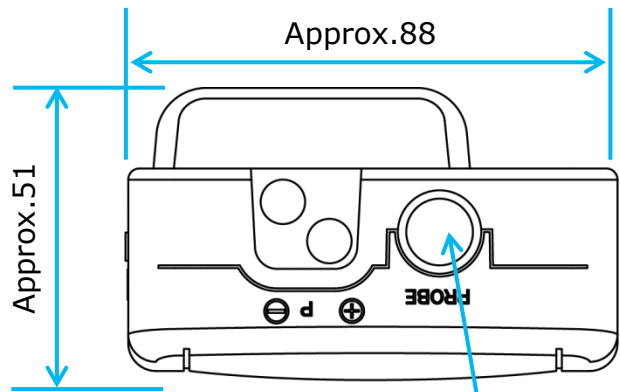

- Analog output is available on MODEL6535-A0 /-C0 and MODEL6536-A0 /-C0

Analog Output Terminal

Serial Communication Terminal

DC Input Terminal

Probe Socket

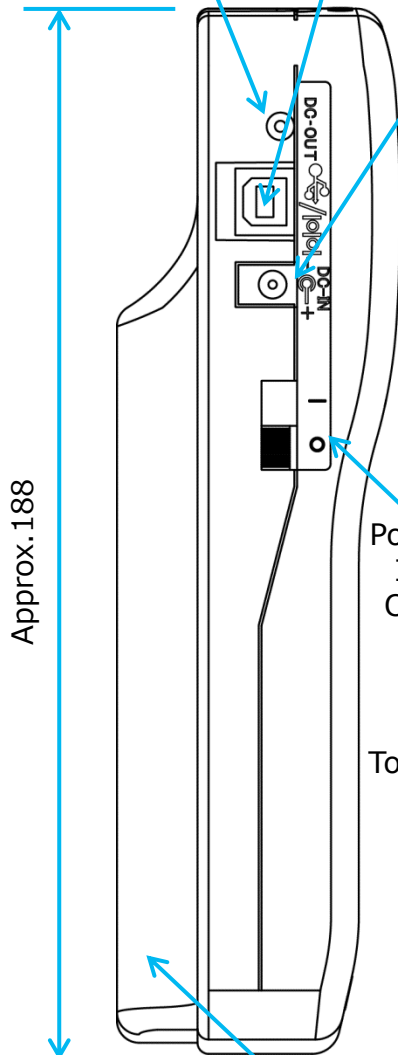

Power Switch
I: ON
O: OFF

Touch Panel

Battery Compartment

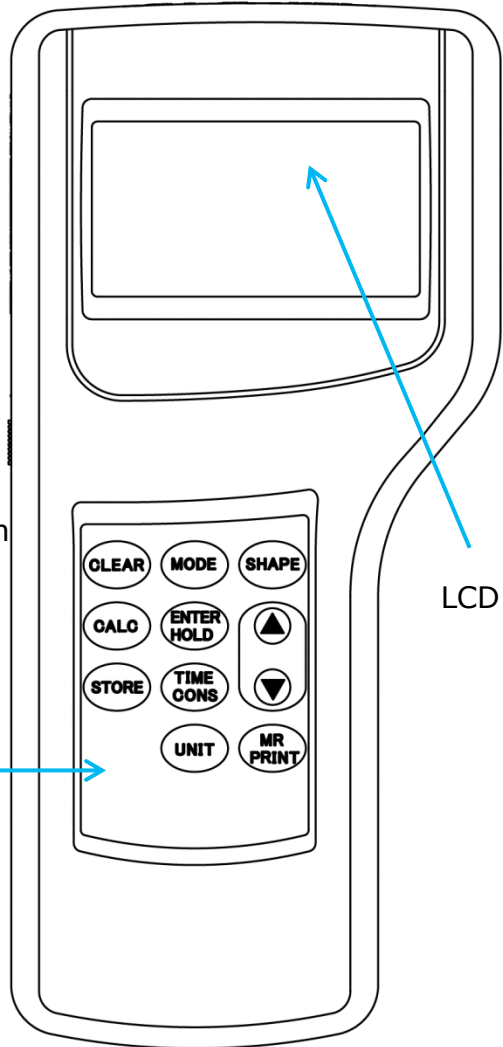

Touch Panel

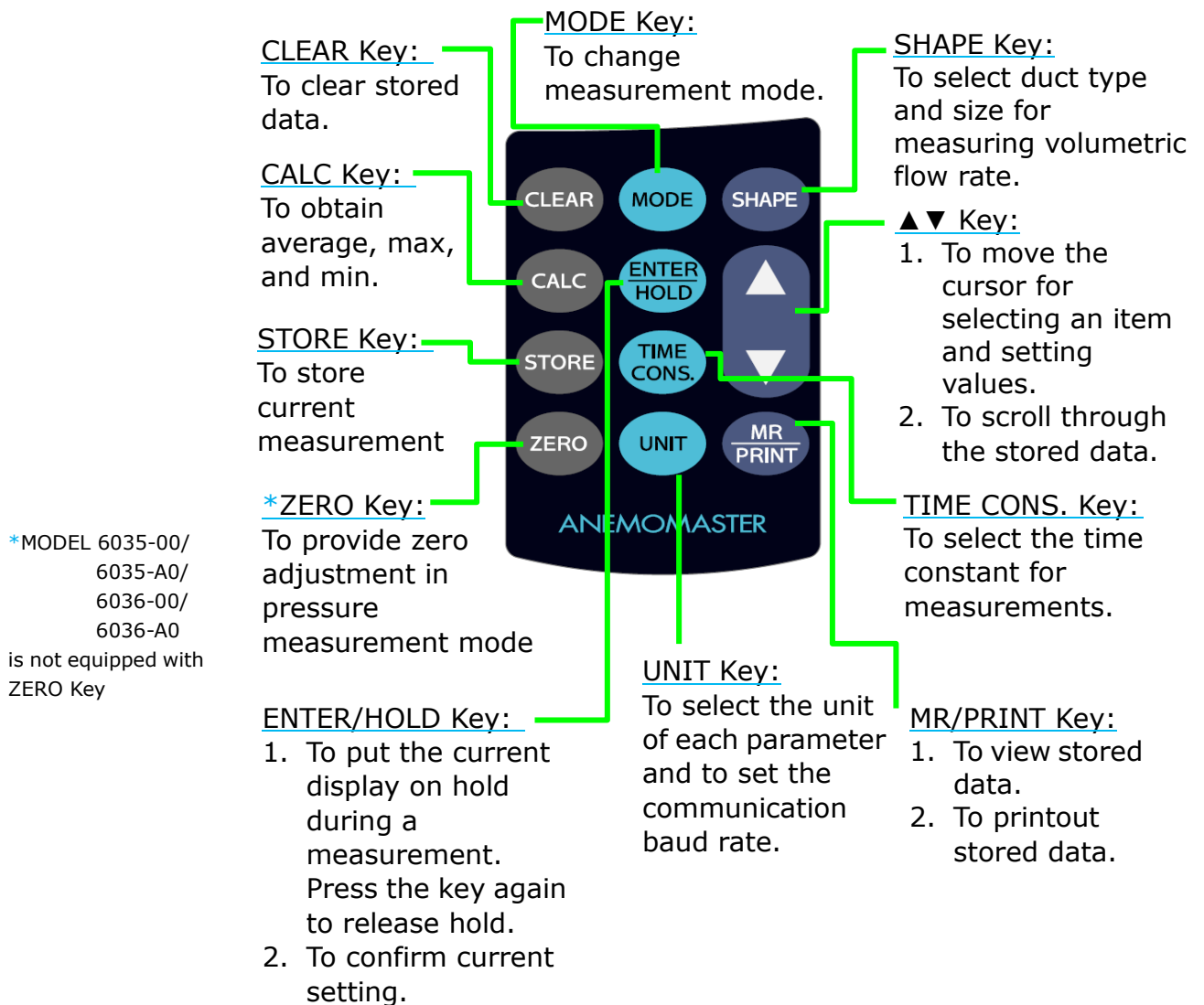

<Straight Probe (MODEL6035)>

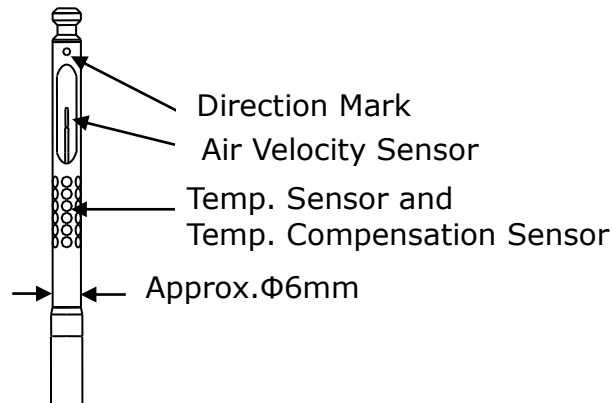

**<Articulating Probe (MODEL6036)>
-How to extend the Articulating Probe-**

Caution:

Do not excessively bend the flex-neck or apply excessive force. When the instrument is not in use, the probe must be returned to the original position and stored.

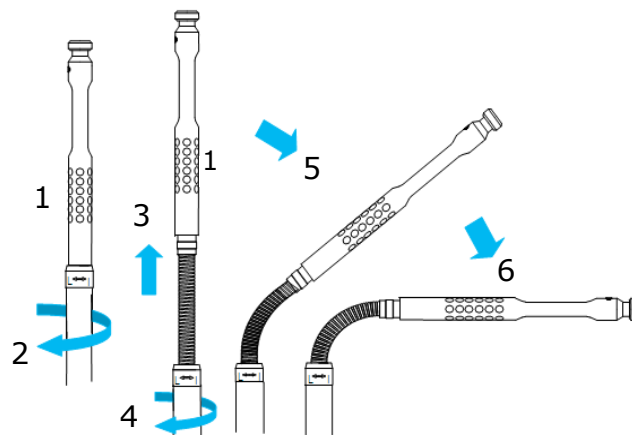

1. Hold the upper part 1 of the probe, and unscrew 2.
2. Pull out the flex-neck 3. Fix the probe in its extended position by holding 1 and turning 4.
3. Slowly bend the flex-neck. (5&6).

Backside of the body

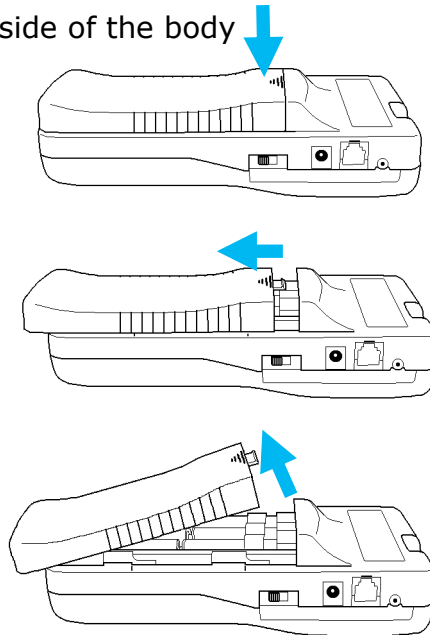

1. Press down on the battery cover with your finger as shown left.

2. Slide the cover toward the bottom of the instrument until it stops,

3. Lift the cover away from the body.

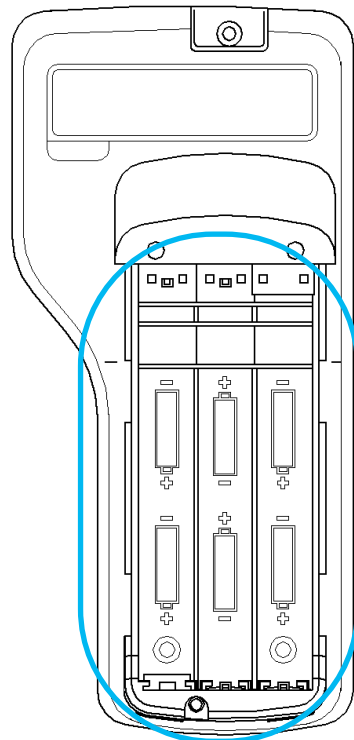

4. Insert the batteries according to the indicated polarity chart. The instrument requires six (6) AA size batteries. Types of batteries that can be used are: Manganese, Alkaline, Ni-Cd batteries, or Ni-MH batteries. The six (6) batteries must be of the same type. DO NOT mix different types of batteries. Failure to observe this may cause battery leakage or damage to the instrument.

*Batteries CANNOT be recharged by the AC adapter.

*When using charging batteries, please recharge them with the special charger for those batteries.

Types of Batteries that can be Used.

- Manganese (R6), AA batteries
- Alkaline (LR6), AA batteries
- Ni-Cd, AA batteries
- Ni-MH, AA batteries

5. Put the cover back on by reversing the above procedures.

Turning ON/OFF the Power

The power switch to turn the power ON/OFF is located at the side of the instrument.

When powered up, the LCD test screen will be displayed before it switches to the Air Velocity / Air Temperature measurement screen in approx. 2 seconds.

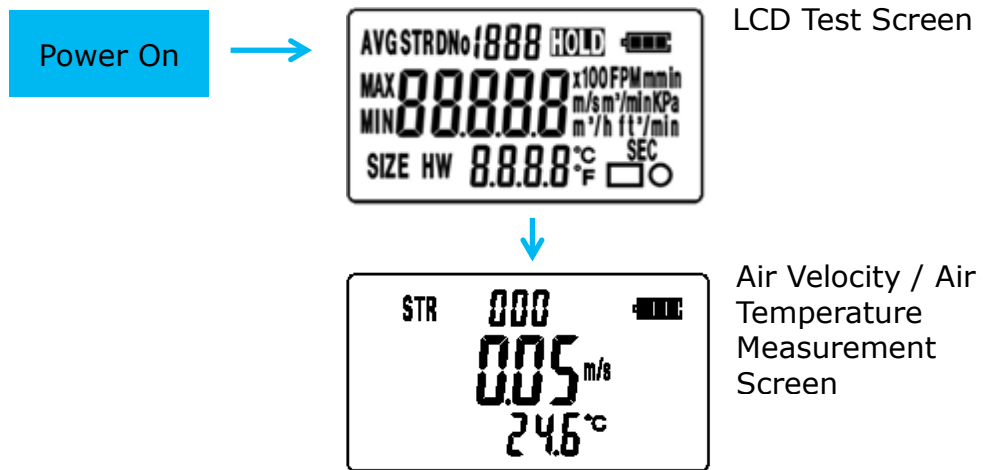
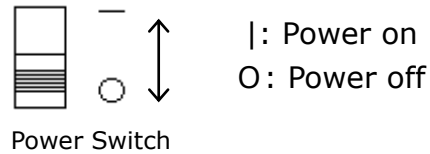

Calibration Reminder

One year after the last calibration, the Annual Calibration Reminder will display on the screen.

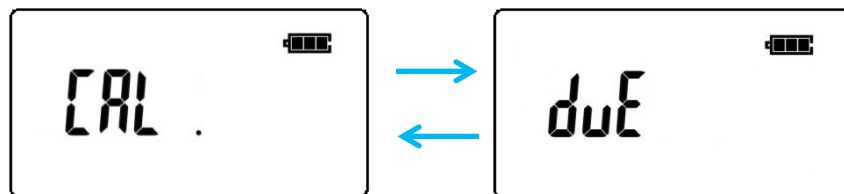

Calibration Reminder Screen

Press any key or wait for 10 seconds to return to the Normal Measurement Screen.

Battery Level Indicator



Check the "Battery Level Indicator" to confirm the remaining battery level. The battery consumption rate largely depends on the measured air velocity. When the batteries need to be replaced (or recharged), the indicator will start blinking.

- When using a charging battery, the battery level may be indicated as low even right after recharging because of its low nominal voltage (1.2V).
- The screen may freeze if high velocity is measured when the battery level indicator is blinking.

The indicator changes as indicated below according to the remaining battery level:



Blinks
Batteries must
be replaced

- Locked Status -

When  is displayed, all functions of the instrument will be locked. The current measurement will be cancelled and data will NOT be saved. To release the lock, turn off the power and replace the batteries.

Precautions for Measurements

Air Velocity Measurement Precautions

- The probe has its own directivity characteristics. Make sure that the direction mark is facing into the airflow (for details of the directivity characteristics, refer to "Probe Directivity (Air Velocity)" on P.31). If you are not sure of the airflow direction, slowly rotate the probe and select the point where you get the maximum velocity reading,

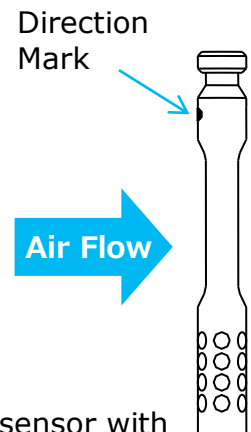

- The probe compensates air velocity change due to temperature change by using the air velocity sensor with the temperature compensation sensor. In order to obtain this compensation effect, it is required that both sensors are evenly exposed to the airflow under the same temperature conditions.

- For measurements in an environment with rapid air temperature changes, measure for at least 20 seconds and wait for the reading to stabilize before starting the actual measurement (i.e. the data will not be accurate until the probe has time to acclimate to the environment.).



Air Temperature Measurement Precautions

- The response time for temperature measurement improves as the air velocity increases. Wait for the reading to become stable before taking a measurement.

- When no airflow is present, the air temperature reading may be higher than the actual temperature due to the heat generated by the air velocity sensor. It is recommended that you SLOWLY wave the probe to create an environment with approx. 0.1m/s airflow to obtain accurate temperature readings.

Duct Shape / Size Input

Before measuring the volumetric flow rate, duct shape and size settings must be entered.

Duct Shape: There are two duct shapes – Rectangular and Circular, which are indicated as  and  at the lower right corner of the LCD screen.

Size of Duct: For a rectangular duct, set the width (W) and height (H). For a circular duct, set the diameter (D).

Size Range: Maximum dimension of a side: 2550mm

Input Increment: Range of 0 to 1000mm: 1mm

Range of 1000 to 2550mm: 10mm

*When inch is selected for the input unit, the maximum dimension will be 255 inch.

Input Increment: Range of 0 to 100inch: 0.1inch

Range of 100 to 255inch: 1inch



Press **SHAPE** key to enter the setting screen.

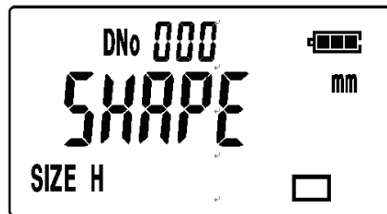

<Registering a Rectangular Duct>



Select  with the   keys, and press the **ENTER HOLD** key.



<Registering a Circular Duct>



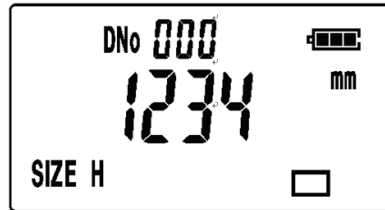

Select  with   keys, and press the **ENTER HOLD** key.



<Entering the Dimension of a Rectangular Duct>

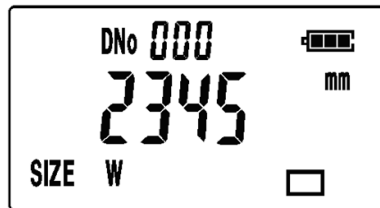
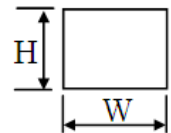

Set the height (H) with   keys and press the **ENTER HOLD** key.





Set the width (W) with   keys and press the **ENTER HOLD** key.

*Press and hold either of the   keys over 2 seconds, and the increment speed will accelerate.



<Entering the Dimension of a Circular Duct>

Set the diameter (D) with   keys and press the **ENTER HOLD** key.

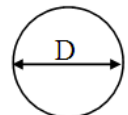

Measurement

When the instrument is turned on, the LCD test screen will be displayed for approx. 2 seconds. The test screen will then switch to the Air Velocity / Air Temperature measurement screen. The display is updated every 1 second.

Changing the Measurement Mode

To change the measurement mode, press the **MODE** key while each measurement screen is displayed. The screen changes as shown below.

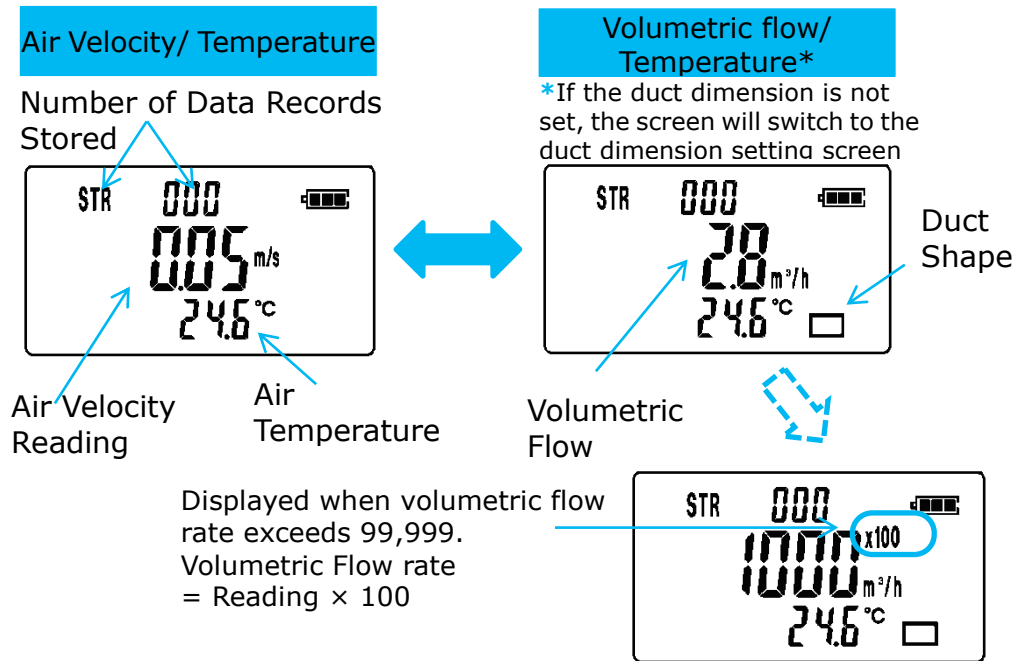

Hold the Reading

* For data storage, refer to "Data Storage and Statistical Calculation Procedure" (P.18).

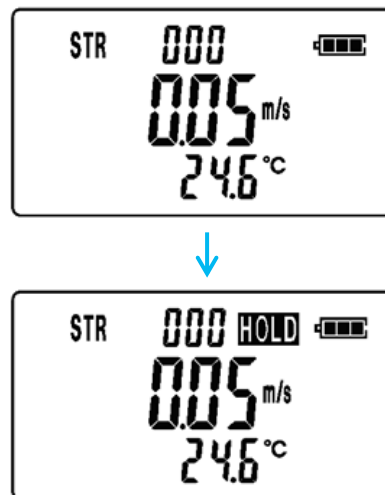

While measuring, press the **ENTER/HOLD** key to hold the current reading.

HOLD mark will be displayed at the upper right of the reading while the reading is held.

To recover from the hold mode, press the **ENTER/HOLD** key again.

By pressing the **STORE** key while the reading is held, the displayed reading will be saved temporarily in the memory, and hold mode will be released to resume measurement.

Setting the Time Constant

When there is rapid change in the measurement data, the readings may become difficult to read. In such case, the speed of updating the readings can be reduced by changing the time constant setting.

*Time constant can be set only for Air Velocity and Volumetric Flow measurements.

Time Constant determines the time span of the moving average. When a larger (longer) time constant is selected, the readings will be rather stable, and when a smaller (shorter) time constant is selected, the readings will be more responsive and sensitive to the change.

*The time constant selected from 1, 5, 10 and 20 seconds will be initialized once the power is turned off, and will return to the default setting of 1 second.

The time constant can be selected from 1, 5, 10 or 20 seconds.





< Time Constant Setting Screen >

By pressing the  key in a measurement mode, the display switches to the time constant setting screen.

Time Constant

Time cons. unit

EXAMPLE: when setting the time constant to 20 seconds:

Select the time constant "20.0" by pressing   keys, and press the  key.

§ 4

Data Storage and Statistical Calculation

Storing Measured Data

- Data storage function is only available on MODEL6036

Measured data can be stored in the built-in memory of the instrument. The instrument can hold up to 1500 data records. When storing the measured data, average, maximum and minimum values will be calculated for the data group to be stored. Each data group is stored with a storage number (shown as DNo xxx) which starts from 001 for each mode. Contents of the data stored in each measurement mode are shown in the following table.

- Pressure mode is available on MODEL6035-B0/6035-C0/6036-B0/6036-C0

Measurement Mode	Stored Data
Air Velocity / Air Temperature	Air Velocity, Air Temperature and Data Storage No.
Volumetric Flow Rate / Air Temperature	Volumetric Flow Rate, Air Temperature, Data Storage No., and Duct Shape/Size
*Pressure / Air Temperature	Pressure, Air Temperature, and Data Storage No.

You can print out the measured data by using the supplied software "PC-LINK Software" or the optional printer.

Data Storage and Statistical Calculation Procedure

Data storage procedure is described below by taking an example of an operation in the "Air Velocity / Air Temperature Measurement Mode". Data storage procedure is same in other mode as well.

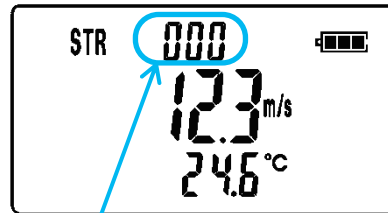

Number stored data records

- Temporary Memory

By pressing the **STORE** key while measuring, the current reading will be stored in the temporary memory.

- Number of Stored Data Records

Indicates the number of data records stored in the temporary memory.

*Temporary Memory – Data will be cleared once measurement mode is changed, the power is turned off or calculation is executed.

- Temporary Data Storage

The displayed reading will be stored in the temporary memory each time the **STORE** key is pressed, and the number of stored data records will increase by one. *A maximum of 1500 data records can be stored.

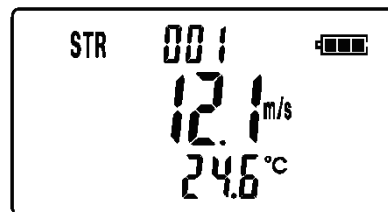

*[No. of data records stored] + [No. of data records that can temporarily be stored] = 1500

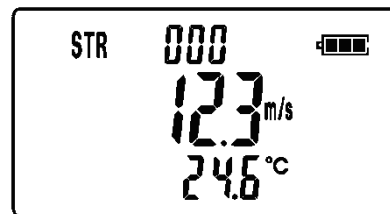
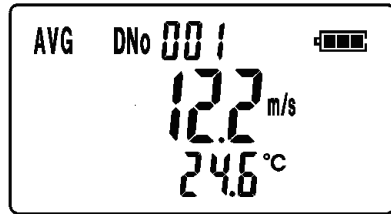

• Data Storage and Statistical Calculation

Press the **CALC** key to execute the statistical calculation (Average, Maximum and Minimum) for the group of data records stored in the temporary memory.

Display will switch in the sequence shown as follows (AVG →MAX→MIN→) as you press the **CALC** key.

• Storing the Calculated Results

To store the calculated results, press the **STORE** key while average, maximum or minimum value is displayed. The display will then return to the original measurement mode and the temporary memory will be cleared.

• To Clear the Data Group

To clear the data group without saving, press and hold the **CLEAR** key while average, maximum or minimum value is displayed. The display will return to the original measurement mode.

*Data records stored in the temporary memory and the calculation results will be cleared.

- On MODEL6035, the screen will return to the measurement mode you were in by pressing **CLEAR** key after calculation

Viewing and Deleting Stored Data

- The function of viewing and deleting stored data is available on MODEL6036

The average, maximum and minimum value of the stored data can be viewed on the display and deleted.



Data viewing and deleting procedure will be described below by taking an example of an operation in the "Air Velocity / Air Temperature Measurement Mode".



•Viewing the Stored Data

Press the  key when the instrument is in the measurement mode in which the data is stored. The most recently stored average value (AVG) will be displayed.

•Viewing Other Data

By pressing the  key, maximum, minimum and average value of the data group can viewed. To move to the previous/next data group, press   keys.

•Exit from Data Viewing

Press the  key to exit (cancel) data viewing. When cancelled, the screen will return to the measurement mode.

•Deleting the Stored Data Group

Select the data group to be deleted, and press the  key. The air velocity value will start blinking.

To delete the selected data, press the  key again. When pressed, *CLEAR* will be displayed. After displaying *CLEAR*, the screen will return to the original measurement mode.

To delete ALL data groups stored in the relevant measurement mode, press and hold the  key for approx. 5 seconds until *CLEAR* is displayed. All Data Groups stored under this mode will be cleared. After *CLEAR* is displayed, the screen will return to the measurement mode.

List of Measurement Units:

- Air velocity: m/s, FPM
- Volumetric flow rate: m³/h, ft³/min, m³/min
- Air temperature: °C, °F
- Length: mm, inch

<Unit Conversion Table>

Air Velocity: 1m/s=196FPM
 Air Temp: T (°F)=1.8×T(°C)+32
 Volumetric Flow: 1 m³/h=35.32 ft³/h
 Length: 1inch=25.4 mm

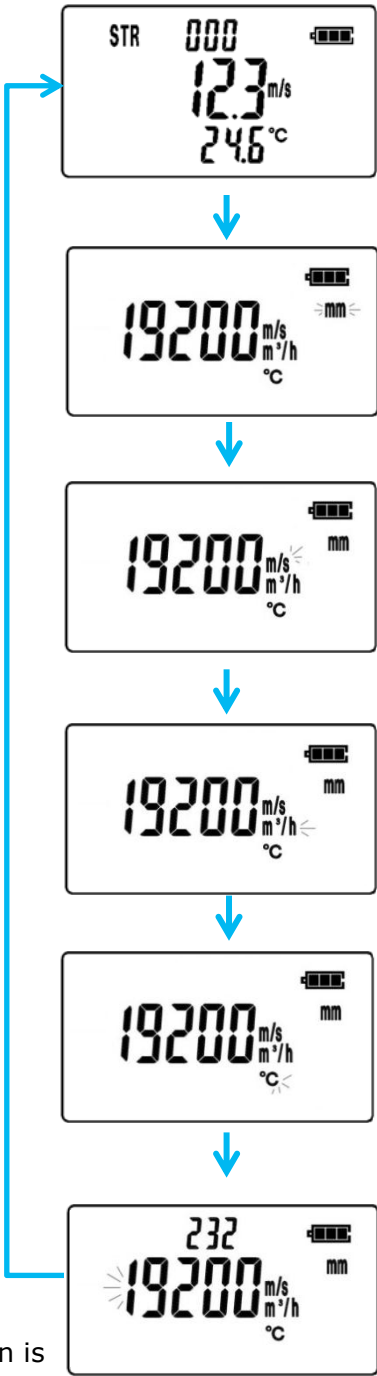

• Measurement Mode

Press the **UNIT** key to enter the unit setting mode.

• Length Unit

The unit to be set will blink. Use **▲** **▼** keys to select the unit. Press the **ENTER HOLD** key to save the setting and to proceed to the next unit setting.

• Air Velocity Unit

Repeat the above procedure for each unit.

• Volumetric Flow Unit

• Air Temperature Unit

• Baud Rate

Serial communication baud rate used in this instrument is shown on the right.

- 4800bps
 - 9600bps
 - 19200bps
 - 38400bps

■ Serial communication is only available on MODEL6036

§ 6

Data Output

- Print function is only available on MODEL6036

Printing Out the Measurement Data (MODEL6036)

To print out the stored measurement data, an optional printer and printer cable are required. The printer cable must be connected to the serial communication terminal located on the side of the instrument.

Serial Communication Terminal

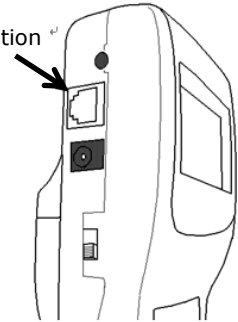

<Requirements>

- Printer (optional)
- Printer Cable (optional)

<Communication Protocol>

You need to enter the same baud rate and data transmission conditions on both the Main Body and the printer.

Data Bit Length	8 bit
Parity	None
Baud Rate	Set Value
Stop Bit	1

➤ For how to set the baud rate of the instrument, refer to "Setting the Measurement Unit and Baud Rate". (P.21)

- For settings of the printer, please refer to the operational manual of the printer.

<Connecting the Printer and the Instrument>

1. Connect the printer and the instrument with the printer cable by inserting the printer cable in the serial communication terminal located at the side of the instrument.
2. Turn on the power of the instrument first, and then turn on the printer.
3. Confirm that the instrument is in the measurement mode.

Printing Directly from the Measurement Mode

Procedure for printing directly from the measurement mode is described below, taking an example of an operation in the "Air Velocity/Air Temperature Measurement Mode".



Hold the reading by pressing the **ENTER HOLD** key.

HOLD sign will be displayed in the upper right part of the LCD screen.

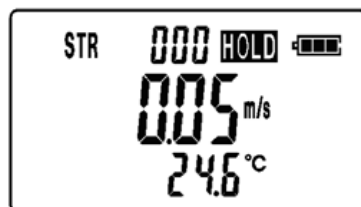

Press the **MR PRINT** key to execute printing. While printing, *Print* will be displayed on the screen.



When printing is complete, the screen will return to the measurement screen with the reading held. Measurement can be resumed by releasing the hold mode.

Printout Examples (Measurement Mode)

Measurement Mode		
Air Velocity / Air Temperature	Volumetric Flow / Air Temperature	Pressure/Air Temperature
<ul style="list-style-type: none"> EXAMPLE Vel 0.15m/s Temp 21.8°C	<ul style="list-style-type: none"> EXAMPLE (Rectangular duct) Duct Shape R Size 2550*2550mm FlowRate 407.3 m3/h Temp 22.5°C <ul style="list-style-type: none"> EXAMPLE (Circular duct) Duct Shape C Size 2550mm FlowRate 407.3m3/h Temp 23.6°C	<ul style="list-style-type: none"> EXAMPLE Press 1.03kPa Temp 20.1°C

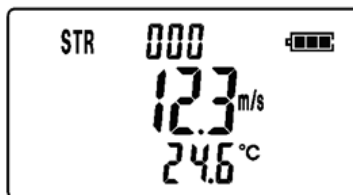

Printing Out Stored Data

Procedure of printing the stored data is described below by taking an example of printing the sixth data group stored in the "Air Velocity / Air Temperature Measurement Mode".

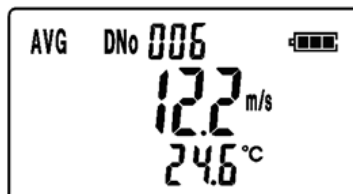

Press the  key in the measurement mode. The most recently stored average value will be displayed.



Select the Data group to be printed by using the   keys. When selected, press the  key and the reading will start blinking. Connect the printer.



Press the  key again to execute printing. On the screen, *Print* will be displayed.

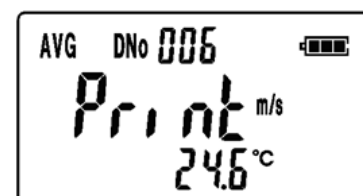

To print all data group stored in this mode, press and hold the  key for approx. 5 seconds until *Print* appears on the screen. All data stored under the relevant mode will be printed out continuously. When printing is complete, the display will return to the measurement mode.

Printout Examples (Stored Data)

Measurement Mode		
Air Velocity / Air Temperature	Volumetric Flow / Air Temperature	Pressure/ Air Temperature
<p>●EXAMPLE for group DNo006</p> <p>DNo.006</p> <p>001 Vel 0.15m/s Temp 21.8°C</p> <p>002 Vel 0.16m/s Temp 21.8°C</p> <p>003 Vel 0.14m/s Temp 21.8°C</p> <p>004 Vel 0.13m/s Temp 21.8°C</p> <p>AVG Vel 0.15m/s Temp 21.8°C</p>	<p>●EXAMPLE for group DNo006 (When the duct shape is Rectangular.)</p> <p>DNo.006 Duct Shape R Size 2550*2550mm</p> <p>001 FlowRate 407.3 m3/h Temp 22.5°C</p> <p>002 FlowRate 405.6 m3/h Temp 22.5°C</p> <p>003 FlowRate 400.9 m3/h Temp 22.5°C</p> <p>004 FlowRate 401.4 m3/h Temp 22.5°C</p> <p>AVG FlowRate 403.8 m3/h Temp 22.5°C</p> <hr/> <p>●EXAMPLE for group DNo005 (When the duct shape is Circular.)</p> <p>DNo.005 Duct Shape C Size 2550mm</p> <p>001 FlowRate 407.3m3/h Temp 23.6°C</p> <p>002 FlowRate 405.6m3/h Temp 23.6°C</p> <p>003 FlowRate 400.9m3/h Temp 23.6°C</p> <p>004 FlowRate 401.4m3/h Temp 23.6°C</p> <p>AVG FlowRate 403.8m3/h Temp 23.6°C</p>	<p>●EXAMPLE for group DNo006</p> <p>DNo.006</p> <p>001 Press 1.03 kPa Temp 20.1°C</p> <p>002 Press 1.02 kPa Temp 20.1°C</p> <p>003 Press 1.01 kPa Temp 20.1°C</p> <p>004 Press 1.00 kPa Temp 20.1°C</p> <p>AVG Press 1.02 kPa Temp 20.1°C</p>

Analog Output

- Analog output is available on MODEL 6035-A0/6035-C0/6036-A0/6036-C0.

Analog output is limited to the output of air velocity in the Air Velocity / Air Temperature Mode.

1. Data update interval0.1sec
2. Load impedance.....5K Ω and above
3. Output voltage.....DC 0~3V (0~30m/s)
4. Polarity of output voltage... \ominus \bullet \oplus

Analog Output Terminal

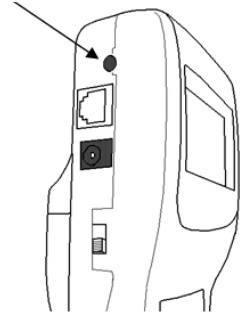

USB Serial Communication

- Serial communication is only available on MODEL6036

For serial communication, the USB cable must be connected to the serial communication terminal located at the side of the instrument.

<Requirements>

- Computer
- USB Cable
- Measurement Software
 1. PC-LINK Software:
For transferring stored data to the PC.
 2. Data Acquisition Software:
For transferring real time data to the PC.

Serial Communication Terminal

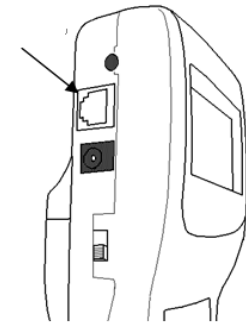

<Connecting the Instrument to a Computer>

1. Turn off the instrument.
2. Connect the instrument to a computer with the USB communication cable.
3. Turn the instrument on.
4. Confirm that the instrument is in normal measurement mode.

*Refer to the digital operation manual provided with the software CD-ROM for operation procedures.

When the sensor is contaminated with impurities such as dust, particles, soot or machine oil, the heat dissipation rate will change. In most cases, heat dissipation will decrease, resulting in lower air velocity readings.

This is same for the probes which are equipped with a mesh cover. The same problem will occur if the mesh is deformed, or clogged with impurities.

If impurities are attached to the sensor or the mesh from using the instrument in an unclean environment, it is recommended that the sensor is cleaned right after use.

Method of Cleaning

Clean the sensor of the probe in an ultrasonic cleaner for approx. 10-20 sec. Do not clean the sensor longer than required as excess cleaning will lead to sensor coating damage.

Use water for cleaning.

The sensor can also be cleaned in a vessel filled with neutral detergent diluted by water, and by gently stirring it in the vessel.

Caution

- Make sure to TURN OFF the power before cleaning.
- Dry the probe completely after cleaning. Do not turn on the power before completely dried.
- Never dry the probe with heat. (Heat may cause permanent damage to the sensor.)

§ 8

Specifications

Product		ANEMOMASTER Standard	ANEMOMASTER Professional
Model		6035	6036
Measuring Object		Clean Air Flow	
Measuring Range (Resolution)	Air Velocity	0.01 to 30.0 m/s (0.00 to 9.99m/s: 0.01m/s, 10.0 to 30.0m/s: 0.1m/s)	
	Air Temperature	-20.0 to 70.0 °C (0.1°C)	
	Pressure* ²	-5.00 to 5.00 kPa (0,01 kPa)	
Duct Size Range		0 to 2550 mm 0 to 255 inch	
Accuracy	Air Velocity	±3% of reading or ±0.015 m/s (±3 FPM), whichever is greater	
	Air Temperature	± 0.5 °C	
	Pressure* ²	±3% of reading or ±0.01 kPa	
Response Time	Air Velocity	Approx.1sec. (at Air Velocity: 1m/s, 90% Response)	
	Air Temperature	Approx.30sec.(at Air Velocity: 1m/s, 90% Response)	
	Pressure* ²	Approx. 1 sec.	
Sampling Functions		<ul style="list-style-type: none"> - Hold the reading - Statistical calculation (Average, Maximum, Minimum) - Time constant setting (1, 5, 10, 20 sec.) - Remaining battery level indicator (4 levels) - Selection of sampling units (Air velocity: m/s; Flow rate: m3/h, m3/min, ft3/min; Air Temperature: °C or °F) - Duct shape setting: Rectangular or Circular / Duct size unit: mm or inch) 	
Data Storage		–	Max. 1500 data records.
External Dimensions		Probe: approx.Φ6(Φ14)x 294 to 1060mm Cable length: approx.2000 mm Main body: approx. 88(W) x 188(L) x 51(H) mm	
Output		Analog output* ¹ : DC 0 to 3V (Only for air velocity output)	Digital output : USB (automatically switched to RS-232C when connected to printer: Baud rate: 4800, 9600, 19200, 38400bps) Analog output* ¹ : DC 0 to 3V (Only for air velocity output)
Power Source		Alkaline AA Batteries×6 (Manganese, Ni-Cd, and Ni-MH batteries can be used as well), AC Adapter* ³ : AC 100 to 240V (50/60Hz)	
Battery Life		Approx.10 hours (when Air velocity: 5 m/s, Air temp: 20°C, and using Alkaline batteries)	
Operating Environment		Main Body: 5 to 40°C (41 to 104 °F) with no visible condensation Probe: -20 to 70°C (-4 to 158 °F) with no visible condensation	
Storage Temperature Range		-10 to 50°C (14 to 122 °F) with no visible condensation	
Weight		Approximately 500 g (batteries included)	
Standard Accessories		Carrying case×1, Operation manual×1, Alkaline AA Batteries×6	
		USB cable×1, Measurement software CDROM(for Windows) x 1	
Optional Accessories		AC Adapter, Printer, Printer cable, ,Hands-free Case	

*1: Analog Output is available on MODEL6035-A0, 6035-C0, 6036-A0, and 6036-C0.

*2: Pressure is available on MODEL6035-B0, 6035-C0, 6036-B0, and 6036-C0

*3: Optional

Hot-wire Anemometer Principle

When the heated air velocity sensor is exposed to airflow, the sensor temperature will change by the heat drawn by the airflow.

Accordingly, the sensor resistance value will change. This change in the resistance value will vary largely as the air velocity increases.

Therefore, if the relationship between the air velocity and the resistance value is known, the air velocity can be obtained by measuring the resistance value (or current).

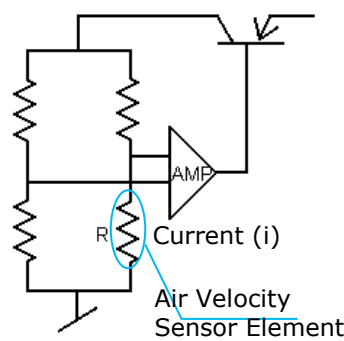
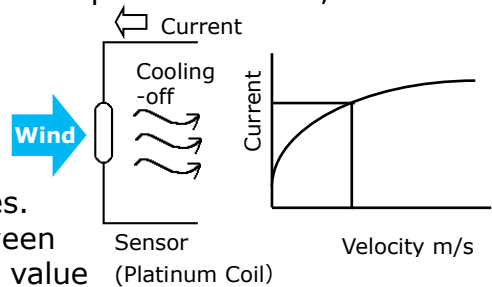

The *Anemomaster* anemometer is based on the above principle. Generally, a hot-wire anemometer employs a feedback circuit to control the sensor to maintain constant temperature. (Constant Temperature Type)

When there is a change in the air velocity, the heat drawn from the sensor (heat dissipation) will change accordingly. In order to maintain constant temperature, current is applied to the sensor to compensate this change. Thus, the air velocity value can be obtained from the amount of the applied current (i).

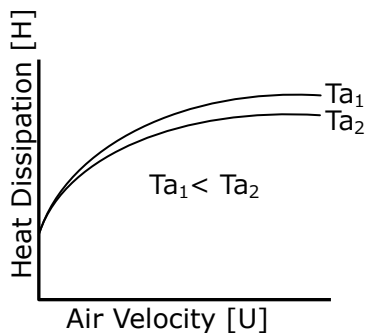

The amount of heat [H] drawn from the air velocity sensor can be expressed by the following formula.

$$H = (a + b\sqrt{U})(T - Ta) \dots\dots\dots\text{King's Formula}$$

- Where; H: Heat Dissipation
- T: Sensor Temperature
- Ta: Air Temperature
- U: Air velocity
- a, b: Constant

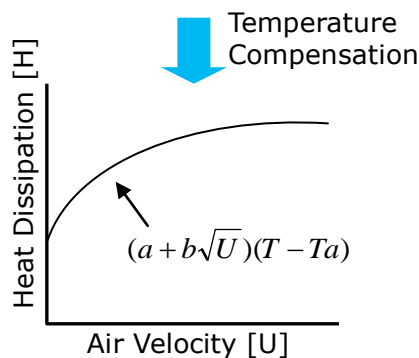

The Heat Dissipation [H] can also be expressed by the following form sensor resistance (R) and current (i).

$$H = RI^2$$

(R is kept constant regardless of the air velocity change)

Thus: $RI^2 \propto a + b\sqrt{U}$

As shown by this formula, the change in the air velocity "U" can be interpreted as the change in the current "i".

- **Temperature Compensation -**

When the air temperature changes, the amount of heat dissipation will change accordingly even the air velocity is constant. Thus, *Anemomaster* employs a temperature compensation circuit to enable accurate air velocity measurement by eliminating the influence to the temperature change. For this purpose, a temperature measurement sensor R_c having the same temperature coefficient as the air velocity is provided at the opposite side of the bridge, and the bridge is adjusted so that the difference with the air temperature ($T - T_a$) is kept constant.

- **Air Temperature Measurement -**

An air temperature element (platinum resistor) which its resistance value changes by the air temperature is incorporate din on side of the bridge. The air temperature can be obtained by measuring the variance in the resistance value.

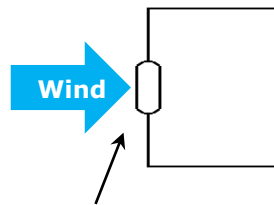

Air temperature element
(Platinum resistor)

When the heated air velocity sensor of the instrument is exposed to airflow, the heat is drawn from the sensor. The instrument obtains air velocity readings by using this relationship between the amount of heat removed (heat dissipation) and air velocity.

Since the instrument is calibrated with clean airflow with normal temperature and pressure, when the condition of air to be measured is different from that of the air used for calibration, the heat dissipation amount will differ even when the velocity is consistent (i.e. velocity reading is influenced by the condition of air).

Influence of Air Temperature

The instrument is a hot-wire anemometer, which measures the air velocity by using heat dissipation amount. Thus if temperature compensation is not provided, air velocity readings will be affected by the ambient air temperature change even the air velocity is consistent. In order to prevent such influence, the instrument is equipped with a temperature compensation circuit for measuring and compensating the air temperature in the range of 5°C to 60°C

Influence of Atmospheric Pressure

The instrument is calibrated under atmospheric pressure of 1013 hPa. Since change in the atmospheric pressure will influence the heat dissipation amount, compensation of the atmospheric pressure is required. Compensation can be provided by using the following formula.

$$U_m = \frac{1013}{P_m} \times U_c$$

Where; U_m : Actual Air Velocity [m/s]

U_c : Indicating Value

P_m : Atmospheric Pressure at the Measuring Point [hPa]

Influence of Air Composition

Compensation is required if the measurement is to be performed in an environment including any gas other than air. Compensation shall be performed by calculating the heat dissipation amount from the physical properties of the gas, and comparing it with the heat dissipation amount of the air.

§ 11

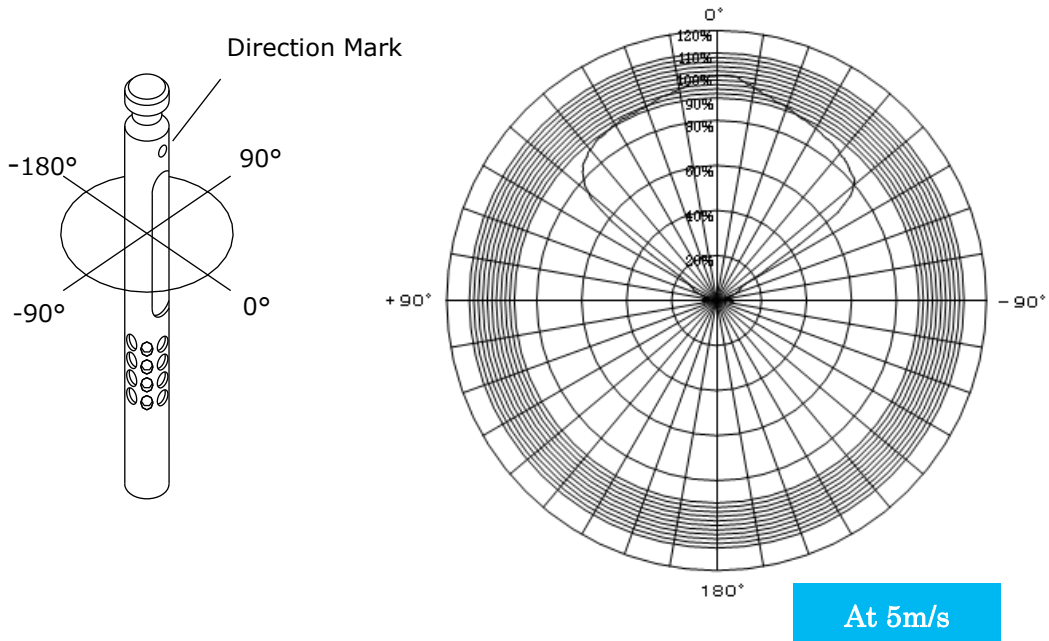

Probe Directivity (Air Velocity)

Horizontal Directivity

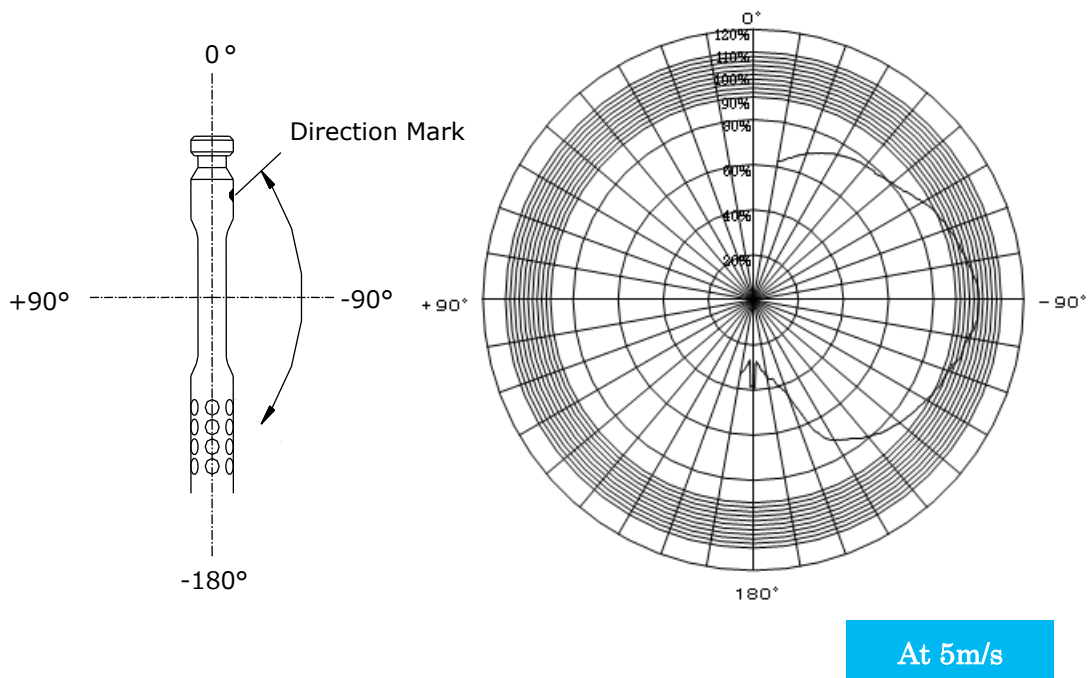

Vertical Directivity



Problems	Possible Cause / Solution	Refer To
Display does not appear when power is turned ON.	Battery is inserted in wrong polarity. →Turn off the power and insert the battery correctly.	Page 11 & 12
	The battery is low. →Turn off the power and replace the batteries.	Page 11 & 12
 blinks	The battery is low. →Turn off the power and replace the batteries.	Page 11 & 12
Reading is displayed as "-----"	Measurable range is exceeded. →The instrument must be used in the specified measurement range.	Page 27
	Probe wire disconnection or sensor damage. →Contact your local distributor for repair.	Page 34
Incorrect air velocity reading.	Confirm that the direction mark of the probe is facing against the airflow direction.	Page 14
	Sensor of the probe is dirty. →Turn off the power, and clean the sensor.	Page 26
High air temperature readings.	Correct reading cannot be obtained when there is no airflow. Minimum 0.1 m/s velocity is required for measurement.	Page 14
Air velocity reading does not change from "0.0" when sampling in Volumetric Flow / Air Temperature measurement mode.	Duct shape and dimension settings are not made properly (setting is zero). →Provide correct duct shape/dimension settings.	Page 14
Printing Failure	Confirm that the printer cable is connected properly.	Page 22
	Printer is not connected in the right order. →After connecting the printer, turn on the instrument first, and then turn on the printer.	Page 22
	Baud rate is not set properly. →Confirm the instrument and printer settings.	Page 22
Data Transfer Failure	Confirm that the USB cable is connected properly. Make sure that it is not confused with the printer cable.	Page 25
Analog Output Failure	Confirm that the polarity of the output terminal is correct.	Page 25
	The reading is in "hold" mode. →Press the  key to release the hold mode.	Page 16
Incorrect Output Value	Load impedance is set lower than the specified value. →Load impedance must be set to 5kΩ and over.	Page 25

Various Status Displays



The number of stored data records has exceeded the maximum limit of 1500 data records. Stored data must be deleted to enable further data storage.

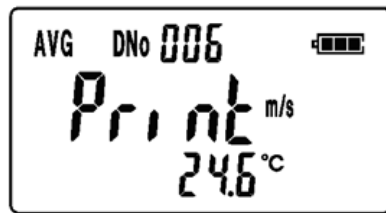

The screen on the right is displayed during printing.

When you want to cancel printing, press and hold the  key.

Kanomax Limited Warranty

The limited warranty set forth below is given by KANOMAX JAPAN, Inc. (hereafter referred to as "KJI") with respect to the KANOMAX brand anemometer, and its attachment parts including probe and other accessories (hereafter referred to as "PRODUCT") purchased directly from KJI or from an authorized distributor.

Your PRODUCT, when delivered to you in new condition in its original container, is warranted against defects in materials or workmanship as follows: for a period of two (2) years from the date of original purchase, defective parts or a defective PRODUCT returned to KJI, as applicable, and proven to be defective upon inspection, will be exchanged for a new or comparable rebuilt parts, or a refurbished PRODUCT as determined by KJI. Warranty for such replacements shall not extend the original warranty period of the defective PRODUCT.

This limited warranty covers all defects encountered in normal use of the PRODUCT, and does not apply in the following cases:

- (1) Use of parts or supplies other than the PRODUCT sold by KJI, which cause damage to the PRODUCT or cause abnormally frequent service calls or service problems.
- (2) If any PRODUCT has its serial number or date altered or removed.
- (3) Loss of damage to the PRODUCT due to abuse, mishandling, alternation, improper packaging by the owner, accident, natural disaster, electrical current fluctuations, failure to follow operation, maintenance or environmental instructions prescribed in the PRODUCT's operation manual provided by KJI, or service performed by other than KJI.

NO IMPLIED WARRANTY, INCLUDING ANY IMPLIED WARRANTY OF MERCHANTABILITY OR FITNESS FOR A PARTICULAR PURPOSE, APPLIES TO THE PRODUCT AFTER THE APPLICABLE PERIOD OF THE EXPRESS LIMITED WARRANTY STATED ABOVE, AND NO OTHER EXPRESS WARRANTY OR GUARANTY, EXCEPT AS MENTIONED ABOVE, GIVEN BY ANY PERSON OR ENTITY WITH RESPECT TO THE PRODUCT SHALL BIND KJI. KJI SHALL NOT BE LIABLE FOR LOSS OF STORAGE CHARGES, LOSS OR CORRUPTION OF DATA OR ANY OTHER SPECIAL, INCIDENTAL OR CONSEQUENTIAL DAMAGES CAUSED BY THE USE OR MISUSE OF, OR INABILITY TO USE OR CONSEQUENTIAL DAMAGES CAUSED BY THE USE OR MISUSE OF, OR INABILITY TO USE, THE PRODUCT, REGARDLESS OF THE LEGAL THEORY ON WHICH THE CLAIMS IS BASED, AND EVEN IF KJI HAS BEEN ADVISED OF THE POSSIBILITY OF SUCH DAMAGES. IN NO EVENT SHALL RECOVERY OF ANY KIND AGAINST KJI BE GREATER IN AMOUNT THAN THE PURCHASE PRICE OF THE PRODUCT SOLD BY KJI AND CAUSING THE ALLEGED DAMAGE. WITHOUT LIMITING THE FOREGOING, THE OWNER ASSUMES ALL RISK AND LIABILITY FOR LOSS, DAMAGE OF, OR INJURY TO THE OWNER AND THE OWNER'S PROPERTY AND TO OTHERS AND THEIR PROPERTY ARISING OUT OF USE OR MISUSE OF, OR INABILITY TO USE, THE PRODUCT NOT CAUSED DIRECTLY BY THE NEGLIGENCE OF KJI. THIS LIMITED WARRANTY SHALL NOT EXTEND TO ANYONE OTHER THAN THE ORIGINAL PURCHASER OF THE PRODUCT, OR THE PERSON FOR WHOM IT WAS PURCHASED AS A GIFT, AND STATES THE PURCHASER'S EXCLUSIVE REMEDY.

After Service

•When you have a problem with your instrument, please check out Section 12 "Troubleshooting" first.

•If that does not solve the problem, please contact your local distributor or call our service center. (See last page for contact information.)

•During the warranty period, we will repair at no charge a product that proves to be defective due to material or workmanship under normal use. (See Section 13 Kanomax Limited Warranty.)

•Repair after warranty expiration:

Upon request, we will repair the instrument at the customer's expense, if the instrument's performance is found to be recoverable by providing the repair.

•Replacement parts are available for minimum period of five (5) years after termination of production. This storage period of replacement parts is considered as the period during which we can provide repair service. For further information, please contact your local distributor or our service center.

**KANOMAX***The Ultimate Measurements*U.S.A.

KANOMAX USA, INC.

PO Box 372, 219 Route 206, Andover, NJ 07821 U.S.A.

TEL: (800)-247-8887 / (973)-786-6386 FAX: (973)-786-7586

URL: <http://www.kanomax-usa.com/>E-Mail: info@kanomax-usa.comJAPAN

KANOMAX JAPAN, INC.

2-1 Shimizu, Suita City, Osaka 565-0805, Japan

TEL: 81-6-6877-0183 FAX: 81-6-6879-5570

URL: <http://www.kanomax.co.jp>E-Mail: sales@kanomax.co.jpCHINA

Shenyang Kano Scientific Instrument Co., Ltd.

#2610, 51 Wulihe Street Heping District Shenyang P.R.C.

TEL: 86-24-23846440 FAX: 86-24-23898417

URL: <http://www.kanomax.com.cn/>E-Mail: sales@kanomax.com.cn

Copyright © Kanomax Japan Inc. All rights reserved.

2012

No copying, distribution, publication, modification, or incorporation of this document, in whole or part, is permitted for commercial purposes without the express written permission of Kanomax.

The contents of this document may be changed without prior notice.

01002/12.04



KANOMAX

The Ultimate Measurements