



KANOMAX
The Ultimate Measurements

TABmaster Model 6720 Instruction Manual



Be sure to read this manual thoroughly before using the instrument.
Fully understand and pay attention to each caution mentioned.
Please keep this manual for ready reference.



01003

22.01

Attention:

In order to ensure your interests and enable you to receive timely and effective after-sales service, please fill in the "Warranty Card" carefully and cut it along the dotted line. After copying, fax or mail it to our company according to our company's contact information. If you do not fax or mail this warranty card to our company in time, you will not be able to enjoy our company's normal warranty and technical support, please cooperate.



KANOMAX
The Ultimate Measurements



WARRANTY CARD

Date: __Day __Month __Year

Product Name	
Product Model	
Number	(Please find it in the rear case and base of the instrument)
Date of Purchase	Month Day Year

Company Name			
Address		Post Code	
Telephone		Fax	
Using Dep.		Connector	
E-mail			
Instrument use (Fill in detailed)			
Customer feedback			

Attention:

1. When the user receives the purchased instrument, please fill in the warranty card carefully and confirm the signature, then fax or send this form back to our company;
2. The warranty period of the purchased instrument is the "date of purchase" filled in this warranty card.
(All instruments of our company are guaranteed for one year under the premise of carefully reading the product manual and operating normally according to their instructions, if there is any quality problems);
3. In order to ensure your interests and enable you to receive timely and effective after-sales service, please keep this warranty card properly.

CONTENTS

Composition & Parts	3
Attentions & Notes.....	5
1. Introduction.....	8
1.1 Product Features.....	8
1.2 Main Specificaion.....	8
2. Capture Hood Structure.....	9
2.1 Instrument Base	9
2.2 Micromanometer	10
3.Installation.....	10
3.1 Capture Hood Installation	10
3.2 Velocity Grid Installation	11
3.3 Pitot Tube Installation	11
3.4 Micromanometer Installation	11
4. Operation Directions	12
4.1 Supplying Power	12
4.2 On/Off.....	13
4.3 Back Pressure Plate	13
5. Functions Test	13
5.1 Testing System.....	14
5.1.1 Single Measurement Mode.....	14
5.1.2 Average Measurement Mode	14
5.1.3 Back Pressure Measurement Mode.....	15
5.1.4 Print Settings.....	16
5.1.5 Tools Settings.....	16
5.1.6 Model Setting.....	16
5.1.7 ID Setting.....	17
5.1.8 Units Setting	17
5.2 Setting System	17

5.2.1 Date&Time Setting	17
5.2.2 Standard/Actual Test	18
5.2.3 Bluetooth Setting.....	18
5.2.4 Printer Connecting.....	18
5.2.5 Compensation K factor	19
5.2.6 Input Current Temperature	19
5.3 Data Handling	19
5.3.1 Scanning.....	19
5.3.2 Delete.....	20
5.3.3 Print	20
5.4 Data Output.....	21
6. Common Trouble Shooting	22
7. Warranty and After Service.....	23
7.1 Warranty	23
7.2. After Service	23

Composition & Parts

● Capture Hood 6720 Standard components:

Items	Qty.
Micro-manometer Model 6720-DP	1
Instrument base	1
Fabric Hood: 610×610 mm	1
Carrying case	1
Portable handle	1
Frame	1
Poles	4
Back pressure plate	1
Communication cable	1
AA batteries	4
Calibration certificate	1
CD-Rom (Manual and software inside)	1
Quick-Guide	1

● Capture Hood 6720 Optional components:

Items	Specifications
610*610mm	Spare Hood
610*1220mm	
305*1220mm	
915*610mm	
915*915mm	
500*500mm	
Capture Hood Stand	Test with capture hood, overall height \geq 3.4m
Bluetooth printer main unit	Printer paper: 57mm* ϕ 30mm
AC adapter	DC5V
Velocity-Grid	Pitot Tube
2.3*200mm	
4*300mm	
8*500mm	2*250cm
Pressure tubing	

6720-DP Standard:

Items	Qty.
Micro-manometer Model6720-DP	1
Velocity Grid	1
Carrying case	1
Pressure tubing	2
Communication cable	1
AA batteries	4
Calibration certificate	1
CD-Rom (Manual and software inside)	1
Quick-Guide	1

6720-DP Optional Parts:

Items	Specifications
2.3*200mm	Pitot Tube
4*300mm	
8*500mm	
Bluetooth printer main unit	Printer paper: 57mm* ϕ 30mm
AC adapter	DC5V

ATTENTIONS&NOTES

The warning symbols mentioned in this manual are defined below:

[Symbol Classifications]

Danger : To Prevent Serious Injury or Death

Warnings in this classification indicate a danger that may result in serious injury or death if not observed.

Caution: To Prevent Damage to the Product

If the contents of such warnings are ignored, the instrument may be damaged or the performance of the instrument may be degraded.

(Description of Symbols)









- △ This symbol indicates cautions (including dangers). The specific attention content is drawn in the triangle box.





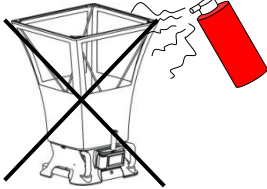







- ⊘ This symbol indicates prohibited items. Specific prohibited content is drawn in a circular frame.



- This symbol indicates a mandatory action. A specific action is given near the symbol.

 WARNING		
 Heating Forbidden	<ul style="list-style-type: none"> ○ Never bring the fabric hood into a flammable gas atmosphere. … Otherwise, the heat may cause a fire or a explosion. 	
 Dis assembly prohibition	<ul style="list-style-type: none"> ○ Do not disassemble or refit the instrument. … Otherwise, it may cause an electric shock or a fire. 	
 Using properly	<ul style="list-style-type: none"> ○ Use the instrument properly by following the directions in this instruction manual. … Otherwise, it may cause an electric shock, fire or damage the sensor. 	
	<ul style="list-style-type: none"> ○ During use, if the instrument emits abnormal smell, sound, smoke or liquid flows into the instrument, please unplug the AC adapter and remove the battery immediately, and send it to the KANOMAX maintenance department for repair. 	

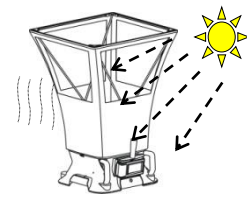
<p>Using properly</p>	<p>... Otherwise, there is possibility of electric shock, fire or instrument malfunction.</p>
<p> Forbidden</p>	<p>○ Do not exposure the instrument to rain or water.</p> <p>... Otherwise, it may cause a fire or a explosion.</p> 

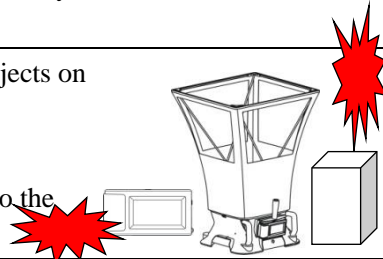
 CAUTION	
<p></p>	<p>○ Always unplug the instrument when it is not in use.</p> <p>... Failure to do so may cause an electric shock, fire or circuit damage.</p>
<p> Using properly</p>	<p>○ When the instrument is not used for a long time, please remove the internal battery. When the battery power is low, please replace the battery in time.</p> <p>... Failure to do so may cause battery leakage and damage to the instrument.</p>
<p> Using properly</p>	<p>○ When using an external power adapter, ensure to use the correct power adapter as required</p> <p>... Otherwise it may damage the instrument.</p>
<p> Forbidden</p>	<p>○ Do not wipe the instrument with a volatile solvent.</p> <p>... The body may deform or deteriorate. Use a soft dry cloth to remove stains. If stains persist, soak the cloth in a neutral detergent and wipe the instrument with the soft cloth. Never use volatile solvents such as thinner or benzene.</p>
<p> Forbidden</p>	<p>○ Do not use or leave the instrument in a high temperature, high humidity or dusty environment. Do not leave the instrument under direct sunlight.</p> <p>... Otherwise, the instrument may not function properly or the inside components may be damaged.</p> 
<p> Forbidden</p>	<p>○ Never drop the unit or place heavy objects on it..</p> <p>... It may cause damage or malfunction to the instrument.</p> 

1. Introduction

TAB master Model 6720 is a kind of intelligent test instrument with multifunctional of air flow test, velocity test and micro-differential pressure test. It's widely used in air flow testing of air-conditioning, HVAC system and other places, especially for the high precision micro-differential pressure test.

1.1 Product Features

- ◆4.3inch color LCD.
- ◆Measure air flow, velocity, temperature, humidity, atmospheric pressure at the same time.
- ◆Two kinds of tests are available for supply flow and exhaust flow.
- ◆Back pressure compensation.
- ◆Ultra-large storage capacity: 8000 records, which can be printed or transferred to the computer.
- ◆Blue tooth communication makes remote monitoring and data transferring available.
- ◆Can be connected to a Bluetooth printer, which is to print test data in real time.
- ◆Low power consumption. Battery power supply can work continuously for 14 hours. But if no operation for a long time, it can enter power saving mode.

1.2 Main Specifications

Items		6720 version 1.3
Air Flow	Flow Range	40~4300 m ³ /h
	Accuracy	Readings $\pm 3\% \pm 8\text{m}^3/\text{h}$ ($> 85\text{m}^3/\text{h}$)
	Resolution	1 m ³ /h
Velocity	Test Range	0.15~40m/s (Pitot Tube) 、 0.15~15 m/s (Velocity Grid)
	Accuracy	Readings $\pm 3\% \pm 0.05\text{m/s}$ ($> 0.25\text{m/s}$)
	Resolution	0.01m/s
Differential Pressure	Test Range	-2500~2500Pa
	Accuracy	Readings $\pm 1.5\% \pm 0.25\text{Pa}$
	Resolution	0.001Pa
Temperature	Test Range	0~60°C
	Accuracy	$\pm 0.5^\circ\text{C}$
	Resolution	0.1°C
Humidity	Test Range	0~100%RH
	Accuracy	$\pm 3\% \text{RH}$ (10~90%RH)
	Resolution	0.1%RH
Atmospheric Pressure	Test Range	70~130kPa
	Accuracy	Readings $\pm 2\%$
	Resolution	0.1 kPa
Operating Temp.		0~60°C (no condensing)
Storage Temp.		-20~70°C (no condensing)

Power Source	4 pcs of 5No.-model batteries (about 14hrs available) or DC5V adapter
Weight	Approx.3.6kg

2.Capture Hood Structure



2.1 Instrument Base

1. The exterior structure of the base

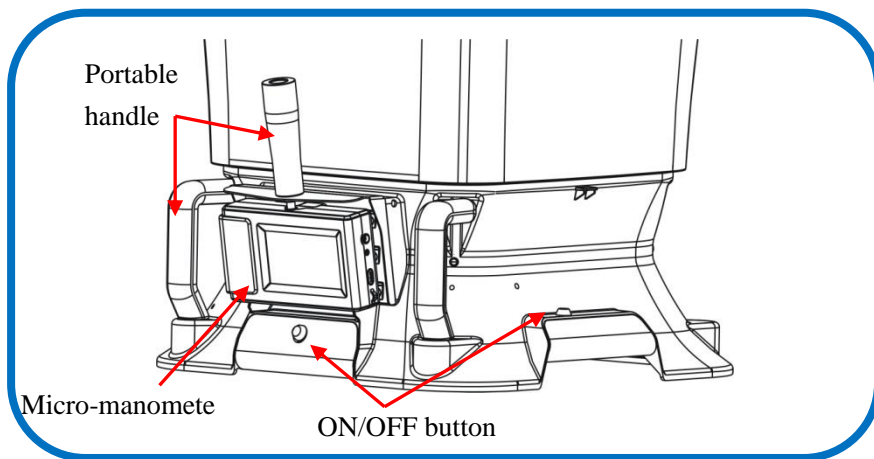

2.The internal structure of the base

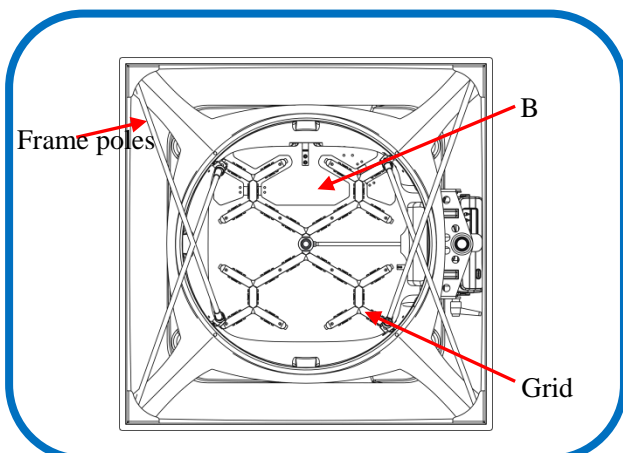

3. Grid

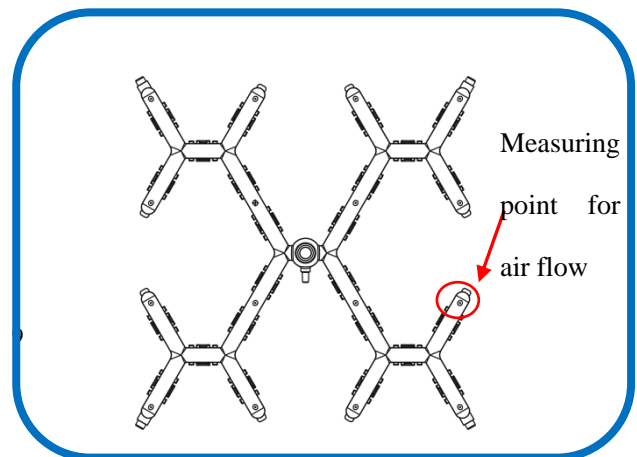

2.2 Micromanometer Structure

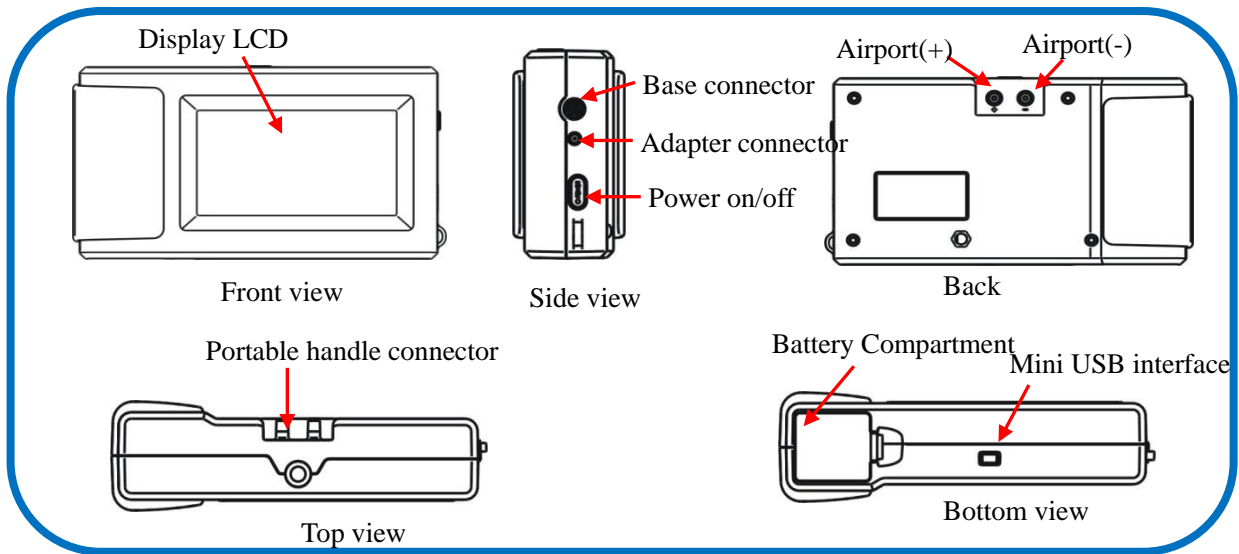

3. Installation

3.1. Capture Hood Installation

1. Installations of fabric hood and base

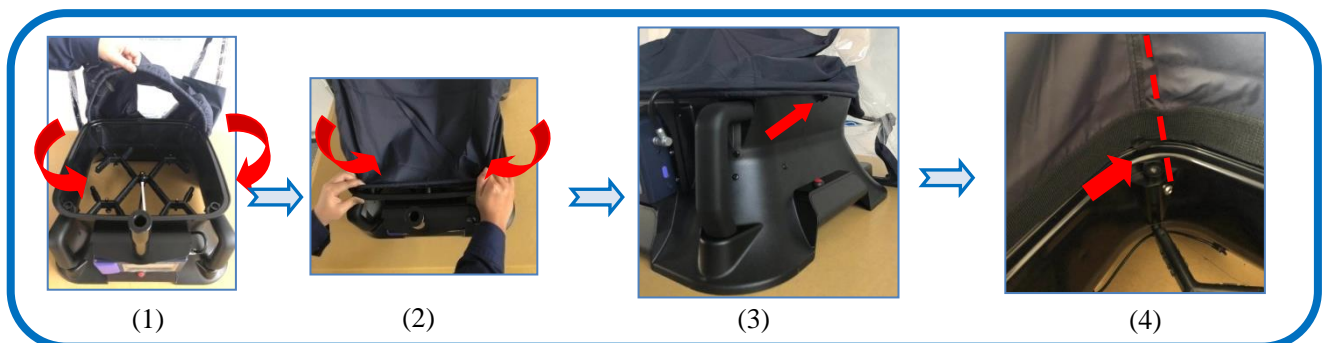

Note:

1) Make sure the elastic band of the fabric hood is placed exactly as shown (Figure(3)) to ensure a good fit.

2) Use the 4 positioning holes on the base stitching as a guide to ensure the hood fully wraps around the base..

2. Frame poles installation

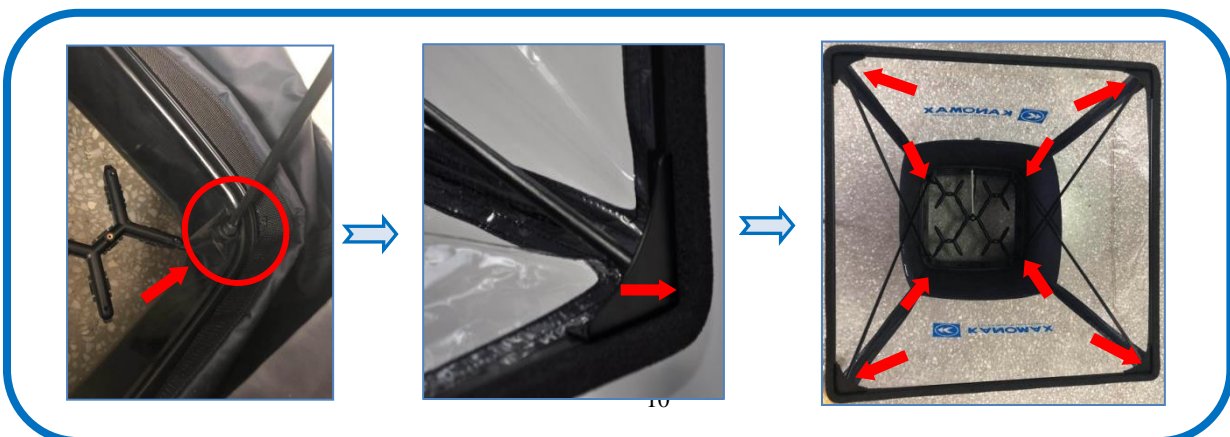

Note: The poles always cross in an “X” shape when assembling. To remove the poles, simply reverse the step

3. Installations of micro-manometer and portable handle

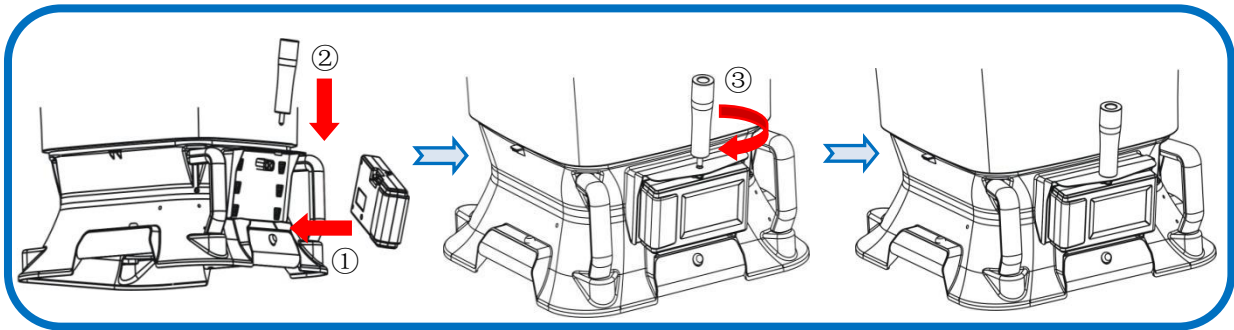

Note: 1) Release the poles and portable handle when packing in the carrying case to avoid case damaged.

2) The micromanometer number corresponds to the base number one by one

3.2 Velocity Grid Installation

Air velocity testing can be achieved when micromanometer works together with the velocity Grid.

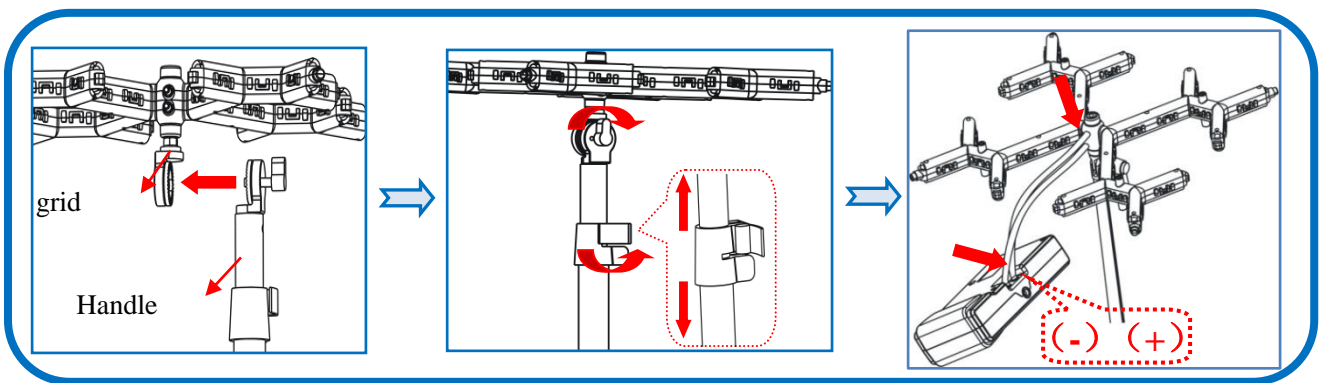

Note: Mounting angle between the Grid and handle can be adjusted as request.

3.3 Pitot Tube Installation

Air flow and velocity testing can be achieved when micro-manometer work together with Pitot tube.

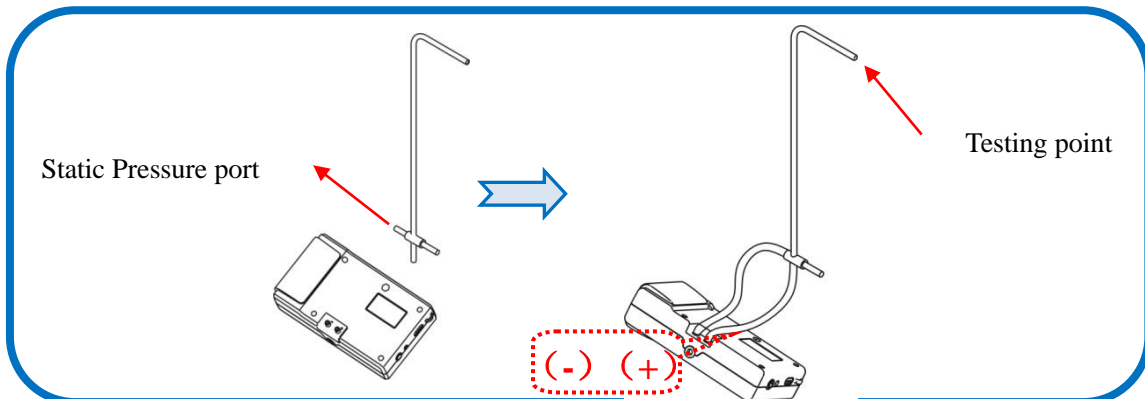

3.4 Micromanometer Installation

Differential pressure testing can be achieved by using the micromanometer.

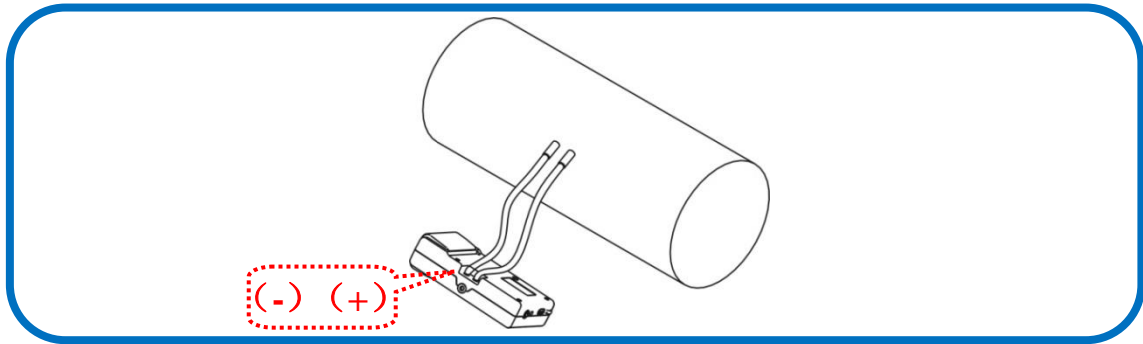

4. Operation Directions

4.1. Power Supply

1. Power by AC adapter. AC adapter will be as the priority power supply when the AC adapter and batteries are capable of using. The specification of the AC adapter is: I/P: AC 110-240V 50/60HZ O/P: DC 5V/2A.

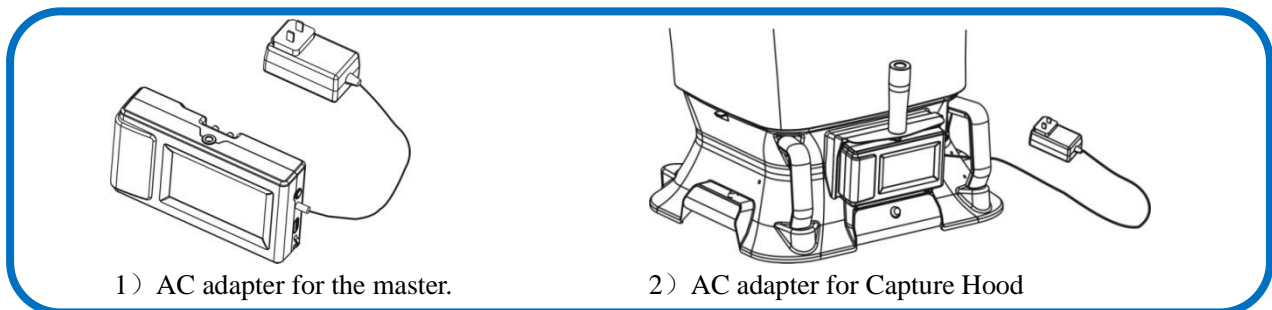

2. Power by batteries.

- ◆ Powered by 4 AA-size batteries, with the battery compartment cover open, install the batteries (please pay attention to the polarity of the batteries).
- ◆ Alkaline battery or rechargeable Ni-MH battery can be used. Never mix battery types, or battery leakage or damage to the instrument may occur.

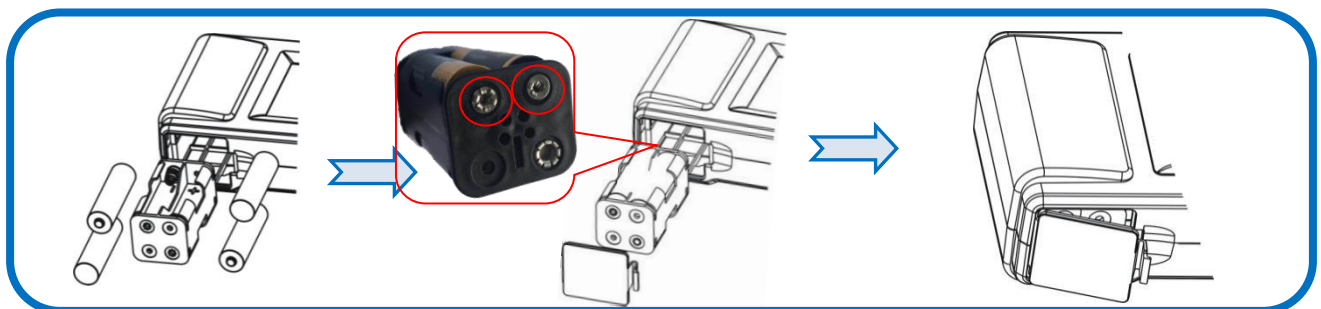

- ◆ When power is supplied with batteries, the current charge value will be displayed on the upper of the LCD. When the batteries run out of power, the instrument will turn off.

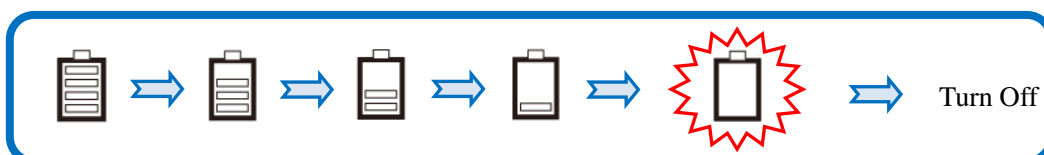

Note:

- 1) The test may stop if the battery is low during testing.

- 2) Don't use a full power battery with low power batteries.
- 3) It is recommended you change batteries when the power shows low.

4.2 ON/OFF

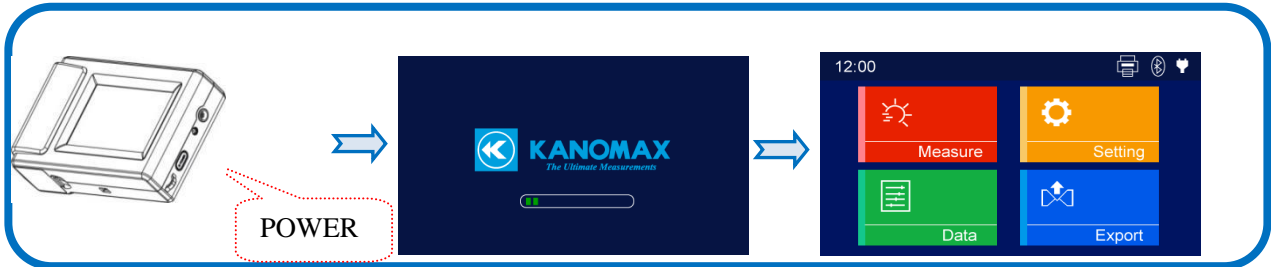

1. Getting Started

Press【POWER】 for two seconds, and the instrument will turn on, displaying “KANOMAX” then enter into the testing interface.

2. Shut Down

Press 【POWER】 for two seconds, and the instrument will turn off automatically.

4.3 Back pressure plate

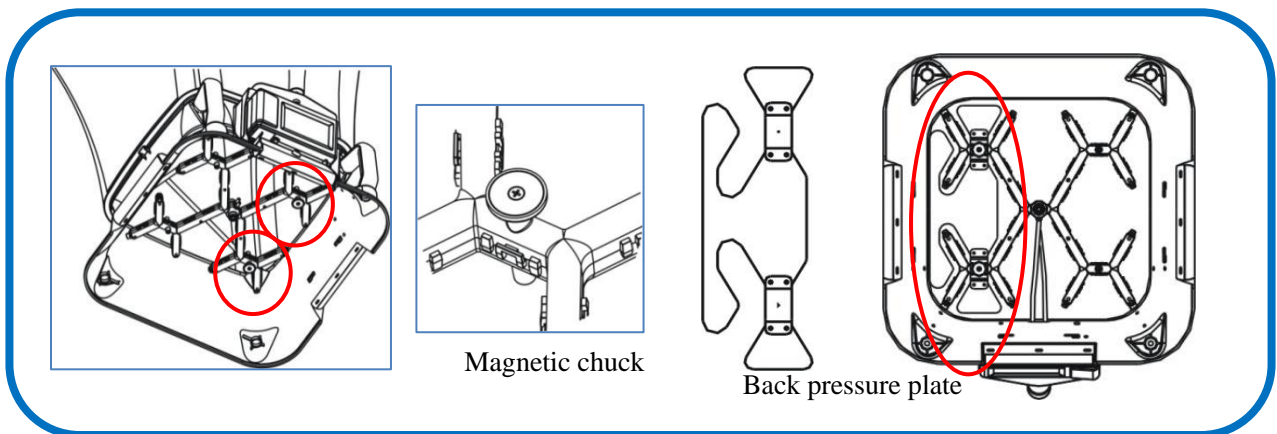

Note:

- 1) When testing in non-back pressure mode, please keep the back pressure plate.
- 2) When the air flow is greater than 1500m³/h, It is recommended to use the back pressure mode test and follow the prompt steps to test.

5.Functions Test

Besides the airflow test, if along with other optional products, test air velocity and micro-differential pressure is available.

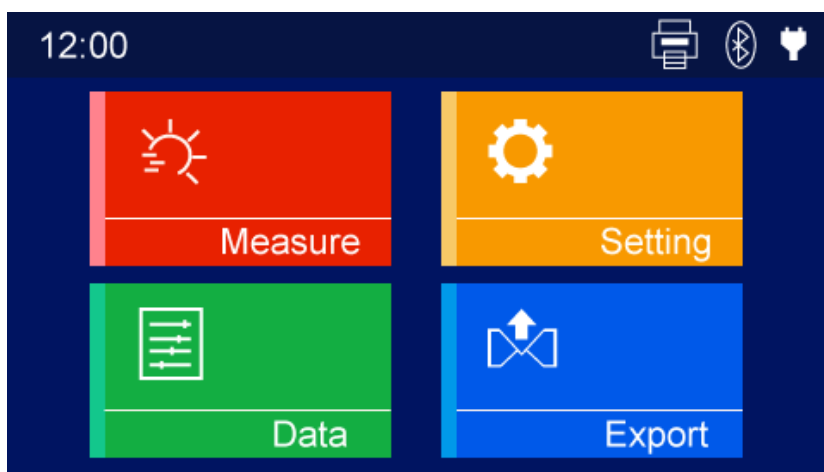

- 1.Measure/Test System--According to tools, the corresponding test values.
- 2.Setting/Instrument Settings—Date & Time, Bluetooth Switch, printer connecting, etc.
- 3.Data/Data Handling--Display storage data. The functions of print and delete are available.
- 4.Export/Data Output--Export stored data via PC.

5.1. Measuring System

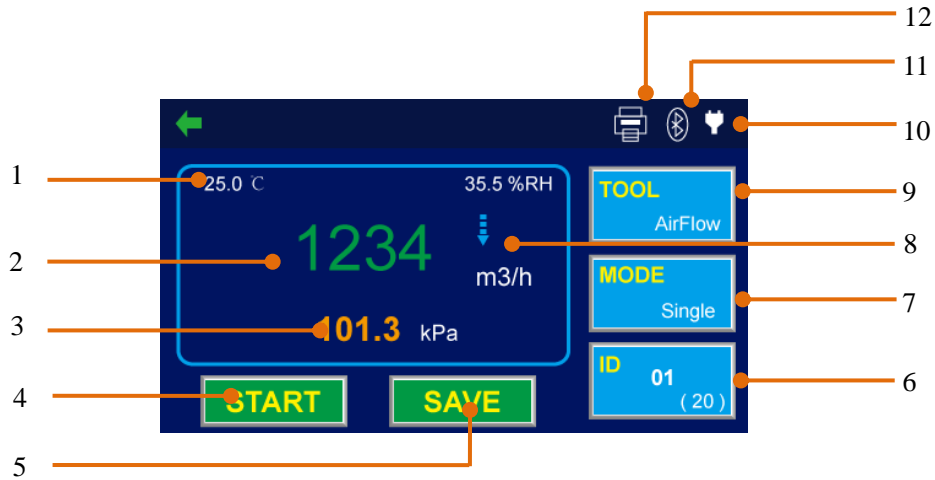

- | | |
|--|---|
| 1. Temperature, Humidity (Capture Hood) | 2. Test Data Display |
| 3. Atmospheric Pressure | 4. ON /OFF icon |
| 5. Data storage icon | 6. Test ID and total quantity of storage data |
| 7. Test mode —display the current testing mode | 8. Wind direction icon |
| 9. Test tool | 10. Power supply mode —display the current power supply |
| 11. Bluetooth Status | 12. Connecting the Bluetooth printer |

5.1.1 Single Measurement Mode



Note:

- 1) START: Left-button for the micromanometer or instrument base.
- 2) After testing start for about 8s with stably measuring, output displaying the test data and testing wind direction.
- 3) Testing stop when finish outputting.
- 4) After the measurement stops, press “SAVE” to record the testing value, if you do the “Cycle” No. will increase by 1.
- 5) Same testing method with the capture hood when using the Velocity Grid、Pitot、Micromanometer.

5.1.2 Average Measurement Mode



- 1) After testing start for about 8s with stably measuring , output displaying the test data for the first time.
- 2) Go on the testing with frequency of 1s for data updating.
- 3) The continuously outputting is as the average data and be related with the “Damp Per.”set by user. More larger of the value of ”Damp Per.” will get more stable of the testing data.
- 4) If the storage period "Cycle Per." is not 0, the data will be stored according to the time set by "Cycle Per.", and the "Cycle" will increase automatically.
- 5) Press “STOP”, testing stop.
- 6) Same testing method with the capture hood when using the Velocity Grid、 Pitot、 Micromanometer.

5.1.3 Back Pressure Compensation Measurement Mode

In order to reduce the measure error of the pressure loss, which causing from the hood to the system and get the more real air flow, we suggest testing under the Back Pressure Mode when air flow is more than 1500 m³/h.

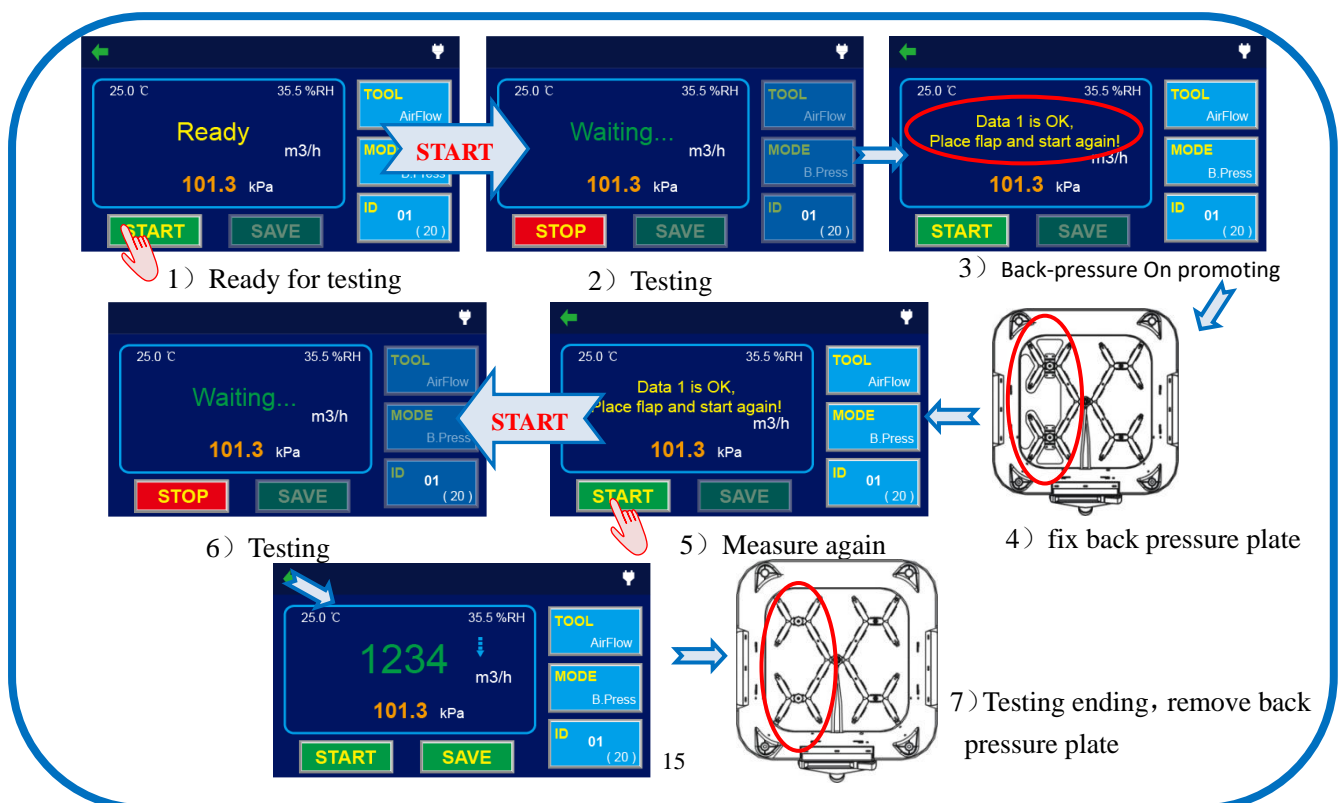

Note:

- 1) After testing start for about 8s, indicating “Open Flap”It’s time for switching on the Back Pressure Plate as needed.
- 2) Press START for about 8s, testing stop, real airflow outputting with back pressure compensation.
- 3) When select Velocity Grid、Pitot tube、Micromanometer for testing, Back Pressure Compensation will be not available.

5.1.4 Print Settings

The 6720 can be connected to our dedicated portable Bluetooth printer to print test data at any time (the format is as shown in the figure below). Please refer to chapter 5.2.4 of the manual for the connection process of the Bluetooth printer.

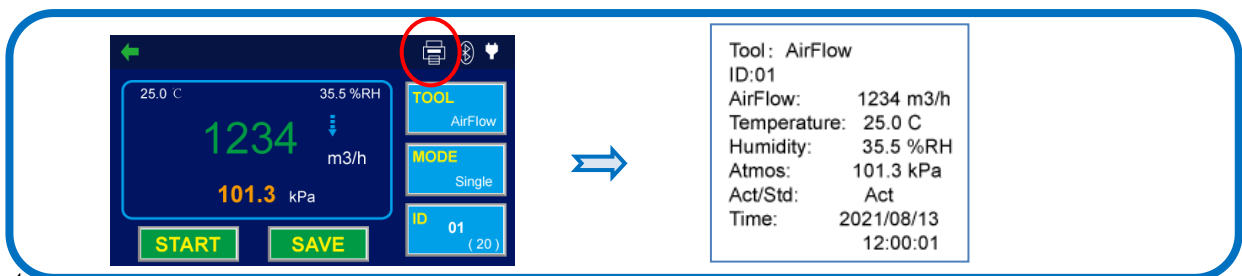

Note:

- 1) Please purchase our dedicated Bluetooth printer, and the printer icon will be displayed in the status bar after the connection is successful.
- 2) In single test and back pressure test mode, print when the test result is formed.
- 3) In continuous test mode, print once per 1s according to the update frequency of test results.

5.1.5 Tools Settings

The TABmaster Model 6720 is an instrument for airflow, air temperature, and relative humidity measurements. The optional accessories (Velocity Grid, Pitot tube, and Micromanometer) expand the parameters that the instrument can measure. Refer to the Chapter 3 and 5 for details.

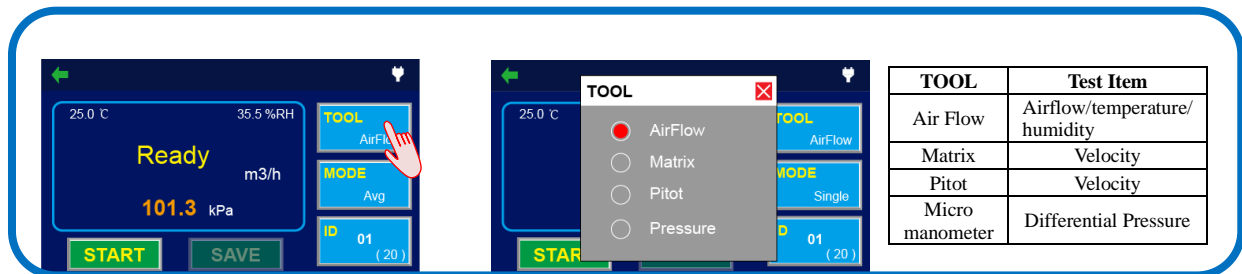

5.1.6 Test Mode Settings

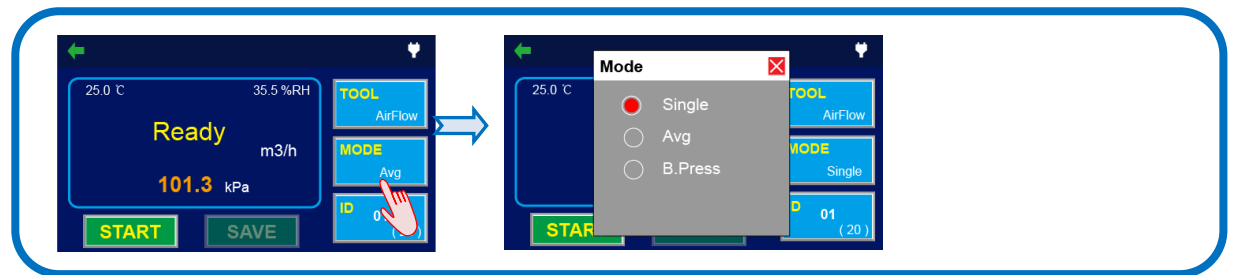

5.1.7 Test ID Setting

(1) The maximum number of Test IDs is 20.
 (2) Every tool owns independent test ID.
 (3) A Test ID can contain up to 100 Cycles.

5.1.8 Units Setting

(1) Testing area is touchable.
 (2) All tools are without same unit.

5.2 System Setting

Note:

- 1) Date & Time: real-time display the current date and time
- 2) STD: Standard mode option
- 3) BLE: Bluetooth communication start on
- 4) Printer: Bluetooth printer connecting
- 5) P. Factor: Pitot tube correction factor
- 6) K. Factor: Test value correction factor
- 7) Cycle Per.: Data storage cycle
- 8) Damp Per: Damping coefficient
- 9) Temp: temperature input (with tools of grid and pitot tube)

5.2.1 Date & Time Setting

Note: OK icon means confirm, ESC icon means cancel.

5.2.2 Standard/Actual Test

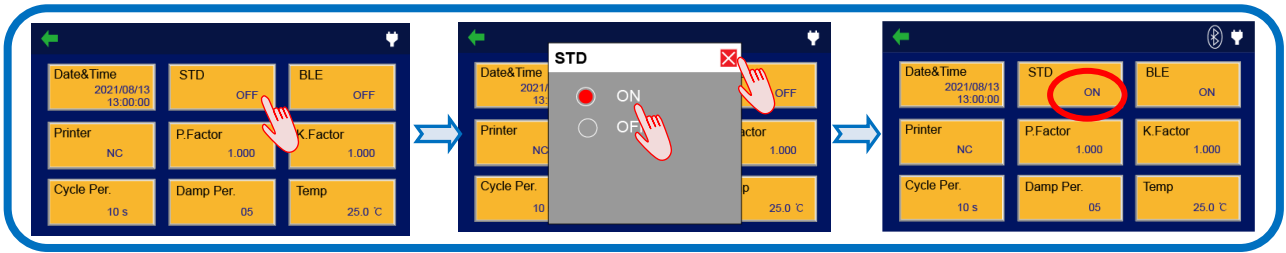

Note:

- 1) STD is ON, means Standard (Std) environmental test. The atmospheric pressure is 101.32kPa and the temperature is 21.1°C.
- 2) STD is OFF, means Actual(Act) environmental test, including atmospheric pressure compensation and temperature compensation.
- 3) When selecting tool of micro differential pressure, the function will be forbidden.

5.2.3 Bluetooth Setting



Note:

- 1) Bluetooth communication is to realize the remote control and data monitoring of the air volume cover 6720 by using a mobile phone. It needs to be used together with the APP software provided by our company. Please refer to the "TAB Mobile Software User Manual".
- 2) In order to improve the service life of the battery, please turn off the Bluetooth switch in time when not using Bluetooth communication.

5.2.4 Printer Connecting

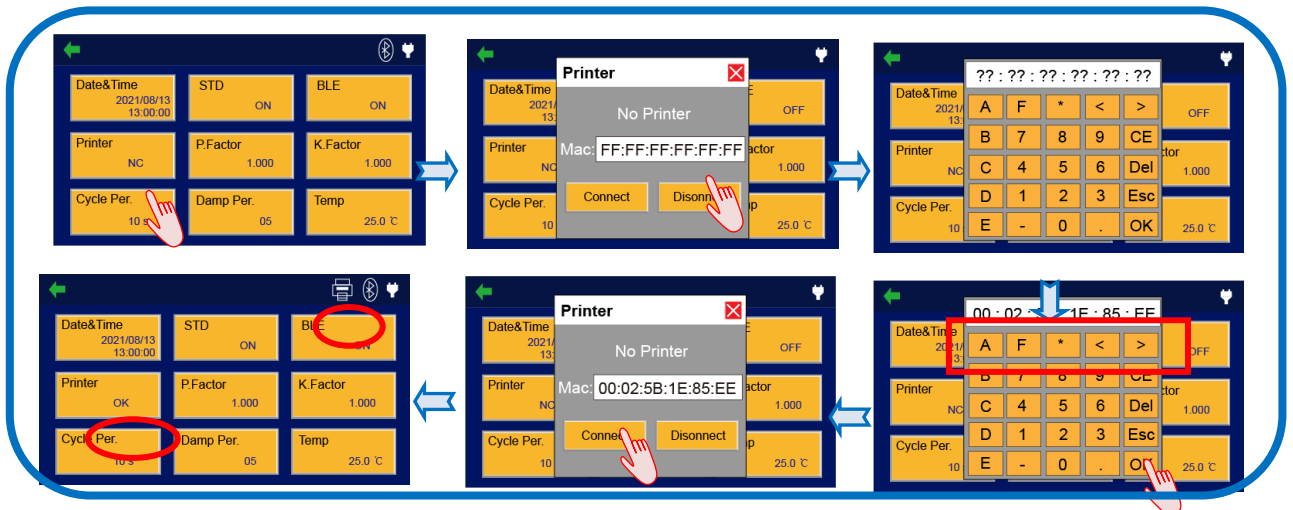

Note:

- 1) Please connect to our dedicated portable Bluetooth printer, the printer's Mac address is marked in the battery box.
- 2) Please try to keep the distance between the Bluetooth printer and the air volume cover as close as possible to keep the print data from being lost.
- 3) If the Bluetooth printer is disconnected, the printer icon disappears, please keep an eye on the Bluetooth connection status.

5.2.5 Compensation K factor

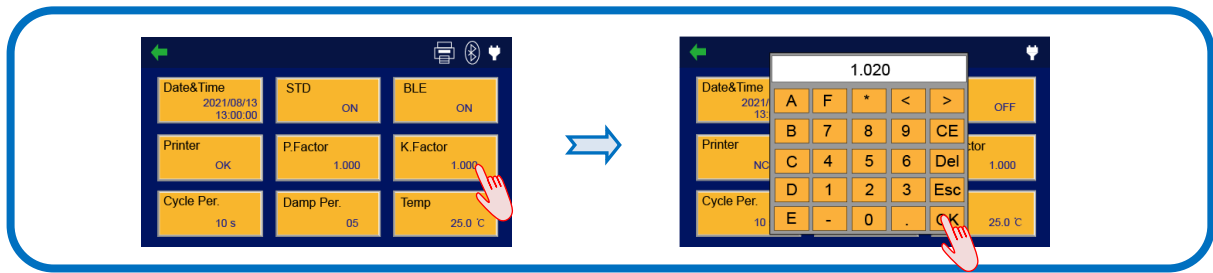

Note:

- 1) K.Factor is used to compensate the test value to make it more accurate, its range is 0.500~1.500.

Note: K.Factor affects the accuracy of the measured value, must have a test benchmark, please use it with caution. Example: Select the air volume hood tool, the test value of 6720 is 1000m³/h, and the air volume benchmark is 1020m³/h. At this time, Factor= benchmark/test value, that is, Factor=1.020. Enter the Factor to correct the accuracy of the test value of 6720.

5.2.6 Input current temperature

When the velocity grid and pitot tube tools are selected, the current ambient temperature needs to be entered manually.

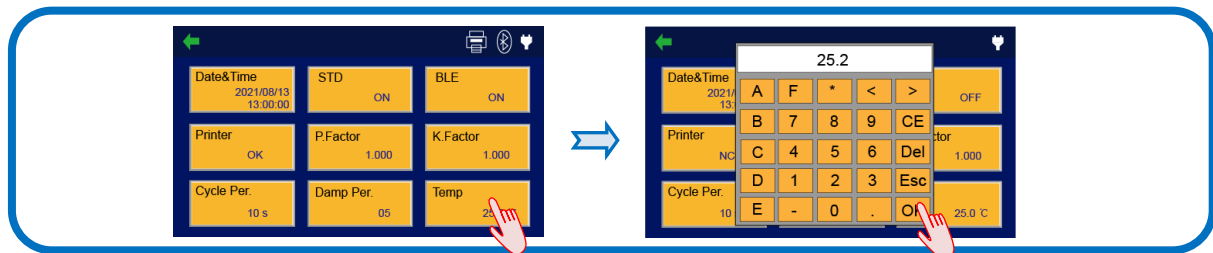

Note: Temperature range is 0~60.0°C。

5.3 Data Handling

5.3.1 Scanning



5.3.2 Delete

1) Delete ID

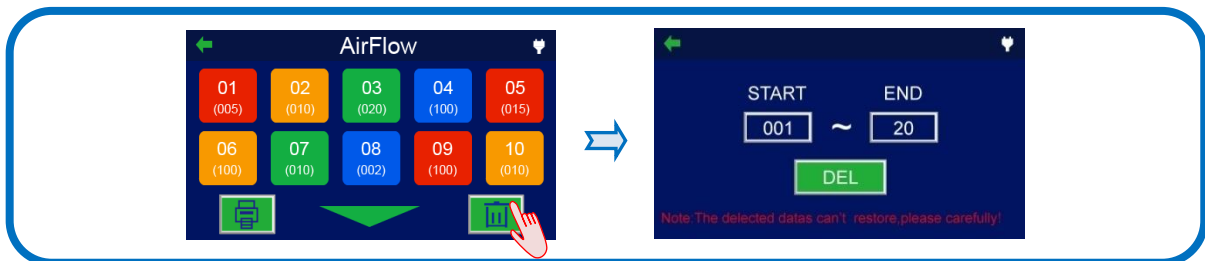

2) Delete cycle

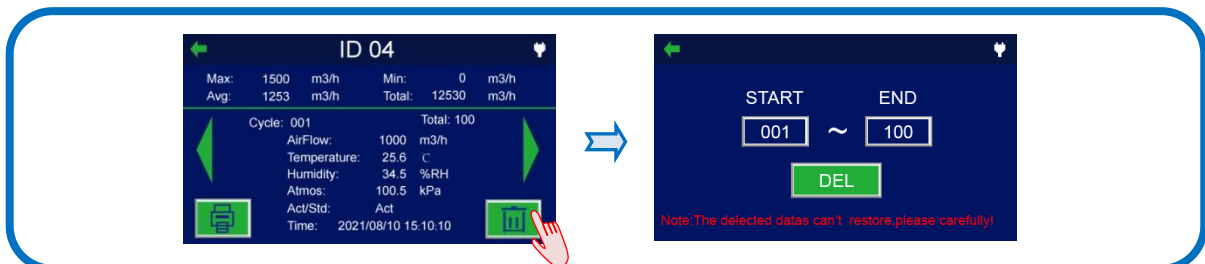

Note:

- 1) Only the data under the current tool is allowed to be deleted.
- 2) Once the data is deleted, it cannot be recovered.
- 3) Please delete invalid data in time to ensure effective storage space.



5.3.3 Print

1) ID Method

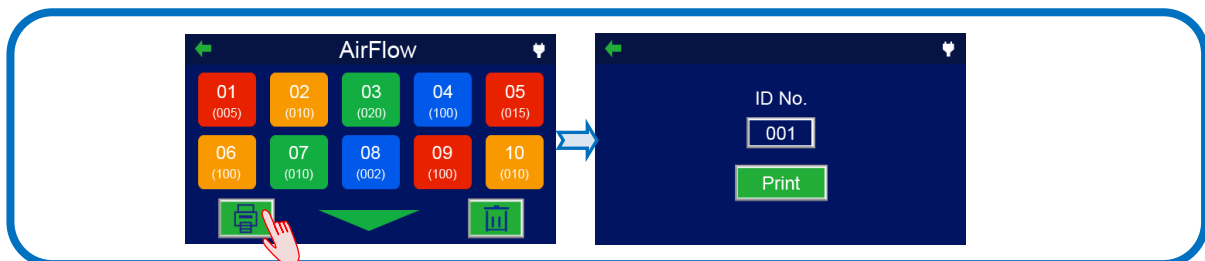

2) Cycle Method

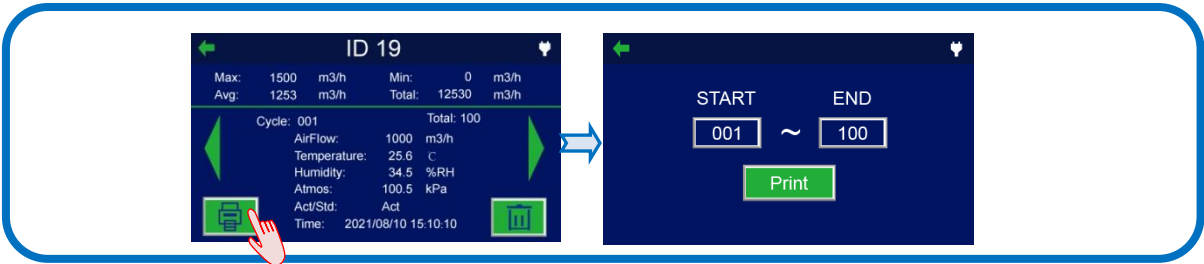

3) Disconnect the printer

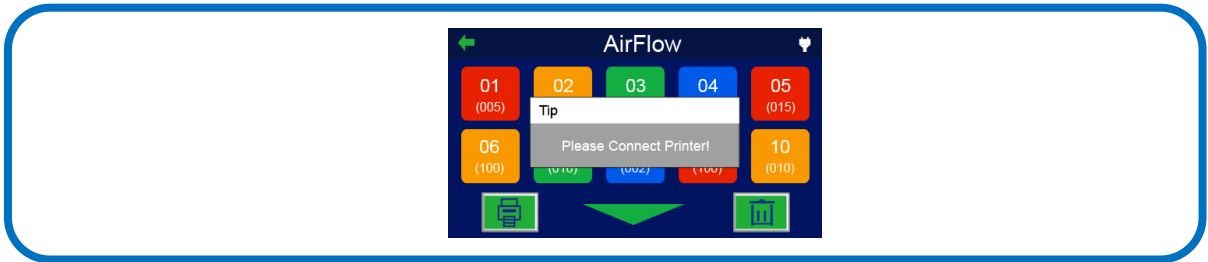

5.4 Data Output

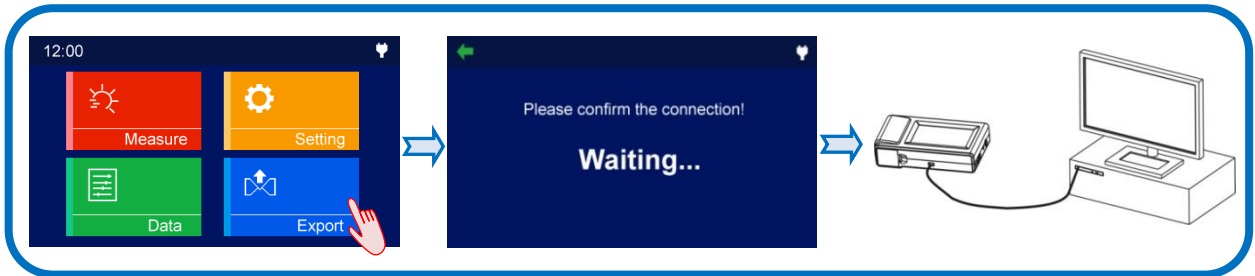

Note:

- 1) The export function is to transfer the saved test data to the computer. It needs to be used together with the communication cable and data acquisition software provided by our company. Please refer to the "6720 Data Acquisition Software Instruction Manual".

6. Common Trouble Shooting

Please check the following list before requesting a repair:

Symptom	Possible Causes	Trouble Shooting
No display when power On	Incorrect specification of the AC Adapter	Check and refer to Chapter4.1 in Manual
	Battery installation error	Check and refer to Chapter4.1 in Manual
	Low or dead battery power	Replace the batteries
Temp.Value 0.0, Humidity Value 0.0	Base's cable falls off	Reinsert the connecting cable
	Sensor or cable is broken	Connect after-service for maintenance
Display "DATA Error"	Back-Pressure mode using incorrect	Refer to Chapter 5.4 in Manual
Testing record can not be saved	Over-limit Cycle quantity in current ID	Add new ID or delete some data
Printing unreadable code	Unmatched printer	Using our special optional printer supplied by us.

7. Warranty and After Service

7.1 Warranty

- ◆ The product comes with an instrument warranty card. When you purchase the product, please be sure to fill in the required information in the warranty card accurately and send it back to our company at the address listed in time.
- ◆ After the warranty card is returned, our company will start the registration management of after-sales service accordingly.
- ◆ If the warranty card of the instrument is not returned, sometimes the after-sales service will be delayed, so please user be sure to assist.
- ◆ Under the premise of carefully reading the product instruction manual and operating normally according to its instructions, if there is a product quality problem, the warranty will be one year from the date of product purchase.

7.2 After Service

- ◆ When you have a problem with your instrument, please check out the “6.Common Trouble Shooting” section first.
- ◆ If the fault cannot be eliminated, please contact our company (please refer to the last page of the instruction manual for contact information).
- ◆ Repairs under warranty. Due to our company's manufacturing reasons, we will provide free repairs.
- ◆ Out-of-warranty repairs. After the warranty period has expired, if the user wants to maintain the function and accuracy of the instrument through repairs, our company will carry out paid repairs according to the user's requirements.

When service is required, please provide the following

- * Product Name: _____
- * Model No.: _____
- * Serial No.: _____
- * Description of the problem in detail.
- * Data of Purchase: Day _Month _Year



KANOMAX
The Ultimate Measurements

CHINA

SHENYANG KANO SCIENTIFIC INSTRUMENT CO., LTD.

#1314-1315, Zhongliang Square, 56-39 Yellow River North
Street, HuangGu District, Shenyang City. PRC.

TEL: 86-024-23846440 83951688 83951788

FAX: 86-024-23898417-820

URL: www.kanomax.com.cn

USA

Kanomax Group Companies

KANOMAX USA, INC.

219 U.S. Highway 206, Andover, New Jersey 07821

Tel: 1-800-247-8887(USA) / 1-973-786-6386

FAX: 1-973-786-7586

URL: www.kanomax-usa.com/

E-mail: info@kanomax-usa.com

JAPAN

Japan & Asia

KANOMAX JAPAN, INC.

2-1 Shimizu, Suita City, Osaka 565-0805

Tel: 81-6-6877-0183

FAX: 81-6-6877-5570

URL: www.kanomax.co.jp/

E-mail: sales@kanomax.co.jp