

# Model 7703 Multiplexer Module

## Instructions for use with DAQ6510

Keithley Instruments  
28775 Aurora Road  
Cleveland, Ohio 44139  
1-800-935-5595  
[tek.com/keithley](http://tek.com/keithley)

### Introduction

The 7703 32-Channel High-Speed Differential Multiplexer Module offers 32 channels of 2-pole or 16 channels of 4-pole multiplexer switching that can be configured as two independent banks of multiplexers. The nonlatching reed relays provide high speeds and are designed for 300 V, 500 mA; 10 VA. The relay closures are stored in onboard memory. The 7703 is ideal for RTD and thermistor temperature applications.

**Figure 1: Model 7703 32-Channel High-Speed Differential Multiplexer Module**



Item shipped may vary from model pictured here.



The 7703 includes the following features:

- Two-wire or four-wire resistance measurements (automatically pairs switches for four-wire measurements— $n + 16$ )
- Two 50-pin D-sub connectors for use with the Model 7788 50-Pin D-Subminiature Connector Kit
- Temperature applications (RTD or thermistor)
- High-speed, non-latching reed relays (relays go to open state after power is removed or after System Reset)
- Model 7788 50-Pin D-Subminiature Connector Kit, which includes two D-sub connectors.

The 7703 can be used with the DAQ6510 Data Acquisition and Multimeter System.

## NOTE

If you are using this switching module with the 2700, 2701, or 2750, please see *Model 7700, 7702, and 7703 Multiplexer Modules User's Guide*, Keithley Instruments document number PA-695.

## Connections

The following information describes how to make connections to the switching module and define the channel designations. A connection log is provided that you can use to record your connections.

### **⚠ WARNING**

**Connection and wiring procedures in this document are intended for use by qualified personnel only. Do not perform these procedures unless qualified to do so. Failure to recognize and observe normal safety precautions could result in personal injury or death.**

## Module connections

### **⚠ WARNING**

**Do not attempt to perform this procedure unless qualified to do so. Failure to recognize and observe normal safety precautions could result in personal injury or death.**

### **⚠ WARNING**

**Do not exceed the maximum specifications for the 7703 switching module. Refer to the specifications provided in the data sheet. Failure to recognize and observe normal safety precautions could result in personal injury or death.**

When you are looking at the rear connectors of the 7703 switching module, the connector on the left is P1017 and the connector on the right is P1016.

**Figure 2: Model 7703 Pinouts (P1017 and P1016)**

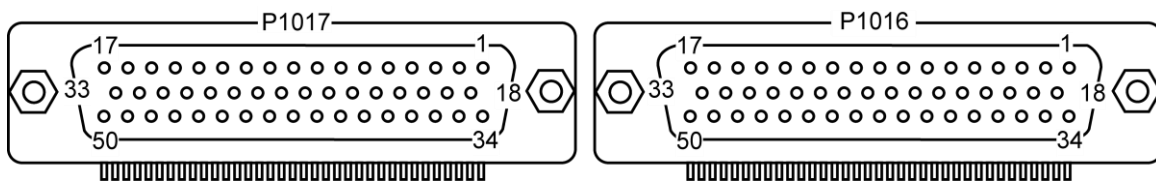

Make connections to the Model 7788 50-Pin D-Sub Connector Kit using the correct wire size (up to 20 AWG). Add supplementary insulation around the harness for voltages above 42 V<sub>PEAK</sub>, as shown in the following figure. Refer to *Model 7788 50-Pin D-Sub Connector Kit Connection and Wiring Information*, Keithley Instruments document PA-687, for specific wiring instructions.

---

**⚠ WARNING**

All wiring must be rated for the maximum voltage in the system. For example, if 1000 V is applied to the front terminals of the instrument, the switching module wiring must be rated for 1000 V. Failure to recognize and observe normal safety precautions could result in personal injury or death.

---

**⚠ WARNING**

A connector cover must be installed on an unused D-sub connector. If the connector is left open, an electrical shock hazard may be present. Failure to recognize and observe normal safety precautions could result in personal injury or death.

---

Figure 3: Covering an unused connector

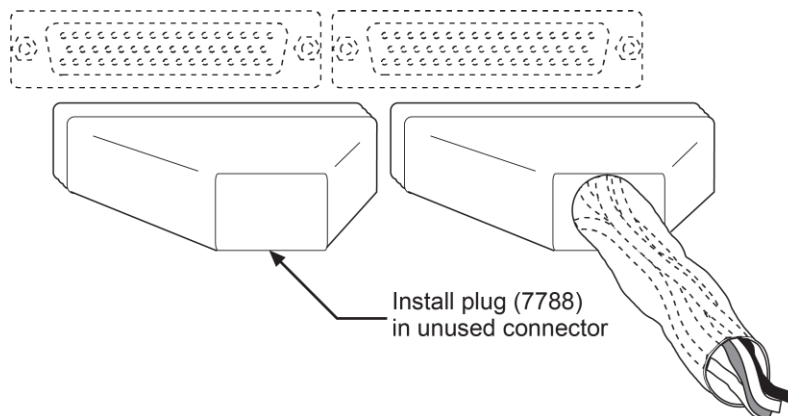

## Channel designations

P1017						P1016					
Pin	CH	Pin	CH	Pin	CH	Pin	CH	Pin	CH	Pin	CH
18	9 HI	30	15 HI	42	29 HI	1	Sense HI	26	5 HI	38	19 HI
19	9 LO	31	15 LO	43	29 LO	2	Sense LO	27	5 LO	39	19 LO
20	10 HI	32	16 HI	44	30 HI	4	Input HI	28	6 HI	40	20 HI
21	10 LO	33	16 LO	45	30 LO	6	Input LO	29	6 LO	41	20 LO
22	11 HI	34	25 HI	46	31 HI	18	1 HI	30	7 HI	42	21 HI
23	11 LO	35	25 LO	47	31 LO	19	1 LO	31	7 LO	43	21 LO
24	12 HI	36	26 HI	48	32 HI	20	2 HI	32	8 HI	44	22 HI
25	12 LO	37	26 LO	49	32 LO	21	2 LO	33	8 LO	45	22 LO
26	13 HI	38	27 HI			22	3 HI	34	17 HI	46	23 HI
27	13 LO	39	27 LO			23	3 LO	35	17 LO	47	23 LO
28	14 HI	40	28 HI			24	4 HI	36	18 HI	48	24 HI
29	14 LO	41	28 LO			25	4 LO	37	18 LO	49	24 LO

## Schematic diagram

The simplified schematic diagram of the 7703 is shown in the following figure.

Channels 1 to 32 are used for all measurements.

There are two backplane relays (channels 33 and 34) to connect the input channels to the backplane of the instrument. With a 2-wire function selected, channel 33 closes. With a 4-wire function selected, channels 33 and 34 close.

There is a 2-pole/4-pole relay (channel 35) between channels 1 to 16 and channels 17 to 32. When a 2-wire function (such as DCV) is selected, channel 35 closes (2-pole position) to allow any of the 32 channels to be connected to the input backplane.

When a 4-wire function is selected, channel 35 opens (4-pole position) to isolate channels 1 to 16 from channels 17 to 32. When one of the channels 1 to 16 is closed, its paired channel (17 to 32) also closes to connect the sense channel to the sense backplane.

The Input and Sense terminals are connected to the inputs of channels 33 and 34 (isolation relays).

### NOTE

Channels 33 to 35 in this schematic refer to designations used for control and not actual available channels. For more information, refer to the applicable instrument reference manual.

Figure 4: 7703 simplified schematic

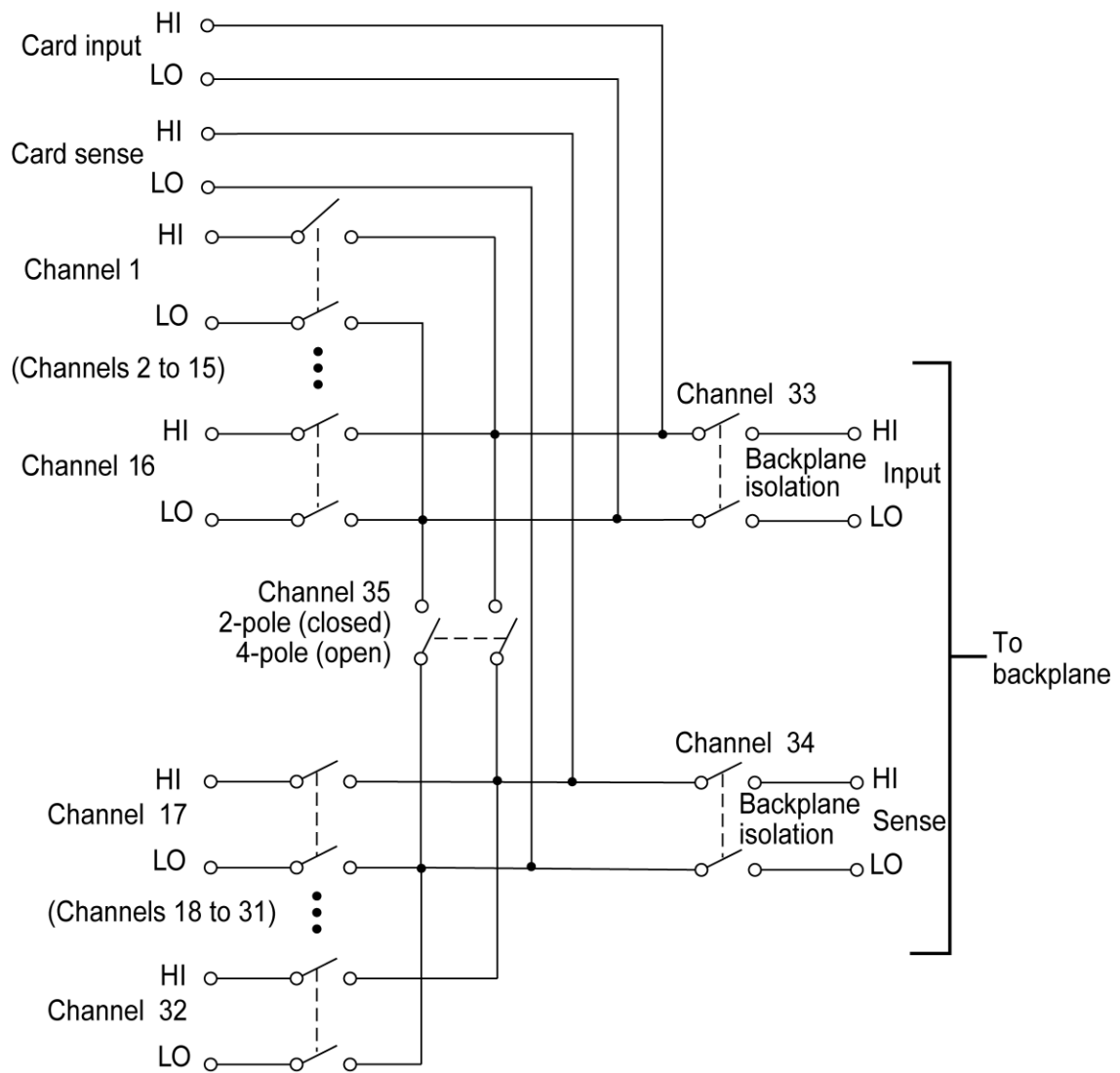

## Connection log

You can use the table to record your connection information.

Channel		Color	Description	Description	Color	Channel
INPUT	H					
	L					
SENSE	H					
	L					
CH1	H				H	CH17
	L				L	
CH2	H				H	CH18
	L				L	
CH3	H				H	CH19
	L				L	
CH4	H				H	CH20
	L				L	
CH5	H				H	CH21
	L				L	
CH6	H				H	CH22
	L				L	
CH7	H				H	CH23
	L				L	
CH8	H				H	CH24
	L				L	
CH9	H				H	CH25
	L				L	
CH10	H				H	CH26
	L				L	
CH11	H				H	CH27
	L				L	
CH12	H				H	CH28
	L				L	
CH13	H				H	CH29
	L				L	
CH14	H				H	CH30
	L				L	
CH15	H				H	CH31
	L				L	
CH16	H				H	CH32
	L				L	

## Installation

---

### WARNING

**Before operating an instrument with an accessory switching module, verify that the switching module is properly installed and the mounting screws are tightly fastened. If the mounting screws are not properly connected, an electrical shock hazard may be present.**

---

To use the switching operations, a switching module must be installed in the DAQ6510.

If you are installing two switching modules, it is easier to install one switching module into Slot 2 first, then install the second switching module into Slot 1.

---

### NOTE

If you have a Keithley Instruments Model 2700, 2701, or 2750 instrument, you can use your existing switching module in the DAQ6510. Follow the instructions in your original equipment documentation to remove the module from the instrument, then use the following instructions to install it in the DAQ6510. You do not need to remove wiring to the module.

---

### NOTE

For inexperienced users, it is recommended that you do not connect a device under test (DUT) and external circuitry to the switching module. This allows you to exercise close and open operations without the dangers associated with live test circuits. You can also set up pseudocards to experiment with switching. Refer to Pseudocards in the *Model DAQ6510 Reference Manual* for information on setting up pseudocards.

---

---

### WARNING

**To prevent electric shock that could result in injury or death, never handle a switching module that has power applied to it. Before installing or removing a switching module, make sure the DAQ6510 is turned off and disconnected from line power. If the switching module is connected to a DUT, make sure power is removed from all external circuitry.**

---

---

### WARNING

**If a card slot is unused, you must install slot covers to prevent personal contact with high voltage circuits. Failure to install slot covers could result in personal exposure to hazardous voltages, which could cause personal injury or death if contacted.**

---

## CAUTION

**Before installing or removing a switching module, make sure the DAQ6510 power is turned off and disconnected from line power. Failure to comply may result in incorrect operation and loss of data in the memory.**

---

Required equipment:

- Medium flat-blade screwdriver
- Medium Phillips screwdriver

### ***To install switching module into the DAQ6510:***

1. Turn off the DAQ6510.
2. Disconnect the power cord from the power source.
3. Disconnect the power cord and any other cables that are connected to the rear panel.
4. Position the DAQ6510 so you are facing the rear panel.
5. Use the screwdriver to remove the slot cover screws and the cover plate. Retain the plate and screws for future use.
6. With the top cover of the switching module facing up, slide the switching module into the slot.
7. Press the switching module in firmly to make sure the switching module connector is connected to the DAQ6510 connector.
8. Use the screwdriver to tighten the two mounting screws to secure the switching module to the mainframe. Do not overtighten.
9. Reconnect the power cord and any other cables.

## Remove a switching module

## NOTE

Before you remove a switching module, or begin any testing, make sure that all of the relays are open. Since some relays may be latched closed, you must open all of the relays before removing the switching module to make connections. Additionally, if you drop your switching module, it is possible for some relays to latch closed.

---

To open all channels select **Menu > Control > Open**. If there are no channels closed, the Open button is not selectable. If any channel is closed, then the Open button is active and selecting it will open all channels.

## WARNING

**To prevent electric shock that could result in injury or death, never handle a switching module that has power applied to it. Before installing or removing a switching module, make sure the DAQ6510 is turned off and disconnected from line power. If the switching module is connected to a DUT, make sure power is removed from all external circuitry.**

---

## WARNING

**If a card slot is unused, you must install slot covers to prevent personal contact with high voltage circuits. Failure to install slot covers could result in personal exposure to hazardous voltages, which could cause personal injury or death if contacted.**

---



## CAUTION

Before installing or removing a switching module, make sure the DAQ6510 power is turned off and disconnected from line power. Failure to comply may result in incorrect operation and loss of data in the memory.

---

Required equipment:

- Medium flat-blade screwdriver
- Medium Phillips screwdriver

### **To remove switching module from the DAQ6510:**

1. Turn off the DAQ6510.
2. Disconnect the power cord from the power source.
3. Disconnect the power cord and any other cables that are connected to the rear panel.
4. Position the DAQ6510 so you are facing the rear panel.
5. Use the screwdriver to loosen the mounting screws that secure the switching module to the mainframe.
6. Carefully remove the switching module.
7. Install a slot plate or switching module in the empty slot.
8. Reconnect the power cord and any other cables.

## Operation

### CAUTION

Before installing or removing a 7703 switching module, make sure the DAQ6510 power is turned off and disconnected from line power. Failure to comply may result in incorrect operation and loss of data in the 7703 switching module memory.

---

### CAUTION

To prevent overheating or damage to the 7703 switching module relays, never exceed the following maximum signal levels between any two inputs or chassis: Channels 1 to 32: 300 VDC or 300 V<sub>RMS</sub> (425 V<sub>PEAK</sub>) for AC waveforms, 0.5 A switched, 10 W maximum.

---

Refer to the instrument documentation for operating instructions.

This switching module does not support current measurements. If the instrument has the TERMINALS switch set to REAR and you are working with the slot that contains this switching module, the AC, DC, and digitize current functions are not available. You can measure current using the front panel or using another slot that contains a switching module that supports the AC, DC, and digitize current measurements.

If you use remote commands to attempt to measure current when configuring a channel, an error is returned.

## Factory service

To return the switching module to Keithley Instruments for repair:

- Call the Repair Department at 1-800-833-9200 or send an email to [RMAREQUEST@tektronix.com](mailto:RMAREQUEST@tektronix.com) for a Return Material Authorization (RMA) number.
- Carefully pack the instrument in the original packing carton.
- Write ATTENTION REPAIR DEPARTMENT and the RMA number on the shipping label.

The following safety precautions should be observed before using this product and any associated instrumentation. Although some instruments and accessories would normally be used with nonhazardous voltages, there are situations where hazardous conditions may be present.

This product is intended for use by personnel who recognize shock hazards and are familiar with the safety precautions required to avoid possible injury. Read and follow all installation, operation, and maintenance information carefully before using the product. Refer to the user documentation for complete product specifications.

If the product is used in a manner not specified, the protection provided by the product warranty may be impaired.

The types of product users are:

**Responsible body** is the individual or group responsible for the use and maintenance of equipment, for ensuring that the equipment is operated within its specifications and operating limits, and for ensuring that operators are adequately trained.

**Operators** use the product for its intended function. They must be trained in electrical safety procedures and proper use of the instrument. They must be protected from electric shock and contact with hazardous live circuits.

**Maintenance personnel** perform routine procedures on the product to keep it operating properly, for example, setting the line voltage or replacing consumable materials. Maintenance procedures are described in the user documentation. The procedures explicitly state if the operator may perform them. Otherwise, they should be performed only by service personnel.

**Service personnel** are trained to work on live circuits, perform safe installations, and repair products. Only properly trained service personnel may perform installation and service procedures.

Keithley products are designed for use with electrical signals that are measurement, control, and data I/O connections, with low transient overvoltages, and must not be directly connected to mains voltage or to voltage sources with high transient overvoltages. Measurement Category II (as referenced in IEC 60664) connections require protection for high transient overvoltages often associated with local AC mains connections. Certain Keithley measuring instruments may be connected to mains. These instruments will be marked as category II or higher.

Unless explicitly allowed in the specifications, operating manual, and instrument labels, do not connect any instrument to mains.

Exercise extreme caution when a shock hazard is present. Lethal voltage may be present on cable connector jacks or test fixtures. The American National Standards Institute (ANSI) states that a shock hazard exists when voltage levels greater than 30 V RMS, 42.4 V peak, or 60 VDC are present. A good safety practice is to expect that hazardous voltage is present in any unknown circuit before measuring.

Operators of this product must be protected from electric shock at all times. The responsible body must ensure that operators are prevented access and/or insulated from every connection point. In some cases, connections must be exposed to potential human contact. Product operators in these circumstances must be trained to protect themselves from the risk of electric shock. If the circuit is capable of operating at or above 1000 V, no conductive part of the circuit may be exposed.

Do not connect switching cards directly to unlimited power circuits. They are intended to be used with impedance-limited sources. NEVER connect switching cards directly to AC mains. When connecting sources to switching cards, install protective devices to limit fault current and voltage to the card.

Before operating an instrument, ensure that the line cord is connected to a properly-grounded power receptacle. Inspect the connecting cables, test leads, and jumpers for possible wear, cracks, or breaks before each use.

When installing equipment where access to the main power cord is restricted, such as rack mounting, a separate main input power disconnect device must be provided in close proximity to the equipment and within easy reach of the operator.

For maximum safety, do not touch the product, test cables, or any other instruments while power is applied to the circuit under test. ALWAYS remove power from the entire test system and discharge any capacitors before: connecting or disconnecting cables or jumpers, installing or removing switching cards, or making internal changes, such as installing or removing jumpers.

Do not touch any object that could provide a current path to the common side of the circuit under test or power line (earth) ground. Always make measurements with dry hands while standing on a dry, insulated surface capable of withstanding the voltage being measured.

For safety, instruments and accessories must be used in accordance with the operating instructions. If the instruments or accessories are used in a manner not specified in the operating instructions, the protection provided by the equipment may be impaired.

Do not exceed the maximum signal levels of the instruments and accessories. Maximum signal levels are defined in the specifications and operating information and shown on the instrument panels, test fixture panels, and switching cards.

When fuses are used in a product, replace with the same type and rating for continued protection against fire hazard.

Chassis connections must only be used as shield connections for measuring circuits, NOT as protective earth (safety ground) connections.

If you are using a test fixture, keep the lid closed while power is applied to the device under test. Safe operation requires the use of a lid interlock.

If a  screw is present, connect it to protective earth (safety ground) using the wire recommended in the user documentation.

The  symbol on an instrument means caution, risk of hazard. The user must refer to the operating instructions located in the user documentation in all cases where the symbol is marked on the instrument.

The  symbol on an instrument means warning, risk of electric shock. Use standard safety precautions to avoid personal contact with these voltages.

The  symbol on an instrument shows that the surface may be hot. Avoid personal contact to prevent burns.

The  symbol indicates a connection terminal to the equipment frame.

If this  symbol is on a product, it indicates that mercury is present in the display lamp. Please note that the lamp must be properly disposed of according to federal, state, and local laws.

The **WARNING** heading in the user documentation explains hazards that might result in personal injury or death. Always read the associated information very carefully before performing the indicated procedure.

The **CAUTION** heading in the user documentation explains hazards that could damage the instrument. Such damage may invalidate the warranty.

The **CAUTION** heading with the  symbol in the user documentation explains hazards that could result in moderate or minor injury or damage the instrument. Always read the associated information very carefully before performing the indicated procedure. Damage to the instrument may invalidate the warranty.

Instrumentation and accessories shall not be connected to humans.

Before performing any maintenance, disconnect the line cord and all test cables.

To maintain protection from electric shock and fire, replacement components in mains circuits — including the power transformer, test leads, and input jacks — must be purchased from Keithley. Standard fuses with applicable national safety approvals may be used if the rating and type are the same. The detachable mains power cord provided with the instrument may only be replaced with a similarly rated power cord. Other components that are not safety-related may be purchased from other suppliers as long as they are equivalent to the original component (note that selected parts should be purchased only through Keithley to maintain accuracy and functionality of the product). If you are unsure about the applicability of a replacement component, call a Keithley office for information.

Unless otherwise noted in product-specific literature, Keithley instruments are designed to operate indoors only, in the following environment: Altitude at or below 2,000 m (6,562 ft); temperature 0 °C to 50 °C (32 °F to 122 °F); and pollution degree 1 or 2.

To clean an instrument, use a cloth dampened with deionized water or mild, water-based cleaner. Clean the exterior of the instrument only. Do not apply cleaner directly to the instrument or allow liquids to enter or spill on the instrument. Products that consist of a circuit board with no case or chassis (e.g., a data acquisition board for installation into a computer) should never require cleaning if handled according to instructions. If the board becomes contaminated and operation is affected, the board should be returned to the factory for proper cleaning/servicing.

Safety precaution revision as of June 2017.