

Model 2290-10 10 kV Power Supply

User's Manual

2290-10-900-01 Rev. C / November 2016



2290-10-900-01C

A Greater Measure of Confidence



Model 2290-10

10 KV Power Supply

User's Manual

© 2016, Keithley Instruments

Cleveland, Ohio, U.S.A.

All rights reserved.

Any unauthorized reproduction, photocopy, or use of the information herein, in whole or in part, without the prior written approval of Keithley Instruments is strictly prohibited.

All Keithley Instruments product names are trademarks or registered trademarks of Keithley Instruments. Other brand names are trademarks or registered trademarks of their respective holders.

Microsoft, Visual C++, Excel, and Windows are either registered trademarks or trademarks of Microsoft Corporation in the United States and/or other countries.

Document number: 2290-10-900-01 Rev. C / November 2016

The following safety precautions should be observed before using this product and any associated instrumentation. Although some instruments and accessories would normally be used with nonhazardous voltages, there are situations where hazardous conditions may be present.

This product is intended for use by qualified personnel who recognize shock hazards and are familiar with the safety precautions required to avoid possible injury. Read and follow all installation, operation, and maintenance information carefully before using the product. Refer to the user documentation for complete product specifications.

If the product is used in a manner not specified, the protection provided by the product warranty may be impaired.

The types of product users are:

Responsible body is the individual or group responsible for the use and maintenance of equipment, for ensuring that the equipment is operated within its specifications and operating limits, and for ensuring that operators are adequately trained.

Operators use the product for its intended function. They must be trained in electrical safety procedures and proper use of the instrument. They must be protected from electric shock and contact with hazardous live circuits.

Maintenance personnel perform routine procedures on the product to keep it operating properly, for example, setting the line voltage or replacing consumable materials. Maintenance procedures are described in the user documentation. The procedures explicitly state if the operator may perform them. Otherwise, they should be performed only by service personnel.

Service personnel are trained to work on live circuits, perform safe installations, and repair products. Only properly trained service personnel may perform installation and service procedures.

Keithley Instruments products are designed for use with electrical signals that are measurement, control, and data I/O connections, with low transient overvoltages, and must not be directly connected to mains voltage or to voltage sources with high transient overvoltages. Measurement Category II (as referenced in IEC 60664) connections require protection for high transient overvoltages often associated with local AC mains connections. Certain Keithley Instruments measuring instruments may be connected to mains. These instruments will be marked as category II or higher.

Unless explicitly allowed in the specifications, operating manual, and instrument labels, do not connect any instrument to mains.

Exercise extreme caution when a shock hazard is present. Lethal voltage may be present on cable connector jacks or test fixtures. The American National Standards Institute (ANSI) states that a shock hazard exists when voltage levels greater than 30 V RMS, 42.4 V peak, or 60 VDC are present. A good safety practice is to expect that hazardous voltage is present in any unknown circuit before measuring.

Operators of this product must be protected from electric shock at all times. The responsible body must ensure that operators are prevented access and/or insulated from every connection point. In some cases, connections must be exposed to potential human contact. Product operators in these circumstances must be trained to protect themselves from the risk of electric shock. If the circuit is capable of operating at or above 1000 V, no conductive part of the circuit may be exposed.

Do not connect switching cards directly to unlimited power circuits. They are intended to be used with impedance-limited sources. NEVER connect switching cards directly to AC mains. When connecting sources to switching cards, install protective devices to limit fault current and voltage to the card.

Before operating an instrument, ensure that the line cord is connected to a properly-grounded power receptacle. Inspect the connecting cables, test leads, and jumpers for possible wear, cracks, or breaks before each use.

When installing equipment where access to the main power cord is restricted, such as rack mounting, a separate main input power disconnect device must be provided in close proximity to the equipment and within easy reach of the operator.

For maximum safety, do not touch the product, test cables, or any other instruments while power is applied to the circuit under test. ALWAYS remove power from the entire test system and discharge any capacitors before: connecting or disconnecting cables or jumpers, installing or removing switching cards, or making internal changes, such as installing or removing jumpers.

Do not touch any object that could provide a current path to the common side of the circuit under test or power line (earth) ground. Always make measurements with dry hands while standing on a dry, insulated surface capable of withstanding the voltage being measured.

For safety, instruments and accessories must be used in accordance with the operating instructions. If the instruments or accessories are used in a manner not specified in the operating instructions, the protection provided by the equipment may be impaired.

Do not exceed the maximum signal levels of the instruments and accessories. Maximum signal levels are defined in the specifications and operating information and shown on the instrument panels, test fixture panels, and switching cards.

When fuses are used in a product, replace with the same type and rating for continued protection against fire hazard.

Chassis connections must only be used as shield connections for measuring circuits, NOT as protective earth (safety ground) connections.

If you are using a test fixture, keep the lid closed while power is applied to the device under test. Safe operation requires the use of a lid interlock.

If a  screw is present, connect it to protective earth (safety ground) using the wire recommended in the user documentation.

The  symbol on an instrument means caution, risk of danger. The user must refer to the operating instructions located in the user documentation in all cases where the symbol is marked on the instrument.

The  symbol on an instrument means caution, risk of electric shock. Use standard safety precautions to avoid personal contact with these voltages.

The  symbol on an instrument shows that the surface may be hot. Avoid personal contact to prevent burns.

The  symbol indicates a connection terminal to the equipment frame.

If this  symbol is on a product, it indicates that mercury is present in the display lamp. Please note that the lamp must be properly disposed of according to federal, state, and local laws.

The **WARNING** heading in the user documentation explains dangers that might result in personal injury or death. Always read the associated information very carefully before performing the indicated procedure.

The **CAUTION** heading in the user documentation explains hazards that could damage the instrument. Such damage may invalidate the warranty.

Instrumentation and accessories shall not be connected to humans.

Before performing any maintenance, disconnect the line cord and all test cables.

To maintain protection from electric shock and fire, replacement components in mains circuits — including the power transformer, test leads, and input jacks — must be purchased from Keithley Instruments. Standard fuses with applicable national safety approvals may be used if the rating and type are the same. The detachable mains power cord provided with the instrument may only be replaced with a similarly rated power cord. Other components that are not safety-related may be purchased from other suppliers as long as they are equivalent to the original component (note that selected parts should be purchased only through Keithley Instruments to maintain accuracy and functionality of the product). If you are unsure about the applicability of a replacement component, call a Keithley Instruments office for information.

Unless otherwise noted in product-specific literature, Keithley Instruments instruments are designed to operate indoors only, in the following environment: Altitude at or below 2,000 m (6,562 ft); temperature 0 °C to 50 °C (32 °F to 122 °F); and pollution degree 1 or 2.

To clean an instrument, use a damp cloth or mild, water-based cleaner. Clean the exterior of the instrument only. Do not apply cleaner directly to the instrument or allow liquids to enter or spill on the instrument. Products that consist of a circuit board with no case or chassis (e.g., a data acquisition board for installation into a computer) should never require cleaning if handled according to instructions. If the board becomes contaminated and operation is affected, the board should be returned to the factory for proper cleaning/servicing.

Safety precaution revision as of March 2016.

Table of Contents

Getting started	1-1
Welcome	1-1
Extended warranty	1-1
Contact information	1-1
CD-ROM contents	1-1
Organization of manual	1-2
Features	1-2
Unpacking and inspecting	1-2
Inspect for damage	1-2
Shipment contents	1-3
Optional accessories	1-3
Connecting cables and connectors	1-3
Rack mount kits	1-3
Protection module	1-3
Front-panel familiarization	1-4
Rear-panel familiarization	1-5
Line cord	1-5
Connect to other instruments	1-6
Safe configuration and test setup	2-1
Introduction	2-1
High voltage safety precautions	2-1
Safely connect to instruments	2-2
Line voltage selection	2-2
Interlock circuit	2-2
Connecting the interlock of the Model 2290-10	2-3
Connecting the Model 2290-10 output to a custom test fixture	2-4
Basic operation	3-1
Numeric and cursor keys	3-1
Select, Enter, Clear	3-1
Set output voltage	3-2
Set voltage limit	3-2
Set current limit	3-3
Set current trip	3-3
Store and recall	3-3
Analog programming and monitor	3-4
Remote operation	4-1
Introduction	4-1
RS-232 cable	4-1
Connect GPIB cables to your instrument	4-1

Set the GPIB address	4-3
Bus connections	4-3
Command syntax	4-3
Multiple commands	4-3
Command buffer	4-3
Command queries	4-3
Command examples	4-4
Remote commands	4-4
Output control commands	4-4
Setting control commands	4-5
Interface control commands	4-6
Status reporting commands	4-7
Status messages	5-1
Status reporting	5-1
Status byte register	5-2
Standard event status register	5-2
Error messages.....	6-1
Error and status messages	6-1
Table: Error messages.....	6-1
Table: Summarizes status messages	6-2
Table: Programmatic errors.....	6-2
Typical applications.....	7-1
Introduction	7-1
Program example 1.....	7-1
Program example 2.....	7-4
Performance verification	8-1
Introduction	8-1
Environmental conditions	8-1
Warm-up period	8-1
Recommended test equipment	8-2
Verification procedures	8-2
DC voltage accuracy	8-3
DC current accuracy	8-4
Troubleshooting	9-1
Stuck buttons	9-1
Line power.....	9-1
Repeated trips.....	9-1
Incorrect rear-panel output voltage	9-1
Front-panel test	9-2
Power-on reset.....	9-2

No high voltage	9-2
Service	9-2
Index	I-1

Getting started

In this section:

Welcome	1-1
Unpacking and inspecting	1-2
Optional accessories	1-3
Front-panel familiarization	1-4
Rear-panel familiarization	1-5

Welcome

Thank you for choosing a Keithley Instruments product. The Model 2290-10 10 kV power supply is designed for use in the research laboratory and for test applications. It also has excellent regulation and low output voltage ripple. The digital displays provide accurate readings of voltage and current and also provide for easy, precise setting of output values using digital entry of current and voltage values. Output voltage can be set from the front panel, with a remote analog voltage, or using the RS-232 interface or the IEEE-488 interface. Voltage and current signals are also available for remote monitoring and analog control.

Extended warranty

Additional years of warranty coverage are available on many products. These valuable contracts protect you from unbudgeted service expenses and provide additional years of protection at a fraction of the price of a repair. Extended warranties are available on new and existing products. Contact your local Keithley Instruments representative for details.

Contact information

If you have any questions after you review the information in this documentation, please contact your local Keithley Instruments office, sales partner, or distributor. You can also call the corporate headquarters of Keithley Instruments (toll-free inside the U.S. and Canada only) at 1-800-935-5595, or from outside the U.S. at +1-440-248-0400. For worldwide contact numbers, visit the [Keithley Instruments website](http://www.tek.com/keithley) (<http://www.tek.com/keithley>).

CD-ROM contents

The Series 2290 Power Supply Product Information CD-ROM contains:

User's Manuals: Includes information about optional accessories, operation topics, remote operation, performance verification, troubleshooting, and application examples that you can use as starting point to create your own applications.

LabVIEW™ Driver and IVI Driver software: Instrument drivers are used to communicate with an instrument and help to control it.

Organization of manual

Getting started: Front and rear panel familiarization, LED displays.

Safe connection: Configuration and test setup.

Basic operation: Set the voltage source, set the voltage trip limit, and set the current limit.

Remote operation: Remote interfaces and commands.

Status messages: Description of the Model 2290-10 status messages.

Errors: Error numbers with descriptions.

Typical applications: Detailed examples of how to use commands to accomplish certain test applications.

Performance verification: Environmental conditions, test equipment, and verification procedures.

Troubleshooting: Description of commonly encountered issues and information on how to resolve them.

Features

The key features of the Model 2290-10 include:

- **High-voltage operation.** Source voltages up to a maximum of 10 kV.
- **10 W power capability.** Source currents up to 1 mA at 10 kV.
- **Ease of use.** Digital displays and the keypad simplify setting the voltage and current parameters.
- **Programmable voltage limit.** Voltage limit can be preset to ensure safe operation.
- **Programmable current limit.** Current limit and trip point can be preset to prevent possible equipment damage.
- **Monitor outputs.** Provide 0 to 10 V signals that can be used to monitor the high-voltage output and current.
- **External voltage control.** Allows the high-voltage output value to be controlled with a 0 to 10 V input signal.
- **Standard RS-232 and IEEE-488 interfaces.** Allow the instrument to be remotely controlled by a personal computer.
- **Safety interlock.** Connections to an internal circuit that shuts down the high-voltage output when an external circuit is opened. The external circuit would typically include a limit switch on a test fixture door.

Unpacking and inspecting

Inspect for damage

Upon receiving the Model 2290-10, carefully unpack the instrument and inspect for any obvious signs of physical damage that might have occurred during shipment. Notify the shipping agent of any damage immediately.

Shipment contents

The following items are included with every Model 2290-10 order:

- Model 2290-10 High-Voltage Power Supply
- Model 2290-10 Product Information CD-ROM
- AC line power cord
- Model 2290-10 additional accessories, as ordered
- 3-pin mating interlock connector

Optional accessories

The following optional accessories are available for use with the Model 2290-10:

Connecting cables and connectors

- Model 2290-10-SHVUC: 10 kV SHV male to unterminated cable; 3.05 m (10 ft)
- Model 2290-10-SHV: 10 kV SHV male to SHV male cable; 3.05 m (10 ft)
- Model 2290-INT-CABLE: 3-pin interlock connector to unterminated cable; 3.05 m (10 ft)
- Model 2290-10-SHVBH: 10 kV SHV female bulkhead connector

Rack mount kits

- Model 2290-10-RMK-2: Double rack-mount kit; mounts two power supplies side-by-side
- Model 2290-10-RMK-1: Single rack-mount kit; mounts a single power supply
- Model 4299-7: Shelf rack-mount kit; mounts one or two power supplies

Protection module

Model 2290-PM-200

The protection module is intended for use in applications where a device breakdown or other potential failure could connect the high-voltage output of the Model 2290-5 or Model 2290-10 High Voltage Power Supply to a lower voltage source-measure unit (SMU).

Front-panel familiarization

The Model 2290-10 front panel is shown below. Descriptions of the controls on the front panel follow the figure.

Figure 1: Model 2290-10 Front panel

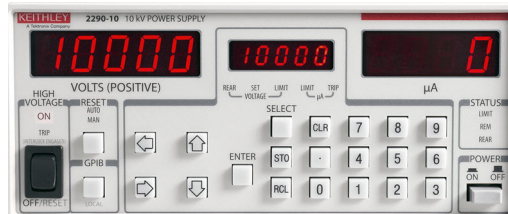

<p>POWER button</p>	<p>Applies power to the instrument. The instrument always powers up with the high voltage off. The current instrument configuration and any saved instrument presets are stored in non-volatile memory. The serial number, firmware version, and model number are displayed when power is turned on. If an error appears on power up, the current instrument configuration and any saved presets are lost, and the default settings are used. To restore the default settings, hold down the clear button (CLR) while turning on the power. Note that this will erase any saved parameters.</p>
<p>HIGH VOLTAGE enable switch</p>	<p>This is a three position switch. In the OFF/RESET position, the high voltage is off, and all trips are cleared. In this position, the high voltage is locked off and cannot be turned on by computer control. The ON position is a momentary-contact position and turns on the high voltage for manual or rear panel analog control. Note that the switch should be held in the ON position for at least a half second to turn the high voltage on. In the middle position, the high voltage is enabled and can be turned on by commands sent over a computer interface. The ON LED above the switch indicates that the high voltage is on; the TRIP LED indicates a trip has occurred.</p>
<p>VOLTS (POSITIVE) LED display</p>	<p>Displays the output voltage.</p>
<p>Center LED display</p>	<p>Displays the value of the parameter that is entered or adjusted, including Error and status messages (on page 6-1) that may occur.</p>
<p>μA LED display</p>	<p>Displays the output current.</p>
<p>SELECT, ENTER, CLR (Clear) button</p>	<p>The SELECT button is used to choose which parameter is being displayed in the center display. The ENTER button enters the parameter shown in the center display. The CLR (clear) button erases the value in the center display and recalls the last value that was entered.</p>
<p>Numeric and cursor buttons</p>	<p>All parameters are adjusted using the cursor or numeric buttons.</p>
<p>STATUS indicators</p>	<p>Three LEDs indicate the instrument's status. The LIMIT LED is on when the unit is in current limit. The REM LED is on when the unit is in remote, and the front panel is locked out. The REAR LED is on when the high voltage is controlled by the analog input.</p>
<p>RESET button</p>	<p>Reset mode determines how the instrument responds after a voltage or current trip. There are two modes: MAN and AUTO. In MAN (manual) mode the high voltage remains off after a trip and requires that the operator manually turn it back on. In AUTO (automatic) mode the unit waits until the output voltage has fallen to 2 % of its full-scale value and then turns the high voltage back on. This feature is useful when dealing with loads that occasionally short circuit, but recover after high voltage has been removed.</p>

GPIB button	The GPIB address button sets the GPIB primary address.
LOCAL button	The LOCAL button takes the instrument out of remote and restores operation of other front panel controls.
STO and RCL buttons	STO (store) and RCL (recall) allow up to nine complete instrument settings to be saved in nonvolatile memory. RCL 0 recalls the default settings.

Rear-panel familiarization

The Model 2290-10 rear panel is shown below. Descriptions of the controls on the rear panel follow the figure.

Figure 2: Model 2290-10 rear panel



Power entry	The power entry module contains the line fuse and the line voltage selection. Refer to the Safely connect to instruments topic for instructions on selecting the correct line voltage and fuse.
HIGH VOLTAGE output port	The HIGH VOLTAGE output port is an SHV female port that connects the Model 2290-10 source output to external equipment. SHV-to-SHV and SHV-to-MHV mated high voltage cables are available.
Analog I/O	The SET BNC jack is an input connection for analog control of the high voltage output. The MONITOR BNC jacks provide voltage and current monitor signals.
GPIB	The 24-pin IEEE-488 STANDARD PORT (GPIB) allows computer control of the Model 2290-10.
RS-232	The RS-232 serial port allows computer control of the Model 2290-10.
INTERLOCK port	The contacts for an external safety circuit intended to prevent personnel from contacting high voltage. The interlock circuit must be engaged to allow the instrument to output high voltage.

Line cord

The Model 2290-10 uses a detachable, three-wire power cord for connection to the power source and to a safety earth ground through a grounded AC outlet. Only use the power cord that is provided with your instrument, or an equivalent adequately rated power cord.

⚠ WARNING

The exposed metal parts of the instrument are connected to the outlet ground through the line cord to provide protection against electrical shock. Always use an AC outlet that has a properly connected safety ground.

Connect to other instruments

The rear panel SET and MONITOR BNC jack shields are connected to chassis ground and the AC power source ground using the power cord. Do not apply any voltage to the shields. The HIGH VOLTAGE SHV port is also connected to chassis ground and cannot be floated above ground.

WARNING

This unit contains hazardous voltages. Be absolutely certain that the high voltage is completely discharged before removing or connecting the high-voltage cable. High-voltage cables can store charge if they are disconnected from the supply while high voltage is turned on, and can cause personal injury or death if not handled properly. Use only connecting cables with a rated working voltage of 10 kV or higher (see the [Optional accessories](#) (on page 1-3) section for more information).

Do not connect the high-voltage output to exposed circuitry. Any load connected to the high-voltage output should be enclosed in a metal shield that is connected to safety earth ground using #18 AWG or larger wire.

If the instrument is used in a manner not specified by Keithley Instruments, the protection provided by the equipment may be impaired.

Safe configuration and test setup

In this section:

Introduction	2-1
High voltage safety precautions	2-1
Safely connect to instruments	2-2
Interlock circuit	2-2

Introduction

The Model 2290-10 can generate hazardous voltages. It is intended for use with a test fixture or in a test system that has safety mechanisms in place to prevent an operator from accessing these voltages.

This section describes how to use the Model 2290-10 to test a device with a custom test fixture or system.

High voltage safety precautions

Make sure that you read and observe the following high voltage safety precautions before operating the Model 2290-10.

WARNING

The Model 2290-10 is capable of sourcing hazardous live high voltages that can cause personal injury or death due to electric shock. This unit should be used only by qualified personnel who recognize the dangers of high voltages.

Make certain that the source is turned off and that high voltage is completely discharged before removing the high-voltage cable. High-voltage cables can store charge if they are disconnected from the supply while the high voltage is on. The charge on the cable can cause injury or damage even after the cable is disconnected from the unit.

The Model 2290-10 is provided with an interlock circuit that must be positively activated in order for the high voltage output to be enabled. The interlock helps facilitate safe operation of the equipment in a test system. Bypassing the interlock could expose the operator to hazardous voltages that could result in personal injury or death.

Safely connect to instruments

Line voltage selection

The Model 2290-10 autodetects the input voltage and the input frequency. It operates from a 100 V AC to 240 V AC power source that has a line frequency between 50 Hz and 60 Hz. Power consumption is less than 80 W total.

The AC power connection on the rear panel provides the connection to the detachable power cord and to a protective ground. Make sure that you always use an outlet that has a protective ground.

There are three versions of the Model 2290-10 to allow operation from a 100, 120, 220, or 240 V nominal AC power source with a line frequency of 50 or 60 Hz. Before connecting the power cord to a power source, verify that the line voltage selector card, located in the rear panel fuse holder, is set for the correct AC line voltage.

CAUTION

This instrument may be damaged if operated with the line voltage selector set for the wrong AC line voltage, or if the wrong fuse is installed.

Interlock circuit

An interlock circuit is provided on the rear panel of the instrument. This circuit must be closed to enable the Model 2290-10 to produce output voltages. When the safety interlock signal is enabled, the power supply is enable to output up to 10 kV. However, when the safety interlock signal is not enabled, the output voltage is turned off.

WARNING

The Model 2290-10 is provided with an interlock circuit that must be positively activated in order for the high voltage output to be enabled. The interlock helps facilitate safe operation of the equipment in a test system. Bypassing the interlock could expose the operator to hazardous voltages that could result in personal injury or death.

Connecting the interlock of the Model 2290-10

The interlock pins control the high-voltage supply.

The pin locations and connections are shown in the following figure. The pins are:

- Pin 3: Chassis ground
- Pin 2: Interlock enable
- Pin 1: +5 V DC out (current limited)

Figure 3: Model 2290 interlock connector wiring

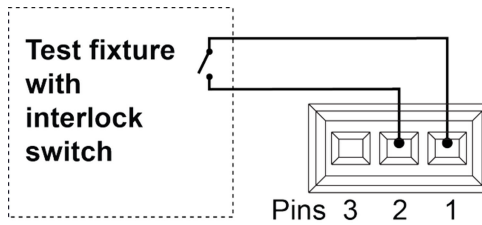

The following figure shows how to connect the Model 2290-10 internal 10 V source in order to engage the external interlock (or interlocks) circuits:

Figure 4: Model 2290-10 Internal 10 kV source

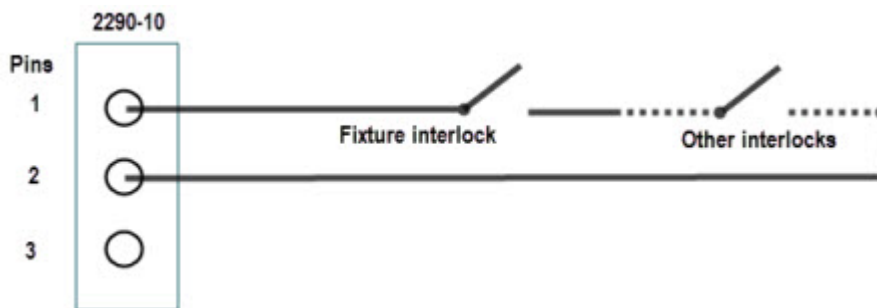

Connecting the Model 2290-10 output to a custom test fixture

Keithley Instruments offers several accessories that can help you when building a custom test fixture or system.

You can use a high-voltage SHV bulkhead connector (Model 2290-10-SHVBH) on your test fixture. The following sections show you how to connect a Model 2290-10 to a custom fixture and also how to make connections to the device inside the custom fixture.

The next figure shows typical high-voltage output connections.

Figure 5: Set up for testing a high-voltage diode in a safe enclosure

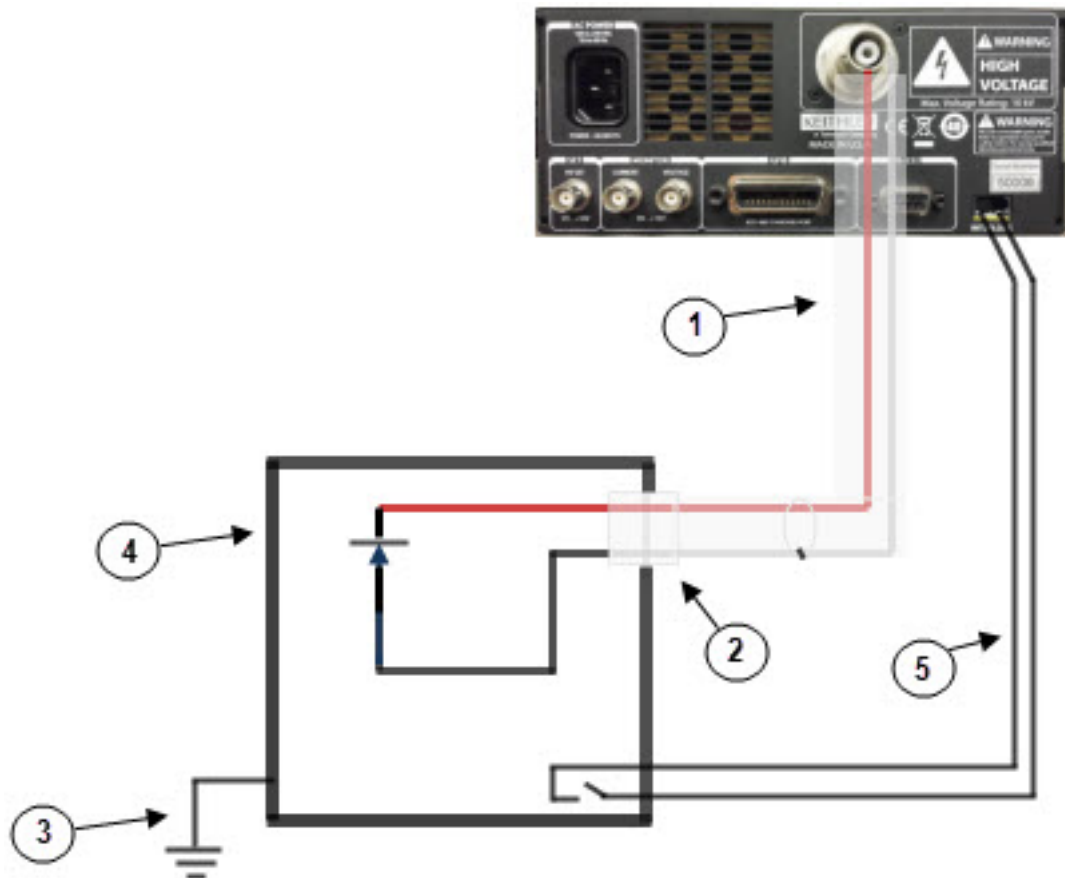

Item	Description	Notes
1	Model 2290-10-SHV high-voltage cable	
2	Model 2290-10-SHVBH high-voltage male bulkhead connector	
3	Test fixture protective earth (safety ground)	
4	Test fixture interlocked metal safety enclosure	A safety enclosure with an interlock that has a normally-open (NO) switch.
5	Test fixture lid interlock switch connection	

 **WARNING**

If you need to convert from safe high-voltage (SHV) to another connector type, be sure to only adapt SHV connectors to connectors that are rated to the maximum possible voltage in your test setup. If you use adapters that are not rated to the maximum possible voltage in your test setup, electric shock may result.

Basic operation

In this section:

Numeric and cursor keys.....	3-1
Select, Enter, Clear	3-1
Set output voltage	3-2
Set voltage limit.....	3-2
Set current limit	3-3
Set current trip.....	3-3
Store and recall	3-3
Analog programming and monitor	3-4

Numeric and cursor keys

All parameters are adjusted using the cursor or numeric keys. When using the cursors, the adjusted digit being adjusted in the center display will flash. When using direct numerical entry, press the number and decimal point buttons until the value you want appears on the center display. Note that the current is specified in μA .

The cursor buttons are used to adjust parameters:

- Up arrow increments the digit
- Down arrow decrements the digit
- Left arrow cursor selects and moves the digit to the left
- Right arrow cursor selects and moves the digit to the right

Select, Enter, Clear

To adjust a value, press the **SELECT** button until the appropriate LED is lit (for example, the VOLTAGE LEDs SET or LIMIT). While the value is changing, the appropriate LED will flash indicating that the value in the center display is not the present unit setting. If an incorrect value is entered, press **CLR** (clear) to start over. When the value you want is in the center display, press the **ENTER** button to update the unit's actual setting, and the LED will stop flashing

Set output voltage

To manually set the output voltage, with the high voltage on or off (refer to the [Front-panel familiarization](#) (on page 1-4) graphic for more information):

1. Press the **SELECT** button until the **VOLTAGE SET** LED is on. The present voltage setting will appear on the center display.
2. To change the voltage setting, enter the voltage using either the numeric or cursor buttons.
3. After the new value has been entered into the center display, press **ENTER** to update the output voltage.

NOTE

The **VOLTAGE SET** LED will flash until **ENTER** or **CLR** is pressed to remind you that the displayed value is not the actual programmed value.

If an Err2 message appears (illegal parameter entered), check the voltage limit to see that it is greater than or equal to the set voltage. Use the **CLR** button to clear any error message (see the Set voltage limit topic for more information).

If the **REAR** LED is on, the high voltage is programmed from the voltage applied to the analog input on the rear panel. In this mode, the high voltage cannot be programmed from the front panel, and the center display will show the actual output voltage in the **VOLTAGE SET** mode.

If you want to set the output voltage remotely, refer to the command [VSET\(?\) <n>](#) (on page 4-6) (voltage set). To set the output voltage using the rear panel analog input, refer to the Analog programming and monitor topic.

Set voltage limit

The voltage limit is a protection feature intended to prevent the output voltage from being set too high or from overshooting because of large load changes. The output voltage cannot be set higher than the voltage limit. In addition, if the output voltage ever exceeds the programmed limit by more than 10 % of full scale, the trip point is reached, and the high voltage is disabled. In this case, a VTRP (voltage trip) message appears on the center display.

NOTE

It is not necessary to clear the trip before turning the high voltage back on. If it is necessary to change a parameter before turning the high voltage back on, pressing **CLR** or placing the high voltage switch in the off position will clear the trip.

Set the voltage limit as follows:

1. Press the **SELECT** button until the **VOLTAGE LIMIT** LED is lit. The present value of the voltage limit is shown on the center display.
2. Change the limit value using either the numeric or cursor buttons.
3. Press **ENTER** to update the actual limit value.

NOTE

If an Err2 message appears (illegal parameter entered), check to see that the output voltage is less than or equal to the new voltage limit.

Set current limit

The power supply output current is clamped at the current limit. If the current limit is reached, the output voltage may not equal its programmed value. When the unit is current limited, the STATUS LIMIT LED is on.

Set the current limit as follows:

1. Press the **SELECT** button until the μ A LIMIT LED is on. The present value of the current limit is shown on the center display.
2. Change the limit value using either the numeric or cursor buttons.
3. Press **ENTER** to update the actual limit value.

Set current trip

The current trip shuts off the high voltage when the output current exceeds the trip value. The current trip value is set in the same manner as the voltage and current limits. After a current trip occurs, the ITRP (current trip) message will appear on the middle display. Current trips are cleared in the same fashion as voltage trips.

Set the current trip as follows:

1. Press the **SELECT** button until the μ A TRIP LED is on. The present value of the current trip is displayed in the center window.
2. Change the limit value using either the numeric or cursor buttons.
3. Press **ENTER** to update the actual trip value.

Store and recall

STO (store) and RCL (recall) allow up to nine complete instrument setups to be saved in nonvolatile memory and later recalled.

To store a setup:

1. Program the various instrument operating modes to be stored.
2. Press the **STO** button.
3. Press a number (**1** to **9**) to select the storage location.
4. Press the **ENTER** button to complete the storage process.

To recall a setup:

1. Press the **RCL** button.
2. Press the number button (**0** to **9**) for the configuration to be recalled (RCL 0 returns the instrument to the factory default setup).
3. Press the **ENTER** button.

NOTE

Whenever a setup is recalled, the high voltage is turned off for safety.

If an Err3 (recall error) occurs, the stored setup was lost due to a memory error and must be stored again using the STO button.

The factory default setup can be recalled by pressing the **CLR** button while turning on the power or by recalling setup 0 (RCL 0). The default setup is also recalled after a power-on memory error (Err 1). The next table lists the factory default setup.

Mode	Default setting
Output voltage	0 V
Voltage limit	10000 V
Current limit	1050 μ A
Current trip	1050 μ A
Reset mode	MAN
High voltage	OFF
GPIB address	14

Analog programming and monitor

There are two MONITOR output BNC connections on the rear panel of the Model 2290-10. Both are 0 to +10 V outputs. There is also a SET BNC connection that is used to receive analog programming voltage.

To select the rear SET analog high voltage control, press **SELECT** on the front panel until the REAR LED is on, then press **ENTER**.

⚠ WARNING

The BNC jack outer shells are connected to chassis ground and cannot be floated.

Figure 6: 2290-10 Voltage and current monitor connections

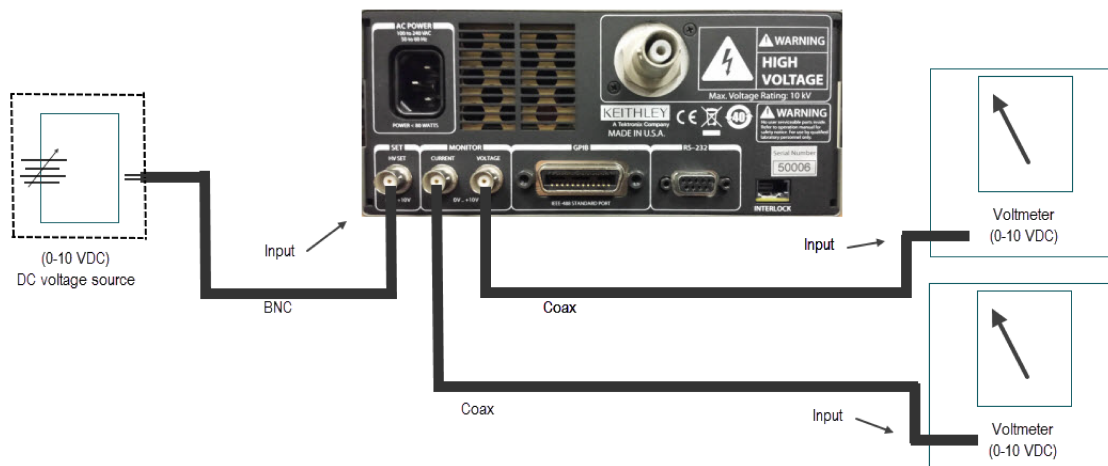

When the REAR LED is on, the output voltage is controlled by the rear panel signal and displayed on the center display when in the VOLTAGE SET mode. The voltage limit is still active, and the unit does not allow the rear panel voltage to set the output value above the voltage limit.

Voltage Set: This BNC jack becomes an analog control input for the high-voltage output. An input of 0 V to +10 V will set the output voltage from 0 V to full scale. The next table summarizes the analog input voltage examples.

Analog input voltage	High-voltage output
2 V	2000 V
5 V	5000 V
7 V	7000 V
10 V	10000 V

Voltage Monitor: Provides 0 to +10 V for 0 to full-scale output. The next table lists voltage monitor examples.

Output voltage	Analog monitor examples
1000 V	1 V
3500 V	3.5 V
5000 V	5 V
10000 V	10 V

Current Monitor: Provides a 0 to +10 V signal for 0 to full-scale current output. The next table summarizes the current monitor output examples.

Current output	Current monitor
100 μ A	1 V
350 μ A	3.5 V
700 μ A	7 V
1000 μ A	10 V

Remote operation

In this section:

Introduction	4-1
Command syntax	4-3
Remote commands	4-4

Introduction

This section contains detailed information on remotely programming the Model 2290-10 over the IEEE-488 (GPIB) interface and the RS-232 interface. Any computer that supports the IEEE-488 bus may be used to program the instrument. The Model 2290-10 supports the IEEE-488.1 (1978) interface standard, as well as the required common commands of the IEEE-488.2 (1987) standard.

The cabling distance between the controller and instrument hub with GPIB is limited to 9 m (30 ft). In a system connected with GPIB, you can have 15 instruments attached to each controller.

RS-232 cable

The settings for the RS-232 interface are 9600 baud and with no parity. The complete instrument configuration is retained in nonvolatile memory.

Connect GPIB cables to your instrument

To connect an instrument to the GPIB, use a cable equipped with standard GPIB connectors, as shown below.

Figure 7: GPIB Connector

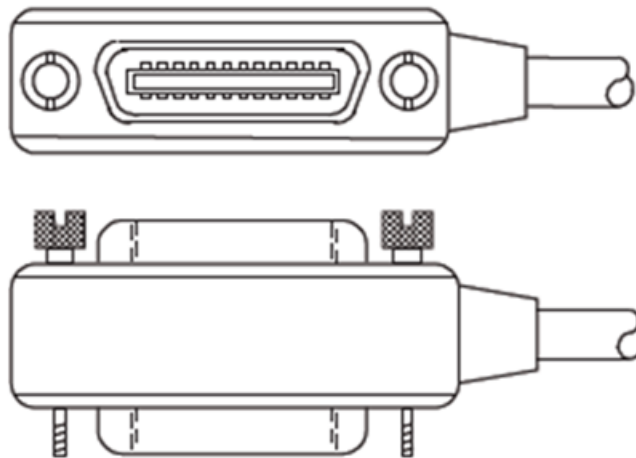

To make a parallel connection to the instrument, stack the connectors. Each connector has two screws to ensure that connections remain secure. The figure below shows a typical connection diagram for a test system with multiple instrument .

⚠ CAUTION

To avoid possible mechanical damage, stack no more than three connectors on any one instrument. To minimize interference caused by electromagnetic radiation, use only shielded IEEE-488 cables. Contact Keithley Instruments for shielded cables.

Figure 8: Model 2290-10 GPIB example connections

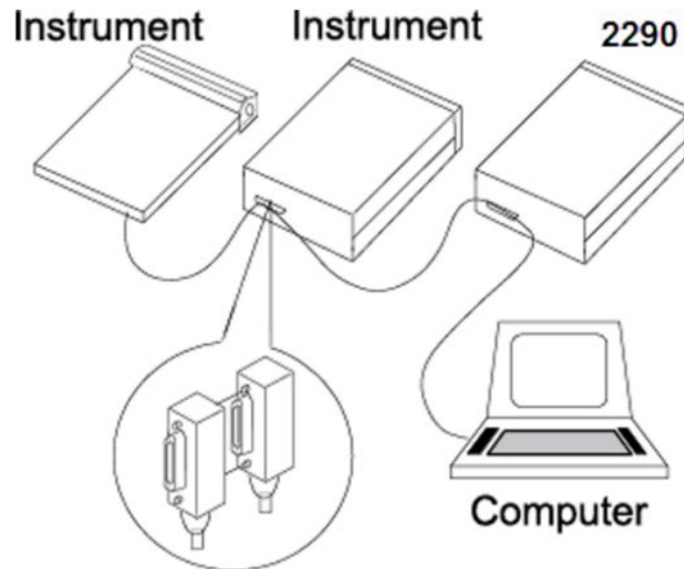

To connect the instrument to the GPIB:

1. Align the cable connector with the port on the rear panel. The location of the port is shown in the following figure.
2. Attach the connector. Tighten the screws securely but do not overtighten them.

Figure 9: Model 2290-10 rear panel GPIB location

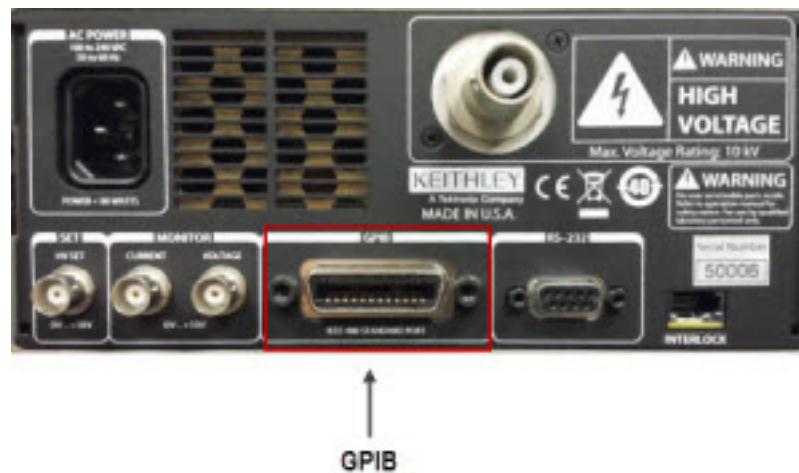

3. Connect any additional connectors from other instruments, as required for your application.
4. Ensure the other end of the cable is properly connected to the controller.

Set the GPIB address

The default GPIB address is 14. Before attempting to communicate with the Model 2290-10 over the IEEE-488 interface, make sure the instrument's primary address is set correctly. To enter the GPIB address, press the **GPIB** button and then increment or decrement the address as required using the up and down arrow buttons and then press **ENTER**. The allowable primary address range is from 0 to 30. Be sure to avoid address conflicts with other instruments on the bus, including the controller.

Bus connections

With the power off, connect the Model 2290-10 GPIB connector to the computer IEEE-488 interface. Shielded GPIB cables such as the Keithley Model 7007 are recommended.

Command syntax

Commands sent to the Model 2290-10 use ASCII characters. Commands may be in either upper or lower case and may contain any number of embedded space characters.

A command to the Model 2290-10 must be followed by a command terminator. The terminator is a linefeed (<LF>) or EOI. No command processing occurs until a command terminator is received. Commands beginning with an asterisk (*) are IEEE-488.2 defined common commands.

Multiple commands

Multiple commands may be sent on one command line by separating them with semicolons (;). When several commands are included on the same line, the entire line is parsed and executed before any other device action proceeds. This method allows command synchronization using the synchronization command (*WAI).

Command buffer

The Model 2290-10 stores incoming bytes in a 128-character input buffer. Characters accumulate in the input buffer until a command terminator (either <CR> or <LF>) is received, at which point the message is parsed and executed. Query responses are buffered in a 128-character output queue. If the buffer overflows, then all of the data in the both the input buffer and output queue are discarded, and an error is reported in the standard event status byte.

Command queries

The present value of a particular parameter may be determined by querying the Model 2290-10 for its value. A query is formed by appending a question mark (?) to the command and omitting the parameter from the command. If multiple queries are sent on one command line (separated by semicolons), responses will be returned in a single line with the individual responses separated by semicolons. The default response terminator is a linefeed (<LF>) plus EOI. All commands return integer results except as noted in individual command descriptions.

Command examples

Command	Description
VSET 1.0E3	Sets the voltage to 1000 V.
VSET?	Queries the voltage setting.
*IDN?	Queries the device identification.
VSET 100.0;VSET?	Sets the voltage to 100 V and queries the voltage.

Remote commands

The following Model 2290-10 commands are divided by the type of command: Output control, Setting control, Interface control, and Status reporting. Note that multiple parameters are separated by commas. Commands with queries are followed by a question mark in parentheses (?). Commands that have only a query include a "?". Commands that cannot be queried have no question mark. Brackets [] indicate the parameter is optional. An asterisk (*) preceding the command indicates IEEE-488.2 common commands.

NOTE

Parentheses shown in command descriptions indicate only that a query form is available. Do not include parentheses in commands.

Output control commands

HVOF

The **HVOF** command turns off the high voltage output.

HVON

The **HVON** command turns on the high voltage provided that the front panel HIGH VOLTAGE switch is not in the OFF position. If the switch is in the OFF position, the high voltage is left off, and an execution error is reported. This command also automatically clears any voltage or current trips.

IOUT?

The **IOUT?** query returns the value of the actual output current. This value is the same as that shown on the front panel μ A display.

NOTE

As with the front-panel display, this value takes about one second to stabilize after a change in current.

VOUT?

The `VOUT?` query returns the actual output voltage. This value is the same as that shown on the front panel VOLTS display. The value returned is a floating-point number and includes the + sign of the output voltage.

NOTE

As with the front panel voltage display, this value takes about one second to stabilize after a change in voltage.

Setting control commands

*RCL <n>

The `*RCL` (recall) command recalls stored configuration setting <n>, where <n> ranges from 0 to 9. Setting 0 recalls the default settings. If the stored setting is corrupted, an error is returned.

Example: `*RCL 0` Recall default setting

*SAV <n>

The `*SAV` (Save) command stores the present instrument setup as setting <n>, where <n> ranges from 1 to 9.

Example: `*SAV 3` Save setting #3

ILIM(?) <n>

The `ILIM` command sets the value of the current limit to <n>, where <n> is a floating-point value in amperes. The `ILIM?` query returns the current limit setting.

Example: `ILIM 1E-6` Set 1 μ A current limit

Default value: 1.05 μ A

ITRP(?) <n>

The `ITRP` command sets the value of the current trip to <n>, where <n> is a floating-point value in amperes. The `ITRP?` query returns the current trip setting.

Example: `ITRP 1E-6` Set 1 μ A trip current

Default value: 1.05 μ A

SMOD?

The `SMOD?` query returns the `VSET` setting mode. A returned value of 0 indicates that the voltage value is controlled by the front panel or bus setting, while the value 1 indicates that the output is controlled by the rear-panel SET/MON voltage control input. Note that the setting mode may only be changed by setting the rear-panel VOLTAGE switch.

TCLR

The `TCLR` command clears any voltage or current trips.

TMOD(?) <n>

The `TMOD` command sets the trip reset mode. The value `<n> = 0` sets manual trip reset, while the value `<n> = 1` sets the trip reset mode to automatic.

VLIM(?) <n>

The `VLIM` command sets the value of the voltage limit to `<n>`, where `<n>` is in volts. The `VLIM?` query returns the present limit setting. As with front panel control, the `VLIM` value must be greater than or equal to the `VSET` value, or an execution error will occur.

Example: `VLIM 500` Set 500 V voltage limit

Default value: 10000 V

VSET(?) <n>

The `VSET` command sets the voltage output level to `<n>`. If rear panel control is enabled, an error is returned. The value `<n>` is in volts. The `VSET?` query returns the current `VSET` value. As with front panel control, the `VSET` value must be less than or equal to the `VLIM` value, or an execution error will occur.

Example: `VSET 2500` Set output to 2.5 kV

Default value: 0 V

Interface control commands

*RST

The `*RST` (reset) common command resets the Model 2290-10 to its default configuration. This command performs the same function as holding down the front panel CLR button at power-on.

*OPC?

The `OPC?` command causes the operation complete bit in the status event register to be set when all previously started local overlapped commands are complete. Note that each node independently sets its own operation complete bits in its own status model. Any nodes that are not actively performing overlapped commands set the bits immediately. All remaining nodes set their own bits as they complete their own overlapped commands.

LERR?

The `LERR?` query returns the error code of the last remote interface error (see the [Table: Programmatic errors](#) (on page 6-2) for more information).

Example: `*IDN; LERR?` 113

*IDN?

The `*IDN?` (identification) common query returns the Model 2290-10 device configuration. The response string is in the format:

KEITHLEY INSTRUMENTS, MODEL 2290-10, <serial_number>, <version_number>

Where:

2290-10 is the model number.

serial_number is the serial number of the particular unit.

version_number is the 3-digit firmware version level.

*WAI

The `*WAI` common command is a synchronization command that halts further command processing until all present commands are complete. For example, the commands `WAI` and `HVON` will wait until the operation is complete, and turn the high voltage back on.

Status reporting commands

The following commands control various status reporting aspects.

*CLS

The `*CLS` (Clear Status) common command clears all status registers.

*ESE(?) <n>

The `*ESE` common command sets the Standard Event Status Enable Register. The parameter <n> is the decimal value that programs the enable register.

Example: `*ESE 12` Set bits 2 and 3

*ESR? [<n>]

The `*ESR?` common query reads the value of the Standard Event Status Register. If the parameter <n> is present, the value of bit <n> is returned. Reading this register without specifying <n> will clear the register, but reading bit <n> will clear only bit <n>. The range of <n> is 0 to 7.

Example: `ESR? 2` Request and clear bit 2

***PSC(?) <n>**

The *PSC (Power-on Status Clear) common command sets the value of the power-on status clear bit. If <n> = 1, the power-on status clear bit is set, and all status registers and enable registers are cleared on power-up. If <n> = 0, the bit is cleared, and the status enable registers maintain their values at power-down. This feature allows the generation of a service request at power-up.

Example: *PSC 1 Set power-on status clear bit

***SRE(?) <n>**

The *SRE (service request enable) common command sets the value of the Service Request Enable Register. The parameter <n> is the decimal value representing the register bits to be set.

Example: *SRE 3 Set bits 0 and 1

***STB? [<n>]**

The *STB? (status byte) common query reads the value of the Status Byte Register. If the parameter <n> is included, the value of bit <n> is returned. Reading this register has no effect on its value; it only represents the summary of the other status registers. The range of <n> is 0 to 7.

Example: *STB? 1 Request bit 1 status

Status messages

In this section:

Status reporting..... 5-1

Status reporting

The Model 2290-10 reports on its status with two registers: The Status Byte Register and the Standard Event Status Register. The overall configuration of these registers is shown in the next figure. Note that bits 0, 1, and 8 through 15 of both the Standard Event Status Register and Standard Event Status Enable Register are not used in the Model 2290-10 and are always set to zero.

On power-up, the Model 2290-10 will either clear all of its status enable registers or maintain them in the state they were in during power-down. The action taken is controlled by the *PSC command and allows events such as SRQ on power-up to be generated.

Figure 10: Model 2290-10 Status model

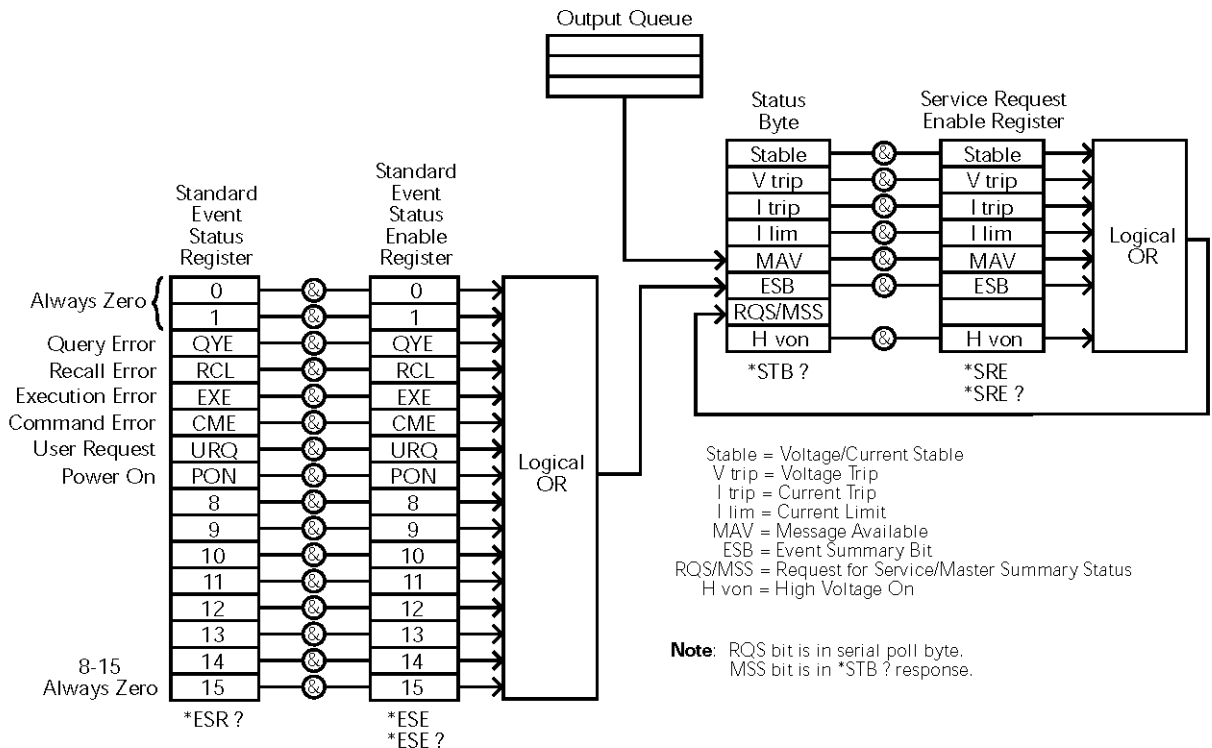

Status byte register

The next table summarizes bits in the Status Byte, which may be read with the *STB? query or with the serial polling sequence. The Model 2290-10 will generate a service request (SRQ) whenever one of these bits is set and the corresponding bit in the Service Request Enable Register is set, except for bit 6, the RQS/MSS bit. (Use the *SRE command and the decimal bit value in the table to set Service Request Enable Register bits.) Note that any given status condition will produce only one SRQ even if that condition is never cleared.

Table: Status byte

Bit	Decimal value	Name	Description
0	1	Stable	Indicates that the VSET or ILIM value is stable. The function depends on whether the Model 2290-10 is in current limit or constant voltage mode.
1	2	¹ V trip	Indicates that a voltage trip has occurred.
2	4	¹ I trip	Indicates that a current trip has occurred.
3	8	¹ I lim	Indicates that a current limit condition has occurred.
4	16	MAV	Indicates message available in the GPIB output queue.
5	32	ESB	Indicates that an unmasked bit in the Standard Event Status Register has been set.
6	64	² RQS/MSS	Request for Service/Master Summary Status.
7	128	HV on	Indicates that the high voltage is on.
Note: SRQ may be enabled for corresponding condition by sending *SRE with decimal value of bit (except bit 6). For example, *SRE 4 enables SRQ on current trip.			
¹ The V trip, I trip, and I lim bits are latched bits. They are set on the occurrence of the appropriate event and will remain set until either the status byte is read or the *CLS command is sent. Latching allows you to detect if a trip or limit condition has ever occurred.			
² Request for Service bit in serial poll byte. Master Summary Status bit in *STB? response.			

Standard event status register

The next table summarizes the bits in the Standard Event Status Register, which can be read using the *ESR? query. This status register is defined by the IEEE-488.2 standard and is used primarily to report errors in commands received over the GPIB. When the bits in this register are latched, they stay latched and are cleared by reading them, or by sending the *CLS command. If a bit in the Standard Event Status Register is latched and the corresponding bit in the Standard Event Status Enable Register (programmed with *ESE) is also latched, the ESB bit in the Status Byte Register is latched.

Table: Standard event status register

Bit	Decimal value	Name	Description
0	1	Unused	
1	2	Unused	
2	4	Query Error	Set by an output queue overflow.
3	8	Recall Error	Set if a stored configuration setting is corrupt.
4	16	Execution Error	Set by an out-of-range parameter, or non-completion of a command due to a condition such as an overload.
5	32	Command Error	Set by a command syntax error or unrecognized command.
6	64	URQ	Set by any button press.
7	128	PON	Set by power-on.
Note: Set ESB bit in Status Byte Register by sending the *ESE command with the condition you want. For example, *ESE 16 sets ESB on execution error.			

Error messages

In this section:

Error and status messages 6-1

Error and status messages

Table: Error messages

The next table shows the error numbers that you will see on the center display. These errors also set corresponding bits of the Standard Event Status Register.

Note that the **CLR** button clears any errors.

Error number	Description	Comments
Err1	Memory Error	Power-on memory error of the last setup. Default setup is recalled.
Err2	Illegal Parameter Entered	Parameter entered is out of range.
Err3	Stored Value Recall Error	The stored setup (from STO and RCL) was lost.
Err4	Illegal Storage Address	STO 0 is reserved for default settings.
Err5	No GPIB Interface	GPIB interface not detected, and the GPIB address cannot be set.
Err6	Syntax error over GPIB	Invalid command. Err6 indicates the command had an error in syntax or was unrecognizable. A syntax error could be a misspelling of a command. This error will set the Command Error bit (bit 5) of the Standard Event Status Register.
Err7	Illegal parameter sent over GPIB	Parameter programmed is out of range. Err7 indicates a parameter was set out of range, or a command could not be completed because of an overload. This error will set the Execution Error bit (bit 4) of the Standard Event Status Register.
Err8	GPIB Output queue full	Output buffer overflowed. Err8 indicates the output queue overflowed and was cleared. This error could be caused by querying the unit repeatedly and not reading out all of the characters, or by a problem at the GPIB controller (the unit that's requesting and receiving the data). This error will set the Query Error bit (bit 2) of the Standard Event Status Register.

Table: Summarizes status messages

The next table summarizes the status messages. Note that the message indicated in the next table is seen on the center display.

Message	Description
VTRP	Voltage trip (voltage limit exceeded)
ITRP	Current trip (current limit exceeded)
PTRP	Primary trip (power transformer primary current limit exceeded)

Table: Programmatic errors

Note that the error numbers in the next table are not available on the center display and are only available using the `LERR?` (last error) query. This query returns the error number of the last remote interface error.

This is a list of possible error numbers and descriptions (see [LERR?](#) (on page 4-7) for more information)

Error number	Description
10	Illegal value (execution)
100	Lost data (query)
101	No data (query)
102	No listener (query)
103	Overflow (query)
110	Illegal command (parser)
111	Undefined command (parser)
112	Illegal query (parser)
113	Illegal set (parser)
114	Null parameter (parser)
115	Extra parameter (parser)
116	Missing parameter (parser)
117	Overflow (parser)
118	Bad float (parser)
119	Float overflow (parser)
120	Bad integer (parser)
121	Integer overflow (parser)
122	Bad hex value (parser)
123	Hex overflow (parser)
124	Bad token integer (parser)
125	Unknown token (parser)
126	Syntax error (parser)
151	CMF reset (device dependent)
152	COP reset (device dependent)
153	Illegal reset (device dependent)
154	Recall error (device dependent)
155	Watchdog (device dependent)

Typical applications

In this section:

Introduction 7-1

Introduction

This section is broken into two examples:

Example 1 demonstrates how to generate a basic linear voltage sweep with the Model 2290-10 to reverse bias a high-voltage diode and make leakage current measurements at each point of the sweep.

Example 2 demonstrates basic interaction of the Model 2290-10 high-voltage power supply with a Model 263xB System SourceMeter< R> instrument. The Model 2290-10 is used to generate a basic linear voltage sweep across the diode and the Model 263xB is used to make a leakage current measurement on the diode.

Program example 1

Linear voltage sweep and current measurements with Model 2990-5

Equipment needed:

- 1 high-voltage diode enclosed in a safe test fixture
- 1 Model 2290-10 high-voltage power supply
- 1 GPIB cable to connect the Model 2290-10 to a computer with a GPIB interface
- Appropriate cabling to connect the Model 2290-10 to the test fixture

Device connections:

The Model 2290-10 is a unipolar power supply. Therefore, the diode should be connected so that it can be reverse-biased, that is the cathode should be connected to the HI output terminal of the Model 2290-10.

Figure 11: Model 2290-10 reverse-biased diode

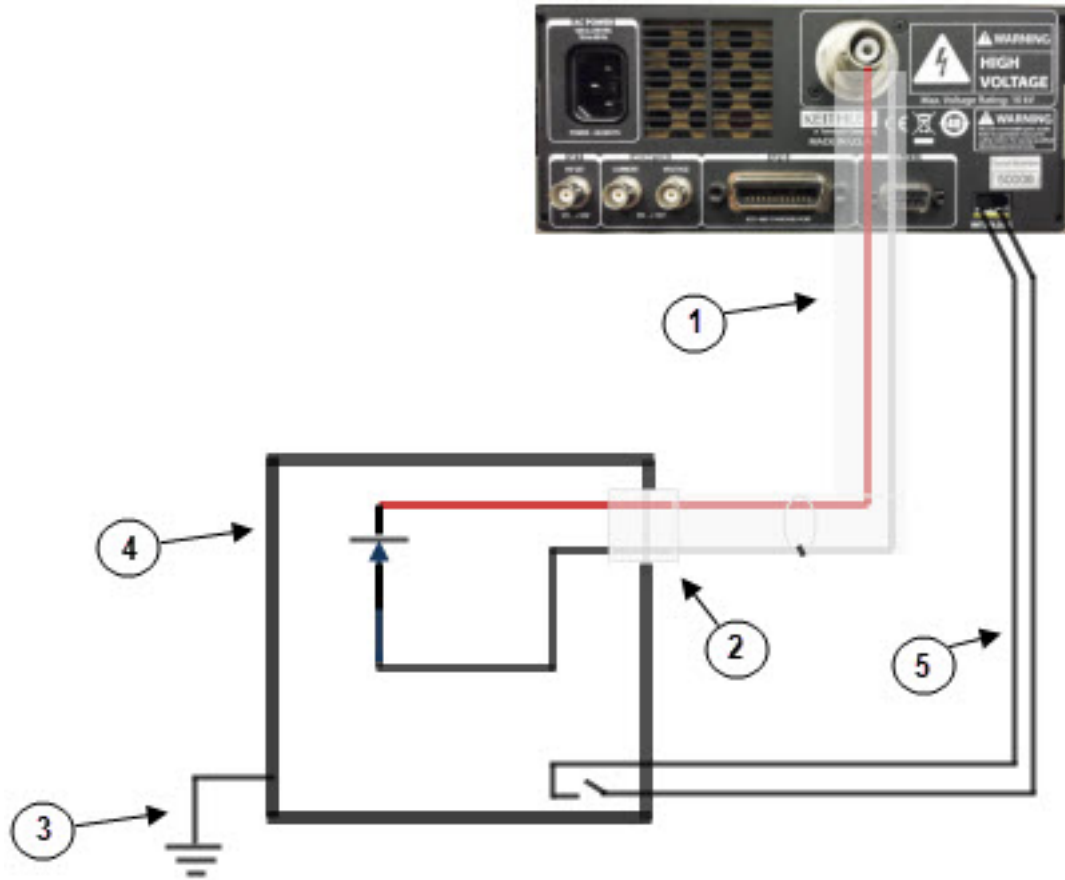

Item	Description	Notes
1	Model 2290-10-SHV high-voltage cable	
2	Model 2290-10-SHVBH high-voltage male bulkhead connector	
3	Test fixture protective earth (safety ground)	
4	Interlocked metal safety enclosure	A safety enclosure with an interlock that has a normally-open (NO) switch.
5	Test fixture interlock switch connection	

Example program code

The following code was created and tested using the Python® programming language using the pyVISA module. To learn more about Python, go to www.python.org (<http://www.python.org>).

NOTE

The example python program code below can be copied and pasted for your testing purposes, however, the code must match to include the indents of specific lines.

```
# Import pyVISA module into the Python environment.
import visa
import time

# Open a VISA session with the Model 2290 at GPIB address 14.
ki2290 = visa.instrument("GPIB::14")

# Reset and clear the status of the Model 2290.
ki2290.write("*RST")
ki2290.write("*CLS")
ki2290.write("*RCL 0")

# Define sweep variables for the programmed output voltage and
# measured current readings.
voltage = 0
currReading = ""
currRdgList = []

# Turn on the output of the Model 2290.
time.sleep(1)
ki2290.write("HVON")

# Perform a sweep from 0 to 3000 V and make current measurements
# at each point of the sweep.
for n in range(0,11):
    ki2290.write("VSET"+str(voltage))
    time.sleep(2) # Allow new voltage level to stabilize
    currReading = ki2290.ask("IOUT?")
    currRdgList.append(currReading)
    voltage = voltage + 300

# Set the output voltage of the Model 2290 to 0V and turn
# off its output.
ki2290.write("VSET 0")
ki2290.write("HVOF")

# Print the current measurements.
print "Current Measurements: ", currRdgList
```

Program example 2

Linear voltage sweep with Model 2290-10 and current measurements with Model 263xB

The next figure shows how to connect the interlock circuits of the Model 2290-10 and the Keithley Model 263xB SourceMeter® instrument with the normally-open switch on the test fixture:

Figure 12: Interfacing the interlock circuits of the Model 2290-10 and the Model 263xB SourceMeter instrument to the test fixture

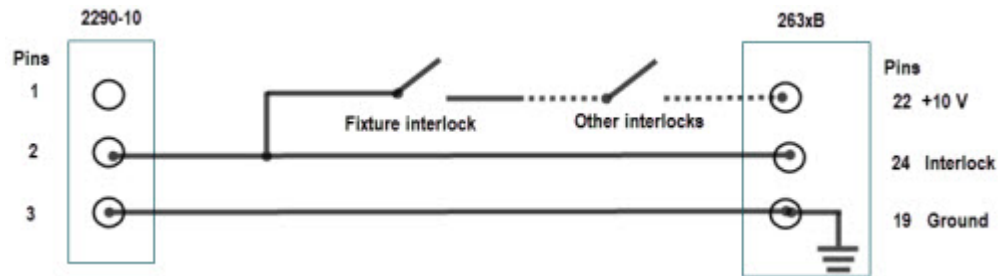

The output of the Model 2290-10 can only be turned on when the interlock is engaged. The interlock is engaged when the interlock pin is pulled high through a switch to more than +3 V. The interlock is disengaged when the signal applied is less than +1.2 V.

The interlock is intended for use through a normally open switch, which may be installed on the lid of a test fixture, on the enclosure of a semiconductor prober or device handler, or on the door or doors of a test equipment rack.

In the next example, the reverse-bias sweep across the diode is performed like program example 1. However, the Model 263xB System SourceMeter instrument is used to obtain more accurate leakage current measurements on the diode. This example may also be easily applied to measuring the drain leakage current of a MOSFET, or collector leakage current of a BJT or IGBT.

Equipment needed:

- 1 high-voltage diode enclosed in a safe test fixture
- 1 Model 2290-10 high-voltage power supply
- 2 GPIB cables to connect the Model 2290-10 and the Model 263xB to a computer with a GPIB interface
- 2 Model 2290-10-SHV cables
- 2 Model 2290-10-SHVBH bulkhead connectors
- 1 Model 2290-PM-200 protection module
- 2 Model 7078-TRX cables to connect the Model 263xB to the protection module

Device connections of a high-voltage diode test with a Model 2290-10 high voltage supply, protection module, and SourceMeter instrument follow.

The next figure is a simple circuit schematic of the test performed in this example.

Figure 13: Model 2290-10 reverse-biased diode connections with SourceMeter 1

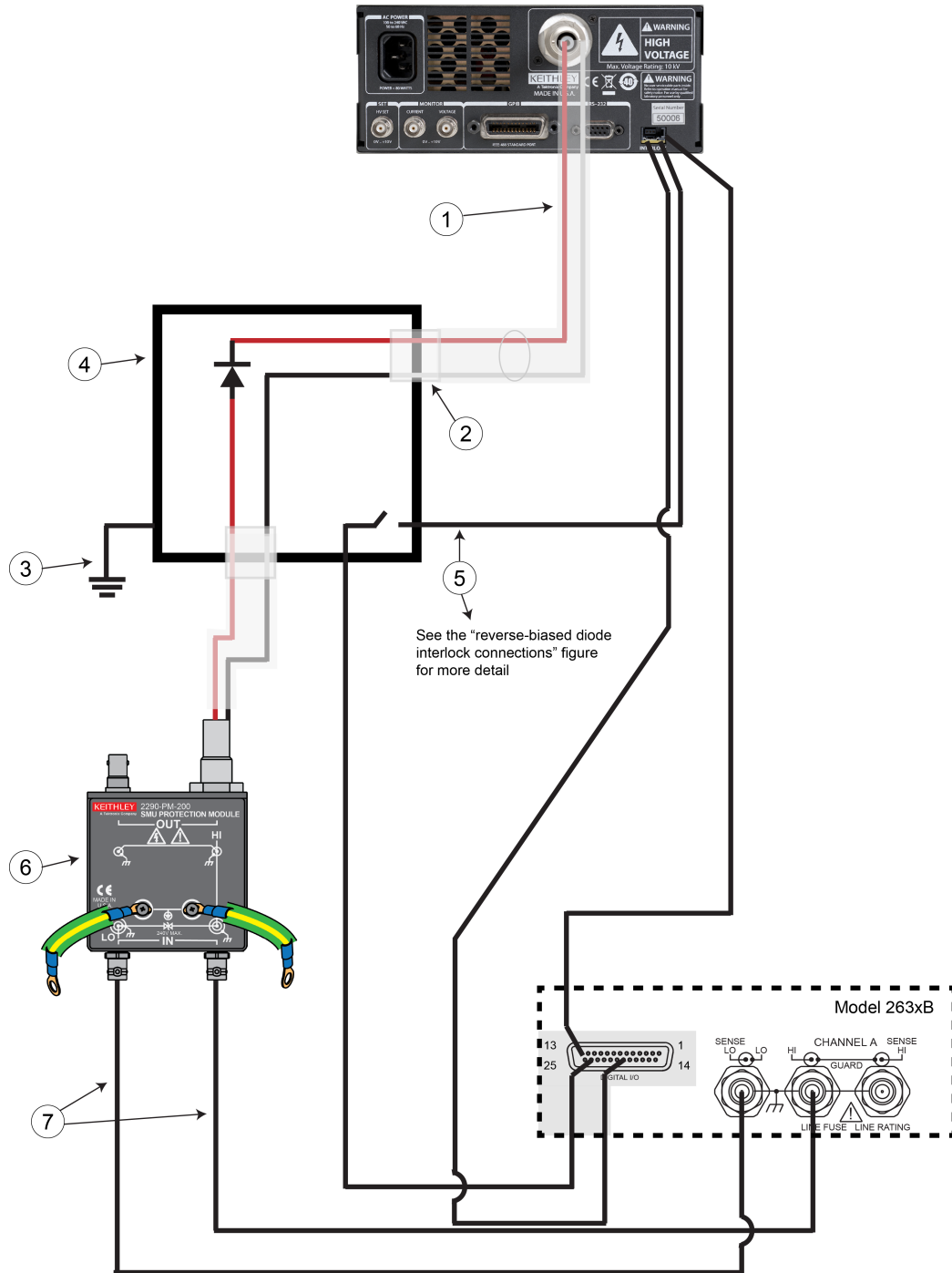

Item	Description	Notes
1	Model 2290-10-SHV high-voltage cable	
2	Model 2290-10-SHVBH high-voltage male bulkhead connector	
3	Test fixture protective earth (safety ground)	
4	Interlocked metal safety enclosure	A safety enclosure with an interlock that has a normally-open (NO) switch.
5	Test fixture interlock switch connections	For 2290-10 connect pin 2 (interlock) and pin 3 (ground) , and 263xB connect pin 22 (+5 V DC out), pin 24 (interlock), pin 19 (ground).
6	Model 2290-PM-200 high voltage SMU Protection Module	
7	Model 7078-TRX cables	Connect the Protection Module to the Model 263xB SMU

The next figure details how these connections should be made in a safe test enclosure.

Figure 14: Model 2290-10 reverse-biased diode interlock connections

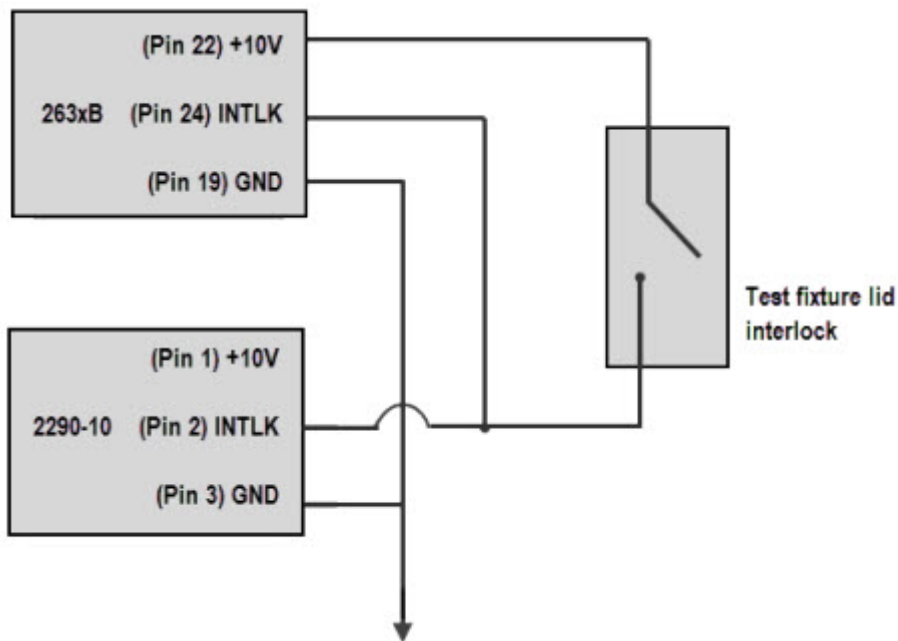

Example program code

The following code was created and tested using the Python programming language using the pyVISA module. To learn more about Python, go to www.python.org (<http://www.python.org>).

NOTE

The example python program code below can be copied and pasted for your testing purposes, however, the code must match to include the indents of specific lines.

```
# Import pyVISA module into the Python environment.
import visa
import time

# Open a VISA session with the Model 2290 at GPIB address 14
# and 263xB at GPIB address 26.
ki2290 = visa.instrument("GPIB::14")
ki263x = visa.instrument("GPIB::26")

# Reset and clear the status of the Model 263xB.
ki263x.write("reset()")
ki263x.write("*CLS")

# Reset and clear any errors of the Model 2290.
ki2290.write("*RST")
ki2290.write("*CLS")
ki2290.write("*RCL 0")

# Configure the Model 263xB as an ammeter, set the current
# limit and current measurement range.
ki263x.write("smua.source.rangev = 0.2")
ki263x.write("smua.source.levelv = 0")
ki263x.write("smua.source.limiti = 1e-3")
ki263x.write("smua.measure.rangei = 100e-6")

# Configure the display of the Model 263xB and turn on the output.
ki263x.write("display.screen = display.SMUA")
ki263x.write("display.smua.measure.func = display.MEASURE_DCAMPS")
ki263x.write("smua.source.output = smua.OUTPUT_ON")

# Define sweep variables for the programmed output voltage
# and measured current readings.
voltage = 0
currReading = ""
currRdgList = []

# turn on the output of the Model 2290.
time.sleep(1)
ki2290.write("HVON")

# Perform a sweep from 0 to 3000 V and make current measurements
# at each point of the sweep.
for n in range(0,11):
    ki2290.write("VSET " + str(voltage))
    time.sleep(2) # Allow new voltage level to stabilize
    currReading = ki263x.ask("print(smua.measure.i())")
    time.sleep(1) # Allow measurement to be taken
```

```
currRdgList.append(currReading)
voltage = voltage + 300

# Set the voltage of the Model 2290 to 0V and turn off its output.
ki2290.write("VSET 0")
ki2290.write("HVOF")

# Turn off the output of the Model 263xB.
ki263x.write("smua.source.output = smua.OUTPUT_OFF")

# Print the current measurements.
print "Current Measurements: ", currRdgList
```

Performance verification

In this section:

Introduction	8-1
Environmental conditions	8-1
Warm-up period	8-1
Recommended test equipment	8-2
Verification procedures	8-2

Introduction

This section contains procedures to verify that the Model 2290-10 meets or exceeds its stated performance specifications for DC voltage accuracy, DC current accuracy, load regulation, and output voltage ripple. These procedures do not adjust your instrument. If your instrument fails any of the performance verification tests, you should contact Keithley Instruments service.

WARNING

The procedures in this section are intended to be used by qualified service personnel only. Many of these procedures may expose you to hazardous voltages that could result in personal injury or death. Do not perform these procedures unless you are qualified to do so. Use extreme caution when working with hazardous voltages.

Environmental conditions

All verification procedures should be performed at an ambient temperature of 18 °C to 28 °C, and at a relative humidity of 70 % or less, unless otherwise noted.

Warm-up period

The Model 2290-10 should be turned on and allowed to warm up for at least one hour before performing the verification procedures. The test equipment should also be allowed to warm up for the time period recommended by the manufacturer.

Recommended test equipment

The next table summarizes the recommended test equipment for the verification procedures.

Recommended verification test equipment		
Equipment	Specifications	Manufacturer and model
High-voltage divider	0.01% DC accuracy	Ohm-Labs, Inc. (formerly Julie Research) KV-10/.01 or KV-10R
Multimeter	0.002% DC accuracy, 10 G Ω DC input impedance	Keithley Model 2000
990 Ω load resistor	1%, 1 W	Any appropriate resistor manufacturer
1 M Ω load resistor	10 kV, 25 W	

Verification procedures

The verification procedures are explained in detail in the following paragraphs. Refer to the [Recommended test equipment](#) (on page 8-2) table and the respective diagrams for test equipment and connections.

WARNING

The following procedures use high voltage. Use extreme care to avoid electrical shock that could result in personal injury or death. Do not touch any exposed circuitry while the high voltage is enabled.

High-voltage cables can store a charge even when disconnected from the unit. Always turn off the high voltage and make sure all cables and circuitry are completely discharged before connecting or disconnecting cables or other circuitry.

DC voltage accuracy

Use the following steps to measure the accuracy of the DC output voltage.

1. With the power off, connect the Model 2290-10 HIGH VOLTAGE output connector to the high-voltage divider, and connect the multimeter to the 1 V output tap of the divider (see next figure).

⚠ WARNING

Turn off high voltage and allow ample time for the voltage to discharge before changing any connections. Also, make sure that you connect the divider chassis to safety earth ground using #18 AWG or larger wire.

Figure 15: Model 2290-10 Connections for DC voltage accuracy tests

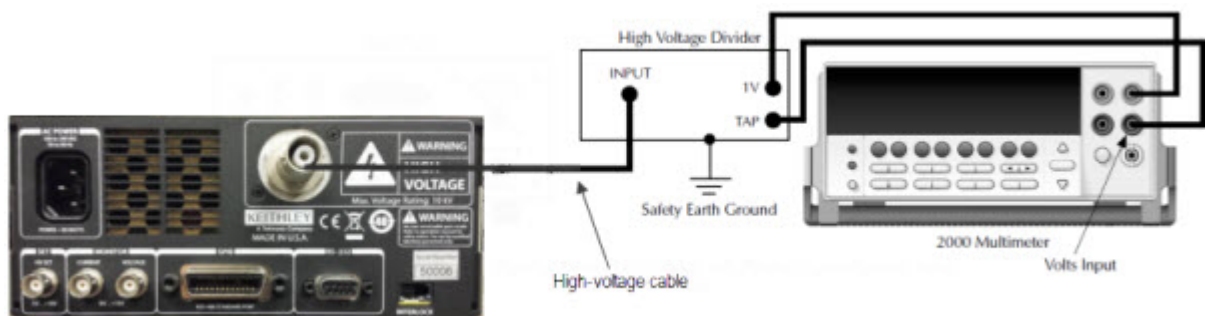

2. Turn on the power, and set the Model 2290-10 to its default conditions (press **RCL, 0**, and then **ENTER**).
3. Select the multimeter DCV function and enable autoranging.
4. With the high voltage turned off, allow the multimeter reading to settle to 0 V, and then enable the REL mode to null any residual offset voltage.
5. Turn on the Model 2290-10 high-voltage output. Set the Model 2290-10 output voltage to each value as indicated in the DC voltage accuracy summary table, and verify that the reading parameters are within stated limits. For each setting:
 - Set the output voltage as indicated in the table.
 - Wait for the output to settle (about one minute).
 - Make sure that the Model 2290-10 VOLTS display reading is within stated limits.
 - Verify that the multimeter reading is within required limits.
6. Turn off the high voltage, and allow the voltage to discharge.

Table: DC voltage accuracy

Output voltage (volts)	Voltage display limits (volts)		Multimeter reading limits (volts)	
500	492	508	494.0	506.0
1000	992	1008	994.0	1006.0
1500	1492	1508	1494.0	1506.0
2000	1992	2008	1994.0	2006.0
2500	2492	2508	2494.0	2506.0
3000	2992	3008	2994.0	3006.0
3500	3492	3508	3494.0	3506.0
4000	3992	4008	3994.0	4006.0
4500	4492	4508	4494.0	4506.0
5000	4992	5008	4994.0	5006.0
6000	5992	6008	5994.0	6006.0
7000	6992	7008	6994.0	7006.0
8000	7992	8008	7994.0	8006.0
9000	8992	9008	8994.0	9006.0
10000	9992	10008	9994.0	10006.0

DC current accuracy

The DC current accuracy test measures the accuracy of the output current limit and the μA (current) display.

1. Using the ohms function of the multimeter, measure and record the value of the 990 Ω resistor.
2. With the power off, connect the 990 Ω resistor, the 10 M Ω load resistor, and the multimeter to the Model 2290-10 HIGH VOLTAGE output connector, as shown in the next figure. Note that the multimeter is connected across the 990 Ω resistor.

WARNING

Turn off high voltage and allow ample time for the voltage to discharge before changing any connections.

For safety purposes, the resistors must be mounted within a safety shield connected to protective earth (safety ground) using #18 AWG or larger wire. Be sure to connect the 990 Ω resistor to the low (chassis side) of the Model 2290-10 output. Otherwise, the multimeter will be floated 5 kV above earth ground, which could result in instrument damage or risk of electric shock.

Figure 16: Model 2290-10 Connections for DC current accuracy tests

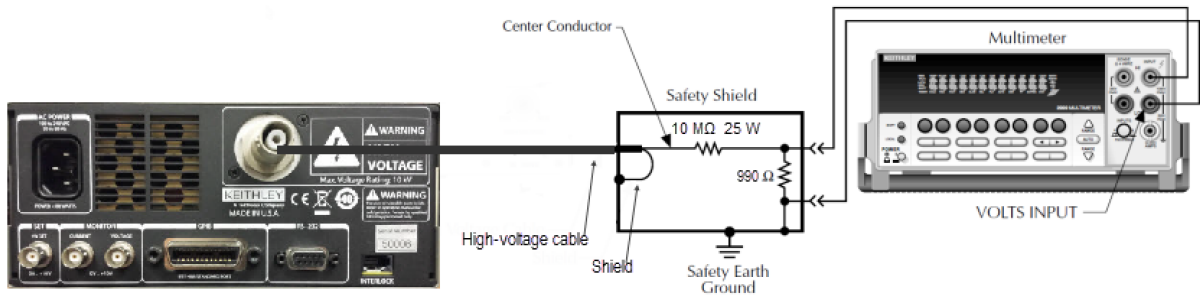

3. Turn on the power, and recall the Model 2290-10 default conditions (press **RCL**, **0**, and then **ENTER**).
4. Select the multimeter DCV function, and enable autoranging.
5. With the high voltage off, allow the multimeter reading to settle and then enable REL to null any residual offset voltage.
6. Set the Model 2290-10 output voltage to 10000 V, and set the current limit to 100 μ A. Turn the high voltage on.
7. Note the DMM reading, and then calculate the current as follows: $I = V/R$, where V is the multimeter voltage reading, and R is the actual value of the 990 Ω resistor measured in step 1.
8. Verify that the current computed in step 7 is within $\pm 5 \mu$ A of the programmed current limit value. Also, make sure that the front panel μ A display reading is within $\pm 2 \mu$ A of the actual current value.
9. Repeat steps 6 through 8 for the remaining currents listed in the next table. For each value:
 - Program the current limit to the correct value.
 - Measure and record the multimeter voltage reading.
 - Compute the current from the voltage and resistance.
 - Verify the computed and display current values are within required limits.
10. Turn off the high voltage, and allow the voltage to discharge.

Table: DC current accuracy summary

Current limit setting	Multimeter voltage ¹	Calculated current ²	Allowable current range ³	
			Lower limit	Upper limit
100 μ A	V	μ A	95	105
200 μ A	V	μ A	195	205
300 μ A	V	μ A	295	305
400 μ A	V	μ A	395	405
500 μ A	V	μ A	495	505
600 μ A	V	μ A	595	605
700 μ A	V	μ A	695	705
800 μ A	V	μ A	795	805
900 μ A	V	μ A	895	905
1000 μ A	V	μ A	995	1005
¹ Voltage across 990 Ω resistor measured by multimeter.				
² Calculated as follows: $I = V/R$, where V= multimeter voltage reading and R= measured resistor value.				
³ Limits calculated as follows: $I \pm 5 \mu$ A, where I = calculated current.				

Troubleshooting

In this section:

Stuck buttons	9-1
Line power.....	9-1
Repeated trips.....	9-1
Incorrect rear-panel output voltage	9-1
Front-panel test.....	9-2
Power-on reset.....	9-2
No high voltage	9-2
Service	9-2

Stuck buttons

If the center display is filled with a number (such as 4444) or one particular message (such as Err2), and the front-panel buttons are unresponsive, check to see if a button is stuck. If so, gently tap the stuck button back to the center of its hole to free it.

Line power

Verify that the line cord is plugged completely into the power entry module and that the front-panel power switch is on.

Repeated trips

Voltage trips: This problem may occur if the load changes too rapidly, causing the voltage to overshoot. Try raising the voltage limit.

Current trips: Disconnect the load, and note if the unit still trips. If the unit operates with no load, the load may be causing the problem. If the unit still trips with the load disconnected, the unit may be damaged. Contact the factory for further information.

Incorrect rear-panel output voltage

If the output voltage is not correct, check the REAR LED and rear panel VOLTAGE switch to verify the unit is in the SET mode. Also, check that the voltage limit is higher than the set voltage.

Front-panel test

This test verifies that all segment drivers are functional. Hold down the **ENTER** button while turning on the unit to run the front panel test. After power is turned on, one segment of one numerical digit should be on. Press the up arrow button to step through all eight digit segments of the present digit and the following digit. When the up arrow button is pressed again, all segments and one of the single LEDs should be on. Repeatedly press the up arrow button to cycle through all single LEDs.

The buttons can then be tested by pressing each button and observing the button code on the display. The codes increase from top to bottom and left to right. After this test, turn the power off and then back on to restart the instrument.

Power-on reset

If the instrument turns on with unusual combinations of LEDs on, garbled displays, or is unresponsive to the front-panel buttons, the memory contents may have been corrupted, causing the instrument to lock up. To remedy the situation, turn the unit off and hold down the **CLR** button while turning the power back on. Doing so causes the unit to initialize the memory and load the default setup.

No high voltage

If the Model 2290-10 does not enable the high voltage, check to make sure that the HIGH VOLTAGE LED is on. If the HIGH VOLTAGE LED is OFF, check the following:

1. Make certain that you hold down the high voltage button for at least one-half second. This button requires a fairly long button press to avoid turning on the high voltage accidentally.
2. Check the voltage limit and current trip levels to verify that they are sufficiently high for the expected output values.

If the HIGH VOLTAGE LED is ON, but the output voltage is zero or lower than expected, check the following:

1. The LIMIT LED is on. If so, the current limit value could be too low, or the load could be drawing excessive current.
2. The voltage limit is as large as or larger than the set output voltage.
3. The REAR LED is on. If so, the high voltage is being programmed by the analog voltage applied to the SET/MON input on the rear panel and not by the front panel. Make sure that the rear panel VOLTAGE switch is in the correct position.
4. The interlock is not asserted.

Service

For repair and instrument adjustment services, contact your local Keithley Instruments representative. For worldwide contact numbers, visit the Keithley Instruments website (<http://www.keithley.com> (<http://www.tek.com/keithley>)).

Index

*

*CLS • 4-7
*ESE(?) <n> • 4-7
*ESR? [<n>] • 4-7
*IDN? • 4-7
*OPC? • 4-6
*PSC(?) <n> • 4-8
*RCL <n> • 4-5
*RST • 4-6
*SAV <n> • 4-5
*SRE(?) <n> • 4-8
*STB? [<n>] • 4-8
*WAI • 4-7

A

Analog programming and monitor • 3-4

B

Basic operation • 3-1
Bus connections • 4-3

C

CD-ROM contents • 1-1
Command buffer • 4-3
Command examples • 4-3
Command queries • 4-3
Command syntax • 4-3
Connect GPIB cables to your instrument • 4-1
Connect to other instruments • 1-6
Connecting cables and connectors • 1-3
Connecting the interlock of the Model 2290-10 • 2-3
Connecting the Model 2290-10 output to a custom text fixture • 2-4
contact information • 1-1
Contact information • 1-1

D

DC current accuracy • 8-4
DC voltage accuracy • 8-3

E

Environmental conditions • 8-1
Error and status messages • 1-4, 6-1
Error messages • 6-1
Example program code • 7-3, 7-7

Extended warranty • 1-1

F

Features • 1-2
Front-panel familiarization • 1-4, 3-2
Front-panel test • 9-2

G

Getting started • 1-1

H

High voltage safety precautions • 2-1
HVOF • 4-4
HVON • 4-4

I

ILIM(?) <n> • 4-5
Incorrect rear-panel output voltage • 9-1
Inspect for damage • 1-2
Interface control commands • 4-6
Interlock circuit • 2-2
Introduction • 2-1, 4-1, 7-1, 8-1
IOUT? • 4-4
ITRP(?) <n> • 4-5

L

LERR? • 4-6, 6-2
Line cord • 1-5
Line power • 9-1
Line voltage selection • 2-2

M

Multiple commands • 4-3

N

No high voltage • 9-2
Numeric and cursor keys • 3-1

O

Optional accessories • 1-3, 1-6
Organization of manual • 1-2
Output control commands • 4-4

P

Performance verification • 8-1

Power-on reset • 9-2
Program example 1 • 7-1
Program example 2 • 7-4
Protection module • 1-3

R

Rack mount kits • 1-3
Rear-panel familiarization • 1-5
Recommended test equipment • 8-2
Remote commands • 4-4
Remote operation • 4-1
Repeated trips • 9-1
RS-232 cable • 4-1

S

Safe configuration and test setup • 2-1
Safely connect to instruments • 2-2
Select, Enter, Clear • 3-1
Service • 9-2
Set current limit • 3-3
Set current trip • 3-3
Set output voltage • 3-2
Set the GPIB address • 4-3
Set voltage limit • 3-2
Setting control commands • 4-5
Shipment contents • 1-3
SMOD? • 4-5
Standard event status register • 5-2
Status byte register • 5-2
Status messages • 5-1
Status reporting • 5-1
Status reporting commands • 4-7
Store and recall • 3-3
Stuck buttons • 9-1

T

Table

DC current accuracy summary • 8-5
DC voltage accuracy • 8-4
Error messages • 6-1
Programmatic errors • 4-6, 6-2
Standard event status register • 5-3
Status byte • 5-2
Summarizes status messages • 6-2
TCLR • 4-5
TMOD(?) <n> • 4-5
Troubleshooting • 9-1
Typical applications • 7-1

U

Unpacking and inspecting • 1-2

V

Verification procedures • 8-2

VLIM(?) <n> • 4-6
VOUT? • 4-4
VSET(?) <n> • 3-2, 4-6

W

Warm-up period • 8-1
Welcome • 1-1

Specifications are subject to change without notice.
All Keithley trademarks and trade names are the property of Keithley Instruments.
All other trademarks and trade names are the property of their respective companies.

Keithley Instruments
Corporate Headquarters • 28775 Aurora Road • Cleveland, Ohio 44139 • 440-248-0400 • Fax: 440-248-6168 • 1-800-935-5595 • www.tek.com/keithley



A Greater Measure of Confidence