

Models 2380-500 and 2380-120 Programmable DC Electronic Load Quick Start Guide



Safety precautions

The following safety precautions should be observed before using this product and any associated instrumentation. Although some instruments and accessories would normally be used with nonhazardous voltages, there are situations where hazardous conditions may be present.

This product is intended for use by personnel who recognize shock hazards and are familiar with the safety precautions required to avoid possible injury. Read and follow all installation, operation, and maintenance information carefully before using the product. Refer to the user documentation for complete product specifications.

If the product is used in a manner not specified, the protection provided by the product warranty may be impaired.

The types of product users are:

Responsible body is the individual or group responsible for the use and maintenance of equipment, for ensuring that the equipment is operated within its specifications and operating limits, and for ensuring that operators are adequately trained.

Operators use the product for its intended function. They must be trained in electrical safety procedures and proper use of the instrument. They must be protected from electric shock and contact with hazardous live circuits.

Maintenance personnel perform routine procedures on the product to keep it operating properly, for example, setting the line voltage or replacing consumable materials. Maintenance procedures are described in the user documentation. The procedures explicitly state if the operator may perform them. Otherwise, they should be performed only by service personnel.

Service personnel are trained to work on live circuits, perform safe installations, and repair products. Only properly trained service personnel may perform installation and service procedures.

Keithley products are designed for use with electrical signals that are measurement, control, and data I/O connections, with low transient overvoltages, and must not be directly connected to mains voltage or to voltage sources with high transient overvoltages. Measurement Category II (as referenced in IEC 60664) connections require protection for high transient

overvoltages often associated with local AC mains connections. Certain Keithley measuring instruments may be connected to mains. These instruments will be marked as category II or higher.

Unless explicitly allowed in the specifications, operating manual, and instrument labels, do not connect any instrument to mains.

Exercise extreme caution when a shock hazard is present. Lethal voltage may be present on cable connector jacks or test fixtures. The American National Standards Institute (ANSI) states that a shock hazard exists when voltage levels greater than 30 V RMS, 42.4 V peak, or 60 VDC are present. A good safety practice is to expect that hazardous voltage is present in any unknown circuit before measuring.

Operators of this product must be protected from electric shock at all times. The responsible body must ensure that operators are prevented access and/or insulated from every connection point. In some cases, connections must be exposed to potential human contact. Product operators in these circumstances must be trained to protect themselves from the risk of electric shock. If the circuit is capable of operating at or above 1000 V, no conductive part of the circuit may be exposed.

Do not connect switching cards directly to unlimited power circuits. They are intended to be used with impedance-limited sources. NEVER connect switching cards directly to AC mains. When connecting sources to switching cards, install protective devices to limit fault current and voltage to the card.

Before operating an instrument, ensure that the line cord is connected to a properly-grounded power receptacle. Inspect the connecting cables, test leads, and jumpers for possible wear, cracks, or breaks before each use.

When installing equipment where access to the main power cord is restricted, such as rack mounting, a separate main input power disconnect device must be provided in close proximity to the equipment and within easy reach of the operator.

For maximum safety, do not touch the product, test cables, or any other instruments while power is applied to the circuit under test. ALWAYS remove power from the entire test system and discharge any capacitors before: connecting or disconnecting cables or jumpers, installing or removing switching cards, or making internal changes, such as installing or removing jumpers.

Do not touch any object that could provide a current path to the common side of the circuit under test or power line (earth) ground. Always make measurements with dry hands while standing on a dry, insulated surface capable of withstanding the voltage being measured.

For safety, instruments and accessories must be used in accordance with the operating instructions. If the instruments or accessories are used in a manner not specified in the operating instructions, the protection provided by the equipment may be impaired.

Do not exceed the maximum signal levels of the instruments and accessories. Maximum signal levels are defined in the specifications and operating information and shown on the instrument panels, test fixture panels, and switching cards.

When fuses are used in a product, replace with the same type and rating for continued protection against fire hazard.

Chassis connections must only be used as shield connections for measuring circuits, NOT as protective earth (safety ground) connections.

If you are using a test fixture, keep the lid closed while power is applied to the device under test. Safe operation requires the use of a lid interlock.

If a  screw is present, connect it to protective earth (safety ground) using the wire recommended in the user documentation.

The  symbol on an instrument means caution, risk of hazard. The user must refer to the operating instructions located in the user documentation in all cases where the symbol is marked on the instrument.

The  symbol on an instrument means warning, risk of electric shock. Use standard safety precautions to avoid personal contact with these voltages.

The  symbol on an instrument shows that the surface may be hot. Avoid personal contact to prevent burns.

The  symbol indicates a connection terminal to the equipment frame.

If this  symbol is on a product, it indicates that mercury is present in the display lamp. Please note that the lamp must be properly disposed of according to federal, state, and local laws.

The **WARNING** heading in the user documentation explains hazards that might result in personal injury or death. Always read the associated information very carefully before performing the indicated procedure.

The **CAUTION** heading in the user documentation explains hazards that could damage the instrument. Such damage may invalidate the warranty.

The **CAUTION** heading with the  symbol in the user documentation explains hazards that could result in moderate or minor injury or damage the instrument. Always read the associated information very carefully before performing the indicated procedure. Damage to the instrument may invalidate the warranty.

Instrumentation and accessories shall not be connected to humans.

Before performing any maintenance, disconnect the line cord and all test cables.

To maintain protection from electric shock and fire, replacement components in mains circuits — including the power transformer, test leads, and input jacks — must be purchased from Keithley. Standard fuses with applicable national safety approvals may be used if the rating and type are the same. The detachable mains power cord provided with the instrument may only be replaced with a similarly rated power cord. Other components that are not safety-related may be purchased from other suppliers as long as they are equivalent to the original component (note that selected parts should be purchased only through Keithley to maintain accuracy and functionality of the product). If you are unsure about the applicability of a replacement component, call a Keithley office for information.

Unless otherwise noted in product-specific literature, Keithley instruments are designed to operate indoors only, in the following environment: Altitude at or below 2,000 m (6,562 ft); temperature 0 °C to 50 °C (32 °F to 122 °F); and pollution degree 1 or 2.

To clean an instrument, use a cloth dampened with deionized water or mild, water-based cleaner. Clean the exterior of the instrument only. Do not apply cleaner directly to the instrument or allow liquids to enter or spill on the instrument. Products that consist of a circuit board with no case or chassis (e.g., a data acquisition board for installation into a computer) should never require cleaning if handled according to instructions. If the board becomes contaminated and operation is affected, the board should be returned to the factory for proper cleaning/servicing. Safety precaution revision as of June 2017.

Safety

Introduction

Unpack

Connect

Test

Next steps

Power and environmental specifications

For indoor use only.

Power supply	100/220 V, 115/230 V, 50 Hz or 60 Hz
Operating altitude	Maximum 2000 m (6562 ft) above sea level
Operating temperature	0 °C to 40 °C, full accuracy to 80% relative humidity at up to 35 °C, non-condensing
Storage temperature	-20 °C to 70 °C , 10% to 85% relative humidity at up to 40 °C and 5% to 60% relative humidity above 40 °C up to 70 °C
Pollution degree	2

CAUTION

Carefully consider and configure the appropriate output-off state, source levels, and compliance levels before connecting the instrument to a device that can deliver energy. Failure to consider the output-off state, source levels, and compliance levels may result in damage to the instrument or to the device under test.

Introduction

The Keithley Models 2380-500-15, 2380J-500-15, 2380-120-60, and 2380J-120-60 programmable high-precision DC electronic load instruments support constant current (CC), constant voltage (CV), constant resistance (CR), constant power (CP), and transient operating modes.

The 2380-500-15 has an input power of 200 W and the 2380-120-60 has an input power of 250 W. The most sensitive measurement resolution for the two loads are 0.1 mV and 0.01 mA. The instruments have adjustable current rise and fall times that range from 0.0001 A/ μ s to 2.5 A/ μ s. The load current switching speed reaches up to 50 kHz. The load can be controlled externally from 0 V through 10 V using analog interfaces. It is equipped with built-in RS-232, USB, and GPIB ports. The load provides a special LED mode to conduct a LED power supply test by simulating an LED current load. The 2380 load also has a Battery Test mode to discharge a battery and measure the Amp-Hour capacity of the battery.

Complete documentation for the 2380 loads are available for download on the Keithley web page at tek.com/keithley.

Safety

Introduction

Unpack

Connect

Test

Next steps

Unpack and inspect the instrument

To unpack and inspect the instrument:

1. Inspect the box for damage.
2. Open the top of the box.
3. Remove the documentation and accessories.
4. Remove the packaging inserts.
5. Carefully lift the instrument out of the box.

CAUTION

Do not lift the programmable DC electronic load from the front bezel. Lifting the instrument by the terminal blocks of front bezel can cause instrument damage.

6. Inspect the instrument for any obvious signs of physical damage. Report any damage to the shipping agent immediately.

You received one of the following instruments:

- 2380-500-15
- 2380J-500-15
- 2380-120-60
- 2380J-120-60

Instruments includes the following accessories and documentation:

- Power line cord (part number CO-XX/161-XXXX-XX)
- Calibration Certificate (0011655XX)
- USB cable (1746841XX)
- Environmental Disclosure Statement (Instrument/System) (PA-935)

Refer to the packing list that came with the shipment for additional items that shipped with your instrument.

Front panel overview

The front panel of the instrument is shown in the following figure.

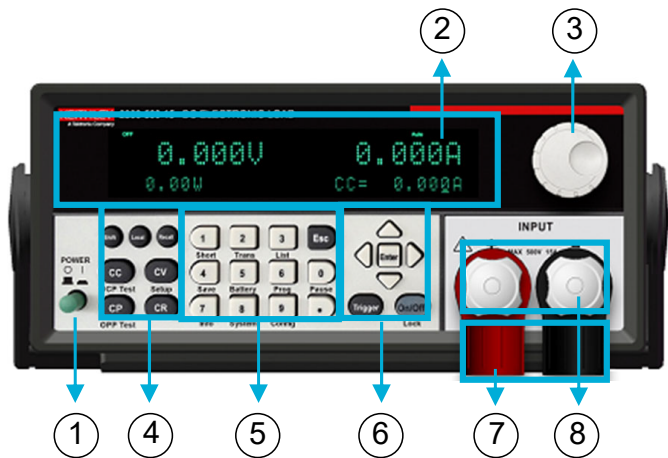

The items in the figure are:

- 1 Power on/off switch
- 2 Display
- 3 Navigation control
- 4 Function keys
- 5 Numeric keypad, Esc key, and combination buttons
- 6 Navigation arrow keys, Enter, Trigger, and On/Off button
- 7 Protective covers
- 8 Input terminals

The front-panel keypad, including function keys, numeric keypad, combination buttons, and the Esc key, is shown in the next figure.

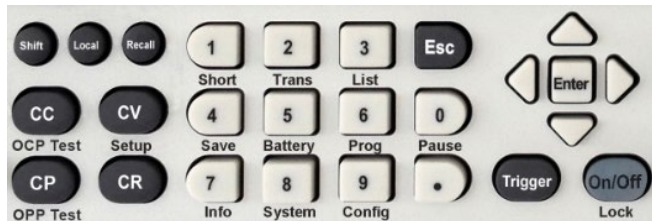

Safety

Introduction









Unpack

Connect

Test

Next steps

Button descriptions



- : Enables access to secondary functions
- : Sets the instrument to local mode
- : Recalls stored instrument settings
- : Sets the load to CC mode and configures the current value
- : Sets the load to CV mode and configures the voltage value
- : Sets the load to CR mode and configures the resistance value
- : Sets the load to CP mode and configures the power value
- : Sets the load to trigger mode for list and transient function
- : Turns the instrument on or off

: Confirms settings

: Up arrow key

: Down arrow key

: Left and right arrow keys

 — : Enters numeric values for various parameters

: Decimal point

: Cancels the present action and returns to the previous menu

Rear panel overview

The rear-panel interface is shown in the next figure. Descriptions of the options are provided in the following table.

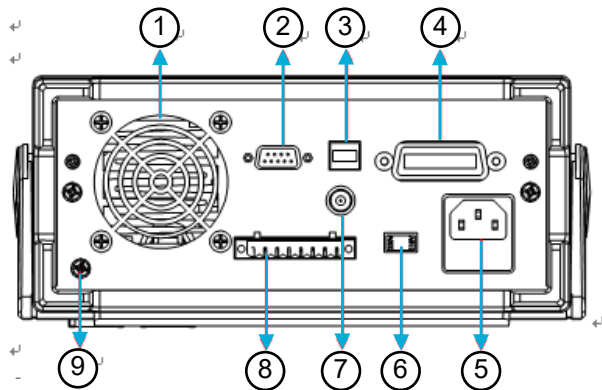

No.	Description
1	Cooling fan
2	RS-232 interface
3	USB interface
4	GPIB interface
5	AC socket (fuse inside)
6	Line voltage selector
7	I-monitor interface
8	Remote sense terminals, external trigger, and programming input terminals
9	Protective ground terminal

Safety

Introduction

Unpack

Connect

Test

Next steps

Connect the instrument

Important test system safety information

This product is sold as a stand-alone instrument that may become part of a system that could contain hazardous voltages and energy sources. It is the responsibility of the test system designer, integrator, installer, maintenance personnel, and service personnel to make sure the system is safe during use and is operating properly.

It is important that you consider the following factors in your system design and use:

- The international safety standard IEC 61010-1 defines voltages as hazardous if they exceed $30 V_{RMS}$ and $42.4 V_{PEAK}$, or 60 VDC for equipment rated for dry locations. Keithley Instruments products are only rated for dry locations.
- Read and comply with the specifications of all instruments in the system. The overall allowed signal levels may be constrained by the lowest rated instrument in the system. For example, if you are using a 500 V power supply with a 300 VDC rated switch, the maximum allowed voltage in the system is 300 VDC.
- Make sure any test fixture connected to the system protects the operator from contact with hazardous voltages, hot surfaces, and sharp objects. Use shields, barriers, insulation, and safety interlocks to accomplish this.

- Cover the device under test (DUT) to protect the operator from flying debris in the event of a system or DUT failure.
- Double-insulate all electrical connections that an operator can touch. Double insulation ensures the operator is still protected even if one insulation layer fails. Refer to IEC 61010-1 for specific requirements.
- Make sure all connections are behind a locked cabinet door or other barrier. This protects the system operator from accidentally removing a connection by hand and exposing hazardous voltages. Use high-reliability fail-safe interlock switches to disconnect power sources when a test fixture cover is opened.
- Where possible, use automatic handlers so that operators are not required to access the DUT or other potentially hazardous areas.
- Provide training to all users of the system so that they understand all potential hazards and know how to protect themselves from injury.

NOTE

To keep users safe, always read and follow all safety warnings provided with each of the instruments in your system.

Install the instrument

You can use a Model 2380-500-15, 2380J-500-15, 2380-120-60, or 2380J-120-60 instrument on a bench or in a rack. See the instructions that came with your rack-mount kit if you are installing the programmable DC electronic load in a rack.

To prevent damaging heat build-up and ensure specified performance, make sure there is adequate ventilation and air flow around the instrument to ensure proper cooling. Do not cover the ventilation holes on the top, sides, or bottom of the instrument.

Make sure the instrument is positioned so that it is easy to reach any disconnecting devices, such as the power cord and the power switch.

CAUTION

Operating the instrument on an incorrect line voltage may cause damage to the instrument, possibly voiding the warranty.

Connect line power

The instruments operate at 100 V, 115 V, 220 V, or 230 V with a frequency of 50 Hz or 60 Hz. Make sure that the AC line voltage indicator in the center of the rear-panel power module matches the AC line voltage in your facility, as shown in the following figure.

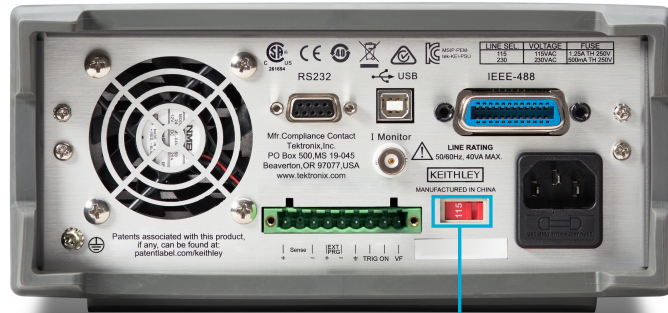

AC line voltage indicator

Safety

Introduction

Unpack

Connect

Test

Next steps

Connect line power

WARNING

The power cord supplied with the Model 2380-500-15, 2380J-500-15, 2380-120-60, or 2380J-120-60 instrument contains a separate protective earth (safety ground) wire for use with grounded outlets. When proper connections are made, the instrument chassis is connected to power-line ground through the ground wire in the power cord. In addition, a redundant protective earth connection is provided through a screw on the rear panel. This terminal should be connected to a known protective earth. In the event of a failure, not using a properly grounded protective earth and grounded outlet may result in personal injury or death due to electric shock.

Do not replace detachable MAINS supply cords with inadequately rated cords. Failure to use properly rated cords may result in personal injury or death due to electric shock.

To connect line power:

1. Make sure the front-panel power switch is in the off (0) position.
2. On the rear panel, select the correct voltage level (230 V, 115 V, or 100 V).
3. Connect the socket of the supplied power cord to the power connection on the rear panel.
4. Connect the plug of the power cord to a grounded AC outlet.

Turn on the instrument

Turn on the instrument by pressing the front-panel POWER switch so that it is in the on (I) position.

Test the instrument

Connections for testing

Wires for connection to the front-panel input terminals and sense terminals must be 20 AWG to 12 AWG.

CAUTION

The wire must be heavy enough not to overheat while carrying the short-circuit input current of the unit. Make sure to meet the wiring requirements described above.

Two-wire connections

Two-wire connections are used for basic operations when maximum precision is not required. Keep the wire as short as possible to reduce wire resistance. If you want higher measurement precision, use four-wire remote sense connections.

To connect the DUT to the load using a two-wire connection:

1. Unscrew the two nuts and remove the two protective covers, as shown in the following figure.

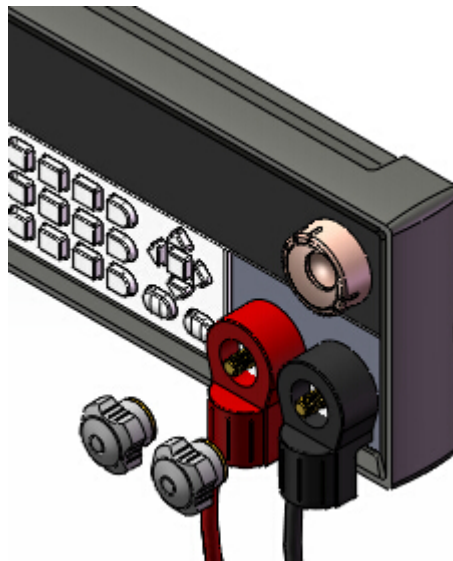

Safety

Introduction

Unpack

Connect

Test

Next steps

2. Connect the cables to the two input terminals, as shown in the following figure.

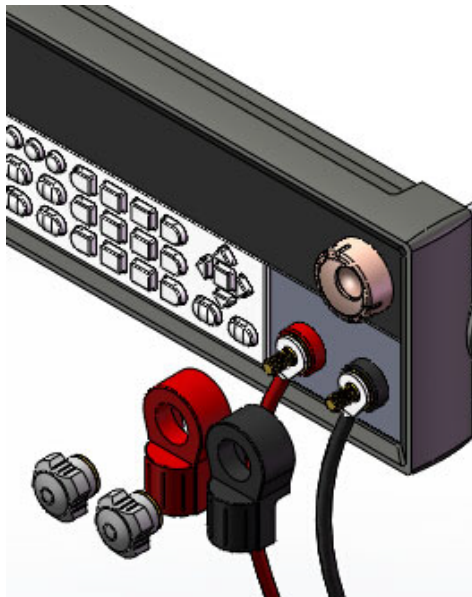

3. Mount the protective covers to the two input terminals.

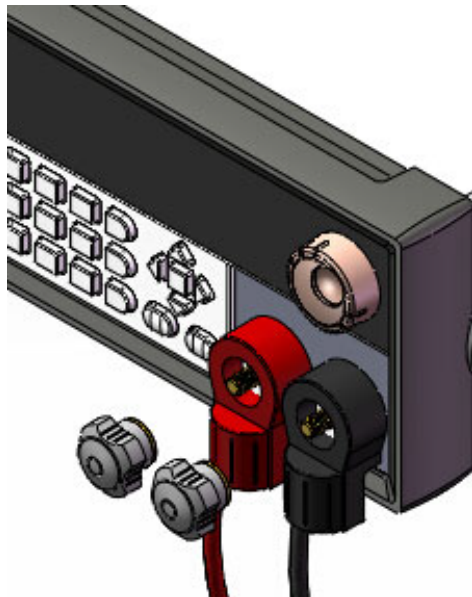

4. Screw the two input terminals tight, as shown in the following figure.

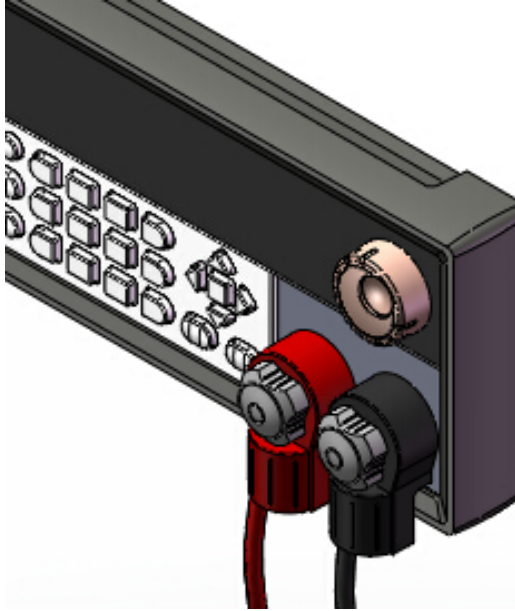

5. Connect the other end of the cables to the DUT. The red cable is connected to the positive electrode and the black cable is connected to the negative electrode.

⚠ WARNING

Failure to install the protective cover may result in personal injury or death due to electric shock.

Four-wire remote sense connections

For higher measurement precision, you can use four-wire remote sense connections.

To connect the DUT to the load using four-wire remote sense connections:

1. Unscrew the two nuts and remove the two protective covers.
2. Connect the cables to the two input terminals.
3. Mount the protective covers to the two input terminals.
4. Screw the two input terminals tight.
5. Connect the other end of the cables to the DUT. The red cable is connected to the positive electrode and the black cable is connected to the negative electrode.

Safety

Introduction

Unpack

Connect

Test

Next steps

6. Connect the DUT to the remote sense terminals on the rear panels, as shown in the next wiring diagram.

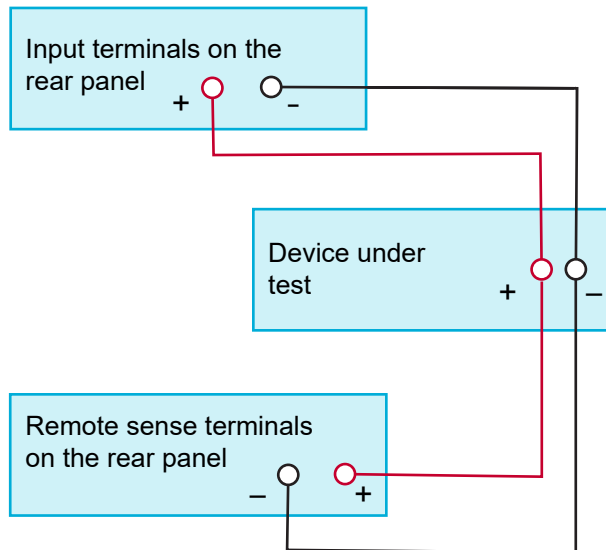

NOTE

Steps 1 to 5 are the same as the steps for two-wire connections. For illustrations, see “Two-wire connections” on page 13.

Front-panel user interface overview

The front-panel user interface gives you quick access to measurement settings, system configuration, instrument status, and other instrument functionality.

Home screen overview

When you turn on the instrument, you see the home screen, shown in the following figure.

0.000V	0.000A
0.00W	CC=0.000A

The top row on the home screen displays the actual input voltage and current values.

The second row on the home screen displays the actual power value and the present (voltage, power, resistance) setting values.

Menu screen overview

Press **Shift** + **8** on the front panel to display the **SYSTEM MENU** screen.

The following options are displayed: Initialize, Power-ON, Buzzer, Knob, Trigger, Display, Communication, and Protocol.

To select an option, use the left-right arrow keys or use the knob to select an option. Press **Enter** and configure the parameters.

Press **Shift** + **9** on the front panel to show the **CONFIG MENU**.

The following options are displayed: Von, Protect, Measure, CR-LED, Remote-Sense, and Ext-Program.

To select an option, use the left-right arrow keys or use the knob to select an option. Press **Enter** and configure the parameters.

The programmable DC electronic load allows you to perform the following measure functions:

- Short function: Simulate a short circuit with an input.
- Transient mode: Conduct a dynamic response time test for a power supply.
- OCP Function: Conduct an automatic test for OCP conditions.
- OPP Function: Conduct an automatic test for OPP conditions.
- Battery mode: Conduct a battery capacity test by sinking a fixed current load.
- CR-LED mode: Conduct an output current test for an LED power supply.
- Measure mode: Conduct a rising/falling time test for a power supply or a fuse melting time test.
- Autotest function: Conduct an automatic test with various modes.

Safety

Introduction

Unpack

Connect

Test

Next steps

Front-panel key combinations for measurement functions are:

- Shift + 1 **Short:** Enable/Disable short function.
- Shift + 2 **Tran:** Configure transient parameters.
- Shift + 3 **List:** Configure list parameters.
- Shift + 5 **Battery:** Configure battery test parameters.
- Shift + 6 **Program:** Configure autotest parameters.
- Shift + CC **OCP Test:** Configure OCP parameters.
- Shift + CV **Setup:** Configure maximum voltage/current range for each function.
- Shift + CP **OPP:** Configure OPP parameters.

Specify a measurement range

You can set value ranges for measurements or allow the instrument to choose the ranges automatically.

The measurement range determines the input during the measurement, and also affects the precision of the measurements and the maximum signal that can be measured.

You can specify the current range and voltage range for the programmable DC electronic load.

To set the range for CC, CV, CR, or CP from the front panel:

1. Press the **CC**, **CV**, **CR**, or **CP** key.
2. Press Shift + CV.
3. Set the range of each parameter. Values are shown in the following table.
4. Press Enter.

Model number	Current measurement ranges	Voltage measurement ranges
2380-500-15 2380J-500-15	Low range: 0 A to 3 A High range: 0 A to 15 A	Low range: 0 V to 50 V High range: 0 V to 500 V
2380-120-60 2380J-120-60	Low range: 0 A to 6 A High range: 0 A to 60 A	Low range: 0 V to 18 V High range: 0 V to 120 V

See the “Constant-status operation mode” section of the *Models 2380-500 and 2380-120 Programmable DC Electronic Load Instruments User’s Manual* (part number 2380-120-60-900-01) for additional details and configuration of specific parameters.



Configure and execute a 2-step linear list sweep

The following example demonstrates how to set the electronic load to input a linear list sweep from 1 A to 2 A. The values demonstrated in the example are default settings. Each step in the list sweep remains for five seconds. The list is stored in list location 1. The input turns on at 0 A and remains at 2 A at the end of list execution.

To configure and execute a list sweep using the front panel:

1. Press  + . The following is displayed.

LIST
On Recall Edit

2. Press  . Select **Edit**.
3. Press to confirm. The following is displayed.

EDIT LIST
High-Rate Low-Rate

4. Press  . Select **High-Rate**. Press to confirm.

The following is displayed.

EDIT LIST
Current Range=0.000A

Safety

Introduction

Unpack

Connect

Test

Next steps

5. Enter the value for the low current range. Press ENTER. The following text is displayed.

EDIT LIST
File Step=2 (2-84)

6. Edit the step count. For example, press to set two steps, and then press to confirm. The following text is displayed.

EDIT LIST
Step 001 Level=1A

7. Edit the current value for step 1. Press to confirm. The following text is displayed.

EDIT LIST
Step 001 Rate=0.1A/uS

8. Edit the current slope for step 1. Press to confirm. The following text is displayed.

EDIT LIST
Step 001 Width=5S

9. Edit the width time for step 1. Press to confirm. The following text is displayed.

EDIT LIST
Step 002 Level=2A

10. Edit the current value for step 2. Press to confirm. The following text is displayed.

EDIT LIST
Step 002 Rate=0.1A/uS

11. Edit the current slope for step 2. Press  to confirm. The following text is displayed.

EDIT LIST

Step 002 Width=5S

12. Edit the width time for step 2. Press  to confirm. The following text is displayed.

EDIT LIST

Repeat Count=1

13. Edit the list repeat times. Press  to confirm. The following text is displayed.

EDIT LIST



Save List File=1 (1-7)

14. Save the list file by selecting a storage location. Press  to confirm.

15. Press . Select **On**. Press  to confirm. The Trig indicator turns on.

LIST

On Recall Edit

16. Press  to turn on the load input.
17. Press  to generate a trigger signal and to start the execution of the list.
18. To quit list operations, press **CC**, **CV**, **CR**, or **CP**.

Safety

Introduction

Unpack

Connect

Test

Next steps

To execute a list sweep using a stored list:

1. Press  + .

LIST
On Recall Edit

2. Press   to move to **Recall**. Press  to confirm.

The following is displayed.

Recall List File=1

3. Select the pre-saved list file. Press  to confirm. The following is displayed.

LIST
On Recall Edit

4. Press . Select **Off**. Press  to turn it on. The Trig indicator light turns on.

5. Press  to turn on the input.

6. Press  to run the list.

Next steps

Refer to the *Models 2380-500 and 2380-120 Programmable DC Electronic Load Instruments User's Manual* (part number 2380-120-60-900-01) for detailed information about all features of the instrument.

Also see [tek.com/keithley](https://www.tek.com/keithley) for support and additional information about the instrument.

Safety

Introduction

Unpack

Connect

Test

Next steps

Contact information:

Australia* 1 800 709 465

Austria 00800 2255 4835

**Balkans, Israel, South Africa, and other
ISE countries** +41 52 675 3777

Belgium* 00800 2255 4835

Brazil +55 (11) 3759 7627

Canada 1 800 833 9200

Central East Europe / Baltics
+41 52 675 3777

Central Europe / Greece +41 52 675 3777

Denmark +45 80 88 1401

Finland +41 52 675 3777

France* 00800 2255 4835

Germany* 00800 2255 4835

Hong Kong 400 820 5835

India 000 800 650 1835

Indonesia 007 803 601 5249

Italy 00800 2255 4835

Japan 81 (3) 6714 3010

Luxembourg +41 52 675 3777

Malaysia 1 800 22 55835

**Mexico, Central/South America, and
Caribbean** 52 (55) 56 04 50 90

Middle East, Asia, and North Africa
+41 52 675 3777

The Netherlands* 00800 2255 4835

New Zealand 0800 800 238

Norway 800 16098

People's Republic of China 400 820 5835

Philippines 1 800 1601 0077

Poland +41 52 675 3777

Portugal 80 08 12370

Republic of Korea +82 2 565 1455

Russia / CIS +7 (495) 6647564

Singapore 800 6011 473

South Africa +41 52 675 3777

Spain* 00800 2255 4835

Sweden* 00800 2255 4835

Switzerland* 00800 2255 4835

Taiwan 886 (2) 2656 6688

Thailand 1 800 011 931

United Kingdom / Ireland* 00800 2255 4835

USA 1 800 833 9200

Vietnam 12060128

* European toll-free number. If not
accessible, call: +41 52 675 3777

Find more valuable resources at TEK.COM
Copyright © 2019, Tektronix. All rights reserved.
Tektronix products are covered by U.S. and
foreign patents, issued and pending. Information
in this publication supersedes that in all previously
published material. Specification and price change
privileges reserved. TEKTRONIX and TEK are
registered trademarks of Tektronix, Inc. All other
trade names referenced are the service marks,
trademarks, or registered trademarks of their
respective companies.



2380-120-60-903-01 Rev. B / March 2019

