

# Model 2002 Multimeter

## Getting Started Manual

2002-903-01 Rev. A / May 1994

---

# Model 2002 Multimeter Getting Started Manual

©1994, Keithley Instruments, Inc.  
All rights reserved.  
Cleveland, Ohio, U.S.A.  
First Printing May 1994  
Document Number: 2002-903-01 Rev. A

---

## Manual Print History

The print history shown below lists the printing dates of all Revisions and Addenda created for this manual. The Revision Level letter increases alphabetically as the manual undergoes subsequent updates. Addenda, which are released between Revisions, contain important change information that the user should incorporate immediately into the manual. Addenda are numbered sequentially. When a new Revision is created, all Addenda associated with the previous Revision of the manual are incorporated into the new Revision of the manual. Each new Revision includes a revised copy of this print history page.

Revision A (Document Number 2002-903-01) ..... May 1994

The following safety precautions should be observed before using this product and any associated instrumentation. Although some instruments and accessories would normally be used with non-hazardous voltages, there are situations where hazardous conditions may be present.

This product is intended for use by qualified personnel who recognize shock hazards and are familiar with the safety precautions required to avoid possible injury. Read and follow all installation, operation, and maintenance information carefully before using the product. Refer to the user documentation for complete product specifications.

If the product is used in a manner not specified, the protection provided by the product warranty may be impaired.

The types of product users are:

**Responsible body** is the individual or group responsible for the use and maintenance of equipment, for ensuring that the equipment is operated within its specifications and operating limits, and for ensuring that operators are adequately trained.

**Operators** use the product for its intended function. They must be trained in electrical safety procedures and proper use of the instrument. They must be protected from electric shock and contact with hazardous live circuits.

**Maintenance personnel** perform routine procedures on the product to keep it operating properly, for example, setting the line voltage or replacing consumable materials. Maintenance procedures are described in the user documentation. The procedures explicitly state if the operator may perform them. Otherwise, they should be performed only by service personnel.

**Service personnel** are trained to work on live circuits, perform safe installations, and repair products. Only properly trained service personnel may perform installation and service procedures.

Keithley Instruments products are designed for use with electrical signals that are rated Measurement Category I and Measurement Category II, as described in the International Electrotechnical Commission (IEC) Standard IEC 60664. Most measurement, control, and data I/O signals are Measurement Category I and must not be directly connected to mains voltage or to voltage sources with high transient over-voltages. Measurement Category II connections require protection for high transient over-voltages often associated with local AC mains connections. Assume all measurement, control, and data I/O connections are for connection to Category I sources unless otherwise marked or described in the user documentation.

Exercise extreme caution when a shock hazard is present. Lethal voltage may be present on cable connector jacks or test fixtures. The American National Standards Institute (ANSI) states that a shock hazard exists when voltage levels greater than 30V RMS, 42.4V peak, or 60VDC are present. A good safety practice is to expect that hazardous voltage is present in any unknown circuit before measuring.

Operators of this product must be protected from electric shock at all times. The responsible body must ensure that operators are prevented access and/or insulated from every connection point. In some cases, connections must be exposed to potential human contact. Product operators in these circumstances must be trained to protect themselves from the risk of electric shock. If the circuit is capable of operating at or above 1000V, no conductive part of the circuit may be exposed.

Do not connect switching cards directly to unlimited power circuits. They are intended to be used with impedance-limited sources. NEVER connect switching cards directly to AC mains. When connecting sources to switching cards, install protective devices to limit fault current and voltage to the card.

Before operating an instrument, ensure that the line cord is connected to a properly-grounded power receptacle. Inspect the connecting cables, test leads, and jumpers for possible wear, cracks, or breaks before each use.

When installing equipment where access to the main power cord is restricted, such as rack mounting, a separate main input power disconnect device must be provided in close proximity to the equipment and within easy reach of the operator.

For maximum safety, do not touch the product, test cables, or any other instruments while power is applied to the circuit under test. ALWAYS remove power from the entire test system and discharge any capacitors before: connecting or disconnecting cables or jumpers, installing or removing switching cards, or making internal changes, such as installing or removing jumpers.

Do not touch any object that could provide a current path to the common side of the circuit under test or power line (earth) ground. Always make measurements with dry hands while standing on a dry, insulated surface capable of withstanding the voltage being measured.

The instrument and accessories must be used in accordance with its specifications and operating instructions, or the safety of the equipment may be impaired.

Do not exceed the maximum signal levels of the instruments and accessories, as defined in the specifications and operating information, and as shown on the instrument or test fixture panels, or switching card.

When fuses are used in a product, replace with the same type and rating for continued protection against fire hazard.

Chassis connections must only be used as shield connections for measuring circuits, NOT as safety earth ground connections.

If you are using a test fixture, keep the lid closed while power is applied to the device under test. Safe operation requires the use of a lid interlock.

If a  screw is present, connect it to safety earth ground using the wire recommended in the user documentation.

The  symbol on an instrument indicates that the user should refer to the operating instructions located in the user documentation.

The  symbol on an instrument shows that it can source or measure 1000V or more, including the combined effect of normal and common mode voltages. Use standard safety precautions to avoid personal contact with these voltages.

The  symbol on an instrument shows that the surface may be hot. Avoid personal contact to prevent burns.

The  symbol indicates a connection terminal to the equipment frame.

If this  symbol is on a product, it indicates that mercury is present in the display lamp. Please note that the lamp must be properly disposed of according to federal, state, and local laws.

The **WARNING** heading in the user documentation explains dangers that might result in personal injury or death. Always read the associated information very carefully before performing the indicated procedure.

The **CAUTION** heading in the user documentation explains hazards that could damage the instrument. Such damage may invalidate the warranty.

Instrumentation and accessories shall not be connected to humans.

Before performing any maintenance, disconnect the line cord and all test cables.

To maintain protection from electric shock and fire, replacement components in mains circuits - including the power transformer, test leads, and input jacks - must be purchased from Keithley Instruments. Standard fuses with applicable national safety approvals may be used if the rating and type are the same. Other components that are not safety-related may be purchased from other suppliers as long as they are equivalent to the original component (note that selected parts should be purchased only through Keithley Instruments to maintain accuracy and functionality of the product). If you are unsure about the applicability of a replacement component, call a Keithley Instruments office for information.

To clean an instrument, use a damp cloth or mild, water-based cleaner. Clean the exterior of the instrument only. Do not apply cleaner directly to the instrument or allow liquids to enter or spill on the instrument. Products that consist of a circuit board with no case or chassis (e.g., a data acquisition board for installation into a computer) should never require cleaning if handled according to instructions. If the board becomes contaminated and operation is affected, the board should be returned to the factory for proper cleaning/servicing.

---

# Table of Contents

## 1 Front Panel Operation

Product overview .....	1-2
Display .....	1-8
Power-up.....	1-8
Bench defaults .....	1-9
Voltage measurements.....	1-10
Current measurements.....	1-11
Two and four-wire resistance measurements .....	1-12
Frequency measurements .....	1-14
Temperature measurements.....	1-16

## 2 Measurement Options

Multiple displays .....	2-2
Menus .....	2-6
Relative.....	2-10
Trigger .....	2-11
Speed .....	2-14
Resolution.....	2-15
Filter .....	2-16
Buffer (Data Store).....	2-18
Math .....	2-20
Internal scanning .....	2-22
External scanning .....	2-26

## 3 IEEE-488 Bus Operation

Software support.....	3-2
IEEE-488 bus standards .....	3-3
IEEE-488 bus connections .....	3-3
Primary address selection.....	3-4
Common commands.....	3-5
SCPI commands .....	3-6
SCPI command syntax .....	3-7
SCPI signal oriented commands .....	3-11
SCPI subsystem commands .....	3-12
Program examples .....	3-18

## 4 Specs and Accessories

Condensed specifications .....	4-2
Accessories available.....	4-8

---

# 1 Front Panel Operation

## Product overview

If you have any questions after reviewing this information, please contact your local Keithley representative, or call one of our Applications Engineers at **1-800-348-3735** (U.S. and Canada only). Worldwide phone numbers are listed on the back cover.

The Model 2002 is an 8½-digit multimeter with the following measurement capabilities:

- DC voltage measurements from 1nV to 1100V
- AC RMS voltage measurements from 100nV to 750V, 1100V peak
- DC current measurements from 10pA to 2.1A
- AC current measurements from 100pA to 2.1A
- 2-wire resistance measurements from 100nΩ to 1.05GΩ
- 4-wire resistance measurements from 100nΩ to 2.1MΩ
- Frequency measurements from 1Hz to 15MHz
- RTD temperature measurements from -200°C to +630°C
- Thermocouple temperature measurements (with optional card) from -200°C to +1820°C

**Figure 1**  
Measurement ranges  
(resolution)

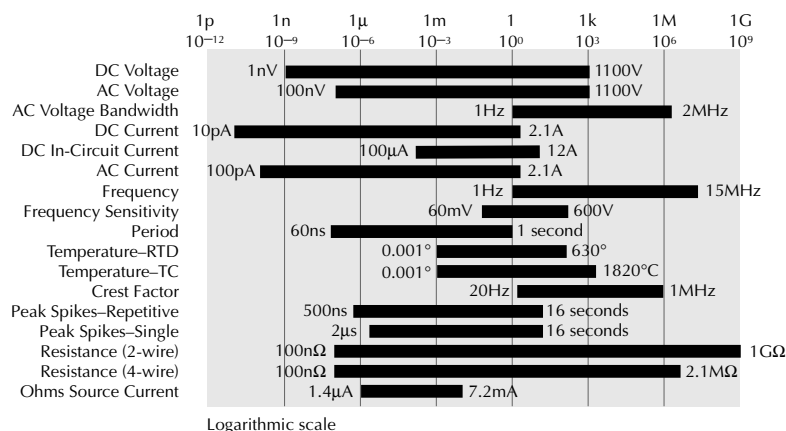



Some additional capabilities of the Model 2002 include:

- Data storage with burst mode capability
- Scan (measure) channels of an external scanner (e.g., Model 7001 or 7002)
- Single button zeroing (REL)
- Built-in math functions
- Digital filtering
- Remote operation using the IEEE-488 bus

By installing the appropriate option card, the capabilities of the Model 2002 are extended as follows:

- Scan internal channels (Model 2001-SCAN Scanner Card or Model 2001-TCSCAN Thermocouple Scanner Card)
- Perform thermocouple temperature measurements (Model 2001-TCSCAN Thermocouple Scanner Card)
- Extend the voltage and resistance measurement ranges (Model 1801 Nanovolt Preamp)

The Model 2002 front and rear panel overviews (Figures 2 and 3) include important abbreviated information that should be reviewed before operating the instrument.

**Figure 2**  
Model 2002  
front panel  
overview

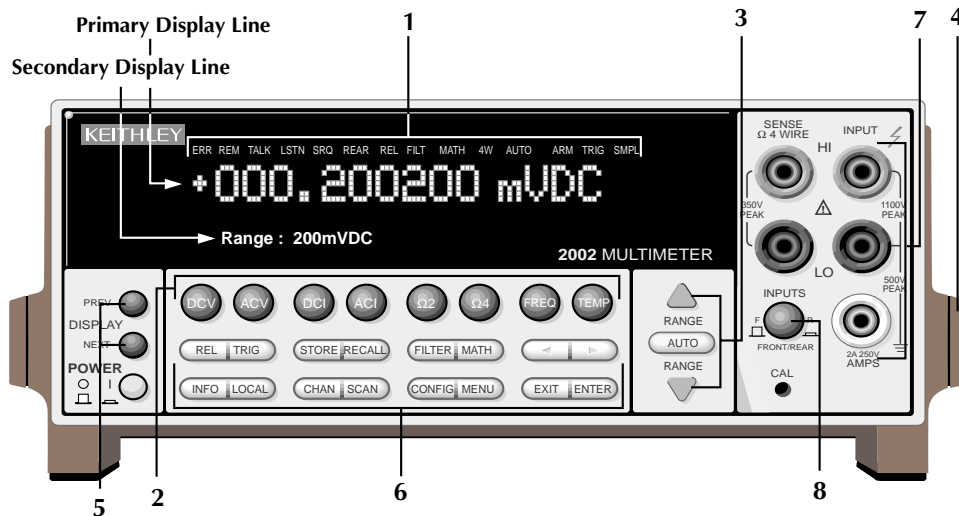

### 1 ANNUNCIATORS

ERR	Questionable reading
REM	In remote
TALK	Addressed to talk
LSTN	Addressed to listen
SRQ	Service Request
REAR	Reading acquired from rear inputs
REL	Relative reading displayed
FILT	Digital filter enabled
MATH	Math calculation enabled
4W	4-wire resistance reading displayed
AUTO	Autoranging enabled
ARM	Trigger armed; not in idle
*(asterisk)	Reading being stored

**2 FUNCTION KEYS** Select measurement function (DC and AC voltage, DC and AC current, 2-wire and 4-wire resistance, frequency, and temperature)

### 3 RANGE KEYS

▲	Moves to higher range; increments digit
▼	Moves to lower range; decrements digit
AUTO	Enables/disables autorange

- 
- 4 **HANDLE** (not shown) Pull out and rotate to desired position
- 5 **DISPLAY KEYS** PREV/NEXT Scroll through multiple displays of a function
- 6 **OPERATION KEYS**
- REL Enables/disables relative reading
  - TRIG Triggers unit
  - STORE Enables data storage
  - RECALL Displays reading data (reading, number, time). Use PREV/NEXT DISPLAY for maximum, minimum average, standard deviation
  - FILTER Displays digital filter status for present function and toggles filter on/off
  - MATH Displays math calculation and toggles math on/off if configured
  - ◀ and ▶ Moves cursor among data entry digits, menu selections, and information displays
  - INFO Shows context-sensitive information about the present display
  - LOCAL Cancels IEEE-488 remote
  - CHAN Selects internal scanner channel to measure (1-10)
  - SCAN Performs scan of internal or external scanner channels, or ratio or delta
  - CONFIG Configures functions and operations
  - MENU Saves/restores instrument conditions; sets up GPIB; performs calibration and self-tests; defines limits, buffer, digital I/O, autozero
  - EXIT Cancels selection, moves back within menu structure
  - ENTER Holds reading, enters selection, moves down within menu structure
- 7 **INPUT CONNECTIONS**
- INPUT HI and LO Used for making DC volts, AC volts, and 2-wire resistance measurements
  - AMPS Used in conjunction with INPUT LO to make DC current and AC current measurements. Also holds current input fuse (2A, 250V, fast blow, 5×20mm)
  - SENSE Ω4 WIRE HI and LO Used with INPUT HI and LO to make 4-wire resistance measurements
- 8 **INPUTS** Selects input connections on front or rear panel

**Figure 3**  
Model 2002  
rear panel  
overview

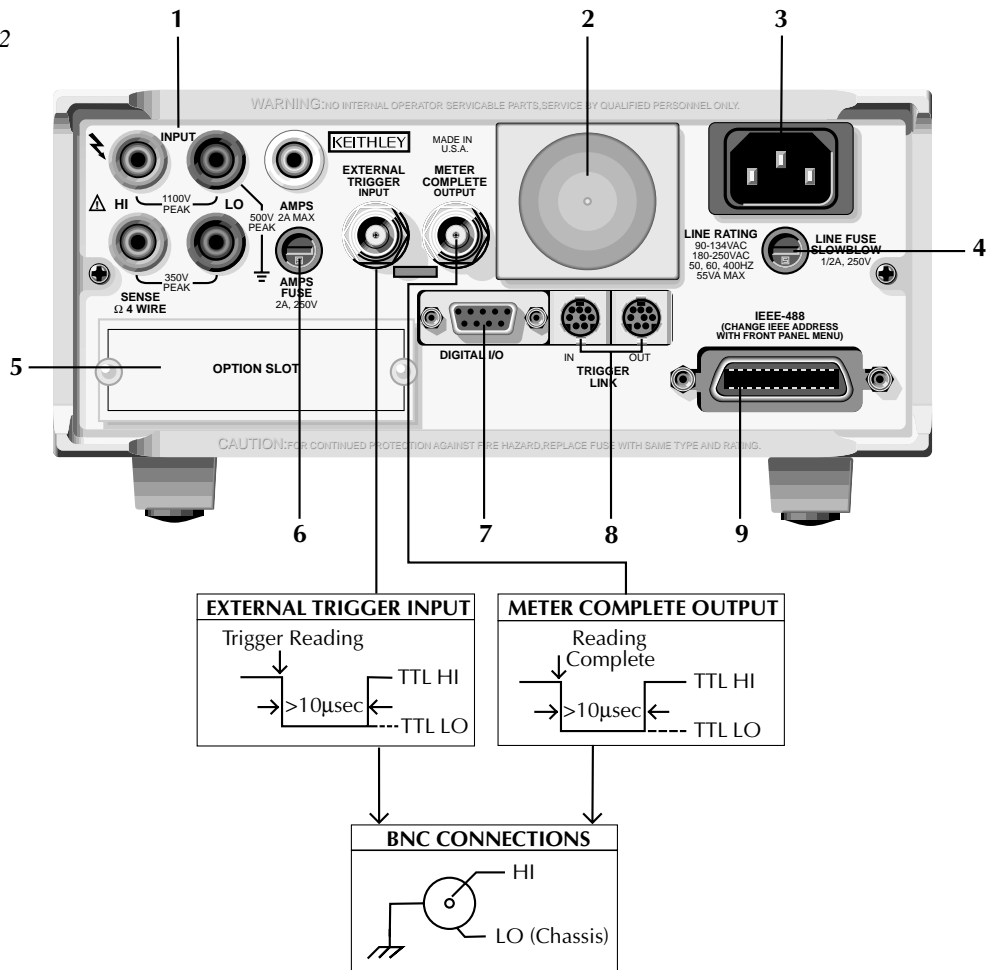

**1 INPUT CONNECTIONS**

- INPUT HI and LO** Used for DC volts, AC volts, and 2-wire resistance measurements
- AMPS** Used with INPUT LO to make DC current and AC current measurements
- SENSE  $\Omega$ 4 WIRE HI and LO** Used with INPUT HI and LO to make 4-wire resistance measurements

**2 FAN** Keep filter clean to ensure proper instrument cooling

**3 POWER LINE INPUT**

90–134VAC and 180–250VAC (universal); 50, 60, or 400Hz (self-identifying at power-up)

**WARNING:** Connect to grounded outlet using 3-wire power cord

**4 LINE FUSE** 0.5A, 250V, slow blow, 5×20mm

**5 OPTION SLOT** An option card installs in this slot

**6 AMPS FUSE** 2A, 250V, fast blow, 5×20mm

**7 DIGITAL I/O** A DB-9 connector for the TTL-compatible digital I/O with one input and four outputs

**8 TRIGGER LINK IN and OUT** Two 8-pin micro DIN connectors for sending and receiving trigger pulses among other instruments

**9 IEEE-488 CONNECTOR** Connects the instrument to the IEEE-488 (GPIB) bus

**NOTE:** Use shielded IEEE-488 cables

## Display

As shown in the Model 2002 front panel overview (Figure 2), the front panel has three lines of display information: the primary display line, the secondary display line, and annunciators.

- **Primary Display Line:** The top line displays readings along with units. It can also display measurement type (e.g., RMS), “hold”, math operating type, channel number, menu headings and messages. Error and status messages are listed in Section 2 of the User’s Manual.
- **Secondary Display Line:** The bottom line displays the range, other measurement parameters (e.g., coupling or ratio), menu items, messages and multiple displays (see MEASUREMENT OPTIONS section of this manual). Longer text strings are indicated by arrows on either end of the display line. Use the cursor keys (◀ and ▶) to display the additional information.

Note that in certain situations, displayed readings may be expressed in scientific notation. For example, a reading of +1.0000e-03VDC is interpreted as 1mVDC.

## Power-up

**Warning**      *Before turning on the Model 2002, make sure it is connected to a grounded power receptacle using the supplied power cord or the equivalent. Failure to properly ground the unit creates a shock hazard that could result in injury or death.*

Use the front panel POWER switch to turn power on and off.

During power-up, the Model 2002 performs self-tests on its memory elements. If a failure occurs, the instrument momentarily displays an error message and turns on the ERR annunciator. If the instrument passes the self-tests, the firmware revision levels, memory option (if installed), and IEEE-488 address are displayed.

For complete information on the power-up sequence, see Section 2 in the User’s Manual.

## Warm-up

The instrument is ready for use as soon as the power-up sequence is completed. However, to achieve rated accuracy, allow the instrument to warm up for four hours. If the instrument has been subjected to extreme temperatures, allow additional time to allow internal temperatures to stabilize.

---

## Bench defaults

The Model 2002 can save one, five, or ten user setups in non-volatile memory, depending on the installed memory option. You can select one of the user setups as the power-on default, or have the instrument power up to either of the two factory defaults (optimized for “BENCH” or “GPIB” operation).

Since the basic measurement procedures in this manual assume the BENCH defaults, reset the instrument from the SAVESETUP item of the MAIN MENU by performing the following steps:

1. Press the MENU key to display the main menu:

```
MAIN MENU
SAVESETUP GPIB CALIBRATION ►
◀ TEST LIMITS STATUS-MSG GENERAL
```

2. If the SAVESETUP option is not blinking, press the ◀ key until it is blinking and then press ENTER to view the setup menu:

```
SETUP MENU
SAVE RESTORE POWERON RESET
```

3. Select the RESET option and press ENTER to view the reset menu:

```
RESET ORIGINAL DFLTS
BENCH GPIB
```

4. Select the BENCH option and press ENTER. The following message is displayed:

```
RESETTING INSTRUMENT
Enter to confirm; EXIT to abort
```

5. Press ENTER to confirm. The display will show DC voltage readings with auto-range enabled.

Other BENCH default settings for DCV include:

- Triggers — Continuous measurements.
- Measurement speed (integration time) — Normal, 1 power line cycle.
- Digital filter — Advanced, 10 readings, 1% noise tolerance, moving average, enabled.
- Display resolution — 7.5 digits.

Note: See MENUS in the MEASUREMENT OPTIONS section of this manual for details on navigating the Main Menu.

## Voltage measurements

Assuming “BENCH” reset conditions, the basic procedure is as follows:

1. Connect test leads to the INPUT HI and LO terminals. Either the front or rear inputs can be used; place the INPUTS button in the appropriate position.
2. Select the measurement function by pressing DCV or ACV.
3. The AUTO annunciator indicates that autoranging is enabled. If you want manual ranging, use the RANGE ▲ and ▼ keys to select a measurement range consistent with the expected voltage.
4. Connect test leads to the source as shown in Figure 4.

**CAUTION** Do not apply more than 1100V peak or  $2 \times 10^7 \text{V} \cdot \text{Hz}$  to the input, or instrument damage may occur.

5. Observe the display. If the “Overflow” message is displayed, select a higher range until a normal reading is displayed. Use the lowest possible range for the best resolution.
6. Take a reading from the display.

**Figure 4**  
DC and AC  
voltage measurements

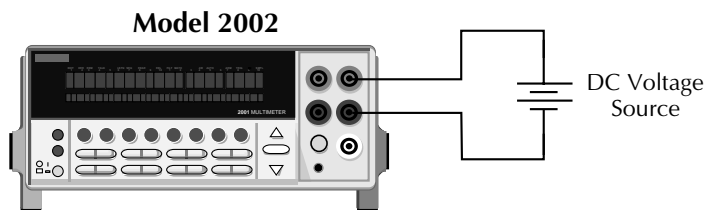

Input Resistance =  $10 \text{M}\Omega$  on 1000V and 200V ranges.  
 $> 100 \text{G}\Omega$  on 20V, 2V and 200mV ranges.  
 $= 1 \text{M}\Omega$  on DCV peak spikes measurement.

**Caution :** Maximum Input = 1100V peak

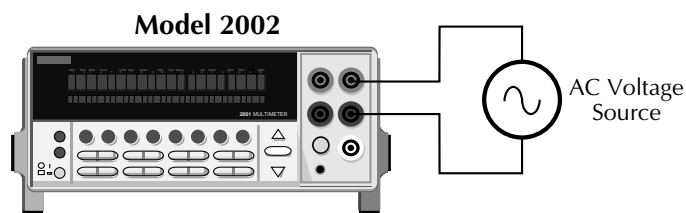

Input Impedance =  $1 \text{M}\Omega$  shunted by  $< 140 \text{pF}$

**Caution:** Maximum Input = 1100V peak,  $2 \times 10^7 \text{V} \cdot \text{Hz}$



## Current measurements

Assuming “BENCH” reset conditions, the basic procedure is as follows:

1. Connect test leads to the AMPS and INPUT LO terminals. Either the front or rear inputs can be used; place the INPUTS button in the appropriate position.
2. Select the measurement function by pressing DCI or ACI.
3. The AUTO annunciator indicates that autoranging is enabled. If you want manual ranging, use the RANGE ▲ and ▼ keys to select a measurement range consistent with the expected current.
4. Connect test leads to the source as shown in Figure 5.

**CAUTION** Do not apply more than 2.1A, 250V to the input, or the amps fuse will blow.

5. Observe the display. If the “Overflow” message is displayed, select a higher range until a normal reading is displayed. Use the lowest possible range for the best resolution.
6. Take the reading from the display.

*Figure 5*  
DC and AC  
current measurements

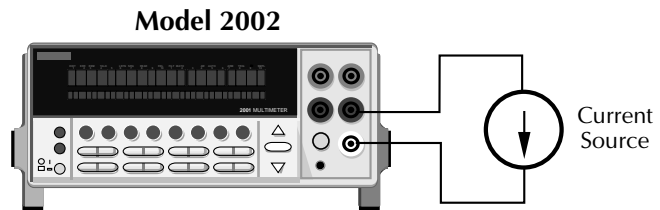

**Caution:** Maximum Input = 2.1A

## Two and four-wire resistance measurements

Assuming “BENCH” reset conditions, the basic procedure is as follows:

1. Connect test leads to the Model 2002 as follows:
  - A. For 2-wire, connect the test leads to INPUT HI and LO.
  - B. For 4-wire, connect the test leads to INPUT HI and LO, and SENSE  $\Omega$ 4 WIRE HI and LO. Recommended Kelvin test probes include the Keithley Models 5805 and 5806.

Either the front or rear inputs can be used; place the INPUTS button in the appropriate position.

2. Select the measurement function by pressing  $\Omega$ 2 or  $\Omega$ 4.
3. The AUTO annunciator indicates that autoranging is enabled. If you want manual ranging, use the RANGE  $\blacktriangle$  and  $\blacktriangledown$  keys to select a measurement range consistent with the expected resistance.
4. Connect test leads to the resistance as shown in Figure 6.

**CAUTION** *Do not apply more than 1100V peak between INPUT HI and LO, or instrument damage may occur.*

5. Observe the display. If the “Overflow” message is displayed, select a higher range until a normal reading is displayed. Use the lowest possible range for the best resolution.
6. Take a reading from the display.

### Shielding

It helps to shield resistances greater than 100k $\Omega$  to achieve a stable reading. Place the resistance in a shielded enclosure and electrically connect the shield to the INPUT LO terminal of the instrument.

**Figure 6**  
*Two and four-wire resistance measurements*

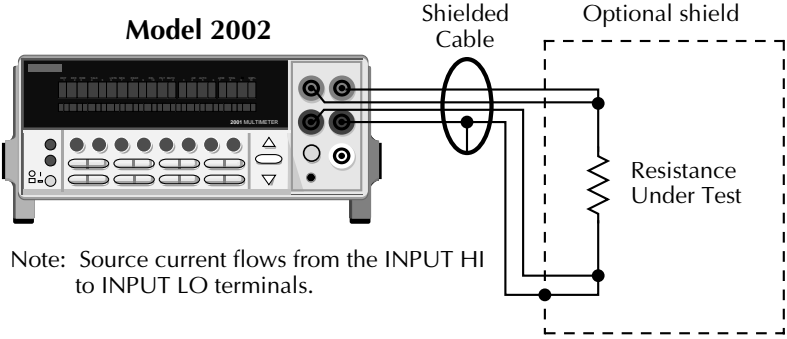
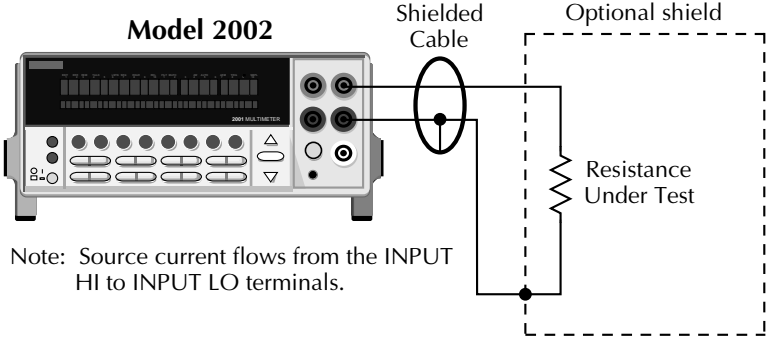

## Frequency measurements

The Model 2002 can make frequency measurements from 1Hz to 15MHz through its INPUT HI and INPUT LO terminals, and from 1Hz to 1MHz through its AMPS and INPUT LO terminals. Assuming “BENCH” reset conditions, the basic procedure is as follows:

1. Connect test leads to the INPUT HI and LO terminals of the Model 2002. Either the front or rear inputs can be used; place the INPUTS button in the appropriate position.

**NOTE** A bench reset defaults the frequency input terminals to INPUT HI and LO.

2. Select the FREQ function.
3. Connect test leads to the source as shown in Figure 7 (top).

**CAUTION** Do not exceed 1100V peak between INPUT HI and INPUT LO, or instrument damage may occur.

4. Take a reading from the display.

The procedure for measuring frequency with the AMPS and INPUT LO terminals is similar. However, the FREQ function has to be configured to use the current terminals (the connection diagram is shown in Figure 7 (lower)). Perform the following steps to select the AMPS and INPUT LO terminals:

1. Press the CONFIG key and then the FREQ key.
2. Using the cursor keys (◀ and ▶), place the cursor on INPUT-TERMINALS and press ENTER.
3. Place the cursor on CURRENT and press ENTER.
4. Use the EXIT key to back out of the menu structure.

**CAUTION** Do not apply more than 2.1A, 250V to the AMPS input, or the amps protection fuse will blow.

**Figure 7**  
Frequency measurements

AC voltage input

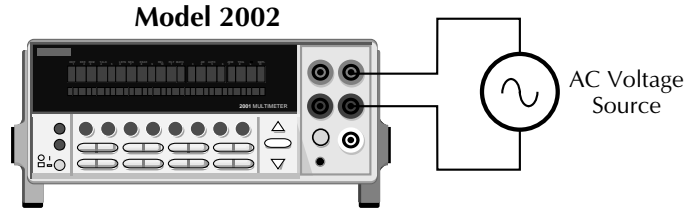

**Caution:** Maximum Input = 1100V peak,  $2 \times 10^7$  V•Hz

AC current input

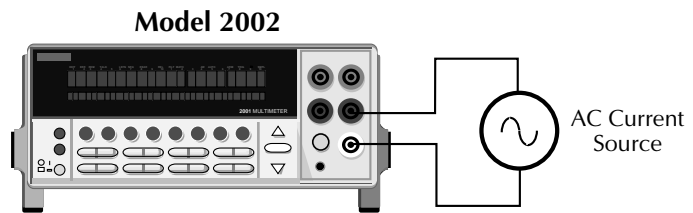

**Caution:** Maximum Input = 1A peak

## Trigger level

An appropriate trigger level is needed for the frequency counter to operate properly. The instrument only counts cycles with peak amplitudes that reach the trigger level. For example, if the trigger level is set for 5V, cycles with peak amplitudes less than 5V are not counted.

Use the RANGE ▲ and ▼ keys to check and/or change the trigger level. The AUTO range key returns the trigger level to 0V or 0mA.

## Temperature measurements

The Model 2002 measures temperature with two different sensor types: RTDs and thermocouples. With RTDs, the Model 2002 can measure temperature between  $-200^{\circ}\text{C}$  and  $+630^{\circ}\text{C}$ . RTDs can be connected to the input terminals or the optional Model 2001-SCAN scanner card.

With thermocouples connected to the Model 2001-TCSCAN card or an external thermocouple card, such as a Model 7057A or 7402 in a Model 7001 or 7002 Switch System, the instrument measures temperature over a range that is dependent on the thermocouple type.

Assuming “BENCH” reset conditions, the basic procedure to measure temperature with a type PT100 4-wire RTD (the default sensor) is as follows:

1. Connect the RTD sensor to the Model 2002 as shown in Figure 8. You can use banana plugs (with the front or rear inputs), or the optional Model 8680 RTD Probe Adapter (with the front inputs). Place the INPUTS button in the appropriate position RTDs can also be connected to the optional Model 2001-SCAN scanner card.
2. Select the TEMP function.

**CAUTION** *Do not exceed 1100V peak between INPT HI and LO, or 350V peak between SENSE  $\Omega$ 4 WIRE HI and LO, or instrument damage may occur.*

3. Observe the display. If the “Overflow” message is shown, the RTD might not be connected properly.
4. Take a reading from the display.

The procedure for measuring temperature with 3-wire and 2-wire RTDs is similar and is covered in Section 2 of the User’s Manual.

To measure temperature with thermocouples, you need to connect the thermocouples to a suitable scanner card, such as the Model 2001-TCSCAN or an external card (Model 7057A or 7402). The thermocouple cards use channel 1 as the reference junction and must be configured on the Model 2002 for TC type, voltage reference and offset. See Section 2 in the User’s Manual for configuration details.

**Figure 8**  
Four-wire RTD temperature measurements

Connections to banana jacks

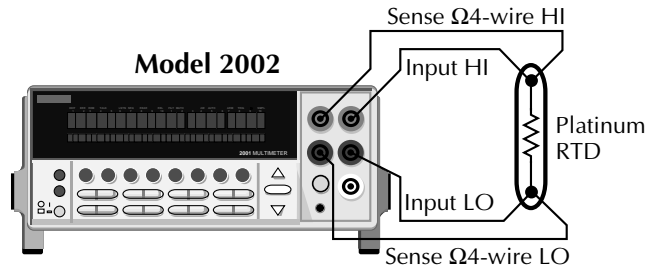

Connections to circular jack

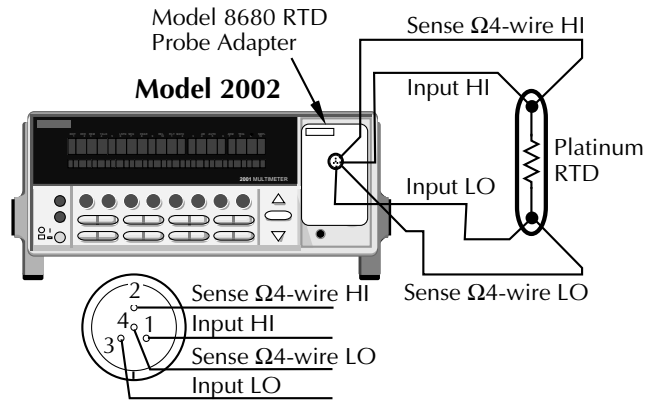

**WARNING:** To avoid a shock hazard and possible instrument damage, do not use the Model 8680 RTD Probe Adapter to measure voltages exceeding 30V RMS, 42.4V peak.

Connections to terminal block

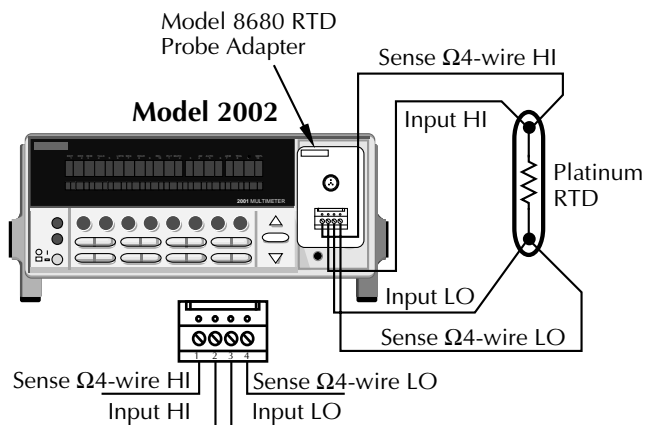





---

# 2 Measurement Options

This section describes the details of making measurements. Configuration options, triggers, reading storage, and scanning are just a few of the topics discussed. You will find this information useful whether operating the Model 2002 from the front panel or IEEE-488 bus.

## **Multiple displays**

Each measurement function and some operations provide “multiple displays” by using the bottom line of the front panel. These multiple displays provide multiple type measurements, show a reading in a different form, or give additional information about the reading.

A few of the frequently used multiple displays are summarized in this section. All the multiple displays are shown in Table 1.

The NEXT and PREV (previous) DISPLAY keys scroll through the multiple displays for the selected function or operation. The multiple display mode can be cancelled by pressing and holding in either key.

**Table 1**  
Multiple displays by function

Function	Next display
All	Bar graph Zero-centered bar graph Maximum and minimum values Relative and actual values Calculated and actual values (see Note 1) Limits bar graph (see Note 1) Adjacent channel readings (see Note 2)
DC voltage	DC volts, AC ripple voltage and frequency Positive peak spikes and highest value Negative peak spikes and lowest value Positive and negative peak spikes
AC voltage	AC RMS voltage, frequency, and crest factor AC RMS, average, and peak voltages
DC current	(none specific to function)
AC current	AC RMS (or average) current and frequency AC RMS and average current
2-wire resistance	Source current Voltage drop across DUT
4-wire resistance	Source current Voltage drop across DUT Lead resistance
Frequency	Period calculation Trigger level
Temperature	Celsius, Fahrenheit, and Kelvin units RTD resistance (or thermocouple voltage) Reference junction (thermocouples only)
Data storage buffer	Maximum and minimum values Average and standard deviation

## Notes:

1. Multiple displays for calculated values and limits bar graph are not available for the frequency function.
2. The multiple display for adjacent channel readings is not available for the DC and AC current functions.



**Bar Graph** — The bar graph is a graphical representation of the reading with zero at the left end. Each full segment of the bar represents approximately 4% of the range limit.



**Zero-centered Bar Graph** — The zero-centered bar graph is a graphical representation of the reading using plus minus limits with zero in the center. Each full segment represents 10% of the limit.



**Maximum and Minimum** — This display shows the maximum and minimum readings that have occurred since the display was entered. Maximum and minimum values are reset by pressing the present function key or by leaving the display.



**Relative and Actual** — This display is used with the rel (relative) feature. While the top line shows the result of the rel operation, the bottom line shows the actual (raw) reading.



**Calculated and Actual** — This display is used with a math calculation. While the top line provides the result of the math calculation, the bottom line provides the raw reading.



**Buffer** — These bottom line displays are used when recalling readings from the data store buffer. They provide the maximum, minimum, average and standard deviation for the readings stored in the buffer.



## Menus

There are two basic menu structures used by the Model 2002: the main menu and the CONFIGURE menus. The main menu accesses items for which there are no dedicated keys; the CONFIGURE menus configure measurement functions and other instrument operations.

Table 2 summarizes main menu selections. Tables 3 and 4 show configuration settings for the measurement functions and instrument operations.

**Table 2**  
*Summary of main menu*

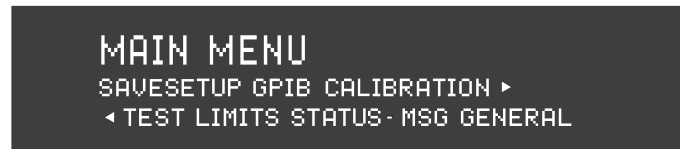

Option	Description
SAVESETUP	Save and restore setups stored in memory, set power-on defaults, and return unit to default conditions.
GPIB	Check or change IEEE-488 bus address, configure unit for talk-only operation, select data elements, and display the status byte.
CALIBRATION	Calibrate the Model 2002 (see Calibration Manual), and check calibration date.
TEST	Perform self-tests (see Repair Manual).
LIMITS	Configure unit to perform limit tests.
STATUS-MSG	Enable/disable status message mode.
GENERAL	Control output lines and read input lines of digital I/O port, check serial number of unit and firmware revision levels, control line-sync and autozero, configure times-tamp, select decimal point character, and set real-time clock.

**Table 3**  
*Configuration settings for each measurement function*

Function	Speed	Filter	Resolution	Coupling	Max. signal level	Units (V, db, dbm)	AC type	Offset comp.	Max. auto range	Sensor
DC Voltage	•	•	•							
AC Voltage	•	•	•	•		•	•			
2-Wire Resistance	•	•	•					•	•	
4-Wire Resistance	•	•	•					•	•	
DC Current	•	•	•							
AC Current	•	•	•	•		•	•			
Frequency/Period			•		•					
Temperature	•	•	•							•

The 2002 allows each measurement function to be configured independently, letting you set each function as desired. For example, if DCV is set for 7½ digits using 10 power line cycles, ACV can be set to 5½ digits at 0.1 power line cycle.

**Table 4**  
*Configuration settings for instrument operations*

Option	Description
CONFIG REL	Set rel (relative) value and enable.
CONFIG TRIG	Configure measure layer, scan layer and arm layer of trigger model.
CONFIG STORE	Enable/disable burst mode, select data grouping, set buffer control, configure timestamp, clear buffer, set buffer size and select buffer feed.
CONFIG FILTER	Select auto, averaging, advanced or averaging-mode filter.
CONFIG MATH	Select and configure math calculation; polynomial, percent or percent deviation.
CONFIG CHAN	Configure unit for internal channels or external channels, and save and restore an alternate function.
CONFIG SCAN	Configure scan for internal or external channels. Configure unit for ratio or delta calculations.
CONFIG NEXT	Change the scale for the zero-center bar graph.

## Navigating menus

Use the following rules to navigate through the menu structures. Table 5 summarizes the front panel keys used for navigation.

1. From the instrument's normal state of displaying readings, you can:
  - View a configuration menu by pressing CONFIG and then the desired function or operation key (DCV, TRIG, etc.).
  - View the top level of the main menu by pressing the MENU key.
2. The unit is returned to the normal reading display by:
  - Pressing EXIT or MENU from the top level of the main menu.
  - Pressing EXIT from the top level of a configuration menu.
  - Pressing a measurement function key from within a menu.
3. Pressing the ENTER key selects an item and, if further definition is needed, moves down within the menu structure. Pressing the EXIT key backs up within a menu structure.
4. The cursor position is denoted by a blinking menu item or parameter. The cursor is moved from one item to the next using the cursor keys (◀ and ▶). To select an item, highlight it with the cursor, then press ENTER.
5. A displayed arrow (◀ and ▶) on the bottom line indicates there is more information or additional menu items to select from. When “◀” is displayed, use the ◀ cursor key. The cursor keys have an auto-repeat feature.
6. A numeric parameter is keyed in by placing the cursor on the digit to be changed, and pressing the RANGE ▲ or ▼ keys to increment or decrement the digit.
7. A change is only executed when the ENTER key is pressed. Entering an invalid parameter generates an error, and the entry is ignored. Changes are also ignored if an EXIT is performed.
8. The INFO key can be used anywhere in a menu to display helpful information messages concerning operation. To cancel an information message and remain in the menu, press INFO a second time, EXIT, or ENTER. Pressing a function key cancels INFO and a menu, and returns the instrument to a reading display.



**Table 5**  
*Menu summary*

Action	Description
CONFIG-(function)	Press the CONFIG key, then a function key (e.g., DCV) to view the top level of a function configuration menu.
MENU	Press the MENU key to view the top level of the main menu. The operations that have no corresponding key are included in the main menu.
◀ or ▶	Use the cursor keys to move the highlighted cursor among menu selections, or the digits of a parameter value, or change channels on the scanner.
RANGE ▲ RANGE ▼	Use the RANGE keys to increment and decrement digits of a parameter value.
ENTER	Accepts menu selection or data entry.
EXIT	Cancels changes menu selection. Also returns you to the previous menu level.
INFO	Displays context-sensitive information about the present menu level. Toggles information message on/off.

## Relative

Rel subtracts a reference value from actual readings. When rel is enabled, the instrument uses the present reading as a relative value. Subsequent readings will be the difference between the actual input value and the rel value.

$$\text{Actual Input} - \text{Reference} = \text{Displayed Reading}$$

Thus, when you perform a zero correction for DCV,  $\Omega 2$ , and  $\Omega 4$  measurements by enabling REL, the displayed offset becomes the reference value. Subtracting the offset from the actual input zeroes the display.

The rel (relative) operation is enabled by pressing the REL key (REL annunciator turns on). Pressing REL a second time disables rel. You can also enter and enable a rel value from the CONFIG-REL display.

A rel value can be established for each measurement function. The state and value of rel for each measurement function are saved when changing functions. Once a rel value is established for a measurement function, the value is the same for all ranges.

### Configuring Rel

To check or change a rel value for a measurement function, perform the following steps:

1. Select the desired measurement function.
2. Press the CONFIG key and then the REL key to display the present rel value.
3. Use the cursor keys (◀ and ▶) and the RANGE keys to change the rel value and press ENTER. The instrument will return to the normal display state with rel enabled.

# Trigger

The following overview is intended to acquaint you with basic triggering. For a complete explanation, see the Model 2002 User's Manual. The simplified model for triggering is shown in Figure 9. It is known as the trigger model.

**Figure 9**  
Simplified  
trigger model

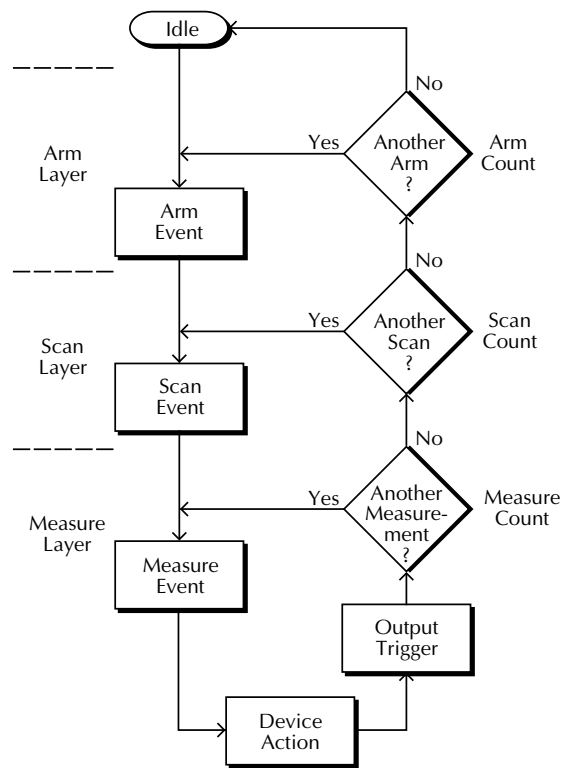

## Idle

The instrument is in idle whenever it is not within one of the layers of the model. The front panel ARM indicator is off when in idle.

When the Model 2002 is taken out of idle by pressing TRIG (or sending :INIT or :INIT:CONT ON over the bus), the ARM indicator turns on and operation proceeds into the Arm Layer.

## Trigger model layers

The trigger model has three layers: the Arm Layer, Scan Layer and Measure Layer. For IEEE-488 bus operation, these layers are known as Arm Layer 1, Arm Layer 2 and the Trigger Layer.

Once the Model 2002 is taken out of idle, operation proceeds through the layers of the trigger model down to the device action where a measurement occurs.

### Control source

In general, each layer contains a control source which holds up operation until the programmed event occurs. The control sources are described as follows:

- Immediate – Event detection is immediately satisfied, allowing operation to continue.
- Manual – Event detection is satisfied by pressing the TRIG key.
- GPIB – Event detection is satisfied when a bus trigger (GET or \*TRG) is received.
- RT-Clock – Event detection in the Arm Layer is satisfied when the programmed time and date occur. (Not available in the Scan Layer and Measure Layer.)
- Timer – Event detection is immediately satisfied on the initial pass through the layer. Each subsequent detection is satisfied when the programmed timer interval elapses. (Not available in the Arm Layer.)
- External – Event detection is satisfied when an input trigger via the EXTERNAL TRIGGER connector is received.
- TrigLink – Event detection is satisfied when an input trigger via the TRIGGER LINK is received.
- Hold – With this selection, event detection is not satisfied by any of the above control source events and operation is held up.

### **Device action**

The primary device action is a measurement. However, the device action could include a function change and a channel scan (if scanner is enabled). A channel is scanned (closed) before a measurement is made. When scanning internal channels, the previous channel opens and the next channel closes (break-before-make). Also included in the device action is the internal settling time delay for the relay.

### **Output trigger**

After each measurement (device action), an output trigger pulse occurs and is available at the rear panel of the Model 2002. When used with an external scanner (such as a Model 7001 or 7002 Switch System), each output trigger would be used to select the next channel in a scan (see EXTERNAL SCANNING in the MEASUREMENT OPTIONS section of this manual).

### **Counters**

All three layers use programmable counters that allow operation to return to or stay in the respective layer. For example, programming the Measure Layer counter to infinite keeps operation in the Measure Layer. After each device action, operation loops back to the Trigger Layer control source. A counter resets when operation loops back to a higher layer (or idle).

## **Bench default trigger model setup**

The bench default setup takes the Model 2002 out of idle, sets the control sources of all layers to Immediate, and sets the Measure Layer counter to infinite. With this trigger model setup, operation simply falls into the Measure Layer (and stays there) to make continuous measurements.

## Speed

SPEED sets the integration time of the A/D converter, the period of time the input signal is measured. The SPEED can be set for each measurement function except **FREQ**. The integration time is specified in parameters based on a number of power line cycles (NPLC), where one PLC for 60Hz is 16.67msec and one PLC for 50Hz and 400Hz is 20msec.

In general, the fastest integration time (0.01 PLC) results in increased reading noise and less usable resolution, while the slowest integration time (50 PLC) provides the best common-mode and normal-mode rejection. In between settings are a compromise between speed and noise.

### Configuring speed

Each measurement function, except **FREQ**, can have its own unique integration time. Speed is set from the configure function menu structures. The procedure is summarized as follows:

1. Press the **CONFIG** key and then the desired function key (**DCV**, **ACV**, etc.).
2. Using the cursor keys (◀ and ▶), select **SPEED** and press **ENTER** to display the following speed options:
  - NORMAL**: Sets the integration time to 1 PLC.
  - FAST**: Sets the integration time to 0.01 PLC.
  - MEDIUM**: Sets the integration time to 0.1 PLC.
  - HIACCURACY**: Sets the integration time to 50 PLC.
  - SET-SPEED-EXACTLY**: This options prompts you to enter a PLC value (0.01 to 50).
  - SET-BY-RESOLUTION**: Automatically optimizes the integration time for the present resolution setting (see the User's Manual).
3. Use the menu items to configure speed. A menu item is selected by placing the cursor (using ◀ and ▶ keys) on it and pressing **ENTER**. Parameter values are changed using the cursor keys and the **RANGE** keys, and then pressing **ENTER**. See **MENUS** if you need more information to navigate through the menu structure.

**NOTE** For more information, see **SPEED** in Section 2 of the User's Manual.

# Resolution

Except for **FREQ**, **TEMP** and some special cases for **ACV**, all functions can operate from 3.5 to 8.5 digits of resolution. Each function can have its own unique resolution setting.

## Configure resolution

Perform the following steps to set resolution for a measurement function:

1. Press the **CONFIG** key and then the desired function key (**DCV**, **ACV**, etc.).
2. Using the cursor keys (◀ and ▶), select **RESOLUTION** and press **ENTER** to display the following resolution options:  
3.5d to 8.5d: Select one of these options to set the display resolution.  
AUTO: This option automatically optimizes the resolution for the present integration time (speed) setting (see the User's Manual).
3. Set resolution by placing the cursor (using ◀ and ▶ keys) on the menu option pressing **ENTER**. See **MENUS** if you need more information to navigate through the menu structure.

**NOTE** For more information, see **RESOLUTION** in Section 2 of the User's Manual.

## Filter

Filtering stabilizes noisy measurements. The Model 2002 uses a digital filter, which is based on reading conversions. The displayed, stored, or transmitted reading is an average of a number of reading conversions. When a filter is enabled by pressing FILTER (FILT annunciator turns on), the selected filter configuration for that measurement function is in effect. Pressing FILTER a second time disables the filter.

### Filter types

The Model 2002 has two types of digital filters; averaging and advanced. Both types are a simple average of 1 to 100 reading conversions. The difference is a user-programmed noise “window” for the advanced filter. The noise window (expressed as a percentage of range) allows a faster response time to large signal step changes. See the User’s Manual for complete information on filter types.

### Filter modes

There are two filter modes: moving or repeating. The moving filter uses a first-in, first-out stack. When the stack becomes full, the measurement conversions are averaged, yielding a reading. For each subsequent conversion, the new conversion is placed into the stack, the oldest conversion is discarded, and a new reading is averaged.

For the repeating filter, the stack is filled and the conversions are averaged to yield a reading. The stack is then cleared and the process starts over. See the User’s Manual for complete information on filter modes.

### Auto filter

With auto filtering, the instrument automatically configures the filter based on the selected function and measurement type.



## Configuring filters

Each measurement function, except **FREQ**, has its own filter configuration. The procedure to configure a filter is summarized as follows:

1. Select the measurement function.
2. Press **CONFIG** and then **FILTER** to display the following filter menu options:
  - AUTO**: Selects auto filtering.
  - AVERAGING**: Selects the averaging filter type and prompts you to enter the number of readings to average (the “stack” size).
  - ADVANCED**: Selects the advanced filter type and prompts you to enter the number of readings to average (the “stack” size). After entering the stack size, you are then prompted to enter the noise tolerance level (0 to 100%).
  - AVERAGING-MODE**: This item is used to select the filter mode: **MOVING** or **REPEAT**.
3. Use the menu items to configure the filter. A menu item is selected by placing the cursor (using ◀ and ▶ keys) on it and pressing **ENTER**. Parameter values are changed using the cursor keys and the **RANGE** keys, and then pressing **ENTER**. See **MENUS** if you need more information to navigate through the menu structure.

**NOTE** The filter configuration menus can also be accessed from the configure function menus.

**Figure 10**  
Filter response/noise window

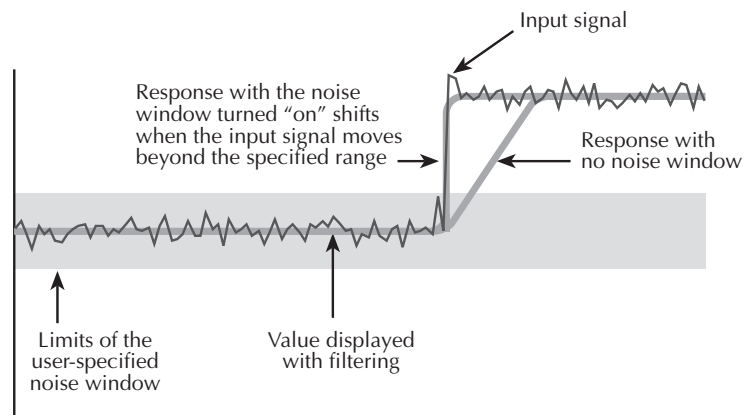

## Buffer (Data Store)

The Model 2002 has a buffer to store readings at two different rates: normal and burst modes. The maximum number of readings that can be stored depends on the installed memory option (standard, MEM1 or MEM2) and the user-programmable data group (full or compact). Storage capacity is summarized in Table 6.

**Table 6**  
*Memory options*

Model	Size (Bytes)	4½-Digit	6½-Digit w/ time stamp	Type
2002	8k	2,027	404	volatile
2002/MEM1	32k	6,909	1,381	non-volatile
2002/MEM2	128k	29,908	5,980	non-volatile

A full data group includes the reading, units, channel#, reading#, timestamp, and status. A compact data group does not include the channel# or timestamp. The data group and other buffer parameters are configured from the CONFIG DATA STORE menu structure.

### Normal mode

The following procedure to store readings at the normal rate uses a typical data store configuration: a user-defined number of readings will be stored in the buffer (fill-and-stop). All aspects of data store configuration and operation are detailed in Section 2 of the User's Manual.

1. Set up the instrument for the desired measurements (function, range, etc.).
2. Configure the data store as follows. Note that a menu item is selected by placing the cursor (using ◀ and ▶ keys) on it and pressing ENTER. See MENUS if you need more information to navigate through the menu structure.
  - Press CONFIG
  - Press STORE
  - Select DATA-GROUP
  - Select FULL or COMPACT
  - Select CONTROL
  - Select FILL-AND-STOP

Note: If you selected the FULL data group, continue on to configure the timestamp. Otherwise, press EXIT to back out of the menu structure.

- Select TIMESTAMP
- Select TYPE
- Select REAL-TIME
- Select FORMAT
- Select ABSOLUTE

Use the EXIT key to back out of the menu structure.

3. Press STORE. The presently programmed buffer size (number of readings to store) is displayed. If desired, use the cursor keys and the RANGE keys to change the buffer size. (Incrementing the most significant digit changes buffer size to the maximum.)

4. Press ENTER to start storing readings. The asterisk (\*) annunciator turns on to indicate a data storage operation.
5. To recall stored readings, press RECALL. Use the RANGE keys to scroll through the buffer.

## Burst mode

The burst data acquisition mode maximizes the reading rate of the Model 2002. With burst mode, new raw readings (A/D counts) are acquired and then post-processed by applying calibration constants. If filter or math operations are enabled, the post-processing time is longer.

The following configuration restrictions apply for burst mode:

- Only the following measurement functions are valid in burst mode:
  - DCV (normal)
  - ACV (RMS or average)
  - DCI (normal)
  - ACI (RMS or average)
  - $\Omega^2$  (normal)
- The trigger event source in the measure layer must be set for immediate, external, trigger link or timer. Also, any “multiple displays” and scanning must be disabled.

**NOTE** *BENCH reset sets the trigger event source to immediate, and disables “multiple displays” and scanning (see BENCH DEFAULTS).*

When burst mode is selected, the instrument is temporarily configured to take fast measurements; autoranging is disabled, integration time is set to 0.01 PLC (167 $\mu$ sec), resolution is fixed at 4.5 digits, buffer data group is set for compact, and buffer control is set to fill-and-stop.

Perform the following steps to perform burst data storage:

1. Configure the instrument’s function, range and triggering to be compatible with burst mode.
2. Press CONFIG and then STORE to display the CONFIG DATA STORE menu.
3. Using the cursor keys (◀ and ▶), select BURST-MODE and press ENTER.

**NOTE** *Enabling burst mode clears the buffer.*

4. Select ON and press ENTER. If the instrument configuration is compatible with burst mode, this action displays the buffer size, places the unit in idle, and takes it out of autorange.
5. Use the cursor and RANGE keys to change the buffer size. With the desired buffer size displayed, press ENTER.
6. When ready, press TRIG to start the acquisition process. The ARM annunciator turns on when the raw readings are being acquired. The asterisk(\*) annunciator turns on when the readings are being post-processed. Both indicators turn off when post-processing is complete.
7. To recall stored readings, press RECALL. Use the RANGE keys to scroll through the buffer.

**NOTE** *For complete information on burst mode, see Section 2 of the User’s Manual.*

## Math

The MATH key lets you perform math operations on single readings and display the result. The three math calculations that are configured from the CONFIGURE MATH menu structure are:

**Polynomial:**

$$Y = (a2)X^2 + (a1)X + (a0)$$

where: X is the normal display reading  
a2, a1, and a0 are user entered constants  
Y is the displayed result

**Percent:**

$$Percent = \frac{Input\ Reading}{Target\ Value} \times 100$$

where: Input Reading is the normal display reading  
Target Value is the user entered constant  
Percent is the displayed result

**Percent Deviation:**

$$PD = \frac{(X - Y)}{Y} \times 100$$

where: X is the normal display reading  
Y is the REL value for the selected function  
PD is the displayed result (percent deviation)

## Selecting and configuring math

The procedure to select and configure a math calculation is summarized as follows:

1. Press CONFIG and then MATH to display the following math filter menu options:  
NONE: Select no calculation when the MATH key is pressed.  
POLYNOMIAL: Select the polynomial calculation and enter the constants (a2, a1, and a0).  
PERCENT: Select the percent calculation and enter the target value (reference).  
PERCENT DEVIATION: Select the percent deviation calculation.
2. Use the menu items to select and configure math. A menu item is selected by placing the cursor (using ◀ and ▶ keys) on it and pressing ENTER. Parameter values are changed using the cursor keys and the RANGE keys, and then pressing ENTER. See MENUS if you need more information to navigate through the menu structure.

## Enabling math

The selected math calculation is enabled by simply pressing the MATH key. When enabled, the MATH annunciator turns on and the calculation type (NONE, POLY, %, or % DEV) is displayed. Also, one of the following messages is briefly displayed:

Math Enabled  
Display = NONE (reading)

Math Enabled  
Display = POLY (reading)

Math Enabled  
Display = % (reading)

Math Enabled  
Display = % DEV (reading)

Math is disabled by pressing MATH a second time.

## Additional math operations

In addition to the math performed on single readings described above, the Model 2002 has these math operations:

- Math performed on buffered readings (maximum and minimum values, average, and standard deviation).
- Math performed on single readings as part of a pass/fail limits test.
- Math performed on scanned readings (ratio and delta).

**NOTE** Complete information on MATH is provided in Section 2 of the User's Manual.

**Figure 11**  
Combining math  
calculations

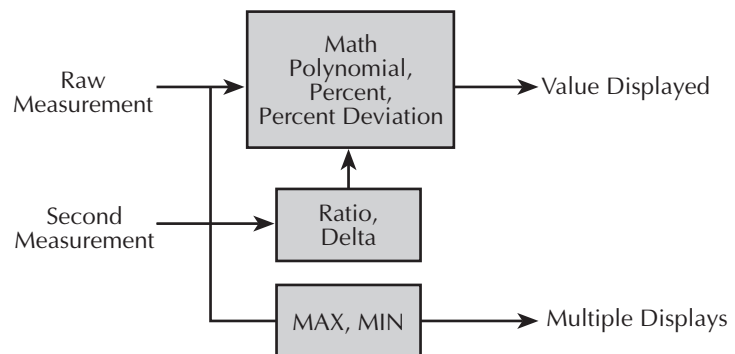

## Internal scanning

The Model 2002 can be used with a scanner card (such as the Model 2001-SCAN or 2001-TCSCAN) installed in the option slot of the instrument. This section provides basic information for scanning internal channels. If the scanner card is not already installed, refer to the scanner card instruction manual.

**NOTE** For complete information on scanning (internal and external), refer to Section 2 in the User's Manual, and the scanner card instruction manuals.

**NOTE** The following steps assume that the Model 2002 is set to the BENCH reset default conditions (see BENCH DEFAULTS).

**Figure 12**  
Model 2001-SCAN  
and Model  
2001-TCSCAN

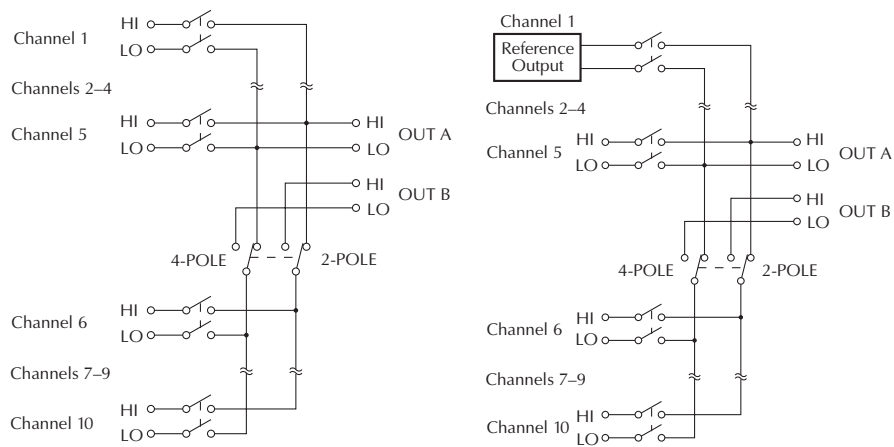

---

## Configure internal channels

A unique measurement function can be assigned to each of the internal scanner card channels. For example, DCV can be assigned to channels 1 and 2, and  $\Omega 2$  can be assigned to channels 3 and 4. Also, scanner card channels can be skipped during the scan by designating them as no channels (---).

Perform the following steps to configure internal channels:

1. Press CONFIG and then CHAN to display the CONFIGURE CHANNELS menu.
2. Using the cursor keys (◀ and ▶), select INTERNAL-CHANS and press ENTER to display the currently selected function for each channel.
3. Function assignments can be changed by placing the cursor on the channel and then using the RANGE keys (▲ and ▼) to display the desired function. Select “---” if you wish to skip the channel during the scan.
4. With the desired function assignments displayed, use the EXIT key to back out of the menu structure.

## Configure scan

Perform the following steps to configure the Model 2002 for an internal scan:

1. Press CONFIG and the SCAN to display the SCAN OPERATION menu options.
2. Use the cursor keys (◀ and ▶) to select INTERNAL and press ENTER.

## Perform the scan

Perform the following steps to scan internal channels:

1. Press SCAN to display the currently programmed scan count. The scan count specifies the number of scans to be performed.
2. To change the scan count, use the cursor keys (◀ and ▶) and RANGE keys (▲ and ▼). Press ENTER to continue.
3. You will then be asked if you wish to use the scan timer to provide a time interval between scans.
  - A. Yes – If you wish to use the scan timer, select YES and press ENTER to display the present interval (in seconds). To change the interval, use the cursor keys and RANGE keys. Press ENTER to continue.
  - B. No – If you do not wish to use the scan timer, select NO and press ENTER.
4. You will then be asked if you wish to store the readings in the buffer.
  - A. Yes – If you want to use the buffer, select YES and press ENTER. A message indicating how many readings will be stored in the buffer is displayed. Press ENTER to continue.
  - B. No – If you do not wish to use the buffer, select NO and press ENTER.
5. With the message “Press ENTER to begin” displayed, press ENTER to start the scan process. If using the buffer, readings can be recalled by pressing RECALL and using the RANGE keys to scroll through the data points.

## Close/Open channels

The CHAN key is used to close an internal channel or channel pair (for 4-wire functions), or open any internal closed channel or channel pair. Perform the following steps to close or open channels:

1. Press CHAN to display the following CHANNEL SELECTION options:  
CLOSE-CHANNEL: Use to close a channel or channel pair on the internal scanner card.  
OPEN-ALL-CHANNELS: Opens all channels on the scanner card.
2. Select the desired option and press ENTER. Selecting CLOSE-CHANNEL prompts you to enter the channel to be closed. Use the cursor keys and RANGE keys to display the channel number and press ENTER. The number of the closed channel will be displayed along with the reading.

**NOTE** *If a 4-wire function is selected, both the selected channel and the paired channel will close. Channel pairs are 1-6, 2-7, 3-8, 4-9 and 5-10.*



## Ratio and delta calculations

With RATIO or DELTA selected from the SCAN OPERATION menu, the Model 2002 can measure two specified internal scanner channels (reference channel and measure channel) and then compute the ratio or difference (delta) between them. Valid measurement functions for ratio and delta include DCV,  $\Omega 2$  and  $\Omega 4$ .

Ratio and delta are calculated as follows:

$$\text{Ratio} = \frac{\text{Measure}}{\text{Reference}}$$

$$\text{Delta} = \text{Measure} - \text{Reference}$$

Perform the following steps to perform ratio or delta calculations:

1. Select and configure ratio or delta as follows. Note that a menu item is selected by placing the cursor (using ◀ and ▶ keys) on it and pressing ENTER. See MENUS if you need more information to navigate through the menu structure.
  - Press CONFIG
  - Press SCAN
  - Select RATIO or DELTA
  - Select MEASURE
  - Select CH1, 2, 3, 4, 5, 6, 7, 8, 9 or 10
  - Select REFERENCE
  - Select CH1, 2, 3, 4, 5, 6, 7, 8, 9 or 10
  - Select FUNCTION
  - Select DCV,  $\Omega 2$  or  $\Omega 4$

Use the EXIT key to back out of the menu structure.

2. Press SCAN to halt triggers (instrument goes into idle).
3. To start ratio or delta measurements, press SCAN or TRIG. The displayed readings are the result of the ratio or delta calculation.
4. To stop ratio or delta measurements, press EXIT.

## External scanning

The Model 2002 can be used with a scanner card (such as the Model 7011 Multiplexer Card) installed in an external scanning mainframe (Model 7001 or 7002 Switch System). With the use of external triggering, the Model 2002 can measure and store each scanned channel.

**NOTE** For complete information on scanning (external and internal), refer to Section 2 in the User's Manual, and the switch system and scanner card instruction manual.

**NOTE** The following steps assume that the Model 2002 is set to the BENCH reset default conditions (see SETTING UP BENCH DEFAULTS) and the Model 7001/2 is set to the RESET default conditions.

### Trigger connections

If using Trigger Link, connect the Model 2002 to the switch system as shown in Figure 13. If using conventional external triggering, connect the instruments as shown in Figure 14. Detailed information on triggering is provided in Section 2 of the User's Manual.

**Figure 13**  
Trigger connections using trigger link

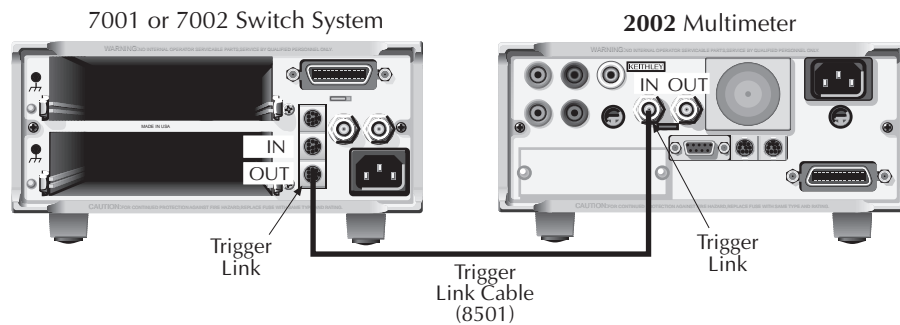

**Figure 14**  
Trigger connections using conventional external triggering

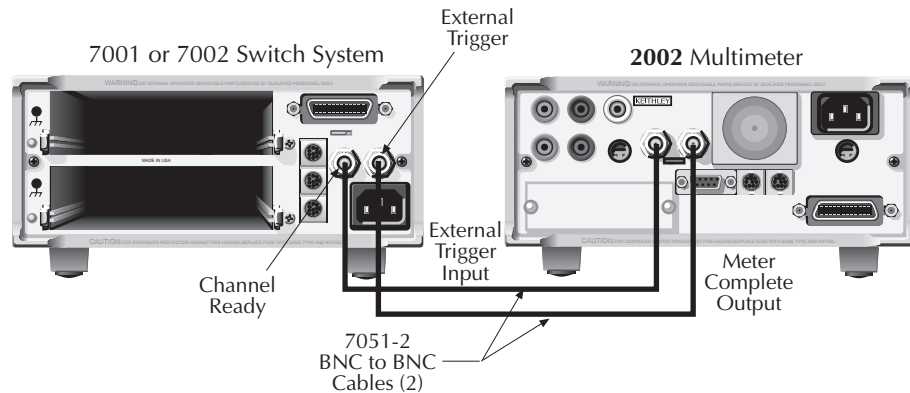

## Configure external channels

A unique measurement function can be assigned to each of the external scanner card channels. For example, DCV can be assigned to channels 1 and 2, and  $\Omega 2$  can be assigned to channels 3 and 4. Also, scanner card channels can be skipped during the scan by designating them as no channels (---).

Perform the following steps to configure external channels:

1. Press CONFIG and then CHAN to display the CONFIGURE CHANNELS menu options.
2. Using the cursor keys (◀ and ▶), select EXTERNAL-INPUTS and press ENTER to display the number of external inputs to be scanned.
3. Use the cursor keys and the RANGE keys to display the number of channels to be scanned and press ENTER. For example, if the scan list is going to consist of 10 channels, then set the number of external inputs to 10.
4. You will then have the opportunity to set a unique measurement function for each external channel.
  - A. DEFAULT – To assign the presently selected function to all external channels, select DEFAULT and press ENTER.
  - B. CHOOSE-FUNCTIONS – To change function assignments, perform the following steps:
    - a. Select CHOOSE-FUNCTIONS and press ENTER. You can use RANGE keys to check the present function assignment for each external channel.
    - b. To change a function assignment, use the RANGE keys to display the channel and press ENTER.
    - c. For the displayed channel, place the cursor on the desired function and press ENTER.
    - d. Repeat steps b and c for other channels.

- e. Use the EXIT key to back out of the menu structure.

## Configure scan

Perform the following steps to configure the Model 2002 for an external scan:

1. Press CONFIG and then SCAN to display the SCAN OPERATION menu options.
2. Use the cursor keys (◀ and ▶) to select EXTERNAL and press ENTER.

## Perform the scan

Perform the following steps to scan external channels. Note that menu items are selected by placing the cursor on it and pressing ENTER. A parameter value is changed by using the RANGE keys and pressing ENTER.

1. Model 2002 – Press SCAN to display the “CONFIG EXT SCANNER; Reset scanner” message.
2. Switch System – If not already done, reset the Model 7001/2 as follows:
  - Press MENU
  - Select SAVESETUP
  - Select RESET
  - Select ENTER
  - Select ENTER

Use the EXIT key to back out of the menu structure.

3. Model 2002 – Press ENTER to display the next message; “CONFIG EXT SCANNER; Set CHAN COUNT to infinite”.
4. Switch System – Set the channel count to infinite as follows:
  - Press SCAN
  - Select SELECT-CONTROL
  - Select NUMBER-OF-CHANS
  - Select CHAN-COUNT
  - Select INFINITE

Note: Do not exit from the menu structure after selecting an infinite channel count.

5. Model 2002 – Select the appropriate trigger source. If using the Trigger Link, select TRIGLINK. If you are instead using conventional external triggering, select EXTERNAL. The “CONFIG EXT SCANNER” message to set channel spacing for the Switch System will then be displayed.

6. Switch System – Set channel spacing as follows. Note that the message on the Model 2002 tells you which channel spacing option to select.
  - Select CHANNEL-SPACING
  - Select TRIGLINK or EXTERNAL

Use the EXIT key to back out of the menu structure.

7. Model 2002 – Press ENTER. The display will prompt you to define the scan list for the Switch System.
8. Switch System – Define the scan list.
9. Model 2002 – Press ENTER to display ‘CONFIG EXT SCANNER; STEP scanner to first channel’.
10. Switch System – Press STEP to close the first channel in the scan.
11. Model 2002 – Press ENTER to display the currently programmed scan count. The scan count specifies the number of scans to be performed. To change the scan count, use the cursor keys (◀ and ▶) and RANGE keys (▲ and ▼). Press ENTER to continue.
12. Model 2002 – You will then be asked if you wish to use the scan timer. The timer is used to provide a time interval between each scan. If you select YES, enter the interval (in seconds).
13. Model 2002 – You will then be asked if you wish to store the readings in the buffer. If you select YES, a message indicating the total number of readings to be stored in the buffer will be displayed. Press ENTER to continue.
14. Model 2002 – With the message “Press ENTER to begin” displayed, press ENTER to start the scan process.
15. After the scan is completed, options to recall readings or repeat the scan will be displayed:
  - RECALL-DATA – Select this option to recall readings. Use the cursor keys and the range keys to scroll through the buffer. When finished, press EXIT to return to the post-scan options.
  - SCAN-AGAIN – Use this option to repeat the scan.
  - EXIT – Use this option to disable the scan.

---

# 3 IEEE-488 Bus Operation

## Software support

Several support alternatives are available for the Model 2002. Contact your local Keithley representative for more detailed information.

### Keithley software subroutines in BASIC, C, and Pascal

To help users develop software faster, Microsoft QuickBASIC, Microsoft BASIC, Microsoft QuickC, and Borland TurboPascal subroutines are provided for several common functions: instrument setup, measurement acquisition, data storage, and data and graphical display. These subroutines can be used as-is to build applications programs, or can be easily translated to meet unique requirements, if desired.

### Keithley start-up package

A start-up package, based on the BASIC language subroutines, is also included to provide basic instrument operation in a simple context. This package can be used for acquiring data or can be modified to perform more specialized functions.

### IEEE-488 interfaces supported

Capital Equipment Corporation, any version (v3.01 or later) and KPC488.2  
National Instruments NI-488 for PCII or PCIIA, rev. C.11 or C.12  
National Instruments NI-488.2 for PCII/IIA or AT-GPIB, rev. 1.5  
IOtech Driver 488, at least v2.6

### MET/CAL™ 1 routines

Routines to calibrate (adjust and/or verify) the Model 2002 on a MET/CAL system are available free.

### Semi-automatic calibration program

For users with a PC who want to speed calibration, a program is available that prompts the operator through setup and calibration of the 2002.

### LabWindows® 2 drivers, LabView drivers

National Instruments has prepared drivers to operate in conjunction with this data acquisition package.

<sup>1</sup>MET/CAL™ is a trademark of the John Fluke Mfg. Co., Inc.

<sup>2</sup>LabWindows® is a trademark of National Instruments.

## IEEE-488 bus standards

For remote operation, the Model 2002 uses the IEEE-488 bus for communication between instrumentation and the controller (computer). The IEEE-488 bus is also known as the GPIB (General Purpose Interface Bus).

In addition to conforming to the IEEE-488-1978 and IEEE-488.1-1987 standards, the Model 2002 also conforms to the IEEE-488.2-1987 standard and the SCPI 1991 (Standard Commands for Programmable Instruments) standard. These two standards allow most instrument operations to be performed with the use of command commands and SCPI commands.

## IEEE-488 bus connections

The Model 2002 is connected to the IEEE-488 bus using a cable terminated with standard IEEE-488 connectors. Figure 15 shows a typical connection scheme for a multi-unit test system. Note that connectors can be stacked to accommodate the parallel connection scheme.

To minimize interference caused by electromagnetic radiation, only use shielded IEEE-488 cables, such as the Keithley Models 7007-1 and 7007-2.

*Figure 15*  
*IEEE-488 connections*

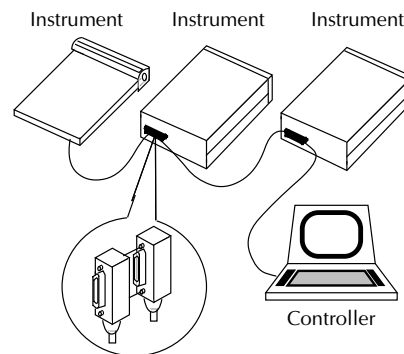



## Primary address selection

The Model 2002 is shipped from the factory with a programmed primary address of 16. The address is displayed on power-up. Programming examples in this manual assume a primary address of 16.

Perform the following steps to check and/or change the primary address:

1. Press MENU to display the MAIN MENU.
2. Place the cursor on GPIB and press ENTER to display the GPIB/PRINT SETUP options.
3. Place the cursor on ADDRESSABLE and press ENTER to display the primary address.
4. To change the address, use the cursor keys and the range keys to display the desired address and, press ENTER.

**NOTE** *Each device on the bus must have a unique address. Typically, the computer uses address 0 or 21.*

5. Use the EXIT key to back out of the menu structure.

## Common commands

Common commands are common to all IEEE-488 devices on the bus. The following information summarizes the Common commands that are used most often. For complete details, refer to Section 3 in the User's Manual.

### **\*CLS** (clear status)

Clears all event registers and Error Queue. After clearing an event register, you can monitor the register for a bit to set, indicating that an event (such as the buffer becoming full) has occurred.

### **\*SAV <NRf>** (save)

Saves the instrument setup to the specified memory location (0 to 9). The number of available memory locations depends on the memory option that is installed. With no extended memory, only location 0 is valid. With MEM1, locations 0 to 4 are valid. With MEM2, locations 0 to 9 are valid. Example: To save the setup to memory location 0, send \*SAV 0.

### **\*RCL <NRf>** (recall)

Returns the instrument to the instrument setup saved at the specified memory location. Example: To recall the setup saved at memory location 0, send \*RCL 0.

### **\*TRG** (trigger)

When a trigger model control source is set for BUS, event detection is satisfied by sending this bus trigger. For example, if instrument operation is waiting at the measure (trigger) layer control source and it is programmed for BUS events, \*TRG will provide the required event resulting in a device action (measurement).

### **\*WAI** (wait to continue)

This delay is used to allow the \*TRG or an initiate command (:INIT or :INIT:CONT ON) to finish before processing any further commands. An INITiate command is not considered finished until instrument operation returns to the idle state.

## SCPI commands

In the Model 2002 Multimeter, you are given access to control settings that are hidden on other instruments. The increased capability does, however, produce increased complexity. To accommodate this, the multimeter incorporates the Standard Commands for Programmable Instruments (SCPI) command set.

Because the instrument has more control points available, it requires more commands than its counterparts to perform comparable tasks. Also, since the command set is much larger than that of other instruments, finding the right commands to do the job is more difficult. Finally, SCPI command names are longer than command names in other instruments.

This introduction to the SCPI command set has three goals:

- Describe the syntax of SCPI commands. Included are descriptions of short forms and default nodes, which help reduce the amount of data sent to the instrument.
- Provide some simple programs to perform commonly used tasks.
- Describe the SCPI commands used in the example programs so you can modify the programs to suit your needs.

# SCPI command syntax

## Tree structure

SCPI commands are organized in a tree structure, similar to disk directories in computer operating systems. Each subdirectory is called a subsystem. For example, part of the `SENSe1` subsystem is listed below and shown in Figure 16.

```
[SENSe[1]]
:DATA?
:FUNCTion "<name>"
:VOLTage
:DC
  :RANGe
    [:UPPer] <n>
    :AUTO <Boolean> | ONCE
  :REFerence <n>
    :STATe <Boolean>
    :ACQuire
```

**Figure 16**  
Hierarchy of the  
example `SENSe1`  
commands

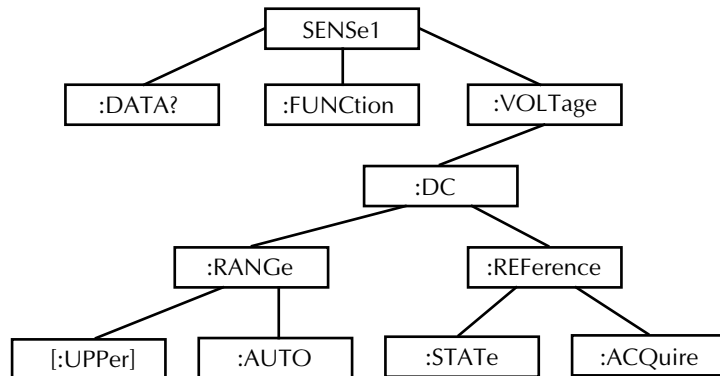

A command summary table is a way of documenting SCPI commands, but it does not show complete command names. A complete command is formed by joining the components. For example, the complete `:STATe` command in the example is:

```
SENSe1:VOLTage:DC:REFerence:STATe
```

Note that square brackets are not part of the command; they indicate optional parts of the command.

This hierarchical approach permits the same command to be used many times. For example, many subsystems contain a `:STATe` command, but each one is unique because the complete command is unique. This is analogous to having a file named `INDEX.TXT`, for example, in each directory of your computer's hard disk. Although the files have the same name, they are unique because they are each in a different directory.

## Long and short form commands

Every SCPI command has a short form, and most also have a long form. The notation used in documentation shows the short form in upper case, with the remainder of the name, which creates the long form, shown in lower case. There are no intermediate forms of the command name - you must send the exact short or long form. However, you do not have to use the mixed capitalization - the Model 2002 accepts commands in any combination of upper and lower case. For example, all of the following are valid forms of the `SENSe1:VOLTage:DC:REFerence` command:

```
sensel:voltage:dc:reference:state  
sens1:volt:dc:ref:stat  
SENS1:volt:DC:rEFErENCE:Stat
```

## Query commands

With few exceptions, every SCPI command has a corresponding query. A command sets a control point in the instrument; a query determines the present setting of the control point. The query is simply the command name with a "?" attached.

Some commands are actions rather than control point settings. These commands have no query form. For example,

```
SENSe1:VOLTage:DC:REFerence:ACQuire
```

is an action command, not a setting, and so has no query form.

There are some queries that have no corresponding command. For example, `SENSe1:DATA?` causes the instrument to return the latest reading. Of course, there is no corresponding command to send a reading value into the instrument.

## Default nodes

SCPI uses the concept of default nodes. Consider the example command tree shown previously in Figure 16. What is within square brackets is not necessary to send to the instrument, but the instrument will accept it if you send it. Consider the `:UPPer` command, which sets the measurement range. To set the Mode 2002 to measure 15VDC, any of the following commands works:

```
SENSe1:VOLTage:DC:RANGe:UPPer 15  
SENSe:VOLTage:DC:RANGe:UPPer 15  
SENSe1:VOLTage:DC:RANGe 15  
VOLTage:DC:RANGe:UPPer 15  
VOLTage:DC:RANGe 15
```

These are shown in long form, but short forms could also be used.

## Command syntax

Notice in the preceding examples that there is no colon character at the beginning of the commands. A leading colon instructs the Model 2002 to interpret the command starting at the root (highest level) of the command tree. Since the Model 2002 also starts at the root each time you send it a new command, the leading colon is not needed (although the instrument will accept it if you send it).

You can send multiple commands in a single message. You separate the commands with a semicolon character. When the Model 2002 encounters a command following a semicolon, it attempts to interpret the command starting at the level of the previous command, unless you precede the second command with a colon. For example, either of the following command strings programs the Model 2002 to the 20VDC range and uses 5VDC as a relative value (with the REFERENCE commands):

```
volt:dc:rang 20;ref 5;ref:stat on  
volt:dc:rang 20::volt:dc:ref 5::volt:dc:ref:stat on
```

The two command strings are treated identically by the Model 2002. In the first string when the instrument encounters ";ref 5", it notices the following:

- It is not the first command in the string.
- There is no leading colon on the command.
- The previous command was at the `VOLTage:DC` level.

Therefore, it interprets the command as if it were at the `VOLTage:DC` level.

---

## SCPI signal oriented commands

Signal oriented commands are used to acquire readings using a set of high-level instructions to control the measurement process. The two most commonly used commands are `:FETCh?` and `:MEASure?`. Details on all signal oriented commands are covered in Section 3 in the User's Manual.

### **:FETCh?**

This query command is used to request the latest post-processed reading. After sending this command and addressing the Model 2002 to talk, the reading will be sent to the computer. This command does not trigger a measurement, it simply requests the last available reading.

### **:MEASure[:<function>]?**

In general, this command places the instrument in the "one-shot" measurement mode (ARM indicator off), triggers a single measurement, and then performs a `:FETCh?`.

If you include the measurement function with this command, the instrument will first go to the specified function and then perform the one-shot measurement and query, as follows:

<code>:MEASure?</code>	Currently selected function
<code>:MEASure:VOLTage:DC?</code>	DCV function
<code>:MEASure:VOLTage:AC?</code>	ACV function
<code>:MEASure:CURREnt:DC?</code>	DCI function
<code>:MEASure:CURREnt:AC?</code>	ACI function
<code>:MEASure:RESistance?</code>	$\Omega$ 2 function
<code>:MEASure:FRESistance?</code>	$\Omega$ 4 function
<code>:MEASure:FREQUency?</code>	FREQ function
<code>:MEASure:TEMPerature?</code>	TEMP function



## SCPI subsystem commands

Detailed information on all SCPI commands are covered in the User's Manual. In this section, only the command used for basic operation are summarized.

### Defaults

```
:SYSTem
:PREset

:POSetup <name>
```

#### SYSTEM Subsystem

Set the 2002 to the system present defaults. Some of the selected defaults include: DCV, continuous triggers, normal speed (1.0 PLC), auto range and auto filter.

Select power-on setups: RST, PRESet or SAV0 through SAV9. Instrument will power up to the \*RST or system present defaults, or one of the \*SAV0 – \*SAV9 setups.

### Fresh readings

```
[ :SENSe[1]]
:DATA:FRESH?
```

#### SENSe Subsystem

Requests a “fresh” reading. This command will not request the same reading twice. If a new reading has already been triggered, this command will wait until the new reading is available.

```
:CALCulate[1]
:DATA:FRESH?
```

#### CALCulate Subsystem

Requests a “fresh” calculated reading. When CALC1 is enabled, sens:data:fres? is the reading before calculation and calc:data:fres? is the reading after calculation. When CALC1 is disabled, the readings are the same.

### Function configuration

```
[ :SENSe[1]]
:FUNCTION <name>
```

#### SENSe Subsystem

Select measurement function:

<name> = 'VOLTage:DC'	DCV function
'VOLTage:AC'	ACV function
'CURRent:DC'	DCI function
'CURRent:AC'	ACI function
'RESistance'	Ω2 function
'FRESistance'	Ω4 function
'FREQuency'	FREQ function
'TEMPerature'	TEMP function

<pre> :VOLTage:DC   :NPLC &lt;n&gt;     :AUTO &lt;b&gt; :RANGe   [:UPPer] &lt;n&gt;   :AUTO &lt;n&gt; :REFerence &lt;n&gt;   :STATe &lt;b&gt;   :ACQuire :DIGits &lt;n&gt;   :AUTO &lt;b&gt; :AVERage   [:STATe] &lt;b&gt;   :TCOnTrol &lt;name&gt;   :COUnT &lt;n&gt;   :AUTO &lt;b&gt; </pre>	<p>Path to configure DCV:</p> <p>Set speed: 0.01 to 10 PLC.</p> <p>Enable or disable auto NPLC.</p> <p>Path to configure measurement range:</p> <p>Specify expected reading to select range.</p> <p>Enable or disable auto range.</p> <p>Specify reference (rel): -1100 to +1100.</p> <p>Enable or disable reference (rel).</p> <p>Use input signal as reference (rel).</p> <p>Specify measurement resolution (see note 1).</p> <p>Enable or disable auto resolution.</p> <p>Path to control the filter (see note 2).</p> <p>Enable or disable the filter.</p> <p>Select filter type (MOVing or REPeat).</p> <p>Specify the filter count (1 to 100).</p> <p>Enable or disable auto filter.</p>
<pre> :VOLTage:AC   (DCV commands) :COUPLing &lt;name&gt; :DETECTOR   [:FUNCTion] &lt;name&gt;    :PWINDow &lt;n&gt; </pre>	<p>Path to configure ACV:</p> <p>The commands listed to configure DCV apply.</p> <p>Specify input coupling: AC or DC.</p> <p>Path to select AC type:</p> <p>Select AC type: RMS, AVERage, PEAK, LFRMS, NPEak or PPEak.</p> <p>Specify window in seconds (0.1 to 9.9) for NPEak or PPEak</p>
<pre> :CURRent:DC   (DCV commands) :METhod &lt;name&gt; </pre>	<p>Path to configure DCI:</p> <p>The commands listed to configure DCV apply.</p> <p>Select measure technique: NORMal, ICIRcuit.</p>
<pre> :CURRent:AC   (DCV commands) :COUPLing &lt;name&gt; :DETECTOR   [:FUNCTion] &lt;name&gt; </pre>	<p>Path to configure ACI:</p> <p>The commands listed to configure DCV apply.</p> <p>Specify input coupling: AC or DC.</p> <p>Path to select AC type:</p> <p>Select AC type: RMS or AVERage.</p>
<pre> :RESistance   (DCV commands) :OCOMPensated &lt;b&gt; </pre>	<p>Path to configure <math>\Omega 2</math>:</p> <p>The commands listed to configure DCV apply.</p> <p>Enable or disable offset compensation.</p>
<pre> :FRESistance   (DCV commands) :OCOMPensated &lt;b&gt; </pre>	<p>Path to configure <math>\Omega 4</math>:</p> <p>The commands listed to configure DCV apply.</p> <p>Enable or disable offset compensation.</p>

<pre> :FREQuency   :COUPLing &lt;name&gt;   :REFerence &lt;n&gt;     :STATe &lt;b&gt;     :ACQuire   :DIGits &lt;n&gt;   :SOURce &lt;name&gt;   :THReshold     :CURRent       :RANGe &lt;n&gt;       :LEVel &lt;n&gt;     :VOLTagE       :RANGe &lt;n&gt;       :LEVel &lt;n&gt;       :TTL </pre>	<p>Path to configure <b>FREQ</b>:</p> <p>Specify input coupling: AC or DC.  Specify reference (rel): 0 to 15e6.  Enable or disable reference (rel).  Use input signal as reference (rel).  Specify measurement resolution: 4 or 5.  Select source: <b>CURRent</b> or <b>VOLTagE</b>.  Path to configure threshold:  Path to set current threshold:  Specify range: 0 to 1.  Specify level: <math>\pm 60\%</math> of max signal level.  Path to configure voltage threshold:  Specify range: 0 to 1000.  Specify level: <math>\pm 60\%</math> of max signal level.  Set threshold to <b>TTL</b> level.</p>
<pre> :TEMPerature (DCV commands) :TRANsducer &lt;name&gt; :RTD   :TYPE &lt;name&gt;    :ALPHa &lt;Nrf&gt;   :BETA &lt;Nrf&gt;   :DELTA &lt;Nrf&gt;   :RZERo &lt;Nrf&gt; </pre>	<p>Path to configure <b>TEMP (RTD)</b>:</p> <p>DCV commands (except <b>:RANGe</b>) apply.  Select transducer: <b>RTD</b>, <b>FRTD</b> or <b>TCouple</b>.  Path to configure RTD measurements:  Select parameters: <b>PT385</b>, <b>PT3916</b>, <b>PT100</b>, <b>D100</b>, <b>F100</b>, or <b>USER</b>.  Specify alpha constant for <b>USER</b>: 0 to 0.01.  Specify beta constant for <b>USER</b>: 0 to 1.  Specify delta constant for <b>USER</b>: 0 to 5.  Specify rzero constant for <b>USER</b>: 0 to 1000.</p>

## Notes:

- Resolution (**:DIGits**) parameters:  
All functions except **FREQ** and **TEMP** — 3.5 to 8.5.  
**FREQ** — 4 to 5.  
**TEMP** — 4 to 7.
- An advanced filter is available for **DCV**, **ACV**, **DCI**, **ACI**,  $\Omega 2$ , and  $\Omega 4$ . Refer to the User's Manual to use the advanced filter.

## Measurement units (ACV and TEMP)

:UNIT	UNIT Subsystem
:TEMPerature <name>	Select units for TEMP: C, F, or K.
:VOLTage	Path to configure units for ACV:
:AC <name>	Select units for ACV: V, DB, or DBM.
:DB	Path to set dB reference voltage:
:REFerence <n>	Specify reference (volts): 0.001 to 750.
:DBM	Path to set dBm reference impedance:
:IMPedance <n>	Specify reference ( $\Omega$ ): 1 to 9999.

## Data store (Buffer)

:TRACe	TRACe Subsystem
:EGROup <name>	Select element group: FULL or COMPact.
:POINts <n>	Specify buffer size.
:FEED <name>	Select reading source: SENSE, CALCulate or NONE.
:CONTRol <name>	Select control mode and enable buffer: NEVer, NEXT, ALWAYS or PRETrigger.

Note: See User's Manual to use :PRETrigger.

## Open/close channels and scan

:ROUTE	ROUTE Subsystem
:CLOSE <list>	Close specified channel.
:STATE?	Query the closed channel.
:OPEN <list>	Open specified channel.
:OPEN:ALL	Open all channels.
:SCAN	Path to control scanning (see note):
[:INTernal] <list>	Specify internal scan list: 2 to 10 chans.
:EXTernal <list>	Specify external scan list: 2 to 80 chans.
:LSElect <name>	Enable the specified scan: INTernal, EXTernal, RA-Tio, DELTA or NONE (see note).

Note: See User's Manual to use :RATio and :DELTA.

## Trigger model

Performing a system preset (:SYSTEM:PRESet) configures the trigger model for typical instrument operation. After a system preset, many advanced operations can be accomplished using the initiate commands, :ABORT, and the trigger (measure) layer commands. All of the following commands are part of the Trigger Subsystem.

:INITiate	
[:IMMediate]	Take the instrument out of idle (ARM indicator on).
:CONTinuous <b>	Enable or disable continuous initiation.
:ABORT	Reset trigger system. Instrument stays in idle if continuous initiation is disabled (off).
:TRIGger	Path to configure the trigger layer:
:SOURce <name>	Select control source: IMMediate, TIMer, MANual, BUS, TLINK, EXTernal or HOLD.
:TIMer <n>	Set timer interval (sec): 0 to 9999999.999.
:DELay <n>	Set delay between measurements (sec) 0 to 999999.999.

## Status register

The status register structure of the Model 2002 lets you monitor and act upon numerous events that occur. Many programming decisions can be made by monitoring the Measurement Event Register and the Operation Event Register. See the User's Manual for details of the status registers.

:STATUS	STATUS Subsystem.
:MEASurement	Path for measurement status registers:
[:EVENT]?	Use to read the Measurement Event Register.
:OPERation	Path for operation status registers:
[:EVENT]?	Use to read the Operation Event Register.

When an event register is read, a decimal value is sent to the computer. The binary equivalent determines which bits in the register are set. For example, a decimal value of 33 indicates that bits B0 and B5 are set. An event register is cleared when it is read. Sending \*CLS clears all event registers.

Some of the more useful bits of these event registers are summarized as follows:

### Measurement Event Register

Bit B0 set = Reading Overflow  
Bit B5 set = Reading Available  
Bit B7 set = Buffer Available  
Bit B8 set = Buffer Half Full  
Bit B9 set = Buffer Full

### Operation Event Register

Bit B4 set = Measuring  
Bit B9 set = Calculating  
Bit B10 set = Idle

## Program examples

All examples presume QuickBASIC version 4.5 or higher and a CEC IEEE-488 interface card with CEC driver version 2.11 or higher, with the Model 2002 at address 16 on the IEEE-488 bus.

### Changing function and range

The Model 2002 has independent controls for each of its measurement functions. This means, for example, that autorange can be turned on for DC voltage while leaving it off for AC voltage.

Another difference is in the parameter to the range command. In our older instruments, a single number was used to denote each range. The parameter of the SCPI `RANGE` command is given as "the maximum value to measure." The instrument interprets this parameter and goes to the appropriate range. When you query the range with `RANGE?` the instrument sends back the full-scale value of its present range.

The following example program illustrates changing function and range. It sets the range for several functions, then takes readings on each of those functions.

Note that the Model 2002 rounds the range parameter to an integer before choosing the appropriate range. Sending `VOLTage:DC:RANGE 20.45` will set the Model 2002 to the 20V range.

```
'Example program to demonstrate changing function and range,  
'taking readings on various functions  
'For QuickBASIC 4.5 and CEC PC488 interface card  
  
'Edit the following line to where the QuickBASIC  
'libraries are on your computer  
'$INCLUDE: 'c:\qb45\ieeeqb.bi'  
  
'Initialize the CEC interface as address 21  
CALL initialize(21, 0)  
  
'Reset the SENSE1 subsystem settings, along with the trigger  
'model, each READ? will cause one trigger  
CALL SEND(16, "*rst", status%)  
  
'Set range for each function to measure  
CALL SEND(16, "volt:dc:rang .1", status%)  
CALL SEND(16, "volt:ac:rang 20", status%)  
CALL SEND(16, "res:rang 10e3", status%)  
  
'Switch to DC volts and take reading  
CALL SEND(16, "func 'volt:dc'::read?", status%)  
reading$ = SPACE$(80)  
CALL ENTER(reading$, length%, 16, status%)  
PRINT reading$  
  
'Switch to AC volts and take reading  
CALL SEND(16, "func 'volt:ac'::read?", status%)  
reading$ = SPACE$(80)  
CALL ENTER(reading$, length%, 16, status%)  
PRINT reading$  
  
'Switch to 2-wire ohms and take reading  
CALL SEND(16, "func 'res'::read?", status%)  
reading$ = SPACE$(80)  
CALL ENTER(reading$, length%, 16, status%)  
PRINT reading$
```



## One-shot triggering

Our older DMMs generally have two types of triggering: one-shot and continuous. In one-shot, each activation of the selected trigger source causes one reading. In continuous, the DMM is idle until the trigger source is activated, at which time it begins taking readings at a specified rate. Typical trigger sources are:

- IEEE-488 talk
- IEEE-488 Group Execute Trigger (GET)
- “X” command
- External trigger (rear panel BNC)

Arming the instrument to respond to triggers is implicit in the non-SCPI DMMs. Simply sending a command to a non-SCPI DMM to change any of the trigger controls causes the instrument to arm itself for triggers.

The SCPI trigger model implemented in the Model 2002 gives you:

- Explicit control over the trigger source (the TRIGger subsystem).
- A two-level control for arming the instrument for triggers.
- A way for completely disabling triggers.

Changing any of the settings in the TRIGger subsystem does not automatically arm the Model 2002 for triggers.

The following program sets up the Model 2002 to take one reading each time it receives an external trigger pulse.

```
'Example program to demonstrate one-shot external triggering
'For QuickBASIC 4.5 and CEC PC488 interface card

'Edit the following line to where the QuickBASIC
'libraries are on your computer
'$INCLUDE: 'c:\qb45\ieeqb.bi'

'Initialize the CEC interface as address 21
CALL initialize(21, 0)

'Reset controls in INIT, ARM:LAY1, ARM:LAY2, and TRIG subsystems
'and put trigger model in IDLE state
CALL SEND(16, "*rst", status%)

CALL SEND(16, "trig:sour ext;coun inf", status%)

'start everything
CALL SEND(16, "init", status%)
```

After the Model 2002 receives the INITiate command, it stops in the TRIGger layer of the trigger model, waiting for a pulse on the external trigger jack. Each time a pulse arrives on the external trigger jack, the Model 2002 takes one reading. Because TRIGger:COUNT has been set to INFINITY, the trigger model never exits from the TRIGger layer. You can send the ABORT command to put the trigger model in the idle state, disabling triggers until another INITiate command is sent.

## Continuous triggering #1

The following example program sets up the Model 2002 to take readings as fast as it can once it receives an external trigger. The actual reading rate will depend upon other factors, such as A/D integration time, autozero mode, autorange on/off, etc.

```
'Example program to demonstrate continuous triggering
'For QuickBASIC 4.5 and CEC PC488 interface card

'Edit the following line to where the QuickBASIC
'libraries are on your computer
'$INCLUDE: 'c:\qb45\ieeeqb.bi'

'Initialize the CEC interface as address 21
CALL initialize(21, 0)

'Reset controls in INIT, ARM:LAY1, ARM:LAY2, and TRIG subsystems
'and put trigger model in IDLE state
CALL SEND(16, "*rst", status%)

'*RST sets TRIG:SOUR to IMM
CALL SEND(16, "arm:lay2:sour ext", status%)
CALL SEND(16, "trig:coun inf", status%)

'start everything
CALL SEND(16, "init", status%)
```

After the Model 2002 receives the INITiate command, it stops in ARM:LAYer2 of the trigger model, waiting for a pulse on the external trigger jack. After the external trigger signal occurs, the Model 2002 moves to the TRIGger layer. Since TRIGger:SOURce is set to IMMEDIATE, a reading is triggered immediately, with a subsequent reading triggered as soon as the previous one is finished.

## Continuous triggering #2

The following example program sets up the Model 2002 to take readings continuously after an external trigger is received. The trigger rate is set to one reading every 50ms.

```
'Example program to demonstrate continuous triggering
'at a specified rate
'For QuickBASIC 4.5 and CEC PC488 interface card

'Edit the following line to where the QuickBASIC
'libraries are on your computer
'$INCLUDE: 'c:\qb45\ieeegb.bi'

'Initialize the CEC interface as address 21
CALL initialize(21, 0)

'Reset controls in INIT, ARM:LAY1, ARM:LAY2, and TRIG subsystems
'and put trigger model in IDLE state
CALL SEND(16, "*rst", status%)

'*RST sets TRIG:SOUR to IMM
CALL SEND(16, "arm:lay2:sour ext", status%)
CALL SEND(16, "trig:coun inf;sour tim;tim .05", status%)

'start everything
CALL SEND(16, "init", status%)
```

After the Model 2002 receives the INITiate command, it stops in ARM:LAYer2 of the trigger model, waiting for a pulse on the external trigger jack. After the external trigger signal occurs, the Model 2002 moves to the TRIGger layer. Since TRIGger:SOURce is set to TIMer, a reading is triggered immediately, with a subsequent reading every 50ms. Because TRIGger:COUNT has been set to infinity, the trigger model never exits from the TRIGger layer.

## Generating SRQ on buffer full

When your program must wait until the Model 2002 has completed an operation, it is more efficient to program the 2002 to assert the IEEE-488 SRQ line when it is finished, rather than repeatedly serial polling the instrument. An IEEE-488 controller will typically address the instrument to talk, then unaddress it, each time it performs a serial poll. Repeated polling of the Model 2002 will generally reduce its overall reading throughput. Therefore, use the `srq%` function call.

The Model 2002 provides a status bit for nearly every operation it performs. It can be programmed to assert the IEEE-488 SRQ line whenever a status bit becomes true or false. The IEEE-488 controller (your computer) can examine the state of the the SRQ line without performing a serial poll, thereby detecting when the 2002 has completed its task without interrupting it in the process.

The following example program segment sets up the Model 2002 to assert SRQ when the reading buffer has completely filled, then arms the reading buffer, initiates readings, and waits for the Model 2002 to indicate that the buffer is full.

This is not a complete program. Not shown are the commands to configure the trigger model and the reading buffer (see the next example). The example shown here can be modified for any event in the Model 2002 status reporting system.

```
'Reset STATUS subsystem (not affected by *RST)
CALL SEND(16, "stat:pres;*cls", status%)

CALL SEND(16, "stat:meas:enab 512", status%)'enable BFL
CALL SEND(16, "*sre 1" status%)'enable MSB
CALL SEND(16, "trac:feed:cont next", status%)

' Start everything
CALL SEND(16, "init", status%)

WaitSRQ:
IF (NOT(srq%())) THEN GOTO WaitSRQ
CALL SPOLL(16, poll%, status%)
IF (poll% AND 64)=0 THEN GOTO WaitSRQ
```

Notice that after the program has detected an asserted SRQ line, it serial polls the Model 2002 to determine if it is the device requesting service. This is necessary for two reasons:

- Serial polling the Model 2002 causes it to quit asserting the SRQ line.
- In test systems that have more than one IEEE-488 instrument programmed to assert SRQ, your program must determine which instrument is actually requesting service.

Once an event register has caused a service request, it cannot cause another service request until you clear it by reading it (in this case using `STATUS:MEASUREMENT[:EVENT]?`) or by sending the `*CLS` command.

## Storing readings in buffer

The reading buffer in the Model 2002 is flexible and capable. It has four controls, which are found in the TRACe subsystem. There are commands to control:

- The size of the buffer (in readings).  
TRACe:POINts <NRF>
- Whether or not extra data is stored with each reading (e.g., channel number, timestamp). Storing extra data reduces the maximum size of the buffer.  
TRACe:EGROup FULL include extra data  
TRACe:EGROup COMPact exclude extra data
- Where the data is coming from (before or after the CALCulate1 math post-processing).  
TRACe:FEED SENSE1 store unprocessed readings  
TRACe:FEED CALCulate1 store math processed readings
- Select buffer control mode.  
TRACe:FEED:CONTRol NEVER immediately stop storing readings  
TRACe:FEED:CONTRol NEXT start now, stop when buffer is full  
TRACe:FEED:CONTRol ALWays start now, never stop  
TRACe:FEED:CONTRol PRETrigger start now, stop when pretrigger is satisfied

The following example program sets up the Model 2002 to take 20 readings as fast as it can into the buffer, then reads the data back after the buffer has filled. The readings will be stored with the timestamp, etc., but the program reads back only the reading values and timestamp.

```
'Example program to demonstrate the reading buffer
'For QuickBASIC 4.5 and CEC PC488 interface card

'Edit the following line to where the QuickBASIC
'libraries are on your computer
'$INCLUDE: 'c:\qb45\ieeeqb.bi'

'Initialize the CEC interface as address 21
CALL initialize(21, 0)

'Reset controls in INIT, ARM:LAY1, ARM:LAY2, and TRIG subsystems
'and put trigger model in IDLE state
CALL SEND(16, "*rst", status%)

'Reset STATUS subsystem (not affected by *RST)
CALL SEND(16, "stat:pres;*cls", status%)
CALL SEND(16, "stat:meas:enab 512", status%)'enable BFL
CALL SEND(16, "*sre 1", status%)'enable MSB
CALL SEND(16, "trig:coun 20", status%)

'TRACe subsystem is not affected by *RST
CALL SEND(16, "trac:poin 20;egr full", status%)
CALL SEND(16, "trac:feed sens1;feed:cont next", status%)

'Start everything
CALL SEND(16, "init", status%)

'Initialize reading$ while the 2002 is busy taking readings
reading$ = SPACE$(4000)

WaitSRQ:
IF (NOT(srq%)) THEN GOTO WaitSRQ
CALL SPOLL(16, poll%, status%)
IF (poll% AND 64)=0 THEN GOTO WaitSRQ

CALL SEND(16, "form:elem read,time", status%)
CALL SEND(16, "trac:data?", status%)
CALL ENTER(reading$, length%, 16, status%)
PRINT reading$
```

## Taking readings with the scanner card

The Model 2001-SCAN is an optional 10-channel scanner card for the Model 2002 Multimeter. Only one channel can be closed at a time. If you close a channel while another is already closed, the first one opens with break-before-make operation.

You can use the scanner card two ways. One is to issue a command to close a particular channel before sending other commands to take readings. The other way is to program the scan list, and let the meter take care of closing a channel before taking a reading. There is a fundamental difference in the instrument's behavior in these two approaches.

In the scan list, a measurement function is bound to each channel, so that when the next channel in the list closes, the meter switches to the associated function. Simply sending a channel close command, however, does not change the measurement function. While using the scan list, the meter responds to a trigger by first going to the next channel in the list, then switching to the function bound to that channel, before taking a reading.

The following example program measures DC volts on channel 1, AC volts on channel 2, and 2-wire resistance on channel 3, using the `ROUTE:CLOSE` command.

```
'Example program to demonstrate taking readings on different
'scanner channels
'For QuickBASIC 4.5 and CEC PC488 interface card

'Edit the following line to where the QuickBASIC
'libraries are on your computer
'$INCLUDE: 'c:\qb45\ieeeqb.bi'

'Initialize the CEC interface as address 21
CALL initialize(21, 0)

'Reset controls in INIT, ARM:LAY1, ARM:LAY2, and TRIG subsystems
'and put trigger model in IDLE state, set function to DCV
CALL SEND(16, "*rst", status%)

'Close channel 1, take DC voltage reading
CALL SEND(16, "rout:clos (@1);:read?", status%)
reading$ = SPACE$(80)
CALL ENTER(reading$, length%, 16, status%)
PRINT reading$

'Close channel 2, take AC voltage reading
CALL SEND(16, "func 'volts:ac'", status%)
CALL SEND(16, "rout:clos (@2);:read?", status%)
reading$ = SPACE$(80)
CALL ENTER(reading$, length%, 16, status%)
PRINT reading$

'Close channel 3, take ohms reading
CALL SEND(16, "func 'res'", status%)
CALL SEND(16, "rout:clos (@3);:read?", status%)
reading$ = SPACE$(80)
CALL ENTER(reading$, length%, 16, status%)
PRINT reading$
```



The following example program sets up the Model 2002 using a scan list to measure DC voltage on channel 1, AC voltage on channel 2, and 2-wire resistance on channel 3. The meter takes ten sets of readings, with each set spaced 15 seconds apart, and each of the three readings in each group taken as fast as possible. The Model 2002 stores the readings in the buffer, and asserts SRQ when the buffer is full. The program waits for the SRQ, then reads the readings from the buffer.

```
'Example program to demonstrate using the scan list
'For QuickBASIC 4.5 and CEC PC488 interface card

'Edit the following line to where the QuickBASIC
'libraries are on your computer
'$INCLUDE: 'c:\qb45\ieeegb.bi'

'Initialize the CEC interface as address 21
CALL initialize(21, 0)

'Reset controls in INIT, ARM:LAY1, ARM:LAY2, and TRIG subsystems
'and put trigger model in IDLE state, set function to DCV
CALL SEND(16, "*rst", status%)

'Reset STATUS subsystem (not affected by *RST)
CALL SEND(16, "stat:pres;*cls", status%)

CALL SEND(16, "stat:meas:enab 512", status%)'enable BFL
CALL SEND(16, "*sre 1", status%)'enable MSB
```

```
'*RST sets TRIG:SOUR to IMM
CALL SEND(16, "trig:coun 3", status%)
CALL SEND(16, "arm:lay2:sour tim;tim 15", status%)
CALL SEND(16, "arm:lay2:coun 10", status%)

'TRACe subsystem is not affected by *RST
CALL SEND(16, "trac:poin 30;egr full", status%)
CALL SEND(16, "trac:feed sensl;feed:coun next", status%)
' now the buffer is armed

CALL SEND(16, "rout:scan (@1:3)", status%)
CALL SEND(16, "rout:scan:func (@1), 'volt:dc'", status%)
CALL SEND(16, "rout:scan:func (@2), 'volt:ac'", status%)
CALL SEND(16, "rout:scan:func (@3), 'res'", status%)
CALL SEND(16, "rout:lssel int", status%)

'Start everything
CALL SEND(16, "init", status%)

'Initialize reading$ while the 2002 is busy taking readings
reading$ = SPACE$(2500)

WaitSRQ:
IF (NOT(srq%())) THEN GOTO WaitSRQ
CALL SPOLL(16, poll%, status%)
IF (poll% AND 64)=0 THEN GOTO WaitSRQ

CALL SEND(16, "form:elem read,time,chan", status%)
CALL SEND(16, "trac:data?", status%)
CALL ENTER(reading$, length%, 16, status%)
PRINT reading$
```

---

# 4 Specs and Accessories

## Specifications

The following pages contain the condensed specifications for the 2002. Every effort has been made to make these specifications complete by characterizing its performance under the variety of conditions often encountered in production, engineering, and research.

The 2002 provides transfer, 24-hour, 90-day, 1-year, and 2-year specifications, with full specifications for the 90-day, 1-year, and 2-year intervals. This allows the operator to utilize 90-day, 1-year, or 2-year recommended calibration intervals, depending upon the level of accuracy desired. As a general rule, the 2002's 2-year performance exceeds a 6½-digit DMM's 90-day, 180-day, or 1-year specifications.

### Absolute accuracy

All DC specifications are given as relative accuracies. To obtain absolute accuracies, the absolute uncertainties of the calibration sources must be added to the relative accuracies. The absolute uncertainties for the calibration sources used during Keithley's factory calibration are included in the specifications. The uncertainties of the operator's sources may be different.

All AC specifications are given as absolute accuracies.

### Typical accuracies

Accuracy can be specified as typical or warranted. All specifications shown are warranted unless specifically noted. Almost 99% of the 2002's specifications are warranted specifications. In some cases it is not possible to obtain sources to maintain traceability on the performance of every unit in production on some measurements (e.g., high-voltage, high-frequency signal sources with sufficient accuracy do not exist). These values are listed as typical.

**DC VOLTS**  
**DCV INPUT CHARACTERISTICS AND ACCURACY**

ENHANCED ACCURACY<sup>1</sup> - 10PLC, DFILT 10

RANGE	FULL SCALE	RESOLUTION	INPUT RESISTANCE	RELATIVE ACCURACY ±(ppm of reading + ppm of range)					TEMP. COEFFICIENT*
				Transfer <sup>5</sup>	24 Hours <sup>2</sup>	90 Days <sup>3</sup>	1 Year <sup>3</sup>	2 Years <sup>3</sup>	
200 mV <sup>4</sup>	±210.000000	1 nV	>100 GΩ	0.4 + 1.5	3.5 + 3	15 + 8	19 + 9	23 + 10	2 + 1.8
2 V <sup>4</sup>	±2.10000000	10 nV	>100 GΩ	0.2 + 0.15	1.2 + 0.3	6 + 0.8	10 + 0.9	14 + 1	0.2 + 0.18
20 V	±21.0000000	100 nV	>100 GΩ	0.1 + 0.05	1.2 + 0.1	6 + 0.15	10 + 0.15	14 + 0.15	0.3 + 0.02
200 V	±210.000000	1 μV	10 MΩ ±1%	0.5 + 0.08	5 + 0.4	14 + 2	22 + 2	30 + 2	1.5 + 0.3
1000 V <sup>6</sup>	±1100.00000	10 μV	10 MΩ ±1%	1 + 0.05	5 + 0.08	14 + 0.4	22 + 0.4	30 + 0.4	1.5 + 0.06

\* ± (ppm of reading + ppm of range)/°C Outside T<sub>CAL</sub> ± 5°C

1. Specifications are for 10 power line cycles, synchronous autozero, 10-reading repeat digital filter, autorange off, except as noted.
2. For TCAL ±1°C, following 4-hour warm-up. TCAL is ambient temperature at calibration (23°C at the factory). Add 0.5 ppm of reading uncertainty if the unit is power cycled during this interval.
3. For TCAL ±5°C, following 4-hour warm-up.
4. Care must be taken to minimize thermal offsets due to operator cables.
5. Specifications apply for 20-reading repeat digital filter, TREF ± 0.5°C (TREF is the initial ambient temperature), and for measurements within 10% of the initial measurement value and within 10 minutes of the initial measurement time.
6. Add 2.5ppm × (VIN/1000V)<sup>2</sup> additional uncertainty for inputs above 200V, except in transfer accuracy specifications.

DC VOLTAGE UNCERTAINTY = ± [ (ppm of reading) × (measured value) + (ppm of range) × (range used) ] / 1,000,000.

% ACCURACY = (ppm accuracy) / 10,000.

1PPM OF RANGE = 20 counts for ranges up to 200V and 10 counts on 1000V range at 7½ digits.

**KEITHLEY FACTORY CALIBRATION UNCERTAINTY**

RANGE	ppm of reading
200 mV	3.2
2 V	3.2
20 V	2.6
200 V	2.6
1000 V	2.6

Factory calibration uncertainty represents traceability to NIST. This uncertainty is added to relative accuracy specifications to obtain absolute accuracies. The 200mV and 2V range uncertainties are equal to the uncertainty of the 2V calibration source. The 20V, 200V, and 1000V range uncertainties are equal to the uncertainty of the 20V calibration source.

**AC VOLTS**

**NORMAL MODE RMS<sup>1</sup>**

90 Days, 1 Year or 2 Years, ±2°C from last AC self-cal for 1% to 100% of range<sup>2</sup>, ±(% of reading + % of range)

RANGE	±(% of reading + % of range)									
	20–50Hz	50–100Hz	0.1–2kHz	2–10kHz	10–30kHz	30–50kHz	50–100kHz	100–200kHz	0.2–1MHz	1–2MHz
200 mV	0.25+0.015	0.07+0.015	0.02 + 0.01	0.02 + 0.01	0.025 + 0.01	0.05 + 0.01	0.17+0.015	0.5+0.025	2+0.1	5+0.2
2 V	0.25+0.015	0.07+0.015	0.02 + 0.01	0.02 + 0.01	0.025 + 0.01	0.05 + 0.01	0.17+0.015	0.5+0.025	2+0.1	5+0.2
20 V	0.25+0.015	0.07+0.015	0.03+0.015	0.04+0.015	0.05 +0.015	0.07+0.015	0.17+0.015	0.5+0.025	4+0.2	7+0.2 <sup>4</sup>
200 V <sup>3</sup>	0.25+0.015	0.07+0.015	0.03+0.015	0.04+0.015	0.05 +0.015	0.07+0.015	0.17+0.015	0.5+0.025 <sup>4</sup>	4+0.2 <sup>4</sup>	
750 V <sup>3</sup>	0.25+0.015	0.1 +0.015	0.05+0.015	0.06+0.015	0.08 +0.015	0.1+0.015 <sup>4</sup>	0.5 +0.015 <sup>4</sup>			

1. Specifications apply for sinewave input, AC + DC coupling, 1 power line cycle, autozero on, digital filter off, following 55-minute warm-up.
2. For 1% to 5% of range below 750V range, and for 1% to 7% of 750V range, add 0.01% of range uncertainty. For inputs from 200kHz to 2MHz, specifications apply above 10% of range.
3. Add 0.001% of reading × (VIN/100V)<sup>2</sup> additional uncertainty above 100V rms.
4. Typical values.

**OHMS****ENHANCED ACCURACY<sup>1</sup> - 10PLC, Offset comp. on, DFILT 10**

RANGE	Transfer <sup>5</sup>	RELATIVE ACCURACY ± (ppm of reading + ppm of range)				TEMPERATURE COEFFICIENT ± (ppm of reading + ppm of range) / °C Outside TCAL ±5°C
		24 Hours <sup>3</sup>	90 Days <sup>4</sup>	1 Year <sup>4</sup>	2 Years <sup>4</sup>	
20 Ω	2.5 + 3	5 + 4.5	15 + 6	17 + 6	20 + 6	2.5 + 0.7
200 Ω	2.5 + 2	5 + 3	15 + 4	17 + 4	20 + 4	2.5 + 0.5
2 kΩ	1.3 + 0.2	2.5 + 0.3	7 + 0.4	9 + 0.4	11 + 0.4	0.8 + 0.05
20 kΩ	1.3 + 0.2	2.5 + 0.3	7 + 0.4	9 + 0.4	11 + 0.4	0.8 + 0.05
200 kΩ	2.5 + 0.4	4.5 + 0.5	17 + 0.8	21 + 0.9	25 + 1	3 + 0.18
2 MΩ	5 + 0.2	10 + 0.3	38 + 0.5	50 + 0.5	62 + 0.5	6 + 0.1
20 MΩ <sup>2</sup>	15 + 0.1	50 + 0.2	175 + 0.6	250 + 0.6	300 + 0.6	20 + 0.1
200 MΩ <sup>2</sup>	50 + 0.5	150 + 1	500 + 3	550 + 3	600 + 3	80 + 0.5
1 GΩ <sup>2</sup>	250 + 2.5	750 + 5	2000 + 15	2050 + 15	2100 + 15	400 + 2.5

- Specifications are for 10 power line cycles, 10-reading repeat digital filter, synchronous autozero, autorange off, 4-wire mode, offset compensation on (for 20Ω to 20kΩ ranges), except as noted.
- For 2-wire mode.
- For TCAL ±1°C, following 4-hour warm-up. TCAL is ambient temperature at calibration (23°C at the factory).
- For TCAL ±5°C, following 4-hour warm-up.
- Specifications apply for 20-reading repeat digital filter, TREF ± 0.5°C (TREF is the initial ambient temperature), and for measurements within 10% of the initial measurement value and within 10 minutes of the initial measurement time.

RESISTANCE UNCERTAINTY = ± [ (ppm of reading) × (measured value) + (ppm of range) × (range used) ] / 1,000,000.

% ACCURACY = (ppm accuracy) / 10,000.

1PPM OF RANGE = 20 counts for ranges up to 200MΩ and 10 counts on 1GΩ range at 7½ digits.

**KEITHLEY FACTORY CALIBRATION UNCERTAINTY**

RANGE	ppm of reading	
20 Ω	29.5	Factory calibration uncertainty represents traceability to NIST. This uncertainty is added to relative accuracy specifications to obtain absolute accuracies. The 20Ω - 2MΩ range uncertainties are equal to the uncertainty of the respective calibration sources. The 20MΩ, 200MΩ, and 1GΩ range uncertainties are equal to the uncertainty of the 2MΩ calibration source.
200 Ω	7.7	
2 kΩ	6.4	
20 kΩ	7.8	
200 kΩ	7.3	
2 MΩ	14.9	
20 MΩ	14.9	
200 MΩ	14.9	
1 GΩ	14.9	

**DC AMPS****DCI INPUT CHARACTERISTICS AND ACCURACY**

RANGE	FULL SCALE	RESOLUTION	MAXIMUM BURDEN VOLTAGE <sup>4</sup>	RELATIVE ACCURACY <sup>1</sup> ±(ppm of reading + ppm of range)				TEMPERATURE COEFFICIENT <sup>1</sup> ±(ppm of reading + ppm of range)/°C Outside TCAL ±5°C
				24 Hours <sup>2</sup>	90 Days <sup>3</sup>	1 Year <sup>3</sup>	2 Years <sup>3</sup>	
200 μA	210.00000	10 pA	0.25 V	50 + 6	275 + 25	350 + 25	500 + 25	50 + 5
2 mA	2.1000000	100 pA	0.3 V	50 + 5	275 + 20	350 + 20	500 + 20	50 + 5
20 mA	21.0000000	1 nA	0.35 V	50 + 5	275 + 20	350 + 20	500 + 20	50 + 5
200 mA	210.000000	10 nA	0.35 V	75 + 5	300 + 20	375 + 20	525 + 20	50 + 5
2 A	2.10000000	100 nA	1.1 V	350 + 5	600 + 20	750 + 20	1000 + 20	50 + 5

- Specifications are for 1 power line cycle, autozero on, 10-reading repeat digital filter.
- For TCAL ± 1°C, following 55-minute warm-up. TCAL is ambient temperature at calibration (23°C at the factory).
- For TCAL ± 5°C, following 55-minute warm-up.
- Actual maximum burden voltage = (maximum burden voltage) × (I MEASURED/I FULL SCALE).

DC CURRENT UNCERTAINTY = ± [ (ppm reading) × (measured value) + (ppm of range) × (range used) ] / 1,000,000.  
 % ACCURACY = (ppm accuracy) / 10,000.  
 5PPM OF RANGE = 10 counts at 6½ digits.

### DC IN-CIRCUIT CURRENT

The DC in-circuit current measurement function allows a user to measure the current through a wire or a circuit board trace without breaking the circuit.

When the In-Circuit Current Measurement function is selected, the 2002 will first perform a 4-wire resistance measurement, then a voltage measurement, and will display the calculated current.

**TYPICAL RANGES:**

- Current:** 100µA to 12A.
- Trace Resistance:** 1mΩ to 10Ω.
- Voltage:** ±200mV max. across trace.
- Speed:** 4 measurements/second at 1 power line cycle.
- Accuracy:** ±(5% +500µA). For 1 power line cycle, autozero on, 10-reading digital filter, TCAL±5°C, 90 days, 1 year or 2 years.

**MEASUREMENT RANGE CHART**

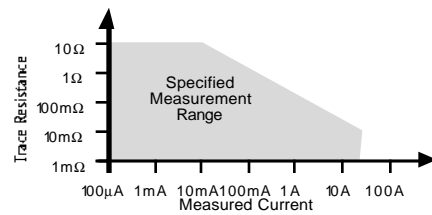

### AC AMPS

**ACI ACCURACY<sup>1,2</sup>**

**90 Days, 1 Year or 2 Years, TCAL ±5°C, for 5% to 100% of range, ±(% of reading + % of range)**

RANGE	20Hz–50Hz	50Hz–200Hz	200Hz–1kHz	1kHz–10kHz	10kHz–30kHz <sup>3</sup>	30kHz–50kHz <sup>3</sup>	50kHz–100kHz <sup>3</sup>
200 µA	0.35 + 0.015	0.2 + 0.015	0.4 + 0.015	0.5 + 0.015			
2 mA	0.3 + 0.015	0.15 + 0.015	0.12 + 0.015	0.12 + 0.015	0.25 + 0.015	0.3 + 0.015	0.5 + 0.015
20 mA	0.3 + 0.015	0.15 + 0.015	0.12 + 0.015	0.12 + 0.015	0.25 + 0.015	0.3 + 0.015	0.5 + 0.015
200 mA	0.3 + 0.015	0.15 + 0.015	0.12 + 0.015	0.15 + 0.015	0.5 + 0.015	1 + 0.015	3 + 0.015
2 A	0.35 + 0.015	0.2 + 0.015	0.3 + 0.015	0.45 + 0.015	1.5 + 0.015	4 + 0.015	

1. Specifications apply for sinewave input, AC+DC coupling, 1 power line cycle, autozero on, digital filter off, following 55-minute warm-up.
2. Add 0.005% of range uncertainty for current above 0.5A rms for self-heating.
3. Typical values.

AC CURRENT UNCERTAINTY = ±[ (% of reading) × (measured value) + (% of range) × (range used) ] / 100.  
 PPM ACCURACY = (% accuracy) × 10,000.  
 0.015% OF RANGE = 30 counts at 5½ digits.

### FREQUENCY COUNTER

**FREQUENCY/PERIOD INPUT CHARACTERISTICS AND ACCURACY 90 Days, 1 Year or 2 Years**

	FREQUENCY RANGE <sup>1</sup>	PERIOD RANGE	RESOLUTION	MINIMUM SIGNAL LEVEL <sup>2</sup>			MAXIMUM INPUT	TRIGGER LEVEL	ACCURACY ±(% of reading)
				1HZ–1MHz	1–5MHz	5–15MHz			
AC Voltage Input	1Hz–15 MHz	67 ns – 1 s	5 digits	60 mV	60 mV	350 mV	1100 V pk <sup>1</sup>	0–600V	0.03
AC Current Input	1Hz–1 MHz	1 µs – 1 s	5 digits	150 µA			1 A pk	0–600mA	0.03

1. Subject to 2 × 10<sup>7</sup>V•Hz product (for inputs above 20V).
2. Valid for the lowest range. For each range increase, multiply these numbers by 10.

TIME BASE: 7.68MHz ± 0.01%, 0°C to 55°C.

READING TIME: 420ms maximum.

VOLTAGE INPUT IMPEDANCE: 1MΩ ±2% with <140pF.

TRIGGER LEVEL ADJUSTMENT: Trigger level is adjustable in 0.5% of range steps to ±60% of range in real-time using the up and down range buttons.

FREQUENCY RANGING: Autoranging from Hz to MHz.

FREQUENCY COUPLING: AC + DC or AC only.

**TEMPERATURE (RTD)**

RANGE	RESOLUTION	4-WIRE ACCURACY <sup>3</sup>			
		24 Hours <sup>1</sup>	90 Days <sup>2</sup>	1 Year <sup>2</sup>	2 Years <sup>2</sup>
-100° to +100°C	0.001°C	±0.016°C	±0.020°C	±0.021°C	±0.022°C
-200° to +630°C	0.001°C	±0.061°C	±0.066°C	±0.068°C	±0.070°C
-148° to +212°F	0.001°F	±0.029°F	±0.036°F	±0.038°F	±0.040°F
-328° to +1166°F	0.001°F	±0.110°F	±0.119°F	±0.122°F	±0.126°F

1. For TCAL ± 1°C, following 4-hour warm-up.
2. For TCAL ± 5°C, following 4-hour warm-up.
3. Specifications are for 10 power line cycles, autozero on, 10 reading repeat digital filter, 4-wire mode. Exclusive of RTD probe errors.

RTD TYPE: 100Ω platinum, DIN 43760, 4-wire. ITS-90 (PT100, D100, F100) and IPTS-68 (PT385, PT3916).

SENSOR CURRENT: 960μA (pulsed).

TEMPERATURE COEFFICIENT: ± 0.001°C/°C or ± 0.002°F/°C outside TCAL ± 5°C.

MAXIMUM SOURCE HI LEAD RESISTANCE: 200Ω.

MAXIMUM SOURCE LO LEAD RESISTANCE: 100Ω.

**TEMPERATURE (Thermocouple)****THERMO-  
COUPLE**

TYPE	RANGE	RESOLUTION	ACCURACY <sup>1</sup>
J	-200° to +760°C	0.001°C	±0.5 °C
K	-200° to +1372°C	0.001°C	±0.5 °C
T	-200° to +400°C	0.001°C	±0.5 °C
E	-200° to +1000°C	0.001°C	±0.6 °C
R	0° to +1768°C	0.001°C	±3 °C
S	0° to +1768°C	0.001°C	±3 °C
B	+350° to +1820°C	0.001°C	±5 °C

1. Relative to external 0°C reference junction; exclusive of thermocouple errors. Junction temperature may be external. Applies for 90 days, 1 year or 2 years, TCAL ± 5°C.

**IEEE-488 BUS IMPLEMENTATION**

IMPLEMENTATION: IEEE-488.2, SCPI-1991.0.

MULTILINE COMMANDS: DCL, LLO, SDC, GET, GTL, UNT, UNL, SPE, SPD.

UNILINE COMMANDS: IFC, REN, EOI, SRQ, ATN.

INTERFACE COMMANDS: SH1, AH1, T5, TE0, L4, LE0, SR1, RL1, PP0, DC1, DT1, C0, E1.

**DIGITAL I/O**

CONNECTOR TYPE: 8 pin "D" subminiature.

INPUT: One pin, TTL compatible.

OUTPUTS: Four pins. Open collector, 30V maximum pull-up voltage, 100mA maximum sink current, 10Ω output impedance.

CONTROL: Direct control by output or set real-time with limits.



## GENERAL SPECIFICATIONS AND STANDARDS COMPLIANCE

### POWER

**Voltage:** 90–134V and 180–250V, universal self-selecting.

**Frequency:** 50Hz, 60Hz, or 400Hz, self-identifying at power-up.

**Consumption:** <5VA.

### ENVIRONMENTAL

**Operating Temperature:** 0°C to 50°C.

**Storage Temperature:** –40°C to 70°C.

**Humidity:** 80% R.H., 0°C to 35°C, per MIL-T-28800E<sup>1</sup> Para 4.5.5.1.2.

### CALIBRATION

**Type:** Software. No manual adjustments required.

**Sources:** 2 DC voltages, 6 resistances, and 5 DC currents. All other functions calibrated (adjusted) from these sources and a short circuit. No AC calibrator required for adjustment.

**Average Time to Perform:** 40 minutes for comprehensive calibration, 6 minutes for AC-only calibration.

**PROCESS:** MIL-STD 45662A.

### PHYSICAL

**Case Dimensions:** 90mm high × 214mm wide × 369mm deep (3½ in. × 8½ in. × 14½ in.).

**Working Dimensions:** From front of case to rear including power cord and IEEE-488 connector: 15.0 inches.

**Net Weight:** <4.2kg (<9.2 lbs.).

**Shipping Weight:** <9.1kg (<20lbs.).

### STANDARDS

**EMI/RFI:** Conforms to VDE 0871B (per Vfg 1046/1984), IEC 801-2. Meets FCC part 15 Class B, CISPR-22 (EN55022).

**Safety:** Conforms to IEC348, CAN/CSA-C22.2. No. 231, MIL-T-28800E<sup>1</sup>. Designed to UL1244.

### ACCESSORIES SUPPLIED

The unit is shipped with line cord, high performance modular test leads, manuals, option slot cover, and full calibration data.

Note 1: For MIL-T-28800E, applies to Type III, Class 5, Style E.

## Accessories available

### Rack kits

- 4288-1 Single Fixed Rack Mount Kit: Allows mounting on the right or left of a standard rack opening,
- 4288-2 Side-by-Side Rack Mount Kit: Allows two of the following instruments to be mounted side-by-side: 2001, 2002, 182, 428, 486, 487, 7001.
- 4288-3 Side-by-Side Rack Mount Kit: For mounting a Model 2001 or 2002 and Model 199.
- 4288-4 Side-by-Side Rack Mount Kit: For mounting a Model 2001 or 2002 and 5¼-in instruments (195A, 196, 220, 224, 230, 263, 595, 614, 617, 705, 750, 775, etc.) in a standard 19-in rack.

### General-purpose probes

- 1600A High Voltage Probe (not UL approved)
- 1651 50A Current Shunt (not UL approved)
- 1682A RF Probe (not UL approved)
- 1685 Clamp-On AC Current Probe (not UL approved)
- 1751 Safety Test Lead
- 1754 Universal Test Lead Kit
- 8604 SMD Probe Set
- 8605 High Performance Modular Test Leads (included)
- 8606 Performance Probe Tip Kit

### Temperature probes

- 1301 TC Temperature Probe (not UL approved)
- 8680 RTD Probe Adapter
- 8681 Miniature RTD Surface Probe
- 8693 General-Purpose Probe
- 8695 Surface Probe
- 8696 Air/Gas Probe

### Trigger-link cables

- 8501-1 Trigger-Link Cable, Micro DIN to Micro DIN (1 meter)
- 8501-2 Trigger-Link Cable, Micro DIN to Micro DIN (2 meter)
- 8502 Trigger-Link Adapter

**Additional cables**

8530	GPIB to Printer Cable, 2m (6.6 ft)
7007-1	Shielded GPIB Cable, 1m (3.3 ft)
7007-2	Shielded GPIB Cable, 2m (6.6 ft)
7051-2	BNC Trigger Interconnect Cable, 0.6m (2 ft)
7051-5	BNC Trigger Interconnect Cable, 1.5m (5 ft)
7051-10	BNC Trigger Interconnect Cable, 3m (10 ft)

**Service parts kits**

2002-SPARES KIT	Single Unit Spares Kit: An inexpensive kit of high mortality parts.
2002-MOD KIT	Single Unit Module Kit: A set of boards including digital boards, analog board cables and fuses.

**Four-wire probes**

5805	Kelvin Probes – Dual Pin Type, 0.9m (3 ft)
5805-12	Kelvin Probes – Dual Pin Type, 3.7m (12 ft)
5806	Kelvin Clip Lead Set, 0.9m (3 ft)
5807-7	Helical Spring Point Test Leads

**Low thermal probes**

8610	Low Thermal Shorting Plug
8611	Low Thermal Patch Leads (pair)
8612	Low Thermal Spade Leads (pair)

**Manuals**

2002-900-00	User's Manual
2002-902-00	Repair Manual
2002-905-00	Calibration Manual

**Additional optional equipment**

2001-SCAN	10-Channel Scanner Card
2001-TCSCAN	9-Channel Thermocouple Scanner Card
1050	Padded Carrying Case

---

# Index

## A

- Accessories 4-8
- Accuracy 4-2
- Amps fuse 1-7
- Annunciators 1-4
- Auto filter 2-16

## B

- Bench default 1-9, 2-13
- Buffer 3-23, 3-24
- Buffer (Data Store) 2-18
- Burst mode 2-19

## C

- Cables 4-9
- Channels 2-23, 2-24, 2-27, 3-15, 3-26, 3-28
- Command syntax 3-10
- Common commands 3-5
- Configuration settings 2-7
- CONFIGure menus 2-6
- Control source 2-12
- Counters 2-13
- Current measurements 1-11

## D

- Data store (Buffer) 3-15
- Delta 2-25
- Device action 2-13
- Digital I/O 1-7
- Display 1-8
- Display keys 1-5, 2-2

## E

- External scanning 2-26

## F

- Fan 1-7
- Filter 2-16
- Filter modes 2-16
- Filter types 2-16
- Frequency measurements 1-14
- Fresh readings 3-12
- Front panel 1-4
- Function keys 1-4

## I

- Idle 2-11
- IEEE-488 3-18
- IEEE-488 bus 3-3
- IEEE-488 connector 1-7
- IEEE-488.2 3-3
- Input connections 1-5, 1-7
- Inputs 1-5
- Internal scanning 2-22

## L

- Line fuse 1-7
- Long form 3-8

## M

- Main menu 2-6
- Manuals 4-9
- Math 2-20
- Measurement ranges 1-2
- Menus 2-6, 2-8
- Model 1801 Nanovolt Preamp 1-3
- Model 2001-SCAN 1-16, 2-22, 3-26
- Model 2001-SCAN Scanner Card 1-3
- Model 2001-TCSCAN 1-16, 2-22
- Model 2001-TCSCAN Thermocouple Scanner Card 1-3
- Model 7001 or 7002 Switch System 2-26
- Models 7007-1 and 7007-2 3-3
- Multiple displays 2-2

## O

- Operation keys 1-5
- Option card 1-3
- Option slot 1-7
- Output trigger 2-13

## P

- Percent 2-20
- Percent deviation 2-20
- Polynomial 2-20
- Power line input 1-7
- Power-up 1-8
- Primary address 3-4
- Product overview 1-2
- Program examples 3-18
- Probes 4-8, 4-9

## Q

- Query commands 3-9

## R

- Range keys 1-4
- Ratio 2-25
- Rear panel 1-6
- Relative 2-10
- Resistance measurements 1-12
- Resolution 2-15
- RTDs 1-16

## S

- Scanner card 1-16
- Scanning 2-22, 2-26
- SCPI 3-3, 3-6
- SCPI command syntax 3-7

---

## S

- SCPI signal oriented commands 3-11
- SCPI subsystem commands 3-12
- SENSe1 3-7
- Shielding 1-12
- Short form 3-8
- Software support 3-2
- Specifications 4-2
- Speed 2-14
- SRQ 3-23
- Status register 3-17

## T

- Temperature measurements 1-16
- Thermocouples 1-16
- Trigger 2-11
- Trigger level 1-15
- Trigger link 1-7, 4-8
- Trigger model 2-11, 3-16
- Triggering 3-20, 3-21, 3-22
- Voltage measurements 1-10

## W

- Warm-up 1-8

- 2001-SCAN 4-9

- 2001-TCSCAN 4-9

Model No. \_\_\_\_\_ Serial No. \_\_\_\_\_ Date \_\_\_\_\_

Name and Telephone No. \_\_\_\_\_

Company \_\_\_\_\_

List all control settings, describe problem and check boxes that apply to problem. \_\_\_\_\_

- |  |  |  |
|--|--|--|
| <input type="checkbox"/> Intermittent            | <input type="checkbox"/> Analog output follows display   | <input type="checkbox"/> Particular range or function bad; specify _____ |
| <input type="checkbox"/> IEEE failure            | <input type="checkbox"/> Obvious problem on power-up     | <input type="checkbox"/> Batteries and fuses are OK                      |
| <input type="checkbox"/> Front panel operational | <input type="checkbox"/> All ranges or functions are bad | <input type="checkbox"/> Checked all cables                              |

Display or output (check one)

- |   |  |
|---|--|
| <input type="checkbox"/> Drifts           | <input type="checkbox"/> Unable to zero                      |
| <input type="checkbox"/> Unstable         | <input type="checkbox"/> Will not read applied input         |
| <input type="checkbox"/> Overload         |  |
| <input type="checkbox"/> Calibration only | <input type="checkbox"/> Certificate of calibration required |
| <input type="checkbox"/> Data required    |  |

(attach any additional sheets as necessary)

Show a block diagram of your measurement system including all instruments connected (whether power is turned on or not). Also, describe signal source.

Where is the measurement being performed? (factory, controlled laboratory, out-of-doors, etc.)

\_\_\_\_\_

What power line voltage is used? \_\_\_\_\_ Ambient temperature?°F \_\_\_\_\_

Relative humidity? \_\_\_\_\_ Other? \_\_\_\_\_

Any additional information. (If special modifications have been made by the user, please describe.)

\_\_\_\_\_

**Be sure to include your name and phone number on this service form.**

Specifications are subject to change without notice.  
All Keithley trademarks and trade names are the property of Keithley Instruments, Inc.  
All other trademarks and trade names are the property of their respective companies.



A G R E A T E R M E A S U R E O F C O N F I D E N C E

**Keithley Instruments, Inc.**

**Corporate Headquarters** • 28775 Aurora Road • Cleveland, Ohio 44139 • 440-248-0400 • Fax: 440-248-6168 • 1-888-KEITHLEY • [www.keithley.com](http://www.keithley.com)