

# Series 2220 Multichannel Programmable DC Power Supplies

## User's Manual

2220S-900-01 Rev. C / December 2013



2220S-900-01C

A Greater Measure of Confidence

**KEITHLEY**  
A Tektronix Company



Series 2220  
Multichannel Programmable DC Power Supplies  
User's Manual

© 2013, Keithley Instruments, Inc.

Cleveland, Ohio, U.S.A.

All rights reserved.

Any unauthorized reproduction, photocopy, or use of the information herein, in whole or in part, without the prior written approval of Keithley Instruments, Inc. is strictly prohibited.

TSP<sup>®</sup>, TSP-Link<sup>®</sup>, and TSP-Net<sup>®</sup> are trademarks of Keithley Instruments, Inc. All Keithley Instruments product names are trademarks or registered trademarks of Keithley Instruments, Inc. Other brand names are trademarks or registered trademarks of their respective holders.

Document number: 2220S-900-01 Rev. C / December 2013



# Safety precautions

---

The following safety precautions should be observed before using this product and any associated instrumentation. Although some instruments and accessories would normally be used with nonhazardous voltages, there are situations where hazardous conditions may be present.

This product is intended for use by qualified personnel who recognize shock hazards and are familiar with the safety precautions required to avoid possible injury. Read and follow all installation, operation, and maintenance information carefully before using the product. Refer to the user documentation for complete product specifications.

If the product is used in a manner not specified, the protection provided by the product warranty may be impaired.

The types of product users are:

**Responsible body** is the individual or group responsible for the use and maintenance of equipment, for ensuring that the equipment is operated within its specifications and operating limits, and for ensuring that operators are adequately trained.

**Operators** use the product for its intended function. They must be trained in electrical safety procedures and proper use of the instrument. They must be protected from electric shock and contact with hazardous live circuits.

**Maintenance personnel** perform routine procedures on the product to keep it operating properly, for example, setting the line voltage or replacing consumable materials. Maintenance procedures are described in the user documentation. The procedures explicitly state if the operator may perform them. Otherwise, they should be performed only by service personnel.

**Service personnel** are trained to work on live circuits, perform safe installations, and repair products. Only properly trained service personnel may perform installation and service procedures.

Keithley Instruments products are designed for use with electrical signals that are measurement, control, and data I/O connections, with low transient overvoltages, and must not be directly connected to mains voltage or to voltage sources with high transient overvoltages. Measurement Category II (as referenced in IEC 60664) connections require protection for high transient overvoltages often associated with local AC mains connections. Certain Keithley measuring instruments may be connected to mains. These instruments will be marked as category II or higher.

Unless explicitly allowed in the specifications, operating manual, and instrument labels, do not connect any instrument to mains.

Exercise extreme caution when a shock hazard is present. Lethal voltage may be present on cable connector jacks or test fixtures. The American National Standards Institute (ANSI) states that a shock hazard exists when voltage levels greater than 30 V RMS, 42.4 V peak, or 60 VDC are present. A good safety practice is to expect that hazardous voltage is present in any unknown circuit before measuring.

Operators of this product must be protected from electric shock at all times. The responsible body must ensure that operators are prevented access and/or insulated from every connection point. In some cases, connections must be exposed to potential human contact. Product operators in these circumstances must be trained to protect themselves from the risk of electric shock. If the circuit is capable of operating at or above 1000 V, no conductive part of the circuit may be exposed.

Do not connect switching cards directly to unlimited power circuits. They are intended to be used with impedance-limited sources. NEVER connect switching cards directly to AC mains. When connecting sources to switching cards, install protective devices to limit fault current and voltage to the card.

Before operating an instrument, ensure that the line cord is connected to a properly-grounded power receptacle. Inspect the connecting cables, test leads, and jumpers for possible wear, cracks, or breaks before each use.

When installing equipment where access to the main power cord is restricted, such as rack mounting, a separate main input power disconnect device must be provided in close proximity to the equipment and within easy reach of the operator.

For maximum safety, do not touch the product, test cables, or any other instruments while power is applied to the circuit under test. ALWAYS remove power from the entire test system and discharge any capacitors before: connecting or disconnecting cables or jumpers, installing or removing switching cards, or making internal changes, such as installing or removing jumpers.

Do not touch any object that could provide a current path to the common side of the circuit under test or power line (earth) ground. Always make measurements with dry hands while standing on a dry, insulated surface capable of withstanding the voltage being measured.

For safety, instruments and accessories must be used in accordance with the operating instructions. If the instruments or accessories are used in a manner not specified in the operating instructions, the protection provided by the equipment may be impaired.

Do not exceed the maximum signal levels of the instruments and accessories, as defined in the specifications and operating information, and as shown on the instrument or test fixture panels, or switching card.

When fuses are used in a product, replace with the same type and rating for continued protection against fire hazard.

Chassis connections must only be used as shield connections for measuring circuits, NOT as protective earth (safety ground) connections.

If you are using a test fixture, keep the lid closed while power is applied to the device under test. Safe operation requires the use of a lid interlock.

If a  screw is present, connect it to protective earth (safety ground) using the wire recommended in the user documentation.

The  symbol on an instrument means caution, risk of danger. The user must refer to the operating instructions located in the user documentation in all cases where the symbol is marked on the instrument.

The  symbol on an instrument means caution, risk of electric shock. Use standard safety precautions to avoid personal contact with these voltages.

The  symbol on an instrument shows that the surface may be hot. Avoid personal contact to prevent burns.

The  symbol indicates a connection terminal to the equipment frame.

If this  symbol is on a product, it indicates that mercury is present in the display lamp. Please note that the lamp must be properly disposed of according to federal, state, and local laws.

The **WARNING** heading in the user documentation explains dangers that might result in personal injury or death. Always read the associated information very carefully before performing the indicated procedure.

The **CAUTION** heading in the user documentation explains hazards that could damage the instrument. Such damage may invalidate the warranty.

Instrumentation and accessories shall not be connected to humans.

Before performing any maintenance, disconnect the line cord and all test cables.

To maintain protection from electric shock and fire, replacement components in mains circuits — including the power transformer, test leads, and input jacks — must be purchased from Keithley Instruments. Standard fuses with applicable national safety approvals may be used if the rating and type are the same. Other components that are not safety-related may be purchased from other suppliers as long as they are equivalent to the original component (note that selected parts should be purchased only through Keithley Instruments to maintain accuracy and functionality of the product). If you are unsure about the applicability of a replacement component, call a Keithley Instruments office for information.

To clean an instrument, use a damp cloth or mild, water-based cleaner. Clean the exterior of the instrument only. Do not apply cleaner directly to the instrument or allow liquids to enter or spill on the instrument. Products that consist of a circuit board with no case or chassis (e.g., a data acquisition board for installation into a computer) should never require cleaning if handled according to instructions. If the board becomes contaminated and operation is affected, the board should be returned to the factory for proper cleaning/servicing.

Safety precaution revision of January 2013.

# Table of Contents

Preface .....	ii
Welcome .....	ii
Products .....	ii
Extended Warranty .....	iii
Contact Information .....	iii
CD-ROM Contents .....	iii
Key Features .....	iv
Getting Started .....	1
Standard Accessories .....	1
Optional Accessories .....	1
Available Services .....	2
Specifications .....	4
Operating Requirements .....	5
Front-panel Features .....	6
Rear-panel Features .....	10
Front-panel Operation .....	12
Installing the System .....	14
Cleaning .....	16
Operating Basics .....	17
Basic Settings .....	17
Menu Operations .....	18
User Settings .....	20
System Information .....	22
Configure The Instrument for Your Application .....	23
Connect to a Device Under Test .....	23
Index .....	

# Preface

## Welcome

Thank you for using a Keithley Instruments product. The Series 2200 Multichannel Programmable DC Power Supplies are flexible DC sources designed to power a wide range of applications. The model 2230-30-1 and its variants offer three power channels and the model 2220-30-1 and its variants provide two channels. The output channels on both models are independent and isolated, allowing you to power circuits with different references or polarities. Each channel can be enabled or disabled as your application requires. All outputs feature remote sense capability which can be used to reduce the effect of lead resistance, delivering 0.03% basic voltage accuracy even when using long leads. Basic current accuracy is 0.1% for all channels and linear regulation delivers low noise – less than 3 mVp-p. Flexible display modes make it easy to use the two 30 V outputs in combination, and the USB interface makes it easy to build PC-based systems without converters or special cables. The G versions of each model include a GPIB interface in combination with the USB interface.

These compact power supplies cover a wide range of applications without covering a lot of bench space. Versions of these power supplies are available for use at 100 VAC nominal line voltage which is common in Japan. These versions are indicated by the "J" suffix.

## Products

This manual contains information about the following products:

<b>Model</b>	<b>Description</b>
2220-30-1	Programmable Dual Channel DC Power Supply
2220G-30-1	Programmable Dual Channel DC Power Supply with GPIB Interface
2220J-30-1	Programmable Dual Channel DC Power Supply for Japan
2220GJ-30-1	Programmable Dual Channel DC Power Supply with GPIB Interface for Japan
2230-30-1	Triple Channel Programmable DC Power Supply
2230G-30-1	Programmable Triple Channel DC Power Supply with GPIB Interface
2230J-30-1	Triple Channel Programmable DC Power Supply for Japan
2230GJ-30-1	Programmable Triple Channel DC Power Supply with GPIB Interface for Japan



## Extended Warranty

Additional years of warranty coverage are available on many products. These valuable contracts protect you from unbudgeted service expenses and provide additional years of protection at a fraction of the price of a repair. Extended warranties are available on new and existing products. Contact your local Keithley Instruments representative for details.

## Contact Information

If you have any questions after reviewing this information, please use the following sources:

1. Keithley Instruments website (<http://www.keithley.com>)
2. Keithley web forum (<http://forum.keithley.com>)
3. Call Keithley Instruments corporate headquarters (toll-free inside the U.S. and Canada only) at 1-888-KEITHLEY (1-888-534-8453), or from outside the U.S. at +1-440-248-0400. For worldwide contact numbers, visit the Keithley Instruments website (<http://www.keithley.com>).

## CD-ROM Contents

A CD-ROM is shipped with each Series 2200 order. The Series 2200 Product Information CD-ROM contains:

- **User manual:** Includes a description of connections, operation information, and maintenance information. Users looking for basic operating information and an in-depth description of the way the instrument works (including troubleshooting and optimization) should refer to this manual.
- **Quick Start Front Panel and Programming Operation Guide:** Includes information about front panel operation and corresponding SCPI command codes to perform essential functions.
- **Specifications and performance verification manual:** Includes instrument specifications and procedures to verify that instrument accuracy is within the limits stated in the instrument's one-year accuracy specifications.
- **Programmer's manual:** Includes instrument programming information. Programmers looking for command references should refer to this manual.
- **PC Connectivity manual:** Includes instructions for installing software, drivers, and files to use LabVIEW SignalExpress Edition software to remotely acquire data and measurements from supported instruments.
- **Drivers and release notes:** IVI Instrument Driver, driver for National Instruments LabVIEW™, and related release notes; SignalExpress Step and related release notes.
- **Keithley I/O layer and release notes.**
- **Security and declassification instructions:** Includes information about how to sanitize and secure the instrument for customers with security concerns.

For the latest drivers and additional support information, see the Keithley Instruments website (<http://www.keithley.com>).

## Key Features

The Series 2200 instruments offer:

- Two 30 V at 1.5 A channels
- 6 V at 5 A, a third channel (2230 models only)
- 3-year factory warranty extendable to 5 years
- Linear regulation
- 0.03% Basic voltage accuracy
- 0.1% Basic current accuracy
- Less than 3 mV<sub>pp</sub> ripple and noise
- Remote sense to compensate for lead resistance
- 30 user-defined setup memories
- USB Device port on rear-panel for PC connectivity and remote programming; the G models include the GPIB interface along with the USB interface
- Works with National Instruments LabVIEW SignalExpress™ Tektronix Limited Edition Software which is available for download at [www.tektronix.com/downloads](http://www.tektronix.com/downloads)

# Getting Started

## Standard Accessories

For the current list of standard and optional accessories, upgrades, and options available for your power supply, visit the Keithley website, [www.Keithley.com](http://www.Keithley.com).

**Table 1: Standard accessories**

Accessory	Keithley part number
<b>Series 2200 Product Information CD-ROM.</b> You can view a list of the contents of this CD. (See page iii, <i>CD-ROM Contents</i> .)	2220S-950-01
Rear Panel Mating Connector with shorting clips for 2220-30-1 and 2230-30-1	CS-1655-15
Certificate of calibration	—
Power Cord <sup>1</sup>	<i>One of the following:</i>
	North America (Option A0). The factory sets the 110V/220V selector switch to 110 V.
	Universal Euro (Option A1). The factory sets the 110V/220V selector switch to 220 V.
	United Kingdom (Option A2). The factory sets the 110V/220V selector switch to 220 V.
	Australia (Option A3). The factory sets the 110V/220V selector switch to 220 V.
	Chile, Italy (Option A4). The factory sets the 110V/220V selector switch to 220 V.
	Switzerland (Option A5). The factory sets the 110V/220V selector switch to 220 V.
	Denmark (Option A7). The factory sets the 110V/220V selector switch to 220 V.
	Israel (Option A8). The factory sets the 110V/220V selector switch to 220 V.
	Argentina (Option A9). The factory sets the 110V/220V selector switch to 220 V.
	China (Option A10). The factory sets the 110V/220V selector switch to 220 V.
	India (Option A11). The factory sets the 110V/220V selector switch to 220 V.

<sup>1</sup> Models 2220J-30-1 and 2230J-30-1 come standard with a Japanese power cord. No other power cord options are available for these models.

## Optional Accessories

For the current list of standard and optional accessories, upgrades, and options available for your power supply, visit the Keithley website, [www.Keithley.com](http://www.Keithley.com).

**Table 2: Optional accessories**

Accessory	Keithley part number
Remote Sense Shorting Clip	344-0654-00
Universal Fixed Mount Rack Kit	4299-7

**Table 2: Optional accessories (cont.)**

<b>Accessory</b>	<b>Keithley part number</b>
Fixed Mount Rack Kit	RMU2U
RMU2U Rackmount Cosmetic Filler Panel	386-7598-xx
Series 2200 Multichannel Rear Panel Mating Connector	CS-1655-15
USB Cable	USB1-1
IEEE-488.2 Interface Board for the PCI Bus USB-1-1 USB Cable	KPCI-488LPA
Double Shielded Premium IEEE-488 Interface Cables, 0.5m (1.6 ft)	7007-05
Double Shielded Premium IEEE-488 Interface Cables, 1m (3.2 ft)	7007-1
Double Shielded Premium IEEE-488 Interface Cables, 2m (6.5 ft)	7007-2
Double Shielded Premium IEEE-488 Interface Cables, 3m (10 ft)	7007-3
Double Shielded Premium IEEE-488 Interface Cables, 4m (13 ft)	7007-4

## Available Services

For the current list of available services and accessories, upgrades, and options for your instrument, visit the Keithley website, [www.keithley.com](http://www.keithley.com).

**Table 3: Available services**

<b>Service</b>	<b>Keithley part numbers <sup>1</sup></b>
1-year factory warranty extended to 1 additional year from date of shipment	2220-30-1-EW
	2220G-30-1-EW
	2230-30-1-EW
	2230G-30-1-EW
	2220J-30-1-EW
	2220GJ-30-1-EW
	2230J-30-1-EW
	2230GJ-30-1-EW
3 calibrations within 3 years of service from date of shipment	C/2220-30-1-3Y-STD
	C/2220G-30-1-3Y-STD
	C/2230-30-1-3Y-STD
	C/2230G-30-1-3Y-STD
	C/2220J-30-1-3Y-STD
	C/2220GJ-30-1-3Y-STD
	C/2230J-30-1-3Y-STD
C/2230GJ-30-1-3Y-STD	

**Table 3: Available services (cont.)**

<b>Service</b>	<b>Keithley part numbers <sup>1</sup></b>
3 (ANSI-Z540-1 compliant) calibrations within 3 years of service from date of shipment	C/2220-30-1-3Y-DATA
	C/2220G-30-1-3Y-DATA
	C/2230-30-1-3Y-DATA
	C/2230G-30-1-3Y-DATA
	C/2220J-30-1-3Y-DATA
	C/2220GJ-30-1-3Y-DATA
	C/2230J-30-1-3Y-DATA
5 calibrations within 5 years of service from date of shipment	C/2220-30-1-5Y-STD
	C/2220G-30-1-5Y-STD
	C/2230-30-1-5Y-STD
	C/2230G-30-1-5Y-STD
	C/2220J-30-1-5Y-STD
	C/2220GJ-30-1-5Y-STD
	C/2230J-30-1-5Y-STD
5 (ANSI-Z540-1 compliant) calibrations within 5 years of service from date of shipment	C/2220-30-1-5Y-DATA
	C/2220G-30-1-5Y-DATA
	C/2230-30-1-5Y-DATA
	C/2230G-30-1-5Y-DATA
	C/2220J-30-1-5Y-DATA
	C/2220GJ-30-1-5Y-DATA
	C/2230J-30-1-5Y-DATA
C/2230GJ-30-1-5Y-DATA	

<sup>1</sup> Select the part number that contains your instrument model. For example, you would select 2220-30-1-EW for a model 2220 instrument.

## Specifications

For more specifications, refer to the Specifications and Performance Verification Technical Reference included on the CD-ROM that was shipped with your instrument.

**Table 4: Electrical ratings for the power connection, frequency 50/60 Hz**

Model	Line Selector Switch Setting	Voltage Range	Fuse Rating	Max Power
2220-30-1	110 V / 220 V	110: 110/115/120	For 110 V: 6.3 A TH, 250 V	350 VA
2220G-30-1		220: 220/230/240	For 220 V: 3.15 A TH, 250 V	
2220J-30-1	110 V / 220 V	110: 100 V	For 110 V: 6.3 A TH, 250 V	350 VA
2220GJ-30-1		220: 200 V	For 220 V: 3.15 A TH, 250 V	
2230-30-1	110 V / 220 V	110: 110/115/120	For 110 V: 6.3 A TH, 250 V	450 VA
2230G-30-1		220: 220/230/240	For 220 V: 3.15 A TH, 250 V	
2230J-30-1	110 V / 220 V	110: 100 V	For 110 V: 6.3 A TH, 250 V	450 VA
2230GJ-30-1		220: 200 V	For 220 V: 3.15 A TH, 250 V	

**Table 5: Environmental performance for all models**

Parameter	Description
Temperature	Operating: +0 °C to +40 °C
Humidity	Operating: 5% to 95% relative humidity (% RH) at up to 40 °C, non-condensing
Altitude	Operating: 100% capability up to 2,000 meters

### Nominal Voltage Ratings

There are two ranges for all models, selectable by the line-voltage selector switch. Check the voltage select switch on the bottom of the power supply before turning it on:

- 110 V setting, 110 / 115 / 120 VAC
- 220 V setting, 220 / 230 / 240 VAC

Fluctuations must not exceed 10% of the nominal rated voltage.

### Float Voltage Rating

Float voltage rating: Any output can be floated up to 240 V (DC + pk AC with AC limited to a maximum of 3 V pk-pk and maximum of 60 Hz) relative to any other output terminal. The remote sense terminals should remain within 1 V of their respective outputs to avoid possible damage.

## Operating Requirements

1. Place the instrument on a bench or similar surface with the bottom of the instrument closest to the surface.



---

**WARNING.** Do not stand the instrument on its rear-panel. This position is unstable and the instrument might tip over and be damaged or fall on someone and cause injury. To avoid damage to the instrument or bodily injury, only place the instrument so that the bottom of the instrument is laid flat on a stable surface.

---

2. Before operating, ensure that the ambient temperature is between +0 °C and +40 °C (+32 °F to +104 °F).



---

**WARNING.** To ensure proper cooling, keep the front, sides, and rear of the instrument clear of obstructions.

---



---

**WARNING.** Observe all safety precautions listed in this manual before using this product and any associated instruments. Although some instruments and accessories would be used with non-hazardous voltages, there are situations where hazardous conditions may be present. This product is intended for use by qualified personnel who recognize shock hazards and are familiar with the safety precautions required to avoid possible injury. Read and follow all installation, operation, and maintenance information carefully before using the product. Refer to this manual for complete product specifications. Before performing any maintenance, disconnect the line cord and all test cables. Operators of this instrument must be protected from electric shock at all times. The responsible body must ensure that operators are prevented access and/or insulated from every connection point. In some cases, connections must be exposed to potential human contact. Product operators in these circumstances must be trained to protect themselves from the risk of electric shock. If the circuit is capable of operating at or above 1000 volts, no conductive part of the circuit may be exposed.

---



---

**WARNING.** Use properly rated load wires. All load wires must be heavy enough not to overheat when carrying the maximum short-circuit output current of the power supply. If there is more than one load, then any pair of load wires must be capable of safely carrying the full-rated short-circuit output current of the power supply.

---



---

**WARNING.** Do not loosen any screw on this product, except those in the rear connector, which are intended to retain attached external wires to the connector. There are no user serviceable components inside.

---



---

**WARNING.** To reduce risk of fire and shock, ensure the mains supply voltage fluctuations do not exceed 10% of the operating voltage range.

---

## Front-panel Features

Controls and display elements are shown in the following illustrations and tables.

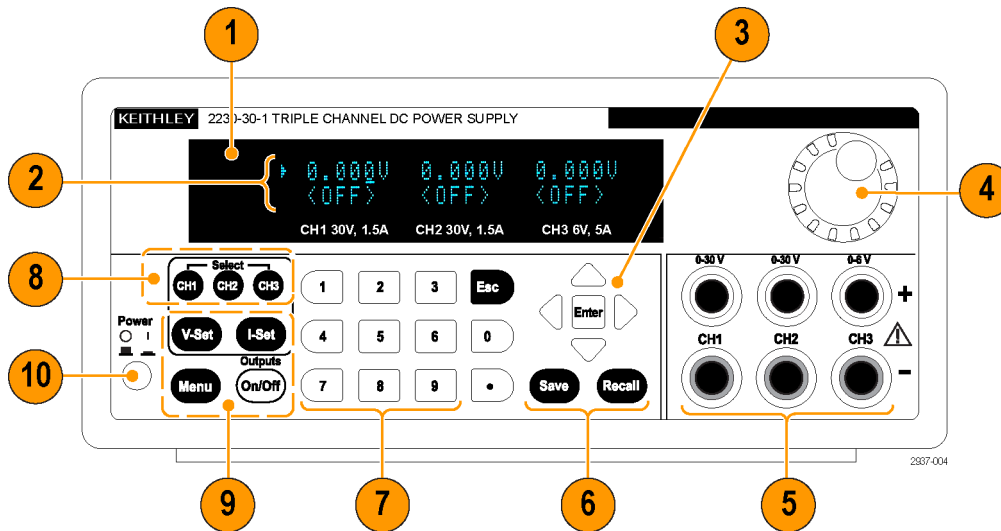



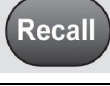





Figure 1: Front-panel for all versions of model 2230-30-1, which has three output channels.

1. Display
2. Top row: Voltage readings or settings for each channel.  
Bottom row: Current readings or settings for each channel.
3. Up, down, right, and left arrow keys and **Enter** button
4. Multipurpose knob. Rotate to increase or decrease digits or to select menu items
5. Output connectors
6. **Save** and **Recall** function buttons
7. Number keys (**0** to **9** and **Esc**) for direct numeric entry
8. Channel select buttons
9. **V-Set**, **I-Set**, **Menu (Local)**, and **Output On/Off** function buttons
10. Power button



## Function button descriptions

Button	Description
	Sets the voltage limit
	Sets the current limit
	Saves the present settings to a specified setup memory location (1 to 30). Select the memory location with the multipurpose knob, the up or down arrow keys, or the numeric keypad. The power supply saves the settings after you push <b>Enter</b> .
	Recalls a saved setting from a specified setup memory location (1 to 30). Select the memory location with the multipurpose knob, the up or down arrow keys, or the numeric keypad. The power supply recalls the settings after you push <b>Enter</b> .
	Used to access the settings menu. Navigate the settings menu with the up and down keys. Push <b>Enter</b> to select the displayed menu item.
	Selects the channel to be adjusted. The cursor indicates the currently selected channel.
	Turns on or off all enabled output channels. The regulation mode, constant voltage (CV) or constant current (CC), is shown on the display when the output is turned on.
	Backs out of the selected function. If the instrument's focus is in a menu, pushing <b>Esc</b> will back up one menu level.

## Menu descriptions

Primary Menu	Secondary Menu	Description
>Default Set		Returns the instrument to the factory default setup values. This does not change the setup memory.
>Enable Channels		Enables or disables one or more output channels.
> Protection Settings	>Max Volt Set	Sets the maximum output voltage value to which you can set on a specified output channel.
	>Output Timers	After you select "On", you can set a time period after which a specified output channel will turn off.
	>Key Lock	When activated, this feature locks the front-panel controls and prompts for a password to enable settings changes. This feature does not lock the power switch or the output on/off switch.
>Track CH1/CH2		Maintains a constant ratio between Channel 1 and Channel 2. The ratio is the ratio that is present when tracking is turned on.

## Menu descriptions (cont.)

Primary Menu	Secondary Menu	Description
> Combine CH1+CH2		<p><b>Series V1+V2:</b> By wiring Channel 1 and Channel 2 in series, you can output up to 60 V. When this setting is activated the meter will read the combined voltage across Channel 1 and Channel 2.</p> <p><b>Parallel I1+I2:</b> By wiring Channel 1 and Channel 2 in parallel, you can drive up to 3 A. When this setting is activated the meter will read the combined current from Channel 1 and Channel 2.</p>
>User Settings	>Output Recall	<p>Sets the power output On/Off state after power up. "On" restores the state to that which was in use before the power was last turned off. "Off" disables this function and configures the output channel to power up in the off state.</p> <p><b>NOTE.</b> Wait 3 seconds after changing the settings to allow the settings to be completely stored before powering off the instrument</p>
	>Save Last	<p>Recalls the operating parameters of the power supply after power up. It does this by saving the last setting of operating parameters before you turn the instrument off and then restoring the saved setting when you turn the instrument back on.</p> <p><b>NOTE.</b> Wait 3 seconds after changing the settings to allow the settings to be completely stored before powering off the instrument.</p>
	>Key Beep	<p>Turns on or off a beeper sound when you push a button or press a key. "On" enables the key sound. "Off" disables it.</p>
	>Knob Lock	<p>Locks the multipurpose knob.</p>
	>Communication Port	<p><b>For G versions only:</b> Offers the option of selecting the GPIB interface or the USB interface. USB is the default interface. When the GPIB interface is selected, an address is displayed. The desired GPIB address can be entered using either the keypad, the multipurpose knob, or the arrow keys.</p>
>System Info	>Address	<p>Select a GPIB address. (This feature is not currently available.)</p> <p>The Address selection is not available on the "G" versions.</p>
	> Error Log	<p>Lists all errors that have occurred.</p>
	Firmware-SW version	<p>Shows the versions of firmware installed on the instrument.</p>
	>Cal Date	<p>Shows the date and time of the last calibration.</p>

### Channel status messages

Symbol	Description
OFF	The power supply output is off
CV	Constant voltage mode
CC	Constant current mode

### Displayed error messages

Symbol	Description
<b>EEPROM Test Fail</b>	An EEPROM Error was detected during power-on self test. The instrument should be returned to Keithley for service.
<b>User Data Lost</b>	A user data error was detected during power-on self test. Turn the instrument off and then turn it back on to clear the error. If the error occurs repeatedly, the instrument should be returned to Keithley for service.
<b>Channel Initialization Failed</b>	An output channel failure was detected during power-on self test. The instrument should be returned to Keithley for service.
<b>Calibration Data Lost</b>	A calibration data error was detected during power-on self test. Turn the instrument off and then turn it back on to clear the error. If the error occurs repeatedly, the instrument should be returned to Keithley for service.
<b>Setup x Save Failure!</b>	Saving a setup to memory x failed. The instrument should be returned to Keithley for service.
<b>Invalid Operation</b>	A Save operation may have been attempted while the instrument was in tracking, series, or parallel mode. A tracking, parallel, or series setup cannot be saved in setup memory. A Recall operation may have been attempted while the instrument was in tracking, series, or parallel mode. The recall function is disabled in these modes.
<b>Over Temperature...</b>	An internal over-temperature has been detected and the outputs have been turned off. Check to make sure ambient temperature does not exceed the operating temperature specification of the instrument, and insure the fan has sufficient clearance. Allow the instrument to cool down and press any button to clear the error. If the message occurs repeatedly, return the instrument to Keithley for service.

## Rear-panel Features

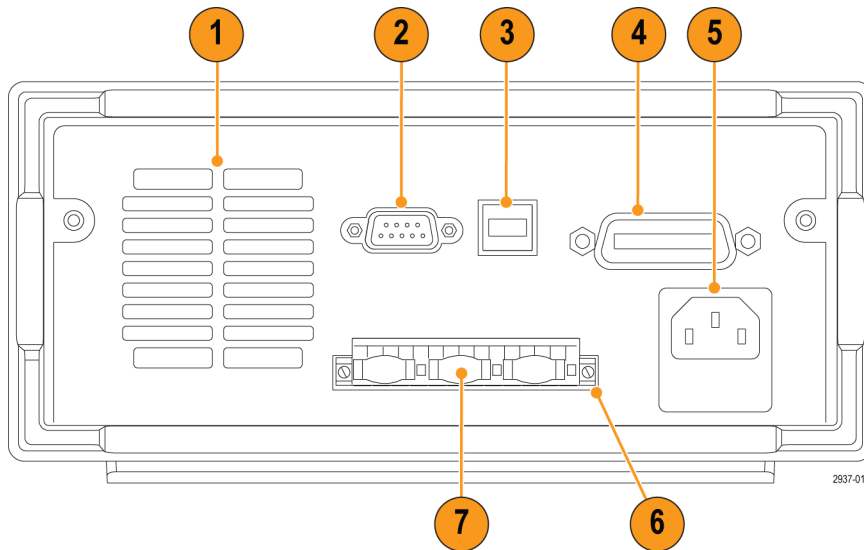

Figure 2: Rear-panel of the 2230-30-1, 2230J-30-1, 2230G-30-1, and 2230GJ-30-1. Only the G versions have the GPIB interface (item 4).

1. Cooling vents.
2. Factory test port.



**CAUTION.** *Unauthorized use of the factory test port could damage this product.*

3. USB Device port.
4. GPIB interface (G models only).
5. 110 V/220 V power connector.
6. 15-pin connector. Includes remote sense and earth ground connections. For each output channel, there is an Output Drive +, a Sense +, an Output Drive -, a Sense -, and an earth ground.

The **Output Drive +** terminals are equivalent to the front-panel output + connectors.

The **Output Drive -** terminals are equivalent to the front-panel output - connectors.

The **Output Sense + and -** terminals are used for remote sensing.

The Earth Ground terminals are tied to each other, to the chassis of the instrument, and to the earth terminal on the power cord.

7. Shorting clips (one per output channel). Use these for proper regulation when not using remote sense. The shorting clips come installed. They short the drive + to the sense + and the drive - to the sense - for each channel. To use remote sense for one or more channels, remove the shorting clip for the corresponding channel(s).

8. 110 V/220 V selector switch.

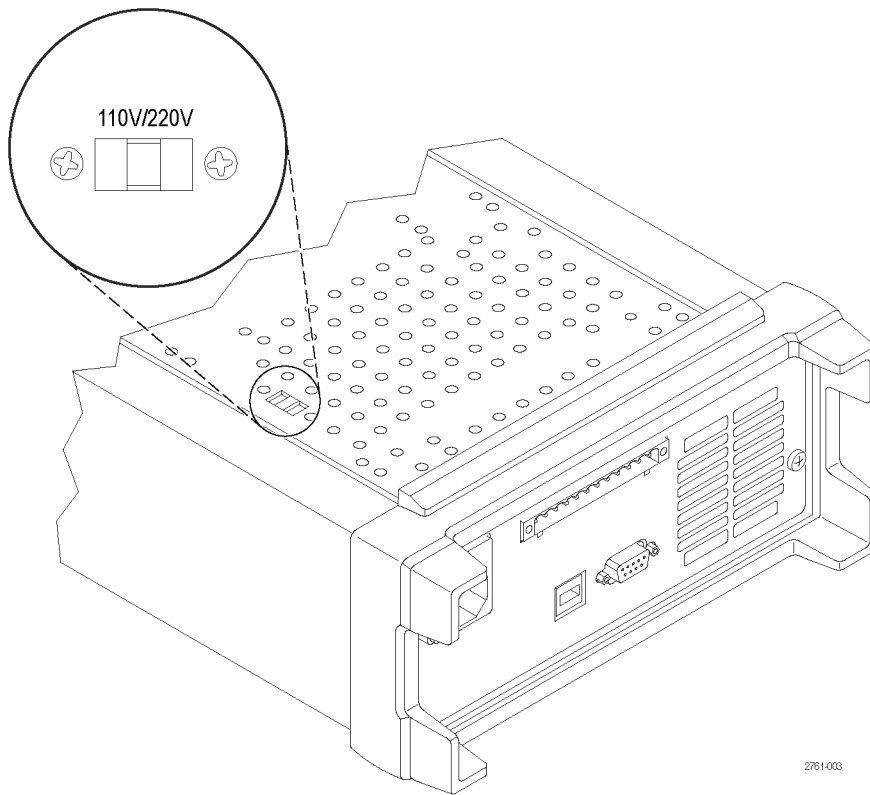

2761-003

## Front-panel Operation

Within a few seconds after powering on, the power supply shows the actual voltage for each channel on the top line of the display and the actual current for each channel on the bottom line of the display.

You can enable or disable the output of the power supply from the front-panel by pushing the **Output On/Off** button. When the output is off, the **OFF** message will appear on the display.

The display shows the present operating status of each channel with display messages. When a channel operates in constant voltage mode, the **CV** indicator is displayed. When it operates in the constant current mode, the **CC** indicator is displayed.

---

**NOTE.** If the front-panel was locked with a password, enter the correct password after you push the function buttons (**V-set**, **I-set**, **Save**, **Recall**, or **Menu**), then you can change the settings.

---

---

**NOTE.** To cancel a function operation (**V-set**, **I-set**, **Save**, **Recall**, or **Menu**), push the **Esc** button.

---

### Initializing to the Default Setup

Use the default setup to get the power supply into a default initial state.

1. Remove all leads from the output connectors.
2. Turn on the power supply.
3. Push **Menu**. **Default Set** should appear on the display.
4. Push **Enter** to bring up the default settings menu. **No** and **Yes** should appear on the display.
5. Push the down arrow button to select **Yes**. Push **Enter** to enable the default settings.

The default settings are:

- **Output On/Off = OFF**
- **V-Set = 1.000V** for all channels
- **I-Set = 0.1000A** for all channels
- **Knob Lock = Off**
- **Max Volt Set = Off** for all channels
- **Out Time Set = Off** for all channels
- **Output Recall = Off**
- **Save Last = On**
- **Key Beep = Off**
- **Tracking = Off**
- **Series V1 + V2 = Off**
- **Parallel I1 + I2 = Off**
- **Address = 1**

## Connect to an External Computer with USB

1. Load VISA on your computer. You can download NI VISA from the National Instruments website at [www.NI.com](http://www.NI.com).

NI VISA is required when using the USB interface. It is recommended when using the GPIB interface.

2. Connect the instrument to the computer with a USB cable. The computer will then recognize the power supply as a USB device. If National Instruments SignalExpress is installed, the computer will also give you the option of running that program.

For more information on loading and running SignalExpress, see the Connectivity Installation Manual on the Documentation Browser CD that was shipped with your instrument. You can also download a copy of this manual from [www.Keithley.com/manuals](http://www.Keithley.com/manuals).

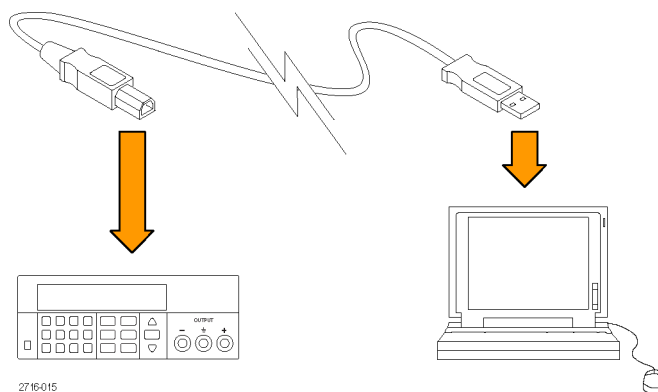

3. G<sup>n</sup> versions can connect to a computer or a system using the GPIB interface. Connect the GPIB interface using a cable equipped with standard IEEE-488 connectors. The GPIB address is set as described under the User Settings option in the Menu Descriptions section of this manual.

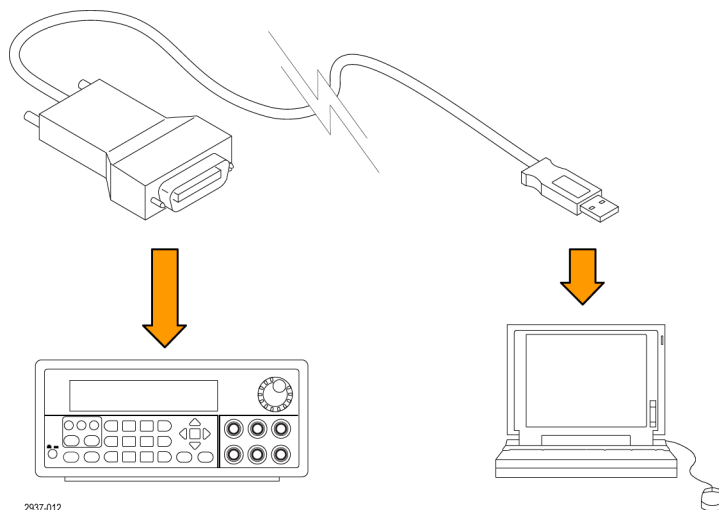

## Installing the System

This section contains information on how to install your instrument. Before performing the procedures on the next several pages to verify that the instrument is ready to use, do the following:

- Unpack the instrument and check that you received all the items listed as standard accessories.
- Check that you also received any other accessories that you ordered with your instrument.
- Check the Keithley website ([www.Keithley.com](http://www.Keithley.com)) for the most current information.

### Powering the Instrument On and Off

To power on the instrument follow these steps:

1. Make all the connections.
2. Properly set the 110 V / 220 V selector switch on the bottom of the instrument.

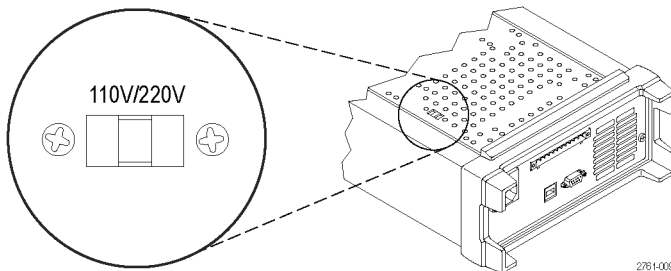

3. Connect the power cord that was provided with the instrument to the power connector on the rear-panel. Connect the power cord plug to a properly grounded electrical outlet.
4. Push the power button on the front-panel.

To power off the instrument, push the front-panel power button.



**WARNING.** To satisfy safety requirements, always use load wires heavy enough not to overheat when carrying the maximum short-circuit output current of the power supply. If there is more than one load, then every pair of load wires must be capable of safely carrying the full-rated current of the power supply.

### What To Do If The Instrument Does Not Turn On

To solve problems you might encounter when turning on the instrument, follow these steps:

1. Verify that there is AC power to the power supply.

First, check that the AC power cord is firmly plugged into the power connector on the rear-panel of the power supply. You should also make sure that the AC power source you plugged the power supply into is energized. Then, check that the power supply is turned on.

2. Verify the power-line voltage settings.

Check that the line voltage selector switch on the bottom of the instrument is set to the proper value for your country (110 V<sub>AC</sub> or 220 V<sub>AC</sub>). Change the voltage setting if it is not correct.



---

**NOTE.** Under certain circumstances, powering the instrument from a mains voltage for which it is not configured can cause the mains fuse to open.

---

3. Verify that the correct power-line fuse is installed.  
If the fuse is damaged, replace the fuse for your power supply.  
If you set the line selection to 110 V, use a 6.3 A, TH 250 V fuse.  
If you set the line selection to 220 V, use a 3.15 A, TH 250 V fuse.
4. If you need more help, contact Keithley.

## Check the Output

The following procedures check that the power supply develops its rated outputs and properly responds to operation from the front-panel.

**Voltage output check.** To verify basic voltage functions without a load, follow these steps.

1. Remove all leads from the output connectors.
2. Turn on the power supply.
3. Push **Menu. Default Set** should appear on the display.
4. Push **Enter** to bring up the default settings menu. **No** and **Yes** should appear on the display.
5. Push the down arrow button to select **Yes**. Push **Enter** to enable the default settings.
6. Push the front-panel **On/Off** button to turn on the outputs. The **OFF** messages on the display should be replaced by current readings and the **CV** indicators should turn on. The upper line of the display should show the actual output voltage.
7. Check that the front-panel voltmeter properly responds to the number keys. First, select a channel using one of the channel select buttons.  
  
Push **V-set**, use the number keys to set the voltage value to 0 and push **Enter**. Check if the displayed voltage value is approximately 0 V and check if the displayed current value is approximately 0 A. You can confirm the 0 V setting with a voltmeter.
8. Push **V-set** and use the numeric keys and **Enter** button to set the voltage value to the maximum allowable for your power supply, as indicated on the unit's front-panel.
9. Check if the displayed voltage value is approximately the same value as the voltage setting.
10. Repeat steps 7 through 9 for each output channel.

**Current output check.** To verify the basic current functions with a short across the power supply output, follow these steps:

1. Remove all leads from the output connectors.
2. Turn on the power supply.
3. Push **Menu. Default Set** should appear on the display.
4. Push **Enter** to bring up the default settings menu. **No** and **Yes** should appear on the display.
5. Push the down arrow button to select **Yes**. Push **Enter** to enable the default settings.

6. Ensure that the output is disabled and the display **OFF** messages are shown for all channels. If needed, push the **On/Off** button to ensure that the outputs are disabled and the **OFF** messages are displayed.
7. Use an insulated test lead to connect a short across the (+) and (-) output terminals of the channel you will be testing.  
Use a wire size sufficient to handle the maximum current. You should use at least a 22 gauge wire.



---

**WARNING.** *To satisfy safety requirements, always use load wires heavy enough not to overheat when carrying the maximum short-circuit output current of the power supply. If there is more than one load, then every pair of load wires must be capable of safely carrying the full-rated current of the power supply.*

---

8. Push the **On/Off** button to enable the outputs. The **CC** indicator should be on the channel with the shorted output.
9. Select a channel using one of the channel select buttons.
10. Push **I-set** and use the numeric keys and **Enter** button to set the current value to 0 A. Check if the displayed current value is approximately 0 A.
11. Push **I-set** and use the numeric keys and **Enter** button to set the current value to the maximum allowable for the output channel. Check if the displayed current value is approximately the same value as the maximum allowable.
12. Turn all outputs off by pressing the **Output On/Off** button. Note that the outputs are off when the display for all channels shows **<OFF>**.
13. Repeat steps 7 through 12 for each output channel.
14. Turn off the instrument and remove the short wire from the (+) and (-) output terminals.

## Cleaning

Inspect the power supply as often as operating conditions require. To clean the exterior surface, perform the following steps:

1. Remove loose dust on the outside of the power supply with a lint-free cloth. Use care to avoid scratching the display.
2. Use a soft cloth dampened with water to clean the power supply. Use an aqueous solution of 75% isopropyl alcohol for more efficient cleaning.



---

**CAUTION.** *To avoid damage to the surface of the power supply, do not use any abrasive or chemical cleaning agents.*

---



---

**CAUTION.** *Avoid getting moisture inside the unit during external cleaning. Use only enough cleaning solution to dampen the cloth or swab.*

---

# Operating Basics

## Basic Settings

### Set the Voltage Output or Voltage Limit for a Specific Channel

You may set the voltage limit from 0 V to the maximum voltage rating shown on the instrument nameplate. To set the voltage limit, do the following:

1. The position of the cursor determines which channel will be adjusted. If the cursor is not located in the correct channel, select the correct channel by pressing the appropriate channel Select button.
2. Push **V-set**.
3. Use the numeric keys and push **Enter** to set the voltage limit. You can also use the up, down, right and left arrow keys or the multipurpose knob.

### Set the Current Output or Current Limit for a Specific Channel

You may set the current limit from 0 A to the maximum current value of each model. The maximum current rating is shown on the instrument nameplate. To set the current limit, do the following:

1. The position of the cursor determines which channel will be adjusted. If the cursor is not located in the correct channel, select the correct channel by pressing the appropriate channel Select button.
2. Push **I-set**.
3. Use the numeric keys and push **Enter** to set the current limit. You can also use the up, down, right and left arrow keys or the multipurpose knob.

### Save and Recall Setups

You can store up to 30 different setups in setup memory locations (1 to 30). Each setup includes the set voltage limits, the set current limits, and the protection menu settings for all channels. When shipped from the factory, setup memories 1 through 30 are empty. Save and recall setups as follows:

#### Saving setups.

1. After you set up the power supply, (voltage and current limits and the protection menu settings), push the **Save** button.
2. Use the number keys or the arrow keys to select the setup memory (1 to 30) that you want to store the values in.
3. Push **Enter** to confirm the memory location.

#### Recalling setups.

1. Push **Recall**.
2. Use the number keys or the arrow keys to select the setup memory that you want to recall from.
3. Push **Enter**.

## Menu Operations

### Restore Default Setup

You can restore the factory default setting by doing the following:

1. Remove all leads from the output connectors.
2. Turn on the instrument.
3. Push **Menu**.
4. Push **Enter** to select **Default Set**.
5. Push the down arrow key to select **Yes**.
6. Push **Enter**.

### Enable and Disable Output Channels

You can enable or disable each output channel using this menu setting. If a channel is disabled, it will remain off after the **Output On/Off** button is turned on. The default setting is to have all channels enabled.

### Protection Settings

The following protection settings allow you to set maximum voltage, use output timers, and lock the front-panel.

**Set the maximum voltage.** This control determines the maximum voltage that you can set using the **V-set** control. This can help keep accidental over-voltage from being applied to sensitive loads. To set the maximum voltage, follow these steps:

1. Push **Menu**.
2. Use the arrow keys to select **Protection Settings**.
3. Push **Enter**. **Max Volt Set** should appear on the display.
4. Push **Enter**. A list of Max V settings for each channel will appear.
5. Use the arrow keys to select the correct channel. Push **Enter** to select.
6. Use the numeric keys or the arrow keys or multipurpose knob to change the voltage value. The value must be less than the maximum voltage output noted on the nameplate of the power supply.
7. Push **Enter**.
8. Push **Esc** to exit the menu system.

---

**NOTE.** *The default maximum voltage is the full voltage range of the particular power supply being used.*

---

**Use output timers.** Independent timers may be activated and set for each output channel. The timers start when the **Output On/Off** button is turned on. When each active timer expires, its corresponding channel turns off.

**Lock the front-panel.** This function prevents any adjustments from being made to the instrument. Once the lock is activated, a four-digit, user-specified password must be entered to change any instrument settings. Even after the front-panel is locked, the **Output On/Off** control and power button continue to operate normally. Turning the power off deactivates the lock and resets the password.

## Use Tracking

When tracking is turned on, Channel 1 and Channel 2 respond together to any adjustments in voltage. A constant ratio will be maintained between the voltage setting on the two channels. The ratio is determined by the voltage settings present on Channel 1 and Channel 2 when tracking is turned on.

For example, if Channel 1 and Channel 2 are both set to 1 V when tracking is turned on, a one to one ratio will be maintained and any voltage change on Channel 1 will result in an identical change on Channel 2. If Channel 1 is set to 10 V and Channel 2 is set to 5 V when tracking is turned on, a two to one ratio will be maintained and any voltage change on Channel 1 will result in a voltage change of half the size on Channel 2.

1. Push **CH1**, then **V-Set**, and then enter the desired voltage for Channel 1.
2. Push **Enter**.
3. Push **CH2**, then **V-Set**, and then enter a voltage in the desired ratio to Channel 1.
4. Push **Enter**.
5. Push **Menu**, use the down arrow key to navigate to **Track CH1/CH2**, and then push **Enter**.
6. Push the down arrow key to select **Track On** and then push **Enter** to turn on tracking.
7. Check that a **T** shows between the Channel 1 and Channel 2 voltage readings on the display. This indicates the power supply is in the tracking mode.

---

**NOTE.** When the tracking mode is enabled, the output timer takes on the setting for Channel 1. The Channel 2 timer setting is ignored.

---

## Combine Channels

You can combine the meter readings of any channels. The following procedures show you how to do that for certain applications, such as when outputs are wired in series or in parallel.

**Combine metering of Channel 1 and Channel 2 when outputs are wired in series.** You can combine the outputs of Channel 1 and Channel 2 by doing the following:

---

**NOTE.** The wiring between the supplies drives the accuracy of measurements in this mode. Ensure that wire sizes are sufficient, wires are short, and connections are tightened to maximize accuracy.

---

1. Wire the outputs in series. (See page 24, *Wiring in Series*.)
2. Push **Menu** and use the up arrow key to navigate to **Combine CH1+CH2**.
3. Push **Enter**.
4. Use the down arrow key to navigate to **V1+V2 Series** and push **Enter**.
5. Check that the word **Series** appears on the display, replacing the Channel 2 voltage and current readings. This indicates that the power supply is in the V1 + V2 Series state. The total output voltage is displayed on Channel 1.
6. Set the Channel 1 voltage to the desired voltage value (up to 60 V).

**Combine metering of Channel 1 and Channel 2 when outputs are wired in parallel.** You can combine the outputs of Channel 1 and Channel 2 by doing the following:

---

**NOTE.** All measurements are at the terminals. If the wires used to connect the channels together are too small, too long, or improperly tightened, accuracy of measurements will be adversely affected.

---

1. Wire the outputs in parallel. (See page 25, *Wiring in Parallel*.)
2. Push **Menu** and use the up arrow key to navigate to **Combine CH1+CH2**.
3. Push **Enter**.
4. Use the down arrow key to navigate to **I1+I2 Parallel** and push **Enter**.
5. Check that the word **Para** appears on the display, replacing the Channel 2 voltage and current readings. This indicates that the power supply is in the I1 + I2 state. The total output current is displayed on Channel 1.
6. Set the Channel 1 current to the desired total current value (up to 3 A).

## User Settings

### Recall the Power Supply ON/OFF Output State at Power On

This parameter determines the On or Off output state after the power supply is powered on. If you select **On**, the power supply will restore the state of the output to that which was in use before the power was last turned off. If the output was turned **On** when the power supply is turned off or loses power then the output will return to the **On** state when the power supply is turned back on or power is restored. **Off** will disable this function and the output channel will always be set to **Off** after the power supply is powered on.

To enable or disable this control,

1. Push **Menu**.
2. Use the up and down arrow keys to select **>User Settings**.
3. Push **Enter**.
4. Use the up and down arrow keys to select **Output Recall**.
5. Push **Enter**.
6. Use the up or down arrow keys to select **On** or **Off**.
7. Push **Enter**.
8. Push **Esc** to exit the menu system.

---

**NOTE.** The default selection is set to *Off*.

---

### Recall the Power Supply Operating Parameters at Power On

This parameter determines whether the power supply saves its most recent settings, such as voltage and current, and restores these settings at power on. If you set this parameter to **Off** then the power supply returns to the default settings at power on. If you select **On**, the power supply will restore the state to that which was in use before the power was last turned off.

To enable or disable this control,

1. Push **Menu**.
2. Use the arrow keys to select **>User Settings**.
3. Push **Enter**.
4. Use the arrow keys to select **Save Last**.
5. Push **Enter**.
6. Use the arrow keys to select **On** or **Off**.
7. Push **Enter**.
8. Push **Esc** to exit the menu system.

---

**NOTE.** *The default selection is set to On.*

---

### Set the Key Sound

This control can switch on or off the beeper that sounds when you push any button or press any key. To enable or disable this feature,

1. Push **Menu**.
2. Use the arrow keys to select **>User Settings**.
3. Push **Enter**.
4. Use the arrow keys to select **>Key Beep**.
5. Push **Enter**.
6. Use the arrow keys to select **On** or **Off**.
7. Push **Enter**.
8. Push **Esc** to exit the menu system.

---

**NOTE.** *The default selection is set to Off.*

---

### Lock the Multipurpose Knob

To lock the multipurpose knob so it cannot be used to change settings or to select menu items,

1. Push **Menu**.
2. Use the arrow keys to select **>User Settings**.
3. Push **Enter**.
4. Use the arrow keys to select **Knob Lock**.
5. Push **Enter**.
6. Use the arrow keys to select **On** or **Off**.

7. Push **Enter**.
8. Push **Esc** to exit the menu system.

## System Information

### Check the Error Log

You can view the error log by doing the following:

1. Push **Menu**.
2. Use the arrow keys or multipurpose knob and navigate to **System Info** and then push **Enter**.
3. Use the arrow keys or multipurpose knob and navigate to **Error Log** and then push **Enter**. You will see a list of any errors that have occurred.
4. To exit the menu push **Esc**.

### Check the Firmware Version of the Instrument

This instrument includes two sets of firmware: Main and Auxiliary. To see the versions of installed firmware, do the following:

1. Push **Menu**.
2. Use the arrow keys or multipurpose knob and navigate to **System Info** and then push **Enter**.
3. Use the arrow keys or multipurpose knob and navigate to **Main:**. The numbers you see after **Main:** and **Aux:** are the main firmware version and auxiliary firmware version, respectively.
4. To exit the menu push **Esc**.

### Check the Calibration Date of the Instrument

This instrument stores the date that it was last calibrated. To see the calibration date, do the following:

1. Push **Menu**.
2. Use the arrow keys or multipurpose knob and navigate to **System Info** and then push **Enter**.
3. Use the arrow keys or multipurpose knob and navigate to the menu item below **Main:** . The date and time displayed are the date and time of the last calibration performed on this instrument.
4. To exit the menu push **Esc**.



## Configure The Instrument for Your Application

The menu system includes settings, like **Max Volt**, that determine the maximum voltage output of the power supply and settings, like **Save Last** and **Output Recall**, that determine how the instrument initializes itself at power-up.

This power supply features a constant voltage/constant current automatic crossover. This feature permits continuous operation in the transition from constant-voltage mode to constant-current mode as the load changes. The intersection of the constant-current and constant-voltage modes is called the crossover point.

For example, if the load is such that the power supply is operating in constant-voltage mode, the power supply provides a regulated output voltage. As the load draws more current, the output voltage remains constant until the preset current limit is reached. Then the crossover occurs. At that point, the output current becomes constant and the output voltage drops in proportion to further load increases.

Crossover is indicated by the front-panel **CC** and **CV** messages. If the **CV** message appears, the instrument is operating in constant-voltage mode. If the **CC** message appears, the instrument is operating in constant-current mode.

Crossover from the constant-current mode to the constant-voltage mode also occurs automatically in response to a decrease in load current.

## Connect to a Device Under Test

You can connect this instrument to a device that you want to test. In this section are procedures for configurations using local and remote sense, and examples for parallel, serial, and bipolar wiring connections.

---

**NOTE.** When connecting to a device under test, you should use at least a 22 gauge wire, which is the minimum wire size sufficient to handle the maximum current.

---



**WARNING.** Use properly rated load wires. All load wires must be heavy enough not to overheat when carrying the maximum short-circuit output current of the power supply. If there is more than one load, then any pair of load wires must be capable of safely carrying the full-rated short-circuit output current of the power supply.

---



**WARNING.** To satisfy safety requirements, always use load wires heavy enough not to overheat when carrying the maximum short-circuit output current of the power supply. If there is more than one load, then every pair of load wires must be capable of safely carrying the full-rated current of the power supply.

---

### Set Up to Use Local Sense

Configuring the power supply for local sense allows connection to the device under test with two lead wires, but does not compensate for voltage drop in the leads.

1. On the rear-panel terminal strip, install wires or the supplied shorting clips between drive OUT + and SENSE +, and between drive OUT - and SENSE -. When using the included shorting clips, they should be installed as shown previously. (See page 10, *Rear-panel Features*.)
2. Connect to your device under test using two wires from the front-panel binding posts.

### Set Up to Use Remote Sense

Use remote sensing to regulate the output voltage at the device under test. This feature lets you compensate for the voltage drop in the leads between the power supply front-end terminals and the device-under-test. To set the remote sensing mode:

1. Remove any jumpers or shorting clip on the rear-panel terminal strip connectors between drive OUT + and SENSE + and between drive OUT - and SENSE -.
2. Connect a pair of sense leads from SENSE + and SENSE - to the device under test.



**CAUTION.** To assure system stability, use jacketed, twisted-pair cables between the remote sense terminals of the instrument and the load.

3. Connect a pair of drive leads from the drive OUT + and drive OUT - to the device under test.

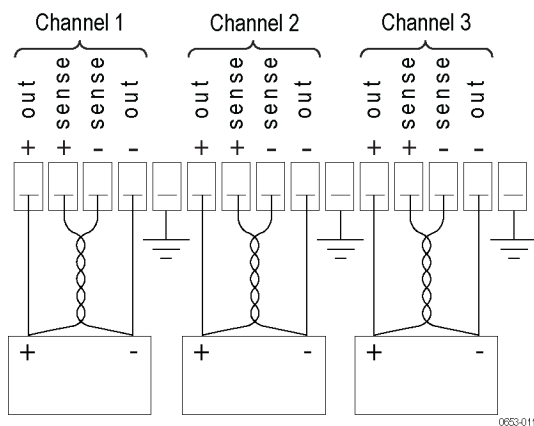

Load (Device Under Test)

### Wiring in Series

By wiring Channel 1 and Channel 2 in series, you can use your power supply to provide up to 60 V to a device under test. The following figure shows how to wire the outputs for Series operation. (See Figure 3.)

Your instrument can also be configured to read the combined voltage from two channels. See *Combine metering of Channel 1 and Channel 2 when outputs are wired in series* to learn how to set the instrument to measure the combined voltage. (See page 19.)

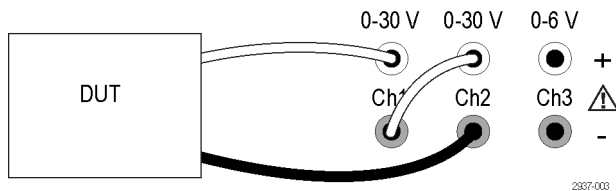
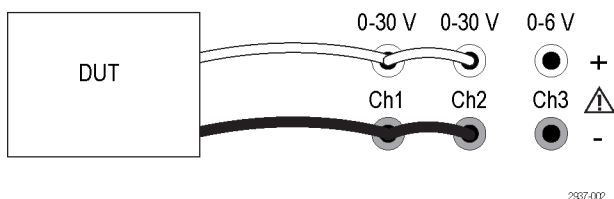

**Figure 3: Series setup for model 2230-30-1 and device under test. Series setup for model 2220-30-1 is the same, but Channel 2 is on the far right.**

## Wiring in Parallel

By wiring Channel 1 and Channel 2 in parallel, you can use your power supply to provide up to 3 A to a device under test. The following figure shows how to wire the outputs for Parallel operation. (See Figure 4.)

Your instrument can also be configured to read the combined current from two channels. See *Combine metering of Channel 1 and Channel 2 when outputs are wired in parallel* to learn how to set the instrument to measure the combined current. (See page 19.)

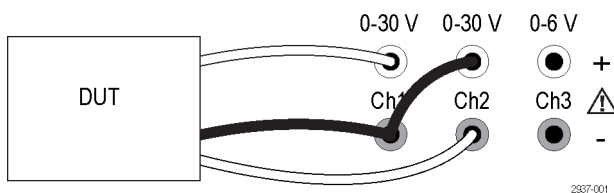

**Figure 4: Parallel setup for model 2230-30-1 and device under test. Parallel setup for model 2220-30-1 is the same, but Channel 2 is on the far right.**

## Wiring for Bipolar Applications

The outputs of your instrument can be wired as a bipolar source. When testing a system in which independent positive and negative supplies are needed, the outputs should be wired as shown here. (See Figure 5.)

To make the positive and negative supplies track together, you can activate tracking. See *Use Tracking* to learn more about tracking and find out how to turn tracking on. (See page 19.)



**Figure 5: Bipolar setup for model 2230-30-1 and device under test. Bipolar setup for model 2220-30-1 is the same, but Channel 2 is on the far right.**



# Index

## Symbols and Numbers

110 V/220 V selector switch, 11  
15-pin connector, 10

## A

Accessories  
    optional, 1  
    standard, 1, 2

## B

Bipolar wiring, 19  
Button  
    Channel select, 7  
    I-set, 7  
    Menu, 7  
    On/off, 7  
    Recall, 7  
    Save, 7  
    V-set, 7

## C

Channel select button, 7  
Channels  
    combining, 19  
    combining in parallel, 19  
    combining in series, 19  
Check  
    current, 15  
    no power, 14  
    voltage, 15  
Connectivity  
    USB, 12  
Connector, 15-pin, 10  
Connectors, 6  
Crossover, 23  
Current  
    constant, 23  
    display, 6  
    limit adjustment, 17

## D

Display, 6  
    Upper messages, 9

## E

Error messages, 9

## F

Features, iv  
Front-panel, 12  
    indicators and buttons, 6  
Function button  
    Channel select, 7  
    I-set, 7  
    Menu, 7  
    On/off, 7  
    Recall, 7  
    Save, 7  
    V-set, 7

## I

I-set button, 7  
Installation, 14

## K

Key  
    arrow, 6  
    function, 6  
    number, 6  
    Save and Recall, 6  
Key Sound, 21  
Knob  
    Lock Set, 21  
    multipurpose, 6

## L

Local sense, 23

## M

Max Volt Set, 18  
Menu button, 7  
Messages, 9  
    error, 9  
Multipurpose  
    knob, 6  
    Knob lock, 21

## N

No power, 14

## O

On/off button, 7  
Operating requirements, 5  
Operation  
    current limit adjustment, 17  
    recalling setups, 17  
    saving setups, 17  
    voltage limit adjustment, 17  
Optional accessories, 1  
Options, 1  
Output  
    display, 6  
    Recall, 20

## P

Parallel wiring, 19  
Power  
    button, 6  
    off, 14  
    on, 14  
    socket, 10

## R

Rear-panel, 10  
Recall  
    button, 7  
    output state at power on, 20  
    parameters at power on, 20  
Remote sense, 10, 24  
Requirements  
    operating, 5

## S

Save button, 7  
Saving and recalling setups, 17  
Series wiring, 19  
Setting  
    current limit, 17  
    voltage limit, 17  
Settings display, 6  
Shorting clip, 10  
Specifications, 4

Standard accessories, 1, 2

## T

Troubleshooting, 14

## U

USB Device port, 10

## V

V-set button, 7

## Voltage

constant, 23

display, 6

limit adjustment, 17

setting maximum, 18



Specifications are subject to change without notice.  
All Keithley trademarks and trade names are the property of Keithley Instruments, Inc.  
All other trademarks and trade names are the property of their respective companies.

Keithley Instruments, Inc.  
Corporate Headquarters • 28775 Aurora Road • Cleveland, Ohio 44139 • 440-248-0400 • Fax: 440-248-6168 • 1-888-KEITHLEY • [www.keithley.com](http://www.keithley.com)

---



A Greater Measure of Confidence