

# Models 707B and 708B Switching Matrix

## Reference Manual

707B-901-01 Rev. B / January 2015



707B-901-01

A Greater Measure of Confidence



# **Models 707B and 708B**

## **Switching Matrix**

### **Reference Manual**

© 2015, Keithley Instruments

Cleveland, Ohio, U.S.A.

All rights reserved.

Any unauthorized reproduction, photocopy, or use of the information herein, in whole or in part, without the prior written approval of Keithley Instruments is strictly prohibited.

TSP<sup>™</sup>, TSP-Link<sup>™</sup>, and TSP-Net<sup>™</sup> are trademarks of Keithley Instruments, Inc. All Keithley Instruments product names are trademarks or registered trademarks of Keithley Instruments. Other brand names are trademarks or registered trademarks of their respective holders.

The Lua 5.0 software and associated documentation files are copyright © 1994-2008, Tecgraf, PUC-Rio. Terms of license for the Lua software and associated documentation can be accessed at the Lua licensing site (<http://www.lua.org/license.html>).

Document number: 707B-901-01 Rev. B / January 2015



The following safety precautions should be observed before using this product and any associated instrumentation. Although some instruments and accessories would normally be used with nonhazardous voltages, there are situations where hazardous conditions may be present.

This product is intended for use by qualified personnel who recognize shock hazards and are familiar with the safety precautions required to avoid possible injury. Read and follow all installation, operation, and maintenance information carefully before using the product. Refer to the user documentation for complete product specifications.

If the product is used in a manner not specified, the protection provided by the product warranty may be impaired.

The types of product users are:

**Responsible body** is the individual or group responsible for the use and maintenance of equipment, for ensuring that the equipment is operated within its specifications and operating limits, and for ensuring that operators are adequately trained.

**Operators** use the product for its intended function. They must be trained in electrical safety procedures and proper use of the instrument. They must be protected from electric shock and contact with hazardous live circuits.

**Maintenance personnel** perform routine procedures on the product to keep it operating properly, for example, setting the line voltage or replacing consumable materials. Maintenance procedures are described in the user documentation. The procedures explicitly state if the operator may perform them. Otherwise, they should be performed only by service personnel.

**Service personnel** are trained to work on live circuits, perform safe installations, and repair products. Only properly trained service personnel may perform installation and service procedures.

Keithley Instruments products are designed for use with electrical signals that are measurement, control, and data I/O connections, with low transient overvoltages, and must not be directly connected to mains voltage or to voltage sources with high transient overvoltages. Measurement Category II (as referenced in IEC 60664) connections require protection for high transient overvoltages often associated with local AC mains connections. Certain Keithley measuring instruments may be connected to mains. These instruments will be marked as category II or higher.

Unless explicitly allowed in the specifications, operating manual, and instrument labels, do not connect any instrument to mains.

Exercise extreme caution when a shock hazard is present. Lethal voltage may be present on cable connector jacks or test fixtures. The American National Standards Institute (ANSI) states that a shock hazard exists when voltage levels greater than 30 V RMS, 42.4 V peak, or 60 VDC are present. A good safety practice is to expect that hazardous voltage is present in any unknown circuit before measuring.

Operators of this product must be protected from electric shock at all times. The responsible body must ensure that operators are prevented access and/or insulated from every connection point. In some cases, connections must be exposed to potential human contact. Product operators in these circumstances must be trained to protect themselves from the risk of electric shock. If the circuit is capable of operating at or above 1000 V, no conductive part of the circuit may be exposed.

Do not connect switching cards directly to unlimited power circuits. They are intended to be used with impedance-limited sources. NEVER connect switching cards directly to AC mains. When connecting sources to switching cards, install protective devices to limit fault current and voltage to the card.

Before operating an instrument, ensure that the line cord is connected to a properly-grounded power receptacle. Inspect the connecting cables, test leads, and jumpers for possible wear, cracks, or breaks before each use.

When installing equipment where access to the main power cord is restricted, such as rack mounting, a separate main input power disconnect device must be provided in close proximity to the equipment and within easy reach of the operator.

For maximum safety, do not touch the product, test cables, or any other instruments while power is applied to the circuit under test. ALWAYS remove power from the entire test system and discharge any capacitors before: connecting or disconnecting cables or jumpers, installing or removing switching cards, or making internal changes, such as installing or removing jumpers.

Do not touch any object that could provide a current path to the common side of the circuit under test or power line (earth) ground. Always make measurements with dry hands while standing on a dry, insulated surface capable of withstanding the voltage being measured.

For safety, instruments and accessories must be used in accordance with the operating instructions. If the instruments or

accessories are used in a manner not specified in the operating instructions, the protection provided by the equipment may be impaired.

Do not exceed the maximum signal levels of the instruments and accessories, as defined in the specifications and operating information, and as shown on the instrument or test fixture panels, or switching card.

When fuses are used in a product, replace with the same type and rating for continued protection against fire hazard.

Chassis connections must only be used as shield connections for measuring circuits, NOT as protective earth (safety ground) connections.

If you are using a test fixture, keep the lid closed while power is applied to the device under test. Safe operation requires the use of a lid interlock.

If a  screw is present, connect it to protective earth (safety ground) using the wire recommended in the user documentation.

The  symbol on an instrument means caution, risk of danger. The user must refer to the operating instructions located in the user documentation in all cases where the symbol is marked on the instrument.

The  symbol on an instrument means caution, risk of electric shock. Use standard safety precautions to avoid personal contact with these voltages.

The  symbol on an instrument shows that the surface may be hot. Avoid personal contact to prevent burns.

The  symbol indicates a connection terminal to the equipment frame.

If this  symbol is on a product, it indicates that mercury is present in the display lamp. Please note that the lamp must be properly disposed of according to federal, state, and local laws.

The **WARNING** heading in the user documentation explains dangers that might result in personal injury or death. Always read the associated information very carefully before performing the indicated procedure.

The **CAUTION** heading in the user documentation explains hazards that could damage the instrument. Such damage may invalidate the warranty.

Instrumentation and accessories shall not be connected to humans.

Before performing any maintenance, disconnect the line cord and all test cables.

To maintain protection from electric shock and fire, replacement components in mains circuits — including the power transformer, test leads, and input jacks — must be purchased from Keithley Instruments. Standard fuses with applicable national safety approvals may be used if the rating and type are the same. Other components that are not safety-related may be purchased from other suppliers as long as they are equivalent to the original component (note that selected parts should be purchased only through Keithley Instruments to maintain accuracy and functionality of the product). If you are unsure about the applicability of a replacement component, call a Keithley Instruments office for information.

To clean an instrument, use a damp cloth or mild, water-based cleaner. Clean the exterior of the instrument only. Do not apply cleaner directly to the instrument or allow liquids to enter or spill on the instrument. Products that consist of a circuit board with no case or chassis (e.g., a data acquisition board for installation into a computer) should never require cleaning if handled according to instructions. If the board becomes contaminated and operation is affected, the board should be returned to the factory for proper cleaning/servicing.

Safety precaution revision as of January 2013.

# Table of Contents

<b>Introduction</b> .....	<b>1-1</b>
Contact information .....	1-1
Overview .....	1-1
Extended warranty .....	1-1
<b>General operation</b> .....	<b>2-1</b>
Rear panel overview .....	2-1
Model 707B Rear panel .....	2-2
Model 708B Rear panel .....	2-2
Wiring .....	2-2
Communication connections .....	2-3
Digital I/O port .....	2-7
Power-up .....	2-10
Line power connection .....	2-10
Power-up sequence .....	2-10
Front-panel operation .....	2-11
Model 707B front panel .....	2-11
Model 708B front panel .....	2-11
Display .....	2-12
Crosspoint display (Model 707B only) .....	2-14
Selecting channels from the front panel .....	2-15
Keys and navigation wheel .....	2-16
Menu options .....	2-19
Remote communications interfaces .....	2-22
USB communications .....	2-23
GPIB setup .....	2-30
LAN communications .....	2-35
Supplied software .....	2-56
Keithley I/O layer .....	2-57
Addressing instruments with VISA .....	2-61
Using the web interface .....	2-66
Introduction .....	2-66
Card pages .....	2-68
Scan Builder page .....	2-71
TSB Embedded .....	2-75
Admin page .....	2-77
Unit page .....	2-77
LXI page .....	2-78
Switch operation .....	2-80
Working with channels .....	2-80
Reset a channel .....	2-97
Pseudocards .....	2-98
Save the present configuration .....	2-98
<b>Functions and features</b> .....	<b>3-1</b>
Scanning and triggering .....	3-1
Trigger model .....	3-1

Trigger model components.....	3-3
Trigger model events and associated commands.....	3-3
Scan and step counts.....	3-4
Basic scan procedure.....	3-5
Changing attributes of an existing scan .....	3-6
Front-panel scanning .....	3-6
Foreground and background scan execution .....	3-7
Include multiple channels in a single scan step.....	3-7
Remote interface scanning .....	3-8
Scan and trigger commands .....	3-8
Scanning examples.....	3-9
Hardware trigger modes.....	3-13
Falling edge trigger mode .....	3-14
Rising edge master trigger mode .....	3-15
Rising edge acceptor trigger mode .....	3-15
Either edge trigger mode.....	3-16
Understanding synchronous triggering modes .....	3-17
Synchronous master trigger mode .....	3-17
Synchronous acceptor trigger mode .....	3-19
Synchronous trigger mode .....	3-19
Events .....	3-21
Event blenders .....	3-21
<b>Theory of operation .....</b>	<b>4-1</b>
Theory of operation .....	4-1
Models 707B and 708B theory of operations overview .....	4-1
Mainframe .....	4-1
Front panel.....	4-5
<b>Introduction to TSP operation.....</b>	<b>5-1</b>
Introduction to TSP operation .....	5-1
Controlling the instrument by sending individual command messages .....	5-1
Queries .....	5-3
Data retrieval commands .....	5-3
Information on scripting and programming.....	5-3
About TSP commands .....	5-3
Beeper control.....	5-3
Bit manipulation and logic operations.....	5-4
channel functions and attributes.....	5-4
createconfigscript function.....	5-7
Data queue.....	5-7
delay function .....	5-7
Digital I/O .....	5-8
Display .....	5-8
Error queue .....	5-8
eventlog functions and attributes.....	5-9
exit function.....	5-9
Queries and response messages.....	5-9
GPIB .....	5-9
LAN and LXI.....	5-10
Local node.....	5-11
make accessor functions.....	5-11
memory functions.....	5-11

opc function.....	5-11
print functions.....	5-11
Reset.....	5-11
Scan.....	5-12
Scripting.....	5-12
Slot.....	5-13
Status model functions.....	5-13
timer functions.....	5-13
trigger functions and attributes.....	5-14
TSP-Link.....	5-14
TSP-Net.....	5-15
Userstrings.....	5-15
waitcomplete function.....	5-15
Overview of instrument drivers.....	5-16
Instrument driver types.....	5-16
VXIPI drivers.....	5-17
Interchangeable Virtual Instruments (IVI) style drivers.....	5-17
LabVIEW drivers.....	5-18
Getting instrument drivers.....	5-18
Instrument driver examples.....	5-18
Migrating from Models 707A and 708A.....	5-19
Migrating Model 707A or 708A programs to Model 707B or 708B.....	5-19
DDC to ICL command equivalencies.....	5-20

## **Instrument programming ..... 6-1**

Fundamentals of scripting for TSP.....	6-1
Fundamentals of scripting for TSP.....	6-1
Fundamentals of programming for TSP.....	6-10
Introduction.....	6-10
What is Lua?.....	6-11
Lua basics.....	6-11
Standard libraries.....	6-25
Programming example: Script with a for loop.....	6-29
Using Test Script Builder (TSB).....	6-31
Installing the TSB software.....	6-32
Project navigator.....	6-33
Script editor.....	6-33
Programming interaction.....	6-33
Advanced scripting for TSP.....	6-33
Global variables and the script.user.scripts table.....	6-33
Create a script using the script.new() command.....	6-35
Rename a script.....	6-37
Retrieve a user script.....	6-39
Delete user scripts from the instrument.....	6-41
Restore a script to the run-time environment.....	6-42
Memory considerations for the run-time environment.....	6-42
TSP-Link system and running simultaneous test scripts.....	6-44
TSP-Link system.....	6-44
TSP-Link nodes.....	6-44
Connect the TSP-Link cable.....	6-44
Initialization.....	6-46
Using TSP to run test scripts simultaneously.....	6-48
TSP-Net.....	6-52
Overview.....	6-52
TSP-Net Capabilities.....	6-52



Using TSP-Net with any Ethernet-enabled device .....	6-53
TSP-Net compared to TSP-Link to communicate with TSP-enabled devices .....	6-54
TSP-Net instrument commands: General device control .....	6-54
TSP-Net instrument commands: TSP-enabled device control .....	6-54
Example: Using tspnet commands .....	6-55

## **TSP command reference..... 7-1**

Command programming notes .....	7-1
Placeholder text .....	7-1
Syntax rules .....	7-2
Logical instruments .....	7-3
Time and date values .....	7-3
Using the TSP command reference .....	7-4
Command name and standard parameters summary .....	7-4
Command usage .....	7-5
Command details .....	7-6
Example section .....	7-6
Related commands and information .....	7-7
Instrument Control Library (ICL) command reference .....	7-8
beeper.beep() .....	7-8
beeper.enable .....	7-8
bit.bitand() .....	7-9
bit.bitor() .....	7-9
bit.bitxor() .....	7-10
bit.clear() .....	7-11
bit.get() .....	7-11
bit.getfield() .....	7-12
bit.set() .....	7-13
bit.setfield() .....	7-14
bit.test() .....	7-14
bit.toggle() .....	7-15
channel.clearforbidden() .....	7-16
channel.close() .....	7-17
channel.connectrule .....	7-18
channel.connectsequential .....	7-19
channel.createspecifier() .....	7-20
channel.exclusiveclose() .....	7-22
channel.exclusiveslotclose() .....	7-23
channel.getclose() .....	7-24
channel.getcount() .....	7-25
channel.getdelay() .....	7-26
channel.getforbidden() .....	7-27
channel.getlabel() .....	7-28
channel.getlabelcolumn() .....	7-30
channel.getlabelrow() .....	7-31
channel.getstate() .....	7-32
channel.gettype() .....	7-33
channel.open() .....	7-33
channel.pattern.catalog() .....	7-35
channel.pattern.delete() .....	7-36
channel.pattern.getimage() .....	7-36
channel.pattern.setimage() .....	7-37
channel.pattern.snapshot() .....	7-39
channel.reset() .....	7-40
channel.setdelay() .....	7-41
channel.setforbidden() .....	7-42
channel.setlabel() .....	7-43
channel.setlabelcolumn() .....	7-44

channel.setlabelrow()	7-46
createconfigscript()	7-47
dataqueue.add()	7-48
dataqueue.CAPACITY	7-49
dataqueue.clear()	7-49
dataqueue.count	7-50
dataqueue.next()	7-51
delay()	7-52
digio.readbit()	7-52
digio.readport()	7-53
digio.trigger[N].assert()	7-53
digio.trigger[N].clear()	7-54
digio.trigger[N].EVENT_ID	7-54
digio.trigger[N].mode	7-55
digio.trigger[N].overrun	7-57
digio.trigger[N].pulsewidth	7-57
digio.trigger[N].release()	7-58
digio.trigger[N].reset()	7-58
digio.trigger[N].stimulus	7-59
digio.trigger[N].wait()	7-61
digio.writebit()	7-61
digio.writeport()	7-62
digio.writeprotect	7-63
display.clear()	7-63
display.getannunciators()	7-64
display.getcursor()	7-65
display.getlastkey()	7-66
display.gettext()	7-67
display.inputvalue()	7-68
display.loadmenu.add()	7-70
display.loadmenu.catalog()	7-71
display.loadmenu.delete()	7-72
display.locallockout	7-72
display.menu()	7-73
display.prompt()	7-74
display.screen	7-75
display.sendkey()	7-76
display.setcursor()	7-77
display.settext()	7-79
display.trigger.clear()	7-80
display.trigger.EVENT_ID	7-80
display.waitkey()	7-81
errorqueue.clear()	7-82
errorqueue.count	7-83
errorqueue.next()	7-83
eventlog.all()	7-84
eventlog.clear()	7-85
eventlog.count	7-86
eventlog.enable	7-86
eventlog.next()	7-87
eventlog.overwritemethod	7-88
exit()	7-88
format.asciiprecision	7-89
format.byteorder	7-89
format.data	7-90
gettimezone()	7-92
gpib.address	7-92
lan.applysettings()	7-93
lan.config.dns.address[N]	7-94
lan.config.dns.domain	7-95
lan.config.dns.dynamic	7-95

lan.config.dns.hostname .....	7-96
lan.config.dns.verify .....	7-97
lan.config.gateway .....	7-97
lan.config.ipaddress .....	7-98
lan.config.method .....	7-98
lan.config.subnetmask .....	7-99
lan.lxidomain .....	7-100
lan.nagle .....	7-100
lan.reset() .....	7-101
lan.restoredefaults() .....	7-101
lan.status.dns.address[N] .....	7-102
lan.status.dns.name .....	7-102
lan.status.duplex .....	7-103
lan.status.gateway .....	7-103
lan.status.ipaddress .....	7-104
lan.status.macaddress .....	7-104
lan.status.port.dst .....	7-105
lan.status.port.rawsocket .....	7-105
lan.status.port.telnet .....	7-106
lan.status.port.vxi11 .....	7-106
lan.status.speed .....	7-107
lan.status.subnetmask .....	7-107
lan.trigger[N].assert() .....	7-108
lan.trigger[N].clear() .....	7-108
lan.trigger[N].connect() .....	7-109
lan.trigger[N].connected .....	7-109
lan.trigger[N].disconnect() .....	7-110
lan.trigger[N].EVENT_ID .....	7-111
lan.trigger[N].ipaddress .....	7-111
lan.trigger[N].mode .....	7-112
lan.trigger[N].overrun .....	7-113
lan.trigger[N].protocol .....	7-114
lan.trigger[N].pseudostate .....	7-114
lan.trigger[N].stimulus .....	7-115
lan.trigger[N].wait() .....	7-117
localnode.define * .....	7-118
localnode.description .....	7-119
node[N].execute() .....	7-120
node[N].getglobal() .....	7-120
localnode.model .....	7-121
localnode.password .....	7-121
localnode.passwordmode .....	7-122
localnode.prompts .....	7-123
localnode.prompts4882 .....	7-124
localnode.reset() .....	7-124
localnode.revision .....	7-125
localnode.serialno .....	7-126
node[N].setglobal() .....	7-126
localnode.showerrors .....	7-127
makegetter() .....	7-127
makesetter() .....	7-128
memory.available() .....	7-129
memory.used() .....	7-130
opc() .....	7-131
print() .....	7-131
printbuffer() .....	7-132
printnumber() .....	7-134
reset() .....	7-135
scan.abort() .....	7-135
scan.add() .....	7-136
scan.addimagestep() .....	7-138

scan.background()	7-139
scan.bypass	7-140
scan.create()	7-141
scan.execute()	7-142
scan.list()	7-143
scan.mode	7-145
scan.reset()	7-146
scan.scancount	7-147
scan.state()	7-148
scan.stepcount	7-149
scan.trigger.arm.clear()	7-149
scan.trigger.arm.set()	7-150
scan.trigger.arm.stimulus	7-150
scan.trigger.channel.clear()	7-152
scan.trigger.channel.set()	7-152
scan.trigger.channel.stimulus	7-153
scan.trigger.clear()	7-155
script.anonymous	7-155
script.delete()	7-156
script.new()	7-156
script.newautorun()	7-158
script.restore()	7-159
script.run()	7-159
script.user.catalog()	7-160
scriptVar.autorun	7-160
scriptVar.list()	7-162
scriptVar.name	7-162
scriptVar.run()	7-163
scriptVar.save()	7-164
scriptVar.source	7-165
settime()	7-165
settimezone()	7-166
slot[X].idn	7-168
slot[X].poles.four	7-169
slot[X].poles.one	7-170
slot[X].poles.two	7-171
slot[X].pseudocard	7-171
status.condition	7-172
status.node_enable	7-174
status.node_event	7-176
status.operation.*	7-177
status.operation.user.*	7-179
status.questionable.*	7-181
status.request_enable	7-183
status.request_event	7-185
status.reset()	7-187
status.standard.*	7-187
status.system.*	7-190
status.system2.*	7-192
status.system3.*	7-194
status.system4.*	7-196
status.system5.*	7-198
timer.measure.t()	7-200
timer.reset()	7-200
trigger.blender[N].clear()	7-201
trigger.blender[N].EVENT_ID	7-201
trigger.blender[N].orenable	7-202
trigger.blender[N].overrun	7-203
trigger.blender[N].reset()	7-203
trigger.blender[N].stimulus[M]	7-204
trigger.blender[N].wait()	7-205

trigger.clear()	7-206
trigger.EVENT_ID	7-206
trigger.timer[N].clear()	7-206
trigger.timer[N].count	7-207
trigger.timer[N].delay	7-208
trigger.timer[N].delaylist	7-208
trigger.timer[N].EVENT_ID	7-209
trigger.timer[N].overrun	7-210
trigger.timer[N].passthrough	7-210
trigger.timer[N].reset()	7-211
trigger.timer[N].stimulus	7-212
trigger.timer[N].wait()	7-213
trigger.wait()	7-213
tslink.group	7-214
tslink.master	7-215
tslink.node	7-215
tslink.readbit()	7-216
tslink.readport()	7-216
tslink.reset()	7-217
tslink.state	7-218
tslink.trigger[N].assert()	7-219
tslink.trigger[N].clear()	7-219
tslink.trigger[N].EVENT_ID	7-220
tslink.trigger[N].mode	7-220
tslink.trigger[N].overrun	7-222
tslink.trigger[N].pulsewidth	7-223
tslink.trigger[N].release()	7-223
tslink.trigger[N].reset()	7-224
tslink.trigger[N].stimulus	7-224
tslink.trigger[N].wait()	7-225
tslink.writebit()	7-226
tslink.writeport()	7-227
tslink.writeprotect	7-227
tspnet.clear()	7-228
tspnet.connect()	7-229
tspnet.disconnect()	7-230
tspnet.execute()	7-231
tspnet.idn()	7-232
tspnet.read()	7-232
tspnet.readavailable()	7-233
tspnet.reset()	7-234
tspnet.termination()	7-234
tspnet.timeout	7-235
tspnet.tsp.abort()	7-236
tspnet.tsp.abortonconnect	7-236
tspnet.tsp.rhtablecopy()	7-237
tspnet.tsp.runscript()	7-238
tspnet.write()	7-239
userstring.add()	7-239
userstring.catalog()	7-240
userstring.delete()	7-241
userstring.get()	7-242
waitcomplete()	7-242

## **Troubleshooting guide ..... 8-1**

Troubleshooting guide	8-1
Error and status messages	8-1
Error summary	8-1
Effects of errors on scripts	8-2

Retrieving errors.....	8-2
<b>USB troubleshooting .....</b>	<b>8-2</b>
Check driver for the USB Test and Measurement Device.....	8-2
<b>Troubleshooting GPIB interfaces .....</b>	<b>8-5</b>
Controller (hardware) not recognized.....	8-5
Timeout errors.....	8-5
<b>Troubleshooting LAN interfaces.....</b>	<b>8-5</b>
Verify connections and settings.....	8-6
Use Ping to test the connection.....	8-6
Open ports on firewalls .....	8-7
Web page problems.....	8-7
LXI LAN status indicator.....	8-8
Initialize the LAN configuration.....	8-8
Install LXI Discovery Browser software on your computer .....	8-8
Communicate using VISA communicator.....	8-9
WireShark .....	8-9
<b>Testing the display, keys, and channel matrix .....</b>	<b>8-9</b>
Verify front panel key operation.....	8-9
Verify display operation.....	8-9
Verify crosspoint display operation (707B only) .....	8-10
<b>Update drivers.....</b>	<b>8-10</b>
<b>Contacting support.....</b>	<b>8-10</b>
<b>Frequently asked questions.....</b>	<b>9-1</b>
Frequently asked questions .....	9-1
How do I get my LAN or web connection to work?.....	9-1
Why can't I close a channel?.....	9-1
How do I know if an error has occurred on my instrument? .....	9-2
How do I find the serial number and firmware version of the instrument?.....	9-3
<b>Next steps .....</b>	<b>10-1</b>
Additional Models 707B and 708B information .....	10-1
<b>Maintenance.....</b>	<b>A-1</b>
Maintenance.....	A-1
Upgrading firmware.....	A-1
Check fan status .....	A-2
Fuse replacement .....	A-2
Fixed rack installation.....	A-4
<b>Using Models 707A and 708A compatibility mode .....</b>	<b>B-1</b>
Using Models 707A and 708A compatibility mode .....	B-1
Model A to Model B differences .....	B-1
Models 707A and 708A commands .....	B-3
<b>Status model .....</b>	<b>C-1</b>
Status model .....	C-1
Overview .....	C-1
Status model diagrams .....	C-3

Status function summary.....C-13  
Clearing registers .....C-13  
Startup state.....C-14  
Programming and reading registers.....C-14  
Status byte and service request (SRQ).....C-16  
TSP-Link system status .....C-21

**Index ..... I-1**

---

## Introduction

### In this section:

---

Contact information .....	1-1
Overview .....	1-1
Extended warranty .....	1-1

## Contact information

If you have any questions after you review the information in this documentation, please contact your local Keithley Instruments office, sales partner, or distributor, or call Keithley Instruments corporate headquarters (toll-free inside the U.S. and Canada only) at 1-800-935-5595, or from outside the U.S. at +1-440-248-0400. For worldwide contact numbers, visit the [Keithley Instruments website](http://www.keithley.com) (<http://www.keithley.com>).

## Overview

The Models 707B and 708B provide outstanding low-current matrix capability and let you control up to 576 matrix crosspoints in real time. Their large matrix format makes them well suited for your large ATE system applications, such as semiconductor device characterization, wafer level reliability, parallel test, and modeling.

The Model 707B can host up to six test cards. The Model 708B is a single slot chassis.

## Extended warranty

Additional years of warranty coverage are available on many products. These valuable contracts protect you from unbudgeted service expenses and provide additional years of protection at a fraction of the price of a repair. Extended warranties are available on new and existing products. Contact your local Keithley Instruments office, sales partner, or distributor for details.





## General operation

### In this section:

Rear panel overview .....	2-1
Wiring.....	2-2
Power-up.....	2-10
Front-panel operation.....	2-11
Remote communications interfaces .....	2-22
Using the web interface.....	2-66
Switch operation.....	2-80

## Rear panel overview

You make power and communications connections to the rear panel of the instrument. The connections available are described in the following table. The following figures show the locations of the connections.

Rear panel options	
Option	Description
Slots	Use the slots in the Keithley Instruments Models 707B and 708B for the switching cards. The Model 707B can accept up to six switching cards. The Model 708B can accept one switching card. If a slot does not contain a card, make sure to cover the slot with a slot cover. For model and firmware version information on the installed cards, press the <b>SLOT</b> key.
IEEE-488	IEEE-488 (GPIB) connector. See <a href="#">GPIB quick start</a> (on page 2-31).
Digital I/O	Digital input/output connector. See <a href="#">Digital I/O port</a> (on page 2-7) for connection information.
LAN	Ethernet (LAN) connector. See <a href="#">Connect the LAN cable</a> (on page 2-4).
Fuse	Line fuse. Model 707B fuse rating is Slow Blow 2.0A, 250V. Model 708B is Slow Blow 1.0 A 250V. To replace the fuse, see <a href="#">Fuse replacement</a> (on page A-2).
USB (Type B)	USB communication interface connection. See <a href="#">Connect the USB cable</a> (on page 2-3).
Power	Using the supplied line cord, connect to a grounded AC power outlet. See <a href="#">Line power connection</a> (on page 2-10) for connection details.
TSP-LINK	Use with TSP-Link <sup>®</sup> cable to expand the system. See <a href="#">Connect the TSP-Link cable</a> (on page 2-6).
Serial number	Serial number of the instrument.

## Model 707B Rear panel

Figure 1: Model 707B rear panel

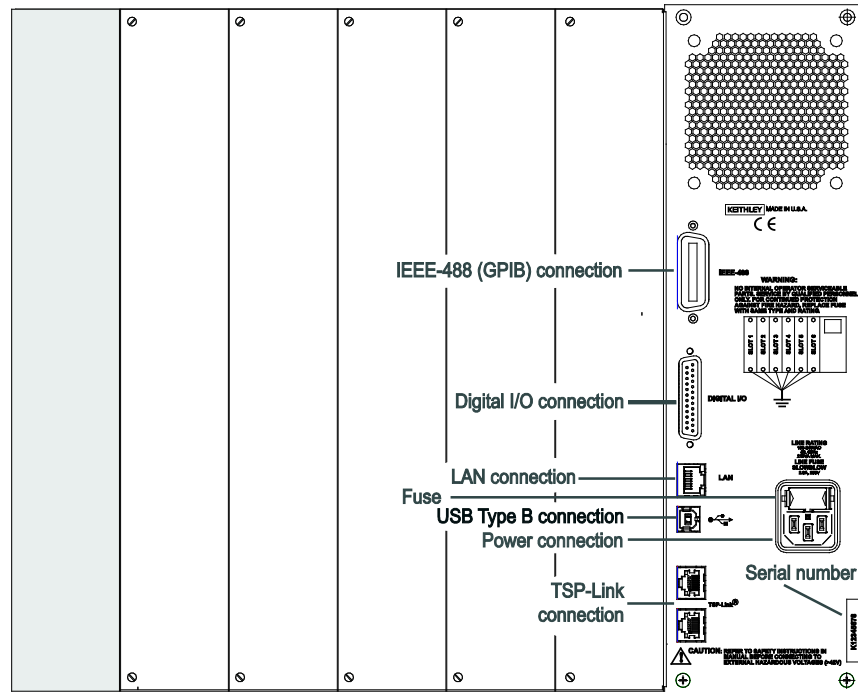

## Model 708B Rear panel

Figure 2: Model 708B full rear panel

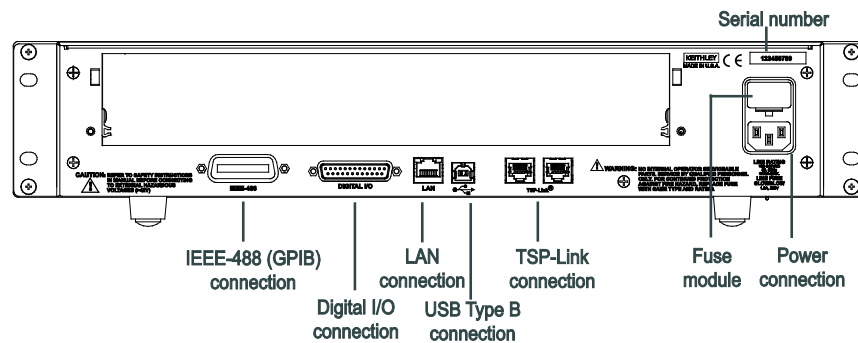

## Wiring

This section describes communication, digital I/O, and power connections.

Note that all signal wiring to devices and instruments is done through the switch cards. Please refer to the switch card manuals for additional information.

## Communication connections

The following topics describe how to connect the cable connections for the communication interfaces.

To properly set up the communications interfaces after connection, see the information in [Remote communications interfaces](#) (on page 4-4).

### Connect the USB cable

*To connect the USB cable:*

Connect the Type B end of the USB cable to the connector on the back of the instrument (shown below).

**Figure 3: Model 707B rear panel USB connection**

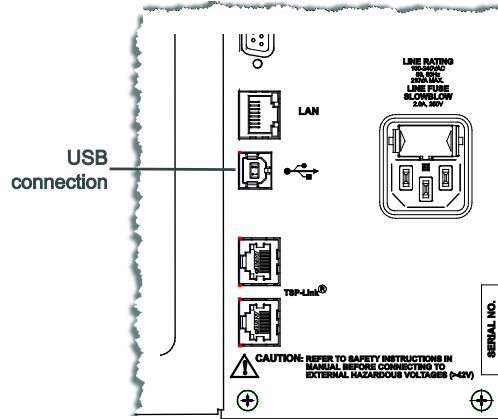

**Figure 4: Model 708B rear panel USB connection**

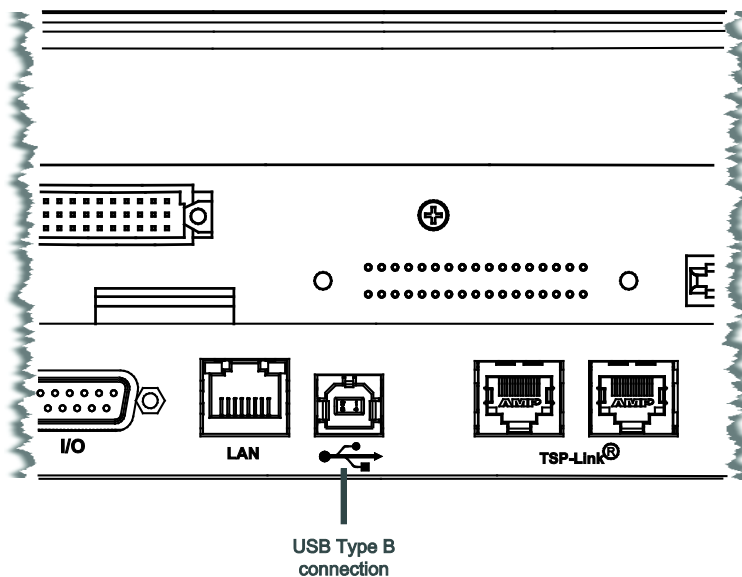

## Connect the LAN cable

Connect the LAN connector between the rear panel of the instrument and the host computer or network router. You can use an LAN crossover cable (RJ-45, male/male) or straight-through cable. The instrument automatically senses which cable you have connected.

The location of the LAN connector on the instrument is shown below.

### NOTE

The TSP-Link connectors will accept a LAN connection, but will not be identified as a LAN and will not connect properly. Be sure to connect the LAN connector correctly.

**Figure 5: Model 707B rear panel LAN connection**

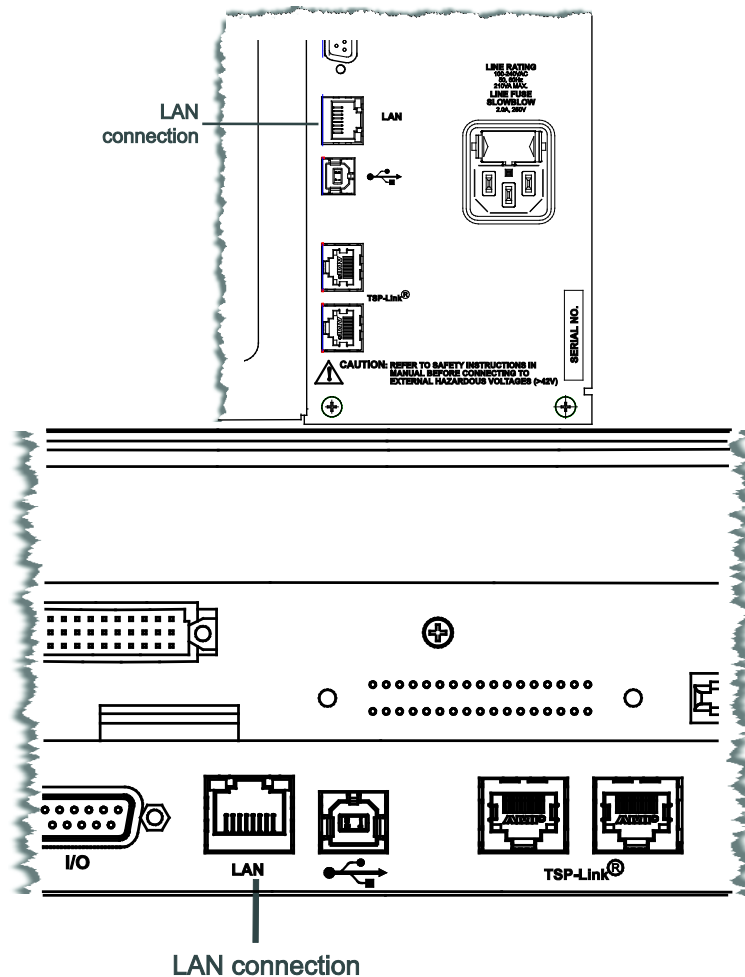

## Connect the GPIB cable

To connect an instrument to the GPIB bus, use a cable equipped with standard IEEE-488 connectors, as shown below.

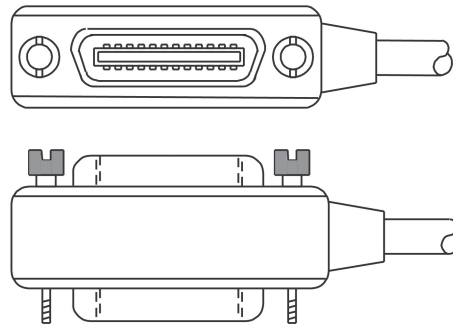
**Figure 6: GPIB connector**

To allow many parallel connections to one instrument, stack the connectors. Each connector has two screws to ensure that connections remain secure. The figure below shows a typical connection diagram for a test system with multiple instruments.

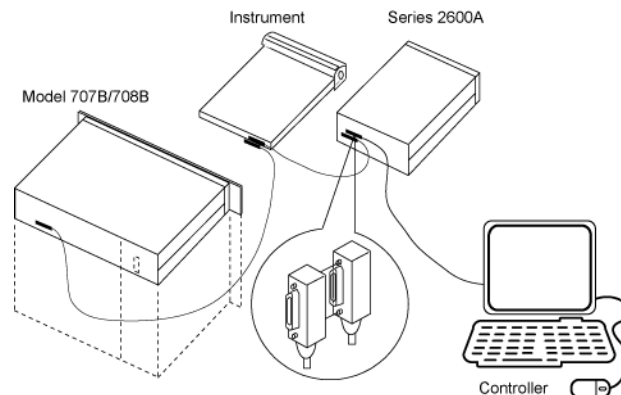
**Figure 7: IEEE-488 connections**

### CAUTION

To avoid possible mechanical damage, stack no more than three connectors on any one instrument. To minimize interference caused by electromagnetic radiation, use only shielded IEEE-488 cables. Contact Keithley Instruments for shielded cables.

To connect the instrument to the IEEE-488 bus, line up the cable connector with the connector on the rear panel. Install and tighten the screws securely, making sure not to overtighten them. The following figure shows the location of the connector.

**Figure 8: Model 707B rear panel IEEE-488 connection**

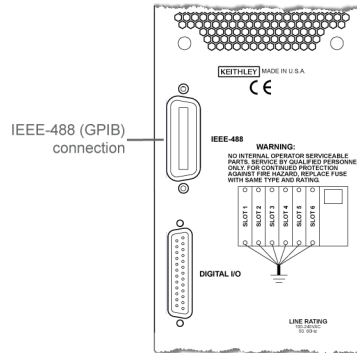

Connect any additional connectors from other instruments as required for your application. Make sure the other end of the cable is properly connected to the controller. You can only have 15 devices connected to an IEEE-488 bus, including the controller. The maximum cable length is either two meters (6.5 feet) multiplied by the number of devices or 20 meters (65.6 feet), whichever is less. Erratic bus operation may occur if you ignore these limits.

### Connect the TSP-Link cable

Connect the TSP-Link connector to one of the TSP-Link connectors on the rear panel of the instrument.

The location of the TSP-Link connectors on the instrument are shown below.

## NOTE

For an example of setting up a TSP-Linked system, see "Working with a Series 2600A" in the Models 707B and 708B User's Manual.

Figure 9: Model 708B rear panel TSP-Link connection

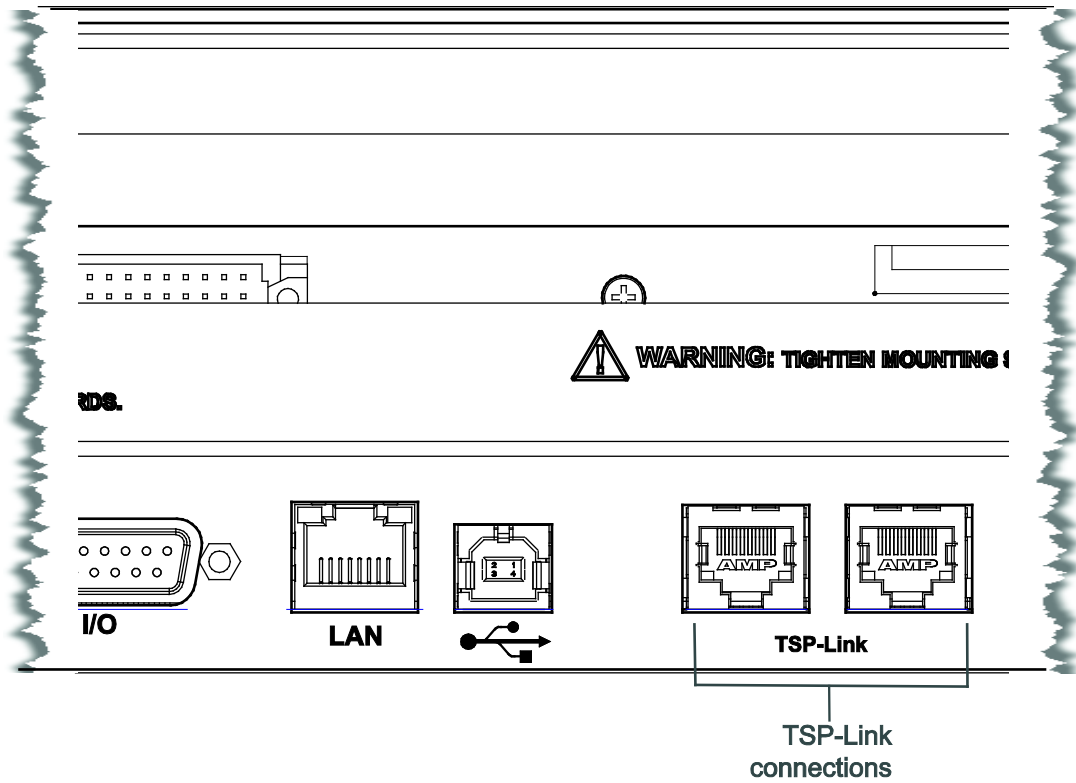
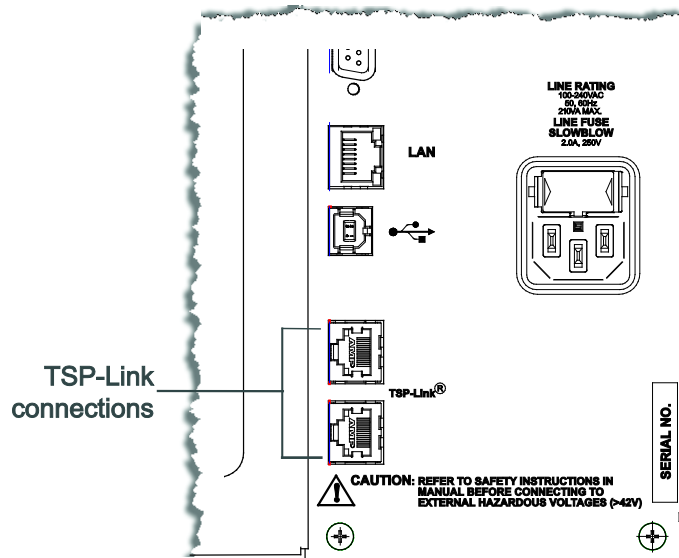

Figure 10: Model 707B rear panel TSP-Link connection



### Digital I/O port

The Models 707B and 708B have a digital input/output port that can be used to control external digital circuitry. For example, a handler that is used to perform binning operations can be used with a digital I/O port. The digital I/O port is a standard female DB-25 connector.

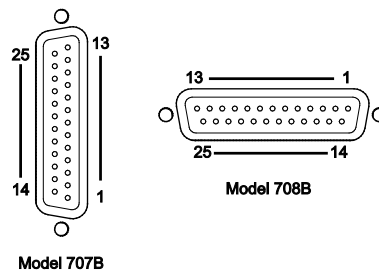

**Figure 11: Models 707B and 708B digital I/O ports**

Pin	Description
1	Digital I/O #1
...	...
14	Digital I/O #14
15-21	Ground
22	+5V D (fused, 600 mA)
23	Not connected; pin reserved for future use
24	Not connected; pin reserved for future use
25	+5V D (fused, 600 mA)

## NOTE

If you were using a Model 707A or 708A, see [Using Models 707A and 708A compatibility mode](#) (on page B-1).

### Connecting cables

Use a cable equipped with a standard male DB-25 connector (Keithley Instruments part number CA-126-1).

### Digital I/O lines (pins 1 through 14)

The port provides 14 digital I/O lines. Each output is set high (+5 V) or low (0 V) and can read high or low logic levels.

### +5 V output



The digital I/O port provides a +5 VDC output that is used to drive external logic circuitry. Maximum combined current output for all lines is 250 mA. These lines are protected by a self-resetting fuse with an hour recovery time.

## Controlling digital I/O lines



---

Although the digital I/O lines are primarily intended for use with a device handler for limit testing, they can also be used for other purposes such as controlling external logic circuits. You can control lines either from the front panel or over a remote interface.

### *To set digital I/O values from the front panel:*

1. Press the **MENU** key, select **DIGOUT**, and then press the **ENTER** key or press the navigation wheel .
2. Select **DIG-IO-OUTPUT**, and then press the **ENTER** key or the navigation wheel .
3. Set the decimal value as required to set digital I/O lines in the range of 0 to 16,383 (see the table in [Digital I/O bit weighting](#) (on page 2-9)), and then press the **ENTER** key or the navigation wheel .  
For example, to set digital I/O lines 3 and 8, set the value to 132.
4. Press the **EXIT (LOCAL)** key as needed to return to the main menu.

### *To write-protect specific digital I/O lines to prevent their values from being changed:*

1. Press the **MENU** key, then select **DIGIO**, and then press the **ENTER** key or the navigation wheel .
2. Select **WRITE-PROTECT**, and then press the **ENTER** key or the navigation wheel .
3. Set the decimal value as required to write-protect digital I/O lines within the range of 0 to 16,383 (see [Digital I/O bit weighting](#) (on page 2-9)), and then press the **ENTER** key or the navigation wheel .  
For example, to write-protect digital I/O lines 4 and 10, set the value to 520.
4. Press the **EXIT (LOCAL)** key as needed to return to the main menu.

To remove write protection, reset the decimal value to include only the lines that you want to write protect. To remove write protection from all lines, set the value to 0.

## Digital I/O bit weighting

---

Bit weighting for the digital I/O lines is shown in the following table.

**Digital bit weight**

Line #	Bit	Decimal weighting	Hexadecimal weighting
1	B1	1	0x0001
2	B2	2	0x0002
3	B3	4	0x0004
4	B4	8	0x0008
5	B5	16	0x0010
6	B6	32	0x0020
7	B7	64	0x0040
8	B8	128	0x0080
9	B9	256	0x0100
10	B10	512	0x0200
11	B11	1,024	0x0400
12	B12	2,048	0x0800
13	B13	4,096	0x1000
14	B14	8,192	0x2000

## Power-up

### Line power connection

Follow the procedure below to connect the Model 707B or 708B to line power and turn on the instrument.

The Model 707B or 708B operates from a line voltage of 100 V to 240 V at a frequency of 50 Hz or 60 Hz. Line voltage is automatically sensed (there are no switches to set). Make sure the operating voltage in your area is compatible.

#### WARNING

*The power cord supplied with the Model 707B or 708B contains a separate protective earth (safety ground) wire for use with grounded outlets. When proper connections are made, the instrument chassis is connected to power-line ground through the ground wire in the power cord. In addition, a redundant protective earth connection is provided through a screw on the rear panel. This terminal should be connected to a known protective earth. In the event of a failure, not using a properly grounded protective earth and grounded outlet may result in personal injury or death due to electric shock.*

*Do not replace detachable MAINS supply cords with inadequately rated cords. Failure to use properly rated cords may result in personal injury or death due to electric shock.*

#### CAUTION

Operating the instrument on an incorrect line voltage may cause damage to the instrument, possibly voiding the warranty.

**To connect the Model 707B or 708B to line power and turn on the instrument:**

1. Make sure that the front panel power switch is in the off (O) position. See [Front-panel operation](#) (on page 2-11) for switch location.
2. Connect the female end of the supplied power cord to the power connection (AC receptacle) on the rear panel. See [Rear panel overview](#) (on page 2-1) for connector location.
3. Connect the other end of the power cord to a grounded AC outlet.
4. Turn on the instrument by pressing the front panel power switch to the on (I) position.

### Power-up sequence

When the instrument is turned on, the instrument performs self-tests and momentarily lights all segments and indicators on the display. If a failure is detected, the instrument momentarily displays an error message. Error messages are listed in [Error and status messages](#) (on page 8-1).

If there are no errors, three dots are briefly displayed. On the Model 707B, the crosspoint display shows the text "Wait for Init to End." When initialization is complete, the bottom display shows "KEITHLEY Model 707B." The Model 708B displays "KEITHLEY Model 708B."

## Front-panel operation

The front panel of the Keithley Instruments Model 707B or 708B contains the following items:

- The display
- The crosspoint display (Model 707B only)
- The keys and navigation wheel
- The LAN status indicator
- The POWER button

You can use the keys, displays, and the navigation wheel to change the selected channel or channel pattern. You can also use them to access, view, and edit the menu items. The crosspoint display on the Model 707B shows you which channels are opened and closed.

### Model 707B front panel

The front panel of the Model 707B is shown below.

Figure 12: Model 707B front panel

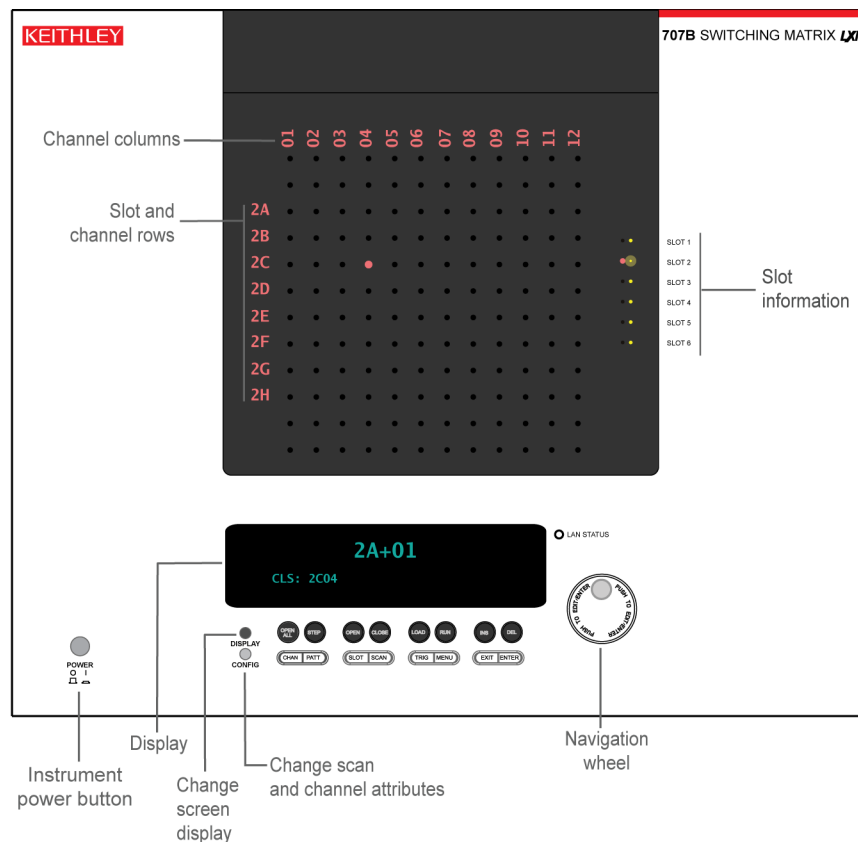

### Model 708B front panel

The front panel of the Model 708B is shown below.

Figure 13: Model 708B front panel

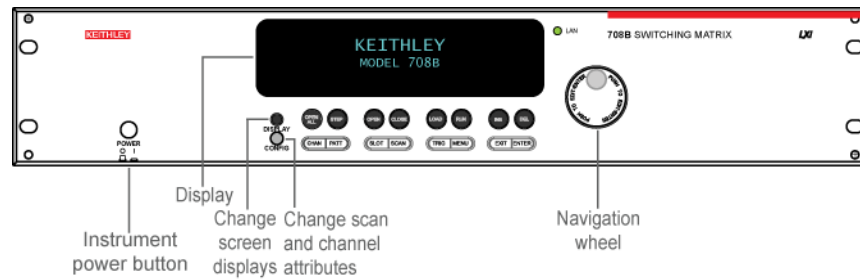

## Display

### NOTE

This section describes the front-panel display of the Model 708B and the bottom display of the Model 707B.

During operation, the display provides information about the selected channel, channel pattern, channel state, and errors. You can press **DISPLAY** to cycle between the display of the channel or pattern, the closed channel list, or a screen message.

During setup, the display shows menu choices that you can use to configure the instrument.

### Display during operation

During operation, the display shows the control status (local or remote) and the current channel, and indicates if any channels are closed. An example is shown below.

If REM is not displayed, control is through the front panel.

Figure 14: Display during operation

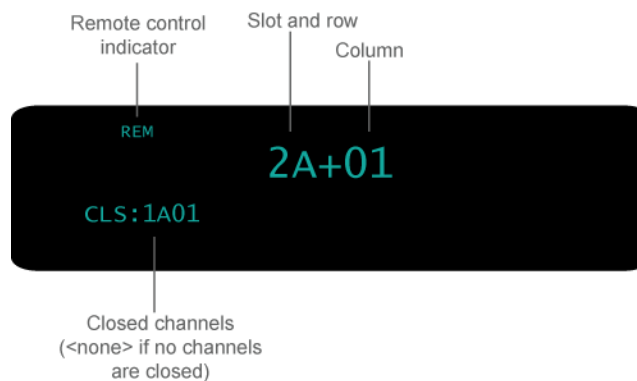

The control status is shown in the upper left corner of the display. If REM is displayed, the instrument is being controlled remotely (through GPIB, LAN, or USB).

If you are connecting to the instrument through GPIB, you may also see the following indicators:

- TALK: Instrument is addressed to talk
- LSTN: Instrument is addressed to listen
- SRQ: Service request
- REM: Remote communication

By default, the top line of the display shows the slot, row, and column of the selected channel. If labels have been set up for your instrument, you might see four-character labels for your channels, such as GATE+SMU1. See [Set up labels](#) (on page 2-91) for information on setting up labels.

**To change the selected channel:**

1. Press the navigation wheel to select the row.
2. Turn the navigation wheel to go to a different row.
3. Press the navigation wheel again to select the column.
4. Turn the wheel to go to a new column.
5. Press the navigation wheel or **ENTER** when selection is complete. The new channel is displayed.



After CLS (on the lower line of the display), the closed channels are listed. If no channels are closed, <none> is displayed here. If the list of closed channels extends past one screen, "..." is displayed at the end of the lower line. To see the full list of closed channels, press **DISPLAY** until the list of closed channels is displayed.

## NOTE

For the Model 707B, also see [Selecting channels from the front panel](#) (on page 2-15) to select a channel.

## Display during setup

During setup, the display shows menu choices that you can use to configure the instrument.

To use the menus, you use the navigation wheel  to scroll through menu options. When a menu item is selected, it blinks. Press the navigation wheel  or **ENTER** to select an option.

In the following figure, the Main Menu is displayed, with arrows showing that there are additional menu items.

**Figure 15: Front-panel Main Menu display**

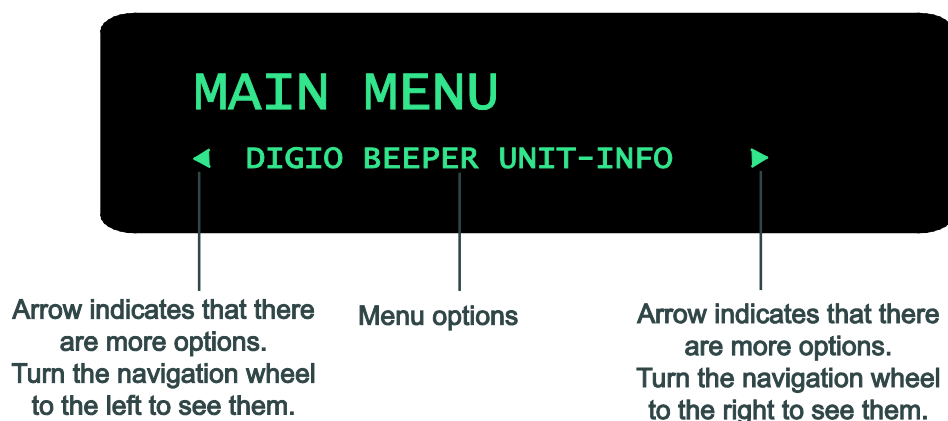

## Crosspoint display (Model 707B only)

The crosspoint display on the front panel of the Model 707B displays information about the slots that contain cards and the open and closed state of the channels for one card slot at a time. If there are no cards in the instrument's slots, the crosspoint display shows "No card in unit."

**Figure 16: Model 707B crosspoint display**

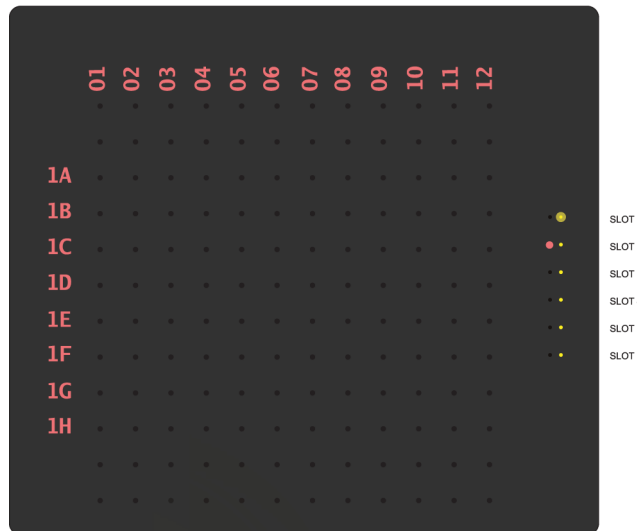

The crosspoint display has a list of slots on the right. To the left of the slot list are lights that show you an overview of the cards in the instrument's slots.

**Figure 17: Model 707B slot indicators**

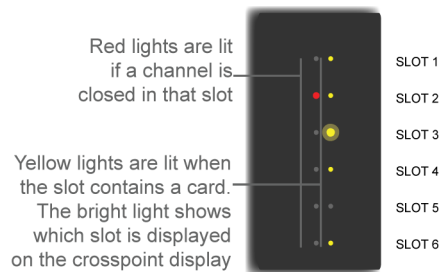

The red lights indicate closed channels. If a red light is on, a channel in that slot is closed. If the red light is not lit for a slot, all channels in that slot are open. In the figure above, the card in slot 2 has at least one closed channel.

The yellow lights indicate which slots contain a card and which slot is presently displayed on the crosspoint display. When a yellow light is on, the slot contains a card. When a yellow light is off, the slot does not contain a card. If the yellow light is brighter than the others, that slot is being displayed on the crosspoint display. In the figure above, there are cards in five slots, no card in slot 5, and the channels for the card in slot 3 are displayed on the crosspoint display.

### Crosspoint display description

The crosspoint display displays all channels for one card slot at a time. If there are no cards in the instrument's slots, the crosspoint display shows "No card in unit."

The rows are labeled by default with the slot number following by the row number. For example, slot 1 would start with 1A, 1B and slot 2 would start with 2A, 2B and so on.

The columns are labeled by default as 01, 02, and so on.

If a red light is on at a row-column crosspoint, the channel at the crosspoint is closed. If no red light is on, the channel is open. Channels appear in different LED intensities when a row is selected. Channels that are closed appear brighter than ones that are presently selected.

You can change the label names; see [Set up labels](#) (on page 2-91).

You can also open and close channels by pressing **CHAN** to use the [CHANNEL ACTION menu options](#) (on page 2-20).



### Selecting channels from the front panel

From the front panel, you can change the display to show another card slot, choose a specific channel, and open and close channels. For the 707B, the crosspoint display shows you the status of the channels for one card at a time.

**To display a different slot:**

Press the navigation wheel, then turn the navigation wheel to the right to go to the next slot or to the left to go to the previous slot. You must go through all of the rows on one slot to go to the next slot.

**To choose a specific row:**

1. When you are displaying the slot that contains the row, press the navigation wheel . The red lights for that row are displayed.
2. Turn the navigation wheel  to go to the row you want to select.
3. Press the navigation wheel  to select the row. The red lights for each crosspoint in the row are on, as shown in the following figure.

**Figure 18: One row selected**





**NOTE**

On the Model 707B, if you scroll past the last row, you will go to the next slot.



**To choose a specific column in the selected row:**

1. After choosing the row, press the navigation wheel . A column of red lights is displayed.
2. Turn the navigation wheel  to go to the column. Note that scrolling through the columns will not scroll through slots as scrolling through rows does.
3. Press the navigation wheel  to select the column and row. This channel is now displayed on the bottom display.

**To open and close channels:**

You can use the crosspoint display to view the open or closed status of a specific channel crosspoint.

After selecting the channel crosspoint so that the channel is displayed on the bottom display, you can press **OPEN** or **CLOSE** to open or close the channel.

## Keys and navigation wheel



The keys and navigation wheel  on the front panel allow you to turn on, set up, and operate the instrument from the front panel.

The **POWER** switch. Press this key to turn the instrument on (I). Press it again to turn the instrument off (O).

### Navigation wheel





---

Turn the navigation wheel  to scroll to a menu option or to change the selected value.

Push the navigation wheel  to open menus or to select a menu option or a value. In most cases, pressing the navigation wheel  performs the same action as pressing the **ENTER** key.

On the Model 707B, you can use the navigation wheel  to control which slot is displayed on the crosspoint display.

**To change a value with multiple characters:**

1. Turn the navigation wheel  to go to the character you want to change (the character blinks when selected).
2. Press the navigation wheel  to edit that character.
3. Turn the navigation wheel  to change the value.
4. Press the navigation wheel  to keep the change.
5. Repeat these steps as needed to change the value.
6. Press the **ENTER** key or the navigation wheel  when finished changing all the characters.

### Front-panel keys

---

The **DISPLAY** key cycles between three screens: The channel display or pattern display, the closed channel list, and the user screen text, which is set with [display.settext\(\)](#) (on page 7-79).

When the closed channel listing is displayed, if the list of channels is longer than one screen, you can use the navigation wheel  to scroll through the list of closed channels.

The **CONFIG** key **c** accesses attribute menus in which you can configure channels and scans.

**CONFIG** and then **CHAN** opens the Channel Attribute menu.

**CONFIG** and then **SCAN** opens the Scan Attribute menu.

**Keys**

The top row of keys under the display allows you to open and close channels, work with scan lists, and load and run scripts.

**Figure 19: Models 707B and 708B top row of keys**



Key descriptions	
Key	Description
<b>OPEN ALL</b>	Opens all closed channels.
<b>STEP</b>	If a scan list has been defined, press <b>STEP</b> to step through the list. Each press is one scan step. See <a href="#">Basic scan procedure</a> (on page 3-5).
<b>OPEN</b>	Opens the selected channel or channel pattern.
<b>CLOSE</b>	Closes the selected channel or channel pattern.
<b>LOAD</b>	Loads code or scripts that can be run from the front panel.
<b>RUN</b>	Runs the last code or script selected through the <b>LOAD</b> key.
<b>INS</b>	Appends the selected channel or channel pattern to the scan list.
<b>DEL</b>	Deletes the first occurrence of the selected channel or channel pattern from the scan list.

Also see:

- For detail on using **OPEN ALL**, **STEP**, **OPEN**, and **CLOSE**: [Closing and opening channels](#) (on page 2-86).
- For detail on using **LOAD** and **RUN**: [LOAD TEST menu options](#) (on page 2-19).
- For detail on using **INS** and **DEL**: [Front-panel scanning](#) (on page 3-6).

The bottom row of keys allow you access menus and set up channels, patterns, cards, scans, triggers, and general instrument operation.

**Figure 20: Bottom row of keys**



Key descriptions	
Key	Description
<b>CHAN</b>	If a channel is displayed, opens the <a href="#">CHANNEL ACTION menu options</a> (on page 2-20), which allows you to open and close channels. If a pattern is displayed, pressing <b>CHAN</b> switches to channel view.
<b>PATT</b>	If a pattern is displayed, opens the <a href="#">PATTERN ACTION menu options</a> (on page 2-21), which allows you to manage patterns, open and close patterns, and reset them. If a channel is displayed, pressing <b>PATT</b> changes to display a pattern.
<b>SLOT</b>	Displays information about the installed cards and the instrument. Information includes the firmware revision, model name, and model number.
<b>SCAN</b>	Opens the <a href="#">SCAN ACTION menu options</a> (on page 2-21), which allows you to run, manage, view, and reset scan lists. See <a href="#">Scanning and triggering</a> (on page 3-1).
<b>TRIG</b>	Generates a trigger that can be used in a script or the trigger model. See <a href="#">Scanning and triggering</a> (on page 3-1). Also see <a href="#">display.trigger.EVENT_ID</a> (on page 7-80).
<b>MENU</b>	Opens the <a href="#">Main menu options</a> (on page 2-22), which allows you to manage scripts, manage communications, select channel connections, test the keys, test the display, manage digital I/O settings, set up the beeper, and display instrument information.
<b>EXIT</b>	This key: <ul style="list-style-type: none"> <li>• Cancels the current selection and returns to the previous menu item.</li> <li>• Exits remote operation so you can control the instrument from the front panel.</li> <li>• Aborts a scan that is running.</li> <li>• Aborts a script that is executing.</li> </ul>
<b>ENTER</b>	Accepts the current selection or brings up the next menu option. In most cases, pressing <b>ENTER</b> is the same as pressing the navigation wheel  .

## LAN status indicator

The LAN status indicator is lit when the instrument is connected through the local area network (LAN) with no errors.

If this is not lit, the instrument is not connected through the LAN or there is a connection problem.

If you are using the web interface, the LAN status indicator blinks when you click the **ID** button in the upper right corner on the home page.

See [LAN communications](#) (on page 2-35) for more information.

## Set beeper and key clicks



---

You can turn the instrument beeper and key click sounds on or off.

### NOTE

Disabling the beeper also disables the keyclicks. To enable keyclicks, you must also enable the beeper.

*To change the beeper or key click sounds from the front panel:*

1. Press **MENU**.
2. Use the navigation wheel  to select BEEPER.
3. Select KEYCLICK or BEEP.
4. Select ENABLE or DISABLE.
5. Press **ENTER** or press the navigation wheel  to save the change.
6. Press **EXIT (LOCAL)** to return to the Main Menu.

## Menu options

The menus that can be accessed from the front panel of the instrument allow you to set up and run the instrument.

### LOAD TEST menu options

---

Allows you to run scripts and code from the front panel that you created through the communication interface, or configuration scripts created by pressing the front-panel MENU key, then selecting SCRIPT > CREATE-CONFIG.

To open this menu, press **LOAD**.

The User option loads code that was added to Load Test with the [display.loadmenu.add\(\)](#) (on page 7-70) command.

The Scripts option loads named scripts that were added to the run-time environment.

After selecting code or script from the User or Scripts option, you can press **RUN** to execute the selected code or script.

### Channel Attribute Menu options

---

The options in the Channel Attribute Menu allow you to configure channels from the front panel.

To open the Channel Attribute Menu, go to channel view. Select the channel for which you want to set attributes, then press **CONFIG**, then press **CHAN**.

The options are:

- **LABEL**: Sets the label that is displayed on the front panel for the specified channel.
- **LABEL-ROW**: Sets the label that is displayed on the front panel for the specified row.
- **LABEL-COL**: Sets the label that is displayed on the front panel for the specified column.
- **FORBID**: Allows you to prevent the channel from being closed.
- **DELAY**: Sets delay time (in addition to settling time) for the specified channels. Enter the value for the delay in 1ms steps from 0 to 60 seconds for a channel.
- **COUNT**: Displays closure cycles for the specified channel.

For more information about channel attribute settings, see [Channel attributes](#) (on page 2-90).

---

### Scan Attribute Menu options

Use the options in this menu to configure scans from the front panel.

To open this menu, press **CONFIG**, then press **SCAN**.

Options include:

- **ADD**: Reminder that you need to use **INS** to add channels or channel patterns to a scan.
- **BYPASS**: Allows you to bypass the trigger for the first step of the first scan. See [Trigger mode](#) (on page 3-1) for more information.
- **MODE**: Selects how the scan initializes the instrument when the scan is executed. Choose OPEN-ALL to open all channels or OPEN-SELECT to open only those involved in the scan.
- **SCAN\_CNT**: Sets the scan count, which is the number of times that the instrument repeats the steps in a scan. After repeating the steps this number of times, the instrument returns to idle.

For information on configuring scans, see [Changing attributes of an existing scan](#) (on page 3-6).

---

### CHANNEL ACTION menu options

Allows you to change the state of channels from the front panel.

To open this menu, display a channel, then press **CHAN**.

Options include:

- **OPEN**: Opens the selected channel.
- **CLOSE**: Closes the selected channel.
- **EXCLOSE**: Closes the selected channel and opens any closed channels on the instrument.
- **EXSLOTCLOSE**: Closes the specified channel and opens any closed channels on the same slot. Channels on other slots remain closed.
- **RESET**: Restores the factory default settings to the selected channel. Resetting a channel deletes any channel patterns that contain that channel.

For more information, see [Working with channels](#) (on page 2-80).

## **PATTERN ACTION menu options**

---

Allows you to configure and change patterns from the front panel.

To open this menu, in pattern view, press **PATT**.

Options include:

- **CREATE**: If no patterns have been created, this is the only option that is displayed. Allows you to create a new pattern.
- **OPEN**: Opens the channels in the selected channel pattern.
- **CLOSE**: Closes the channels in the selected channel pattern. These closures are appended to any channels that are already closed.
- **EXCLOSE**: Closes the channels in the selected pattern so that the channels associated with the pattern are exclusively closed. Any previously closed channels are opened.
- **EXSLOTCLOSE**: Exclusively closes the channels in the specified channel pattern for the selected slots.
- **VIEW**: Displays the channels that are in the selected pattern.
- **DELETE**: Deletes the channel pattern.
- **RESET**: Displays options that allow you to reset the channels in the selected channel pattern to factory default settings. Resetting a channel pattern causes that pattern to be deleted because when channels are reset, they delete patterns that contain them.

For information about working with channel patterns, see [Channel patterns](#) (on page 2-92).

## **SCAN ACTION menu options**

---

Allows you to work with the scan lists from the front panel. You must have a scan list created before using this option. See [Basic scan procedure](#) (on page 3-5) for information.

To open this menu, press **SCAN**.

Options include:

- **BACKGROUND**: Runs the scan while allowing front panel operation.
- **CREATE**: Reminder that you must use the INS key to create a scan list.
- **LIST**: Displays the scan list. Use the navigation wheel  to scroll through the channels.
- **CLEAR**: Clears the scan list.
- **RESET**: Resets the scan settings to the factory default settings, which includes clearing the scan list.

## Main menu options

The options in the main menu allow you to create a configuration script, set up communications, verify and set some instrument operation, set up digital input/output, and get instrument information.

To open the main menu, press **MENU**.

### Main Menu options

Option	Description	Also see
<b>SCRIPT</b>	Option for creating a script that stores the present configuration of the instrument.	<a href="#">Save the present configuration</a> (on page 2-98)
<b>GPIB</b>	Options for setting up GPIB communications.	<a href="#">GPIB setup</a> (on page 2-30)
<b>DDC</b>	Options that allow you to run existing 707A or 708A applications.	<a href="#">Using Models 707A and 708A compatibility mode</a> (on page B-1)
<b>LAN</b>	Options for setting up LAN communications.	<a href="#">LAN communications</a> (on page 2-35)
<b>TSPLINK</b>	Options for configuring TSP-Link.	<a href="#">TSP-Link system</a> (on page 6-44)
<b>CHANNEL</b>	Select a connection rule to determine the order in which switch channels are opened and closed, and select whether to connect sequentially.	<a href="#">Connection methods for close operations</a> (on page 2-82)
<b>DISPLAY</b>	Verify operation of the keys, display, and crosspoint display LEDs.	<a href="#">Testing the display, keys, and channel matrix</a> (on page 8-9)
<b>DIGIO</b>	Options for controlling the digital input and output lines.	<a href="#">Digital I/O port</a> (on page 2-7)
<b>BEEPER</b>	Enables or disables the instrument key clicks and beeps.	<a href="#">Set beeper and key clicks</a> (on page 2-19)
<b>UNIT-INFO</b>	Displays the firmware version, serial number, memory usage, and fan status. Fan status is 707B only.	<a href="#">Check fan status</a> (on page A-2)
<b>RESET</b>	Resets the instrument.	<a href="#">Reset</a> (on page 5-11)

## Remote communications interfaces

This section shows you how to connect instruments to the following remote communication interfaces:

- Universal serial bus (USB)
- Local area network (LAN)
- General purpose interface bus (GPIB or IEEE-488)

The USB can be used for single ASCII-based commands.

It describes how to configure and troubleshoot these interfaces on computers with Windows 2000, Windows XP, Windows Vista, and Windows 7 operating systems.

It also describes the I/O software, drivers, and application software that can be used with Keithley's instruments.

## USB communications

To use the rear-panel USB port, you must have the Virtual Instrument Software Architecture (VISA) layer on the host computer. See [How to install the Keithley I/O Layer](#) (on page 2-59) for more information.

VISA contains a USB-class driver for the USB Test and Measurement Class (USBTMC) protocol that, once installed, allows the Microsoft® Windows® operating system to recognize the instrument.

When you connect a USB device that implements the USBTMC or USBTMC-USB488 protocol to the computer, the VISA driver automatically detects the device. Note that the VISA driver only automatically recognizes USBTMC and USBTMC-USB488 devices. It does not recognize other USB devices, such as printers, scanners, and storage devices.

In this section, "USB instruments" refers to devices that implement the USBTMC or USBTMC-USB488 protocol.

### NOTE

The full version of National Instruments (NI®) VISA provides a utility to create a USB driver for any other kind of USB device that you want to communicate with VISA. For more information, see the [National Instruments](#) (see National Instruments - <http://www.ni.com>) website.

## Using USB

A USB cable is shipped with the instrument. If the original cable is not available, you will need a USB cable with a USB Type B connector end and a USB type A connector end. You will need a separate USB cable for each instrument you plan to connect to the computer at the same time using the USB interface.

### *To use a USB connection:*

1. Connect the Type A end of the cable to the host computer.
2. Connect the Type B end of the cable to the instrument.
3. Turn power to the instrument on.
4. When the host computer detects the new USB connection, the Found New Hardware Wizard starts.
5. On the "Can Windows connect to Windows Update to search for software?" dialog box, click **No**, and then click **Next**.
6. On the "USB Test and Measurement device" dialog box, click **Next**, and then click **Finish**.

## Communicate with the instrument

To communicate with the USB device, you need to use NI-VISA™. VISA requires a resource string in the following format to connect to the correct USB instrument:

```
USB[board]::manufacturer ID::model code::serial number[::USB interface number][::INSTR]
```

This requires that you determine the parameters. You can gather this information by running a utility that automatically detects all instruments connected to the computer.

If you installed the Keithley I/O Layer, the Keithley Configuration Panel is available from the Microsoft® Windows® Start menu in the Keithley Instruments menu.



**To use the Keithley Configuration Panel to determine the VISA resource string:**

1. Start the Keithley Configuration Panel. The Select Operation dialog box is displayed.
2. Select **Add**.

**Figure 21: Select Operation dialog box**

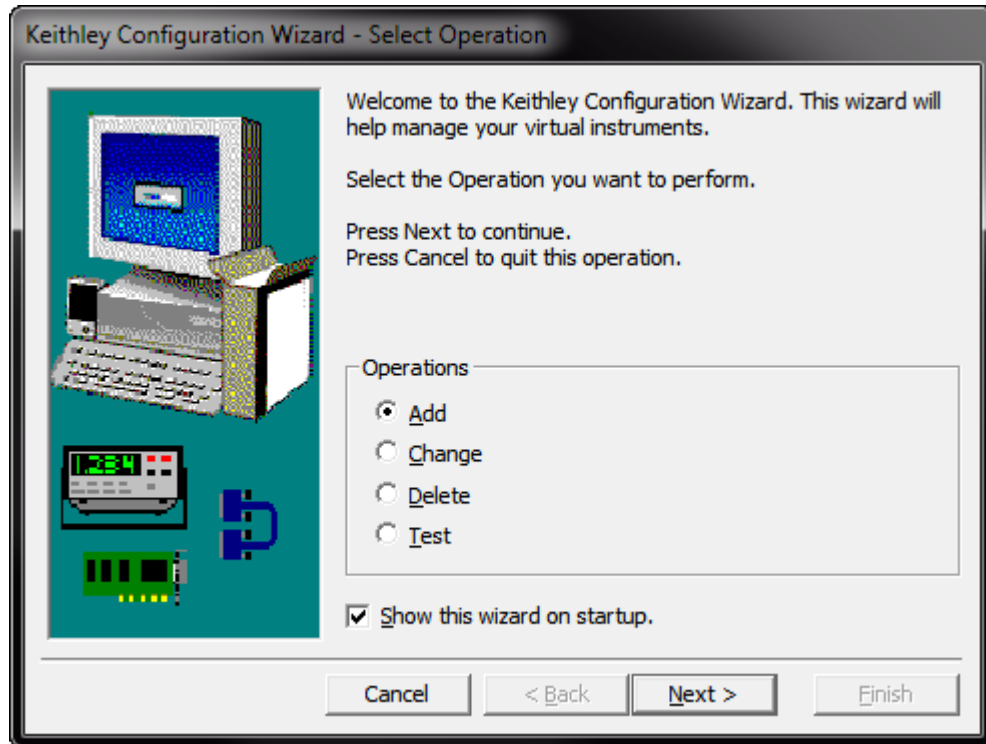

3. Click **Next**. The Select Communication Bus dialog box is displayed.

Figure 22: Select Communication Bus dialog box

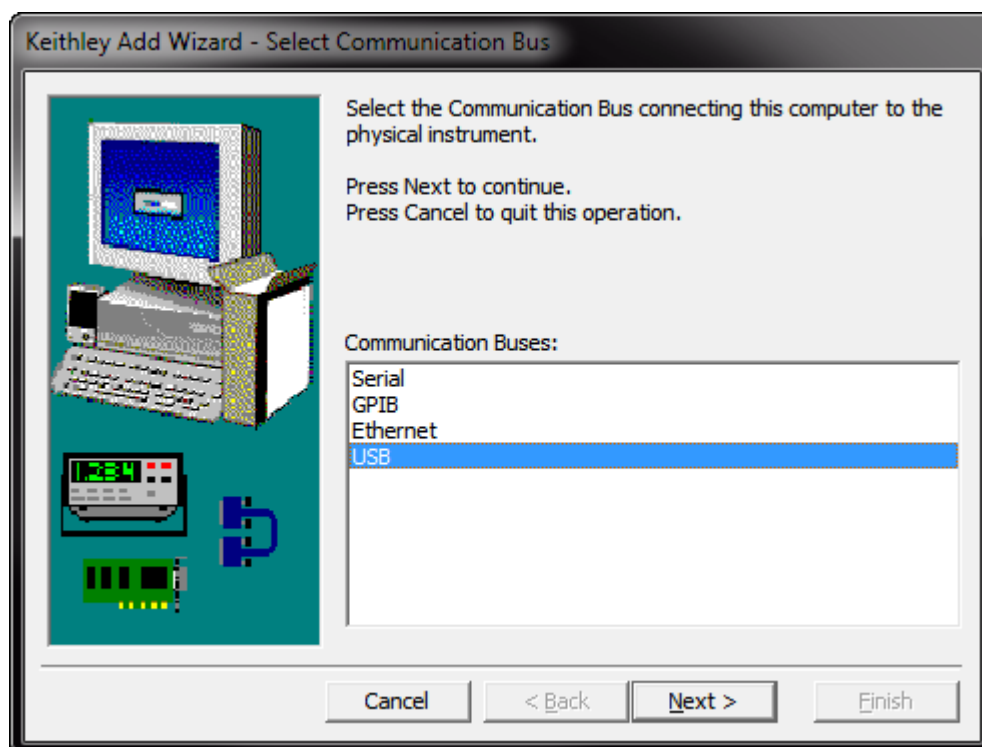

4. Select **USB**.
5. Click **Next**. The Select Instrument Driver dialog box is displayed.

Figure 23: Select Instrument Driver dialog box

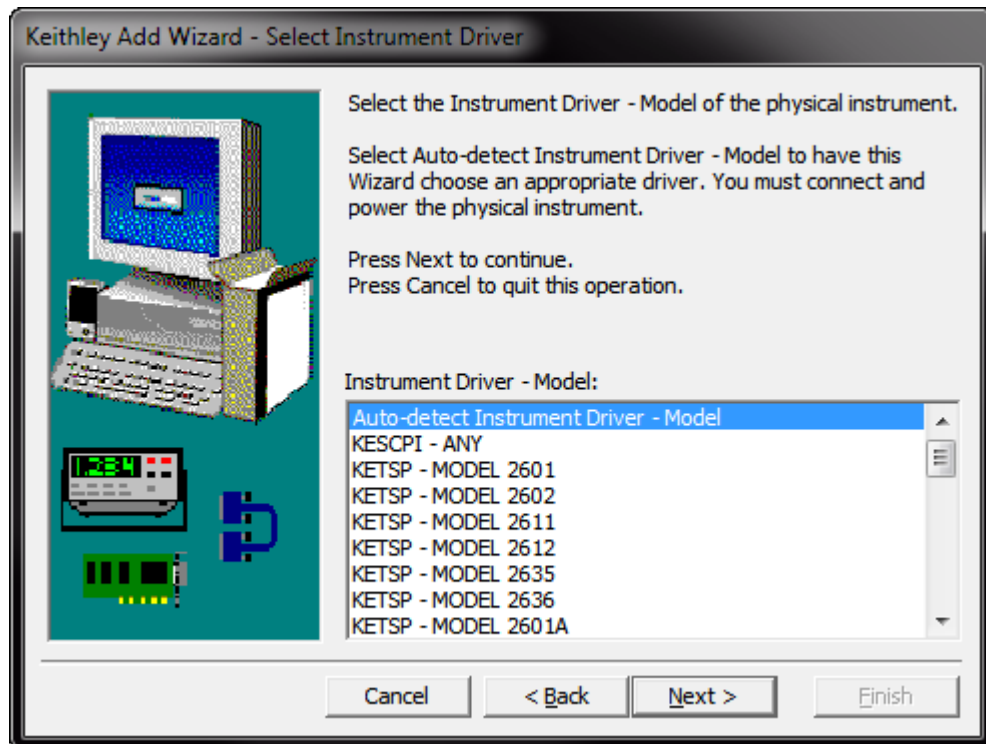

6. Select **Auto-detect Instrument Driver - Model**.
7. Click **Next**. The Configure USB Instrument dialog box is displayed with the detected instrument VISA resource string displayed.

Figure 24: Configure USB Instrument dialog box

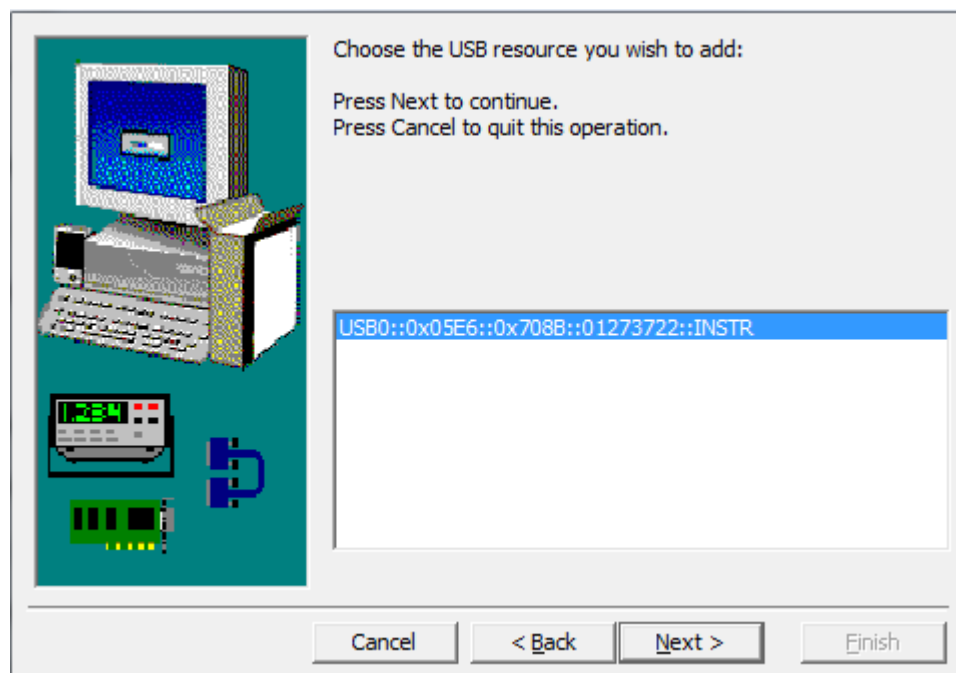

- Click **Next**. The Name Virtual Instrument dialog box is displayed.

**Figure 25: Name Virtual Instrument dialog box**

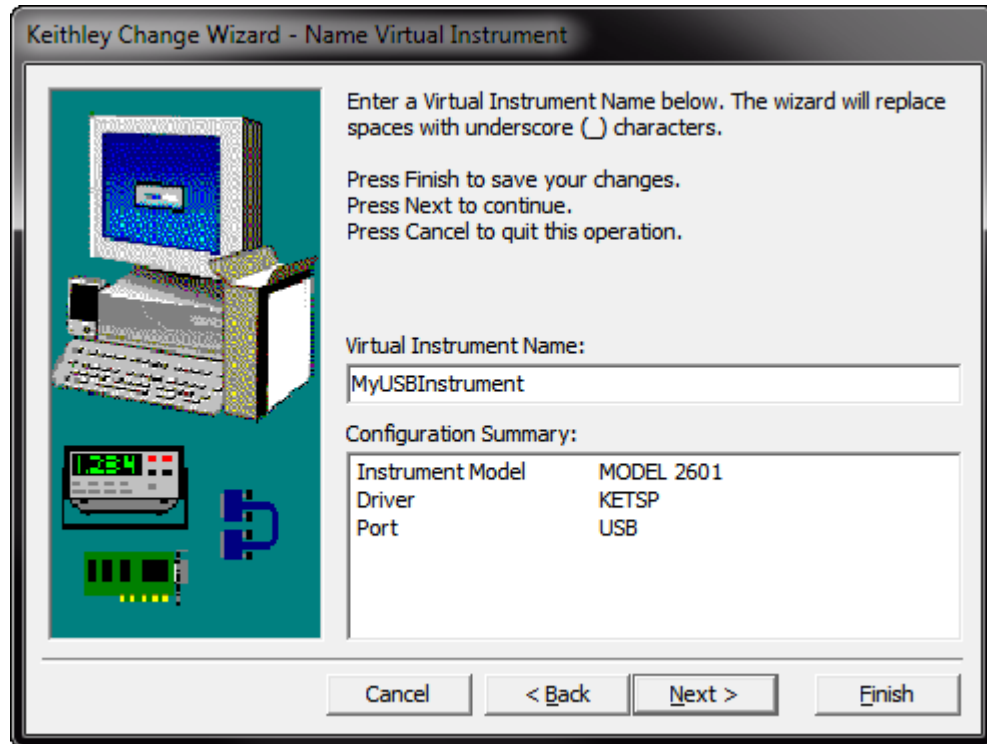

- In the Virtual Instrument Name box, enter a name that you want to use to refer to the instrument.
- Click **Finish**.
- Click **Cancel** to close the Wizard.
- Save the configuration. From the Configuration Utility, select **File > Save**.
- In the Keithley Communicator, select **File > Open Instrument** to open the instrument you just named.

Figure 26: Keithley Communicator Open an Instrument

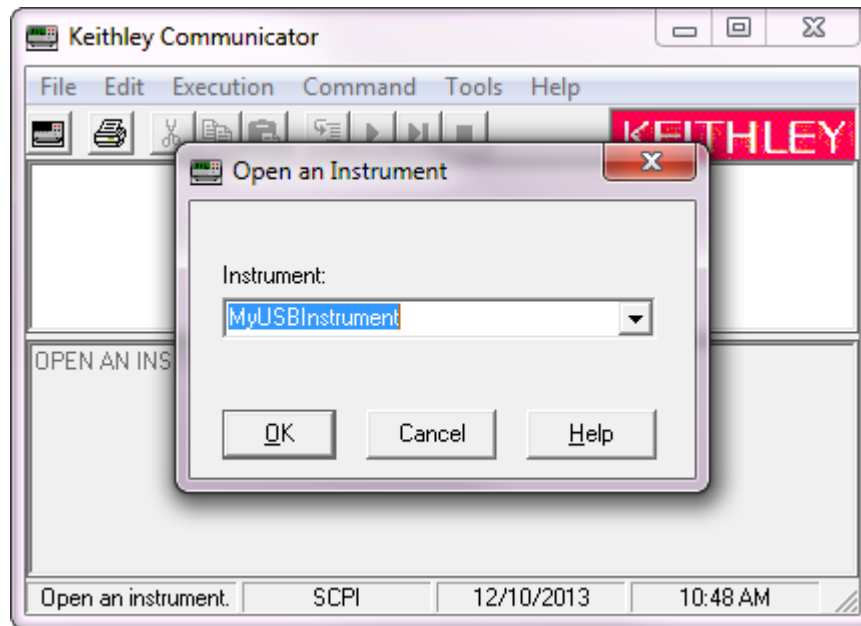

14. Click **OK**.
15. Send a command to the instrument and see if it responds.

**Figure 27: Send a command to the instrument**

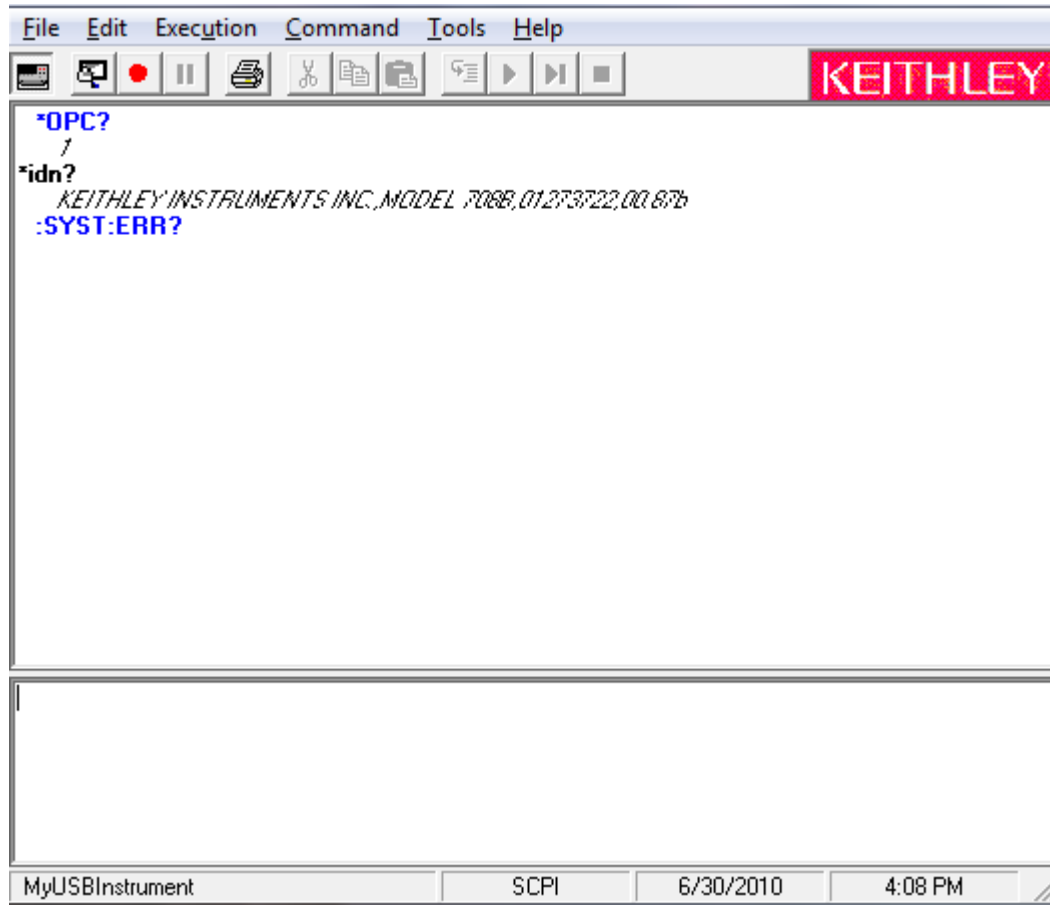

## NOTE

If you have a full version of NI VISA on your system, you can run NI-MAX or the VISA Interactive Utility. See their documentation for information.

If you have the Agilent IO Libraries on your system, you can run Agilent Connection Expert to check out your USB instruments. See their documentation for information.

## Additional USB information

This section provides further details and more advanced information about the USB bus and test-and-measurement instruments.

### Connecting multiple USB instruments to the computer

The most convenient way to connect USB instrumentation to the computer is to plug a USB cable directly from the instrument to the computer. If you have more than one USB instrument or have other USB devices, such as printers, keyboards, and mice, you might not have enough USB connectors on the computer.

To gain more ports, you can use a USB hub or add more USB controller cards if you have available PCI or PCI Express slots.

There are two types of USB hubs that you can use with Model 707B or 708B:

- **Bus powered:** This type of hub draws its power from the USB bus and can only supply 100 mA (USB 2.0) per port.
- **Self powered:** This type of hub has an external power supply and can supply up to 500 mA per port (USB 2.0).

### USB VISA identifiers

The USB identifiers to communicate with your Keithley instrument using VISA are:

- **707B:** USB0::0x05E6::0x707B::[serial number]::INSTR
- **708B:** USB0::0x05E6::0x708B::[serial number]::INSTR

Where:

- USB0: USB interface
- 0x05e6: The Keithley vendor ID (assigned to Keithley Instruments by the USB Implementers Forum, Inc.)
- 707B or 708B: Instrument model number
- [serial number]: The serial number of the instrument (the serial number is also on the rear panel)
- INSTR: Use the USBTMC protocol

## GPIB setup

This section contains information about GPIB standards, connections, and address selection.

### NOTE

The GPIB connector is optional and may not be present on your instrument.

### GPIB standards

The GPIB is the IEEE-488 instrumentation data bus, which uses hardware and programming standards originally adopted by the Institute of Electrical and Electronic Engineers (IEEE) in 1975. The instrument is IEEE Std 488.1 compliant and supports IEEE Std 488.2 common commands and status model topology.

## GPIB quick start

---

### Install the GPIB driver software

Check the documentation for your GPIB controller for information about where to acquire drivers. Keithley Instruments also recommends that you check the website of the GPIB controller for the latest version of drivers or software.

It is important that you install the drivers before you connect the hardware. This prevents associating the incorrect driver to the hardware.

### Install the GPIB cards in your computer

Refer to the documentation from the GPIB controller vendor for information about installing the GPIB controllers.

### Connect the GPIB cable

To connect an instrument to the GPIB bus, use a cable equipped with standard IEEE-488 connectors, as shown below.

**Figure 28: GPIB connector**

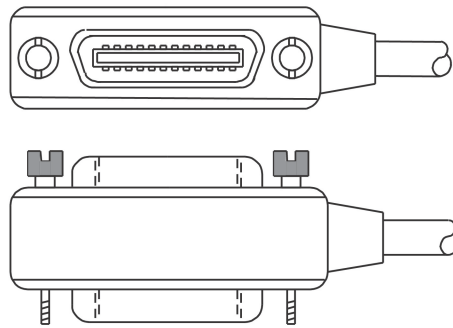

To allow many parallel connections to one instrument, stack the connectors. Each connector has two screws to ensure that connections remain secure. The figure below shows a typical connection diagram for a test system with multiple instruments.

**Figure 29: IEEE-488 connections**

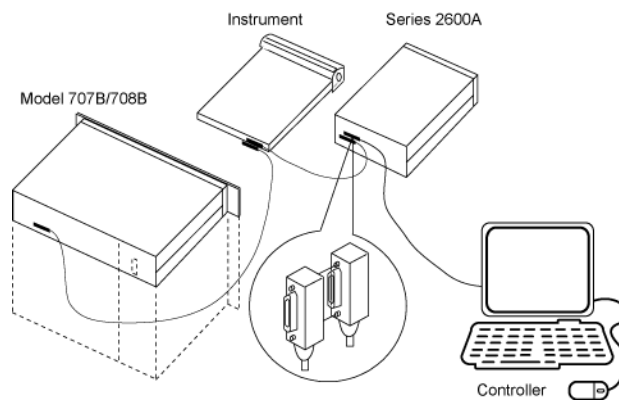



**⚠ CAUTION**

To avoid possible mechanical damage, stack no more than three connectors on any one instrument. To minimize interference caused by electromagnetic radiation, use only shielded IEEE-488 cables. Contact Keithley Instruments for shielded cables.

To connect the instrument to the IEEE-488 bus, line up the cable connector with the connector on the rear panel. Install and tighten the screws securely, making sure not to overtighten them. The following figure shows the location of the connector.

**Figure 30: Model 707B rear panel IEEE-488 connection**

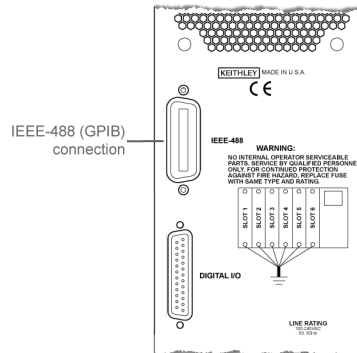

Connect any additional connectors from other instruments as required for your application. Make sure the other end of the cable is properly connected to the controller. You can only have 15 devices connected to an IEEE-488 bus, including the controller. The maximum cable length is either two meters (6.5 feet) multiplied by the number of devices or 20 meters (65.6 feet), whichever is less. Erratic bus operation may occur if you ignore these limits.

**Figure 31: Model 707B rear panel IEEE-488 connection**

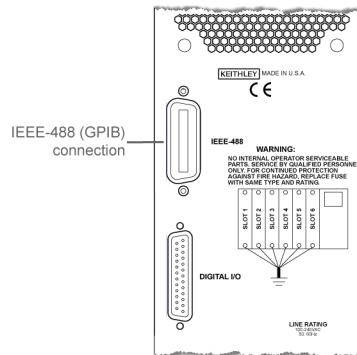
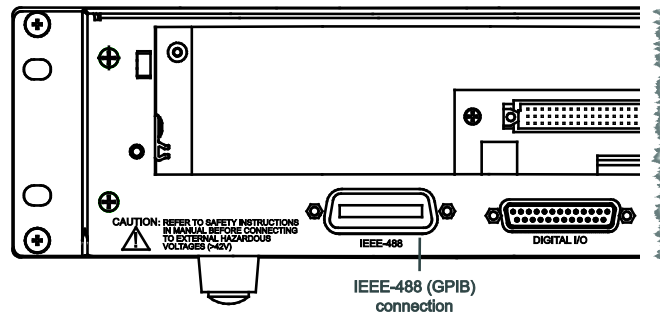

Figure 32: Model 708B rear panel IEEE-488 connection



### Set the GPIB address

The GPIB address is set to 16 at the factory. The address can be set to any address value from 0 to 30. However, the address must be unique in the system. It cannot conflict with an address that is assigned to another instrument or to the GPIB controller.

#### To change the GPIB address:

1. Press the **MENU** key.
2. Select **GPIB > ADDRESS**. Press the navigation wheel  $\odot$  to display the current address.
3. Choose the appropriate GPIB address.
4. Press **ENTER** to save the address.

The address value is saved in nonvolatile memory and will not change when a [reset\(\)](#) (on page 7-135) command is sent or when the power is turned off and then turned on again.

When the GPIB bus is operating, you can use the [gpib.address](#) (on page 7-92) attribute to change the GPIB address remotely.

### Enable GPIB

By default, the instrument is set to GPIB enabled. You only need to enable it if GPIB control was disabled.

#### To enable control through the GPIB:

1. Press the **MENU** key.
2. Select **GPIB**. Press the navigation wheel  $\odot$  to display the GPIB MENU.
3. Select **ENABLE**. Press the navigation wheel  $\odot$ .
4. To enable GPIB, select **ON**. To disable it, select **OFF**.
5. Press **ENTER** to save the setting.

You must turn the instrument on and off before the setting takes effect.

### Communicate with instruments

The GPIB driver software you installed installs an interactive dumb terminal program that allows you to send commands to the instrument. They directly call the GPIB driver support libraries.

For the KPCI-488LPA and KUSB-488B GPIB controller from Keithley Instruments, the configuration utility is called the KI-488 Diagnostic Tool. It is available from the Windows Start menu at **Keithley Instruments > KI-488 > KI-488 Diagnostic Tool**.

For the KUSB-488A GPIB controller from Keithley Instruments, the configuration utility is called TrTest. It is available from the Windows Start Menu at **Keithley Instruments > GPIB-488-CEC > TrTest**.

For National Instruments GPIB controllers, you can use NI-MAX. Start NI-MAX. If your hardware is installed correctly, you should see the controller in the GPIB section of the tree control on the left side. Select it and right-click to see an option to communicate with the instrument.

## NOTE

If you want to use the GPIB controller with instrument driver (such as VXIPnP or IVI) or high-level software, you must also install I/O software, which installs the VISA layer. See [How to install the Keithley I/O Layer](#) (on page 2-59).

### Terminator

When receiving data over the GPIB, the instrument terminates messages on any line feed character or any data byte with EOI asserted (line feed with EOI asserted is also valid). When sending data, it appends a line feed character to all outgoing messages. The EOI line is asserted with the terminating line feed character.

However, if you want your program to communicate with all I/O buses on the instrument (GPIB, USB, LAN (VXI-11 and raw socket)), it is good practice to add a line feed to the end of the outgoing command. Use VISA and the same program will work with all the I/O buses by changing the resource string in the VISA Open method.

## GPIB reference

---

### Configure the GPIB controllers

Each instrument on a GPIB bus needs a unique address from a range of 0 to 30. Generally, the GPIB host controller is on address 0. However, there are GPIB controllers that adopt the address of 21. To be safe, do not configure any of the instruments for 21 or 0.

If you do need to change the host controller address, consult the controller documentation.

For the KPCI-488LPA and KUSB-488B GPIB controller from Keithley Instruments, the configuration utility is called the KI-488 Diagnostic Tool. It is available from the Microsoft® Windows® Start menu at **Keithley Instruments > KI-488 > KI-488 Diagnostic Tool**.

For the KUSB-488A GPIB controller from Keithley Instruments, the configuration utility is called GPIB Configuration. It is available from the Windows Start Menu at **Keithley Instruments > GPIB-488 > GPIB Configuration**.

For National Instruments (NI™) GPIB controllers, you can use NI-MAX. Start NI-MAX. If your hardware is installed correctly, you will see the controller in the GPIB section of the tree control on the left side. Select it and right-click to see an option to configure the controller. Do not forget to save your settings.

## LAN communications

You can communicate with the instrument using a local area network (LAN).

When you connect using a LAN, you can use a web browser to communicate with the instrument through the instrument's internal web page and other web applets.

Models 707B and 708B are class C LXI compliant. They are scalable test instruments with direct connections to host computers. They can also interact with a DHCP or DNS server and other LXI compliant instruments on a LAN.

The Models 707B and 708B are compliant with IEEE standard 802.3 (Ethernet) and support full connectivity on a 10 Mbps or 100 Mbps network.

### NOTE

Contact your network administrator to confirm your specific network requirements before setting up a LAN connection.

## LAN quick start

### Overview

This section describes how to connect an instrument directly to a computer using a LAN connection. To do this, you will:

1. Identify and record network settings.
2. Configure the network settings on the computer and instrument.
3. Create a direct instrument-to-PC LAN connection.
4. Set up an IP address between the computer and the instrument.
5. Access the instrument's internal web interface.

### Configure the computer's network interface card to obtain an IP address automatically

### NOTE

Do not change your IP address without consulting your system administrator. Entering an incorrect IP address can prevent your computer from connecting to your corporate network.

### Identify and record the existing IP configuration

### CAUTION

You are responsible for returning settings to their original configuration before reconnecting the computer to a corporate network. Failure to do this could result in damage to your equipment or loss of data. These settings include, but are not limited to, the IP address, DHCP enabled mode, and the subnet mask.

Record the existing IP configuration information for the computer in the table below so that you can return all settings back to their original configuration before reconnecting your computer to a corporate network.

<b>DHCP Enabled</b>	
<b>IP Address</b>	
<b>Subnet Mask</b>	
<b>Default Gateway</b>	
<b>DNS Servers</b>	

#### Set up automatic IP address selection

If you are connecting to a LAN that has a DHCP server or if you have a direct connection between the instrument and a host computer, you can use automatic IP address selection.

If you select Auto, the instrument attempts to get an IP address from a DHCP server. If this fails, it reverts to an IP address in the range of 169.254.1.0 through 169.254.254.255.

### NOTE

Both the host computer and the instrument should be set to use automatic LAN configuration. Though it is possible to have one set to manual configuration, it is more complicated to set up.

#### To set up automatic IP address selection:

1. Select **Obtain an IP address automatically**.
2. Click **OK**. Close the network settings dialog boxes.

#### Configure the instrument to obtain an IP address automatically

1. From the front panel of the instrument, press the **MENU** key.
2. Use the navigation wheel to select **LAN > CONFIG > METHOD**. Press the navigation wheel to display the METHOD menu.
3. Select **AUTO**. Press the navigation wheel to select AUTO and return to the LAN CONFIG menu.
4. Press the **EXIT** key once to return to the LAN MENU.
5. Select **APPLY**. Press the navigation wheel to apply the setting. The Main Menu is displayed.

#### Connect the LAN cable

Connect the LAN connector between the rear panel of the instrument and the host computer or network router. You can use an LAN crossover cable (RJ-45, male/male) or straight-through cable. The instrument automatically senses which cable you have connected.

The location of the LAN connector on the instrument is shown below.

### NOTE

The TSP-Link connectors will accept a LAN connection, but will not be identified as a LAN and will not connect properly. Be sure to connect the LAN connector correctly.

Figure 33: Model 707B rear panel LAN connection

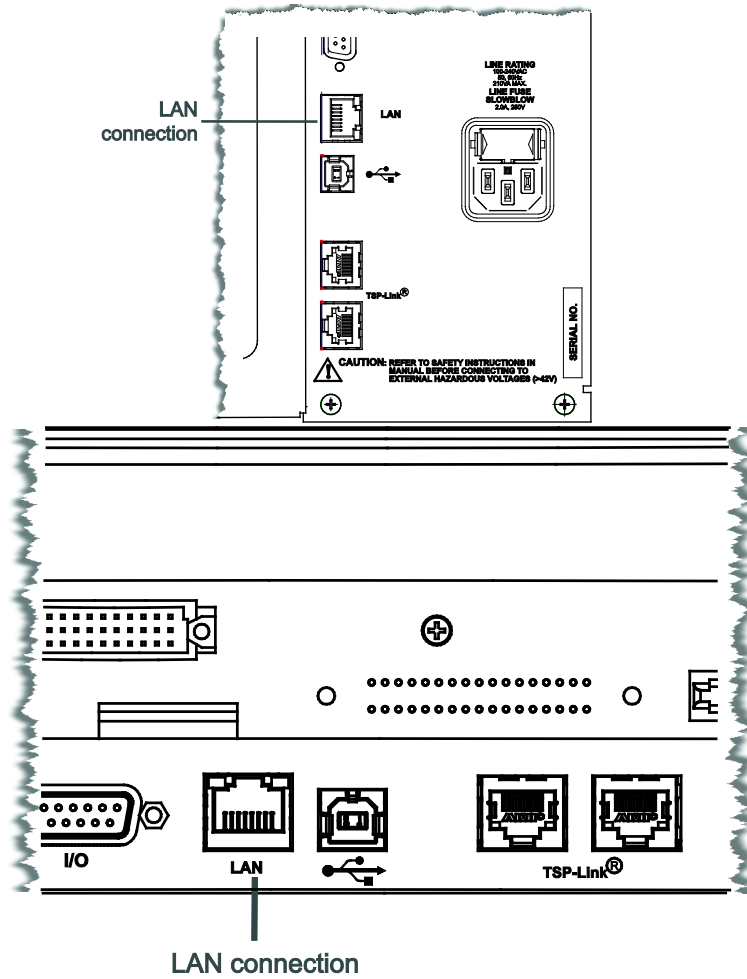

**Wait for the LAN status indicator on the front panel to turn solid green**

A solid green LAN status indicator confirms that the instrument was assigned an IP address. Note that it may take several minutes for the computer and instrument to establish a connection.

### Install LXI Discovery Browser software on your computer

You can use the LXI Discovery Browser to identify the IP addresses of LXI-certified instruments. Once identified, you can double-click the IP address in the LXI Discovery Browser to open the web interface for the instrument.

The Keithley LXI Discovery Browser is available on the [Keithley Instruments website](http://www.keithley.com) (<http://www.keithley.com>).

#### *To locate the Keithley LXI Discovery Browser on the Keithley website:*

1. Select the **Support** tab.
2. In the model number box, type 707B.
3. From the list, select **Software** and click the search icon. A list of software applications for the instrument is displayed.
4. See the readme file included with the application for more information.

For more information about the LXI Consortium, see the [LXI Consortium website](http://www.lxistandard.org) (<http://www.lxistandard.org>).

### Run the LXI Discovery Browser

#### *To run the LXI Discovery Browser software:*

1. From the Microsoft Windows Start menu, select **Keithley Instruments**.
2. Select **LXI Discovery Browser**.
3. Click **LXI Discovery Browser**. The Keithley LXI Discovery Browser window is displayed. The LXI Discovery Browser displays the instruments that it finds on the network and their associated IP addresses.
4. Double-click an IP address in the LXI Discovery Browser dialog box. The instrument web page for that instrument opens.

## LAN reference

---

### Overview of LAN instruments

When Ethernet ports became standard on computers, it was logical that instrumentation would follow. The VXI-11 protocol, which was standardized on in the early 1990s, is the standard used to emulate GPIB over Ethernet.

Even though Ethernet became the standard LAN technology on instruments, LAN instruments from different vendors differed in the approach they took. Some vendors only supported static IP, whereas others had DHCP, DLLA (Auto-IP), and static addressing. The LXI consortium was started to standardize what should be in all instruments that conform to LXI.

An instrument that conforms to LXI version 1.3 must have the following:

- All three IP addressing modes: DHCP, Auto-IP, and static IP.
- A web server that has some standard Ethernet configuration parameters:
  - IP configuration: IP address, subnet mask, gateway.
  - Password protection on anything that might change the instrument state.
  - A control on the web page that flashes an LED or some form of indicator on the front panel of the instrument. LXI calls this the Device Identification Functionality. This allows you to identify the web page you are currently looking at with the instrument. This helps you identify a specific instrument in a rack of similar model instruments.

- A reserved URL in the instrument that provides an xml document that has standard configuration information. This can be useful for software tools that need to identify the instruments and their capabilities. The URL is **http://<host>:<port>/lxi/identification**.
- An IVI driver for the instrument.
- A LAN Status (fault) indicator.
- VXI-11 discovery protocol.
- LAN reset button or menu option. LXI calls this the LAN Configuration Initialize (LCI).

When the LXI-defined LAN reset is selected, the instrument reverts its LAN settings to a known set of defaults. The default LAN settings for LXI instruments are:

- DHCP and Auto-IP enabled. LXI refers to this as the Auto IP address mode (compared to the manual address mode, which is fixed or static IP addressing).
- Web password is reset to the factory default.
- Ping responder enabled.
- Dynamic DNS and mDNS enabled.

LXI Version 1.3 added the requirement of mDNS (multicast DNS) discovery.

### **Instrument LAN protocols**

#### **Raw socket communications**

All Keithley instruments that have LAN connections support raw socket communication. This means that you can connect to the TCP/IP port on the instrument and send and receive commands. There is no extra protocol overhead above and beyond what TCP gives you. A programmer can easily communicate with the instrument using Winsock on Windows computers or Berkley sockets on Linux or Apple computers.

The port number to use for connections differs with instrument models:

- 707B and 708B: Port 5025

#### **Dead socket connections**

If a computer is connected to an instrument through TCP and the computer application is terminated without releasing the socket, it can leave the port on the instrument “hanging”. You cannot reconnect to it without switching the power to the instrument off and then back on.

To avoid cycling power when this occurs, some instruments have a dead socket port (sometimes known as a backdoor). The dead socket termination port is used to terminate all existing LAN connections. This port cannot be used for command and control functions.

Use the dead socket termination port to manually disconnect a dead session on any open socket. All existing LAN connections are terminated and closed when the connection to the dead socket termination port is closed.

The dead socket termination port for Models 707B and 708B is 5030. Connect to this port, and then when you disconnect, the dead port will be cleaned up (released)



### VXI-11

VXI-11 is a LAN protocol that emulates GPIB over Ethernet. It uses remote procedure calls to call functions in the instrument for creating a link, sending data, reading data, and so on. There is also a small header that indicates how much data is being sent. This means there is some overhead added. Therefore VXI-11 is slower than raw socket communication. On the other hand, with VXI-11, the programmer or driver writer does not have to confirm that the correct number of bytes have been sent and received.

VXI-11 also supports an out-of-band channel, which allows the instrument to signal to the computer that an event, such as a SRQ, has occurred.

VXI-11 has a limitation in that it uses broadcast packets to locate the instrument when it wants to make a connection.

Models 707B and 708B use port 1024 for VXI-11 communication. You do not have to know this port number to connect through VXI-11. The discovery portion of the protocol will negotiate the port number for you. If you are trying to configure a firewall, this port number might be useful.

### LAN network types

Ethernet is a type of Local Area Network (LAN) that works with a variety of transmission media. Some of the more popular variations are 10/100BaseT, 10Base2, and 10BaseF, which use unshielded twisted pair (UTP), coaxial cable, and optical fiber, respectively.

Most of Keithley's instruments work with a 10/100 BaseT network and use a standard RJ-45 connector. This is an eight-wire connector, but only four wires are used: one pair to transmit and one pair to receive data. A 10BaseT network can accommodate transmission speeds up to 10Mbits/second; 100BaseT operates at up to 100Mbits/second. Both types of networks usually require Ethernet hubs to make connections. The exception is a one-to-one connection using a crossover cable (see below).

The LAN connector on an instrument gives you more flexibility than GPIB and RS-232 interface controller-subordinate configurations. Rather than connecting the instrument directly to a computer controller in a closed loop, a LAN instrument can be connected to a TCP/IP network using its own subnetwork, or it can be connected directly to an existing network, including a corporate intranet.

### One-to-one connection

With most instruments, a one-to-one connection is done only when you are connecting a single instrument to a single network interface card.

A one-to-one connection using a network crossover cable connection is similar to a typical RS-232 hookup using a null modem cable. The crossover cable has its receive (RX) and transmit (TX) lines crossed to allow the receive line input to be connected to the transmit line output on the network interfaces.

**Figure 34: One-to-one connection with a crossover cable**

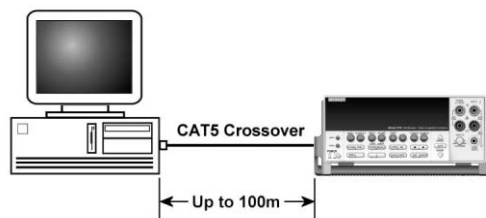

**NOTE**

The Models 707B and 708B supports Auto-MDIX and can use either normal LAN CAT-5 cables (patch) or crossover cables. The instrument automatically adjusts to support either cable.

**One-to-many connection**

With a LAN hub, a single network interface card can be connected to as many instruments as the hub can support. This requires straight-through network (not crossover) cables for hub connections.

The advantage of this method is easy expansion of measurement channels when the test requirements exceed the capacity of a single instrument. With only the instruments connected to the hub, this is an isolated instrumentation network. However, with a corporate network attached to the hub, the instruments become part of the larger network.

**Figure 35: One-to-many connection using a network hub or switch**

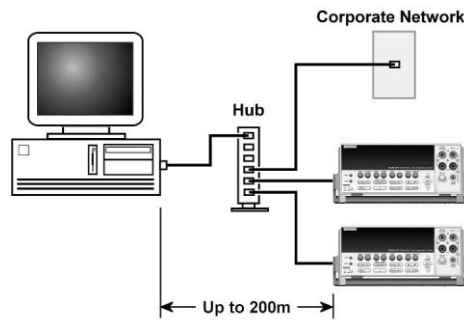

**Two network card connection**

If you need to connect independent corporate and instrumentation networks, two network interface cards are required in the computer controller. Though the two networks are independent, stations on the corporate network can access the instruments, and the instruments can access the corporate network, using the same computer.

This configuration resembles a GPIB setup in which the computer is connected to a corporate network, but also has a GPIB card in the computer to communicate with instruments.

**Figure 36: Two network card connection**

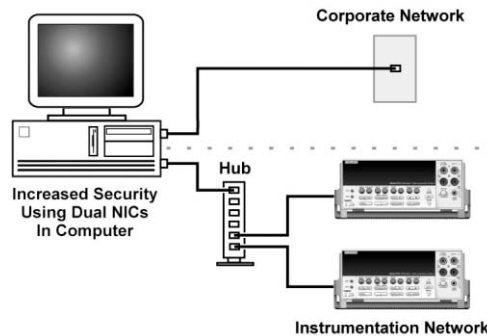

### Instrumentation connection to enterprise routers or servers

This connection uses an existing network infrastructure to connect instruments to the computer controller. In this case, you must get the network resources from the network administrator.

Usually, the instruments are kept inside the corporate firewall, but the network administrator can assign resources that allow them to be outside the firewall. This allows instruments to be connected to the Internet using appropriate security methods. Data collection and distribution can be controlled from virtually any location.

**Figure 37: Instrumentation connection to enterprise routers or servers**

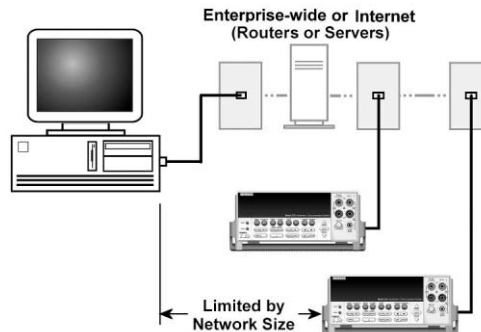

### Setting up an isolated instrument network

The following describes how to set up a simple isolated Class C network for communicating with two LAN instruments using static IP addressing. This network example is similar to the network shown in [One-to-one connection](#) (on page 2-40), but without the corporate network connection to the hub.

The standard Ethernet hub basically repeats anything it receives from one port, making that data available to all its other ports. Hub connections are made with straight-through cables. The hub is connected to the network interface card in the computer. The network interface card and its driver must be properly installed on the computer according to the manufacturer's instructions. You can also use a switch; the benefit of a switch is that it does not forward network packets out all of the ports. It only forwards those that are being addressed by the packet.

#### To set up the network:

1. Create IP addresses for the three hosts (the network interface card and two instruments) on the network. This is a Class C network, so the subnet mask is 255.255.255.0. From the table in [IPv4 address syntax and subnets](#) (on page 2-45), note that the first three parts of the IP address make up the network ID. For purposes of this example, a network ID of 192.68.1 is used, which is the default network ID that is shipped with the most of Keithley's instruments.

If a corporate network is also connected to the same computer using dual network interface cards, the instrumentation network ID must be different than the corporate network ID.

2. Assign the host ID portions of the three IP addresses. In this example, a host number of 1 is assigned to the network interface card. The first instrument is assigned a host number of 10 and the second instrument becomes host number 20. The complete IP addresses are listed below.

#### Example host IP address

Card or instrument	IP address
Network interface card	192.68.1.1
First instrument	192.68.1.10
Second instrument	192.68.1.20

3. In a Windows operating system, use the Windows Control Panel to assign the network interface card IP address. The exact steps differ somewhat for each version of Windows. See [Windows network configuration settings](#) (on page 2-47).
4. Using the front-panel menus, assign a unique IP address to each of the other two instruments. See [Set the IP address on the instrument](#) (on page 2-43).

## NOTE

It is a good idea to record IP addresses for reference. This is especially important when changing the existing network settings on the computer.

5. Verify that the instruments and the network have been set up and are working properly. You can try logging into the web interface of the instrument to test the connection. See [Connect to the instrument web interface](#) (on page 2-66).
6. If you are unable to establish communications, double-check the network settings and try again.

### **To set the IP address:**

1. From the front panel, press the **MENU** key.
2. Use the navigation wheel to select **LAN > CONFIG > METHOD**. Press the navigation wheel to display the METHOD menu.
3. Select **MANUAL**. Press the navigation wheel to select your choice and return to the LAN CONFIG menu.
4. Select **IP\_ADDRESS**. Press the navigation wheel  to display the current IP address.
5. If you are:
  - Connecting directly to a host computer, set all but the last three digits to match the IP address of the host computer. Change the last three numbers (after the last decimal point) to a number that is unique on the LAN. The last three digits may be anything from 1 to 254 for a subnet mask of 255.255.255.0.
  - Connecting to a network: Enter the address provided by your system administrator.



## Quick Tip

To set the address, turn the navigation wheel to go to the number that needs to change, then press the navigation wheel. Turn the navigation wheel to change the number, then press the navigation wheel to set that number. Repeat this for each number that needs to change.

6. Record the instrument's IP address.
7. Press the **ENTER** key when the IP address is complete. The LAN CONFIG menu is displayed.
8. Press the **EXIT (LOCAL)** key once to return to the LAN menu.
9. Select **APPLY**. Press the navigation wheel  to save the change. The Main Menu is displayed.

### TCP/IP network basics

Regardless of the type of network connection used, there must be a way to identify each network device on a network. A software driver installed in the computer provides the means of controlling the instrument. A data communication protocol defines the method of exchanging instructions and data between the computer and each instrument.

#### CAUTION

When connecting to a corporate network, the network administrator **MUST** provide all of the network settings for the LAN instrument. Failure to use settings provided by the network administrator could result in failures at other locations on the corporate network. Failure to work through the network administrator could also be considered a breach of company policy. Always consult with the network administrator before attempting to connect instrumentation to the network.

LAN and LXI instruments use the TCP/IP protocol to communicate with other hosts on the network. A host is defined as any device on the network that can transmit and receive IP packets. In addition to the instrumentation, this includes workstations, servers, and routers. Each host on a TCP/IP network is assigned an IP address that is unique to that host.

### **IPv4 addressing**

Models 707B and 708B support IPv4 addressing. There are three ways of assigning an IP address to a host: DHCP, DDLA, and static.

### **DHCP**

The Dynamic Host Configuration Protocol (DHCP) protocol is a way for network devices to request Internet protocol (IP) parameters such as the IP address, gateway, subnet mask, and DNS server addresses. Each time a network device connects, it leases the IP address for an amount of time set by the DHCP server. Generally, the time is 24 hours, but it could be shorter or longer depending on how the DHCP server was configured.

Typically, DHCP IP addressing is used for corporate networks. It is also commonly the default on home wireless routers that you use to connect your home computer to the internet.

One of the benefits of DHCP is that a system administrator does not have to give you an IP address each time you want to connect something to the network. However, one of the drawbacks is that you do not know the IP address that may be assigned to your network device and it can change from connection to connection. While there are ways to configure DHCP servers to always give the same network device the same IP address each time, but that means a system administrator needs to be involved.

### **Dynamic Link-local Addressing (DLA)**

Also called Auto-IP, DLA was originally used for ad-hoc networks. DLA allows all the network devices to automatically allocate their own unique IP addresses. An Auto-IP address is in the range 169.254.0.0 — 169.254.255.255. A network device randomly picks an address in this range and sends out an ARP packet (on IPv4 only) to see if any other device is using it. If another device responds that it is using it, the network device generates another address and sees if it is in use and so on.

### **Static or fixed IP address**

Static IP addressing means that the person setting up and configuring the network has assigned a fixed, unique IP address to each network device. This requires more rigorous enforcement to make sure everyone has a unique IP address but it has the added benefit that the address will not change.

### **IPv4 address syntax and subnets**

For IPv4, the IP address is 32 bits wide and is divided into two main parts: a network ID number and a host ID number. The address is expressed as four decimal numbers separated by three periods. Valid addresses range from 0.0.0.0 to 255.255.255.255, for a total of about 4.3 billion unique addresses. Each of the four numbers represents the decimal value of the numbers' 8-bit bytes. The way these four numbers are assigned for host ID and network ID depends on the class of network being used.

The network ID must be unique among all network subnets that connect to the Internet or corporate intranet. If the subnet will be connected to the public Internet, the network ID must be obtained from the Network Information Center, which assigns and preserves unique IDs. In any case, each host ID must be unique among all the hosts on the same network (which presumably has a unique network ID number).

In the TCP/IP protocol, a subnet mask separates the network ID from the host ID. The subnet mask looks like an IP address, but sets a data bit high for each position of the IP address that makes up the network ID. Three different classes of network are defined with the IP address and subnet mask, as shown in the following table.

#### Network classes defined by IP address and subnet mask combinations

Network class	IP address	Subnet mask	Available subnets	Available hosts
A	nnn.hhh.hhh.hhh	255.0.0.0	126	16777214
B	nnn.nnn.hhh.hhh	255.255.0.0	16384	65534
C	nnn.nnn.nnn.hhh	255.255.255.0	2097151	254

### NOTE

In the IP address format, "n" is a network ID position, and "h" is a host ID position. For simplicity, the first byte definition has been omitted from the table.

Class C networks are the most common and use the subnet mask 255.255.255.0. The first three bytes are the network ID number and the last byte is the host ID on the network. Host ID numbers 1 through 254 are available for assignment. All hosts on the same isolated network must have the same subnet mask. As a general rule, the top and bottom host numbers are reserved. The top one (nnn.nnn.nnn.255) is the broadcast address and the bottom one (nnn.nnn.nnn.0) is shorthand for the whole subnet.

### DNS

The domain naming system (DNS) is a protocol that provides a way to associate a user-friendly name to an IP address. For example, while few people know the IP address of Google's website, everyone knows www.google.com. When you enter this URL into an Internet browser, the DNS on the network looks up the URL and translates it to the IP address for the Google website. This is invisible to the user.

For DNS to work, there must be a DNS server on the network and the correct IP address for that server must be configured in the computer. Some LAN instruments support DNS — if so, the IP address for the DNS server must be configured as well as the instrument IP address. Instruments, especially LXI instruments, also have to show a valid hostname on their LXI LAN Welcome and IP Configuration pages, and they need to use the DNS to validate that any hostname they display is valid. If they fail to validate a hostname, they must display the IP address for the instrument or a blank hostname in the hostname field on the web page.

DNS requires a network administrator that can update the database in the DNS server with any host name and IP address combinations, so it is not usually suitable for instrumentation setups.

### Dynamic DNS

DNS is a rigid and inflexible system, because you must have a system administration add the DNS entry to the DNS server for it to work. Dynamic DNS tries to address this inflexibility. It addresses the needs of network devices that are powered up and down with IP addresses that can change several times a day.

Dynamic DNS is generally used to refer to a system where there is a DHCP server on the network that allocates IP addresses to the network devices, and therefore there is a method to register a hostname with the DHCP server. The DHCP server assigns the IP address and tracks the hostnames at the same time.

### Multicast DNS

Multicast DNS (mDNS) is a protocol that is more suitable than DNS for small localized ad-hoc networks.

mDNS uses multicast packets for network devices to inform each other of their IP addresses, hostnames, and advertise what services might be available on that device. The packets are usually blocked from going any further than the nearest router. This limits the scope of mDNS, but multicast packets are more network-friendly than broadcast packets. For example, every network device in your subnet receives broadcast packets regardless of need, while for multicast packets, a network device must register for multicast addresses that will be received.

Multicast packets have IPv4 addresses in the range 224.0.0.0 through 239.255.255.255.

### Windows network configuration settings

The following topics describe how to change the LAN network settings for computers that run Microsoft Windows operating systems.

#### Windows XP Internet Protocol (TCP/IP) Properties dialog box

You can review and change IP settings in the Internet Protocol Properties dialog box.

*To open this dialog box in Windows XP:*

1. Click **Start** and select **Settings**, then **Control Panel**.
2. Double-click **Network Connections**.
3. Double-click **Local Area Connection** and click **Properties**. The Local Area Connection Properties dialog box is displayed.
4. In the "This connections uses the following items" list, double-click **Internet Protocol (TCP/IP)**. The Internet Protocol (TCP/IP) Properties dialog box is displayed.

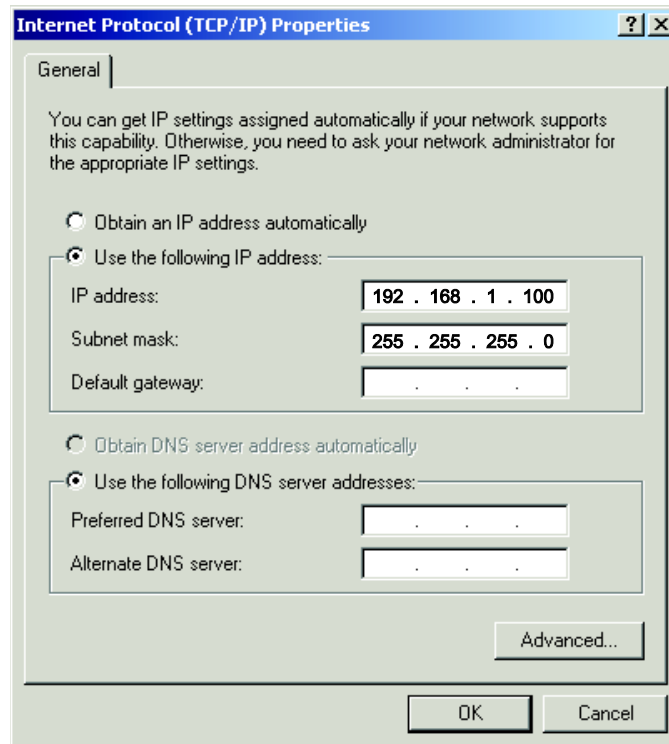

**Figure 38: Internet Protocol (TCP/IP) Properties dialog box****Windows 2000 Internet Protocol (TCP/IP) Properties dialog box**

You can review and change IP settings in the Internet Protocol Properties dialog box.

**To open this dialog box in Windows 2000:**

1. Click **Start** and select **Settings**, then **Control Panel**.
2. Open **Network and Dial-up Connections**.
3. Right-click **Local Area Connection** and select **Properties**. The Local Area Connection Properties dialog box is displayed.

4. In the Items list, double-click **Internet Protocol (TCP/IP)**. The Internet Protocol (TCP/IP) Properties dialog box is displayed.

**Figure 39: Internet Protocol (TCP/IP) Properties dialog box**

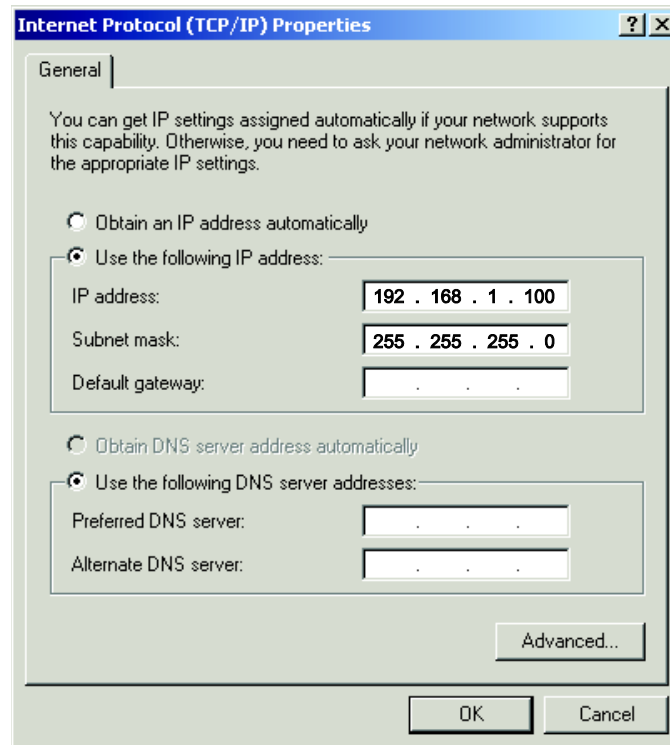

**Windows Vista Internet Protocol Properties dialog box**

You can review and change IP settings in the Internet Protocol Properties dialog box.

**To open this dialog box in Windows Vista:**

1. Click **Start** and select **Control Panel**.
2. Click **Network and Internet**.
3. Open **Network & Sharing Center**.
4. In the list, click **View Status** for the applicable connection. The Local Area Connection Status dialog box is displayed.
5. Click **Properties**. A permissions message is displayed.
6. If you are logged in as an administrator, click **Continue**. If you are not logged in as an administrator, enter the administrator's password to continue.
7. The Network Connection Properties dialog box is displayed.
8. Double-click **Internet Protocol Version 4 (TCP/IPv4)** in the items list. The Internet Protocol Properties dialog box is displayed.

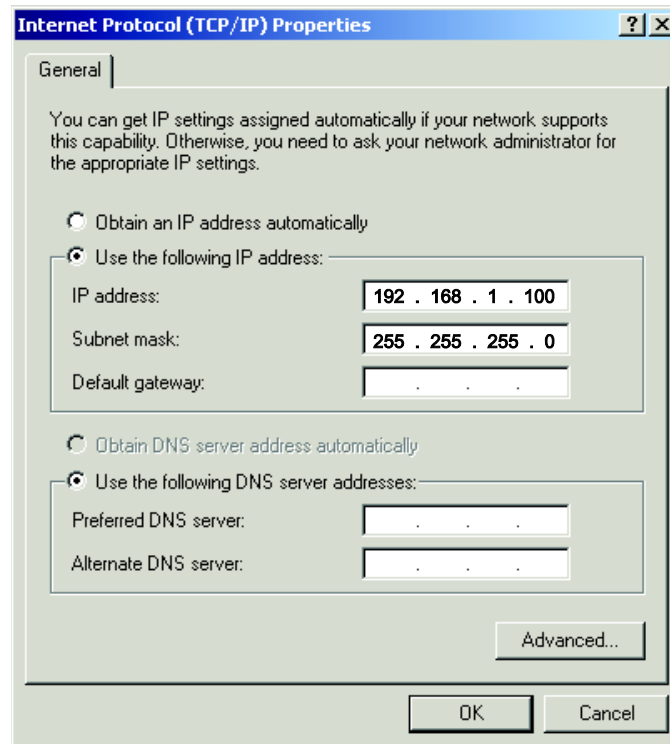
**Figure 40: Internet Protocol (TCP/IP) Properties dialog box****Windows 7 Internet Protocol Version 6 (TCP/IPv6) Properties dialog box**

You can review and change IP settings in the Internet Protocol Version 4 (TCP/IPv4) dialog box.

**To open this dialog box in Windows 7:**

1. Click **Start** and select **Control Panel**.
2. Click **Network and Sharing Center**.
3. Click the Local Area Connection. The Local Area Connection Status dialog box is displayed.
4. In the items list, double-click **Internet Protocol Version 4 (TCP/IPv4)** in the items list. The Internet Protocol Version 4 (TCP/IPv4) Properties dialog box is displayed.

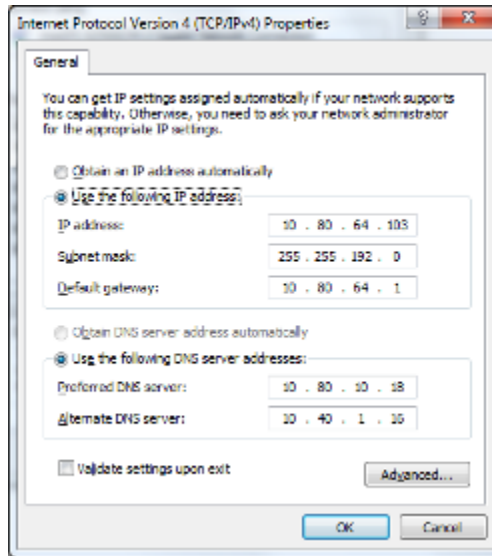
**Figure 41: Windows 7 Internet Protocol Version 6 dialog box**

## Configure LAN settings through the front panel

All instruments need to be configured before they can be used on a network. The main parameters that need to be configured for IPv4 are:

- IP Addressing mode: Models 707B and 708B have a choice of Auto or Manual. Auto mode means the instrument will try to get an address through a DHCP server first and if this fails it will revert to Auto-IP mode. Manual is static IP addressing.
- Subnet Mask.
- Gateway.
- DNS Server address if you are using DNS.

Instruments with front panel displays and menus allow you to configure the instrument LAN settings through the front panel.

### Web connection

You can enable or disable access to the instrument's web interface.

#### *To enable or disable a web connection:*

1. From the front panel, press the **MENU** key, and then select **LAN > ENABLE > WEB**.
2. Select either **ON** or **OFF**. After the power cycle reminder, you return to the LAN CONFIG menu.
3. Press the **EXIT (LOCAL)** key to return to the LAN MENU.
4. Turn the instrument on and off again to finalize the changes.

### Telnet connection

The Telnet protocol is similar to raw socket, and can be used when you need to interact directly with the instrument. Telnet is often used for debugging and troubleshooting. You will need a separate Telnet program to use this protocol.

The Models 707B and 708B supports the Telnet protocol, which you can use over a TCP/IP connection to send commands to the instrument. You can use a Telnet connection to interact with scripts or send real-time commands.

#### *To enable or disable a telnet connection:*

1. From the front panel, press the **MENU** key, and then select **LAN > ENABLE > TELNET**.
2. Select either **ON** or **OFF**. After the power cycle reminder, you return to the LAN CONFIG menu.
3. Press the **EXIT (LOCAL)** key to return to the LAN MENU.
4. Turn the instrument on and off again to finalize the changes.

### VXI-11 connection

This remote interface is similar to GPIB and supports message boundaries, serial poll, and service requests (SRQs). A VXI-11 driver or NI-VISA™ software is required. Test Script Builder (TSB) uses NI-VISA and can be used with the VXI-11 interface. You can expect a slower connection with this protocol.

#### *To enable or disable a VXI-11 connection:*

1. From the front panel, press the **MENU** key, and then select **LAN > ENABLE > VXI11**.
2. Select either **ON** or **OFF**. After the power cycle reminder, you return to the LAN CONFIG menu.
3. Press the **EXIT (LOCAL)** key to return to the LAN MENU.
4. Turn the instrument on and off again to finalize the changes.

### Raw socket connection

Raw socket is a basic ethernet connection that communicates in a manner similar to RS-232 without explicit message boundaries. The instrument always terminates messages with a line feed, but because binary data may include bytes that resemble line-feed characters, it may be difficult to distinguish between data and line-feed characters.

Use raw socket as an alternative to VXI-11. Raw socket offers a faster connection than VXI-11. However, raw socket does not support explicit message boundaries, serial poll, and service requests.

#### *To enable or disable a raw socket connection:*

1. From the front panel, press the **MENU** key, and then select **LAN > ENABLE > RAW**.
2. Select either **ON** or **OFF**. After the power cycle reminder, you return to the LAN CONFIG menu.
3. Press the **EXIT (LOCAL)** key to return to the LAN MENU.
4. Turn the instrument on and off again to finalize the changes.

### Check the LAN network settings

---

You can check the network settings for the instrument without making changes.

#### *To check the network settings:*

1. From the instrument front panel, select **MENU > LAN > STATUS**.

2. Use the navigation wheel to select the following network settings:
  - **IP\_ADDRESS:** The IP address that the instrument is using to communicate over the LAN.
  - **GATEWAY:** The gateway address that the instrument is using to communicate over the LAN.
  - **SUBNET:** The subnet mask that the instrument is using to communicate over the LAN.
  - **METHOD:** Automatic or Manual. When this is automatic, the instrument assigns LAN settings automatically. When this is manual, you need to set the LAN settings.
  - **DNS:** The DNS information.
  - **MAC-ADDRESS:** The Media Access Control address of the network interface card.
  - **SPEED:** The instrument automatically detects the speed of the LAN and adjusts its own settings to match.
  - **DUPLEX:** The instrument automatically detects the duplex setting of the LAN and adjusts its own settings to match.
  - **Port:** RAW-SOCKET, TELNET, VXI-11, or DST. Select the port type to see the assigned port number.
  - **Password:** The current password.
3. Press the **ENTER** key to view the setting.
4. Press the **EXIT** key once to return to the STATUS menu.

### Set up automatic IP address selection

---

If you are connecting to a LAN that has a DHCP server or if you have a direct connection between the instrument and a host computer, you can use automatic IP address selection.

If you select Auto, the instrument attempts to get an IP address from a DHCP server. If this fails, it reverts to an IP address in the range of 169.254.1.0 through 169.254.254.255.

#### NOTE

Both the host computer and the instrument should be set to use automatic LAN configuration. Though it is possible to have one set to manual configuration, it is more complicated to set up.

#### *To set up automatic IP address selection:*



1. On the host computer, in the Internet Protocol Properties dialog box, select **Obtain an IP address automatically**. This enables DHCP mode. If this fails, the computer will automatically try Auto-IP addressing (DLLA).
2. Click **OK**. Close the network settings dialog boxes.
3. From the front panel of the instrument, press the **MENU** key.
4. Use the navigation wheel to select **LAN > CONFIG > METHOD**. Press the navigation wheel to display the CONFIG menu.
5. Select **AUTO**. Press the navigation wheel to select AUTO and return to the LAN CONFIG menu.
6. Press the **EXIT (LOCAL)** key once to return to the LAN MENU.
7. Select **APPLY**. Press the navigation wheel to apply the setting. The Main Menu is displayed.

### Set up instrument for manual LAN configuration

---

After setting up your computer for connection to the instrument, you configure the instrument's LAN settings through the instrument front panel. Settings include the IP address, subnet mask, and the default gateway.

**To set up the LAN on the instrument:**

1. From the front panel, press the **MENU** key.
2. Use the navigation wheel to select **LAN > CONFIG > METHOD**. Press the navigation wheel  to display the METHOD menu.
3. Select **MANUAL**. Press the navigation wheel  to select your choice and return to the LAN CONFIG menu.
4. Select **IP\_ADDRESS**.
5. If you are:
  - Connecting directly to a host computer, refer to the recorded computer's IP address. Set the IP address to match the IP address of the host computer. Change the last three numbers (after the last decimal point) to a number that is unique on the LAN. The last three digits may be anything from 1 to 254 for a subnet mask of 255.255.255.0.
  - Connecting to a network: Enter the address provided by your system administrator.
6. Record the instrument's IP address.
7. Press the **ENTER** key when the IP address is complete. The LAN CONFIG menu is displayed.
8. Select **GATEWAY**.
9. Set the gateway value to match the gateway of the host computer.
10. Press the **ENTER** key when the gateway is complete. The LAN CONFIG menu is displayed.
11. Select **SUBNET**.
12. Set the subnet value to match the settings of the host computer or use the value supplied by your system administrator.
13. Press the **ENTER** key. The LAN CONFIG menu is displayed again.
14. Press the **EXIT (LOCAL)** key once to return to the LAN menu.
15. Select **APPLY**. Press the navigation wheel  to apply the change. The Main Menu is displayed.

---

**Change DNS settings**

---

On the instrument, you can enable or disable the DNS settings and assign a host name to the DNS server.

When verify is enabled, the instrument performs a DNS lookup to verify that the DNS host name matches the value specified in the DNS server.

When dynamic is enabled, DNS registration works with the DHCP server to register the host name specified with the DNS server.

You can also define additional DNS addresses.

**To change DNS settings:**

1. From the front panel, press the **MENU** key, and then select **LAN > CONFIG > DNS > VERIFY**.
2. Select either **ENABLE** or **DISABLE**. You return to the DNS menu.
3. Select **DYNAMIC**.
4. Select either **ENABLE** or **DISABLE**. You return to the DNS menu.
5. To set an additional DNS addresses, select **DNS-ADDRESS1** or **DNS-ADDRESS2**.
6. Enter the address.
7. Press the **ENTER** key.
8. Press the **EXIT** key twice to return to the LAN MENU.
9. Select **APPLY**.

## Change the IP configuration through the web interface

The LAN settings, such as IP address, subnet mask, gateway, and DNS address, can be changed through the web page of the instrument.

If you change the IP address through the web page, the web page will try to redirect to the IP address that gets configured in the instrument. In some cases, this may fail. This generally happens if you switch from static IP address assignment to IP address assignment using a DHCP server. If this happens, you need to revert to either using the front panel to set the IP address or use an automatic discovery tool to determine the new IP address.

### NOTE

You can also change the IP configuration using TSP commands. See [LAN and LXI](#) (on page 5-10) for more information.

*To change the IP configuration using the instrument web page:*

1. Access the instrument's internal web page (see [Using the web interface](#) (on page 2-66)).
2. From the navigation bar on the left, in the LXI Home menu, select **IP Config**.
3. Click **Modify**.
4. You are prompted for a password. The default is admin.

**Figure 42: Modify IP Configuration page**

Hostname:	<input type="text" value="K-708B-01234567"/>
Description:	<input type="text" value="Keithley 708B #01234567"/>
TCP/IP Configuration Mode:	<input type="radio"/> Automatic <input checked="" type="radio"/> Manual
Static IP Address:	<input type="text" value="10.60.8.83"/>
Subnet Mask:	<input type="text" value="255.255.255.0"/>
Default Gateway:	<input type="text" value="10.60.8.1"/>
DNS Servers:	<input type="text" value="10.80.10.18"/> <input type="text" value="10.40.1.16"/>
Domain:	<input type="text"/>
Dynamic DNS:	<input type="radio"/> Enabled <input checked="" type="radio"/> Disabled

**Submit**

5. Change the values.
6. Click **Submit**. The instrument reconfigures its settings, which may take a few moments.



## NOTE

You may lose your connection with the embedded web interface after clicking **Submit**. This is normal and does not indicate an error or failure of the operation. If this occurs, re-open the web page of the instrument to continue.

## Supplied software

The majority of software applications and all instrument drivers from Keithley Instruments depend on some, or all, of the following software components:

- NI-VISA™
- VISA shared components
- IVI shared components
- NI™ CVI™ runtime engine
- NI™ IVI™ compliance package

Keithley instrument driverThese software components are included on the CD-ROMs that came with your instrument, and are also available for download at the [Keithley Instruments support website](http://www.keithley.com/support) (<http://www.keithley.com/support>).

## VISA

The Virtual Instrument Software Architecture (VISA) is a standards body that maintains the specifications for a whole series of software components related to instrument connectivity (I/O). The VISA specifications, formerly maintained by the VXIplug&play Systems Alliance, are now being maintained by the [IVI Foundation](http://www.ivifoundation.org) (<http://www.ivifoundation.org>).

The VISA library (standard VPP-4.3) is a standard for an API to communicate with instruments connected to the computer communication buses: Ethernet, USB, RS-232, GPIB, and so on. VPP-4.3 is a software API standard — several instrument vendors have implementations of VPP-4.3, including National Instruments, Agilent Technologies, and Tektronix.

There are three types of programming interfaces to VISA: VISA-C, VISA-COM and VISA .NET.

- VISA-C is a DLL that has a flat API. The five main message-based functions are viOpenDFLT, viOpen, viWrite, viRead and viClose.
- VISA-COM is an ActiveX type interface to VISA that is more suited for the VB6 and .NET environments.
- VISA.NET is a .NET interface for VISA that the IVI Foundation is currently (July 2010) standardizing on.

## VISA shared components

The IVI Foundation provides the VISA shared components, which contain the VISA-COM components that VISA vendors install with their VISA installations. There are separate entries in the Add/Remove Programs dialog box for the VISA shared components and the vendor's VISA.

## IVI shared components

---

The IVI shared components are a similar concept to the VISA shared components. The IVI Foundation provides class drivers for:

- All the supported instruments (DMM, Scope, Fgen, and so on)
- The configuration store

The IVI shared components also create the installation folders and registry keys that all IVI drivers and support files use for installation.

## NI CVI runtime engine

---

IVI-C drivers that are created using National Instruments (NI™) LabWindows/CVI environment depend on either the CVI runtime (cvirte.dll), or the instrument support run-time (instrsup.dll), and must be present on the system for them to run.

## NI IVI Compliance Package

---

The National Instruments (NI™) IVI Compliance Package is a software package that contains IVI class drivers and support libraries that are needed for the development and use of applications that leverage IVI instrument interchangeability. The IVI Compliance Package also is based on and is compliant with the latest version of the instrument programming specifications defined by the IVI Foundation.

The NI ICP installer installs the IVI shared components, CVI runtime engine, and the instrument support runtime engine.

## Keithley SCPI-based instrument driver

---

The Keithley SCPI-based Instrument IVI-C Driver is used to support the Keithley Configuration Panel Wizard and Keithley Communicator functionality. It contains simple functions for opening, configuring, taking measurements from, and closing the instrument.

## Keithley I/O layer

The Keithley I/O Layer (KIOL) is a software package that contains several utilities and drivers. It is mainly used as a supplement to IVI drivers, or application software like Test Script Builder (TSB).

The KIOL contains:

- NI-VISA™ Runtime-Time Engine
- Keithley Configuration Panel
- Keithley Communicator

## NI-VISA Runtime

---

NI-VISA™ is National Instruments (NI™) implementation of the VISA standard. There are two versions. The full version contains diagnostic and configuration tools such as NI-Spy and NI-MAX and the binary run-time-only files. The run-time version contains only the binary files (DLLs) that allow the drivers to operate.

The Keithley I/O Layer (KIOL) contains a licensed version of the NI-VISA runtime.

If you already have NI software (such as LabVIEW or LabWindows) installed, you have a valid license that can be used with Keithley drivers and application software.

If you do not have NI software installed, to use Keithley drivers or application software, you must install the KIOL. This installs a valid, licensed copy of the NI-VISA runtime to use with Keithley drivers or application software. KIOL installs a valid license for the NI-VISA Run-Time Engine only (not the full version of NI-VISA).

---

## Keithley Configuration Panel

---

The Keithley Configuration Panel is a configuration utility for IVI drivers, similar to NI-MAX. It also has the ability to autodetect USBTMC instruments and LAN instruments that support the VXI-11 protocol.

---

## Keithley Communicator

---

The Keithley Communicator is a dumb terminal program that uses VISA to communicate with the instrument.

---

## Computer requirements for the Keithley I/O Layer

---

The Keithley I/O Layer version C02 supports the following operating systems:

- Microsoft® Windows® (32-bit & 64-bit) Business with Service Pack 1 or later
- Microsoft Windows Vista® Business (32-bit & 64-bit) with Service Pack 2 or later
- Windows XP Professional (32-bit) with Service Pack 3 or later
- Windows 2000 Professional with Service Pack 4 plus update KB891861 or later

Note that Windows 95, Windows 98, Windows ME, Windows NT, Windows XP (64-bit) operating systems are not supported.

---

## How to uninstall previous versions of the Keithley I/O Layer

---

If you have an earlier version of the Keithley I/O Layer software installed on your computer, you must uninstall it.

*To uninstall the Keithley I/O layer:*

1. From the Control Panel, select **Add/Remove Programs**.
2. Uninstall the following components:
  - Keithley I/O Layer
  - Keithley I/O Layer Suite
  - Keithley SCPI-based Instrument IVI-C Driver
  - NI-VISA Run-Time Engine x.x.x (if present) (x.x.x is the VISA version)
3. Reboot your computer.

## How to install the Keithley I/O Layer

---

### NOTE

Before installing, it is a good idea to check the [Keithley Instruments website](http://www.keithley.com) (<http://www.keithley.com>) to see if a later version of the Keithley I/O Layer is available. On the website, select the **Support** tab, under **model number**, type KIOL, and select **Software Driver**.

You can install the Keithley I/O Layer from the CD-ROM that came with your instrument, or from the download from the Keithley website.

The software installs the following components:

- Microsoft® .NET Framework
- NI™ IVI Compliance Package
- NI-VISA™ Run-Time Engine
- Keithley SCPI-based Instrument IVI-C driver
- Keithley I/O Layer

#### **To install the Keithley I/O Layer from the CD-ROM:**

1. Close all programs.
2. Place the CD-ROM into your CD-ROM drive.
3. Your web browser should start automatically and display a screen with software installation links. If you need to manually open the web page, use a file explorer to navigate to the CD-ROM drive and open the file named `index.html`.
4. From the web page, select the **Software** category and click **Keithley I/O Layer**.
5. Accept all defaults.
6. Click **Next**.
7. Click **Install**.
8. Turn your computer off and then on again to complete the installation.

#### **To install the Keithley I/O Layer from the Keithley website:**

1. Download the Keithley I/O Layer Software from the [Keithley Instruments website](http://www.keithley.com) (<http://www.keithley.com>) as described in the note. The software is a single compressed file and should be downloaded to a temporary directory.
2. Run the downloaded file from the temporary directory.
3. Follow the instructions on the screen to install the software.
4. Reboot your computer.

## Special installation considerations

---

Situations may occur during installation that cannot be handled automatically by the installation utility. The installation utility will warn you if one of these situations is detected. The sections below describe the action you must take before the installation can be completed.

### **Mismatch between IVI Shared Components and IVI Engine Detected**

The IVI Shared Components and IVI Engine are software components that may be installed by various test and measurement software applications, instrument drivers, and so on. Keithley I/O Layer software requires that these components, if present, be compatible versions. The installation utility will detect a mismatch, which must be corrected before the software installation can proceed. If this situation is detected, the Keithley I/O Layer software installation will automatically stop.

The recommended way to resolve this situation is to install the IVI Compliance Package (ICP) software from National Instruments (NI™). You may download the ICP software and release notes from National Instrument's website. When the ICP installation is complete, restart the Keithley I/O Layer software installation.

### **Non-National Instruments VISA detected**

VISA software is used to communicate with the instrument and may be installed by various test and measurement software applications, instrument drivers, and so on. Keithley I/O Layer software requires and will install National Instruments NI-VISA™ software. The installer will detect if another vendor's version of VISA is already installed on the computer. If this occurs, the installer will pause and display a warning message. The warning message displays the vendor of the detected VISA in its title bar, if this can be determined. Make a note of the vendor name. At this point, you may elect to continue the installation, which will overwrite the existing VISA installation with NI-VISA. This will allow the Keithley I/O Layer software to operate properly, but may cause other applications or instrument drivers that were dependent on the existing VISA to malfunction.

#### ***The recommended way to resolve this situation is to perform the following steps:***

1. Exit the Keithley I/O Layer software when the warning message is displayed. Make note of the VISA vendor in the warning message (if any).
2. Uninstall the non-NI VISA software.
3. Uninstall Tektronix VISA by selecting OpenChoice TekVISA from the Control Panel Add/Remove programs list.
4. Uninstall Agilent VISA by selecting Agilent I/O Libraries Suite from the Control Panel Add/Remove programs wizard list.
5. Uninstall other versions of VISA by selecting the appropriate entry from the Control Panel Add/Remove Programs Wizard list.
6. Restart the Keithley I/O Layer software installation.
7. If the pre-existing version of VISA was supplied by Tektronix or Agilent (as displayed in the warning message), you may safely reinstall that version of VISA once Keithley I/O Layer software installation is complete. When you reinstall Tektronix or Agilent VISA, it may prompt you to preserve the current VISA version, which you should do. This will usually restore the operation of any dependent applications or drivers.
8. If the pre-existing version of VISA was supplied by a vendor other than Tektronix or Agilent, we recommend that you do not reinstall it, because this will likely cause the Keithley I/O Layer software to malfunction.

## Installation troubleshooting

---

If problems occur during installation, it might be helpful to install the components individually. Errors messages might appear that will help you resolve the installation issue.

If problems occur during installation:

1. Rerun the KIOL installer. Note where the installer unpacks the files (usually in a temporary folder).
2. Cancel the installer.
3. Go to the folder where the files were unzipped.
4. Run the setup.exe for each of the following components in the following order:
  - IVI Compliance Package (ICP)
  - NI-VISA™ Run-Time Engine
  - KIOL
  - Keithley SCPI Driver
5. Ignore all the other folders.
6. Reboot the computer.

## Modifying, repairing, or removing Keithley I/O Layer software

---

The Keithley I/O Layer interconnects many other installers.

To remove all the KIOL components, you need to uninstall the following applications using Control Panel:

- National Instruments NI™ IVI Compliance Package
- National Instruments NI-VISA™ Run-Time Engine
- IVI Shared Components
- Visa Shared Components
- Keithley SCPI Driver

After uninstalling components, reboot the computer.

## Addressing instruments with VISA

VISA allows you to communicate with the instrument on different communication buses by changing a resource string that gets passed in with the viOpen function, in VISA-C, or with the Open method on the VISA-COM resource manager object.

For detailed information about the format of the resource string, refer to the VISA specification VPP4.3 at the IVI Foundation website, or refer to the help file provided by the vendor of the VISA implementation you are using.

The following sections describe the resource strings for some of the communication types that Keithley supports. Any field that has [] (square brackets) around it is optional and will revert to a default value.

## Addressing instruments through the LAN

VISA supports two different LAN protocols, each of which has a different resource string.

**VXI-11** is a protocol that emulates GPIB over the LAN. Models 707B and 708B supports this protocol. The resource string is:

```
TCPIP[board]::host address[::LAN device name][::INSTR]
```

*board* is the network interface card in the computer. This value is usually skipped and VISA determines the correct network interface card (if you have more than one) by looking at the IP address.

*host address* can be either a valid DNS hostname, mDNS hostname, or the IPv4 IP (only) address of the instrument.

*LAN device name* is a method of addressing secondary instruments at the main IP address, similar to secondary addressing on the GPIB bus. The default is *inst0*.

A **raw socket** connection requires more work by the driver or application program to make sure the correct amount of data has been sent or received correctly. All Keithley instruments support the raw socket connection.

```
TCPIP[board]::host address::port::SOCKET
```

The *board* and the *host address* are the same as for the VXI-11 protocol.

*port* is the port to which to connect on the instrument. For the Models 707B and 708B, the port is 5025. See [Instrument LAN protocols](#) (on page 2-39) for a complete list of port numbers.

## Addressing instruments using USB

```
USB[board]::manufacturer ID::model code::serial number[::USB interface number][::INSTR]
```

*board* is not used (0).

*manufacturer ID* is the USB.org reserved four-digit hexadecimal code for the instrument vendor company. Keithley Instruments hexadecimal code is 05E6.

*model code* is the model number of the instrument. For example, when addressing a Model 707B, use 707B.

*serial number* is the serial number of the instrument.

*USB interface number* identifies which USBTMC interface on the instrument to address (usually 0).

### NOTE

Also see [USB VISA identifiers](#) (on page 2-30).

## Addressing instruments through GPIB

---

There are two different resource classes in VISA for the GPIB bus.

**INSTR** is the basic class that everyone uses. It allows application software to send and receive data and commands without dealing with some low level GPIB nuances. This class is recommended for typical GPIB communication.

The **INTFC** class allows finer control over the GPIB controller card in the computer. You must comply with the IEEE-488.1 protocol and tell the instrument to listen and the controller to talk before sending a message to the instrument. This class allows you to communicate to the instrument using low-level GPIB commands. Refer to your VISA documentation for more details on how to use this class.

The GPIB INSTR resource class format is:

```
GPIB[board][::primary address][::secondary address][::INSTR]
```

*board* is the number of the GPIB card, if there are more than one in the computer. If there is only one GPIB card, don not include *board*, but do not leave a space.

*primary address* is the main GPIB address of the instrument, which can be changed, if necessary, through the front panel of the instrument.

*secondary address* is for secondary addressing in GPIB. Some instruments have subinstruments or cards inside the main instrument or backplane. The primary address identifies the main instrument. The secondary address identifies subinstruments. Refer to the instrument user manual for the secondary address, if applicable.

## Sending raw commands to an instrument

---

The next sections show you how to use VISA-C and VISA-COM to send raw instrument commands without using the instrument drivers.



**VISA-C sample code**

The following is a simple C/C++ console application that reads back the instrument identification string using VISA-C. You need to include visa.h and link with the visa32.lib file.

```
#include "stdafx.h"
#include <visa.h>

#define checkErr(fCall)      if (error = (fCall), (error = (error <
    0) ? error : VI_SUCCESS)) \
                            {goto Error;} else error = error

int _tmain(int argc, _TCHAR* argv[])
{
    ViSession defaultRM, vi;
    char buf [256] = {0};
    ViStatus  error = VI_SUCCESS;

    /* Open session to GPIB device at address 22 */
    checkErr(viOpenDefaultRM(&defaultRM));
    checkErr(viOpen(defaultRM, "GPIB0::14::INSTR", VI_NULL,VI_NULL, &vi));

    /* Initialize device */
    checkErr(viPrintf(vi, "*RST\n"));

    /* Send an *IDN? string to the device */
    checkErr(viPrintf(vi, "*IDN?\n"));
    ViUInt16 status = 0;
    do
    {
        checkErr(viReadSTB(vi, &status));
        printf("ReadSTB = %X\n", status);
    } while(status == 0);

    /* Read results */
    checkErr(viScanf(vi, "%t", &buf));
    /* Print results */
    printf ("Instrument identification string: %s\n", buf);

    /* Close session */
    checkErr(viClose(vi));
    checkErr(viClose(defaultRM));

Error:

    if(error < VI_SUCCESS)
        printf("Visa Error Code: %X\n", error);
    printf("\nDone - Press Enter to Exit");
    getchar();

    return 0;
}
```

### VISA-COM sample code

This example gets the instrument identification string using VISA-COM in C#.

The first thing to do is add a reference to the VISA-COM interop DLL, which is usually located at C:\Program Files\IVI Foundation\VISA\VisaCom\Primary Interop Assemblies\Ivi.Visa.Interop.dll.

```
using Ivi.Visa.Interop;

namespace WindowsApplication1
{
    public class IdnSample: System.Windows.Forms.Form
    {
        private Ivi.Visa.Interop.FormattedIO488 ioDmm;
        //
    }
}

private void IdnSample_Load(object sender, System.EventArgs e)
{
    ioDmm = new FormattedIO488Class();

    SetAccessForClosed();
}

private void btnInitIO_Click(object sender, System.EventArgs e)
{
    try
    {
        ResourceManager grm = new ResourceManager();
        ioDmm.IO = (IMessage)grm.Open("GPIB::16::INSTR",
            AccessMode.NO_LOCK, 2000, "");
        ioDmm.IO.TerminationCharacterEnabled = true;
    }
    catch (SystemException ex)
    {
        MessageBox.Show("Open failed on " + this.txtAddress.Text + " " +
            ex.Source + " " + ex.Message, "IdnSample", MessageBoxButtons.OK,
            MessageBoxIcon.Error);
        ioDmm.IO = null;
    }
}
```

## Using the web interface

### Introduction

The Model 707B or 708B web interface can be used with your choice of web browsers, including Microsoft® Internet Explorer®, Mozilla® Firefox®, Google Chrome™, and Apple® Safari®. Using the web interface, you can review instrument status, control the instrument, and upgrade the instrument over a LAN connection.

The instrument web page resides in the firmware of the instrument. Changes you make through the web interface are immediately made in the instrument.

All examples in this manual can be run through the [TSB Embedded](#) (on page 2-75) web application that is available on the instrument web interface.

### Connect to the instrument web interface

---

To connect to the instrument web interface, you must have an LAN connection from the computer to the instrument.

The web interface requires the web browser plug-in Sun Java™ Runtime Environment Version 6 or higher. Installation files are available from <http://www.java.com/en/download/manual.jsp> (<http://www.java.com/en/download/manual.jsp>).

The ActiveX control and Java applets are installed from the instrument but, depending on the browser security settings, they may require the users permission to be downloaded and installed.

***After the instrument is connected and Java is installed, to connect to the instrument:***

1. Open an internet browser, such as Windows Internet Explorer (v6.0 or higher only).
2. In the Address box, enter the IP address of the instrument (to find the IP address, from the front panel of the instrument, select **MENU > LAN > STATUS > IP-ADDRESS**).

The Home page of the instrument web interface is displayed.

### Web interface home page

---

The home page of the web interface gives you basic information about the instrument, including:

- The instrument model, serial number, firmware revision, and LXI information
- A list of slots and the switch cards that are installed in each slot
- An **ID** button to help you locate the instrument
- Links to the instrument web options, including TSB Embedded.

## Identify the instrument

---

If you have a bank of instruments, you can click the ID button to determine which one you are communicating with.

### *To identify the instrument:*

In the middle of the left side of the Home page, click the **ID** button.

The button turns green and the LAN status indicator on the instrument blinks.

Click the **ID** button again to return the button to its original color and return the LAN status indicator to steady on.

## Log in to the instrument

---

The web interface has both interactive and read-only pages. These pages are always listed in the navigation panel on the left side of the web interface. You can review information on any of the pages without logging in, but to change information, you must log in.

Pages that contain information you can change include a **Login** button. Once you have logged in to one page of the web interface, you do not need to log in again unless you reload the page.

### *To log into the instrument:*

1. Open a page that contains a Login button, such as one of the Cards pages, Scan Builder, or TSB Embedded.

**Figure 43: Web interface login**



2. Click **Login**. The login dialog box is displayed.
3. Enter the password (the default is **admin**).

**Figure 44: 3700A Enter web interface password**

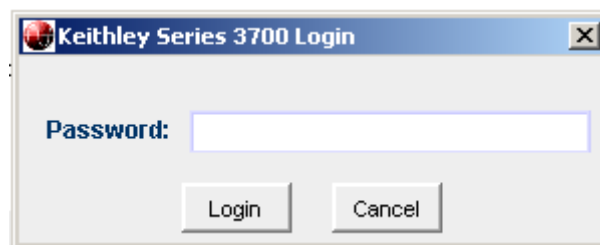

4. Click **Login**.

## NOTE

The default password is **admin**. If the password has been changed, it is available from the front panel of the instrument. Press **MENU > LAN > STATUS > PASSWORD**.

## Card pages

The card pages are interactive pages where you can work with channels in each slot.

To open a card page, on the left navigation, click the slot number.

There is a specific page for each card installed in the mainframe. The page displays a grid that shows the relay configuration of the switch card.

**Figure 45: Web interface Cards page**

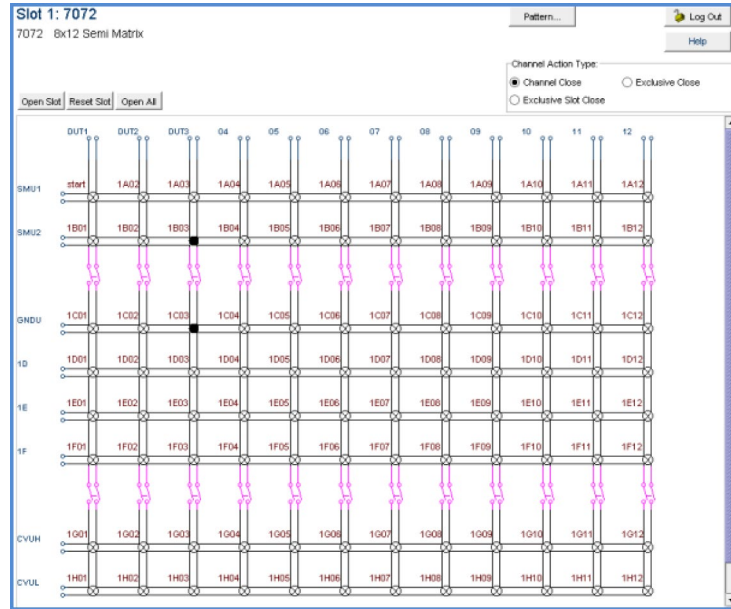

### Open and close slots from the card pages

You can open and close channels from the card pages in several ways.

The simplest method is to click a connection. The channel changes state to open or closed. When the channel is open, the connection will look similar to one of the following graphics (the actual item on the web interface depends on the installed card):

**Figure 46: Web interface open channel**



**Figure 47: Web interface relay open**

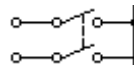

When the channel is closed, the connection will look similar to one of the following:

**Figure 48: Web interface closed channel**



**Figure 49: Web interface relay closed**



To specify the type of close, select a Channel Action Type from the box in the upper right before closing a channel. The options are:

- **Channel Close:** Close the selected channel without affecting the state of any other channels.
- **Exclusive Slot Close:** Close the selected channel and open any closed channels in the same slot.
- **Exclusive Close:** Close the selected channel and open any closed channels in the instrument (the only closed channel is the selected channel).

You can open all channels in a slot by clicking **Open Slot**.

You can open all channels in the instrument by clicking **Open All**.

For more information on opening and closing channels, see [Working with channels](#) (on page 2-80).

## Configure channels from the web interface

To configure channels from the web interface, right-click the channel. The Channel Configuration dialog box is displayed.

Figure 50: Channel configuration dialog box

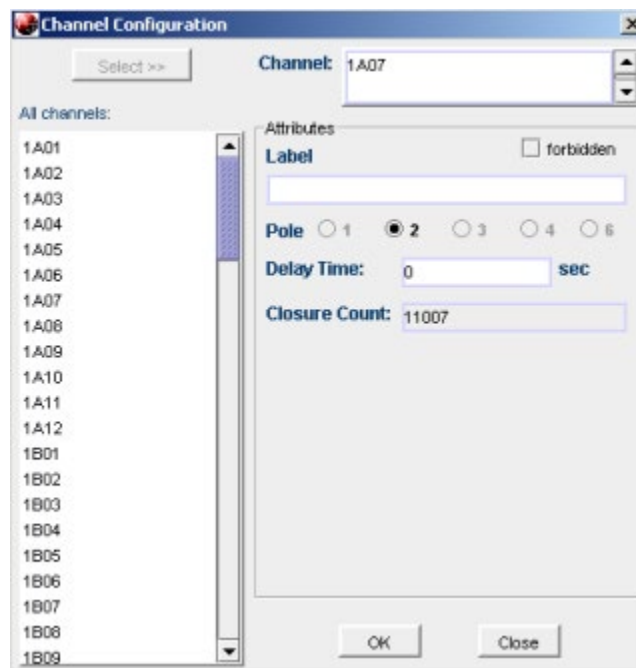

In this dialog box, you can set:

- **Label:** The label for the channel. This is the same as the command `channel.setLabel()`.
- **Forbidden:** Select this box to set the channel to forbidden. This prevents the channel from being closed from any interface. Note that if the channel is used in a channel pattern, the pattern is deleted when you set the channel to forbidden to close.

- **Delay Time:** The additional delay to incur after the relay settles when closing the channel. Enter the value for the delay in seconds. The total delay for channel close is this delay plus the relay settling time.

This dialog box also displays the closure count. See [Determining the number of relay closures](#) (on page 2-85) for information.

## Set up channel patterns from the web interface

You can use channel patterns as a convenient way to refer to a group of switching channels with a single alphanumeric name. When you perform close or open operations on a channel pattern, only the channels that are in the channel pattern are affected.

There is no speed difference when performing close and open operations on channel patterns compared to performing the same operations on individual channels or a list of channels.

### To create a channel pattern from the web interface:

1. From the left navigation, click a slot.  
Click **Pattern** (above the Channel Action Type box). The Channel Pattern Configuration dialog box is displayed.

**Figure 51: Channel pattern configuration dialog box**

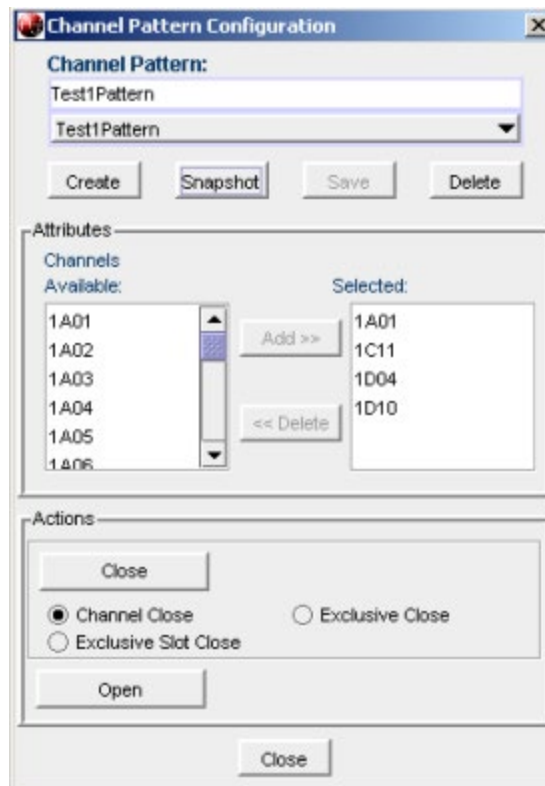

2. Enter a name in the box at the top.
3. From the Channels Available list, select the channels you want to add. You can use Ctrl+click and Shift+click to select multiple channels.
4. Click **Add**. You can add as many channels as needed.
5. Click **Create**.

**To create a channel pattern from the web interface using the Snapshot feature:**

1. Close the channels that you want to include in the pattern.
2. Click **Pattern** (above the Channel Action Type box). The Channel Pattern Configuration dialog box is displayed.
3. Enter a name in the box at the top.
4. Click **Snapshot**. A new pattern is created that contains the closed channels.

**To delete a channel pattern from the web interface:**

1. Select the name of the pattern that you want to delete.
2. Click **Delete**.

For more information regarding patterns, including opening and closing the channels that are in patterns, see [Channel patterns](#) (on page 2-92).

---

**Reset a slot from the web interface**

---

You can reset all the relays in the displayed slot by clicking **Reset Slot**.

When you reset the relays in a slot:

- Any closed channels open
- Labels return to default of slot, row, column
- Delays are set to zero
- If the channel is forbidden to close, it is cleared from being forbidden to close
- If any of the slot's channels are in channel patterns, the patterns are deleted

The rest of the instrument settings are unaffected.

## Scan Builder page

The Scan Builder page allows you to set up and run scans and triggers.

A scan is a series of steps that opens and closes switches sequentially for a selected group of channels. During each step, actions occur, such as waiting for a trigger, taking a measurement on an external instrument, and completing a step count. Scans automate actions that you want to perform consistently and repeatedly on a set of channels.

Triggers are events that prompt the instrument to move from one step to another in a scan. Triggers can come from a variety of sources, such as a key press, digital input, or expiration of a timer. The sequence of actions and events that occur during the scan is called the trigger model, described in [Trigger model](#) (on page 3-1).

Scanning and triggering allow you to synchronize actions across channels. You can set up a scan using the trigger model to precisely time and synchronize the Model 707B or 708B between channels and multiple instruments. You can also use triggers without the triggering model to set up a scan to meet the needs of a specific application that does not fit the triggering model.

### NOTE

If you use Scan Builder to create a scan, use the options in the Scan Builder page to run the scan. Using the TSB Embedded page may not give you the expected results.



---

## Create a scan list

---

Before you can run a scan, you must create a scan list. A scan list is a set of steps that runs in order during a scan. Each step contains a channel, channels, or channel patterns that you want to measure in that step. Each step is acted on separately during the scan.

You can mix channel patterns and individual channels in a scan list. Note that the steps are executed in the order in which they are added to the scan.

### NOTE

Before setting up a scan list, make sure your channels and channel patterns are configured. See [Working with channels](#) (on page 2-80) for detail.

If you change the channel configurations or channel patterns after the scan list has been set up, you may not see expected results. If the change prevents the scan from functioning properly (such as deleting something referenced by the scan), an error message is logged.

#### *To create a scan list from the web interface:*

1. From the left navigation of the web interface Home page, select **Scan Builder**.
2. In the Add Channel By list on the right, select **Number** to add the channels individually or **Pattern** to select patterns. You can include both channels and patterns in the same scan list.
3. If you selected **Number**, select the channel numbers from the list. To remove your selections from the Add Channel By list, click **Clear Channel Selection**. You can use Ctrl+click to select multiple channels and Shift+click to select a range of channels.
4. If you selected **Pattern**, select a pattern from the Channel Pattern list.
5. Click **Add Step**. The channels and patterns are added to the Steps list.
6. In the **Scan Count** box, enter the number of times you want to repeat the steps in the scan.
7. Repeat these steps as needed to build the scan steps. The scan is saved as you build it.

---

## Clear the scan list from the web interface

---

Clearing the scan list deletes all channels and channel patterns from the scan list.

#### *To clear the scan list from the web interface:*

1. From the left navigation area of the web interface home page, select **Scan Builder**.
2. Click **Scan Clear**.

---

## Review the scan list

---

You can review the existing scan list to see which channels and channel patterns are listed, and in which order.

#### *To review the scan list from the web interface:*

1. From the left navigation of the web interface Home page, select Scan Builder.
2. Select the **Build & Run** tab. The scan list is shown in the Steps box.

---

## Reset the scan list

---

You can clear the scan list and return scan settings to their factory defaults using scan reset. A scan reset does not affect any settings in the instrument except the scan list and trigger model.

The settings that are affected are:

- Channels and patterns are removed from the scan list
- Bypass: Returned to default setting of ON
- Mode: Returned to default setting of Open All
- Scan count: Returned to default setting of 1
- Trigger to start scan: Set to Immediate
- Trigger to continue channel action for each scan step: Setting is cleared
- Arm (Scan Start Stimulus) is set to None
- Channel Action Stimulus is set to Channel Ready Event
- Channel Ready Event is set to None
- Scan Complete Even is set to None

**To reset the scan list from the web interface:**

1. From the left navigation of the web interface Home page, select Scan Builder.
2. Click **Scan & Trigger Reset**.

---

## Run the scan

You can run a scan in one of several ways:

- **Background:** Runs the scan in the background so that you can perform other tasks while the scan is running. You can use the Query State to check scan status.
- **Step by Step:** Steps through the scan.

**To run the scan as a background scan from the web interface:**

Click **Execute Background** or **Step by Step**.

---

## Stop the scan

**To stop the scan from the web interface:**

On the Build & Run tab, click **Abort**.

---

## Monitor the state of the scan

To monitor the state of the scan, you can click **Query State** on the Build & Run tab. **Query State** displays the current state of the scan, which can be:

- Empty: No scan defined
- Building: Scan list is being created
- Running: Scan in process
- Success: Scan completed successfully

---

## Set up simple triggers

You can set up triggers to control your scan using the options on the Simple Trigger tab. You can set:

- The event that starts the scan
- The time interval event that controls the channel action for each step of the scan

To see these options, click the **Simple Trigger** tab from the top of the Scan Builder page.

### Trigger to start scan

You can choose the triggers that will be used to start the scan. The options to start the scan are:

**Immediate:** When Immediate is selected, the scan starts as soon as you click **Execute Background** on the Build & Run tab. Select Immediate when you do not have trigger requirements to start the scan. This is the default selection.

**Digital Input:** When selected, you select a digital line (1 to 14) that is used to start a scan. You can select falling or rising for the digital input. Falling selects the falling edge trigger. Rising selects the rising edge of the trigger.

### NOTE

If Other is displayed in the mode list, a different mode (other than falling or rising) is already selected. Other is not a mode and cannot be selected. It is only an indicator that the digital triggering is already set up for a different mode. See [Advanced triggering](#) (on page 2-74) for other options.

### Channel action trigger

You can select the trigger to use to continue channel action for each scan. The options to continue channel action are:

**Immediate:** When immediate is selected, the scan immediately steps to the next channel in the scan list. This is the default setting.

**Digital Input:** When selected, you select a digital line (1 to 14) that is used to trigger the instrument to step to the next channel. You can select falling or rising for the digital input. Falling selects the falling edge trigger. Rising selects the rising edge of the trigger.

### NOTE

If Other is displayed in the mode list, a different mode (other than falling or rising) is already selected. Other is not a mode and cannot be selected. It is only an indicator that the digital triggering is already set up for a different mode. See [Advanced triggering](#) (on page 2-74) for other options.

**Every *N* seconds:** This parameter adds a fixed delay between each channel. The delay occurs before the next channel in the scan list is closed.

### Advanced triggering

The Advanced Trigger tab of the Scan Builder allows you to set the options that are available from the Simple Trigger tab, as well as more sophisticated options to control scan triggering.

The Advanced Trigger tab uses the trigger model flowchart to help you visualize and define the input and output triggers to the scan.

For more information on the trigger model, see [Trigger model](#) (on page 3-1).

The options on the Advanced Trigger tab include:

- **Mode:** Select Open All to open all slots before the scan starts. Select Open Selective to open only channels that are involved in scanning; closed channels that are not involved in scanning remain closed. Select Fixed ABR to open all channels involved in the scan, but close all required backplane relays before the scan.
- **Arm (Scan Start) Stimulus:** Select the event that causes the arm event detector trigger to be set to the detected state (the scan can begin).
- **Channel Action Stimulus:** Select the event that causes the channel event detector to be set to the detected state (the step can begin).
- **Channel Ready Event To:** Select the recipient of the Channel Ready Event.
- **Scan Complete Event To:** Select the recipient of the Scan Complete Event.

There is also a **Config** button available for each of the options except Mode. When you click this button, a dialog box with additional options for the selection is displayed.

### Set the scan mode

The scan mode determines how channels are opened before the start of the scan.

You can select:

- **Open all:** All slots are opened.
- **Open select:** All channels selected in the scan list are opened; any closed channels remain closed if they are not in the scan list.
- **Fixed ABR:** All necessary backplane relays are closed before the scan.

#### *To set the scan mode from the web interface:*

1. Select the **Advanced Trigger** tab.
2. Select **Mode**.
3. Select **Open All** or **Open Selective**.

## TSB Embedded

TSB Embedded is an application that includes a command line interface that you can use to issue ICL commands. It also offers script-building functionality. TSB Embedded resides in the instrument.

### Script management options

Existing scripts are listed in the User Scripts box on the left side of TSB Embedded.

To run a script, click the name of the script and then click **Run**.

To delete a script, click the name of the script and click **Delete**. The script is deleted from the User Scripts list and from the nonvolatile memory of the instrument.

To stop operation of a script, click **Abort Script**.

To export the selected script to the computer, click **Export to PC**. Choose the directory in which to save the script and click **Save**. Scripts are saved to a file with the extension `t.sp`. TSP files are native to Test Script Builder or TSB Embedded, but they can be opened and edited in any text editor.

To import scripts from the computer, click **Import from PC**. Select the directory that contains the file. You can only import files with the extension `tsp`.

To clear the name box and the box that contains the script, click **Clear**.

To view the contents of a script, type the name of a script in the TSP Script box and click **View Script**.

To create a script, see [Create a script using TSB Embedded](#) (on page 2-76).

### Command line interface

**Console:** Enter command line entries here to send commands to the instrument. Click **Enter** to send the command. The commands and output are shown in the Instrument Output box.

To resend a command, click the button at the left of the Console box.

**Figure 52: Web interface console**

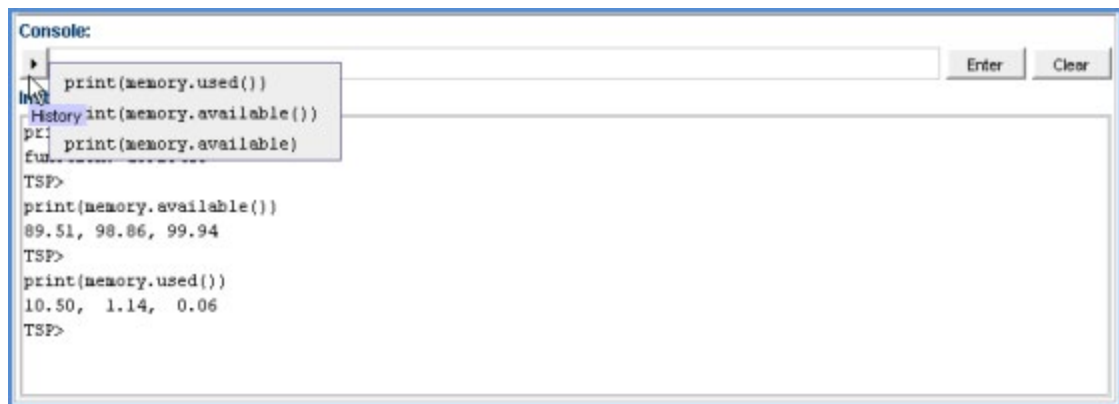

### Instrument control

To reset the entire TSP-enabled system, including the controlling node and all subordinate nodes, click **Reset**.

## Create a script using TSB Embedded

### NOTE

If you are using TSB Embedded to create scripts, you do not need to use the commands `loadscript` or `loadandrunscript` and `endscript`.

You can create a script from the instrument web page with TSB Embedded. When you save the script in TSB Embedded, it is loaded into the run-time environment and saved in the nonvolatile memory of the instrument. For information about using TSB Embedded, select the **Help** button on a web page or the Help option from the navigation pane on the left side of the web interface.

#### **To create a script using TSB Embedded:**

1. In the TSP Script box, enter a name for the script.
2. In the input area, enter the sequence of commands to be included in the script.
3. Click **Save Script**. The name is added to the User Scripts list on the left.

## Admin page

Through the Admin page, you can change the instrument password and the instrument time.

### Change the password

---

*To change the password for the web interface:*

1. In the web interface, from the left navigation, click **Admin**. A login page is displayed.
2. Enter the current password in the Password box. (The default is "admin".)
3. Click **Login**. The Administration page is displayed.
4. In the Current Password box, enter the current password.
5. In the New Password box, enter the new password.
6. In the Confirm New Password box, enter the new password again.
7. Click **Submit**. The new password takes effect immediately.

### Change the instrument date and time

---

*To change the date and time of the instrument:*

1. In the web interface, from the left navigation, click **Admin**. A login page is displayed.
2. Enter the current password in the Password box (the default is "admin").
3. Click **Login**. The Administration page is displayed.
4. Enter the Year.
5. Select the Month, Day, Hour, Minutes and Seconds from the lists.
6. Click **Submit**. The new time and date information takes effect immediately.

## Unit page

**Create Config Script:** Save the set up of the instrument as a script.

*To create the script:*

1. Click **Create Config Script**. The Create Config Script dialog box is displayed.
2. To create a script that will run automatically when the instrument is powered on, select "Auto-execute on powerup." Note that this will overwrite the existing autoexec script.
3. To create a script with a new name, select Name and enter the name.
4. Click **OK**.

**Reset:** Resets all instruments in the TSP-enabled system. This is only available if the instrument is the master.

**Open All:** Click this to open all relays on all slots.

**Upgrade Firmware:** Select a firmware upgrade file to download to the instrument and begin the upgrade process.

**Channel Connect Rule:** Select the channel connect rule. See [Connection methods for close operations](#) (on page 2-82) for detail.

**Digital I/O Lines:** This is the tool to configure the 14 digital I/O lines of the instrument. Values can be read or written to the ports, or each individual bit can be toggled. "Write Protect" can be set individually for any I/O line.

**Generate Report:** This generates an instrument report you can use to:

- Review card or instrument information, including a basic description, the firmware revision, and the serial number.
- Review configuration information, including card configuration and number of poles.
- Review the number of closures for each channel on the selected slots. The counts reported for the following cards indicate the number of closures since the last power cycle of the card:
  - 7072
  - 7072-HV
  - 7173-50
  - 7174A
- The number of closures are the closures that have occurred over the lifetime of the card for all other cards.

To print the report, click **Print**.

To clear the report information from the screen, click **Clear**.

## LXI page

The Model 707B or 708B is a LXI Class C instrument. The LXI page is a read-only page that displays the LXI information about the instrument.

## IP Config

The IP Config allows you to review and change the LAN connection information.

See [Change the IP configuration through the web interface](#) (on page 2-55) for more information.

## Log page

The event log records all LAN[0-7] triggers generated and received and can be viewed over any command interface, including the web interface. The following figure shows the view of the LAN[0-7] event log from the embedded web interface.

Up to 32 LAN[0-7] events are logged and shown on this page. The event log is circular and rolls over after 32 events are captured. The LAN[0-7] events correspond to the lan.trigger[1-8] subsystem.

**Figure 53: Event log**

Receive Time	EventID	From	PTP Timestamp		HWDetect	Sequence	Domain	Flags	Data
			Seconds	FractionalSeconds					
Refresh									

The timestamp, event identifier, the IP address and the domain name identify the incoming and outgoing LXI trigger packets. The following table provides detailed descriptions for the columns in the event log.

#### Event log descriptions

Column title	Description	Example
Receive Time	Displays the date and time when the LAN trigger occurred in UTC, 24-hour time	06:56:28.000 8 May 2008
EventID	Identifies the lan.trigger[N] that generates an event	LAN0 = lan.trigger[1] LAN1 = lan.trigger[2] LAN2 = lan.trigger[3] LAN3 = lan.trigger[4] LAN4 = lan.trigger[5] LAN5 = lan.trigger[6] LAN6 = lan.trigger[7] LAN7 = lan.trigger[8]
From	Displays the IP address for the device that generates the LAN trigger	localhost 192.168.5.20
System Timestamp	A timestamp that identifies the time the event occurred. The timestamp uses the following: PTP timestamp Seconds Fractional seconds The Model 707B or 708B does not support the IEEE-1588 standard; the values in this field are always 0 (zero)	
HWDetect	Identifies a valid LXI trigger packet	LXI
Sequence	Each instrument maintains independent sequence counters: One for each combination of UDP multicast network interface and UDP multicast destination port. One for each TCP connection.	
Domain	Displays the LXI domain number (the default value is 0 (zero))	0 1523
Flags	Contain data about the LXI trigger packet	Values: 1 - Error 2 - Retransmission 4- Hardware 8 - Acknowledgments 16 - Stateless bit
Data	The Model 707B or 708B does not support the IEEE-1588 standard; the values in this field are always 0 (zero)	



## Switch operation

### Working with channels

#### Overview

---

This section gives an overview of working with channels, including a discussion of channel types, selecting channels, opening and closing channels, setting common channel attributes, and setting up channel patterns.

#### NOTE

To install the switching card, refer to instructions in Models 707B and 708B Quick Start Guide.

The Models 707B and 708B have specific settings that apply to opening and closing channels.



#### CAUTION

Hot switching can dry weld reed relays such that they will always be on. Hot switching is recommended only when external protection is provided.

#### Specifying a channel

---

The channels on the cards that you can use with the Model 707B or 708B are referred to by a channel specifier. You will use the specifier to identify channels for use with close and open operations, scans, and channel patterns. The specifier is used for all interfaces (front panel, web, and remote command).

A channel specifier is a four or five-digit alphanumeric sequence. The first digit is always the slot number of the slot in which the card is installed in the instrument. The remaining digits vary depending on the type of card.

The following sections describe the channel specifier in more detail and provide generic examples (which may or may not be suitable for your installed cards).

#### Channel types

The Models 707B and 708B support cards with matrix channels. The documentation for your card model lists the available channel types.

Specify multiple channel numbers using lists. Lists build on the individual channel specifier.

### Matrix card channel specifiers

The channels on the matrix cards are referred to by their slot, bank, row, and column numbers:

- **Slot number:** The number of the slot in which the card is installed.
- **Bank number:** The bank number, if used by your card. See your card documentation.
- **Row number:** The row number is either 1 to 8 or A to Z. See your card documentation.
- **Column number:** Always two digits. For columns greater than 99, use A, B, C and so on to represent 10, 11, 12, ...; the resulting sequence is: 98, 99, A0, A1, ..., A8, A9, B0, B1, ...

### Matrix channel examples

Specifier	Slot number	Bank number	Row number	Column number
1A05 or 1105*	1	N/A	1	05
1C05	1	N/A	3	05
3C12	3	N/A	3	12

\* Specifier depends on card type. See your card documentation for detail.

### Channel list parameter for remote commands

The channel list parameter is a string-type parameter that is used when controlling the relays of the Model 707B or 708B using a remote command interface. You can specify a list of individual channels or a range of channels in the channel list parameter.

In the command descriptions, the channel list parameter is shown as *channelList*.

When sending this parameter:

- Enclose the contents of the channel list in either single (') or double (") quotes. The beginning and end quotes must be the same style.
- Use a comma or semicolon to separate the channel list or [channel patterns](#) (on page 2-92).
- The string may contain a single channel, single channel pattern, multiple channels, or multiple channel patterns that are comma-delimited.
- Use a colon between the start and end channel to specify a range of channels. The lowest channel must be first and the highest last.

Examples:

- To perform an open or close operation on row 1 and columns 3 and 5 of slot 1, use ("1A03, 1A05") for the *channelList* parameter.
- To perform an open or close operation on all channels in the range of row 1 and columns 1 through 5 of slot 1, use ("1A01:1A05") for the *channelList* parameter.

### Queries that return a list of channels

For queries that return a channel list parameter, the Model 707B or 708B separates the channels by a comma or semicolon, depending on the command. When multiple channels are used in the query, the information for the lowest numbered channel is listed first, increasing to the highest numbered channel.

When multiple slots are used in the query, the information for the lowest slot number is listed first and increases to the highest slot and channel.

### Connection methods for close operations

You can dictate the order in which relays are opened and closed using the channel connection rule.

#### WARNING

*When the connection rule is set to break before make, the instrument ensures that all switch channels open before any switch channels close. This behavior covers the most common applications and is considered the safest connection rule because the tested device is completely decoupled from the instrument. This is the default behavior. When switch channels are both opened and closed, this command executes not less than the addition of both the open and close settle times of the indicated switch channels.*

*When the connection rule is set to make-before-break, the instrument ensures that all switch channels close before any switch channels open. This behavior should be applied with caution because it will connect two test devices together for the duration of the switch close settle time. When switch channels are both opened and closed, the command executes not less than the addition of both the open and close settle times of the indicated switch channels.*

*With no connection rule (set to `channel.OFF`), the instrument attempts to simultaneously open and close switch channels in order to minimize the command execution time. This results in faster performance at the expense of guaranteed switch position. During the operation, multiple switch channels may simultaneously be in the close position. Make sure your device under test can withstand this possible condition. When switch channels are both opened and closed, the command executes not less than the greater of either the open or close settle times of the indicated switch channels.*

*Cold switching is highly recommended.*

#### CAUTION

Hot switching can dry weld reed relays such that they will always be on. Hot switching is recommended only when external protection is provided.

The channel connect rule determines the order in which multiple channels are opened and closed on the instrument. This attribute applies to electromechanical, reed, and solid state relay switching cards.

You can set the channel connect rule to be:

- **BBM** (break before make): The instrument ensures that all switch channels open before any switch channels close. It is used to avoid momentary shorting of two voltage sources. This is the default.
- **MBB** (make before break): The instrument ensures that all switch channels close before any switch channels open. It is used to eliminate transients caused by switching between current sources. MBB should be applied with caution because it connects two test devices together for the duration of the switch close settle time.
- **OFF**: Permits the instrument to initiate close and open operations simultaneously. This minimizes settling time for the close operation.

## NOTE

You cannot guarantee the sequence of open and closure operations when the channel connect rule is set to OFF. It is highly recommended that you implement cold switching when the channel connect rule is set to OFF.

### *To set the channel connect rule through the front panel interface:*

1. Press the **MENU** key.
2. Use the navigation wheel to scroll to the CHANNEL menu item.
3. Press the **ENTER** key (or the navigation wheel) to display the CONNECT MENU.
4. From this menu, select the RULE menu item.
5. Set the rule to BBM, MBB, or OFF.
6. Use the **ENTER** key to apply the selection.
7. Use the **EXIT** key to leave the menu.

### *To set the channel connect rule through the web interface:*

1. On the Unit page, in the upper left corner, select the channel connect rule menu.
2. Select Break Before Make, Make Before Break, or OFF.

### *To set the channel connect rule through the remote command interface:*

Use the `channel.connectrule` command. Refer to the TSP commands for details.

## Using sequential connect

---

During normal operation, the instrument attempts to minimize the duration of any channel action for a given card type and connect rule. This can result in multiple channels closing or opening simultaneously.

To prevent simultaneous closing and opening, you can use a sequential connection. A sequential connection ensures an orderly closing or opening of single individual channels in a channel list. An orderly action provides for:

- Repeatable and deterministic channel operation times
- Minimized power usage

You incur settling times at each close or open operation. If sequential connection is not selected, action settling times may vary depending on the card type. The total settling time is the sum of the settling times for each specified channel, plus any user delays that have been set for any closed channels. To better calculate timing, you can enable sequential channel connections. Deterministic implies that you can determine the time for a close operation to happen. For example, if you close three channels and each takes 4 ms to close, with sequential on, it will take 12 ms. With sequential off, it may be 4, 8 or 12 ms, depending on whether or not the card can close multiple channels at once.

Opening and closing relays in a sequential manner also uses minimum power. Since only one relay is closed or opened at any given time, the power used for that action is for a single relay and not additive.

By default, sequential connections are turned off. The order in which channels are opened or closed is not guaranteed. This feature also applies to scanning.

The sequential setting affects all channels in the instrument.

***To enable sequential connections through the front panel interface:***

1. Press the **MENU** key.
2. Use the navigation wheel to scroll to the CHANNEL menu item.
3. Press the **ENTER** key.
4. Select the SEQUENTIAL menu item.
5. Select ON or OFF.
6. Use the **ENTER** key to apply the selection.
7. Use the **EXIT (LOCAL)** key to leave the menu.

***To enable sequential connections through the web interface:***

1. Open the **UNIT** page.
2. In the upper left corner, select the Sequential check box (next to the Channel Connect Rule list).

***To enable sequential connections through the remote command interface:***

Send the command:

[channel.connectsequential](#) (on page 7-19)

## Determining the number of relay closures

---

The Models 707B and 708B keeps an internal count of the number of times each switching card relay has been closed. The total number of relay closures is stored in nonvolatile memory on the switching card. Use this count to determine when relays require replacement (see the card documentation for information regarding the contact life specifications).

Relay closures are counted only when a relay transitions from open to closed state. If you send multiple close commands to the same channel without sending an open command, only the first closure is counted.

### NOTE

The counts reported for the following cards indicate the number of closures since the last power cycle of the card:

- 7072
- 7072-HV
- 7173-50
- 7174A

For all other cards, the number of closures are the closures that have occurred over the lifetime of the card.

#### *To view the close count for a channel from the front panel:*

1. Use the navigation wheel  to select the channel.
2. Press the **CONFIG** key.
3. Press the **CHAN** key.
4. Use the navigation wheel to scroll to the "COUNT" menu item.
5. Press the **ENTER** key (or the navigation wheel) to display the close counts.
6. Use the **EXIT** key to leave the menu.

#### *To view the close count for a channel from the web interface:*

1. From the list on the left, select a slot with an installed card.
2. Right-click a channel. The Channel Configuration dialog box is displayed.
3. Check the value in the Closure Count box.

### NOTE

You can also work with channel patterns using the command `channel.getcount()`.

## Identify installed switching cards

---

#### *To identify installed switching cards from the front panel:*

Press the **SLOT** key to scroll through the model numbers, descriptions, and firmware revisions of the installed switching cards.

**To identify installed switching cards from the web interface:**

1. Select the **Unit** page.
2. In the Report area, select the slots that you want information about.
3. Select **Firmware Revision**.
4. Click **Generate Report**. Information about the cards in the slots is displayed below the button.

**To identify installed switching cards from the remote command interface:**

Use `print(slot[X].idn)` to query and identify installed switching cards:

```
print(slot[X].idn)
```

Where:  $X$  = slot number (from 1 to 6)

**Example**

To get a list of all switching cards installed in the slots of a Model 707B or 708B, send the following command over the remote command interface:

```
for x=1,6 do print (slot[x].idn) end
```

The response will be similar to the following:

```
7174, 8x12 Fast Low-I Matrix, 01.00a, <Module Serial Number>  
7072, 8x12 Semi Matrix, 01.00a, <Module Serial Number>  
Empty Slot  
Empty Slot  
Empty Slot  
Empty Slot
```

## Selecting a channel from the front panel

You can perform operations on a single channel from the front panel. To select a channel, see [Selecting channels from the front panel](#) (on page 2-15). Once a channel is selected, it is the selected channel for front panel operation.

## Closing and opening channels

Switching channels allow various methods for closing and opening relay channels.

### NOTE

You can use scans to perform a user-specified sequence of close and open operations on multiple channels. Refer to [Scanning and triggering](#) (on page 3-1) for information on scan operations.

### Operating a channel from the front panel

### NOTE

For the Model 707B, also see [Selecting and closing channels using the crosspoint display](#) to select a channel using the crosspoint display.

### CAUTION

Hot switching can dry-weld reed relays, causing them to always be on. Hot switching is recommended only when external protection is provided.

You can perform operations on a single channel from the front panel.

**To select a channel:**

1. If the instrument is being controlled remotely, press **EXIT** to allow control from the front panel.
2. Turn the navigation wheel  until the channel specifier is displayed on the front panel.  
To:
  - Close a channel without affecting any other channels: Select **CLOSE**.
  - Open the channel: Press **OPEN**.
  - Close a channel and open any other closed channels on the instrument: Select **CHAN** and select **EXCLOSE**. Press **ENTER** to close the selected channels.
  - Close a channel and open any other closed channels on the slot that contains the selected channel: Select **CHAN**, and then select **EXSLOTCLOSE**. Press **ENTER** to close the selected channels.



## NOTE

Once a channel is selected, it is the selected channel for any subsequent front-panel operations.

### Open and close channels from the Channel Action Menu

You can also use the options in the Channel Action Menu to open and close channels.

**To use the Channel Action Menu to open and close channels:**

1. Go to channel view.
2. Select the channel you want to open or close.
3. Press **CHAN**.
4. Use the navigation wheel  to select the option. You can select:
  - **OPEN**: Opens the selected channel.
  - **CLOSE**: Closes the selected channel.
  - **EXCLOSE**: Closes the selected channel; opens any other channels that are closed.
  - **EXSLOTCLOSE**: Closes the selected channel; opens any other channels that are closed on the same slot.
5. Press the navigation wheel  to open or close the channel.

### Selecting, closing, and opening a channel from the web interface

You can perform operations on a single channel from the web interface.

**To select a channel:**

1. You must log into the instrument to work with the channels. See [Log in to the instrument](#) (on page 2-67). After logging in, you can access the channel controls.
2. From the instrument home page, from the navigation on the left, select the slot that contains the channels you want to work with.



Figure 54: Web interface Cards list

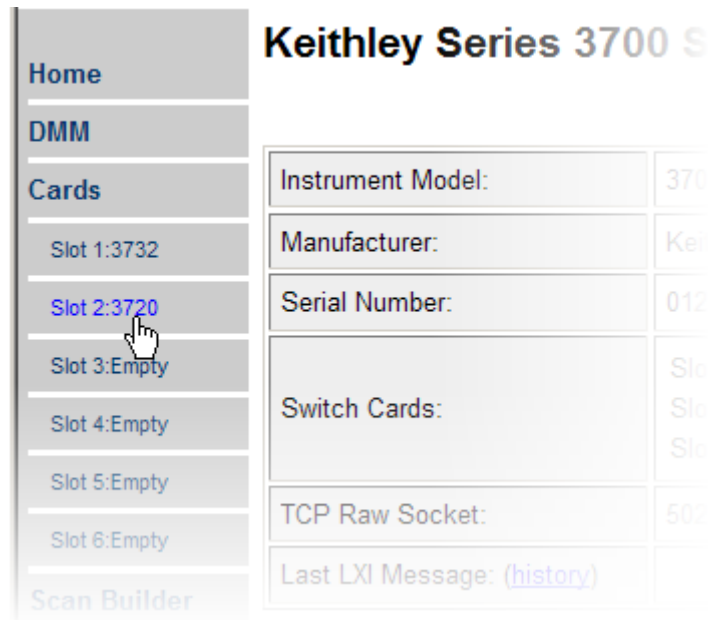

- To close a channel, click the channel. The display of the channel depends on the card that you have installed. Some examples are shown here.

Figure 55: Selecting, closing, and opening a channel from the web interface

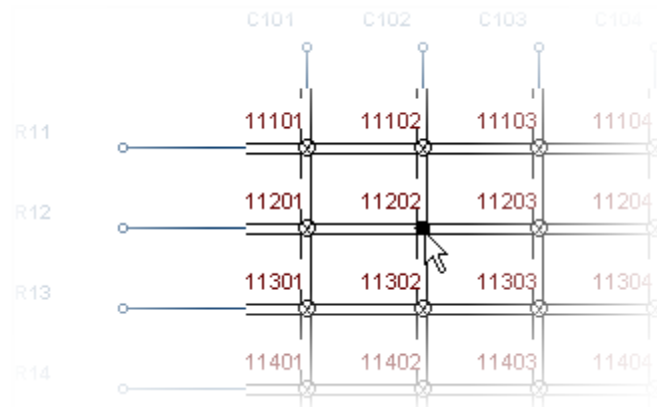
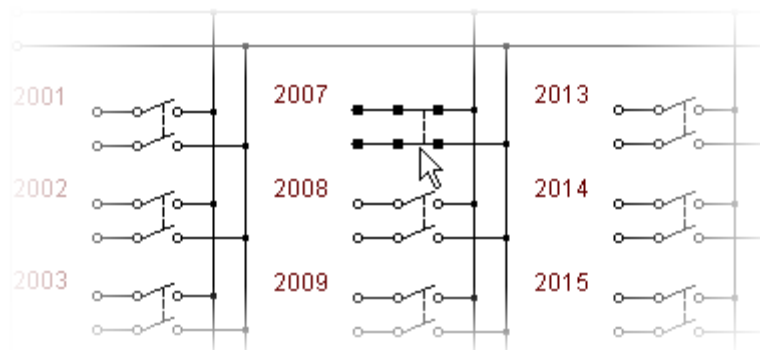
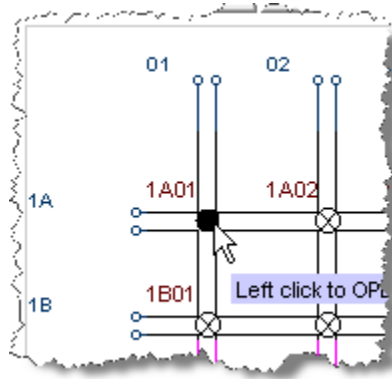
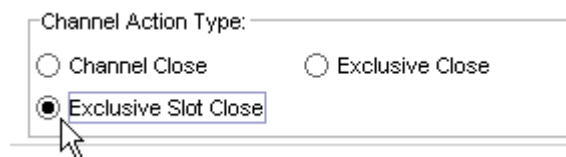

Figure 56: Selecting, closing, and opening a channel from the web interface



**Figure 57: Close a channel**

4. To open a closed channel, click it again.
5. To perform an exclusive close on a channel:
  - a. Select **Exclusive Slot Close** in the Channel Action Type box.

**Figure 58: Select exclusive slot close**

- b. Click a channel to close that channel and open all other channels.

### Selecting, closing, and opening a channel using remote commands

#### To close or open a channel from the remote interface:

You can open and close channels using the following commands:

[channel.close\(\)](#) (on page 7-17)

[channel.exclusiveclose\(\)](#) (on page 7-22)

[channel.exclusiveslotclose\(\)](#) (on page 7-23)

[channel.open\(\)](#) (on page 7-33)

For example, to close channel 1001 over the remote interface, send the command:

```
channel.close("1001")
```

## NOTE

Refer to the TSP commands for details on commands.

### Viewing the close or open status of a channel

To determine whether a channel is closed or open, you can view its status using the front panel interface, remote command query, or instrument web page.

### Viewing status from the front panel

Closed channels are shown on the display of the instrument, separated by commas. If more than one line of closed channels are displayed, you can press **DISPLAY** to display the full list. Use the navigation wheel  to scroll through the list.



## NOTE

For a four-pole operation the paired channel is not displayed on the front panel of the Models 707B and 708B.

### Viewing status from the remote command interface

To view a list of closed channels, use the `channel.getclose()` command. For example:

```
print(channel.getclose("allslots"))
```

To view the close and open status of channels, use the `channel.getstate()` command.

### Viewing status from the instrument web page

To view status from the instrument web page, from the list on the left, select the slot that contains the channel. The status is displayed on the web page for the slot.

## Channel attributes

You can use the front panel and command options to set attributes for specific channels. Some of the attributes you can set are adding a delay, forbidding closure of a channel, and setting channel labels, which are described in the following sections.

### Set additional delay

You can set an additional delay to incur after the relay settles when closing.

#### *To set additional delay time from the front panel:*

1. Display a channel (you might need to press **DISPLAY**).
2. Select the channel for which you want to set attributes.
3. Press **CONFIG**, then press **CHAN**.
  - **DELAY:** Additional delay to incur after the relay settles. Enter the value for the delay in seconds. The total delay for channel operation is user delay plus the relay settling time.

#### *To set additional delay time from the web interface:*

1. From the list on the left, select the slot that contains the channel you want to set an additional delay on.
2. Right-click on the channel you want to bring up the channel configuration dialog box for that channel.
3. Enter the desired delay time (in seconds) in the delay time field on the right side of the dialog box. Once the desired time is entered, click **OK**.

**To set additional delay time through the remote interface:**

Use the command:

```
channel.setdelay() (on page 7-41)
```



**Forbid closing a channel**

You can prevent a channel from being closed from any interface by setting it to forbidden.

**NOTE**

If the channel that is to be forbidden is used in a channel pattern, the pattern is deleted when you set the channel to be forbidden to close.

**To forbid closing of a channel from the front panel:**

1. Display a channel (you might need to press **DISPLAY** first).
2. Select the channel for which you want to set attributes.
3. Press **CONFIG**, then press **CHAN**.
4. Use the navigation wheel  to select **FORBID**.
5. Select Yes to prevent a channel from being closed or No to allow closures.
6. Press the navigation wheel  to save the change.

**To forbid closing of a channel from the web interface:**

1. From the list on the left, select the slot that contains the channel you want to forbid close on.
2. Right-click the channel.
3. Select the forbidden checkbox.
4. Click **OK**.

**To forbid closing of a channel from the remote interface:**

You can also set this attribute using the following commands:

- `channel.setforbidden()` (on page 7-42)
- `channel.clearforbidden()` (on page 7-16)

**Set up labels**



You can define labels for rows, columns, and channels.

Labels must be unique; they cannot have the same as the name of another row, column, channel, or channel pattern. Labels cannot contain spaces, and they do not persist through a power cycle.

Channel labels can be up to 19 characters. Row and columns labels can be up to 8 characters. On the crosspoint display, the first four characters of the label are displayed. On the bottom display, the full label is displayed.

You can only set labels for slots and channels that are installed in the instrument.

**To set up labels from the front panel:**

1. Display a channel (you might need to press **DISPLAY** first).
2. Select the channel for which you want to set labels.
3. Press **CONFIG**, then press **CHAN**.
4. Use the navigation wheel  to select the type of label you want to define:
  - **LABEL**: Sets the label that is displayed on the front panel for the specified crosspoint.
  - **LABEL-ROW**: Sets the label that is displayed on the front panel for the specified row.
  - **LABEL-COL**: Sets the label that is displayed on the front panel for the specified column.
5. Change the name using the navigation wheel .
6. Press the navigation wheel  to save the change.

**To set up labels from the web interface:**

1. From the list on the left, select the slot that contains the channel you want to set up a label on.
2. Right-click the channel.
3. In the Label box, enter the label.
4. Click **OK**.

**To set up labels from the remote interface:**

Use the commands:

- [channel.setlabel\(\)](#) (on page 7-43)
- [channel.setlabelrow\(\)](#) (on page 7-46)
- [channel.setlabelcolumn\(\)](#) (on page 7-44)

You can use labels to refer to the channels in commands. For example, if you set the label for channel 3005 to "start", you could use "start" to close and open the channel.

This is shown in the following example:

```
channel.setlabel("1A01","start")
channel.close("start")
channel.setlabelrow("1B01","SMU2")
channel.setlabelcolumn("1B01","DUT2")
channel.close("SMU2+DUT2")
print(channel.getclose("allslots"))
```

## Channel patterns

---

You can use channel patterns as a convenient way to refer to a group of switching channels with a single alphanumeric name. When you perform close or open operations on a channel pattern, only the channels that are in the channel pattern are affected.

There is no speed difference when performing close and open operations on channel patterns compared to performing the same operations on individual channels or a list of channels.

## NOTE

Channel patterns inherit the delay times of the individual channels that comprise the pattern. For information on the sequence of close operations on multiple channels, refer to [Connection methods for close operations](#) (on page 2-82).

When you create a channel pattern, make sure to:

- Include all of the channels that are needed for that channel pattern.
- Check that channels contained in the pattern are correct.
- Check that channels contained in the pattern create the desired path connection.
- Make sure that channels that you want to include in the pattern are not set to forbidden to close.

When naming the channel pattern, be aware:

- The first character of the name must be alphabetic (upper or lower case)
- Names are case sensitive
- Pattern names must be different than row, column, and channel labels

***To create a channel pattern from the front panel:***

1. Close the channels you want to include in the channel pattern.
2. Press the **PATT** key.
3. From this menu, select the **CREATE** menu item.
4. From this menu, select the **SNAPSHOT** menu item.
5. At the prompt, enter a pattern name using the navigation wheel.
6. Use the **ENTER** key to apply the selection.
7. Use the **EXIT** key to leave the menu.

**To create a channel pattern from the web interface:**

1. From the left navigation, click a slot.
2. Click **Pattern** (above the Channel Action Type box). The Channel Pattern Configuration dialog box is displayed.

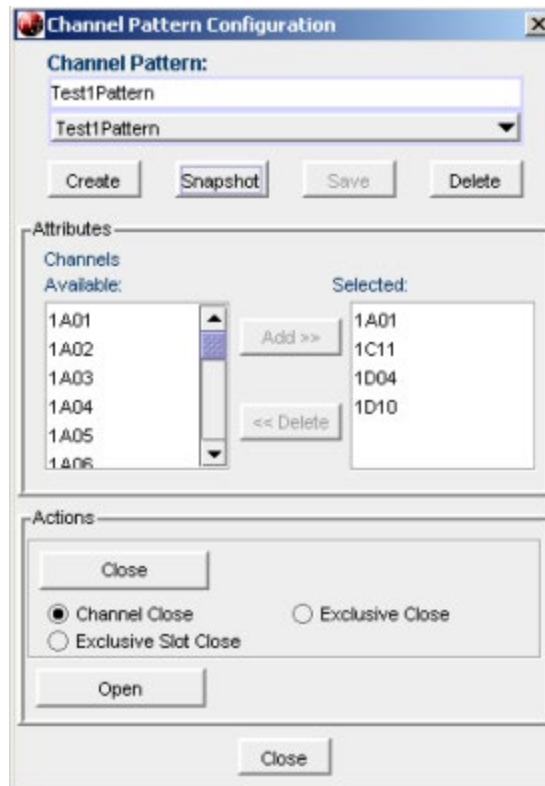
**Figure 59: Channel pattern configuration dialog box**

3. Enter a name in the box at the top.
4. From the Channels Available list, select the channels you want to add. You can use Ctrl+click and Shift+click to select multiple channels.
5. Click **Add**.
6. When the Selected channel list is complete, click **Create**.

**NOTE**

If you close the channels you want to add to the new pattern, you can enter a name and click **Snapshot** to create the new pattern. The closed channels are added to a new pattern.

**To create a channel pattern from the remote command interface:**

You can also work with channel patterns using the following commands:

[channel.pattern.catalog\(\)](#) (on page 7-35)

[channel.pattern.delete\(\)](#) (on page 7-36)

[channel.pattern.getimage\(\)](#) (on page 7-36)

[channel.pattern.setimage\(\)](#) (on page 7-37)

[channel.pattern.snapshot\(\)](#) (on page 7-39)

**NOTE**

Refer to the TSP commands for more details.

**Performing close and open operations on channel patterns****⚠ WARNING**

*Careless channel pattern operation could create an electric shock hazard that could result in severe injury or death. Improper operation can also cause damage to the switching cards and external circuitry. The control of multiple channels using channel patterns should be restricted to experienced test engineers who recognize the dangers associated with multiple channel closures.*

You can close and open channel patterns the same way you do for individual channels.

To perform a particular operation on a channel pattern, use the appropriate open or close command with the channel pattern name for the `channelList` parameter. Refer to Close and open channel operations and commands for detail.

When you request a close or open operation, the Model 707B or 708B verifies that the channels exist for a pattern, but does not verify that the switch path connection is correct. You must ensure the requested operation is safe for a channel pattern and that a good connection will result for your application with the channel pattern.

**To close or open the channels in a channel pattern from the front panel:**

1. Press the **PATT** key to display a channel pattern (you might need to press **DISPLAY** first).
2. Select the channel pattern you want to open or close.

**NOTE**

Model 707B only: Note that when you select a pattern, on the crosspoint display, the lights for the channels included in the pattern are dimly lit.

3. Perform any of the following actions:
  - Open the channels in the channel pattern: Press **OPEN**.
  - Close the channels in the channel pattern without affecting any other channels: Press **CLOSE**.
  - Close the channels in the channel pattern and open any other closed channels on the instrument: Select **PATT** and select EXCLOSE. Press **ENTER** to open or close the channels.
  - Close the channels in the channel pattern and open any other closed channels on the slot: Press **PATT** and select EXSLOTCLOSE. Press **ENTER** to open or close the channels.

**To close or open the channels in a channel pattern from the web interface:**

1. From the list on the left, select a slot with an installed card.
2. Click **Pattern**. The Channel Pattern Configuration dialog box is displayed.



Figure 60: Channel Pattern Configuration dialog box



3. Select the pattern.
4. In the Actions box, to:
  - Open the channels in the channel pattern: Click **OPEN**.
  - Close the channels in the channel pattern without affecting any other channels: Select Channel Close, then click **CLOSE**.
  - Close the channels in the channel pattern and open any other closed channels on the instrument: Select Exclusive Close and click **CLOSE**.
  - Close the channels in the channel pattern and open any other closed channels on the slot: Select Exclusive Slot Close and click **CLOSE**.

**To close or open the channels in a channel pattern from the remote interface:**

`channel.close()` (on page 7-17)

`channel.exclusiveclose()` (on page 7-22)

`channel.exclusiveslotclose()` (on page 7-23)

`channel.open()` (on page 7-33)

## NOTE

Refer to the TSP commands for detail on each command.

### Channel pattern storage

Channel patterns are:

- Part of the script that is created with Create Config Script.
- Deleted when the instrument is reset.
- Deleted when a channel associated with the pattern is reset.
- Allocated 32KB of memory in the Models 707B and 708B instrument for all channel patterns.

To see how much of the channel pattern memory is available or used, send the command:

```
print(memory.available())
```

or

```
print(memory.used())
```

Refer to `memory.available()` (on page 7-129) or `memory.used()` (on page 7-130).

### Reset a channel

You can reset a channel to its factory default settings. When you reset a channel:

- A closed channel opens
- Additional user delay is set to zero
- Labels return to default value
- If the channel is forbidden to close, it is cleared from being forbidden to close
- If the channel is used in channel patterns, the channel patterns that contain the channel are deleted.

Using this function to reset a channel involved in scanning invalidates the existing scan list. The list has to be recreated before scanning again.



## CAUTION

Resetting a channel deletes any channel patterns that contain that channel.

**To reset a channel from the front panel:**

1. Display a channel.
2. Select the channel you want to reset.
3. Press **CHAN**.
4. Select **RESET**.
5. Select **SELECTED**, **ALL**, or **CANCEL**.
6. Press the navigation wheel  to reset the channel.

**To reset all channels on a slot from the web interface:**

1. Select the slot that contains channels you want to reset.
2. Click **RESET SLOT**.
3. All channels on the slot are reset.

**To reset a channel from the remote interface:**

Send the command `channel.reset()` (on page 7-40).

## Pseudocards

You can perform open, close, and scan operations and configure your system without having an actual switching card installed in your instrument. Using the remote interface, you can assign a pseudocard to an empty switching card slot, allowing the instrument to operate as if a switching card were installed.

A pseudocard cannot be configured from the front panel. However, once the remote configuration is complete, you can take the instrument out of remote mode and use the front panel. Press the **EXIT (LOCAL)** key to take the instrument out of remote mode.

When the instrument is turned off, the pseudocard is no longer assigned to the slot.

### Pseudocards programming example

Use the following command to set the pseudocard of slot 2 for 7072 8x12 Semi Matrix card simulation:

```
slot[2].pseudocard = 7072
```

## Save the present configuration

You can capture the present settings of the instrument using the create configuration script feature. When you run this feature, the configuration script is created and saved. You can run it later to return to that configuration, or set it up to be the autoexec script. The configuration script is a normal TSP script; once created, you can use it and modify it as you would any other script.

The configuration script includes:

- Comment lines that identify the script as auto created and the date and time of creation.
- The cards that are installed and the slots in which they are installed.
- A reset command, which will reset the instrument to the factory default settings.
- The commands to reconfigure the instrument. The configuration script only captures settings that have been changed from the factory defaults.

Later, when you run the configuration script, the script will verify that the installed cards and slots match. If they do not, a message is displayed, the script stops, and the configuration is not restored.

Note that the configuration script does not include the status of channels. As initially created, the configuration script performs a reset, which opens all channels.

### NOTE

You can modify the script to change the card models or slots. However, you must make sure that all subsequent commands are valid for the card model or slot change.

### NOTE

For more information on scripts, see [Fundamentals of scripting for TSP](#) (on page 6-1). For more information on the autoexec script, see [Autoexec script](#) (on page 6-7).

A sample configuration script is shown in the following example.

<code>--Auto created configuration script</code>	Indicates that this was created with the Create Configuration Script feature
<code>--Tue Jul 13 13:02:12 2010</code>	Date and time stamp
<code>if string.find(slot[1].idn, "7174") == nil then   print(     "Card installed in slot 1 needs to be a 7174.")   display.clear()   display.settext("Card installed in\$N" ..     "\$Bslot 1\$R needs to be a \$B7174\$R")</code>	Code that verifies that card and slot are in agreement
<code>else</code>	
<code>  reset()</code>	Reset command
<code>  channel.setlabel("1A01", "FirstRowCol")   channel.setlabel("1A12", "LastRowCol")   channel.setlabel("1B01", "FirstNextRow")   channel.setlabel("1B12", "LastNextRow")   channel.pattern.setimage("1A01,1B01", "Row1_2_col_1")   channel.pattern.setimage("1A02,1B02", "Row1_2_col_2")   channel.pattern.setimage("1A03,1B03", "Row1_2_col_3")   channel.pattern.setimage("1A04,1B04", "Row1_2_col_4")   channel.pattern.setimage("1A05,1B05", "Row1_2_col_5")   channel.pattern.setimage("1A06,1B06", "Row1_2_col_6")   channel.pattern.setimage("1A07,1B07", "Row1_2_col_7")   channel.pattern.setimage("1A08,1B08", "Row1_2_col_8")   channel.pattern.setimage("1A09,1B09", "Row1_2_col_9")    channel.pattern.setimage("1A10,1B10", "Row1_2_col_10")    channel.pattern.setimage("1A11,1B11", "Row1_2_col_11")    channel.pattern.setimage("1A12,1B12", "Row1_2_col_12")   collectgarbage()   scan.trigger.channel.stimulus =     scan.trigger.EVENT_CHANNEL_READY   scan.create()   scan.mode = 0   scan.bypass = 1   scan.add("Row1_2_col_1")   scan.add("Row1_2_col_2")   scan.add("Row1_2_col_3")   scan.add("Row1_2_col_4")   scan.add("Row1_2_col_5")   scan.add("Row1_2_col_6")   scan.add("Row1_2_col_7")   scan.add("Row1_2_col_8")   scan.add("Row1_2_col_9")   scan.add("Row1_2_col_10")   scan.add("Row1_2_col_11")   scan.add("Row1_2_col_12")</code>	Code that captures the non-factory default settings
<code>end</code>	

## Create a configuration script

When you run the create configuration script feature, it automatically generates a user script that is saved to a script with a name that you define. Create configuration script is available from the front panel of the instrument, the web interface, and the remote interface.

### NOTE

When you specify the name of the script, be aware that if you specify a name that already exists (including `autoexec`), the existing script is overwritten with the new configuration script.

#### To create a configuration script from the front panel:

1. Press **MENU**.
2. Select **SCRIPT**.
3. Select **CREATE-CONFIG**. The AUTOEXEC ON PWR UP prompt is displayed.
4. Select **Yes** or **No**.
5. If AUTOEXEC is set to no, at the name prompt, enter the name of the configuration. The default name is config01.
6. Press **ENTER**.
7. The AUTOEXEC message is displayed again. Press **EXIT** several times to return to the normal display.

#### To create a configuration script from the web interface:

1. Open the **Unit** page.
2. Log in if necessary.
3. Click **Create Config Script**.

Figure 61: Create Config Script dialog box

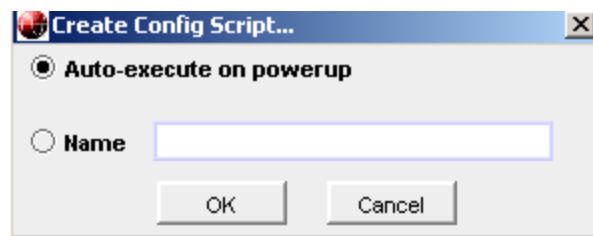

4. To make the configuration script the autoexec script, select Auto-execute on powerup.
5. To assign a name (the script will not be the autoexec script), select Name and enter a name in the box.
6. Click **OK**. The configuration script is created.

#### To create a configuration script from the remote interface:

Send the command:

```
createconfigscript (name)
```

Where *name* is the name you want to assign to the configuration script.

## Running the configuration script

You can run the configuration using the same methods as any other script. See [Run scripts](#) (on page 6-5) for information.

---

## Functions and features

### In this section:

---

Scanning and triggering .....	3-1
Trigger model .....	3-1
Scan and step counts .....	3-4
Basic scan procedure .....	3-5
Remote interface scanning .....	3-8
Hardware trigger modes .....	3-13
Understanding synchronous triggering modes .....	3-17
Events .....	3-21

## Scanning and triggering

A scan is a series of steps that opens and closes switches sequentially for a selected group of channels. During each step, actions occur, such as waiting for a trigger, taking a measurement, and completing a step count. Scans automate actions that you want to perform consistently and repeatedly on a set of channels.

Triggers are events that prompt the instrument to move from one step to another in a scan. Triggers can come from a variety of sources, such as a key press, digital input, or expiration of a timer. The sequence of actions and events that occur during the scan is called the trigger model.

Scanning and triggering allow you to synchronize actions across channels. You can set up a scan using the trigger model to precisely time and synchronize the Model 707B or 708B between channels and multiple instruments. You can also use triggers without the triggering model to set up a scan to meet the needs of a specific application that does not fit the triggering model.

## Trigger model

When you run a scan, the scan sequence follows a trigger model. The trigger model is shown in the following flowchart.

### NOTE

In Models 707B and 708B, only scanning operations use the trigger model. Individual open, close, and measure commands do not affect the trigger model.

The trigger model is used during a scan only. For front panel operation, you use the **SCAN** and **STEP** keys to perform scan actions. For remote operation, you use the scan functions and attributes commands, for example, `scan.execute()` and `scan.mode`.

## NOTE

You cannot use an external trigger event (for example, digital I/O) for the channel stimulus setting of the trigger model when using the front-panel STEP key.

**Figure 62: Models 707B and 708B triggering overview**

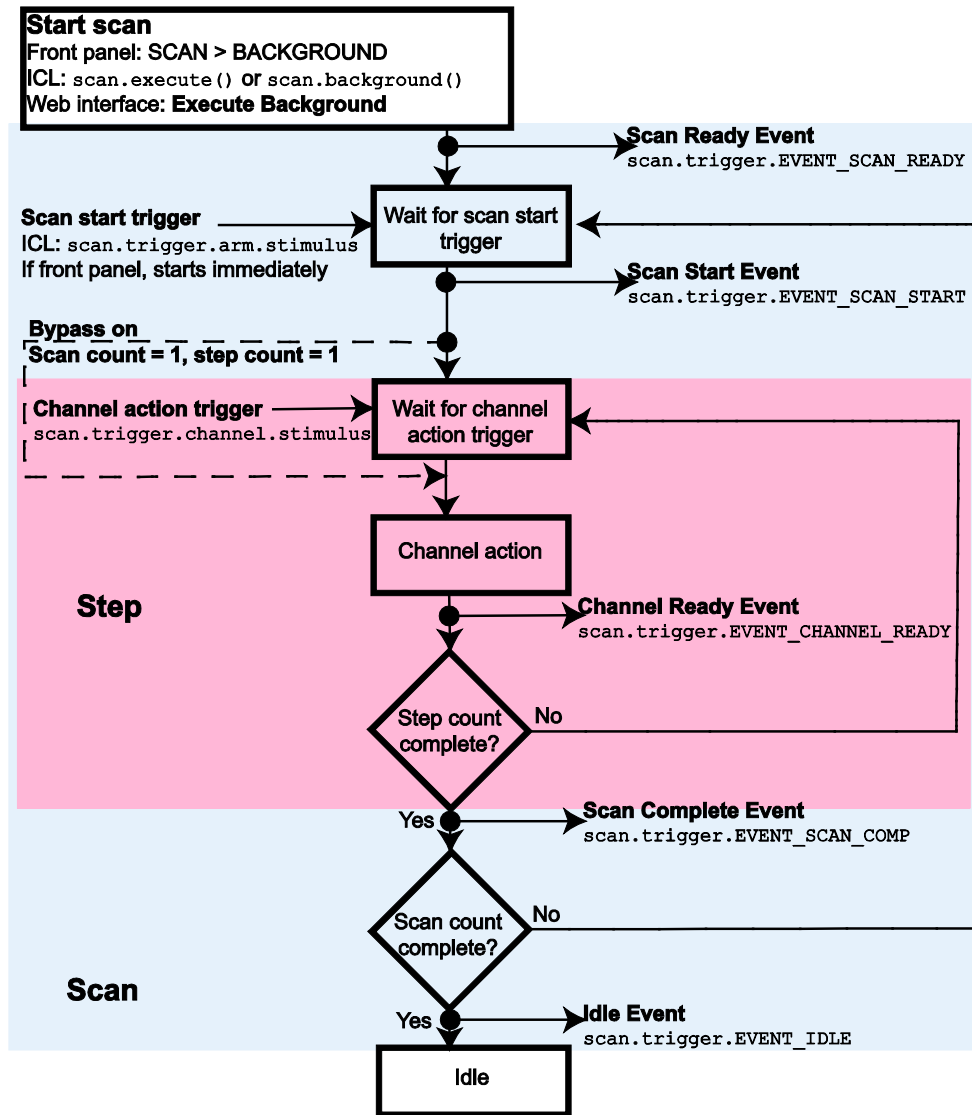

## Trigger model components

The individual components of the trigger model are explained in the following paragraphs.

### Start scan

When a scan is initiated, the instrument leaves the idle state and prepares to start scanning. To prepare for scanning, it verifies that channel settings match the scan settings (such as opening all channels or opening only channels on specific slot). After preparation is complete, the instrument generates the Scan Ready Event and either starts immediately or waits for the arm stimulus event.

When the scan is complete, the instrument returns to the idle state.

### Wait for scan start trigger

The scan can start immediately after receiving the Scan Ready Event, or the instrument can wait for a start trigger (also called the arm action). If it waits for a start trigger, the scan does not start until it receives the start trigger.

When the scan starts, the instrument generates the Scan Start Event.

### Wait for channel action trigger

The channel action trigger is an event that tells the instrument to begin processing the next channel action.

You can bypass the channel action trigger if this is the first step of the first scan count. Bypass is available from the front-panel **CONFIG+SCAN** menu, or by using the command `scan.bypass`.

### Channel action

During the channel action, the instrument opens or closes channels as needed.

When the channel actions are complete, the instrument generates the Channel Ready Event.

### Step count complete

The trigger model repeats these actions for every step in the scan list. The instrument loops back to wait for channel action trigger for each step until the steps are complete.

When all the steps are complete, the instrument generates the Scan Complete Event.

### Scan count complete

The scan can be set to repeat. If the scan count is not complete, the instrument loops back to wait for the scan start trigger.

### Idle

After the instrument has completed the scan list the requested number of times, the instrument generates the Idle Event. This is the completion of the scan.

## Trigger model events and associated commands

The Models 707B and 708B trigger model has the following events and associated command attributes. These events, along with other events in the system, may be used to configure various stimulus settings.



For example, the channel ready event (`scan.trigger.EVENT_CHANNEL_READY`) may be set to pulse digital I/O line 3 when it gets generated. The command message for this would be:

```
digio.trigger[3].stimulus = scan.trigger.EVENT_CHANNEL_READY
```

Likewise, you can use the digital I/O line 5 trigger event to satisfy the scan trigger channel stimulus, which causes the channel action to occur when a trigger is detected on line 5. The command message for this is:

```
scan.trigger.channel.stimulus = digio.trigger[5].EVENT_ID
```

Event	Associated attribute
Scan Ready Event	<code>scan.trigger.EVENT_SCAN_READY</code>
Scan Start Event	<code>scan.trigger.EVENT_SCAN_START</code>
Channel Ready Event	<code>scan.trigger.EVENT_CHANNEL_READY</code>
Scan Complete Event	<code>scan.trigger.EVENT_SCAN_COMP</code>
Idle Event	<code>scan.trigger.EVENT_IDLE</code>

## NOTE

Scanning operations run through the trigger model, but individual open and close commands have no interaction with the trigger model.

## Scan and step counts

When running a scan, it may be necessary to determine the scan progress. You can use `scan.state()` to read the scan and step count to determine the point in the scan table being executed.

"Scan count" represents the number of the current iteration through the scan portion of the trigger model. This number does not increment until after the scan begins. Therefore, if an instrument is waiting for an input to trigger a scan start, the scan count represents the previous number of scan iterations. If no scan has yet to begin, the scan count is zero.

"Step count" represents the number of times the scan has completed a pass through the channel action portion of the trigger model. This number does not increment until after the action completes. Therefore, if the instrument is waiting for an input to trigger a channel action, the step count represents the previous step. If no step has yet to complete, the step count is zero. If the step count has yet to complete the first step in a subsequent pass through a scan, the scan count represents the last step in the previous scan pass.

## Basic scan procedure

### NOTE

It is always better to configure all channel attributes before creating a scan. You cannot use an external trigger event, like digital I/O, for the channel stimulus setting of the trigger model when using the front panel **STEP** key. For more information, see Scanning and [Trigger model](#) (on page 3-1).

#### To perform a scan:

1. Configure the channels for scanning as needed.
2. Build the scan list:
  - **Front panel:** Press the **INS** key. The steps are executed in the order in which they are added.
  - **Remote interface:** Send the `scan.create()`, `scan.add()`, or `scan.addimagestep()` command.
3. Configure the scan settings (for example, scan count, bypass, mode, and so on).
4. To start the scan:
  - **Front panel:** Press the **STEP** key or the **SCAN** key and select the **BACKGROUND** menu item.
  - **Remote interface:** Send the command `scan.execute` or `scan.background`.
5. The trigger model leaves the idle state and performs actions on the channels involved in scanning.
  - **Front panel:** When you press the **STEP** key, the Models 707B and 708B leave the idle state and perform the channel action associated with the first step in the scan list.

### NOTE

While scanning is enabled, pressing most front panel keys will cause the instrument to display error code 5522, "Scan Running, Must Abort Scan."

6. The channels are scanned or stepped in the order they were added to the list.
  - **Front panel:** If you are stepping through the scan, press the **STEP** key to proceed to the next step in the list.
  - **Remote interface:** You cannot step a scan remotely over the bus.
7. To abort the scan:
  - **Front panel:** Press the **EXIT** key.
  - **Remote interface:** Use the `scan.abort()` ICL command.

### NOTE

Even if the scan is aborted, channel states match the aborted state of channels in terms of which are closed and opened.

If configured to scan the channels in the scan list again, the Model 707B or 708B waits at the control source for another trigger event. After the scan is complete, the Model 707B or 708B outputs another trigger pulse, if configured to do so. After all requested scans are complete, the instrument returns to the idle state with the channels associated with last scan step closed.

## Changing attributes of an existing scan

When a scan already exists, changing channel attributes also causes the scan to change. Once a scan list has been defined, the Model 707B or 708B tries to incorporate your changes into the scan. If the change impacts the ability of the scan to function properly (such as deleting something referenced by the scan), an error message is logged and the scan list may be cleared.

To see how the scan list may have changed, view the current scan list:

1. Press the **SCAN** key when on the main display.
2. Select the **LIST** option and press the **ENTER** key.
3. Use the navigation wheel or **CURSOR** keys to scroll through the list.

For remote operation, use the `scan.list()` function.

You can clear an existing scan list before making any changes after making a scan list. From the front panel, press the **SCAN** key and select the **CLEAR** option. For bus operation, use the `scan.create()` function.

*To configure a scan from the SCAN ATTR MENU, while in an active scan list:*

1. Press the **CONFIG** key.
2. Press the **SCAN** key. Modify any of the following menu items as desired:
  - **ADD**: Displays **Use INS** key. The related command is `scan.add`.
  - **BYPASS**: Enables (ON) or disables (OFF) bypassing the first step of the first scan pass. Related command: [scan.bypass](#) (on page 7-140).
  - **MODE**: Sets the scan mode value to one of the following:
    - OPEN\_ALL (default setting)
    - OPEN\_SELECT
  - Related command: [scan.mode](#) (on page 7-145).
3. Press the **EXIT** key to leave the menu.

## Front-panel scanning

After channels have been added to the scan list, press the **SCAN** key to display the SCAN ACTION MENU. If no scan list exists, pressing the **SCAN** key will briefly display "No Scan List. Use INSERT to add selection."

The menu contains the following items:

- **BACKGROUND:** Runs scan list in the background
- **CREATE:** Displays **Use INS key**
- **LIST:** Displays the current scan list steps. Turn the navigation wheel to scroll through the list.
- **CLEAR:** Clears the existing scan list.
- **RESET:** Resets the unit's scan settings, which include scan count, clearing the scan list, and scan stimulus settings like scan trigger arm.

Press the **INS** key to add the selected channels or pattern to the existing scan list.

Press the **DEL** key to remove the selected channels or pattern from the existing scan list. Only the first occurrence of the selected item is removed.

When removing channels, channel patterns are not checked to determine if the channel being removed is associated with its image. To remove a channel pattern in a scan list, select the channel pattern to be removed, and then press the **DEL** key.

Press the **STEP** key to single step through a scan list.

## Foreground and background scan execution

You can execute a scan in the foreground or background. Background execution allows you to query settings. If a scan is running in the foreground, it will need to finish or be aborted before you can query any settings.

When a scan is running in the background, you can send commands to be processed. The commands that you can use include most of the command messages that you use to query for settings, for example:

```
print(scan.state())
```

Most of the commands to change how the instrument is configured will log the following error message to the error queue:

```
5522, Scan Running, Must Abort Scan
```

## Include multiple channels in a single scan step

Through the remote control interface, you can use `scan.addimagestep` to combine a list of channels into a scan step.

The following example creates five scan steps with the indicated channels.

```
scan.create()  
scan.addimagestep("1A01, 1B01, 1C03")  
scan.sddimagestep("1A03, 1B03, 1C03")  
scan.addimagestep("1A05, 1B05, 1C03")  
scan.sddimagestep("1A07, 1B07, 1C03")  
scan.addimagestep("1A09, 1B09, 1C03")
```

## Remote interface scanning

### Scan and trigger commands

The following list contains commands associated with triggers and bus operation scanning:

- [trigger.blender\[N\].clear\(\)](#) (on page 7-201)
- [trigger.blender\[N\].orenable](#) (on page 7-202)
- [trigger.blender\[N\].overrun](#) (on page 7-203)
- [digio.trigger\[N\].clear\(\)](#) (on page 7-54)
- [digio.trigger\[N\].pulsewidth](#) (on page 7-57)
- [digio.trigger\[N\].stimulus](#) (on page 7-59)
- [digio.trigger\[N\].wait\(\)](#) (on page 7-61)
- [lan.trigger\[N\].assert\(\)](#) (on page 7-108)
- [lan.trigger\[N\].clear\(\)](#) (on page 7-108)
- [lan.trigger\[N\].overrun](#) (on page 7-113)
- [lan.trigger\[N\].stimulus](#) (on page 7-115)
- [lan.trigger\[N\].wait\(\)](#) (on page 7-117)
- [scan.add\(\)](#) (on page 7-136)
- [scan.background\(\)](#) (on page 7-139)
- [scan.bypass](#) (on page 7-140)
- [scan.create\(\)](#) (on page 7-141)
- [scan.execute\(\)](#) (on page 7-142)
- [scan.list\(\)](#) (on page 7-143)
- [scan.mode](#) (on page 7-145)
- [scan.reset\(\)](#) (on page 7-146)
- [scan.scancount](#) (on page 7-147)
- [scan.state\(\)](#) (on page 7-148)
- [scan.stepcount](#) (on page 7-149)
- [scan.trigger.arm.clear\(\)](#) (on page 7-149)
- [scan.trigger.arm.set\(\)](#) (on page 7-150)
- [scan.trigger.arm.stimulus](#) (on page 7-150)
- [scan.trigger.channel.clear\(\)](#) (on page 7-152)
- [scan.trigger.channel.set\(\)](#) (on page 7-152)
- [scan.trigger.channel.stimulus](#) (on page 7-153)
- [scan.trigger.clear\(\)](#) (on page 7-155)

## Scanning examples

Assume you have a 7072 card installed in slot 1 of your instrument and you want to scan column 5 on rows 1 to 3. To create this scan, send the following command:

```
scan.create("1A05, 1B05, 1C05")
```

To see the scan list generated from this command, send:

```
print(scan.list())
```

The following will be output:

```
Init) OPEN...
  1) STEP: 1A05
     CLOSE: 1A05
  2) STEP: 1B05
     OPEN: 1A05
     CLOSE: 1B05
  3) STEP: 1C05
     OPEN: 1B05
     CLOSE: 1C05
```

This indicates that the scan list includes three steps. For step 1, the running scan will close "1A05". For step 2, it opens "1A05" and closes "1B05". For step 3, it will open "1B05" and close "1C05".

The following table illustrates how scan count works with this scan list to determine total number of channel closures during a scan.

### How scan count works with the scan list

Number of steps	Scan count value	Total number of step channel closures
3	1 (default)	3 (each step channel once – 1A05, 1B05, 1C05)
3	2	6 (each step channel twice – 1A05, 1B05, 1C05, then 1A05, 1B05, 1C05)
3	3	9 (each step channel three times – 1A05, 1B05, 1C05 then 1A05, 1B05, 1C05 then 1A05, 1B05, 1C05)
<code>scan.stepcount</code>	<code>scan.scancount</code>	<code>scan.stepcount X scan.scancount</code>

Therefore, scan count represents how many times to loop on the total number of steps in a defined scan list.

If you want to pace the steps of closing and opening channels by detecting a trigger on digio trigger line 3, the following flow chart indicates the sequence of events to achieve this. This example uses the same scan list as above and uses a scan count of 3.

As the flow chart below shows, to transition between start of scan to step 1, step 1 and step 2, step 2 and step 3, a trigger needs to be detected on digio trigger line 3. At the end of step 3, if the scan count has reached three, the scan completes. If the scan count hasn't reached 3 then, loop back around to repeat steps 1 to 3 again.

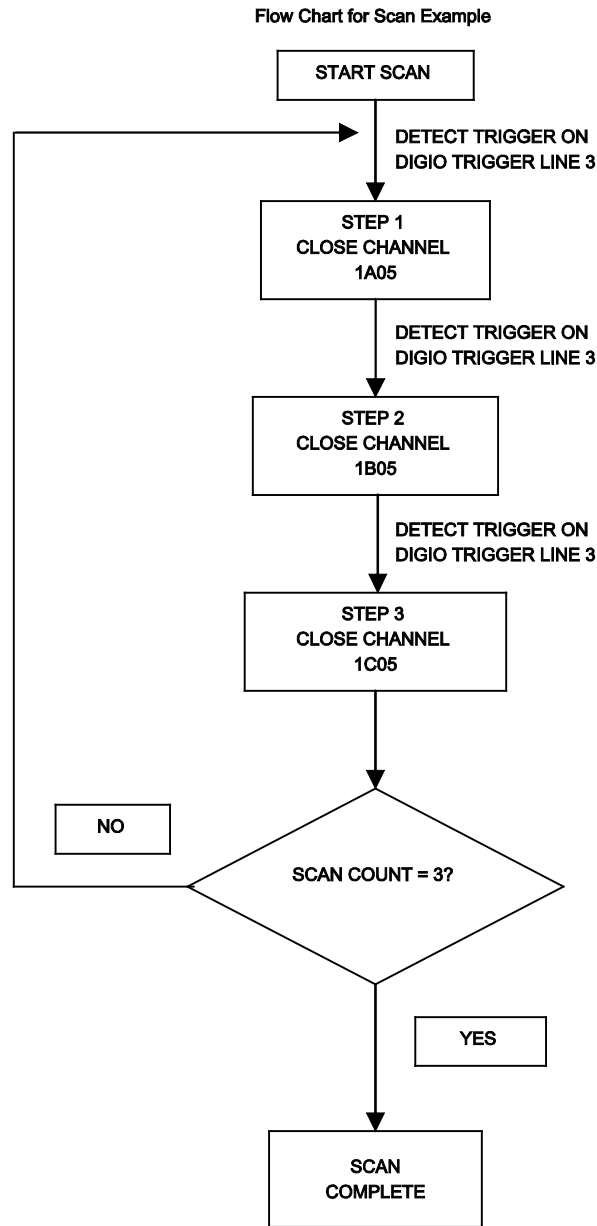

The following represents a script you can enter using the TSB Embedded page on the web to experiment with the scan points discussed above.

<code>reset()</code>	Reset the instrument
<code>scan.add("1A05, 1B05, 1C05")</code>	Create a three channel scan list
<code>digio.trigger[3].mode = digio.TRIG_FALLING</code>	Detect falling edges on digio trigger line 3
<code>scan.trigger.channel.stimulus = digio.trigger[3].EVENT_ID</code>	Configure digio trigger line 3 to pace the scan sequence
<code>scan.scancount = 3</code>	Set the scan count to 3
<code>print(scan.list())</code>	Show the configured scan list
<code>delay(5)</code>	Delay 5 seconds to allow viewing of scan list
<code>scan.background()</code>	Start the scan and let it run in the background
<code>ScanState, ScanCount, StepCount = scan.state()</code>	Get the current scan state information
<code>print(ScanState, "", ScanCount, "", StepCount)</code>	Show the state of scanning
<code>delay(3)</code>	Delay 3 seconds to allow viewing of state
<code>print("state", " scan count", "step count")</code>	Header for output data from for loop
<code>for x = 1, (scan.scancount * scan.stepcount) do</code>	Loop for scan count times step count to step the scan sequence
<code>digio.trigger[3].assert()</code>	Simulate the trigger occurring on digio trigger line 3
<code>ScanState, ScanCount, StepCount = scan.state()</code>	Get the current scan state information
<code>print(ScanState, "", ScanCount, "", StepCount)</code>	Show the state of scanning
<code>delay(3)</code>	Delay 3 seconds to allow viewing of state
<code>end</code>	

On the TSB Embedded page, click **Save Script** to save the script. For example, name the script ScanExample. In the User Scripts list, select ScanExample. Click **Run**. The output of the script is:



Init) OPEN...			
1) STEP: 1A05 CLOSE: 1A05			
2) STEP: 1B05 OPEN: 1A05 CLOSE: 1B05			
3) STEP: 1C05 OPEN: 1B05 CLOSE: 1C05			
2.000000000e+000	1.000000000e+000	0.000000000e+000	Shows scan is running (state = 2) and no steps have completed for scan count of 1
state	scan count	step count	
2.000000000e+000	1.000000000e+000	1.000000000e+000	Shows scan is running (state = 2) and just completed step 1 for scan count of 1
2.000000000e+000	1.000000000e+000	2.000000000e+000	Shows scan is running (state = 2) and just completed step 2 for scan count of 1
2.000000000e+000	1.000000000e+000	3.000000000e+000	Shows scan is running (state = 2) and just completed step 3 for scan count of 1
2.000000000e+000	2.000000000e+000	1.000000000e+000	Shows scan is running (state = 2) and just completed step 1 for scan count of 2
2.000000000e+000	2.000000000e+000	2.000000000e+000	Shows scan is running (state = 2) and just completed step 2 for scan count of 2
2.000000000e+000	2.000000000e+000	3.000000000e+000	Shows scan is running (state = 2) and just completed step 3 for scan count of 2
2.000000000e+000	3.000000000e+000	1.000000000e+000	Shows scan is running (state = 2) and just completed step 1 for scan count of 3
2.000000000e+000	3.000000000e+000	2.000000000e+000	Shows scan is running (state = 2) and just completed step 2 for scan count of 3
6.000000000e+000	3.000000000e+000	3.000000000e+000	Shows scan has completed (state = 6) and just completed step 3 for scan count of 3

**NOTE**

For more examples of using scanning and triggering, see the Models 707B and 708B User's Manual, section "Using a Series 2600 with your Model 707B or 708B."

**Hardware trigger modes**

Use the hardware trigger modes to integrate Keithley Instruments and non-Keithley instruments into an efficient test system. The hardware synchronization lines are classic trigger lines. The Model 707B or 708B contains 14 digital I/O lines and three TSP-Link synchronization lines that you can use for input or output triggering. The following table provides a summary for each hardware trigger mode.

Trigger mode	Output		Input	Notes
	Unasserted	Asserted	Detects	
Bypass	N/A	N/A	N/A	Use the <code>writebit</code> and <code>writeport</code> commands for direct line control
Either edge	High	Low	Either	Short input pulses can cause a trigger overrun
Falling edge	High	Low	Falling	
Rising edge	N/A	N/A	N/A	<ul style="list-style-type: none"> <li>The programmed state of the line determines if the behavior is similar to <code>RisingA</code> or <code>RisingM</code></li> <li>High similar to <code>RisingA</code></li> <li>Low similar to <code>RisingM</code></li> </ul>
Rising A	High	Low	Rising	
RisingM	Low	High	None	
Synchronous	High latching	Low	Falling	<ul style="list-style-type: none"> <li>Behaves similar to <code>SynchronousA</code></li> <li>Trigger overrun detection is disabled</li> <li>To mirror the <code>SynchronousA</code> trigger mode, set the pulse duration to 1 <math>\mu</math>s or any small nonzero value</li> </ul>
SynchronousA	High latching	High	Falling	Ignores the pulse duration
SynchronousM	High	Low	Rising	

Each trigger mode controls the input trigger detection and output trigger generation. The input detector monitors for and detects all edges, even if the node that generates the output trigger causes the edge.

A trigger overrun generates if an input trigger is received before the previous input trigger processes. To determine if a trigger overrun has occurred, reference the trigger overrun attributes.

For additional information on the hardware trigger modes, see TSP commands.

**NOTE**

To have direct control of the line state, use the bypass trigger mode.

## Falling edge trigger mode

The falling edge trigger mode generates low pulses and detects all falling edges. The following graphic illustrates the characteristics for the falling edge input trigger.

**Figure 63: Falling edge input trigger**

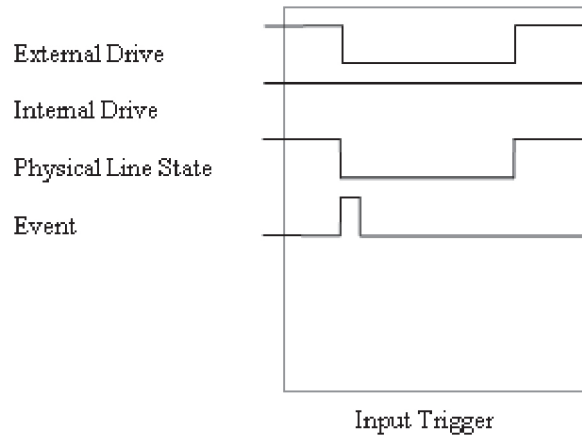

### Input characteristics:

- Detects all falling edges as input triggers

**Figure 64: Falling edge output trigger**

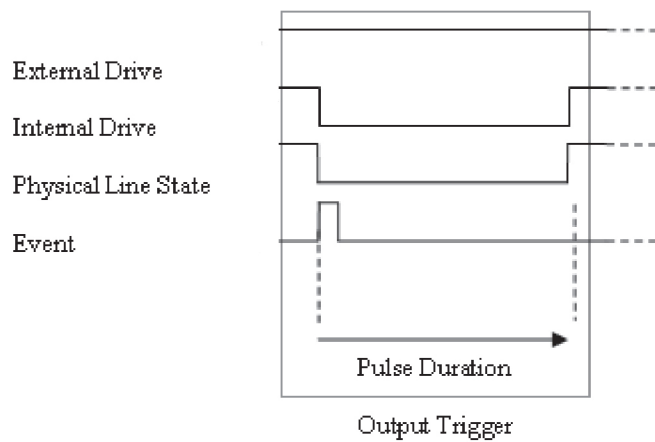

### Output characteristics:

- When the trigger is asserted, it generates a low pulse for the programmed pulse duration.

### Rising edge master trigger mode

Use the rising edge master trigger mode (RisingM) to synchronize with non-Keithley Instruments that require a high pulse. Input trigger detection is not available in this trigger mode. You can use the RisingM trigger mode to generate rising edge pulses.

NOTE

The RisingM trigger mode does not function properly if the line is driven low by an external drive.

**Figure 65: RisingM output trigger**

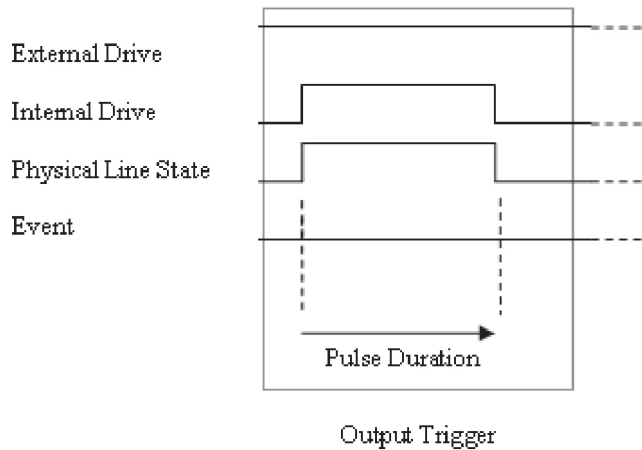

### Rising edge acceptor trigger mode

The rising edge acceptor trigger mode (RisingA) generates a low pulse and detects rising edge pulses. The following graphic displays the RisingA input trigger.

**Figure 66: RisingA input trigger**

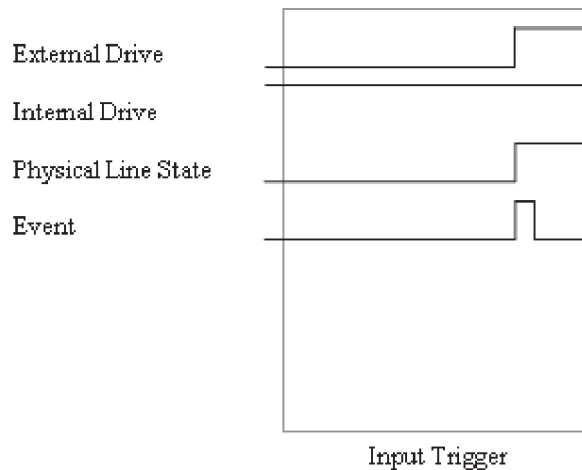

**Input characteristics:**

- All rising edges generate an input event.

**Figure 67: RisingA output trigger**

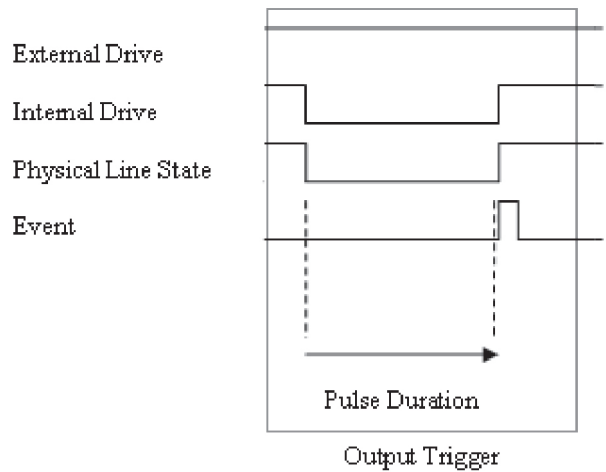

**Output characteristics:**

- When the trigger is asserted, generates a low pulse that is similar to the falling edge trigger mode.

**Either edge trigger mode**

The either edge trigger mode generates a low pulse and detects both rising and falling edges.

**Figure 68: Either edge input trigger**

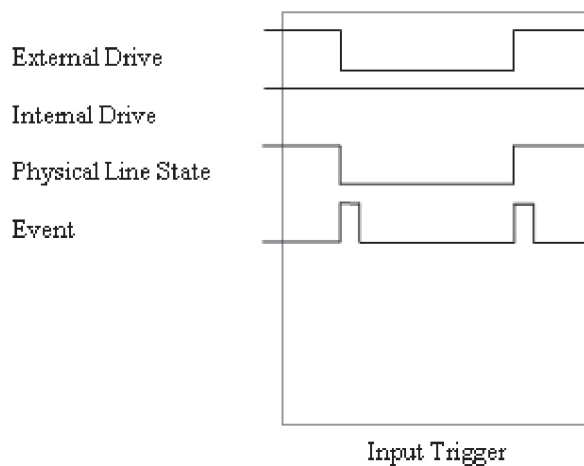

**Input characteristics:**

- All rising or falling edges generate an input trigger event

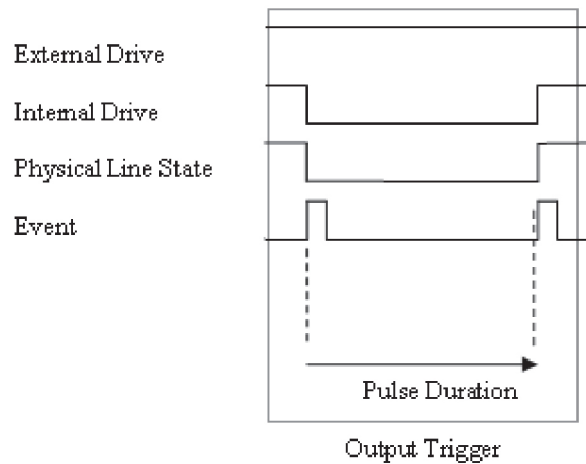
**Figure 69: Either edge output trigger****Output characteristics:**

- When the trigger is asserted, it generates a low pulse that is similar to the falling edge trigger mode.

## Understanding synchronous triggering modes

Use the synchronous triggering modes to implement bidirectional triggering, to wait for one node, or to wait for a collection of nodes to complete all triggered actions.

All non-Keithley instrumentation must have a trigger mode that functions similar to the SynchronousA or SynchronousM trigger modes.

To use synchronous triggering, configure the triggering master to the SynchronousM trigger mode or the non-Keithley equivalent. Configure all other nodes in the test system to SynchronousA trigger mode or a non-Keithley equivalent.

### Synchronous master trigger mode

Use the synchronous master trigger mode (SynchronousM) to generate falling edge output triggers, to detect the rising edge input triggers, and to initiate an action on one or more external nodes with the same trigger line.

In this mode, the output trigger consists of a low pulse. All non-Keithley instruments attached to the synchronization line in a trigger mode equivalent to SynchronousA must latch the line low during the pulse duration.

To use the SynchronousM trigger mode, configure the triggering master as SynchronousM and then configure all other nodes in the test system as Synchronous, SynchronousA, or to the non-Keithley equivalent.

## NOTE

Use the SynchronousM trigger mode to receive notification when the triggered action on all nodes is complete.

**Figure 70: SynchronousM input trigger**

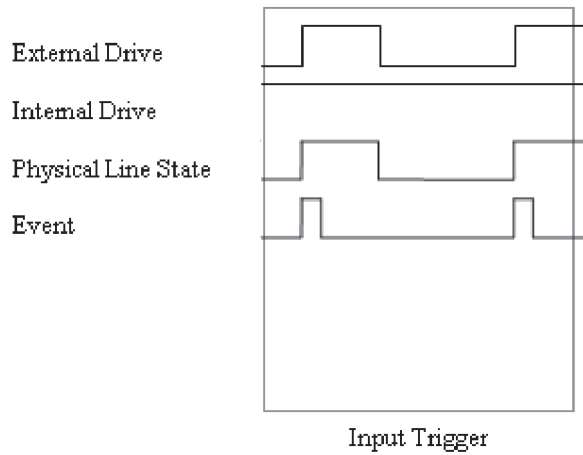

**Input characteristics:**

- All rising edges are input triggers.
- When all external drives release the physical line, the rising edge is detected as an input trigger.
- A rising edge cannot be detected until all external drives release the line and the line floats high.

**Figure 71: SynchronousM output trigger**

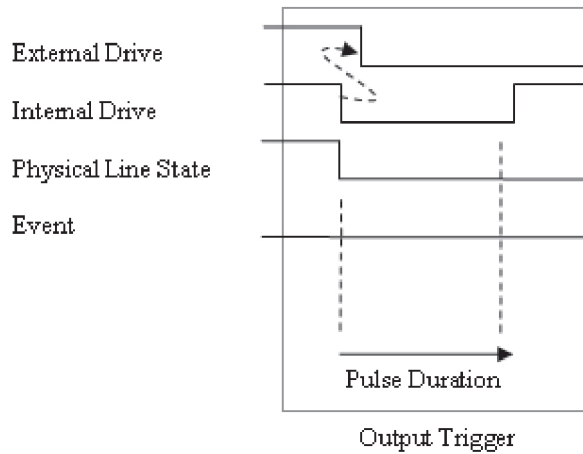

**Output characteristics:**

- When the trigger is asserted, it generates a low pulse that is similar to the Falling Edge trigger mode

## Synchronous acceptor trigger mode

Use the synchronous acceptor trigger mode (SynchronousA) with the SynchronousM trigger mode. The roles of the internal and external drives are reversed in the SynchronousA trigger mode.

**Figure 72: SynchronousA input trigger**

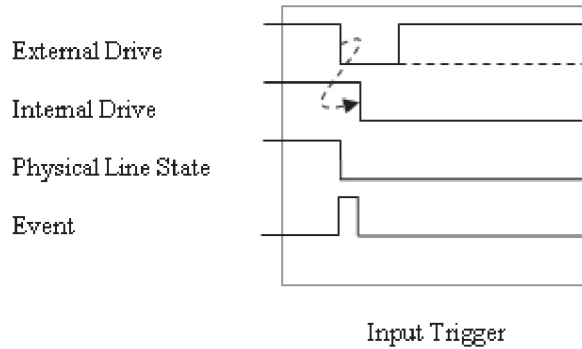

### Input characteristics:

- The falling edge is detected as the external drive pulses the line low, and the internal drive latches the line low

**Figure 73: SynchronousA output trigger**

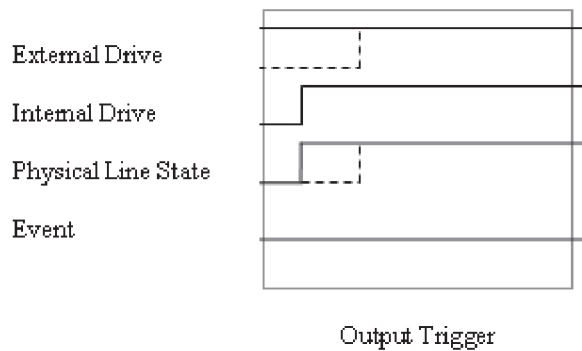

### Output characteristics:

- The physical line state does not change until all drives (internal and external) release the line.

## Synchronous trigger mode

The synchronous trigger mode is a combination of SynchronousA and SynchronousM trigger modes. The SynchronousA and SynchronousM trigger modes provide additional flexibility.



**Figure 74: Synchronous input trigger**

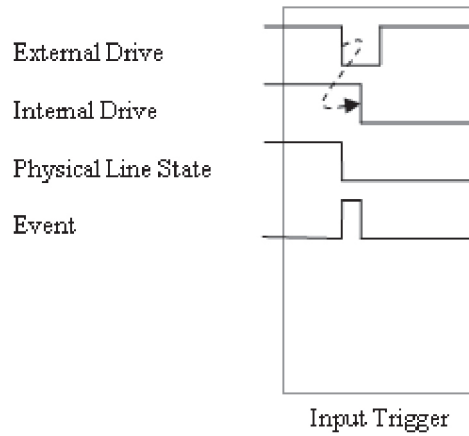

**Input characteristics:**

- The falling edge generates an input event and latches the internal drive low.

**Figure 75: Synchronous output trigger**

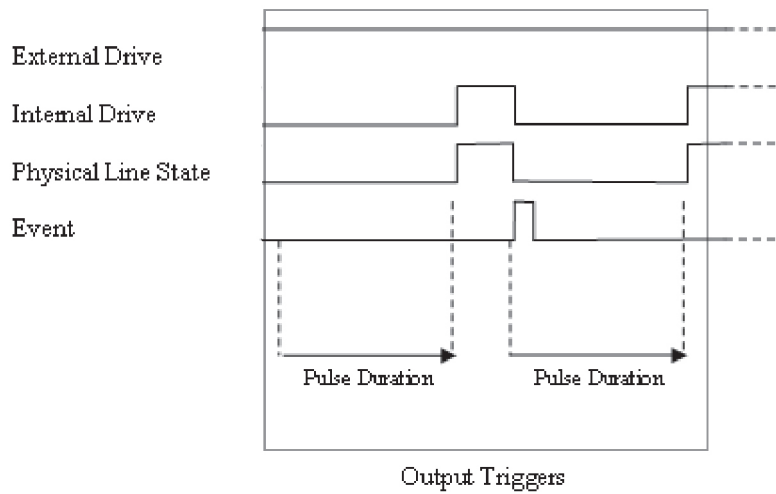

**Output characteristics:**

- When the trigger is asserted, it generates a low pulse for the programmed pulse duration. If the line is latched low, a falling edge does not occur.
- When the trigger is asserted and the line is latched low, the pulse duration is enforced, and then the internal line drive is released.
- A normal falling edge pulse generates when the internal drive is not latched low and the trigger is asserted.

## Events

Event detectors monitor an event. They have one input signal (the stimulus), which is the event that they monitor (in some cases, the stimulus is an action in the system, like a timer expiring or a key press). They have two optional output signals (see figure below). "Detected" reflects the detection state of the event detector. If an event was detected, the detected signal is asserted. Event detectors are usually coupled to something that consumes the events. When an event is consumed, the detected state of the event detector is reset. Should an event be detected while the event detector is in the detected state, the overrun signal will be asserted. You can only clear the overrun signal by sending a TSP command.

**Figure 76: Event detector**

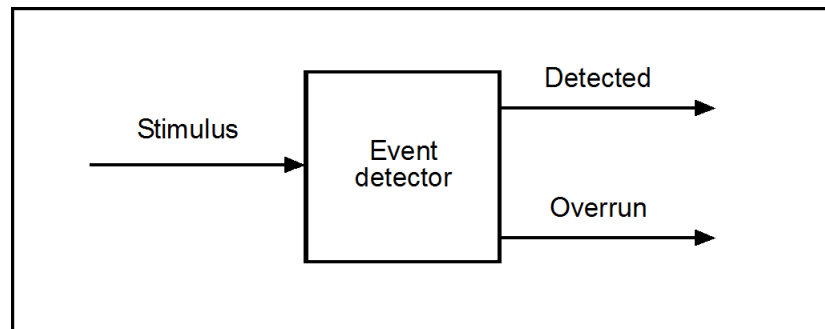

## Event blenders

Advanced event handling requires a way to wait for one of several events (or all of several events). An event blender provides for this combining or blending of events. An event blender can combine up to four events in either an "or" mode or an "and" mode. When in "or" mode, any one of the input events will cause an output event to be generated. When in "and" mode, all the input events must occur before an output event is generated.

When operating in "and" mode, if an event is detected more than once before all events necessary for the generation of an output event, an action overrun will be generated. When operating in "or" mode, an action overrun will be generated when two or more source events are detected simultaneously.

Event blenders each have an associated event detector that can be accessed through script control. Event blenders can only be accessed over a remote interface (no front panel control is available). The following remote commands provide additional information on available blenders:

- [trigger.blender\[N\].clear\(\)](#) (on page 7-201)
- [trigger.blender\[N\].orenable](#) (on page 7-202)
- [trigger.blender\[N\].overrun](#) (on page 7-203)
- [trigger.blender\[N\].stimulus\[M\]](#) (on page 7-204)
- [trigger.blender\[N\].wait\(\)](#) (on page 7-205)



# Theory of operation

**In this section:**

Theory of operation ..... 4-1

## Theory of operation

### Models 707B and 708B theory of operations overview

The Models 707B and 708B are composed of several components assembled into an aluminum frame. The Model 707B supports the operation of up to six relay matrix cards; the Model 708B supports the operation of a single relay matrix card. Each of the components is briefly described below.

### Mainframe

Figure 77: Model 707B mainframe block diagram

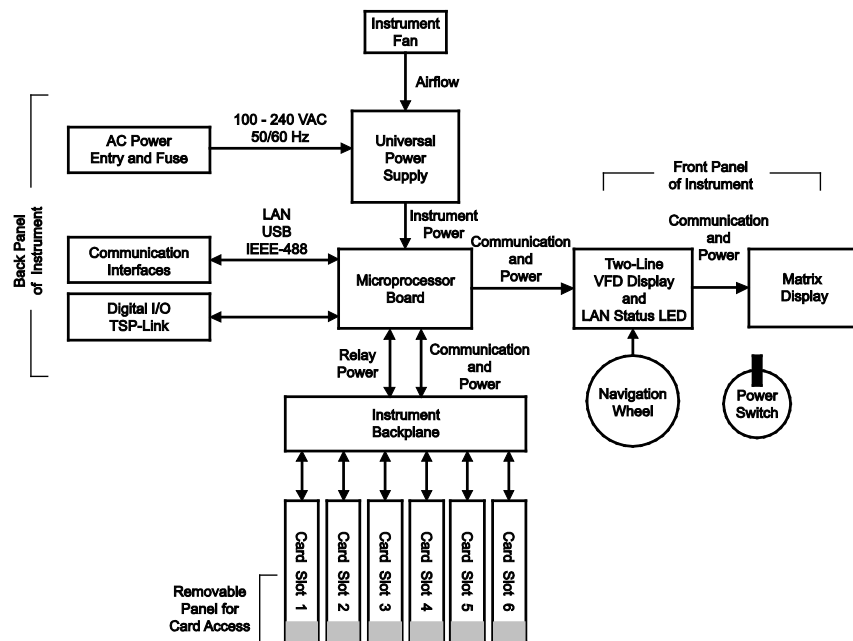
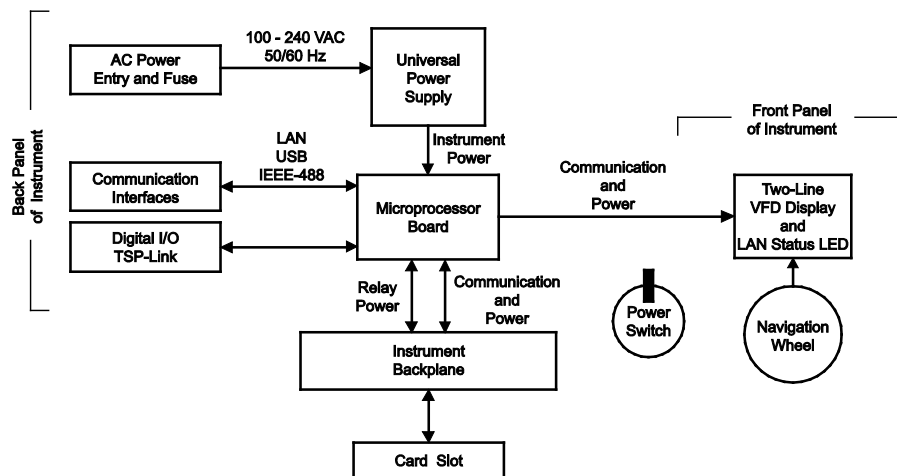

Figure 78: Model 708B mainframe block diagram



### Important test system safety information

This product is sold as a stand-alone instrument that may become part of a system that could contain hazardous voltages and energy sources. It is the responsibility of the test system designer, integrator, installer, maintenance personnel, and service personnel to make sure the system is safe during use and is operating properly.

You must also realize that in many test systems a single fault, such as a software error, may output hazardous signal levels even when the system indicates that there is no hazard present.

It is important that you consider the following factors in your system design and use:

- The international safety standard IEC 61010-1 defines voltages as hazardous if they exceed 30 V rms and 42.4 V peak or 60 V dc for equipment rated for dry locations. Keithley Instruments, Inc. products are only rated for dry locations.
- Read and comply with the specifications of all instruments in the system. The overall allowed signal levels may be constrained by the lowest rated instrument in the system. For example, if you are using a 500 volt power supply with a 300 V dc rated switch, the maximum allowed voltage in the system is only 300 V dc.
- Make sure any test fixture connected to the system protects the operator from contact with hazardous voltages, hot surfaces, or sharp objects. This may be accomplished by shields, barriers, insulation, safety interlocks, or the like.
- Cover the device under test (DUT) to protect an operator from flying debris in the event of a system or DUT failure.

- Double insulate all electrical connections that an operator could touch. Double insulation ensures the operator is still protected even if one insulation layer fails. Refer to IEC 61010-1 for specific requirements.
- Make sure all connections are behind a locked cabinet door or other barrier. This protects the system operator from accidentally removing a connection by hand and exposing hazardous voltages.
- Use high reliability fail-safe interlock switches to disconnect power sources when a test fixture cover is opened.
- Where possible, use automatic handlers so operators are not required to access the DUT or other potentially hazardous areas.
- Provide training to all users of the system so they understand all potential hazards and know how to protect themselves from injury.
- In many systems, during power on, the outputs may be in an unknown state until they are properly initialized. Make sure the design can tolerate this situation without causing operator injury or hardware damage.

Of course, read and follow all safety warnings provided with the specific instruments to keep system users safe.

For Model 707B or 708B, also see [Safety Precautions](#) (on page 1-1).

---

### **Instrument fan (Model 707B only)**

---

The Model 707B includes an internal fan that operates continuously when power is applied to the mainframe. The fan keeps the internal power supply and other electronics cool during operation.

---

### **AC power entry**

---

The Model 707B or 708B is powered from standard AC mains supply through a power entry module that is located on the rear panel of the instrument.

---

### **Universal power supply**

---

All the power for the internal electronics and relay cards is provided by a switched-mode power supply which is located inside the mainframe. The power supply offers improved power efficiency compared to earlier versions of the Models 707A and 708A products.

Total power consumption requirements are listed on the rear panel of the instrument.

---

### **Microprocessor board**

---

At the heart of the Model 707B or 708B instrument is a microprocessor board that processes all communications. It outputs information and status messages, and executes operational commands supplied by the operator.

For information on the commands that can be sent to the instrument, see [Introduction to TSP operation](#) (on page 5-1, on page 5-1).

---

## Remote communications interfaces

---

You can operate the Model 707B or 708B over one of several standard remote interfaces. The rear panel includes connectors for these communication interfaces:

- Universal Serial Bus (USB)
- Local area network (LAN)
- General Purpose Interface Bus (GPIB or IEEE-488)

---

## Trigger and control interfaces

---

You can use rear panel connections to control external digital circuits and instruments that are connected with TSP. See [Digital I/O port](#) (on page 2-7) and [Connect the TSP-Link cable](#) (on page 2-6).

---

## Backplane

---

The Model 707B or 708B backplane is the interface between the installed relay cards. The relay card interfaces with the backplane through a communication and power connector a separate connector for signal routing.

Figure 79: Model 707B backplane

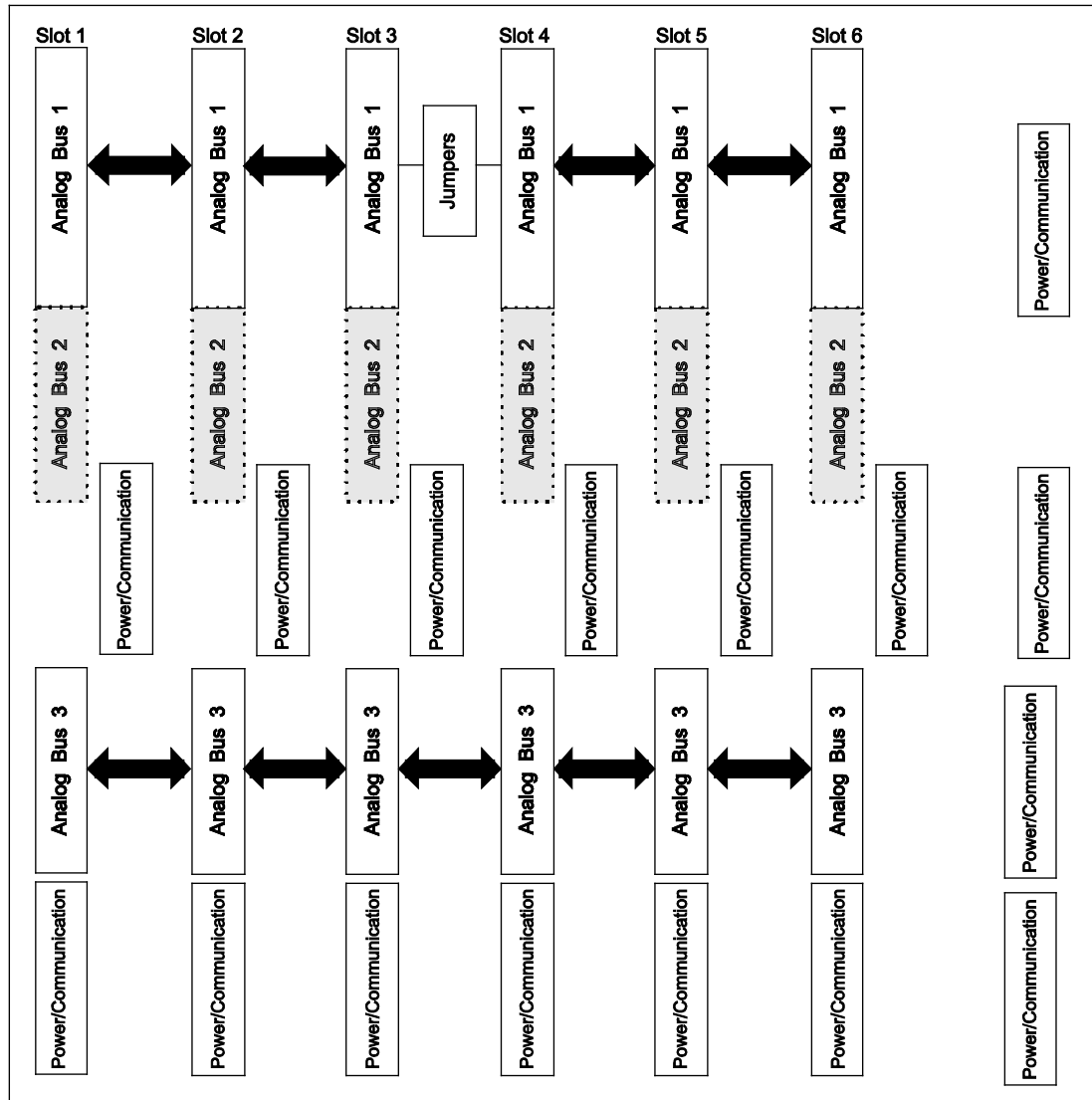

## Front panel

The front panel of the Keithley Instruments Model 707B or 708B contains the following items:

- The display
- The crosspoint display (Model 707B only)
- The keys and navigation wheel ☺
- The LAN status indicator
- The POWER button



You can use the keys, displays, and the navigation wheel ☺ to change the selected channel or channel pattern. You can also use them to access, view, and edit the menu items. The crosspoint display on the Model 707B shows you which channels are opened and closed.

The small display is a two-line vacuum fluorescent display (VFD).



## Upper crosspoint display (Model 707B only)

The larger upper display on the Model 707B mainframe provides a visual means of determining the relay status of each card slot in the instrument at any given time. It also shows the label names for each row and column of the given slot.

The crosspoint display may be operated from the navigation wheel  to scroll through the slots displaying the status. You can use the navigation wheel  to select channels for relay open or closures or other actions.

For details on indicators and additional options, see [Crosspoint display \(Model 707B only\)](#) (on page 2-14).

**Figure 80: Model 707B crosspoint display block diagram**

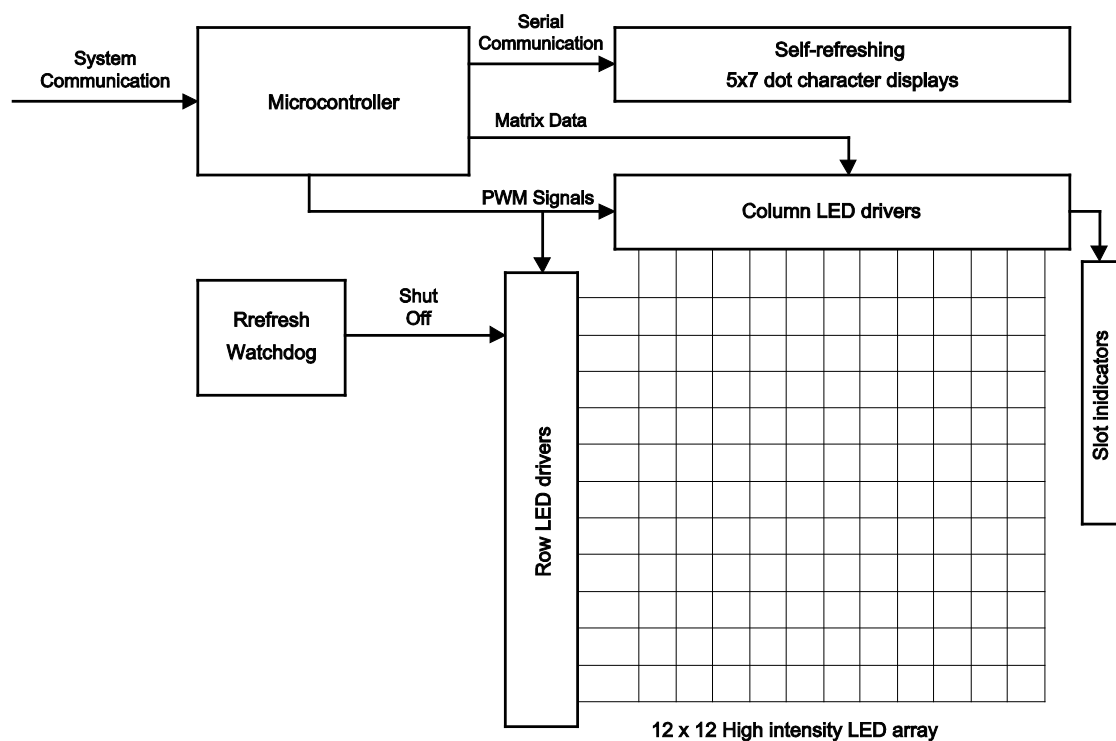

### Description of the crosspoint display components

The front panel of the Model 707B is composed of two main display components: a vacuum fluorescent display (VFD) and a 12 x 12 LED matrix display, called the crosspoint display, that shows the relay status for each of the slots.

The block diagram shows only the matrix display. Its constituent components are described below.

#### Microcontroller

The microcontroller receives commands from the main controller and updates the row and column labels. It also generates the pulse-width modulated (PWM) signals for operating the 12 x 12 LED matrix.

**Row and column labels**

The row and column labels are updated by writing to the devices serially. They handle their own brightness and refresh controls, alleviating the main microcontroller from performing these tasks. As a result, these are only updated when the data changes and a command from the instrument is issued to update the label.

**12 x 12 LED matrix**

The 12 x 12 matrix array of LEDs is driven by PWM signals that cause the intensity of the LED to be bright or dim based on the appropriate setting from the instrument.

Each row and column is updated sequentially. The entire display has a refresh rate of approximately 60 Hz. The time domain details of display refreshing are shown below.

**Figure 81: Model 707B display refresh**

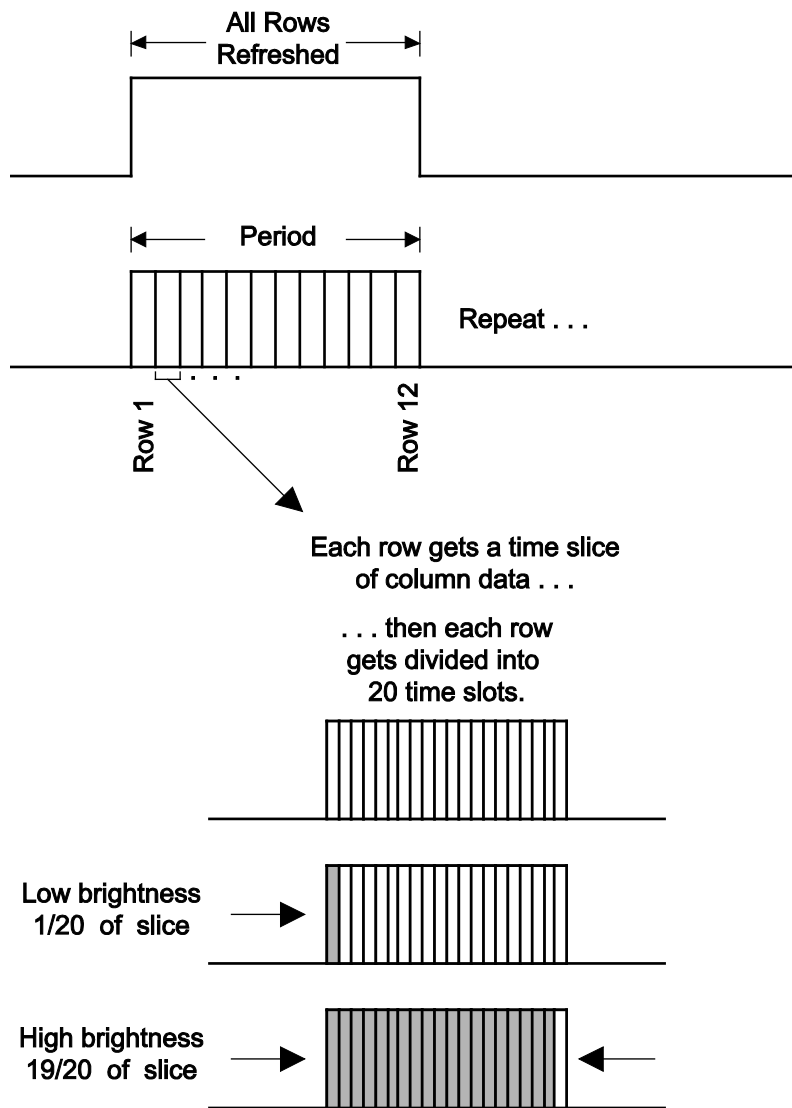

**Slot indicators**

The slot LEDs are treated the same as the matrix LEDs, as additional 13th and 14th columns.

**Display watchdog**

Once the display tasks are started, if the microcontroller stops refreshing, the watchdog circuit shuts off the column drivers to preserve the life of the LEDs.

The display watchdog is part of the standard display test (see [Testing the display, keys, and channel matrix](#) (on page 8-9) for information).

If the watchdog shuts down the display, the first several row labels show "SLOT GRID LEDS OFF."

**Description of basic display operation**

This display board is a subordinate device to the microprocessor board.

The microprocessor board communicates commands to change the state of the matrix or update the row and column labels.

The display board processes these commands independently. It also refreshes the display and performs other tasks. When a display command is issued, the microcontroller processes it to update the display. The task of refreshing rows and PWM generation is done in an interrupt-driven routine to ensure predictable timing.

---

# Introduction to TSP operation

### In this section:

---

Introduction to TSP operation.....	5-1
About TSP commands .....	5-3
Overview of instrument drivers.....	5-16
Migrating from Models 707A and 708A.....	5-19

## Introduction to TSP operation

Instruments that are Test Script Processor (TSP<sup>®</sup>) enabled operate like conventional instruments by responding to a sequence of commands sent by the controller. You can send individual commands to the TSP-enabled instrument the same way you would when using any other instrument.

Unlike conventional instruments, TSP-enabled instruments can execute automated test sequences independently, without an external controller. You can load a series of TSP commands into the instrument . You can store these commands as a script that can be run later by sending a single command message to the instrument.

You do not have to choose between using conventional control or script control. You can combine these forms of instrument control in the way that works best for your test application.

## Controlling the instrument by sending individual command messages

The simplest method of controlling an instrument through the communication interface is to send it a message that contains remote commands. You can use a test program that resides on a computer (the controller) to sequence the actions of the instrument.

TSP commands can be function-based or attribute-based. Function-based commands are commands that control actions or activities. Attribute-based commands define characteristics of an instrument feature or operation.

Constants are commands that represent fixed values.

### Functions

---

Function-based commands control actions or activities. A function-based command performs an immediate action on the instrument.

Each function consists of a function name followed by a set of parentheses ( ). You should only include information in the parentheses if the function takes a parameter. If the function takes one or more parameters, they are placed between the parentheses and separated by commas.

**Example 1**

```
beeper.beep(0.5, 2400)
delay(0.250)
beeper.beep(0.5, 2400)
```

Emit a double-beep at 2400 Hz. The sequence is 0.5 s on, 0.25 s off, 0.5 s on.

**Example 2**

You can use the results of a function-based command directly or assign variables to the results for later access. The following code defines `x` and prints it.

```
x = math.abs(-100)
print(x)
```

Output:  
100

**Attributes**

Attribute-based commands are commands that set the characteristics of an instrument feature or operation. For example, some characteristics of TSP-enabled instruments are the model number (`localnode.model`) and the brightness of the front-panel display (`display.lightstate`).

Attributes can be read-only, read-write, or write-only. They can be used as a parameter of a function or assigned to another variable.

To set the characteristics, attribute-based commands define a value. For many attributes, the value is in the form of a number or a predefined constant.

**Example 1: Set an attribute using a number**

```
beeper.enable = 0
```

This attribute controls the beeps that occur when front-panel controls are selected. Setting this attribute to 0 turns off the beeper.

**Example 2: Set an attribute using a constant**

```
format.data = format.REAL64
```

Using the constant `REAL64` sets the print format to double precision floating point format.

To read an attribute, you can use the attribute as the parameter of a function, or assign it to another variable.

**Example 3: Read an attribute using a function**

```
print(format.data)
```

Reads the data format by passing the attribute to the print function. If the data format is set to 3, the output is:  
3.0000000e+00  
This shows that the data format is set to double precision floating point.

**Example 4: Read an attribute using a variable**

```
fd = format.data
```

This reads the data format by assigning the attribute to a variable named `fd`.

## Queries

Test Script Processor (TSP<sup>®</sup>) enabled instruments do not have inherent query commands. Like any other scripting environment, the `print()` and `printnumber()` commands generate output in the form of response messages. Each `print()` command creates one response message.

### Example

```
x = 10
print(x)
```

Example of an output response message:

```
1.0000000e+01
```

Note that your output may be different if you set your ASCII precision setting to a different value.

## Data retrieval commands

You can send data retrieval commands that return a comma-delimited string. For example, `print(memory.available())` returns the amount of memory that is available in the instrument.

The comma-delimited string that is returned starts with the lowest channel and goes to the highest channel on Slot 1. It then lists each subsequent slot until the highest slot is reached.

## Information on scripting and programming

If you need information about using scripts with your TSP-enabled instrument, see [Fundamentals of scripting for TSP](#) (on page 6-1).

If you need information about using the Lua programming language with the instrument, see [Fundamentals of programming for TSP](#) (on page 6-10).

## About TSP commands

This section contains an overview of the TSP commands for the instrument. The commands are organized into groups, with a brief description of each group. Each section contains links to the detailed descriptions for each command in the TSP command reference section of this documentation (see TSP commands).

## Beeper control

The beeper commands allow you to enable or disable and sound the instrument beeper.

[beeper.beep\(\)](#) (on page 7-8)

[beeper.enable](#) (on page 7-8)

## Bit manipulation and logic operations

The bit functions perform bitwise logic operations on two given numbers, and bit operations on one given number. Logic and bit operations truncate the fractional part of given numbers to make them integers.

### Logic operations

The `bit.bitand()`, `bit.bitor()`, and `bit.bitxor()` functions in this group perform bitwise logic operations on two numbers. The Test Script Processor (TSP<sup>®</sup>) scripting engine performs the indicated logic operation on the binary equivalents of the two integers. This bitwise logic operation is performed on all corresponding bits of the two numbers. The result of a logic operation is returned as an integer.

### Bit operations

The rest of the functions in this group are used for operations on the bits of a given number. These functions can be used to:

- Clear a bit
- Toggle a bit
- Test a bit
- Set a bit or bit field
- Retrieve the weighted value of a bit or field value

All these functions use an index parameter to specify the bit position of the given number. The least significant bit of a given number has an index of 1, and the most significant bit has an index of 32.

## NOTE

The Test Script Processor (TSP) scripting engine stores all numbers internally as IEEE Std 754 double-precision floating point values. The logical operations work on 32-bit integers. Any fractional bits are truncated. For numbers larger than 4294967295, only the lower 32 bits are used.

[bit.bitand\(\)](#) (on page 7-9)

[bit.bitor\(\)](#) (on page 7-9)

[bit.bitxor\(\)](#) (on page 7-10)

[bit.clear\(\)](#) (on page 7-11)

[bit.get\(\)](#) (on page 7-11)

[bit.getfield\(\)](#) (on page 7-12)

[bit.set\(\)](#) (on page 7-13)

[bit.setfield\(\)](#) (on page 7-14)

[bit.test\(\)](#) (on page 7-14)

[bit.toggle\(\)](#) (on page 7-15)

## channel functions and attributes

## About channel commands

---

### Matrix card channel specifiers

The channels on the matrix cards are referred to by their slot, bank, row, and column numbers:

- **Slot number:** The number of the slot in which the card is installed.
- **Bank number:** The bank number, if used by your card. See your card documentation.
- **Row number:** The row number is either 1 to 8 or A to Z. See your card documentation.
- **Column number:** Always two digits. For columns greater than 99, use A, B, C and so on to represent 10, 11, 12, ...; the resulting sequence is: 98, 99, A0, A1, ..., A8, A9, B0, B1, ...

### Matrix channel examples

Specifier	Slot number	Bank number	Row number	Column number
1A05 or 1105*	1	N/A	1	05
1C05	1	N/A	3	05
3C12	3	N/A	3	12

\* Specifier depends on card type. See your card documentation for detail.



## Channel

Channel functions and attributes allow you to adjust, select, open, and close channels. You can also set common channel attributes and set up channel patterns.

The channel functions and attributes are:

[channel.clearforbidden\(\)](#) (on page 7-16)  
[channel.close\(\)](#) (on page 7-17)  
[channel.connectrule](#) (on page 7-18)  
[channel.connectsequential](#) (on page 7-19)  
[channel.createspecifier\(\)](#) (on page 7-20)  
[channel.exclusiveclose\(\)](#) (on page 7-22)  
[channel.exclusiveslotclose\(\)](#) (on page 7-23)  
[channel.getclose\(\)](#) (on page 7-24)  
[channel.getcount\(\)](#) (on page 7-25)  
[channel.getdelay\(\)](#) (on page 7-26)  
[channel.getforbidden\(\)](#) (on page 7-27)  
[channel.getlabel\(\)](#) (on page 7-28)  
[channel.getlabelcolumn\(\)](#) (on page 7-30)  
[channel.getlabelrow\(\)](#) (on page 7-31)  
[channel.getstate\(\)](#) (on page 7-32)  
[channel.gettype\(\)](#) (on page 7-33)  
[channel.open\(\)](#) (on page 7-33)  
[channel.pattern.catalog\(\)](#) (on page 7-35)  
[channel.pattern.delete\(\)](#) (on page 7-36)  
[channel.pattern.getimage\(\)](#) (on page 7-36)  
[channel.pattern.setimage\(\)](#) (on page 7-37)  
[channel.pattern.snapshot\(\)](#) (on page 7-39)  
[channel.reset\(\)](#) (on page 7-40)  
[channel.setdelay\(\)](#) (on page 7-41)  
[channel.setforbidden\(\)](#) (on page 7-42)  
[channel.setlabel\(\)](#) (on page 7-43)  
[channel.setlabelcolumn\(\)](#) (on page 7-44)  
[channel.setlabelrow\(\)](#) (on page 7-46)

## Return value

Several of the channel functions return a value for specified channels and channel patterns.

The return value for these functions is a string containing a list of comma-delimited return items. The *channelList* argument of the remote command determines the number and order of these returned items.

When the *channelList* parameter for these functions is "slotX", the response first lists the channels starting from lowest to highest. More specifically, the channels are returned in numeric order.

When the *channelList* parameter for these functions is "allslots", the response starts with slot 1 and increases to slot 6 for the Model 707B. The Model 708B has only one slot, thus "allslots" is the same as "slot1" for this model. Each slot is processed completely before going to the next. Therefore, all slot 1 channels are listed before slot 2 channels.

When the response is numeric, but in string format, use the `tonumber()` function to convert the string to a number. For example, sending these commands:

```
x = tonumber("1403")
print(x)
```

Results in:

```
1.403000000e+03
```

When the response is a comma-delimited string, the individual return items can be identified by iterating through the list using the comma delimiters. For example, the Lua code below will start at the beginning of a string and break the string into individual items at each comma. The `tonumber()` function is used on each item to determine if it is a number or not. In either case, the value is printed.

```
index1 = 1
index2 = 1
text = "123,abc,hello,4.56"
endIndex = string.len(text)
while index2 ~= endIndex do
    index2 = string.find(text, ",", index1)
    if not index2 then
        index2 = endIndex
    end

    subString = string.sub(text, index1, index2 - 1)
    if not number(subString) then
        print(subString)
    else
        print(tonumber(subString))
    end
    index1 = index2 + 1
end
```

## createconfigscript function

This function captures the present settings of the instrument.

[createconfigscript\(\)](#) (on page 7-47)

## Data queue

Use the data queue commands to:

- Share data between test scripts running in parallel
- Access data from a remote group or a local node on a TSP-Link<sup>®</sup> network at any time

The data queue in the Test Script Processor (TSP<sup>®</sup>) scripting engine is first-in, first-out (FIFO).

You can access data from the data queue even if a remote group or a node has overlapped operations in process.

[dataqueue.add\(\)](#) (on page 7-48)

[dataqueue.CAPACITY](#) (on page 7-49)

[dataqueue.clear\(\)](#) (on page 7-49)

[dataqueue.count](#) (on page 7-50)

[dataqueue.next\(\)](#) (on page 7-51)

## delay function

This function is used to hold up instrument operation for a specified period of time. It is typically used to soak a device at a specific voltage or current for a period of time.

[delay\(\)](#) (on page 7-52)

## Digital I/O

The digital I/O port of the instrument can control external circuitry (such as a component handler for binning operations).

The I/O port has 14 lines. Each line can be at TTL logic state 1 (high) or 0 (low). See the pinout diagram in [Digital I/O port](#) (on page 2-7) for additional information.

There are commands to read and write to each individual bit, and commands to read and write to the entire port.

[digio.readbit\(\)](#) (on page 7-52)

[digio.readport\(\)](#) (on page 7-53)

[digio.trigger\[N\].assert\(\)](#) (on page 7-53)

[digio.trigger\[N\].clear\(\)](#) (on page 7-54)

[digio.trigger\[N\].EVENT\\_ID](#) (on page 7-54)

[digio.trigger\[N\].mode](#) (on page 7-55)

[digio.trigger\[N\].overrun](#) (on page 7-57)

[digio.trigger\[N\].pulsewidth](#) (on page 7-57)

[digio.trigger\[N\].release\(\)](#) (on page 7-58)

[digio.trigger\[N\].reset\(\)](#) (on page 7-58)

[digio.trigger\[N\].stimulus](#) (on page 7-59)

[digio.trigger\[N\].wait\(\)](#) (on page 7-61)

[digio.writebit\(\)](#) (on page 7-61)

[digio.writeport\(\)](#) (on page 7-62)

[digio.writeprotect](#) (on page 7-63)

## Display

[display.clear\(\)](#) (on page 7-63)

[display.getannunciators\(\)](#) (on page 7-64)

[display.getcursor\(\)](#) (on page 7-65)

[display.getlastkey\(\)](#) (on page 7-66)

[display.gettext\(\)](#) (on page 7-67)

[display.inputvalue\(\)](#) (on page 7-68)

[display.loadmenu.add\(\)](#) (on page 7-70)

[display.loadmenu.catalog\(\)](#) (on page 7-71)

[display.loadmenu.delete\(\)](#) (on page 7-72)

[display.locallockout](#) (on page 7-72)

[display.menu\(\)](#) (on page 7-73)

[display.prompt\(\)](#) (on page 7-74)

[display.screen](#) (on page 7-75)

[display.sendkey\(\)](#) (on page 7-76)

[display.setcursor\(\)](#) (on page 7-77)

[display.settext\(\)](#) (on page 7-79)

[display.trigger.clear\(\)](#) (on page 7-80)

[display.trigger.EVENT\\_ID](#) (on page 7-80)

[display.waitkey\(\)](#) (on page 7-81)

## Error queue

When errors and events occur, the error and status messages are placed in the error queue. Use the error queue commands to request error and status message information.

[errorqueue.clear\(\)](#) (on page 7-82)

[errorqueue.count](#) (on page 7-83)

[errorqueue.next\(\)](#) (on page 7-83)

## eventlog functions and attributes

The functions and attributes in this group control the event log.

[eventlog.all\(\)](#) (on page 7-84)  
[eventlog.clear\(\)](#) (on page 7-85)  
[eventlog.count](#) (on page 7-86)  
[eventlog.enable](#) (on page 7-86)  
[eventlog.next\(\)](#) (on page 7-87)  
[eventlog.overwritemethod](#) (on page 7-88)

## exit function

Use this function from in your script to terminate it.

[exit\(\)](#) (on page 7-88)

## Queries and response messages

You can use the `print()`, `printbuffer()`, and `printnumber()` functions to query the instrument and generate response messages. The format attributes control how the data is formatted for the print functions used.

The localnode commands determine if generated errors are automatically sent and if prompts are generated.

[format.asciiprecision](#) (on page 7-89)  
[format.byteorder](#) (on page 7-89)  
[format.data](#) (on page 7-90)  
[localnode.prompts](#) (on page 7-123)  
[localnode.prompts4882](#) (on page 7-124)  
[localnode.showerrors](#) (on page 7-127)  
[print\(\)](#) (on page 7-131)  
[printbuffer\(\)](#) (on page 7-132)  
[printnumber\(\)](#) (on page 7-134)

## GPIB

These commands store the GPIB address and indicate whether GPIB communication is enabled.

[gpib.address](#) (on page 7-92)

## LAN and LXI

The LAN commands have options that allow you to review and configure network settings.

The `lan.config.*` commands allow you to configure LAN settings over the remote interface. Note that you must send `lan.applysettings()` for the configuration settings to take effect.

The `lan.status.*` commands help you determine the status of the LAN.

The `lan.trigger[N].*` commands allow you to set up and assert trigger events that are sent over the LAN.

Other LAN commands allow you to reset the LAN, restore defaults, check LXI domain information, and enable or disable the Nagle algorithm.

- [lan.applysettings\(\)](#) (on page 7-93)
- [lan.config.dns.address\[N\]](#) (on page 7-94)
- [lan.config.dns.domain](#) (on page 7-95)
- [lan.config.dns.dynamic](#) (on page 7-95)
- [lan.config.dns.hostname](#) (on page 7-96)
- [lan.config.dns.verify](#) (on page 7-97)
- [lan.config.gateway](#) (on page 7-97)
- [lan.config.ipaddress](#) (on page 7-98)
- [lan.config.method](#) (on page 7-98)
- [lan.config.subnetmask](#) (on page 7-99)
- [lan.lxidomain](#) (on page 7-100)
- [lan.nagle](#) (on page 7-100)
- [lan.reset\(\)](#) (on page 7-101)
- [lan.restoredefaults\(\)](#) (on page 7-101)
- [lan.status.dns.address\[N\]](#) (on page 7-102)
- [lan.status.dns.name](#) (on page 7-102)
- [lan.status.duplex](#) (on page 7-103)
- [lan.status.gateway](#) (on page 7-103)
- [lan.status.ipaddress](#) (on page 7-104)
- [lan.status.macaddress](#) (on page 7-104)
- [lan.status.port.dst](#) (on page 7-105)
- [lan.status.port.rawsocket](#) (on page 7-105)
- [lan.status.port.telnet](#) (on page 7-106)
- [lan.status.port.vxi11](#) (on page 7-106)
- [lan.status.speed](#) (on page 7-107)
- [lan.status.subnetmask](#) (on page 7-107)
- [lan.trigger\[N\].assert\(\)](#) (on page 7-108)
- [lan.trigger\[N\].clear\(\)](#) (on page 7-108)
- [lan.trigger\[N\].connect\(\)](#) (on page 7-109)
- [lan.trigger\[N\].connected](#) (on page 7-109)
- [lan.trigger\[N\].disconnect\(\)](#) (on page 7-110)
- [lan.trigger\[N\].EVENT\\_ID](#) (on page 7-111)
- [lan.trigger\[N\].ipaddress](#) (on page 7-111)
- [lan.trigger\[N\].mode](#) (on page 7-112)
- [lan.trigger\[N\].overrun](#) (on page 7-113)
- [lan.trigger\[N\].protocol](#) (on page 7-114)
- [lan.trigger\[N\].pseudostate](#) (on page 7-114)
- [lan.trigger\[N\].stimulus](#) (on page 7-115)
- [lan.trigger\[N\].wait\(\)](#) (on page 7-117)
- [localnode.description](#) (on page 7-119)
- [localnode.password](#) (on page 7-121)
- [localnode.passwordmode](#) (on page 7-122)

## Local node

Commands that allow you to set and read from the local node.

[localnode.define.\\*](#) (on page 7-118)  
[localnode.description](#) (on page 7-119)  
[localnode.model](#) (on page 7-121)  
[localnode.password](#) (on page 7-121)  
[localnode.prompts](#) (on page 7-123)  
[localnode.prompts4882](#) (on page 7-124)  
[localnode.reset\(\)](#) (on page 7-124)  
[localnode.revision](#) (on page 7-125)  
[localnode.serialno](#) (on page 7-126)  
[localnode.showerrors](#) (on page 7-127)  
[node\[N\].execute\(\)](#) (on page 7-120)  
[node\[N\].getglobal\(\)](#) (on page 7-120)  
[node\[N\].setglobal\(\)](#) (on page 7-126)

## make accessor functions

Use these functions to create functions to get and set attribute values.

[makegetter\(\)](#) (on page 7-127)  
[makesetter\(\)](#) (on page 7-128)

## memory functions

Check the amount of memory that is available or used in the instrument.

## opc function

This function sets the operation complete status bit when all overlapped commands are completed.

[opc\(\)](#) (on page 7-131)

## print functions

Output data from the instrument.

[print\(\)](#) (on page 7-131)  
[printbuffer\(\)](#) (on page 7-132)  
[printnumber\(\)](#) (on page 7-134)

## Reset

Resets settings to their default settings.

[digio.trigger\[N\].reset\(\)](#) (on page 7-58)  
[lan.reset\(\)](#) (on page 7-101)  
[localnode.reset\(\)](#) (on page 7-124)  
[reset\(\)](#) (on page 7-135)  
[timer.reset\(\)](#) (on page 7-200)  
[trigger.blender\[N\].reset\(\)](#) (on page 7-203)  
[trigger.timer\[N\].reset\(\)](#) (on page 7-211)  
[tsplink.trigger\[N\].reset\(\)](#) (on page 7-224)

## Scan

The scan functions and attributes allow you to set up scanning over the remove interface.

- [scan.abort\(\)](#) (on page 7-135)
- [scan.add\(\)](#) (on page 7-136)
- [scan.addimagestep\(\)](#) (on page 7-138)
- [scan.background\(\)](#) (on page 7-139)
- [scan.bypass](#) (on page 7-140)
- [scan.create\(\)](#) (on page 7-141)
- [scan.execute\(\)](#) (on page 7-142)
- [scan.list\(\)](#) (on page 7-143)
- [scan.mode](#) (on page 7-145)
- [scan.reset\(\)](#) (on page 7-146)
- [scan.scancount](#) (on page 7-147)
- [scan.state\(\)](#) (on page 7-148)
- [scan.stepcount](#) (on page 7-149)
- [scan.trigger.arm.clear\(\)](#) (on page 7-149)
- [scan.trigger.arm.set\(\)](#) (on page 7-150)
- [scan.trigger.arm.stimulus](#) (on page 7-150)
- [scan.trigger.channel.clear\(\)](#) (on page 7-152)
- [scan.trigger.channel.set\(\)](#) (on page 7-152)
- [scan.trigger.channel.stimulus](#) (on page 7-153)
- [scan.trigger.clear\(\)](#) (on page 7-155)

## Scripting

Scripting helps you combine commands into a block of code that the instrument can run. Scripts help you communicate with the instrument efficiently. These commands describe how to create, load, modify, run, and exit scripts.

For detail on using scripts, see [Fundamentals of scripting for TSP](#) (on page 6-1).

- [createconfigscript\(\)](#) (on page 7-47)
- [exit\(\)](#) (on page 7-88)
- [makegetter\(\)](#) (on page 7-127)
- [makesetter\(\)](#) (on page 7-128)
- [script.anonymous](#) (on page 7-155)
- [script.delete\(\)](#) (on page 7-156)
- [script.new\(\)](#) (on page 7-156)
- [script.newautorun\(\)](#) (on page 7-158)
- [script.restore\(\)](#) (on page 7-159)
- [script.run\(\)](#) (on page 7-159)
- [script.user.catalog\(\)](#) (on page 7-160)
- [scriptVar.autorun](#) (on page 7-160)
- [scriptVar.list\(\)](#) (on page 7-162)
- [scriptVar.name](#) (on page 7-162)
- [scriptVar.run\(\)](#) (on page 7-163)
- [scriptVar.save\(\)](#) (on page 7-164)
- [scriptVar.source](#) (on page 7-165)

## Slot

The slot attributes configure and read the settings of the cards in the slots. You can also set up pseudocards.

[slot\[X\].idn](#) (on page 7-168)  
[slot\[X\].poles.four](#) (on page 7-169)  
[slot\[X\].poles.one](#) (on page 7-170)  
[slot\[X\].poles.two](#) (on page 7-171)  
[slot\[X\].pseudocard](#) (on page 7-171)

## Status model functions

The status model is a set of status registers and queues. You can use the following commands to manipulate and monitor these registers and queues to view and control various instrument events.

[status.condition](#) (on page 7-172)  
[status.node\\_enable](#) (on page 7-174)  
[status.node\\_event](#) (on page 7-176)  
[status.operation.\\*](#) (on page 7-177)  
[status.operation.user.\\*](#) (on page 7-179)  
[status.questionable.\\*](#) (on page 7-181)  
[status.request\\_enable](#) (on page 7-183)  
[status.request\\_event](#) (on page 7-185)  
[status.reset\(\)](#) (on page 7-187)  
[status.standard.\\*](#) (on page 7-187)  
[status.system.\\*](#) (on page 7-190)  
[status.system2.\\*](#) (on page 7-192)  
[status.system3.\\*](#) (on page 7-194)  
[status.system4.\\*](#) (on page 7-196)  
[status.system5.\\*](#) (on page 7-198)

## timer functions

Use the functions in this group to control the timer. The timer can be used to measure the time it takes to perform various operations. Use the `timer.reset()` function at the beginning of an operation to reset the timer to zero, and then use the `timer.measure.t()` at the end of the operation to measure the elapsed time.

[timer.measure.t\(\)](#) (on page 7-200)  
[timer.reset\(\)](#) (on page 7-200)



## trigger functions and attributes

Use the trigger functions and attributes to control specific trigger objects.

[trigger.blender\[N\].clear\(\)](#) (on page 7-201)  
[trigger.blender\[N\].EVENT\\_ID](#) (on page 7-201)  
[trigger.blender\[N\].orenable](#) (on page 7-202)  
[trigger.blender\[N\].overrun](#) (on page 7-203)  
[trigger.blender\[N\].reset\(\)](#) (on page 7-203)  
[trigger.blender\[N\].stimulus\[M\]](#) (on page 7-204)  
[trigger.blender\[N\].wait\(\)](#) (on page 7-205)  
[trigger.clear\(\)](#) (on page 7-206)  
[trigger.EVENT\\_ID](#) (on page 7-206)  
[trigger.timer\[N\].clear\(\)](#) (on page 7-206)  
[trigger.timer\[N\].count](#) (on page 7-207)  
[trigger.timer\[N\].delay](#) (on page 7-208)  
[trigger.timer\[N\].delaylist](#) (on page 7-208)  
[trigger.timer\[N\].EVENT\\_ID](#) (on page 7-209)  
[trigger.timer\[N\].overrun](#) (on page 7-210)  
[trigger.timer\[N\].passthrough](#) (on page 7-210)  
[trigger.timer\[N\].reset\(\)](#) (on page 7-211)  
[trigger.timer\[N\].stimulus](#) (on page 7-212)  
[trigger.timer\[N\].wait\(\)](#) (on page 7-213)  
[trigger.wait\(\)](#) (on page 7-213)

## TSP-Link

These functions and attributes allow you to set up and work with a system that is connected by a TSP-Link<sup>®</sup> network.

[tsplink.group](#) (on page 7-214)  
[tsplink.master](#) (on page 7-215)  
[tsplink.node](#) (on page 7-215)  
[tsplink.readbit\(\)](#) (on page 7-216)  
[tsplink.readport\(\)](#) (on page 7-216)  
[tsplink.reset\(\)](#) (on page 7-217)  
[tsplink.state](#) (on page 7-218)  
[tsplink.trigger\[N\].assert\(\)](#) (on page 7-219)  
[tsplink.trigger\[N\].clear\(\)](#) (on page 7-219)  
[tsplink.trigger\[N\].EVENT\\_ID](#) (on page 7-220)  
[tsplink.trigger\[N\].mode](#) (on page 7-220)  
[tsplink.trigger\[N\].overrun](#) (on page 7-222)  
[tsplink.trigger\[N\].pulsewidth](#) (on page 7-223)  
[tsplink.trigger\[N\].release\(\)](#) (on page 7-223)  
[tsplink.trigger\[N\].reset\(\)](#) (on page 7-224)  
[tsplink.trigger\[N\].stimulus](#) (on page 7-224)  
[tsplink.trigger\[N\].wait\(\)](#) (on page 7-225)  
[tsplink.writebit\(\)](#) (on page 7-226)  
[tsplink.writeport\(\)](#) (on page 7-227)  
[tsplink.writeprotect](#) (on page 7-227)

## TSP-Net

The TSP-Net module provides a simple socket-like programming interface to Test Script Processor (TSP<sup>®</sup>) enabled instruments.

[tspnet.clear\(\)](#) (on page 7-228)  
[tspnet.connect\(\)](#) (on page 7-229)  
[tspnet.disconnect\(\)](#) (on page 7-230)  
[tspnet.execute\(\)](#) (on page 7-231)  
[tspnet.idn\(\)](#) (on page 7-232)  
[tspnet.read\(\)](#) (on page 7-232)  
[tspnet.readavailable\(\)](#) (on page 7-233)  
[tspnet.reset\(\)](#) (on page 7-234)  
[tspnet.termination\(\)](#) (on page 7-234)  
[tspnet.timeout](#) (on page 7-235)  
[tspnet.tsp.abort\(\)](#) (on page 7-236)  
[tspnet.tsp.abortonconnect](#) (on page 7-236)  
[tspnet.tsp.rtablecopy\(\)](#) (on page 7-237)  
[tspnet.tsp.runscript\(\)](#) (on page 7-238)  
[tspnet.write\(\)](#) (on page 7-239)

## Userstrings

Use the functions in this group to store and retrieve user-defined strings in nonvolatile memory. These strings are stored as key-value pairs. Key-value pairs are associated arrays of data items, where the key is used to index into the array. The key is a unique identifier such as a part number or identification string. The value is a data item or a pointer to where that data item is stored.

You can use the `userstring` functions to store custom, instrument-specific information in the instrument, such as department number, asset number, or manufacturing plant location.

[userstring.add\(\)](#) (on page 7-239)  
[userstring.catalog\(\)](#) (on page 7-240)  
[userstring.delete\(\)](#) (on page 7-241)  
[userstring.get\(\)](#) (on page 7-242)

## waitcomplete function

Allows you to send a command to wait for all overlapped operations in a group to complete.

[waitcomplete\(\)](#) (on page 7-242)

## Overview of instrument drivers

To use an instrument connected to a computer, you need to send instrument commands to it to make it do what you want. This can be tedious, as the programmer has to learn the low level syntax and also deal with how their programming language or development environment interfaces to the remote communication interface driver or VISA I/O library. Keithley and most other test and measurement companies supply instrument drivers for their instruments.

One thing a driver can do is deal with cross-coupling issues. If you change a setting on an instrument, this can cause other settings to change without notifying you. For example, if you change the range on an instrument, the resolution can change at the same time. Instrument drivers take care of these issues for you as long as it is feasible. Therefore, a driver would have a call where you pass in the measurement function, range, and resolution. The driver would then take care of sending the correct sequence of commands or generate an error if it was impossible to set the requested values.

For information on finding instrument drivers on the Keithley website, see [Getting instrument drivers](#) (on page 5-18).

## Instrument driver types

There are several different styles of instrument drivers. Keithley Instruments provides three different instrument drivers for the Models 707B and 708B: A native LabVIEW driver, an IVI-C driver, and an IVI-COM driver. You need to pick the style that best suits the application development environment (ADE) that you are using. For example, if you are using LabVIEW, you would pick a native LabVIEW driver. If a native LabVIEW driver is not available then you can use an IVI-C driver as LabVIEW has the option of creating a wrapper for the IVI-C driver.

LabVIEW supports IVI-COM drivers but they are definitely not the first or second choice. However, if they are the only driver types for the instrument, they can be used.

If LabWindows/CVI or C/C++ is your programming language, an IVI-C driver is the best option. For Microsoft® Visual Basic® 6.0 and any .NET language (C#, VB.NET, and so on), an IVI-COM driver is the best option.

Sometimes instrument vendors do not provide all three driver types. Most languages can accommodate other driver types, but this is not optimal.

The following sections describe the different driver types in more detail.

## VXIPnP drivers

VXI (Vixie) plug-and-play (VXIPnP) style drivers are Win32 DLLs that have some standard functions defined by the VXIPnP Alliance, such as:

- init
- close
- error\_message
- reset
- self\_test
- Read
- Initiate
- Fetch
- Abort

The application programming interface (API) was defined so that users of instruments would have a familiar API from instrument to instrument. There are some basic guidelines when creating APIs for your instrument, such as using VISA data types and how to construct the CVI hierarchy.

## Interchangeable Virtual Instruments (IVI) style drivers

The major problem with VXIPnP drivers was that the API was not specific to the instrument. For something as standard as measuring DC volts on a digital multimeter (DMM), it would be a good idea if there were a set of standard functions to do this.

The [IVI Foundation](http://www.ivifoundation.org) (<http://www.ivifoundation.org>) defined a set of application programming interfaces (APIs) for the following instruments: DMM, function generator, DC power supply, scope, switch, spectrum analyzer, RF signal generator and power meter. They are currently working on class APIs for some other instrument types.

There are two types of IVI drivers: IVI-COM drivers use Microsoft® COM technology to expose driver functionality, while IVI-C drivers use conventional Microsoft® Windows® DLLs to export simple C-based functions.

For more information about IVI drivers and the differences between the COM, C, and .NET interfaces, see [Making the Case for IVI](#) (<http://pacificmindworks.com/docs/Making%20the%20Case%20for%20IVI.pdf>).

## LabVIEW drivers

### Native LabVIEW drivers

A native LabVIEW™ driver is a LabVIEW driver that is created using entirely built-in LabVIEW VIs — it does not make any calls to external DLLs or Library files. This makes the driver portable to all the platforms and operating systems that LabVIEW and VISA supports (currently, Linux® on x86, Mac OS® X, and Microsoft® Windows®).

National Instruments (NI™) maintains a native [LabVIEW driver style guide](http://zone.ni.com/devzone/cda/tut/p/id/3271) (<http://zone.ni.com/devzone/cda/tut/p/id/3271>).

### LabVIEW driver wrappers

All IVI-C drivers have a function panel file (.fp) that shows a hierarchy of the function calls into a DLL. It is a tool that guides a user to select the correct function call in the driver, since a DLL only has a flat API entry point scheme (unlike COM or .NET). Any CVI-generated .fp file can be imported into LabVIEW and LabVIEW will generate a wrapper for the DLL. The drawback here is that the driver is dependent on the DLL, which is not portable and is therefore Windows-specific.

## Getting instrument drivers

*To see what drivers are available for your instrument:*

1. Go to the [Keithley Instruments support website](http://www.keithley.com/support) (<http://www.keithley.com/support>).
2. Enter the model number of your instrument.
3. Select **Software Driver** from the list.

For LabVIEW™, you can also go to the National Instrument website and search their instrument driver database.

## Instrument driver examples

All Keithley drivers come with examples written in several programming languages that show you how to do the most common things with the instruments.

Install the driver. The examples are in the Microsoft® Windows® Start menu, under **Keithley Instruments > Model Number** (where Model Number is the instrument model number).

## Migrating from Models 707A and 708A

### Migrating Model 707A or 708A programs to Model 707B or 708B

This section is intended to assist you if you are migrating existing programs from the Model 707A or 708A to use the TSP programming syntax on the Model 707B or 708B.

The Model 707A and 708A instruments use device-dependent command (DDC) programming. The Model 707B or 708B use the TSP scripting model. This section provides you with:

- Command syntax differences
- A brief explanation of some Model 707A and 708A model-specific terminology and its Model 707B or 708B equivalent

#### NOTE

Users who want to run programs using Model 707A or 708A DDC commands can run in Model 707A or 708A compatibility mode. See [Using Models 707A and 708A compatibility mode](#) (on page B-1).

### Platform differences

When writing a script for the Model 707B or 708B instrument, consider the following platform differences.

	Model 707A or 708A	Model 707B or 708B
<b>Execution host</b>	A computer sends commands over GPIB from a user-generated program such as Visual Basic, C# or C/C++	A computer sends either commands or user-generated scripts over GPIB, USB, or Ethernet. Scripts can also be run from the front panel of the Model 707B or 708B.
<b>Command structure</b>	Single ASCII capital letter commands, followed by argument if necessary.	Descriptive, word-based command and argument structure using modern dot notation format.
<b>Store program flow control</b>	Not possible; instrument can only step sequentially through a stored relay setup in response to an external trigger.	TSP scripting environment allows access to all Lua program control structure operations, such as for-next, if-then-else, while-do, and repeat-until.

### Execution host

One of the most significant differences between the Model 707A or 708A and Model 707B or 708B is the ability to store user scripts on the instrument. Once loaded onto the instrument, these scripts can be run without connection to a computer. This is different from the Model 707A or 708A, which could only iterate through an existing stored relay setup if there was no connection to a computer. The ability of the Model 707B or 708B to run scripts that are stored locally results in fast execution time and no communications bottlenecks between the instrument and the computer.

### Command structure

The DDC structure of the Model 707A or 708A instrument is based on a single ASCII capital letter with possible alphanumeric arguments and terminated with the "X" execute command.

The Model 707B or 708B instrument uses a modern dot notation format that logically organizes commands by family, subset 1, subset 2 – optional, and argument. For example:

```
channel.open("allslots")
```

### Stored program flow control

DDC programming depended on an additional programming environment to send commands to the 707A or 708A instrument. This provided options for program flow control, but at the expense of added complexity.

The TSP scripting environment uses the Lua programming language, providing a robust and cohesive flow control framework.

## DDC to ICL command equivalencies

In many cases, DDC commands have a single corresponding ICL equivalent command that performs the same or a similar function.

In some cases, more than one ICL command is needed to provide the same functionality of its equivalent DDC counterpart because of the expanded capabilities and additional flexibility of the TSP scripting environment.

The following sections describe the equivalent commands or sets of commands.

### Commands with one-to-one equivalents

The commands in the following table are equivalent.

#### Commands with one-to-one equivalents

DDC	TSP equivalent command	Description
Crc	<code>channel.close(channelList)</code>	Closes a channel
Nrc	<code>channel.open(channelList)</code>	Opens a channel
Hn	<code>display.sendkey()</code>	Emulates a keypress
P0	<code>channel.open("allslots")</code>	Opens all channels on all slots
R0	<code>reset()</code>	Restore factory defaults
U2,0	<code>channel.getclose("allslots")</code>	Get closed channels on all slots
X	No corresponding command	Execute
J0	No corresponding command	Self-test
U7	<code>digio.readport()</code>	Read value from digital I/O port

## Relay setup commands

The following table shows DDC commands that refer to Model 707A and 708A relay setups. The Model 707B or 708B equivalent of relay setups are called scans and patterns.

Scans allow a predetermined set of channels to be closed in a sequential order based on a particular event or combination of events. For more information, see [Scanning and triggering](#) (on page 3-1).

There are some distinct differences between relay setups and scans:

- Scans can only be accessed sequentially. Unlike relay setups, you cannot specify an alternate starting location.
- You can only retrieve scan lists in string format.
- You can only append steps to scans — you cannot insert scan steps before steps that are already in the scan list.
- You cannot remove scan steps from the scan list.

The correlation to scanning holds true for DDC commands  $In$ ,  $En$ ,  $E0$ ,  $Lbbbb$ ,  $Pn$ , and  $Qn$ , while the DDC commands  $Z0,n$ ,  $Zn,0$ , and  $Zm,n$  resemble patterns on the Model 707B or 708B instrument. Patterns allow several channels to be associated by a name, and any operation that occurs to the pattern (such as close or open) happens to each channel in the pattern. For more information, see [Channel patterns](#) (on page 2-92).

### Scanning trigger

DDC	TSP equivalent command	Description
$En$	No corresponding command	Point to present relay setup
$E0$	No corresponding command	Point to stored relay setup
$Lbbbb$	<code>print(scan.list())</code>	Download setups
$Pn$	No corresponding command	Clear relay setup
$Qn$	<code>scan.create(" ")</code>	Delete setup
$Z0,n$	<code>channel.pattern.snapshot("patternName")</code>	Copy present relays to $n$
$Zn,0$	<code>channel.close("patternName")</code>	Copy setup from $n$ to relays
$Zm,n$	<code>channel.pattern.setimage(pattern1, pattern2)</code>	Copy setup from $m$ to $n$
$In$	No corresponding command	Insert blank setup to mem

### Disable or enable the scan event trigger

When enabling external triggering on the Model 707A or 708A instruments, there were two possible trigger sources, the external trigger line or a GPIB Get command. The Model 707B or 708B has multiple trigger events that are available to iterate through a scan list. The following table shows that specifying a scan event trigger automatically enables it. For more information, see [Scanning and triggering](#) (on page 3-1).

### Scanning trigger

DDC	TSP equivalent command	Description
F0	<code>scan.trigger.channel.stimulus = 0</code>	Disable scanning trigger
F1	<code>scan.trigger.channel.stimulus = eventID</code>	Enable scanning trigger



## Trigger polarity

The Model 707A or 708A instrument has one external trigger input that was available to accept TTL level trigger inputs to advance the stored relay setup step.

The Model 707B or 708B instrument allows 14 TTL level inputs through the digital I/O connector to act as events to iterate through a scan list. The handling of this command is similar to the F0 and F1 DDC commands shown in the table below, except that you must specify [N] as the digital I/O line polarity you wish to set. For more information, see [Scanning and triggering](#) (on page 3-1).

### Scan trigger polarity

DDC	TSP equivalent command	Description
A0	<code>digio.trigger[N].mode = digio.TRIG_FALLING</code> <code>scan.trigger.channel.stimulus = digio.trigger[N].EVENT_ID</code>	Select falling edge for scan trigger
A1	<code>digio.trigger[N].mode = digio.TRIG_RISING</code> <code>scan.trigger.channel.stimulus = digio.trigger[N].EVENT_ID</code>	Select rising edge for scan trigger

## Matrix ready

The Model 707A or 708A instrument provides a dedicated TTL output for when a channel close or open operation completes. This output includes the settling time of the specific channel (fixed in hardware) added to a programmed settling time that could be specified by the user. These commands are shown in the table below.

### Matrix ready polarity

DDC	TSP equivalent command	Description
B0	No corresponding command	Rising edge on matrix ready
B1	No corresponding command	Falling edge on matrix ready

The Model 707B or 708B instrument does not have a dedicated matrix ready line when the DDC command compatibility is disabled. However, you can create a TSP function that can emulate the dedicated hardware matrix ready function onto a digital I/O line. The following examples show you how to create TSP code functions for channel close and channel open, respectively, that will duplicate matrix ready functionality for digital I/O Bit B10. After including these functions in your script, a channel close operation is made by calling the function with the channel argument:

```
chanClose("1A01")
```

For more information, see [Digital I/O port](#) (on page 2-7).

### Example: Channel close with matrix-ready functionality

<pre>function chanClose(chan) digio.writebit(10,0)  channel.close(chan) digio.writebit(10,1)  end</pre>	<p>Function accepts valid channels as arguments</p> <p>Clear the 10th digital I/O bit before the close operation</p> <p>Close the channels in the argument</p> <p>Set the 10th digital I/O bit after the close operation</p> <p>End the function</p>
---	--

**Example: Channel open with matrix-ready functionality**

function chanOpen(chan) digio.writebit(10,0)  channel.open(chan) digio.writebit(10,1)  end	Function accepts valid channels as arguments Clear the 10th digital I/O bit before the open operation Open the channels in the argument Set the 10th digital I/O bit after the open operation End the function
--	--

**Set VFD display**

The following commands display a value on the VFD front panel. To return the display to power-on default, send the command:

```
display.screen = display.main
```

The display can also be cleared with the `display.clear()` command.

**VFD display**

DDC	TSP equivalent command	Description
Dcccccc	display.screen = display.USER	Set VFD display text
	display.settext()	

**Set relay setup data format**

The  $G_n$  DDC command controls the data format of relay setups that are returned when queried with the  $U_2, s$  command. The Model 707B or 708B uses a string format for returning scan list, so data formatting is not used.

**Relay setup data format**

DDC	TSP equivalent command	Description
$G_n$	No corresponding command	Data format

**GPIO EOI hold off control**

The  $K_n$  DDC command controls how the GPIO EOI line behaves. The Model 707B or 708B commands are processed from an internal buffer as they are received, so no control is required for the GPIO EOI line.

**GPIO EOI hold off**

DDC	TSP equivalent command	Description
$K_n$	No corresponding command	GPIO EOI/hold off control

## Service request configuration

---

These commands control the behavior of the SRQ line. The Model 707B or 708B instrument can configure some of the events that cause the SRQ to assert, but none of those events address Matrix Ready or when the instrument is ready for trigger. For more information, see [Status model functions](#) (on page 5-13).

### Service request configuration

DDC	TSP equivalent command	Description
M0	<code>status.request_enable = 0</code>	Disable SRQ
M8	No corresponding command	SRQ on Matrix Ready
M16	No corresponding command	SRQ on Matrix Ready
M32	<code>status.request_enable = status.ERROR_AVAILABLE</code>	SRQ on error

## Digital I/O control

---

The Model 707B or 708B instrument provides increased flexibility, with fourteen digital I/O lines (compared to the Model 707A, which has eight input lines and eight output lines, and the Model 708A, which has sixteen input lines and sixteen output lines). It is also possible to write to the digital I/O port simultaneously or on a per-bit basis. For more information, see the [Digital I/O](#) (on page 5-8) section.

### Digital I/O control

DDC	TSP equivalent command	Description
Onnn	<code>digio.writeport(data)</code>	Sets states of digital I/O
Db,s	or <code>digio.writebit(bit,data)</code>	

## Additional channel settling time

---

The Model 707A or 708A had the ability to add relay settling time to the system after a channel closes or opens. The Model 707B or 708B improves on the settling time and allows you to apply additional settling delay on a per-channel basis. For more information, see [channel functions and attributes](#) (on page 5-4).

### Additional channel settling time

DDC	TSP equivalent command	Description
Sn	<code>channel.setdelay(channelList,value)</code>	Additional settling time

## Retrieve card settling time

Although base channel settle time cannot be returned, additional delay time that was specified with the `channel.setdelay(channelList,delay)` command can be returned using:

```
channel.getdelay("allslots")
```

Delays for each channel in csv format are returned. For more information, see [channel functions and attributes](#) (on page 5-4).

### Card settling time

DDC	TSP equivalent command	Description
U6	No corresponding command	Send longest settling time

## Trigger source control

The DDC commands in the following table control the trigger source for advancing the relay setups. The Model 707B or 708B instrument provides similar functionality, but omits triggering on talk and triggering on X. For more information, see [Scanning and triggering](#) (on page 3-1).

### Trigger source control

DDC	TSP equivalent command	Description
T0 or T1	No corresponding command	Trigger on Talk
T2 or T3	<code>scan.trigger.channel.stimulus = trigger.EVENT_ID</code>	Trigger on GPIB Get
T4 or T5	No corresponding command	Trigger on X
T6 or T7	<code>scan.trigger.channel.stimulus = digio.trigger[N].EVENT_ID</code>	Trigger on external trigger

## Send machine status word

The DDC U0 command provides information on several areas of the Model 707A or 708A instrument in one long csv form. There is no one command to provide the same functionality as the U0 command, but the series of Model 707B or 708B commands shown in the following table can be used to provide very similar information, without the need to parse a long, unwieldy string.

### Send machine status word

DDC	TSP equivalent commands	Description
U0	<code>print(localnode.model)</code> <code>print(scan.trigger.channel.stimulus)</code> <code>print(display.getlastkey())</code> <code>print(status.request_enable)</code> <code>print(digio.readport())</code>	Returns the model number Returns trigger stimulus line Returns the last key pressed Gets SRQ Mask Reads Digital I/O port

## Error status word

---

This series of commands provides a descriptive list of error codes and error messages until no more errors are present. For more information, see [Error queue](#) (on page 5-8).

### Error status word

DDC	TSP equivalent command	Description
U1	<pre>count = errorqueue.count for x=count,0,1 do errorcode, message = errorqueue.next() print(errorcode) print(message) end</pre>	Get the number of errors in the queue For loop Get next error codes Print errorcode Print error messages End

## Relay pointer operations

---

The DDC commands in the following table use relay setups as the Model 707B or 708B instrument would use patterns.

The U2,n DDC command returns the channels that are closed in a format based on the DDC G<sub>n</sub> command. The corresponding command for this operation returns the channels contained in the pattern as a csv list. There is no need to send a pattern to the relays. Operations that are to be done to the channels of a pattern are done on the pattern correctly. For more information, see [channel functions and attributes](#) (on page 5-4).

### Relay pointer operations

DDC	TSP equivalent command	Description
U2,n	<code>channel.pattern.getimage(pattern)</code>	Point to stored relay setup
U3	No corresponding command	Send relay step pointer

## Number of subordinates

---

The Model 707B or 708B can expand to other Keithley Instrument's products that have a TSP-Link connector available. When the command listed in the following table is executed, it provides the number of nodes present in the TSP-linked system.

A feature of the Model 707B or 708B is that these remote nodes are not limited to Model 707B or 708B instruments. They can be remotely linked to any Keithley product that supports TSP-Link. For more information, see [TSP-Link system](#) (on page 6-44).

### Number of subordinates

DDC	TSP equivalent command	Description
U4	<code>print(tsplink.reset())</code>	Send number of subordinate devices

The following command returns the model of the card in the specified slot of the local instrument, along with a description of the card, the firmware version, and the serial number.

To get information from cards in TSP-Link connected instruments, send:

```
print(node[nodeNumber].slot[slotNumber].idn)
```

Where: *nodeNumber* is the TSP-Link node of the remote system and *slotNumber* is the slot on the instrument to query. For more information, see [Slot](#) (on page 5-13) and [TSP-Link](#) (on page 5-14).

### Card model number

DDC	TSP equivalent command	Description
U5,n	print(slot[slotNumber].idn)	Send identification of each card in the instrument

### Relay test input

The Model 707B or 708B instrument does not use a relay test connector, so this command is not supported.

### Relay test input

DDC	TSP equivalent command	Description
U8	No corresponding command	Send relay test input

### Connect rules

On the Model 707B or 708B, this command sets the connect rules for the entire instrument. You cannot set this rule on a row-by-row basis. If this feature is required, the high performance of the Model 707B or 708B instrument provides ample time to change the connection rules as needed before channel close or open operations. For more information, see [channel functions and attributes](#) (on page 5-4).

### Connect rules

DDC	TSP equivalent command	Description
Vabcdefg	channel.connectrule = channel.MAKE_BEFORE_BREAK	Make-before-break
Wabcdefg	channel.connectrule = channel.BREAK_BEFORE_MAKE	Break-before-make

### Termination character sent by instrument

The Model 707B or 708B always sends a linefeed (ASCII 10) as a termination character after any data. This behavior cannot be changed.

### Termination characters

DDC	TSP equivalent command	Description
Yn	No corresponding command	Termination character



---

## Instrument programming

### In this section:

---

Fundamentals of scripting for TSP .....	6-1
Fundamentals of programming for TSP .....	6-10
Using Test Script Builder (TSB) .....	6-31
Advanced scripting for TSP .....	6-33
TSP-Link system and running simultaneous test scripts .....	6-44
TSP-Net .....	6-52

## Fundamentals of scripting for TSP

### Fundamentals of scripting for TSP

#### NOTE

Though it can improve your process to use scripts, you do not have to create scripts to use the instrument. Most of the examples in the documentation can be run by sending individual command messages. The next few sections of the documentation describe scripting and programming features of the instrument. You only need to review this information if you are using scripting and programming.

Scripting helps you combine commands into a block of code that the instrument can run. Scripts help you communicate with the instrument more efficiently.

Scripts offer several advantages compared to sending individual commands from the host controller (computer):

- Scripts are easier to save, refine, and implement than individual commands.
- The instrument performs more quickly and efficiently when it processes scripts than it does when it processes individual commands.
- You can incorporate features such as looping and branching into scripts.
- Scripts allow the controller to perform other tasks while the instrument is running a script, enabling some parallel operation.
- Scripts eliminate repeated data transfer times from the controller.

In the instrument, the Test Script Processor (TSP<sup>®</sup>) scripting engine processes and runs scripts.

This section describes how to create, load, modify, and run scripts.



## What is a script?

---

A script is a collection of instrument control commands and programming statements. Scripts that you create are referred to as **user scripts**.

Your scripts can be interactive. Interactive scripts display messages on the front panel of the instrument that prompt the operator to enter parameters.

## Run-time and nonvolatile memory storage of scripts

---

Scripts are loaded into the run-time environment of the instrument. From there, they can be stored in nonvolatile memory in the instrument.

The run-time environment is a collection of global variables, which include scripts, that the user has defined. A global variable can be used to store a value while the instrument is turned on. When you create a script, the instrument creates a global variable with the same name so that you can reference the script more conveniently. After scripts are loaded into the run-time environment, you can run and manage them from the front panel of the instrument or from a computer. Information in the run-time environment is lost when the instrument is turned off.

Nonvolatile memory is where information is stored even when the instrument is turned off. Save scripts to nonvolatile memory to save them even if the power is cycled. The scripts that are in nonvolatile memory are loaded into the run-time environment when the instrument is turned on.

Scripts are placed in the run-time environment when:

- The instrument is turned on. All scripts that are saved to nonvolatile memory are copied to the run-time environment when the instrument is turned on.
- Loaded over a remote command interface.

For detail on the amount of memory available in the run-time environment, see [Memory considerations for the run-time environment](#) (on page 6-42).

### NOTE

If you make changes to a script in the run-time environment, the changes are lost when the instrument is turned off. To save the changes, you must save them to nonvolatile memory. See [Working with scripts in nonvolatile memory](#) (on page 6-7).

## What can be included in scripts?

---

Scripts can include combinations of TSP commands and Lua code. TSP commands instruct the instrument to do one thing and are described in the command reference (see TSP commands). Lua is a scripting language that is described in [Fundamentals of programming for TSP](#) (on page 6-10).

## Commands that cannot be used in scripts

---

Though an instrument accepts the following commands, you cannot use these commands in scripts.

### Commands that cannot be used in scripts

General commands	IEEE Std 488.2 common commands	
abort	*CLS	*RST
endflash	*ESE	*SRE
endscript	*ESE?	*SRE?
flash	*ESR?	*STB?
loadscript	*IDN?	*TRG
loadandrunscript	*OPC	*TST?
password	*OPC?	*WAI

## Manage scripts

---

This section describes how to create scripts by sending commands over the remote interface and using TSB Embedded.

### Tools for managing scripts

To manage scripts, you can send messages to the instrument, use your own development tool or program, use Keithley Instruments Test Script Builder (TSB) software, or use TSB Embedded on the instrument's web interface. TSB and TSB Embedded are described below.

- **Test Script Builder (TSB) software:** TSB software is a programming tool that is on the Test Script Builder Software Suite CD-ROM (included with your Models 707B and 708B). You can use it to create, modify, debug, and store Test Script Processor (TSP<sup>®</sup>) scripting engine scripts. For more information about using the TSB software, see [Using Test Script Builder \(TSB\)](#) (on page 6-31).
- **TSB Embedded:** TSB Embedded is a tool with a reduced set of features than the complete Keithley TSB software. TSB Embedded has both script-building functionality and console functionality (single-line commands). It is accessed from a web browser.

## NOTE

If you are using TSB or TSB Embedded to create scripts, you do not need to use the commands `loadscript` or `loadandrunscript` and `endscript`.

### Create and load a script

You create scripts by loading them into the run-time environment of the instrument. You can load a script as a named script or as the anonymous script.

Once a script is loaded into the instrument, you can execute it remotely or from the front panel.

### Anonymous scripts

If a script is created with the `loadscript` or `loadandrunscript` command with no name defined, it is called the "anonymous" script. There can only be one anonymous script in the run-time environment. If another anonymous script is loaded into the run-time environment, it replaces the existing anonymous script.

### Named scripts

A named script is a script with a unique name. You can have as many named scripts as needed in the instrument (within the limits of the memory available to the run-time environment). When a named script is loaded into the run-time environment with the `loadscript` or `loadandrunscript` commands, a global variable with the same name is created to reference the script.

Key points regarding named scripts:

- If you load a new script with the same name as an existing script, the existing script becomes an unnamed script, which in effect removes the existing script if there are no variables that reference it.
- Sending revised scripts with different names will not remove previously loaded scripts.
- Named scripts can be saved to internal nonvolatile memory. Saving a named script to nonvolatile memory allows the instrument to be turned off without losing the script. See [Working with scripts in nonvolatile memory](#) (on page 6-7).

### Load a script by sending commands over the remote interface

To load a script over the remote interface, you can use the `loadscript`, `loadandrunscript`, and `endscript` commands.

The `loadscript` and `loadandrunscript` commands start the collection of messages that make up the script. When the instrument receives either of these commands, it starts collecting all subsequent messages. Without these commands, the instrument would run them immediately as individual commands.

The `endscript` command tells the instrument to compile the collection of messages. It compiles the messages into one group of commands. This group of commands is loaded into the run-time environment.

The following figure shows an example of how to load a script named “test.” The first command tells the instrument to start collecting the messages for the script named “test.” The last command marks the end of the script. When this script is run, the message “This is a test” is displayed on the instrument and sent to the computer.

**Figure 82: Loadscript and endscript example**

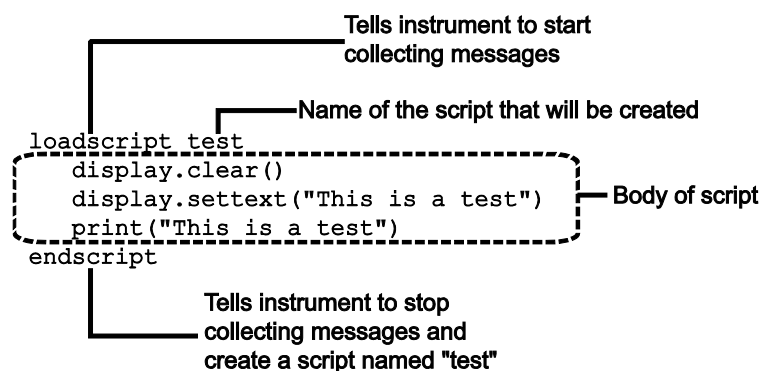

**To load a named script by sending commands:**

1. Send the command `loadscript scriptName`, where `scriptName` is the name of the script. The name must be a legal Lua variable name.
2. Send the commands that need to be included in the script.
3. Send the command `endscript`.
4. You can now run the script. See [Run scripts](#) (on page 6-5).

**NOTE**

To run the script immediately, use `loadandrunscript scriptName` instead of `loadscript`.

**Create a script using TSB Embedded****NOTE**

If you are using TSB Embedded to create scripts, you do not need to use the commands `loadscript` or `loadandrunscript` and `endscript`.

You can create a script from the instrument web page with TSB Embedded. When you save the script in TSB Embedded, it is loaded into the run-time environment and saved in the nonvolatile memory of the instrument. For information about using TSB Embedded, select the **Help** button on a web page or the Help option from the navigation pane on the left side of the web interface.

**To create a script using TSB Embedded:**

1. In the TSP Script box, enter a name for the script.
2. In the input area, enter the sequence of commands to be included in the script.
3. Click **Save Script**. The name is added to the User Scripts list on the left.

**Run scripts**

This section describes how to run the anonymous and named scripts.

**NOTE**

If the instrument is in local control when the script is started, it switches to remote control (`REM` is displayed) while the script is running. The instrument is returned to local control when the script completes. If you press the front-panel **EXIT (LOCAL)** key while the script is running, the script is stopped.

**Run the anonymous script**

The anonymous script can be run many times without reloading it. It remains in the run-time environment until a new anonymous script is created or until the instrument is turned off.

To run the anonymous script, use any one of these commands:

- `run()`
- `script.run()`
- `script.anonymous()`
- `script.anonymous.run()`

**Run a named script**

You can run any named script that is in the run-time environment using one of the following commands:

- `scriptVar()`
- `scriptVar.run()`

Where: `scriptVar` is the user-defined name of the script.

To run a named script from TSB Embedded, select the script from the User Scripts list and click **Run**.

When a script is named, it can be accessed using the global variable `scriptVar`.

**Example: Run a named script**

```
test3()
```

If the script `test3` is loaded into the run-time environment, the instrument executes `test3`.

**Scripts that run automatically**

You can set up scripts to run automatically when you power on the instrument. To do this, either set the `autorun` attribute for the script to `yes` (see [Autorun scripts](#) (on page 6-6)), or create a script with the script name `autoexec` (see [Autoexec script](#) (on page 6-7)).

**Autorun scripts**

Autorun scripts run automatically when the instrument is turned on. You can set any number of scripts to autorun. The run order for autorun scripts is arbitrary, so make sure the run order is not important.

As shown in the example below, you can set a script to run automatically by setting the `.autorun` attribute of the script to `"yes"` and then saving the script.

Example:

```
scriptVar.autorun = "yes"
scriptVar.save()
```

Where: `scriptVar` is the user-defined name of the script.

To disable autorun, set the script's `.autorun` attribute to `"no"` and then save the script.

**NOTE**

The `scriptVar.save()` command saves the script to nonvolatile memory, which makes the change persistent through a power cycle. See [Save a user script to nonvolatile memory](#) (on page 6-8) for more detail.

**Example: Set a script to run automatically**

```
test5.autorun = "yes"
test5.save()
```

Assume a script named `test5` is in the run-time environment. The next time the instrument is turned on, `test5` script automatically loads and runs.

**Autoexec script**

The autoexec script runs automatically when the instrument is turned on. It runs after all the scripts have loaded and any scripts marked as autorun have run.

To create a script that executes automatically, create and load a new script and name it `autoexec`. See [Create and load a script](#) (on page 6-3).

**NOTE**

You must save the autoexec script to nonvolatile memory if you want to use it after instrument power has been turned off and then turned on again. See [Save a user script to nonvolatile memory](#) (on page 6-8) for more detail.

**Example: Creating an autoexec script with loadscript command**

```
loadscript autoexec
display.clear()
display.settext("Hello from autoexec")
endscript
autoexec.save()
```

Creates the script `autoexec`.  
Saves the `autoexec` script to nonvolatile memory. The next time the instrument is turned on, "Hello from autoexec" is displayed.

**Example: Creating an autoexec script using TSB Embedded**

```
display.clear()
display.settext("Hello from autoexec")
```

In the TSP Script box, enter `autoexec`.  
Enter the code in the entry box.  
Click **Save Script**.  
Creates a new script that clears the display when the instrument is turned on and displays "Hello from autoexec."

**Working with scripts in nonvolatile memory**

The [Fundamentals of scripting for TSP](#) (on page 6-1) section in this manual describes working with scripts, primarily in the run-time environment. You can also work with scripts in nonvolatile memory.

The run-time environment and nonvolatile memory are separate storage areas in the instrument. The information in the run-time environment is lost when the instrument is turned off. The nonvolatile memory remains intact when the instrument is turned off. When the instrument is turned on, information in nonvolatile memory is loaded into the run-time environment.

**Save a user script**

You can save scripts to nonvolatile memory using commands or TSB Embedded.

Only named scripts can be saved to nonvolatile memory. The anonymous script must be named before it can be saved to nonvolatile memory.

**NOTE**

If a script is not saved to nonvolatile memory, the script is lost when the instrument is turned off.

**To save a script to nonvolatile memory:**

1. Create and load a named script (see [Create and load a script](#) (on page 6-3)).
2. Do one of the following:
  - Send the command `scriptVar.save()`, where `scriptVar` is the name of the script.
  - In TSB Embedded, click **Save Script**.

**Example: Save a user script to nonvolatile memory**

```
test1.save()
```

Assume a script named `test1` has been loaded. `test1` is saved into nonvolatile memory.

**To save a script to an external USB drive:****NOTE**

When you save a script to a USB flash drive, you do not need to specify a file extension. The extension `.tsp` is automatically added. If you do specify a file extension, it must be `.tsp`. An error will occur if you use any other file extension.

1. Load a script (see [Create and load a script](#) (on page 6-3)).
2. Send the command `scriptVar.save("/usb1/filename.tsp")`, where `scriptVar` is the variable referencing the script and `filename.tsp` is the name of the file.

**NOTE**

You can also use TSB Embedded to save a script to a USB flash drive (or any accessible drive) installed on your computer. From TSB Embedded, load the script and click **Export to PC**.

**Save the anonymous script as a named script**

To save the anonymous script to nonvolatile memory, you must name it first.

**To save the anonymous script as a named script:**

1. To name the script, send the command `script.anonymous.name = "myTest"` (where `myTest` is the name of the script).
2. Send the `script.anonymous.save()` command to save `myTest` to nonvolatile memory.

**Delete user scripts****NOTE**

These steps remove a script from nonvolatile memory. To completely remove a script from the instrument, there are additional steps you must take. See [Delete user scripts from the instrument](#) (on page 6-41).

**To delete a script from nonvolatile memory using a remote interface:**

You can delete the script from nonvolatile memory by sending either of the following commands:

- `script.delete("name")`
- `script.user.delete("name")`

Where: *name* is the user-defined name of the script.

**To delete a script from nonvolatile memory using TSB Embedded:**

1. In TSB Embedded, select the script from the User Scripts list.
2. Click **Delete**. There is no confirmation message.

**Example: Delete a user script from nonvolatile memory**

```
script.delete("test8")
```

Delete a user script named `test8` from nonvolatile memory.

---

## Programming example

### Interactive script

An interactive script prompts the operator to input values using the instrument front panel. The following example script uses display messages to prompt the operator to:

- Enter the digital I/O line on which to output a trigger
- Enter the output trigger pulsewidth

After the output trigger occurs, the front display displays a message to the operator.

When an input prompt is displayed, the script waits until the operator inputs the parameter or presses the **ENTER** key.

The example shown here assumes that you are using TSB or TSB Embedded. If you are using a remote interface, you need to add the `loadscript` and `endscript` commands to the example code. See [Load a script by sending commands over the remote interface](#) (on page 6-4) for details.



```
-- Clear the display.
display.clear()

-- Prompt user for digital I/O line on which to output trigger.
myDigioLine = display.menu("Select digio line", "1 2 3 4 5 6 7 8 9")

-- Convert user input to a number.
intMyDigioLine = tonumber(myDigioLine)

-- Prompt user for digital output trigger mode.
myDigioEdge = display.menu("Select digio mode", "Rising Falling")
if myDigioEdge == "Rising" then
    edgeMode = digio.TRIG_RISING
else
    edgeMode = digio.TRIG_FALLING
end

-- Prompt user for output trigger pulsewidth.
myPulseWidth = display.prompt(
    "000.0", "us", "Enter trigger pulsewidth", 10, 10, 100)

-- Scale the entered pulsewidth.
myPulseWidth = myPulseWidth * 1e-6

-- Generate the pulse.
digio.trigger[intMyDigioLine].mode = edgeMode
digio.trigger[intMyDigioLine].pulsewidth = myPulseWidth
digio.trigger[intMyDigioLine].assert()

-- Alert the user through the display that the
-- output trigger has occurred.
display.setCursor(1, 1)
display.setText("Trigger asserted $Non digital I/O line " .. intMyDigioLine)

-- Wait five seconds and then return to main screen.
delay(5)
display.screen = display.MAIN
```

## Fundamentals of programming for TSP

### Introduction

To conduct a test, a computer (controller) is programmed to send sequences of commands to an instrument. The controller orchestrates the actions of the instrumentation. The controller is typically programmed to request measurement results from the instrumentation and make test sequence decisions based on those measurements.

To take advantage of the advanced features of the instrument, you can add programming commands to your scripts. Programming commands control script execution and provide tools such as variables, functions, branching, and loop control.

The Test Script Processor (TSP<sup>®</sup>) scripting engine is a Lua interpreter. In TSP-enabled instruments, the Lua programming language has been extended with Keithley-specific instrument control commands.

## What is Lua?

Lua is a programming language that can be used with TSP-enabled instruments. Lua is an efficient language with simple syntax that is easy to learn.

Lua is also a scripting language, which means that scripts are compiled and run when they are sent to the instrument. You do not compile them before sending them to the instrument.

## Lua basics

This section contains the basics about the Lua programming language to allow you to start adding Lua programming commands to your scripts quickly.

For more information about Lua, see the [Lua website](http://www.lua.org) (<http://www.lua.org>). Another source of useful information is the [Lua users group](http://lua-users.org) (<http://lua-users.org>), created for and by users of Lua programming language.

### Comments

Comments start anywhere outside a string with a double hyphen (--). If the text immediately after a double hyphen (--) is anything other than double left brackets ([ [), the comment is a short comment, which continues only until the end of the line. If double left brackets follow the double hyphen (-- [ [), it is a long comment, which continues until the corresponding double right brackets (] ]) close the comment. Long comments may continue for several lines and may contain nested [ [ ... ] ] pairs. The table below shows how to use code comments.

#### Using code comments

Type of comment	Comment delimiters	Usage	Example
Short comment	--	Use when the comment text fits on a single line.	--Turn off the front-panel display.
Long comment	--[[ ]]	Use when the comment text is longer than one line.	--[[Display a menu with three menu items. If the second menu item is selected, the selection will be given the value Test2.]]

### Function and variable name restrictions

You cannot use Lua reserved words and top level command names for function or variable names.

You cannot use the following Lua reserved words for function or variable names.

Lua reserved words		
and	for	or
break	function	repeat
do	if	return
else	in	then
elseif	local	true
end	nil	until
false	not	while

You also cannot use top-level command names as variable names. If you use these names, it will result in the loss of use of the commands. For example, if you send the command `digio = 5`, you cannot access the `digio.*` commands until you turn the instrument power off and then turn it on again. These groups include:

Top level command names	
beeper	localnode
bit	opc
channel	reset
dataqueue	scan
delay	slot
digio	status
display	timer
errorqueue	trigger
eventlog	tsplink
exit	tspnet
format	userstring
gpi	waitcomplete
lan	

## Values and variable types

---

In Lua, you can use variables to store values in the run-time environment for later use.

Lua is a dynamically-typed language; the type of the variable is determined by the value that is assigned to the variable.

Variables in Lua are assumed to be global unless they are explicitly declared to be local. A global variable is accessible by all commands. Global variables do not exist until they have been assigned a value.

## Variable types

Variables can be one of the following types.

### Variable types and values

Variable type returned	Value	Notes
"nil"	not declared	The type of the value <code>nil</code> , whose main property is to be different from any other value; usually it represents the absence of a useful value.
"boolean"	true or false	Boolean is the type of the values <code>false</code> and <code>true</code> . In Lua, both <code>nil</code> and <code>false</code> make a condition <code>false</code> ; any other value makes it <code>true</code> .
"number"	number	All numbers are real numbers; there is no distinction between integers and floating-point numbers.
"string"	sequence of words or characters	
"function"	a block of code	Functions perform a task or compute and return values.
"table"	an array	New tables are created with <code>{ }</code> braces. For example, <code>{1, 2, 3.00e0}</code> .
"userdata"	variables	Allows arbitrary program data to be stored in Lua variables.
"thread"	line of execution	

To determine the type of a variable, you can call the `type()` function, as shown in the examples below.

## NOTE

The output you get from these examples may vary depending on the data format that is set.

### Example: Nil

```
x = nil
print(x, type(x))
```

nil      nil

### Example: Boolean

```
y = false
print(y, type(y))
```

false      boolean

### Example: String and number

```
x = "123"
print(x, type(x))

x = x + 7
print(x, type(x))
```

123      string

Adding a number to x forces its type to number.

1.30      number

**Example: Function**

<pre>function add_two(first_value,   second_value)   return first_value + second_value end print(add_two(3, 4), type(add_two))</pre>	<pre>7      function</pre>
--	----------------------------

**Example: Table**

<pre>atable = {1, 2, 3, 4} print(atable, type(atable)) print(atable[1]) print(atable[4])</pre>	<p>Defines a table with four numeric elements. Note that the "table" value (shown here as a096cd30) will vary.</p> <pre>table: a096cd30      table 1 4</pre>
--	--

**Delete a global variable**

To delete a global variable, assign `nil` to the global variable. This removes the global variable from the run-time environment.

**Functions**

With Lua, you can group commands and statements using the `function` keyword. Functions can take zero, one, or multiple parameters, and they return zero, one, or multiple values.

You can use functions to form expressions that calculate and return a value. Functions can also act as statements that execute specific tasks.

Functions are first-class values in Lua. That means that functions can be stored in variables, passed as arguments to other functions, and returned as results. They can also be stored in tables.

Note that when a function is defined, it is stored in the run-time environment. Like all data that is stored in the run-time environment, the function persists until it is removed from the run-time environment, is overwritten, or the instrument is turned off.

**Create functions using the function keyword**

Functions are created with a message or in Lua code in either of the following forms:

```
function myFunction(parameterX) functionBody end
myFunction = function (parameterX) functionBody end
```

Where:

- *myFunction*: The name of the function.
- *parameterX*: Parameter names. To use multiple parameters, separate the names with commas.
- *functionBody*: The code that is executed when the function is called.

To execute a function, substitute appropriate values for *parameterX* and insert them into a message formatted as:

```
myFunction(valueForParameterX, valueForParameterY)
```

Where *valueForParameterX* and *valueForParameterY* represent the values to be passed to the function call for the given parameters.

## NOTE

The output you get from these examples will vary depending on the data format settings of the instrument.

### Example 1

```
function add_two(first_value,
  second_value)
  return first_value + second_value
end
print(add_two(3, 4))
```

Creates a variable named `add_two` that has a variable type of function.

Output:  
7

### Example 2

```
add_three = function(first_value,
  second_value, third_value)
  return first_value + second_value +
    third_value
end
print(add_three(3, 4, 5))
```

Creates a variable named `add_three` that has a variable type of function.

Output:  
12

### Example 3

```
function sum_diff_ratio(first_value,
  second_value)
  psum = first_value + second_value
  pdif = first_value - second_value
  prat = first_value / second_value
  return psum, pdif, prat
end
sum, diff, ratio = sum_diff_ratio(2, 3)
print(sum)
print(diff)
print(ratio)
```

Returns multiple parameters (sum, difference, and ratio of the two numbers passed to it).

Output:  
5  
-1  
0.666666666666667

## Create functions using scripts

You can use scripts to define functions. Scripts that define a function are like any other script: They do not cause any action to be performed on the instrument until they are executed. The global variable of the function does not exist until the script that created the function is executed.

A script can consist of one or more functions. Once a script has been run, the computer can call functions that are in the script directly.

## NOTE

The following steps use TSB Embedded. You can also use the `loadscript` and `endscript` commands to create the script over the remote interface.

### **Steps to create a function using a script:**

1. In TSB Embedded, enter a name into the TSP Script box. For example, type `MakeMyFunction`.
2. Enter the function as the body of the script. This example concatenates two strings:

```
MyFunction = function (who)
    print("Hello " .. who)
end
```

3. Click **Save Script**.

`MakeMyFunction` is now on the instrument in a global variable with the same name as the script (`MakeMyFunction`). However, the function defined in the script does not yet exist because the script has not been executed.

4. Run the script as a function. For this example, send:

```
MakeMyFunction()
```

This instructs the instrument to run the script, which creates the `MyFunction` global variable. This variable is of the type "function" (see [Variable types](#) (on page 6-13)).

5. Run the new function with a value.

```
MyFunction("world")
```

The response message is:

```
Hello world
```

### **Group commands using the function keyword**

The following script contains instrument commands that display the name of the person that is using the script on the front panel of the instrument. It takes one parameter to represent this name. When this script is run, the function is loaded in memory. Once loaded into memory, you can call the function outside of the script to execute it.

When calling the function, you must specify a string for the *name* argument of the function. For example, to set the name to **John**, call the function as follows:

```
myDisplay("John")
```

### **Example: User script**

User script created in Test Script Builder or TSB Embedded	User script created in user's own program
<pre>function myDisplay(name)     display.clear()     display.setText(         name .. "\$N is here!") end</pre>	<pre>loadscript function myDisplay(name)     display.clear()     display.setText(         name .. " \$N is here!") end endscript</pre>

## **Operators**

You can compare and manipulate Lua variables and constants using operators.

**Arithmetic operators**

Operator	Description
+	addition
-	subtraction
*	multiplication
/	division
-	negation (for example, $c = -a$ )
^	exponentiation

**Relational operators**

Operator	Description
<	less than
>	greater than
<=	less than or equal
>=	greater than or equal
~=	not equal
==	equal

**Logical operators**

The logical operators in Lua are `and`, `or`, and `not`. All logical operators consider both `false` and `nil` as false and anything else as true.

The operator `not` always returns `false` or `true`.

The conjunction operator `and` returns its first argument if the first argument is `false` or `nil`; otherwise, `and` returns its second argument. The disjunction operator `or` returns its first argument if this value is different from `nil` and `false`; otherwise, `or` returns its second argument. Both `and` and `or` use shortcut evaluation, that is, the second operand is evaluated only if necessary.

**NOTE**

The example output you get may vary depending on the data format settings of the instrument.

**Example**

```
print(10 or errorqueue.next()) 1.0000000e+01
print(nil or "a")               a
print(nil and 10)               nil
print(false and errorqueue.next()) false
print(false and nil)           false
print(false or nil)            nil
print(10 and 20)               2.0000000e+01
```

**String concatenation****String operators**

Operator	Description
..	Concatenates two strings. If either argument is a number, it is coerced to a string (in a reasonable format) before concatenation.



**Example: Concatenation**

<pre>print(2 .. 3)</pre>	23
<pre>print("Hello " .. "World")</pre>	Hello World

**Operator precedence**

Operator precedence in Lua follows the order below (from higher to lower priority):

- ^ (exponentiation)
- not, - (unary)
- \*, /
- +, -
- .. (concatenation)
- <, >, <=, >=, ~=, !=, ==
- and
- or

You can use parentheses to change the precedences in an expression. The concatenation ("..") and exponentiation ("^") operators are right associative. All other binary operators are left associative. The examples below show equivalent expressions.

**Equivalent expressions**

<code>reading + offset &lt; testValue/2+0.5</code>	=	<code>(reading + offset) &lt; ((testValue/2)+0.5)</code>
<code>3+reading^2*4</code>	=	<code>3+((reading^2)*4)</code>
<code>Rdg &lt; maxRdg and lastRdg &lt;= expectedRdg</code>	=	<code>(Rdg &lt; maxRdg) and (lastRdg &lt;= expectedRdg)</code>
<code>-reading^2</code>	=	<code>-(reading^2)</code>
<code>reading^testAdjustment^2</code>	=	<code>reading^(testAdjustment^2)</code>

**Conditional branching**

Lua uses the `if`, `else`, `elseif`, `then`, and `end` keywords to do conditional branching.

Note that in Lua, `nil` and `false` are `false` and everything else is `true`. Zero (0) is `true` in Lua.

The syntax of a conditional block is as follows:

```
if expression then
  block
elseif expression then
  block
else
  block
end
```

Where:

- *expression* is Lua code that evaluates to either true or false
- *block* consists of one or more Lua statements

#### Example: If

```
if 0 then
  print("Zero is true!")
else
  print("Zero is false.")
end
```

Output:  
Zero is true!

#### Example: Comparison

```
x = 1
y = 2
if x and y then
  print("Both x and y are true")
end
```

Output:  
Both x and y are true

#### Example: If and else

```
x = 2
if not x then
  print("This is from the if block")
else
  print("This is from the else block")
end
```

Output:  
This is from the else  
block

**Example: Else and elseif**

```
x = 1
y = 2
if x and y then
    print("'if' expression 2 was not false.")
end

if x or y then
    print("'if' expression 3 was not false.")
end

if not x then
    print("'if' expression 4 was not false.")
else
    print("'if' expression 4 was false.")
end

if x == 10 then
    print("x = 10")
elseif y > 2 then
    print("y > 2")
else
    print("x is not equal to 10, and y is not greater than 2.")
end
```

**Output:**

```
'if' expression 2 was not false.
'if' expression 3 was not false.
'if' expression 4 was false.
x is not equal to 10, and y is not greater than 2.
```

**Loop control**

If you need to repeat code execution, you can use the Lua `while`, `repeat`, and `for` control structures. To exit a loop, you can use the `break` keyword.

**While loops**

To use conditional expressions to determine whether to execute or end a loop, you use `while` loops. These loops are similar to [Conditional branching](#) (on page 6-18) statements.

```
while expression do
    block
end
```

Where:

- *expression* is Lua code that evaluates to either `true` or `false`
- *block* consists of one or more Lua statements

**NOTE**

The output you get from this example may vary depending on the data format settings of the instrument.

**Example: While**

```
list = {
  "One", "Two", "Three", "Four", "Five", "Six"}
print("Count list elements on numeric index:")
element = 1
while list[element] do
  print(element, list[element])
  element = element + 1
end
```

This loop exits when `list[element] = nil`.

**Output:**

```
Count list elements on
  numeric index:
1  One
2  Two
3  Three
4  Four
5  Five
6  Six
```

**Repeat until loops**

To repeat a command, you use the `repeat ... until` statement. The body of a `repeat` statement always executes at least once. It stops repeating when the conditions of the `until` clause are met.

```
repeat
  block
until expression
```

Where:

- *block* consists of one or more Lua statements
- *expression* is Lua code that evaluates to either `true` or `false`

**NOTE**

The output you get from this example may vary depending on the data format settings of the instrument.

**Example: Repeat until**

```
list = {
  "One", "Two", "Three", "Four", "Five", "Six"}
print("Count elements in list using repeat:")
element = 1
repeat
  print(element, list[element])
  element = element + 1
until not list[element]
```

**Output:**

```
Count elements in list
  using repeat:
1  One
2  Two
3  Three
4  Four
5  Five
6  Six
```

**For loops**

There are two variations of `for` statements supported in Lua: numeric and generic.

**NOTE**

In a `for` loop, the loop expressions are evaluated once, before the loop starts.

The output you get from these examples may vary depending on the data format settings of the instrument.

**Example: Numeric for**

```
list = {"One", "Two", "Three", "Four", "Five", "Six"}
----- For loop -----
print("Counting from one to three:")
for element = 1, 3 do
    print(element, list[element])
end
print("Counting from one to four, in steps of two:")
for element = 1, 4, 2 do
    print(element, list[element])
end
```

The numeric `for` loop repeats a block of code while a control variable runs through an arithmetic progression.

**Output:**

```
Counting from one to three:
1   One
2   Two
3   Three
Counting from one to four, in steps of two:
1   One
3   Three
```

**Example: Generic for**

```
days = {"Sunday",
         "Monday",   "Tuesday",
         "Wednesday", "Thursday",
         "Friday",   "Saturday"}

for i, v in ipairs(days) do
    print(days[i], i, v)
end
```

The generic `for` statement works by using functions called iterators. On each iteration, the iterator function is called to produce a new value, stopping when this new value is nil.

**Output:**

```
Sunday    1    Sunday
Monday    2    Monday
Tuesday   3    Tuesday
Wednesday 4    Wednesday
Thursday  5    Thursday
Friday    6    Friday
Saturday  7    Saturday
```

## Break

The `break` statement can be used to terminate the execution of a `while`, `repeat`, or `for` loop, skipping to the next statement after the loop. A `break` ends the innermost enclosing loop.

Return and `break` statements can only be written as the last statement of a block. If it is necessary to return or `break` in the middle of a block, an explicit inner block can be used.

## NOTE

The output you get from these examples may vary depending on the data format settings of the instrument.

### Example: Break with while statement

```
local numTable = {5, 4, 3, 2, 1}
local k = table.getn(numTable)
local breakValue = 3
while k > 0 do
    if numTable[k] == breakValue then
        print("Going to break and k = ", k)
        break
    end
    k = k - 1
end
if k == 0 then
    print("Break value not found")
end
```

This example defines a break value (`breakValue`) so that the `break` statement is used to exit the `while` loop before the value of `k` reaches 0.

Output:

```
Going to break and k = 3
```

### Example: Break with while statement enclosed by comment delimiters

```
local numTable = {5, 4, 3, 2, 1}
local k = table.getn(numTable)
--local breakValue = 3
while k > 0 do
    if numTable[k] == breakValue then
        print("Going to break and k = ", k)
        break
    end
    k = k - 1
end
if k == 0 then
    print("Break value not found")
end
```

This example defines a break value (`breakValue`), but the break value line is preceded by comment delimiters so that the break value is not assigned, and the code reaches the value 0 to exit the `while` loop.

Output:

```
Break value not found
```

**Example: Break with infinite loop**

<pre>a, b = 0, 1 while true do   print(a, b)   a, b = b, a + b   if a &gt; 500 then     break   end end end</pre>	<p>This example uses a <code>break</code> statement that causes the while loop to exit if the value of <code>a</code> becomes greater than 500.</p> <p>Output:</p> <pre>0    1 1    1 1    2 2    3 3    5 5    8 8    13 13   21 21   34 34   55 55   89 89   144 144  233 233  377 377  610</pre>
---	---

**Tables and arrays**

Lua makes extensive use of the data type `table`, which is a flexible array-like data type. Table indices start with 1. Tables can be indexed not only with numbers, but with any value except `nil`. Tables can be heterogeneous, which means that they can contain values of all types except `nil`.

Tables are the sole data structuring mechanism in Lua. They may be used to represent ordinary arrays, symbol tables, sets, records, graphs, trees, and so on. To represent records, Lua uses the field `name` as an index. The language supports this representation by providing `a.name` as an easier way to express `a["name"]`.

**NOTE**

The output you get from this example may vary depending on the data format settings of the instrument.

**Example: Loop array**

<pre>atable = {1, 2, 3, 4} i = 1 while atable[i] do   print(atable[i])   i = i + 1 end</pre>	<p>Defines a table with four numeric elements.</p> <p>Loops through the array and prints each element.</p> <p>The Boolean value of <code>atable[index]</code> evaluates to <code>true</code> if there is an element at that index. If there is no element at that index, <code>nil</code> is returned (<code>nil</code> is considered to be <code>false</code>).</p> <p><b>Output:</b></p> <pre>1 2 3 4</pre>
--	---

## Standard libraries

In addition to the standard programming constructs described in this document, Lua includes standard libraries that contain useful functions for string manipulation, mathematics, and related functions. Test Script Processor (TSP<sup>®</sup>) scripting engine instruments also include instrument control extension libraries, which provide programming interfaces to the instrumentation that can be accessed by the TSP scripting engine. These libraries are automatically loaded when the TSP scripting engine starts and do not need to be managed by the programmer.

The following topics provide information on some of the basic Lua standard libraries. For additional information, see the [Lua website](http://www.lua.org) (<http://www.lua.org>).

### NOTE

When referring to the Lua website, please be aware that the TSP scripting engine uses Lua 5.0.2.

## Base library functions

### Base library functions

Function	Description
<code>collectgarbage()</code> <code>collectgarbage(<i>limit</i>)</code>	Sets the garbage-collection threshold to the given limit (in kilobytes) and checks it against the byte counter. If the new threshold is smaller than the byte counter, Lua immediately runs the garbage collector. If there is no limit parameter, it defaults to zero (0), which forces a garbage-collection cycle. See the "Lua memory management" topic below for more information.
<code>gcinfo()</code>	Returns the number of kilobytes of dynamic memory that the Test Script Processor (TSP <sup>®</sup> ) scripting engine is using, and returns the present garbage collector threshold (also in kilobytes). See the "Lua memory management" topic below for more information.
<code>tonumber(<i>x</i>)</code> <code>tonumber(<i>x</i>, <i>base</i>)</code>	Returns <i>x</i> converted to a number. If <i>x</i> is already a number, or a convertible string, the number is returned; otherwise, it returns <code>nil</code> . An optional argument specifies the base to use when interpreting the numeral. The base may be any integer from 2 to 36, inclusive. In bases above 10, the letter <code>A</code> (in either upper or lower case) represents 10, <code>B</code> represents 11, and so forth, with <code>Z</code> representing 35. In base 10, the default, the number may have a decimal part, as well as an optional exponent. In other bases, only unsigned integers are accepted.
<code>tostring(<i>x</i>)</code>	Receives an argument of any type and converts it to a string in a reasonable format.
<code>type(<i>v</i>)</code>	Returns (as a string) the type of its only argument. The possible results of this function are "nil" (a string, not the value <code>nil</code> ), "number", "string", "boolean", "table", "function", "thread", and "userdata".



## Lua memory management

Lua automatically manages memory, which means you do not have to allocate memory for new objects and free it when the objects are no longer needed. Lua occasionally runs a garbage collector to collect all objects that are no longer accessible from Lua. All objects in Lua are subject to automatic management, including tables, variables, functions, threads, and strings.

Lua uses two numbers to control its garbage-collection cycles. One number counts how many bytes of dynamic memory Lua is using; the other is a threshold. When the number of bytes crosses the threshold, Lua runs the garbage collector, which reclaims the memory of all inaccessible objects. The byte counter is adjusted and the threshold is reset to twice the new value of the byte counter.

## String library functions

This library provides generic functions for string manipulation, such as finding and extracting substrings. When indexing a string in Lua, the first character is at position 1 (not 0, as in ANSI C). Indices may be negative and are interpreted as indexing backward from the end of the string. Thus, the last character is at position -1, and so on.

### String library functions

Function	Description
<code>string.byte(s)</code> <code>string.byte(s, i)</code> <code>string.byte(s, i, j)</code>	Returns the internal numeric codes of the characters <code>s[i]</code> , <code>s[i+1]</code> , ..., <code>s[j]</code> . The default value for <code>i</code> is 1; the default value for <code>j</code> is <code>i</code> .
<code>string.char(...)</code>	Receives zero or more integers separated by commas. Returns a string with length equal to the number of arguments, in which each character has the internal numeric code equal to its corresponding argument.
<code>string.format(formatstring, ...)</code>	Returns a formatted version of its variable number of arguments following the description given in its first argument, which must be a string. The format string follows the same rules as the <code>printf</code> family of standard C functions. The only differences are that the modifiers <code>*</code> , <code>l</code> , <code>L</code> , <code>n</code> , <code>p</code> , and <code>h</code> are not supported and there is an extra option, <code>q</code> . The <code>q</code> option formats a string in a form suitable to be safely read back by the Lua interpreter; the string is written between double quotes, and all double quotes, newlines, embedded zeros, and backslashes in the string are correctly escaped when written. For example, the call: <code>string.format('%q', 'a string with "quotes" and \n new line')</code> will produce the string: <code>"a string with \"quotes\" and \n new line"</code> The options <code>c</code> , <code>d</code> , <code>E</code> , <code>e</code> , <code>f</code> , <code>g</code> , <code>G</code> , <code>i</code> , <code>o</code> , <code>u</code> , <code>X</code> , and <code>x</code> all expect a number as argument. <code>q</code> and <code>s</code> expect a string. This function does not accept string values containing embedded zeros, except as arguments to the <code>q</code> option.
<code>string.len(s)</code>	Receives a string and returns its length. The empty string <code>" "</code> has length 0. Embedded zeros are counted, so <code>"a\000bc\000"</code> has length 5.

**String library functions**

Function	Description
<code>string.lower(s)</code>	Receives a string and returns a copy of this string with all uppercase letters changed to lowercase. All other characters are left unchanged.
<code>string.rep(s, n)</code>	Returns a string that is the concatenation of $n$ copies of the string $s$ .
<code>string.sub(s, i)</code> <code>string.sub(s, i, j)</code>	Returns the substring of $s$ that starts at $i$ and continues until $j$ ; $i$ and $j$ can be negative. If $j$ is absent, it is assumed to be equal to $-1$ (which is the same as the string length). In particular, the call <code>string.sub(s, 1, j)</code> returns a prefix of $s$ with length $j$ , and <code>string.sub(s, -i)</code> returns a suffix of $s$ with length $i$ .
<code>string.upper(s)</code>	Receives a string and returns a copy of this string with all lowercase letters changed to uppercase. All other characters are left unchanged.

## Math library functions

---

This library is an interface to most of the functions of the ANSI C math library. All trigonometric functions work in radians. The functions `math.deg()` and `math.rad()` convert between radians and degrees.

### Math library functions

Function	Description
<code>math.abs(x)</code>	Returns the absolute value of $x$ .
<code>math.acos(x)</code>	Returns the arc cosine of $x$ .
<code>math.asin(x)</code>	Returns the arc sine of $x$ .
<code>math.atan(x)</code>	Returns the arc tangent of $x$ .
<code>math.atan2(y, x)</code>	Returns the arc tangent of $y/x$ , but uses the signs of both parameters to find the quadrant of the result (it also handles correctly the case of $x$ being zero).
<code>math.ceil(x)</code>	Returns the smallest integer larger than or equal to $x$ .
<code>math.cos(x)</code>	Returns the cosine of $x$ .
<code>math.deg(x)</code>	Returns the angle $x$ (given in radians) in degrees.
<code>math.exp(x)</code>	Returns the value $e^x$ .
<code>math.floor(x)</code>	Returns the largest integer smaller than or equal to $x$ .
<code>math.frexp(x)</code>	Returns $m$ and $e$ such that $x = m2^e$ , where $e$ is an integer and the absolute value of $m$ is in the range $[0.5, 1]$ (or zero when $x$ is zero).
<code>math.ldexp(m, e)</code>	Returns $m2^e$ ( $e$ should be an integer).
<code>math.log(x)</code>	Returns the natural logarithm of $x$ .
<code>math.log10(x)</code>	Returns the base-10 logarithm of $x$ .
<code>math.max(x, ...)</code>	Returns the maximum value among its arguments.
<code>math.min(x, ...)</code>	Returns the minimum value among its arguments.
<code>math.pi</code>	The value of $\pi$ (3.141592654).
<code>math.pow(x, y)</code>	Returns $x^y$ (you can also use the expression $x^y$ to compute this value).
<code>math.rad(x)</code>	Returns the angle $x$ (given in degrees) in radians.
<code>math.random()</code> <code>math.random(m)</code> <code>math.random(m, n)</code>	This function is an interface to the simple pseudorandom generator function <code>rand</code> provided by ANSI C. When called without arguments, returns a uniform pseudorandom real number in the range $[0, 1]$ . When called with an integer number $m$ , <code>math.random()</code> returns a uniform pseudorandom integer in the range $[1, m]$ . When called with two integer numbers $m$ and $n$ , <code>math.random()</code> returns a uniform pseudorandom integer in the range $[m, n]$ .
<code>math.randomseed(x)</code>	Sets $x$ as the seed for the pseudorandom generator: equal seeds produce equal sequences of numbers.
<code>math.sin(x)</code>	Returns the sine of $x$ .
<code>math.sqrt(x)</code>	Returns the square root of $x$ . (You can also use the expression $x^{0.5}$ to compute this value.)
<code>math.tan(x)</code>	Returns the tangent of $x$ .

## Programming example: Script with a for loop

The following script puts a message on the front panel display slowly — one character at a time. The intent of this example is to demonstrate:

- The use of a `for` loop
- Simple display remote commands
- Simple Lua string manipulation

### NOTE

When creating a script using the TSB Embedded, you do not need the shell commands `loadscript` and `endscript`, as shown in the examples below.

<b>Example: User script</b>	
<b>User script created in TSB Embedded</b>	<b>User script created in user's own program</b>
	loadscript
<pre>display.clear() myMessage = "Hello World!" for k = 1, string.len(myMessage) do   x = string.sub(myMessage, k, k)   display.settext(x)   print(x)   delay(1) end</pre>	<pre>display.clear() myMessage = "Hello World!" for k = 1, string.len(myMessage) do   x = string.sub(myMessage, k, k)   display.settext(x)   print(x)   delay(1) end</pre>
	endscript

<b>Example: Create channels with a for loop</b>	
<b>User script created in TSB Embedded</b>	<b>User script created in user's own program</b>
	loadscript
<pre>-- Pseudocard assignment necessary   only -- if slot is empty -- slot[1].pseudocard = 7072 for k = 1, 8, 2 do   chan1 =     channel.createspecifier(1, k, 1)   chan2 =     channel.createspecifier(1, k, 2)   print(chan1 .. "," .. chan2)    scan.addimagestep(chan1 .. "," .. chan2 ) end</pre>	<pre>-- Pseudocard assignment necessary only -- if slot is empty -- slot[1].pseudocard = 7072 for k = 1,8,2 do   chan1 =     channel.createspecifier(1, k, 1)   chan2 =     channel.createspecifier(1, k, 2)   print(chan1 .. "," .. chan2)   scan.addimagestep(chan1 .. "," ..   chan2) end</pre>
	endscript
<b>Output</b>	
<pre>1A01,1A02 1C01,1C02 1E01,1E02 1G01,1G02</pre>	

## Using Test Script Builder (TSB)

Keithley Instruments Test Script Builder (TSB) is a software tool that simplifies building test scripts. You can use TSB to perform the following operations:

- Send remote commands and Lua statements
- Receive responses (data) from commands and scripts
- Upgrade instrument firmware
- Create, manage, and run user scripts
- Debug scripts
- Import factory scripts to view or edit and convert to user scripts

The Keithley Instruments Test Script Processor (TSP<sup>®</sup>) scripting engine is a Lua interpreter. In TSP-enabled instruments, the Lua programming language has been extended with Keithley-specific instrument control commands. For more information about using the Lua scripting language with Keithley TSP-enabled instruments, refer to the [Fundamentals of programming for TSP](#) (on page 6-10) section.

Keithley has created a collection of remote commands specifically for use with Keithley TSP-enabled instruments; for detailed information about those commands, refer to the "Command reference" section of the documentation for your specific instrument. You can build scripts from a combination of these commands and Lua programming statements. Scripts that you create are referred to as "user scripts." Also, some TSP-enabled instruments come with a number of built-in factory scripts.

The following figure shows an example of the Test Script Builder. As shown, the workspace is divided into these areas:

- Project navigator
- Script editor
- Outline view
- Programming interaction
- Help files

Figure 83: Example of the Test Script Builder workspace

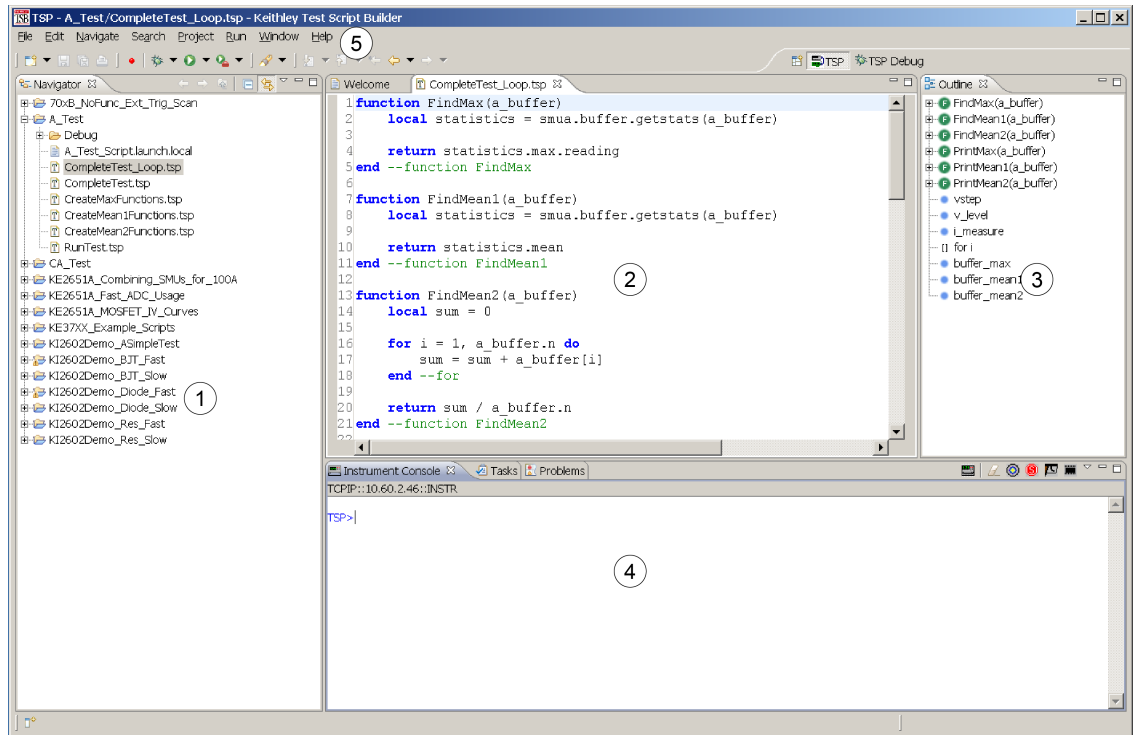

Item	Description
1	Project navigator
2	Script editor; right-click to run the script that is displayed
3	Outline view
4	Programming interaction
5	Help; includes detailed information on using Test Script Builder

## Installing the TSB software

The installation files for the Test Script Builder software are available for download on the [Keithley Instruments support website](http://www.keithley.com/support) (<http://www.keithley.com/support>).

### To install the Test Script Builder (TSB) software:

1. Close all programs.
2. Download the installer to your computer and double-click the .exe file to start the installation.
3. Follow the on-screen instructions.

## Project navigator

The project navigator consists of project folders and the script files (.tsp) created for each project. Each project folder can have one or more script files.

To view the script files in a project folder, click the plus (+) next to the project folder. To hide the folder contents, click the minus (-) next to the project folder.

You can download a TSP project to the instrument and run it, or you can run it from the TSB interface.

## Script editor

The script editor is where you write, modify, and debug scripts.

To open and display a script file, double-click the file name in the project navigator. You can have multiple script files open in the script editor at the same time. Each open script file is displayed on a separate tab.

To display another script file that is already open, click the tab that contains the script in the script editor area.

## Programming interaction

This part of the workspace is where you interact with the scripts that you are building in Test Script Builder (TSB). The actual contents of the programming interaction area of the workspace can vary.

You can send commands from the Instrument Console command line, retrieve data, view variables and errors, and view and set breakpoints when using the debug feature.

## Advanced scripting for TSP

The following topics describe advanced information that can help you understand how the Test Script Processor (TSP<sup>®</sup>) scripting engine works.

### Global variables and the script.user.scripts table

When working with script commands, it is helpful to understand how scripts are handled in the instrument.

Scripts are loaded into the run-time environment from nonvolatile memory when you turn the instrument on. They are also added to the run-time environment when you load them into the instrument.

A script in the run-time environment can be:

- A named script
- An unnamed script
- The anonymous script (which is a special unnamed script)



Script names can be assigned by using the `loadscript` command or by defining the `scriptVar` parameter of the `script.new()` function. When a named script is loaded into the run-time environment:

- A global variable with the same name is created so that you can reference the script more conveniently.
- An entry for the script is added to the `script.user.scripts` table.

When you create a script using the `script.new()` function without providing a name, the script is added to the run-time environment as an unnamed script. The `script.new()` function returns the script, but the script is not added to the `script.user.scripts` table.

When the anonymous script is loaded, it does not have a global variable or an entry in the `script.user.scripts` table. If there is an existing anonymous script, it is replaced by the new one.

When the instrument is turned off, everything in the run-time environment is deleted, including the scripts and global variables.

See the figure below to see how the scripts, global variables, and `script.user.scripts` table interrelate.

Figure 84: Global variables and scripts in the runtime environment

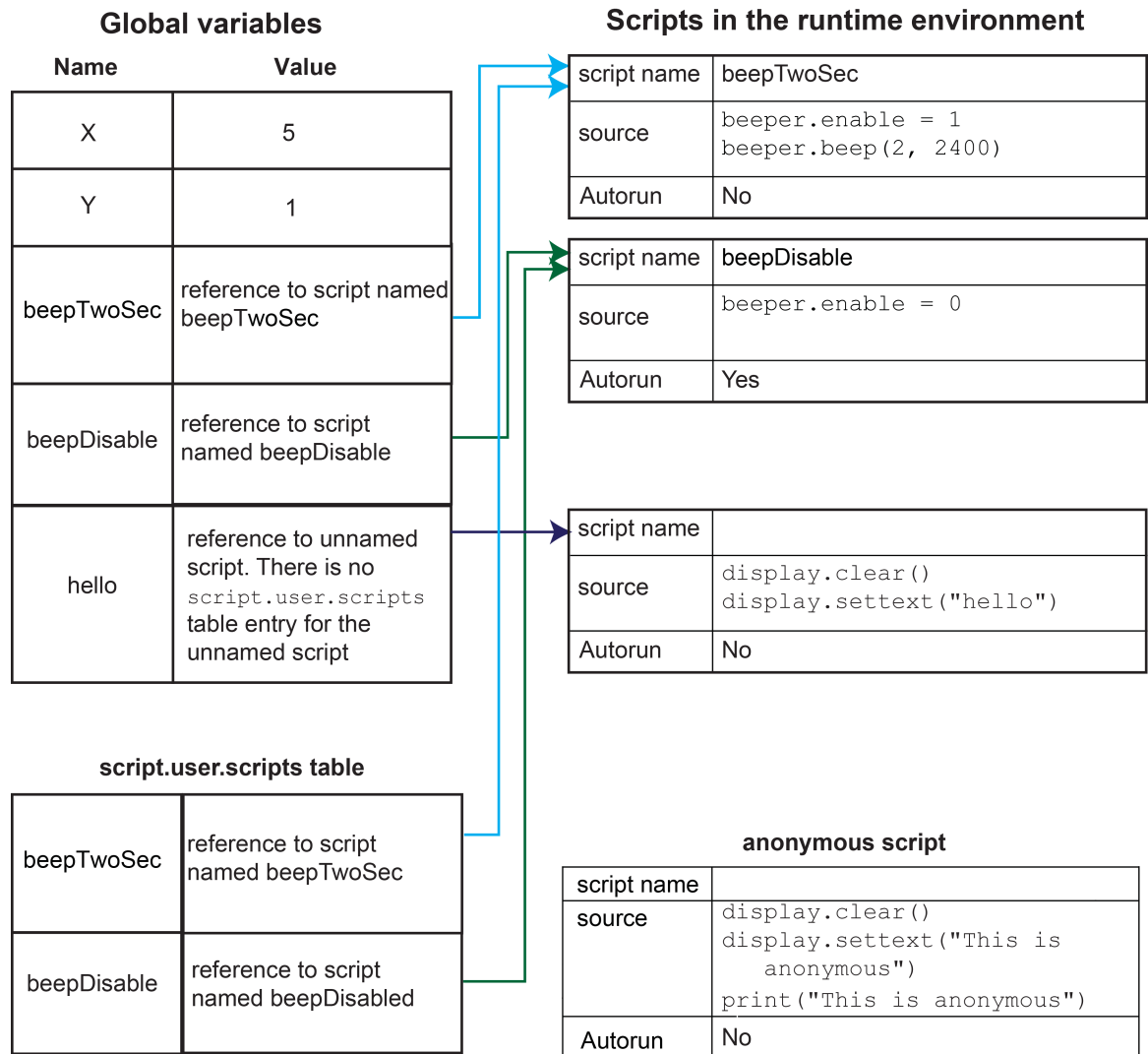

## Create a script using the `script.new()` command

Use the `script.new()` function to copy an existing script from the local node to a remote node. This enables parallel script execution.

You can create a script with the `script.new()` function using the command:

```
scriptVar = script.new(code, name)
```

Where:

`scriptVar` = Name of the variable created when the script is loaded into the run-time environment  
`code` = Content of the script  
`name` = Name that is added to the `script.user.scripts` table

For example, to set up a two-second beep, you can send the command:

```
beepTwoSec = script.new("beeper.enable = 1 beeper.beep(2, 2400)", "beepTwoSec")
```

To run the new script, send the command:

```
beepTwoSec()
```

When you add `beepTwoSec`, the global variable and `script.user.scripts` table entries are made to the run-time environment as shown in the following figure.

**Figure 85: Runtime environment after creating a script**

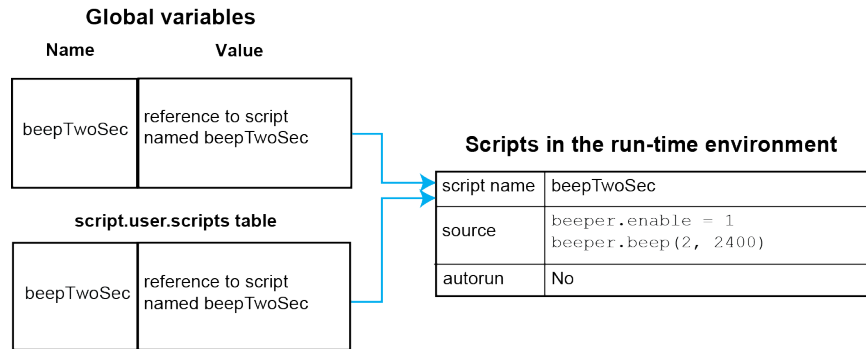

**Create an unnamed script using script.new()**

**NOTE**

Unnamed scripts are not available from the front-panel display of the instrument. Only the anonymous script and named scripts are available from the front-panel display.

When you create a script using `script.new()`, if you do not include `name`, the script is added to the run-time environment as an unnamed script. The `script.new()` function returns the script. You can assign it to a global variable, a local variable, or ignore the return value. A global variable is not automatically created.

For example, send the following command:

```
hello = script.new('display.clear() display.settext("hello")')
```

A script is created in the run-time environment and a global variable is created that references the script.

To run the script, send the command:

```
hello()
```

**Figure 86: Create an unnamed script**

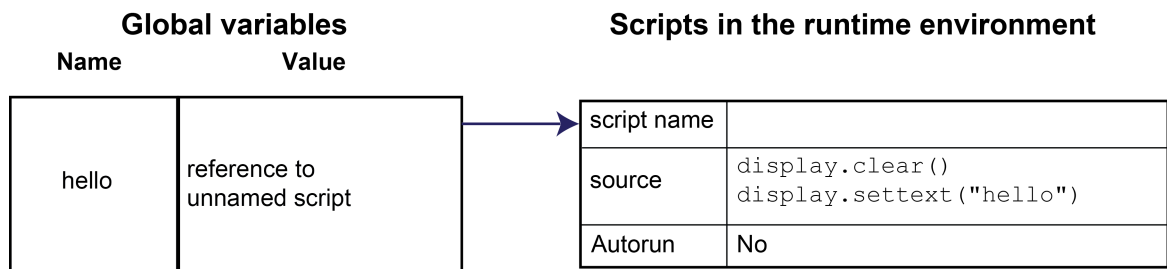

A script will become unnamed if you create a new script with the same name. In this circumstance, the name of the script in the `script.user.scripts` table is set to an empty string before it is replaced by the new script.

For example, if `beepTwoSec` already exists in the `script.user.scripts` table and you sent:

```
beepTwoSec1200 = script.new("beeper.enable = 1 beeper.beep(2, 1200)", "beepTwoSec")
```

The following actions occur:

- `beepTwoSec1200` is added as a global variable.
- The script that was in the run-time environment as `beepTwoSec` is changed to an unnamed script (the name attribute is set to an empty string).
- The global variable `beepTwoSec` remains in the run-time environment unchanged (it points to the now unnamed script).
- A new script named `beepTwoSec` is added to the run-time environment.

In this example, you can access the new script by sending either of the following commands:

```
beepTwoSec1200()
script.user.scripts.beepTwoSec()
```

To access the unnamed script, you can send the command:

```
beepTwoSec()
```

**Figure 87: Create a new script with the name of an existing script**

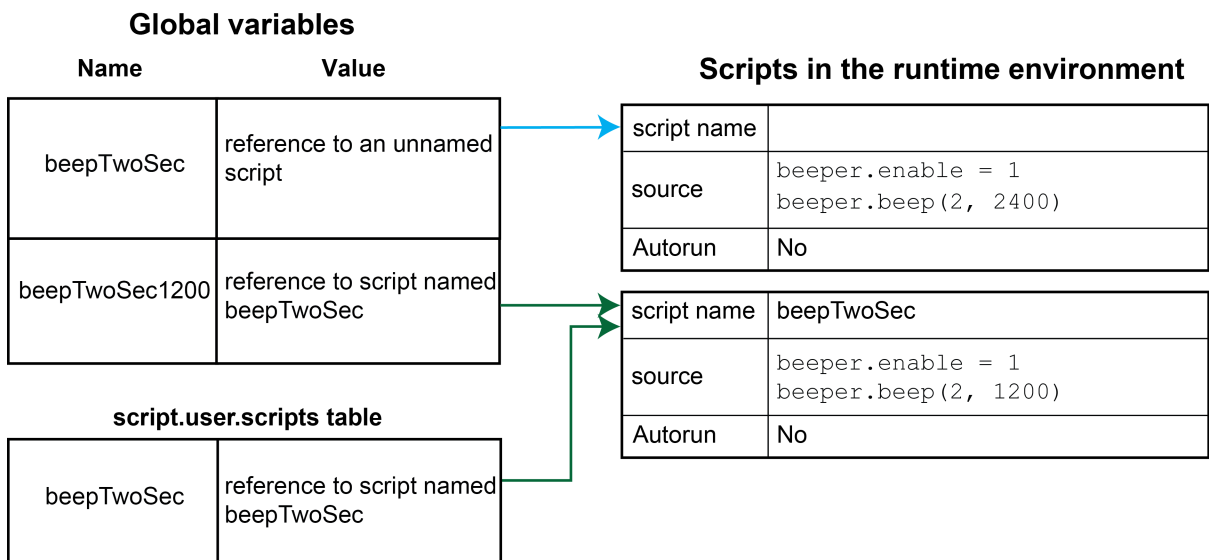

Note that the `script.user.scripts` table entry referencing `beepTwoSec` was removed and a new entry for `beepTwoSec` has been added

## Rename a script

You can rename a script. You might want to rename a script if you need to name another script the same name as the existing script. You could also rename an existing script to be the autoexec script.

To change the name of a script, use the command:

```
scriptVar.name = "renamedScript"
```

Where:

`scriptVar` = The global variable name  
`"renamedScript"` = The new name of the user script that was referenced by the `scriptVar` global variable

After changing the name, you need to save the original script to save the change to the name attribute.

For example:

```
beepTwoSec.name = "beep2sec"  
beepTwoSec.save()
```

Run the `beep2sec` script using the following command:

```
script.user.scripts.beep2sec()
```

## NOTE

If the new name is the same as a name that is already used for a script, the name of the existing script is removed and that script becomes unnamed. This removes the existing script if there are no other variables that reference the previous script. If variables do reference the existing script, the references remain intact.

Changing the name of a script does not change the name of any variables that reference that script. After changing the name, the script is located in the `script.user.scripts` table under its new name.

**Figure 88: Rename script**

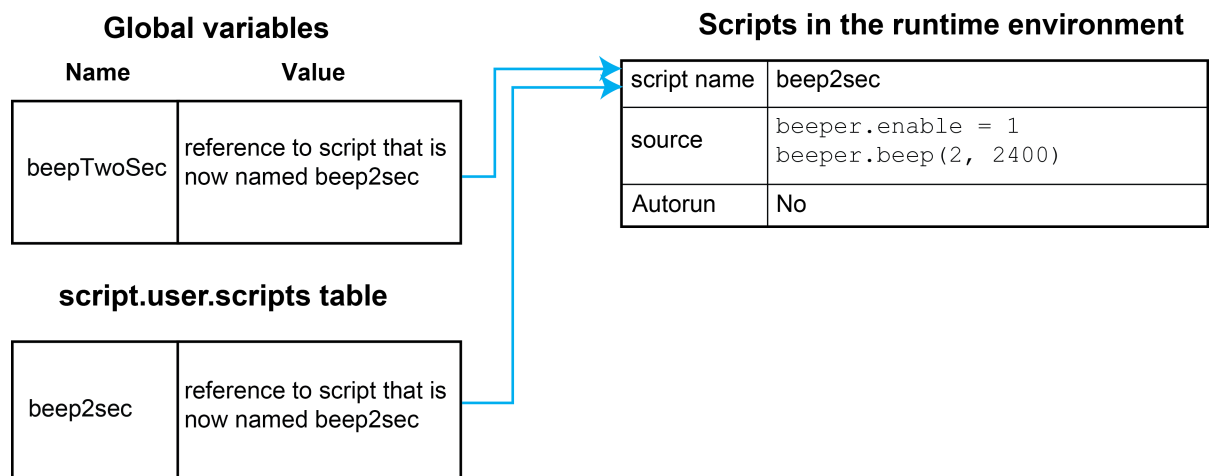

For example, to change the name of the script named `test2` to be `autoexec`:

```
test2.name = "autoexec"  
test2.save()
```

The `autoexec` script runs automatically when the instrument is turned on. It runs after all the scripts have loaded and any scripts marked as `autorun` have run.

**NOTE**

You can also use the `script.new()` and the `scriptVar.source` attribute commands to create a script with a new name. For example, if you had an existing script named `test1`, you could create a new script named `test2` by sending the command:

```
test2 = script.new(test1.source, "test2")
```

See [script.new\(\)](#) (on page 7-156).

**Retrieve a user script**

There are several ways to retrieve the source code of a user script:

- One line at a time: Use `scriptVar.list()` to retrieve the source code one line at a time
- Entire script: Use the `print(scriptVar.source)` command to retrieve the script source code as a single string
- Use TSB Embedded

See [Create and load a script](#) (on page 6-3) for information about recreating the script and loading it back into the instrument.

**NOTE**

To get a list of scripts that are in nonvolatile memory, use the [script.user.catalog\(\)](#) (on page 7-160) function.

**Retrieve source code one line at a time**

To retrieve the source code one line at a time, send the `scriptVar.list()` command. When this command is received, the instrument sends the entire script. Each line of the script is sent as a separate response message. The output includes the `loadscript` or `loadandrunscript` and `endscript` keywords.

After retrieving the source code, you can modify and save the command lines as a user script under the same name or a new name.

To retrieve the source code of a script one line at a time, send the command:

```
scriptVar.list()
```

Where `scriptVar` is the name of the script.

**NOTE**

To retrieve the commands in the anonymous script, use `script.anonymous.list()`.

**Example: Retrieve source code one line at a time**

```
test.list()
```

```
Retrieve the source of a script named "test".
The output will look similar to:
loadscript test
display.clear()
display.settext("This is a test")
print("This is a test")
endscript
```

## Retrieve a script as a single string

---

To retrieve the entire user script source code as a single string, use the `scriptVar.source` attribute. The `loadscript` or `loadandrunscript` and `endscript` keywords are not included.

To retrieve the source code as a single string, send the command:

```
print(scriptVar.source)
```

Where `scriptVar` is the name of the script.

### Example: Retrieve the source code as a single string

```
print(test.source)
```

Retrieve the source of a script named "test".

Output might look similar to:

```
display.clear()
  display.settext("This is a
test") print("This is a
test")
```

## Retrieve a script using TSB Embedded

---

In TSB Embedded, from the User Scripts list, select the script you want to retrieve. The contents of the script are displayed.

### Script example: Retrieve the content of scripts

---

This set of examples:

- Retrieves the source of a script using `scriptVar.list()`
- Retrieves the source of a script using `scriptVar.source`

**Example: Retrieve the content of a script with scriptVar.list()**

```
test.list()
```

Request a listing of the source of `test`.  
An example of the possible instrument output is shown here (note that the `loadscript` and `endscript` commands are included).

Output:

```
loadscript scriptVarTest
listTones = {100, 400, 800}
for index in listTones do
    beeper.beep(.5, listTones[index])
end
endscript
```

**Example: Retrieve the content of a script with scriptVar.source**

```
print(test.source)
```

Request a listing of the source of the script named `test`. The `loadscript` and `endscript` commands are not included.

An example of the possible instrument output is:

```
listTones = {100, 400, 800}
for index in listTones do
    beeper.beep(.5, listTones[index])
end
```

## Delete user scripts from the instrument

In most circumstances, you can delete a script using `script.delete()` (as described in [Delete user scripts](#) (on page 6-8)), and then turn the instrument off and back on again. However, if you cannot turn the instrument off, you can use the following steps to completely remove a script from the instrument.

When you completely remove a script, you delete all references to the script from the run-time environment, the `script.user.scripts` table, and nonvolatile memory.

**To completely remove a script:**

1. **Remove the script from the run-time environment.** Set any variables that refer to the script to `nil` or assign the variables a different value. For example, to remove the script "beepTwoSec" from the run-time environment, send the following code:  

```
beepTwoSec = nil
```
2. **Remove the script from the script.user.scripts table.** Set the name attribute to an empty string (""). This makes the script nameless, but does not make the script become the anonymous script. For example, to remove the script named "beepTwoSec", send the following code:  

```
script.user.scripts.beepTwoSec.name = ""
```
3. **Remove the script from nonvolatile memory.** To delete the script from nonvolatile memory, send the command:  

```
script.delete("name")
```

Where `name` is the name that the script was saved as. For example, to delete "beepTwoSec", you would send:  

```
script.delete("beepTwoSec")
```



## Restore a script to the run-time environment

You can retrieve a script that was removed from the run-time environment but is still saved in nonvolatile memory.

To restore a script from nonvolatile memory into the run-time environment, you can use `script.restore("scriptName")`, where `scriptName` is the user-defined name of the script to be restored.

For example, to restore a user script named "test9" from nonvolatile memory:

```
script.restore("test9")
```

## Memory considerations for the run-time environment

The run-time environment has a fixed amount of memory for storing user scripts and other run-time information.

You can check the amount of memory in the instrument using the `memory.used()` and `memory.available()` functions. These functions return the percentage of memory that is used or available. When you send this command, memory used or available is returned as a comma-delimited string with percentages for used memory.

The format is `systemMemory, scriptMemory, patternMemory`, where:

- `systemMemory`: The percentage of memory used or available in the instrument
- `scriptMemory`: The percentage of memory used or available in the instrument to store user scripts
- `patternMemory`: The percentage of memory used or available in the instrument to store channel patterns

For example, if you send the command:

```
MemUsed = memory.used()  
print(MemUsed)
```

You will get back a value such as `69.14, 0.16, 12.74`, where `69.14` is the percentage of memory used in the instrument, `0.16` is the percentage used for script storage, and `12.74` is the percentage used for channel pattern storage.

See [memory.available\(\)](#) (on page 7-129) and [memory.used\(\)](#) (on page 7-130) for more detail on using these functions.

Some suggestions for increasing the available memory:

- Turn the instrument off and on. This deletes scripts that have not been saved and reloads only scripts that have been stored in nonvolatile memory.
- Remove unneeded scripts from nonvolatile memory. Scripts are loaded from nonvolatile memory into the run-time environment when the instrument is turned on. See [Delete user scripts from the instrument](#) (on page 6-41).
- Reduce the number of TSP-Link<sup>®</sup> nodes.
- Delete unneeded channel patterns (this affects only pattern memory, not instrument memory). See [Channel patterns](#) (on page 2-92).

- Delete unneeded global variables from the run-time environment by setting them to `nil`.
- Set the source attribute of all scripts to `nil`.
- Adjust the `collectgarbage()` settings in Lua. See [Lua memory management](#) (on page 6-26) for information.
- Review scripts to optimize their memory usage. In particular, you can see memory gains by changing string concatenation lines into a Lua table of string entries. You can then use the `table.concat()` function to create the final string concatenation.

The example below shows an example of optimizing a channel pattern that consists of five channels.

#### Example

String concatenation lines	Optimized with the <code>table.concat</code> function
<pre>testPattern = "1A03" testPattern = testPattern .. ",1B03" testPattern = testPattern .. ",1C03" testPattern = testPattern .. ",1D03" testPattern = testPattern .. ",1E03" print(testPattern)</pre>	<pre>testTable = { } testTable[1] = "1A03," testTable[2] = "1B03," testTable[3] = "1C03," testTable[4] = "1D03," testTable[5] = "1E03" testPattern = table.concat(testTable) print(testPattern)</pre>
<p>The output is: 1A03,1B03,1C03,1D03,1E03</p>	<p>The output is: 1A03,1B03,1C03,1D03,1E03</p>

### CAUTION

If the instrument encounters memory allocation errors when memory used is above 95 percent, the state of the instrument cannot be guaranteed. After attempting to save any important data, it is recommended that you turn off power to the instrument and turn it back on to return the instrument to a known state. Cycling power resets the run-time environment. Unsaved scripts and channel patterns will be lost.

## TSP-Link system and running simultaneous test scripts

### TSP-Link system

You can use the TSP-Link<sup>®</sup> expansion interface to expand your test system to include up to 32 addressable TSP<sup>®</sup> enabled instruments that use the TSP-LINK<sup>®</sup>. The expanded system can be stand-alone or computer-based.

**Stand-alone system:** You can run a script from the front panel of any instrument (node) connected to the system. When a script is run, all nodes in the system go into remote operation (REM indicators turn on). The node running the script becomes the master and can control all of the other nodes, which become its subordinates. When the script is finished running, all the nodes in the system return to local operation (REM indicators turn off), and the master/subordinate relationship between nodes is dissolved.

**Computer-based system:** You can use a computer and a LAN, GPIB, or RS-232 interface to any single node in the system. This node becomes the interface to the entire system. When a command is sent through this node, all nodes go into remote operation (REM indicators turn on). The node that receives the command becomes the master and can control all of the other nodes, which become its subordinates. In a computer-based system, the master/subordinate relationship between nodes can only be dissolved by performing an abort operation.

### TSP-Link nodes

Each instrument (node) attached to the TSP-Link<sup>®</sup> network must be identified by assigning it a unique TSP-Link node number.

Commands for remote nodes are stored in the `node` table. An individual node is accessed as `node[N]`, where `N` is the node number assigned to the node.

All TSP-accessible remote commands can be accessed as elements of the specific node. The following attributes are examples of items you can access:

- `node[N].model`: The product model number string of the node.
- `node[N].revision`: The product revision string of the node.
- `node[N].serialno`: The product serial number string of the node.

You do not need to know the node number of the node that is running a script. The variable `localnode` is an alias for the node entry of the node where the script is running. For example, if a script is running on node 5, you can use the global variable `localnode` as an alias for `node[5]`. With this in mind, to access the product model number for this example, use `localnode.model`.

### Connect the TSP-Link cable

Connect the TSP-Link connector to one of the TSP-Link connectors on the rear panel of the instrument.

The location of the TSP-Link connectors on the instrument are shown below.

# NOTE

For an example of setting up a TSP-Linked system, see "Working with a Series 2600A" in the Models 707B and 708B User's Manual.

Figure 89: Model 708B rear panel TSP-Link connection

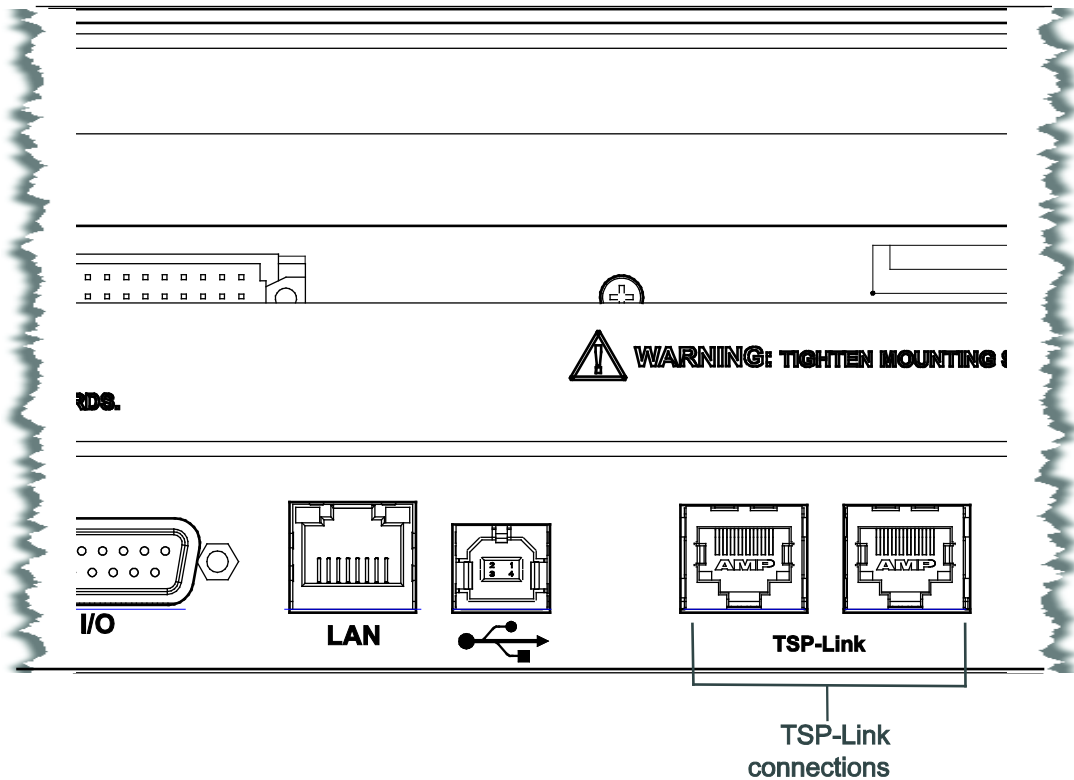
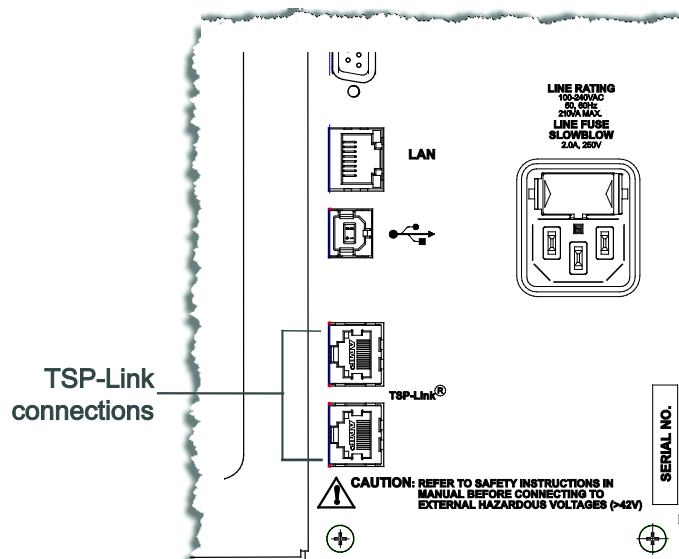

Figure 90: Model 707B rear panel TSP-Link connection



## Initialization

Before a TSP-Link® system can be used, it must be initialized. For initialization to succeed, each instrument in a TSP-Link system must be assigned a different node number.

### Assigning node numbers

---

At the factory, each Models 707B and 708B instrument is assigned as node 1. The node number for each instrument is stored in its nonvolatile memory and remains in storage when the instrument is turned off. You can assign a node number to a Models 707B and 708B using the front panel or by using a remote command. Note that there can only be 32 physical nodes, but you can assign node numbers from 1 to 64.

#### *To assign a node number from the front panel of the instrument:*

1. Press the **MENU** key, then select **TSPLINK > NODE**.
2. Press the navigation wheel  and select the desired number.
3. Press the **ENTER** key to save the node number.

#### *To assign a node number using a remote command:*

Set the `tsplink.node` attribute of the instrument:

```
tsplink.node = N
```

Where:  $N = 1$  to 64

To determine the node number of an instrument, you can read the `tsplink.node` attribute by sending the following command:

```
print(tsplink.node)
```

The above `print` command outputs the node number. For example, if the node number is 1, a 1 is displayed.

### Remote programming

The `tsplink.node` attribute is used to set the node number for an instrument:

```
tsplink.node = N
```

Where:  $N = 1$  to 64

The node number of an instrument can be determined by reading the `tsplink.node` attribute as follows:

```
print(tsplink.node)
```

The above `print` command will output the node number. For example, if the node number is 1, the value `1.000000e+00` will be displayed.

### Resetting the TSP-Link network

---

After all the node numbers are set, you must initialize the system by performing a TSP-Link® network reset.

## NOTE

If you change the system configuration after initialization, you must reinitialize the system by performing a TSP-Link network reset. Changes that require that you reinitialize the TSP-Link network include turning off power or rebooting any instrument in the system, or rearranging or disconnecting the TSP-Link cable connections between instruments.

### Front panel operation

*To reset the TSP-Link® network from the front panel:*

1. Power on all instruments connected to the TSP-Link network.
2. Press the **MENU** key, select **TSPLINK**, and then press the **ENTER** key.
3. Turn the navigation wheel  to select **RESET**, and then press the **ENTER** key.

### Remote programming

The commands associated with the TSP-Link® system reset are listed in the following table.

#### TSP-Link reset commands

Command	Description
<code>tsplink.reset()</code>	Initializes the TSP-Link network
<code>tsplink.state</code>	Reads the state of the TSP-Link network: <ul style="list-style-type: none"> <li>• “online” if the most recent TSP-Link reset was successful</li> <li>• “offline” if the reset operation failed</li> </ul>

An attempted TSP-Link reset operation will fail if any of the following conditions are true:

- Two or more instruments in the system have the same node number
- There are no other instruments connected to the instrument performing the reset (only if the expected number of nodes was not provided in the reset call)
- One or more of the instruments in the system is turned off
- If the actual number of nodes is less than the expected number

The programming example below illustrates a TSP-Link reset operation and displays its state:

```
tsplink.reset()
print(tsplink.state)
```

If the reset operation is successful, `online` is output to indicate that communications with all nodes have been established.

## Using TSP to run test scripts simultaneously

You can use TSP to run test scripts simultaneously on multiple nodes on the TSP-Link network. Running test scripts simultaneously improves functional testing, provides higher throughput, and expands system flexibility.

You can also use TSP to manage the resources that are allocated to the test scripts that are running simultaneously, and to use the data queue to facilitate real-time communication between nodes.

There are two methods you can use to run test scripts in parallel:

- Create multiple TSP-Link networks
- Use a single TSP-Link network with groups

The following table describes the functions of a single TSP-Link network. Each group in this example runs multiple test scripts at the same time or in parallel.

TSP-Link network group functions		
Group number	Group members	Current function
0	Master node	<ul style="list-style-type: none"> <li>• Initiates and runs a test script on Node 2</li> <li>• Initiates and runs a test script on Node 5</li> <li>• Initiates and runs a test script on Node 6</li> </ul>
1	Group leader Node 2	<ul style="list-style-type: none"> <li>• Runs the test script initiated by the master node</li> <li>• Initiates remote operations on Node 3</li> </ul>
	Node 3	<ul style="list-style-type: none"> <li>• Performs remote operations initiated by Node 2</li> </ul>
2	Group leader Node 5	<ul style="list-style-type: none"> <li>• Runs the test script initiated by the master node</li> <li>• Initiates remote operations on Node 4</li> </ul>
	Node 4	<ul style="list-style-type: none"> <li>• Performs remote operations initiated by Node 5</li> </ul>
3	Group leader Node 6	<ul style="list-style-type: none"> <li>• Runs the test script initiated by the master node</li> </ul>

TSP-Link has three synchronization lines that function similarly to the digital I/O synchronization lines. See [Digital I/O](#) (on page 5-8) and [Hardware trigger modes](#) (on page 3-13) for more detailed information.

## Using groups to manage nodes on TSP-Link network

The primary purpose of groups is to allow each group to run a different test script simultaneously.

A group can consist of one or more nodes. You must assign group numbers to each node using remote commands. If you do not assign a node to a group, it defaults to group 0, which will always be grouped with the master node (regardless of the group to which the master node is assigned).

### Master node overview

You can assign the master node to any group. You can also include other nodes in the group that includes the master. Note that any nodes that are set to group 0 are automatically included in the group that contains the master node, regardless of the group that is assigned to the master node.

The master node is always the node that coordinates activity on the TSP-Link network.

The master node:

- Is the only node that can use the `execute()` command on a remote node
- Cannot initiate remote operations on any node in a remote group if any node in that remote group is performing an overlapped operation (a command that continues to operate after the command that initiated it has finished running)
- Can execute the `waitcomplete()` command to wait for the group to which the master node belongs; to wait for another group; or to wait for all nodes on the TSP-Link network to complete overlapped operations (overlapped commands allow the execution of subsequent commands while device operations of the overlapped command are still in progress)

### Group leader overview

Each group has a dynamic group leader. The last node in a group running any operation initiated by the master node is the group leader.

The following list describes the functionality of the group leader:

- Runs operations initiated by the master node
- Initiates remote operations on any node with the same group number
- Cannot initiate remote operations on any node with a different group number
- Can send the `waitcomplete` command without a parameter to wait for all nodes assigned to the same group number

### Assigning groups

Group numbers can range from zero (0) to 64. The default group number is 0. You can change the group number at any time. You can also add or remove a node to or from a group at any time.

Each time the power for a node is turned off, the group number for that node changes to 0.

The following example code dynamically assigns a node to a group:

```
-- Assign node 3 to group 1.  
node[3].tsplink.group = 1
```

### Running simultaneous test scripts

You can send the `execute()` command from the master node to initiate a test script and Lua code on a remote node. The `execute()` command places the remote node in the overlapped operation state. As a test script runs on the remote node, the master node continues to process other commands simultaneously.

Use the following code to send the `execute()` command for a remote node. The *N* parameter represents the node number that runs the test script (replace *N* with the node number).

**To set the global variable "setpoint" on node *N* to 2.5:**

```
node[N].execute("setpoint = 2.5")
```



The following code demonstrates how to run a test script that is defined on the local node. For this example, *scriptVar* is defined on the local node, which is the node that initiates the code to run on the remote node. The local node must be the master node.

**To run *scriptVar* on node *N*:**

```
node[N].execute(scriptVar.source)
```

The programming example below demonstrates how to run a test script that is defined on a remote node. For this example, *scriptVar* is defined on the remote node.

**To run a script defined on the remote node:**

```
node[N].execute("scriptVar()")
```

It is recommended that you copy large scripts to a remote node to improve system performance. See [Copying test scripts across the TSP-Link network](#) (on page 6-51) for more information.

### Coordinating overlapped operations in remote groups

All overlapped operations on all nodes in a group must have completed before the master node can send a command to the group. If you send a command to a node in a remote group when an overlapped operation is running on any node in that group, errors will occur.

You can execute the `waitcomplete()` command on the master node or group leader to wait for overlapped operations. The action of `waitcomplete()` depends on the parameters specified.

If you want to wait for completion of overlapped operations for:

- **All nodes in the local group:** Use `waitcomplete()` without a parameter from the master node or group leader.
- **A specific group:** Use `waitcomplete(N)` with a group number as the parameter from the master node. This option is not available for group leaders.
- **All nodes in the system:** Use `waitcomplete(0)` from the master node. This option is not available for group leaders.

For additional information, refer to [waitcomplete\(\)](#) (on page 7-242).

The following code shows two examples of using the `waitcomplete()` command from the master node:

```
-- Wait for each node in group N to complete all overlapped operations.
waitcomplete(N)
-- Wait for all groups on the TSP-Link network to complete overlapped operations.
waitcomplete(0)
```

A group leader can issue the `waitcomplete()` command to wait for the local group to complete all overlapped operations.

The following code is an example of how to use the `waitcomplete()` command from a group leader:

```
-- Wait for all nodes in the local group to complete all overlapped operations.
waitcomplete()
```

## NOTE

Presently, the Models 707B and 708B have no overlapped commands implemented. However, other TSP-enabled products, such as the Series 2600A System SourceMeter® Instruments, have overlapped commands. Therefore, when the Model 707B or 708B is a TSP master to a subordinate device with overlapped commands, use this function to wait until all overlapped operations are completed.

## Using the data queue for real-time communication

Nodes that are running test scripts at the same time can store data in the data queue for real-time communication. Each instrument has an internal data queue that uses the first-in, first-out (FIFO) structure to store data. You can use the data queue to post numeric values, strings, and tables.

Use the data queue commands to:

- Share data between test scripts running in parallel
- Access data from a remote group or a local node on a TSP-Link® network at any time

You cannot access the reading buffers or global variables from any node in a remote group while a node in that group is performing an overlapped operation. However, you can use the data queue to retrieve data from any node in a group that is performing an overlapped operation. In addition, the master node and the group leaders can use the data queue as a way to coordinate activities.

Tables in the data queue consume one entry. When a node stores a table in the data queue, a copy of the data in the table is made. When the data is retrieved from the data queue, a new table is created on the node that is retrieving the data. The new table contains a completely separate copy of the data in the original table, with no references to the original table or any subtables.

You can access data from the data queue even if a remote group or a node has overlapped operations in process. See the `dataqueue` commands in the [TSP command reference](#) (on page 7-1) for more information.

## Copying test scripts across the TSP-Link network

To run a large script on a remote node, copy the test script to the remote node to increase the speed of test script initiation.

The code in the example below copies a test script across the TSP-Link® network, creating a copy of the script on the remote node with the same name.

```
-- Add the source code from the script
-- testScript to the data queue.
node[2].dataqueue.add(testScript.source)
-- Create a new script on the remote node
-- using the source code from testScript.
node[2].execute(testScript.name ..
    "= script.new(dataqueue.next(), [{" .. testScript.name .. "}]")
```

## Removing stale values from the reading buffer cache

---

The node that acquires the data also stores the data for the reading buffer. To optimize data access, all nodes can cache data from the node that stores the reading buffer data.

When you run Lua code remotely, it can cause reading buffer data that is held in the cache to become stale. If the values in the reading buffer change while the Lua code runs remotely, another node can hold stale values. Use the `clearcache()` command to clear the cache.

The following example code demonstrates how stale values occur and how to use the `clearcache()` command to clear the cache on node 2, which is part of group 7.

## TSP-Net

### Overview

TSP-Net allows the Model 707B or 708B to control Ethernet-enabled devices directly through its LAN port. This enables the Model 707B or 708B to communicate directly with a device that is not TSP®-enabled without the use of a controlling computer.

### TSP-Net Capabilities

For both Test Script Processor (TSP®) and non-TSP devices, the TSP-Net® library permits the Model 707B or 708B to control a remote device through the LAN port. Using TSP-Net methods, you can transfer string data to and from a remote device, transfer and format data into Lua variables, and clear input buffers. TSP-Net is only accessible using Instrument Control Library (ICL) commands from a remote command interface and is not available from the front panel.

You can use TSP-Net to communicate with any Ethernet-enabled device. However, specific TSP-Net commands exist for TSP-enabled devices to allow for support of features unique to TSP. These features include script downloads, reading buffer access, wait completion, and handling of TSP prompts.

Using TSP-Net with TSP-enabled instruments, a Model 707B or 708B can download a script to another TSP-enabled device and have both devices run scripts independently. The Model 707B or 708B can read the data from the remote device and either manipulate the data or send the data to a different remote device on the LAN. You can simultaneously connect to a maximum of 32 devices using standard TCP/IP networking techniques through the LAN port of the Model 707B or 708B.

## Using TSP-Net with any Ethernet-enabled device

### NOTE

Refer to TSP commands for more details about the commands presented in this section.

**To communicate to a remote ethernet-enabled device from the Model 707B or 708B, perform the following steps:**

1. Connect to the remote device through the LAN port. If you are connecting:
  - Directly from the Model 707B or 708B to an ethernet-enabled device: Use an ethernet crossover cable.
  - The Model 707B or 708B to any other device on the LAN: Use a straight-through ethernet cable and a hub.
2. Establish a new connection to a remote device at a specific IP address using `tspnet.connect()`.
3. If the device is not TSP-enabled, you must also provide the port number. If not, the Model 707B or 708B assumes the remote device is TSP-enabled and enables TSP prompts and error handling.

If the Model 707B or 708B is not able to make a connection to the remote device, it generates a timeout error. Use `tspnet.timeout` to set the timeout value. The default timeout value is 20 seconds.

### NOTE

Set `tspnet.tsp.abortonconnect` to 1 to abort any script currently running on a remote TSP device.

4. Use `tspnet.write()` or `tspnet.execute()` to send strings to a remote device. `tspnet.write()` sends strings to the device exactly as indicated, and you must supply any needed termination characters or other lines. Use `tspnet.termination()` to specify the termination character. If you use `tspnet.execute()` (on page 7-231) instead, the Model 707B or 708B appends termination characters to all strings sent to the command.
5. Retrieve responses from the remote device using `tspnet.read()`. The Model 707B or 708B suspends operation until data is available or a timeout error is generated. You can check if data is available from the remote device using `tspnet.readavailable()`.

Disconnect from the remote device using `tspnet.disconnect()`. Terminate all remote connections using `tspnet.reset()`.

### Example script

The following example demonstrates how to connect to a remote device that is not Test Script Processor (TSP<sup>®</sup>) enabled, and send and receive data from this device:

```
-- Disconnect all existing TSP-Net connections.
tspnet.reset()
-- Set tspnet timeout to 5 seconds.
tspnet.timeout = 5
-- Establish connection to another device with
-- IP address 192.168.1.51 at port 1394.
id_instr = tspnet.connect("192.168.1.51",1394, "*rst\r\n")
```

```
-- Print the device ID from connect string.
print("ID is: ", id_instr)
-- Set termination character to CRLF. You must do this
-- on a per connection basis after connection has been made.
tspnet.termination(id_instr, tspnet.TERM_CRLF)
-- Send the command string to the connected device
tspnet.write(id_instr, "*idn?" .. "\r\n")
-- Read the data available, then prints it.
print("instrument write/read returns: ", tspnet.read(id_instr))
-- Disconnect all existing TSP-Net sessions.
tspnet.reset()
```

## TSP-Net compared to TSP-Link to communicate with TSP-enabled devices

The TSP-Link<sup>®</sup> network interface is the preferred communication method for most applications where communication occurs between the Model 707B or 708B and another TSP-enabled instrument.

One of the advantages of using the TSP-Link network interface is that TSP-Link connections have three synchronization lines that are available to each device on the TSP-Link network. You can use any one of the synchronization lines to perform hardware triggering between devices on the TSP-Link network. Refer to [Hardware trigger modes](#) (on page 3-13) for details.

However, if the distance between the Model 707B or 708B and the TSP-enabled device is longer than 15 feet, use TSP-Net commands.

## TSP-Net instrument commands: General device control

The following instrument commands provide general device control:

- [tspnet.clear\(\)](#) (on page 7-228)
- [tspnet.connect\(\)](#) (on page 7-229)
- [tspnet.disconnect\(\)](#) (on page 7-230)
- [tspnet.execute\(\)](#) (on page 7-231)
- [tspnet.idn\(\)](#) (on page 7-232)
- [tspnet.read\(\)](#) (on page 7-232)
- [tspnet.readavailable\(\)](#) (on page 7-233)
- [tspnet.reset\(\)](#) (on page 7-234)
- [tspnet.termination\(\)](#) (on page 7-234)
- [tspnet.timeout](#) (on page 7-235)
- [tspnet.write\(\)](#) (on page 7-239)

## TSP-Net instrument commands: TSP-enabled device control

The following instrument commands provide TSP-enabled device control:

- [tspnet.tsp.abort\(\)](#) (on page 7-236)
- [tspnet.tsp.abortonconnect](#) (on page 7-236)
- [tspnet.tsp.rtablecopy\(\)](#) (on page 7-237)
- [tspnet.tsp.runscript\(\)](#) (on page 7-238)

## Example: Using tspnet commands

```

function telnetConnect(ipAddress, userName, password)
-- Connect through Telnet to a computer.
id = tspnet.connect(ipAddress, 23, "")
-- Read the title and login prompt from the computer.
print(string.format("from computer--> (%s)", tspnet.read(id, "%n")))
print(string.format("from computer--> (%s)", tspnet.read(id, "%s")))
-- Send the login name.
tspnet.write(id, userName .. "\r\n")
-- Read the login echo and password prompt from the computer.
print(string.format("from computer--> (%s)", tspnet.read(id, "%s")))
-- Send the password information.
tspnet.write(id, password .. "\r\n")
-- Read the telnet banner from the computer.
print(string.format("from computer--> (%s)", tspnet.read(id, "%n")))
print(string.format("from computer--> (%s)", tspnet.read(id, "%n")))
print(string.format("from computer--> (%s)", tspnet.read(id, "%n")))
print(string.format("from computer--> (%s)", tspnet.read(id, "%n")))
end

function test_tspnet()
tspnet.reset()
-- Connect to a computer using Telnet.
telnetConnect("192.0.2.1", "my_username", "my_password")
-- Read the prompt back from the computer.
print(string.format("from computer--> (%s)", tspnet.read(id, "%n")))
-- Change directory and read the prompt back from the computer.
tspnet.write(id, "cd c:\\\r\n")
print(string.format("from computer--> (%s)", tspnet.read(id, "%s")))
-- Make a directory and read the prompt back from the computer.
tspnet.write(id, "mkdir TEST_TSP\r\n")
print(string.format("from computer--> (%s)", tspnet.read(id, "%s")))
-- Change to the newly created directory.
tspnet.write(id, "cd c:\\TEST_TSP\r\n")
print(string.format("from computer--> (%s)", tspnet.read(id, "%s")))
-- if you have data print it to the file.
-- 11.2 is an example of data collected.
cmd = "echo " .. string.format("%g", 11.2) .. " >> datafile.dat\r\n"
tspnet.write(id, cmd)
print(string.format("from computer--> (%s)", tspnet.read(id, "%s")))
tspnet.disconnect(id)
end
test_tspnet()

```



---

## TSP command reference

### In this section:

---

Command programming notes.....	7-1
Using the TSP command reference .....	7-4
Instrument Control Library (ICL) command reference .....	7-8

## Command programming notes

### Placeholder text

This manual uses italicized text to represent the parts of remote commands that must be replaced by user specified values. The following examples show typical uses of italicized text:

#### Example 1:

```
gpib.address = address
```

Where:

*address* is an integer (0 to 30) that you specify. For example, to set this attribute to 15 you would send:

```
gpib.address = 15
```

#### Example 2:

```
digio.trigger[N].assert()
```

Where:

*N* is an integer (1 to 14) that you specify. For example, to assert trigger line 7 you would send:

```
digio.trigger[7].assert()
```

To assert a trigger line with a variable as the integer, you would send:

```
triggerline = 7
```

```
digio.trigger[triggerline].assert()
```

#### Example 3:

The attribute returns a string containing information about a card in a specified slot is shown as:

```
slot[X].idn
```

For example, to get information about the card installed in slot 1, you would send:

```
print(slot[1].idn)
```



## Syntax rules

The following table lists syntax requirements to build well-formed instrument control commands.

### Syntax rules for instrument commands

Syntax rule	Details	Examples
<b>Case sensitivity:</b> Instrument commands are case sensitive.  Match the case shown in the command reference descriptions.	Function and attribute names should be in lowercase characters.	An example of the <code>scriptVar.save()</code> function (where <code>test8</code> is the name of the script): <code>test8.save()</code>
	Parameters can use a combination of lowercase and uppercase characters.  Attribute constants use uppercase characters	In the command below, which sets the format of data transmitted from the instrument to double-precision floating point, <code>format.REAL64</code> is the attribute constant and <code>format.data</code> is the attribute command: <code>format.data = format.REAL64</code>
<b>White space:</b> Not required in a function.	Functions can be sent with or without white spaces.	The following functions, which set digital I/O line 3 low, are equivalent: <code>digio.writebit(3,0)</code> <code>digio.writebit (3, 0)</code>
<b>Function parameters:</b> All functions are required to have a set of parentheses () immediately following the function.	You can specify the function parameters by placing them between the parentheses. Note that the parentheses are required even when there are no parameters specified.	The following function specifies all overlapped commands in the nodes in group G that must complete before commands from other groups can execute: <code>waitcomplete(G)</code>  The command below reads the value of the local time zone (no parameters are needed): <code>timezone = gettimezone()</code>
<b>Multiple parameters:</b> Must be separated by commas (,).	Some commands require multiple parameters, which must be separated by commas (,).	This command sets the beeper to emit a double-beep at 2400 Hz, with a beep sequence of 0.5 seconds on, 0.25 seconds off, and then 0.5 seconds on: <code>beeper.beep(0.5, 2400)</code> <code>delay(0.250)</code> <code>beeper.beep(0.5, 2400)</code>
<b>Parameter range:</b> Range values must be separated with a colon (:).	Place a colon (:) between two values to specify a range in a parameter.	The command below replaces the active scan list with an empty scan list, and then adds channels in row 1, columns 1 through 10, on slot 1: <code>scan.create("1A01:1A10")</code>

## Logical instruments

You would normally refer to all instrumentation in one enclosure or node as a single instrument. In the context of Test Script Processor (TSP<sup>®</sup>) scripting engine and instrument commands, it is useful to think of each individual subdivision in an enclosure, such as a card slot or the channels, as a stand-alone instrument. To avoid confusion, all subdivisions of the instrumentation in an enclosure are referred to as "logical instruments."

Each logical instrument is given a unique identifier in a system. These identifiers are used as part of all commands that control a given logical instrument.

The logical instruments are:

- beeper
- bit
- channel
- dataqueue
- digio
- display
- eventlog
- errorqueue
- format
- gpib
- lan
- memory
- scan
- slot
- status
- timer
- trigger
- tsplink
- tspnet
- userstring

### NOTE

Do not create variable names that are the same as names of logical instruments. Doing so will result in the loss of use of the logical instrument and its associated commands. For example, if you send the command `digio = 5`, you cannot access the `digio.*` commands until you turn off the power to the instrument, and then turn it on again.

## Time and date values

Time and date values are represented as the number of seconds since some base. Representing time as a number of seconds is referred to as "standard time format." There are three time bases:

- **UTC 12:00 am Jan 1, 1970.** Some examples of UTC time are reading buffer base timestamps, adjustment dates, and the value returned by `os.time()`.
- **Instrument on.** References time to when the instrument was turned on. The value returned by `os.clock()` is referenced to the turn-on time.
- **Event.** Time referenced to an event, such as the first reading stored in a reading buffer.

## Using the TSP command reference

The TSP command reference contains detailed descriptions of each of the TSP commands that you can use to control your instrument. Each command description is broken into subsections. The figure below shows an example of a command description.

**Figure 91: Example instrument command description**

**beeper.enable**

This attribute allows you to turn the beeper on or off.

Type	TSP-Link accessible	Affected by	Where saved	Default value
Attribute (RW)	Yes	Recall setup Instrument reset	Saved setup Create configuration script	1 (beeper.ON)

**Usage**

```
state = beeper.enable
beeper.enable = state
```

```
state beeper.OFF or 0: Beeper disabled
state beeper.ON or 1: Beeper enabled
```

**Details**

Disabling the beeper also disables front panel key clicks.

**Example**

```
beeper.enable = beeper.ON
beeper.beep(2, 2400)
```

Enables the beeper and generates a two-second, 2400 Hz tone

**Also see**

[beeper.beep\(\)](#) (on page 8-10)

The subsections contain information about the command. The subsections are:

- Command name and summary table
- Usage
- Details
- Example
- Also see

The content of each of these subsections is described in the following topics.

## Command name and standard parameters summary

Each instrument command description starts with the command name, followed by a table with relevant information for each command. Definitions for the numbered items in the figure below are listed following the figure.

1. **Instrument command name.** Signals the beginning of the command description and is followed by a brief description of what the command does.
2. **Type of command.** Options are:
  - **Function.** Function-based commands control actions or activities, but are not always directly related to instrument operation. Function names are always followed by a set of parentheses, for example, `digio.writeport(15)`. If the function does not need a parameter, the parentheses set remains empty, for example, `exit()`.
  - **Attribute (R), (RW), or (W).** Attribute-based commands set or read the characteristics of an instrument feature or operation by defining a value. For example, a characteristic of a TSP-enabled instrument is the model number (`localnode.model`); another characteristic is the number of errors in the error queue (`errorqueue.count`). For many attributes, the defined value is a number or predefined constant. Attributes can be read-only (R), read-write (RW), or write-only (W), and can be used as a parameter of a function or assigned to another variable.
  - **Constant.** A constant command represents a fixed value when used in a script.

3. **TSP-Link accessible. Yes or No;** indicates whether or not the command can accessed through a TSP-Link network.
4. **Affected by.** Commands or actions that have a direct effect on the instrument command.
  - **LAN restore defaults**
  - **Reset:** This command has varied effects depending on how it is used. Reset actions include:
    - Channel reset
    - Digital I/O trigger reset
    - Instrument reset
    - LAN reset
    - LAN restore defaults
    - Local node reset
    - Status reset
    - Instrument reset
    - Trigger blender reset
    - Trigger timer reset
    - TSP-Link trigger reset
5. **Where saved.** Indicates where the command settings reside once they are used on an instrument. Options include:
  - **Create configuration script:** This command is saved as part of the configuration script if you save the current configuration into a script with the `createconfigscript()` command or the MENU - SCRIPT - CREATE-CONFIG option from the front panel.
  - **Not saved:** Command is not saved anywhere and must be typed each time you use it.
  - **Nonvolatile memory:** Storage area in the instrument where information is saved when the instrument is turned off.
  - **Saved setup**
6. **Default value:** Lists the default value or constant for the command. The parameter values are defined in the Usage or Details sections of the command description.

## Command usage

The Usage section of the remote command listing shows how to properly structure the command. Each line in the Usage section is a separate variation of the command usage. All possible command usage options are shown.

**Figure 92: TSP usage description**

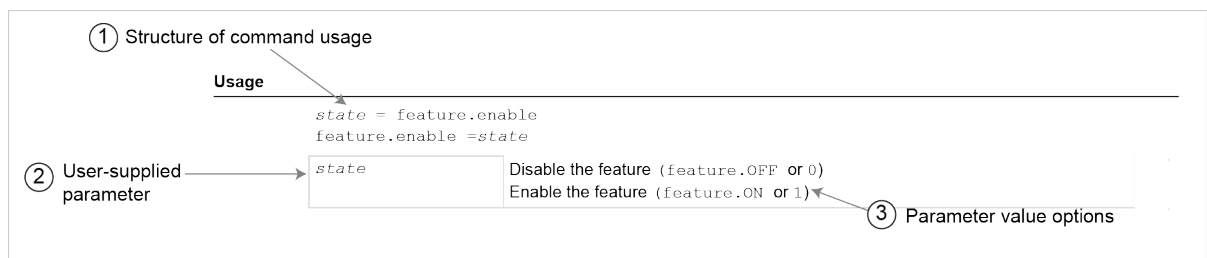

- 1 **Structure of command usage:** Shows how the parts of the command should be organized. If a parameter is shown to the left of the command, it is the return when you print the command. Information to the right are the parameters or other items you need to enter when setting the command.
- 2 **User-supplied parameters:** Indicated by italics. For example, for the function `beeper.beeper(duration, frequency)`, replace *duration* with the number of seconds and *frequency* with the frequency of the tone. `beeper.beeper(2, 2400)` generates a two-second, 2400 Hz tone.

Some commands have optional parameters. If there are optional parameters, they must be entered in the order presented in the Usage section. You cannot leave out any parameters that precede the optional parameter. Optional parameters are shown as separate lines in usage, presented in the required order with each valid permutation of the optional parameters.

For example:

```
printbuffer(startIndex, endIndex, buffer1)
printbuffer(startIndex, endIndex, buffer1, buffer2)
```

- 3 **Parameter value options:** Descriptions of the options that are available for the user-defined parameter.

## Command details

This section lists additional information you need to know to successfully use the remote commands.

**Figure 93: TSP Details description**

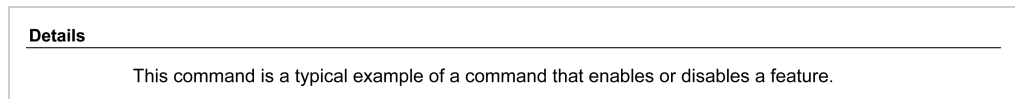

## Example section

The Example section of the remote command description shows examples of how you can use the command.

**Figure 94: TSP example code**



- 1 Actual example code that you can copy from this table and paste into your own programming application.
- 2 Description of the code and what it does. This may also contain example output of the code.

## Related commands and information

The Also See section of the remote command description lists additional commands or sections that are related to the command.

**Figure 95: TSP Also See description**

<b>Also see</b>
<a href="#">exampleUnit.enable()</a> (on page 7-8)

## Instrument Control Library (ICL) command reference

### beeper.beep()

This function generates an audible tone.

Type	TSP-Link accessible	Affected by	Where saved	Default value
Function	Yes			

#### Usage

```
beeper.beep(duration, frequency)
```

<i>duration</i>	The amount of time to play the tone (0.001 to 100 s)
<i>frequency</i>	The frequency of the tone in Hertz (Hz)

#### Details

You can use the beeper of the Models 707B and 708B to provide an audible signal at a specified frequency and time duration. For example, you can use the beeper to signal the end of a lengthy sweep.

The beeper will not sound if it is disabled. It can be disabled or enabled with the beeper enable command, or through the front panel.

#### Example

```
beeper.enable = beeper.ON
beeper.beep(2, 2400)
```

Enables the beeper and generates a two-second, 2400 Hz tone.

#### Also see

[beeper.enable](#) (on page 7-8)

### beeper.enable

This command allows you to turn the beeper on or off.

Type	TSP-Link accessible	Affected by	Where saved	Default value
Attribute (RW)	Yes	Recall setup Instrument reset	Saved setup Create configuration script	1 (beeper.ON)

#### Usage

```
state = beeper.enable
beeper.enable = state
```

<i>state</i>	Disable the beeper: beeper.OFF or 0 Enable the beeper: beeper.ON or 1
--------------	--

#### Details

This command enables or disables the beeper. When enabled, a beep signals that a front-panel key has been pressed. Disabling the beeper also disables front-panel key clicks.

**Example**

<pre>beeper.enable = beeper.ON beeper.beep(2, 2400)</pre>	Enables the beeper and generates a two-second, 2400 Hz tone.
---	--

**Also see**

[beeper.beep\(\)](#) (on page 7-8)

## bit.bitand()

This function performs a bitwise logical AND operation on two numbers.

Type	TSP-Link accessible	Affected by	Where saved	Default value
Function	No			

**Usage**

```
result = bit.bitand(value1, value2)
```

<i>result</i>	Result of the logical AND operation
<i>value1</i>	Operand for the logical AND operation
<i>value2</i>	Operand for the logical AND operation

**Details**

Any fractional parts of *value1* and *value2* are truncated to form integers. The returned *result* is also an integer.

**Example**

<pre>testResult = bit.bitand(10, 9)  print(testResult)</pre>	Performs a logical AND operation on decimal 10 (binary 1010) with decimal 9 (binary 1001), which returns a value of decimal 8 (binary 1000). Output: 8.0000000e+00
--	--

**Also see**

[Bit manipulation and logic operations](#) (on page 5-4)  
[bit.bitor\(\)](#) (on page 7-9)  
[bit.bitxor\(\)](#) (on page 7-10)

## bit.bitor()

This function performs a bitwise logical OR operation on two numbers.

Type	TSP-Link accessible	Affected by	Where saved	Default value
Function	No			



## Usage

```
result = bit.bitor(value1, value2)
```

<i>result</i>	Result of the logical OR operation
<i>value1</i>	Operand for the logical OR operation
<i>value2</i>	Operand for the logical OR operation

## Details

Any fractional parts of *value1* and *value2* are truncated to make them integers. The returned *result* is also an integer.

## Example

```
testResult = bit.bitor(10, 9)
print(testResult)
```

Performs a bitwise logical OR operation on decimal 10 (binary 1010) with decimal 9 (binary 1001), which returns a value of decimal 11 (binary 1011).  
Output:  
1.1000000e+01

## Also see

[Bit manipulation and logic operations](#) (on page 5-4)  
[bit.bitand\(\)](#) (on page 7-9)  
[bit.bitxor\(\)](#) (on page 7-10)

# bit.bitxor()

This function performs a bitwise logical XOR (exclusive OR) operation on two numbers.

Type	TSP-Link accessible	Affected by	Where saved	Default value
Function	No			

## Usage

```
result = bit.bitxor(value1, value2)
```

<i>result</i>	Result of the logical XOR operation
<i>value1</i>	Operand for the logical XOR operation
<i>value2</i>	Operand for the logical XOR operation

## Details

Any fractional parts of *value1* and *value2* are truncated to make them integers. The returned *result* is also an integer.

## Example

```
testResult = bit.bitxor(10, 9)
print(testResult)
```

Performs a logical XOR operation on decimal 10 (binary 1010) with decimal 9 (binary 1001), which returns a value of decimal 3 (binary 0011).  
Output:  
3.0000000e+00

**Also see**

[Bit manipulation and logic operations](#) (on page 5-4)  
[bit.bitand\(\)](#) (on page 7-9)  
[bit.bitor\(\)](#) (on page 7-9)

**bit.clear()**

This function clears a bit at a specified index position.

Type	TSP-Link accessible	Affected by	Where saved	Default value
Function	No			

**Usage**

```
result = bit.clear(value, index)
```

<i>result</i>	Result of the bit manipulation
<i>value</i>	Specified number
<i>index</i>	One-based bit position within value to clear (1 to 32)

**Details**

Any fractional part of *value* is truncated to make it an integer. The returned *result* is also an integer.

The least significant bit of *value* is at *index* position 1; the most significant bit is at *index* position 32.

**Example**

```
testResult = bit.clear(15, 2)
print(testResult)
```

The binary equivalent of decimal 15 is 1111. If you clear the bit at *index* position 2, the returned decimal value is 13 (binary 1101).

Output:  
1.3000000e+01

**Also see**

[Bit manipulation and logic operations](#) (on page 5-4)  
[bit.get\(\)](#) (on page 7-11)  
[bit.set\(\)](#) (on page 7-13)  
[bit.test\(\)](#) (on page 7-14)  
[bit.toggle\(\)](#) (on page 7-15)

**bit.get()**

This function retrieves the weighted value of a bit at a specified index position.

Type	TSP-Link accessible	Affected by	Where saved	Default value
Function	No			

## Usage

```
result = bit.get(value, index)
```

<i>result</i>	Result of the bit manipulation
<i>value</i>	Specified number
<i>index</i>	One-based bit position within <i>value</i> to get (1 to 32)

## Details

This function returns the value of the bit in *value* at *index*. This is the same as returning *value* with all other bits set to zero (0).

The least significant bit of *value* is at *index* position 1; the most significant bit is at *index* position 32.

If the indexed bit for the number is set to zero (0), the result will be zero (0).

## Example

```
testResult = bit.get(10, 4)
print(testResult)
```

The binary equivalent of decimal 10 is 1010. If you get the bit at index position 4, the returned decimal value is 8.  
Output:  
8.0000000e+00

## Also see

[Bit manipulation and logic operations](#) (on page 5-4)

[bit.clear\(\)](#) (on page 7-11)

[bit.set\(\)](#) (on page 7-13)

[bit.test\(\)](#) (on page 7-14)

[bit.toggle\(\)](#) (on page 7-15)

# bit.getfield()

This function returns a field of bits from the value starting at the specified index position.

Type	TSP-Link accessible	Affected by	Where saved	Default value
Function	No			

## Usage

```
result = bit.getfield(value, index, width)
```

<i>result</i>	Result of the bit manipulation
<i>value</i>	Specified number
<i>index</i>	One-based bit position within <i>value</i> to get (1 to 32)
<i>width</i>	The number of bits to include in the field (1 to 32)

## Details

A field of bits is a contiguous group of bits. This function retrieves a field of bits from *value* starting at *index*.

The *index* position is the least significant bit of the retrieved field. The number of bits to return is specified by *width*.

The least significant bit of *value* is at *index* position 1; the most significant bit is at *index* position 32.

**Example**

```
myResult = bit.getfield(13, 2, 3)

print(myResult)
```

The binary equivalent of decimal 13 is 1101. The field at *index* position 2 and *width* 3 consists of the binary bits 110. The returned value is decimal 6 (binary 110).

Output:  
6.0000000e+00

**Also see**

[Bit manipulation and logic operations](#) (on page 5-4)  
[bit.get\(\)](#) (on page 7-11)  
[bit.set\(\)](#) (on page 7-13)  
[bit.setfield\(\)](#) (on page 7-14)

**bit.set()**

This function sets a bit at the specified index position.

Type	TSP-Link accessible	Affected by	Where saved	Default value
Function	No			

**Usage**

```
result = bit.set(value, index)
```

<i>result</i>	Result of the bit manipulation
<i>value</i>	Specified number
<i>index</i>	One-based bit position within <i>value</i> to set (1 to 32)

**Details**

This function returns *result*, which is *value* with the indexed bit set. The *index* must be between 1 and 32.

The least significant bit of *value* is at *index* position 1; the most significant bit is at *index* position 32.

Any fractional part of *value* is truncated to make it an integer.

**Example**

```
testResult = bit.set(8, 3)

print(testResult)
```

The binary equivalent of decimal 8 is 1000. If the bit at *index* position 3 is set to 1, the returned value is decimal 12 (binary 1100).

Output:  
1.2000000e+01

**Also see**

[Bit manipulation and logic operations](#) (on page 5-4)  
[bit.clear\(\)](#) (on page 7-11)  
[bit.get\(\)](#) (on page 7-11)  
[bit.getfield\(\)](#) (on page 7-12)  
[bit.setfield\(\)](#) (on page 7-14)  
[bit.test\(\)](#) (on page 7-14)  
[bit.toggle\(\)](#) (on page 7-15)

## bit.setfield()

This function overwrites a bit field at a specified index position.

Type	TSP-Link accessible	Affected by	Where saved	Default value
Function	No			

### Usage

```
result = bit.setfield(value, index, width, fieldValue)
```

<i>result</i>	Result of the bit manipulation
<i>value</i>	Specified number
<i>index</i>	One-based bit position in <i>value</i> to set (1 to 32)
<i>width</i>	The number of bits to include in the field (1 to 32)
<i>fieldValue</i>	Value to write to the field

### Details

This function returns *result*, which is *value* with a field of bits overwritten, starting at *index*. The *index* specifies the position of the least significant bit of *value*. The *width* bits starting at *index* are set to *fieldValue*.

The least significant bit of *value* is at *index* position 1; the most significant bit is at *index* position 32.

Before setting the field of bits, any fractional parts of *value* and *fieldValue* are truncated to form integers.

If *fieldValue* is wider than *width*, the most significant bits of the *fieldValue* that exceed the width are truncated. For example, if *width* is 4 bits and the binary value for *fieldValue* is 11110 (5 bits), the most significant bit of *fieldValue* is truncated and a binary value of 1110 is used.

### Example

```
testResult = bit.setfield(15, 2, 3, 5)
print(testResult)
```

The binary equivalent of decimal 15 is 1111. After overwriting it with a decimal 5 (binary 101) at *index* position 2, the returned *value* is decimal 11 (binary 1011).  
Output:  
1.1000000e+01

### Also see

[Bit manipulation and logic operations](#) (on page 5-4)  
[bit.get\(\)](#) (on page 7-11)  
[bit.set\(\)](#) (on page 7-13)  
[bit.getfield\(\)](#) (on page 7-12)

## bit.test()

This function returns the Boolean value (*true* or *false*) of a bit at the specified index position.

Type	TSP-Link accessible	Affected by	Where saved	Default value
Function	No			

## Usage

```
result = bit.test(value, index)
```

<i>result</i>	Result of the bit manipulation
<i>value</i>	Specified number
<i>index</i>	One-based bit position within value to test (1 to 32)

## Details

This function returns *result*, which is the result of the tested bit.

The least significant bit of *value* is at *index* position 1; the most significant bit is at *index* position 32.

If the indexed bit for *value* is 0, *result* is *false*. If the bit of *value* at *index* is 1, the returned value is *true*.

If *index* is bigger than the number of bits in *value*, the result is *false*.

## Example

```
testResult = bit.test(10, 4)
print(testResult)
```

The binary equivalent of decimal 10 is 1010. Testing the bit at *index* position 4 returns a Boolean value of *true*.  
Output:  
*true*

## Also see

[Bit manipulation and logic operations](#) (on page 5-4)  
[bit.clear\(\)](#) (on page 7-11)  
[bit.get\(\)](#) (on page 7-11)  
[bit.set\(\)](#) (on page 7-13)  
[bit.toggle\(\)](#) (on page 7-15)

# bit.toggle()

This function toggles the value of a bit at a specified index position.

Type	TSP-Link accessible	Affected by	Where saved	Default value
Function	No			

## Usage

```
result = bit.toggle(value, index)
```

<i>result</i>	Result of the bit manipulation
<i>value</i>	Specified number
<i>index</i>	One-based bit position within <i>value</i> to toggle (1 to 32)

## Details

This function returns *result*, which is the result of toggling the bit *index* in *value*.

Any fractional part of *value* is truncated to make it an integer. The returned value is also an integer.

The least significant bit of *value* is at *index* position 1; the most significant bit is at *index* position 32.

The indexed bit for *value* is toggled from 0 to 1, or 1 to 0.

**Example**

```
testResult = bit.toggle(10, 3)
print(testResult)
```

The binary equivalent of decimal 10 is 1010. Toggling the bit at *index* position 3 returns a decimal value of 14 (binary 1110).  
Output:  
1.4000000e+01

**Also see**

[Bit manipulation and logic operations](#) (on page 5-4)  
[bit.clear\(\)](#) (on page 7-11)  
[bit.get\(\)](#) (on page 7-11)  
[bit.set\(\)](#) (on page 7-13)  
[bit.test\(\)](#) (on page 7-14)

## channel.clearforbidden()

This function clears the list of channels specified from being forbidden to close.

Type	TSP-Link accessible	Affected by	Where saved	Default value
Function	Yes			

**Usage**

```
channel.clearforbidden(channelList)
```

<i>channelList</i>	String that specifies a list of channels, using channel list notation
--------------------	---

**Details**

The *channelList* parameter indicates the channels that will no longer be forbidden to close, and may include:

- allslots or slotX (where X equals 1 to 6 for Model 707B, or 1 for Model 708B)
- Channel ranges or individual channels

This function allows all items contained in the *channelList* parameter to be closed. It removes the "forbidden to close" attribute that can be applied to a channel using `channel.setforbidden()`.

Command processing stops as soon as an error is detected. If an error is found, the channels are not cleared from being forbidden to close.

**Example**

```
channel.reset("slot1")
channel.setforbidden("1A01:1A05")

channel.clearforbidden("1A02,1A03")
print(channel.getforbidden("slot1"))
```

Reset the channels on slot 1.  
Set channels 1A01, 1A02, 1A03, 1A04, and 1A05 to be forbidden to close.  
Change 1A02 and 1A03 to be allowed to close.  
Retrieve the list of forbidden channels.  
Output:  
1A01, 1A04, 1A05

**Also see**

[channel.getforbidden\(\)](#) (on page 7-27)  
[channel.setforbidden\(\)](#) (on page 7-42)

## channel.close()

This function closes the channels and channel patterns that are specified by the channel list parameter without opening any channels.

Type	TSP-Link accessible	Affected by	Where saved	Default value
Function	Yes			

### Usage

```
channel.close(channelList)
```

<i>channelList</i>	A string that lists the channels and channel patterns to close
--------------------	--

### Details

Channels closed with this command are appended to the already closed channels (no previously closed channels are opened by this command).

Actions associated with this function include:

- Close the specified items in *channelList*
- Incur the settling time and any user-specified delay

An error is generated if:

- The parameter string contains `slotX`, where *X* is 1 to 6, or `allslots`
- A forbidden item is specified
- Specified channel does not support being closed

Once an error is detected, the command stops processing and no channels are closed.

### Example

<pre>channel.open("allslots") channel.pattern.setimage("1B02,1B04,1B06",     "Chans") channel.close("1A01:1A05, 1C03, Chans") print(channel.getclose("slot1"))</pre>	<p>Close a variety of channels, directly and with a channel pattern; note that the output sorts the channels</p> <p>Output:</p> <pre>1A01;1A02;1A03;1A04;1A05;1B02;1B04;1     B06;1C03</pre>
--	--

### Also see

- [channel.exclusiveclose\(\)](#) (on page 7-22)
- [channel.exclusiveslotclose\(\)](#) (on page 7-23)
- [channel.getclose\(\)](#) (on page 7-24)
- [channel.open\(\)](#) (on page 7-33)



## channel.connectrule

This attribute controls the connection rule for closing and opening channels in the instrument.

Type	TSP-Link accessible	Affected by	Where saved	Default value
Attribute (RW)	Yes	Instrument reset Recall setup	Create configuration script Save setup	channel.BREAK_BEFORE_MAKE

### Usage

```
rule = channel.connectrule
channel.connectrule = rule
```

<i>rule</i>	<ul style="list-style-type: none"> <li>channel.BREAK_BEFORE_MAKE or 1: Break-before-make (BBM) connections for relays in the instrument</li> <li>channel.MAKE_BEFORE_BREAK or 2: Make-before-break (MBB) connections for relays in the instrument</li> <li>channel.OFF or 0: Does not guarantee a connection rule. The instrument closes relays as efficiently as possible to improve speed performance without applying a rule</li> </ul>
-------------	--

### Details

The connection rule describes the order in which switch channels are opened and closed when using `channel.exclusiveclose()`, `channel.exclusiveslotclose()`, and scanning commands like `scan.execute()` and `scan.background()`. These commands may both open and close switch channels in a single command. The connection rule dictates the algorithm used by the instrument to order the opening and closing of switches.

The connection rule affects the operating time of these commands. These commands do not allow the instrument to continue execution until the settle time of the relays has expired.

When the connection rule is set to `channel.BREAK_BEFORE_MAKE`, the instrument ensures that all switch channels open before any switch channels close. When switch channels are both opened and closed, this command executes not less than the addition of both the open and close settle times of the indicated switch channels.

When the connection rule is set to `channel.MAKE_BEFORE_BREAK`, the instrument ensures that all switch channels close before any switch channels open. This behavior should be applied with caution because it will connect two test devices together for the duration of the switch close settle time. When switch channels are both opened and closed, the command executes not less than the addition of both the open and close settle times of the indicated switch channels.

With no connection rule (set to `channel.OFF`), the instrument attempts to simultaneously open and close switch channels in order to minimize the command execution time. This results in faster performance at the expense of guaranteed switch position. During the operation, multiple switch channels may simultaneously be in the close position. Make sure your device under test can withstand this possible condition. When switch channels are both opened and closed, the command executes not less than the greater of either the open or close settle times of the indicated switch channels.

## NOTE

You cannot guarantee the sequence of open and closure operations when the channel connect rule set to OFF. It is highly recommended that you implement cold switching when the channel connect rule is set to OFF.

In general, the settling time of single commands that open and close switch channels depends on several factors, such as card type and channel numbers. However, the opening and closing of two sequential channels including no others can be guaranteed as follows:

- `channel.BREAK_BEFORE_MAKE` open settle time + close settle time
- `channel.MAKE_BEFORE_BREAK` close settle time + open settle time
- `channel.OFF` maximum of open settle time or close settle time

This behavior is also affected by `channel.connectsequential` and any additional user delay times.

**WARNING**

***Make-before-break (also known as hot switching) can dry-weld reed relays so that they will always be on. Hot switching is recommended only when external protection is provided.***

**Example**

<pre>channel.connectrule = channel.BREAK_BEFORE_MAKE</pre>	Sets the connect rule in the instrument to <code>channel.BREAK_BEFORE_MAKE</code>
--	---

**Also see**

- [channel.connectsequential](#) (on page 7-19)
- [channel.exclusiveclose\(\)](#) (on page 7-22)
- [channel.exclusiveslotclose\(\)](#) (on page 7-23)
- [scan.background\(\)](#) (on page 7-139)
- [scan.execute\(\)](#) (on page 7-142)

---

## channel.connectsequential

This attribute controls whether or not channels are closed sequentially.

Type	TSP-Link accessible	Affected by	Where saved	Default value
Attribute (RW)	Yes	Instrument reset Recall setup	Create configuration script	channel.OFF

**Usage**

```
sequential = channel.connectsequential
channel.connectsequential = sequential
```

<code>sequential</code>	<ul style="list-style-type: none"> <li><code>channel.OFF</code> or 0: Disable sequential connections</li> <li><code>channel.ON</code> or 1: Enable sequential connections</li> </ul>
-------------------------	--

## Details

---

When `channel.connectsequential` is enabled, the list of channel actions is acted on sequentially. No two relays are opened or closed simultaneously.

Using a sequential close allows you to determine the time for a close operation to happen. For example, if you close three channels and each takes 4 ms to close (assuming no additional user delay times), with sequential on, it will take 12 ms. With sequential off, it may be 4, 8 or 12 ms, depending on whether or not the card can close multiple channels at once.

The order in which channels are opened or closed is not guaranteed with sequential off.

The sequential setting affects all channels in the instrument.

## Example

---

<code>channel.connectsequential = channel.ON</code>	Specifies that channels close sequentially.
---	---

## Also see

---

[channel.connectrule](#) (on page 7-18)

[Switch operation](#) (on page 2-80)

---

# channel.createspecifier()

This function creates a string channel descriptor from a series of card-dependent integer arguments.

Type	TSP-Link accessible	Affected by	Where saved	Default value
Function	Yes			

## Usage

---

```
specifier = channel.createspecifier(slot, row, column)
```

<i>specifier</i>	The formatted string for the channel
<i>slot</i>	The slot number to use (1 to 6)
<i>row</i>	The row number to use (see the matrix card documentation for limits); map row letters to numbers (A = 1, B = 2, and so on)
<i>column</i>	Specifies the column number to use

---

**Details**

---

The arguments are dependent upon the card type in the specified slot. This command can only create valid channel descriptors; if an illegal argument is sent for the type of card in the specified slot, an error is generated.

---

**Example 1**

---

```
cs = channel.createspecifier(1, 1, 1)
print(cs)
```

Creates a channel descriptor for row 1, column 1 on the card in slot 1.  
**Output:**  
1A01

---

**Example 2**

---

```
count = 0
for row = 1, 8 do
  for col = 1, 12 do
    ch = channel.createspecifier(1, row, col)
    count = count + tonumber(channel.getcount(ch))
  end
end
print("Count is " .. count .. ".")
```

Assuming an 8x12 matrix card in slot 1, this example calculates the sum of the counts on all channels.  
**Output:**  
Count is 1060656.

## channel.exclusiveclose()

This function closes the specified channels so that they are the only channels that are closed on the instrument.

Type	TSP-Link accessible	Affected by	Where saved	Default value
Function	Yes			

### Usage

```
channel.exclusiveclose(channelList)
```

<i>channelList</i>	A string listing the channels and channel patterns to exclusively close
--------------------	---

### Details

This command allows you to close specific channels and open any other channels on the instrument. When you send this command, any presently closed channel opens if it is not specified to be closed in the parameter. When you send this command:

- Any presently closed channels that are not specified in *channelList* are opened.
- The channels in *channelList* are closed.
- Settling and user-specified delay times are applied as defined by the connection rules and delay settings.

If the *channelList* parameter is an empty string or a string of spaces, all channels are opened. Therefore, sending `channel.exclusiveclose(" ")` is equivalent to `channel.open(channel.getclose("allslots"))`. However, sending the equivalent commands when nothing is closed generates an error because `nil` (the response of `channel.getclose("allslots")`) is being sent to the open command.

An error is generated if:

- The parameter string contains `slotX`, where `X = 1 to 6` or `allslots`
- A specified channel or channel pattern is invalid
- Channel number does not exist for slot specified
- Slot is empty
- A forbidden item is specified

Once an error is detected, the command stops processing. Channels open or close only if no errors are found.

### Example

```
channel.exclusiveclose(" ")
channel.close("1D01,1E12")
print(channel.getclose("slot1"))

channel.pattern.setimage("1B02,1B04,1B06", "myChans")
channel.exclusiveclose("1A01:1A05, 1C03, myChans")
print(channel.getclose("slot1"))
```

Open all channels because the `channelList` parameter is empty.

Close 1D01 and 1E12.

Output:

1D01;1E12

Create the pattern `myChans`.

Exclusively close the channels in `myChans` and additional specified channels. The originally closed channels (1D01 and 1E12) are now open.

Output:

1A01;1A02;1A03;1A04;1A05;1B02;1B04;1B06;1C03

### Also see

- [channel.close\(\)](#) (on page 7-17)
- [channel.connectrule](#) (on page 7-18)
- [channel.connectsequential](#) (on page 7-19)
- [channel.exclusiveslotclose\(\)](#) (on page 7-23)
- [channel.getclose\(\)](#) (on page 7-24)
- [channel.open\(\)](#) (on page 7-33)

## channel.exclusiveslotclose()

This function closes the specified channels and channel patterns on the associated slots and opens any channels that are not specified.

Type	TSP-Link accessible	Affected by	Where saved	Default value
Function	Yes			

### Usage

```
channel.exclusiveslotclose(channelList)
```

<i>channelList</i>	A string that lists the channels and channel patterns to exclusively close on the cards in associated slots
--------------------	---

### Details

This command allows you to bundle the closing of channels with the opening of channels. Any currently closed channels open if they are not specified to be closed on the slots related to the channels in *channelList*. Using this command guarantees that only the specified channels and channel patterns are closed on the slots associated with channels in the *channelList*.

When this command is sent:

- Closed channels for the associated slots are opened if they are not specified in the *channelList*
- Channels specified by the items in *channelList* are closed

Any settling times and user-specified delay times are incurred before command processing is complete

For example, if row 1, column 1 channels are closed on each of the six slots, specifying a *channelList* parameter of "2A02, 4A04" opens the row 1, column 1 channels (slots 2 and 4 only). Then, the row 1, column 2 channel on slot 2, and the row 1, column 4 channel on slot 4 close. The row 1, column 2 channels remain closed on slots 1, 3, 5, and 6.

An error is generated if:

- The parameter string contains slot $x$  (where  $x = 1$  to 6) or allslots
- The parameter string is empty or parameter string with just spaces
- A specified channel is invalid or does not exist for the slot
- Channel pattern does not exist or the image of the pattern is an empty channel list
- A forbidden item is specified

Once an error is detected, the command stops processing. Channels open or close only if no errors are found and remain unchanged with any parsing or syntax error.

#### Example

```
channel.open("allslots")
channel.close("1A01,2A01,3A01,4A01,5A01,6A01")
channel.exclusiveslotclose("3A03")
print(channel.getclose("allslots"))
```

Open all channels on all slots.  
Close row A column 1 channels on all slots.  
Open row A column 1 on slot 3 and close row A column 3 on slot 3 without affecting any other slot with closed channels.  
Output:  
1A01; 2A01; 3A03; 4A01; 5A01; 6A01

#### Also see

[channel.close\(\)](#) (on page 7-17)  
[channel.exclusiveclose\(\)](#) (on page 7-22)  
[channel.getclose\(\)](#) (on page 7-24)  
[channel.open\(\)](#) (on page 7-33)

## channel.getclose()

This function queries for the closed channels indicated by the channel list parameter.

Type	TSP-Link accessible	Affected by	Where saved	Default value
Function	Yes			

#### Usage

```
closed = channel.getclose(channelList)
```

<i>closed</i>	A string listing the channels that are presently closed in the specified channel list parameter
<i>channelList</i>	A string representing the channels and channel patterns that will be queried

#### Details

If more than one channel is closed, they are semicolon-delimited in the string. When the *channelList* contains a channel pattern, only the closed channels in that image are returned.

An error message is generated if an empty parameter string is specified or if the specified channel list contains no valid channels that can be closed (for example, a channel list equaling "slot $x$ " or "allslots").

If nothing is closed within the specified scope, a *nil* response is returned.

**Example 1**

```
channelList = "1A01:1H12"
channel.close("1A01")
print(channel.getclose(channelList))
channel.close("1C03")
print(channel.getclose(channelList))
```

For this example, assume there is a card or pseudocard in slot 1 with no previously closed channels. The output is:

```
1A01
1A01;1C03
```

**Example 2**

```
channel.close("1B03:1B05")
print(channel.getclose("allslots"))
```

For this example, assume there is a card or pseudocard in slot 1 with no previously closed channels. The output is:

```
1B03;1B04;1B05
```

**Also see**

[channel.close\(\)](#) (on page 7-17)  
[channel.exclusiveclose\(\)](#) (on page 7-22)  
[channel.getstate\(\)](#) (on page 7-32)  
[channel.open\(\)](#) (on page 7-33)  
[Data retrieval commands](#) (on page 5-3)

## channel.getcount()

This function returns a string with the close counts for the specified channels.

Type	TSP-Link accessible	Affected by	Where saved	Default value
Function	Yes			

**Usage**

```
counts = channel.getcount(channelList)
```

<i>counts</i>	A comma-delimited string listing the channel close counts
<i>channelList</i>	A string listing the items to query, which can include: <ul style="list-style-type: none"> <li>Channels</li> <li>Channel patterns (channels will be listed in the order in which they are listed in the pattern)</li> <li>slotX, where X equals 1 to 6 for the Model 707B or 1 for the Model 708B</li> <li>allslots</li> </ul>

**Details**

A close count is the number of times a relay has been closed. The count values are returned in the order in which the channels are specified.

If *channelList* includes a pattern, you can use `channel.pattern.getimage()` with the pattern name to see the channel order and the channels to which the close counts pertain.



When the *channelList* parameter for this function is "slotX", the response first lists the channels starting from lowest to highest (from slot 1 to slot 6). Because each slot is processed completely before going to the next, all slot 1 channels are listed before slot 2 channels.

The counts reported for the following cards indicate the number of closures since the last power cycle of the card:

- 7072
- 7072-HV
- 7173-50
- 7174A

For all other cards, the number of closures is the closures that have occurred over the lifetime of the card.

If an error is detected, a `nil` value is returned. No partial list of close counts is returned.

## NOTE

Pseudocards do not support counts, so count values are generated numbers, not actual count values, if a pseudocard is used.

### Example

<pre>channel.pattern.setimage("1A01,1B02,1C01","Path") PathList =   channel.pattern.getimage("Path") print(PathList) print(channel.getcount(PathList)) print(channel.getcount("Path"))</pre>	<p>Gets the close counts for channels in a channel pattern called "Path".</p> <p>Sample output:</p> <pre>1A01,1B02,1C01 11001,11014,11025 11001,11014,11025</pre>
--	---

### Also see

[channel.pattern.getimage\(\)](#) (on page 7-36)

[channel.pattern.setimage\(\)](#) (on page 7-37)

[Data retrieval commands](#) (on page 5-3)

## channel.getdelay()

This function queries for the additional delay time for the specified channels.

Type	TSP-Link accessible	Affected by	Where saved	Default value
Function	Yes	Instrument reset Channel reset Recall setup	Create configuration script Save setup	0

### Usage

```
delayTimes = channel.getdelay(channelList)
```

<i>delayTimes</i>	A comma-delimited string consisting of the delay times (in seconds) for channels specified in <i>channelList</i>
<i>channelList</i>	A string listing the channels to query for their delay times

**Details**

The *channelList* parameter may contain *slotX* (where X equals 1 to 6 for Model 707B, or 1 for Model 708B) or *allslots*.

A command, after closing the state of channels, incurs the delay time indicated in the response for a channel before it completes. However, the internal settling time must elapse before the user delay is incurred. Therefore, the sequence is:

1. Command is processed
2. Channel closes
3. Settling time is incurred
4. User delay is incurred
5. Command completes

The delay times are comma-delimited in the same order that the items were specified in the *channelList* parameter. A value of zero (0) indicates that no additional delay time is incurred before a close command completes.

An error message is generated for the following reasons:

- The specified channels do not support a delay time
- A channel pattern is specified

Command processing stops as soon as an error is detected and a *nil* response is generated.

NOTE
Pseudocards do not support user delays, so this value is always zero (0) if a pseudocard is used.

**Example**

<pre>print(channel.getdelay("1A07,1B05,1C03"))  channel.setdelay("slot1", 3.1) DelayTimes = channel.getdelay("1A07,1B05,1C03") print(DelayTimes)</pre>	<p>Get the existing delays for the listed channels. Output: 0.0000000e+00,0.0000000e+00,0.0000000e+00</p> <p>Set a delay on all channels in slot 1. Verify that the delay was set for the listed channels. Output: 3.1000000e+00,3.1000000e+00,3.1000000e+00</p>
--	--

**Also see**

- [channel.setdelay\(\)](#) (on page 7-41)
- [Data retrieval commands](#) (on page 5-3)

## channel.getforbidden()

This function returns a string listing the channels in the channel list that are forbidden to close.

Type	TSP-Link accessible	Affected by	Where saved	Default value
Function	Yes	Instrument reset Channel reset Recall setup	Create configuration script Save setup	Permitted to close

## Usage

```
forbiddenList = channel.getforbidden(channelList)
```

<i>forbiddenList</i>	Comma-delimited string listing the channels in the channel list that are forbidden to close
<i>channelList</i>	A string listing the channels and channel patterns that are to be checked to see if they are forbidden to close

## Details

The *channelList* parameter indicates which channels to check, and may include:

- `allslots` or `slotX` (where *x* equals 1 to 6 for Model 707B, or 1 for Model 708B)
- Channel ranges or individual channels
- Channel patterns

If there are no channels in the scope of the *channelList* that are on the forbidden list, the string returned is empty or `nil`. The format of the channels in the response string is slot, row, column for matrix channels.

## Example

<pre>channel.reset("slot1") channel.setforbidden("1A01:1A05") print(channel.getforbidden("allslots")) print(channel.getforbidden("slot1")) print(channel.getforbidden(   "1A01:1A03,1B04,1B08,1B12"))</pre>	<p>Reset the channels. Set channels 1A01, 1A02, 1A03, 1A04, and 1A05 to be forbidden. List the forbidden channels on all slots, slot 1, and list of channels.</p> <p><b>Output:</b> 1A01, 1A02, 1A03, 1A04, 1A05 1A01, 1A02, 1A03, 1A04, 1A05 1A01, 1A02, 1A03</p>
---	--

## Also see

- [channel.clearforbidden\(\)](#) (on page 7-16)
- [channel.setforbidden\(\)](#) (on page 7-42)
- [Data retrieval commands](#) (on page 5-3)

## channel.getlabel()

This function retrieves the label associated with one or more channels.

Type	TSP-Link accessible	Affected by	Where saved	Default value
Function	Yes	Instrument reset Channel reset Recall setup	Create configuration script Save setup	slot, row, column identifier

## Usage

```
label = channel.getlabel(channelList)
```

<i>label</i>	A string listing the comma-delimited labels for items in <i>channelList</i>
<i>channelList</i>	A string listing the channels to query for the label associated with them

---

**Details**

---

The *channelList* parameter can contain more than one channel. If it does, a comma delimits the labels for the channels. The return string lists the labels in the same order that the channels were specified. The *channelList* parameter cannot be an empty string and must be a valid channel.

The *channelList* parameter can contain *slotX* (where X equals 1 to 6 for Model 707B, or 1 for Model 708B) or *allslots*. In this case, the channels are listed before the analog backplane relays.

- An error is generated if:
- The slot is empty
- The specified channel is not on the installed card
- A channel pattern is specified

Command processing stops as soon as an error is detected, and then a `nil` response is generated. No partial list of labels is returned.

---

**Example**

---

```
channel.reset("1A01")
print(channel.getlabel("1A01"))
channel.setlabel("1A01", "Device")
print(channel.getlabel("1A01"))
```

```
Reset the channel.
Print the default label of the channel.
Set the label to "Device".
Return the new label.
Output:
1A01
Device
```

---

**Also see**

---

[channel.setlabel\(\)](#) (on page 7-43)

[Data retrieval commands](#) (on page 5-3)

## channel.getlabelcolumn()

This function retrieves the label that was assigned to a column.

Type	TSP-Link accessible	Affected by	Where saved	Default value
Function	Yes	Instrument reset Channel reset	Create configuration script	Empty string or blank

### Usage

```
label = channel.getlabelcolumn(channelList)
```

<i>label</i>	A string that lists the comma-delimited labels for the items in <i>channelList</i> .
<i>channelList</i>	A string that lists the channels to query for the labels associated with them.

### Details

The parameter *channelList* can contain more than one channel. Use a comma to delimit the labels for the channels. The return string *label* lists the labels in the same order that the channels are specified.

You cannot specify a channel pattern.

The *channelList* parameter can contain *slotX* (where *X* equals 1 to 6 for Model 707B, or 1 for Model 708B) or *allslots*. It can also contain a label. However, if the label exists, it is in the returned response and not the numeric channel number.

### Example

```
channel.setlabelcolumn("1A01", "DUT1")
channel.setlabelcolumn("1A03", "DUT2")
print(channel.getlabelcolumn("1a01:1a12"))
```

Label all the column labels on a card.  
Output:  
DUT1,,DUT2,,,,,,,,,  
Also note the change on the display.

### Also see

[channel.getlabelrow\(\)](#) (on page 7-31)  
[channel.setlabelcolumn\(\)](#) (on page 7-44)  
[channel.setlabelrow\(\)](#) (on page 7-46)

## channel.getlabelrow()

This function retrieves the label assigned to a row.

Type	TSP-Link accessible	Affected by	Where saved	Default value
Function	Yes	Instrument reset Channel reset	Create configuration script	Empty string or blank

### Usage

```
label = channel.getlabelrow(channelList)
```

<i>label</i>	A string that lists the comma-delimited labels for the items in <i>channelList</i> .
<i>channelList</i>	A string that lists the channels to query for the labels associated with them.

### Details

The parameter *channelList* can contain more than one channel. If it does, use a comma to delimit the labels for the channel rows. The return string *label* lists the labels in the same order that the channels are specified.

The *channelList* parameter can contain *slotX* (where *X* equals 1 to 6 for Model 707B, or 1 for Model 708B) or *allslots*. It can also contain a label, but it cannot contain a channel pattern.

### Example

```
channel.setrowlabel("1A01", "DUT1")
channel.setrowlabel("1C01", "DUT2")
print(channel.getlabelrow("1A01, 1B01,
    1C01, 1D01, 1E01, 1F01, 1G01, 1H01"))
```

Label the row labels on a card.

Output:

```
DUT1,,DUT2,,,,,
```

Also note the change on the display.

### Also see

[channel.getlabelcolumn\(\)](#) (on page 7-30)

[channel.setlabelcolumn\(\)](#) (on page 7-44)

[channel.setlabelrow\(\)](#) (on page 7-46)

## channel.getstate()

Queries the state indicators of the channels in the instrument.

Type	TSP-Link accessible	Affected by	Where saved	Default value
Function	Yes	Instrument reset Channel reset Recall setup	Not saved	0

### Usage

```
state = channel.getstate(channelList)
state = channel.getstate(channelList, indicatorMask)
```

<i>state</i>	Return string listing the comma-delimited states for the channels in <i>channelList</i>
<i>channelList</i>	String specifying the channels to query, using normal channel list syntax
<i>indicatorMask</i>	Value to specify only certain indicators; if omitted, all indicators are returned

### Details

Each bit in the *state* represents a different indicator. Therefore, multiple indicators can be present (the OR operation is performed bitwise). The optional state *indicatorMask* can be used to return only certain indicators. If there is no *indicatorMask*, then all indicators are returned.

Indicators can be latched or unlatched, depending on other system settings. Latched indicators mean that the condition has occurred since the last reset command (or power cycle). Unlatched indicators mean that the condition occurred when the `channel.getstate()` command was issued.

Although the `channel.getstate()` command returns a string representing a number, this can be easily changed to a number and then compared to one of the provided Lua constants.

The only state information is an indicator of relay state (`channel.IND_CLOSED`).

### Example

```
print(channel.getstate("4A01:4B08"))

channel.pattern.setimage("1A01,2B02,3C03",
    "Path")
print(channel.getstate("Path"))
print(channel.getstate("3C03"))

-- Unmasking the return value must be done
-- one channel at a time.
if bit.band(channel.IND_CLOSED,
    tonumber(channel.getstate("4A10"))) == 1
then
    print("CLOSED")
else
    print("OPENED")
end
```

Query the state of the first 20 channels on slot 4. See the state of channels in channel pattern called "PathList".

The `channel.IND_CLOSED` command equates to the number 1. Because the state is a bit-oriented value, you must perform a logical AND operation on the state to the overload constant to isolate it from other indicators.

The `tonumber()` command only works with a single channel. When multiple channels are returned (for example, `channel.getstate("slot4")`), this string must be parsed by the comma delimiter to find each value.

### Also see

[channel.getclose\(\)](#) (on page 7-24)

---

## channel.gettype()

This function returns the type associated with a channel.

Type	TSP-Link accessible	Affected by	Where saved	Default value
Function	Yes			

### Usage

```
type = channel.gettype(channelList)
```

<i>type</i>	Returns a string listing the comma-delimited types for channels in <i>channelList</i>
<i>channelList</i>	String specifying the channels to query, using normal <i>channelList</i> syntax

### Details

The channel type is defined by the physical hardware of the card on which the channel exists. The only valid channel type for the Models 707B and 708B is `channel.TYPE_SWITCH` or 1.

### Example 1

```
print(channel.gettype("1A01"))
```

Query the channel type of row 1, column 1, in slot 1.

### Also see

None

---

## channel.open()

This function opens the specified channels and channel patterns.

Type	TSP-Link accessible	Affected by	Where saved	Default value
Function	Yes			

### Usage

```
channel.open(channelList)
```

<i>channelList</i>	String listing the channels and channel patterns to open
--------------------	--

### Details

This function opens the specified channels based on the channel's switching configuration.

The settling time associated with a channel must elapse before the command completes. User delay is not added when a relay opens.

### Example 1

```
channel.open("1A01:1A05, 3B03, Chans")
```

Opens channels in row 1, columns 01 to 05 on slot 1; row 2, column 03 on slot 3; and the channels in the channel pattern Chans.



---

**Example 2**

---

```
channel.open("slot3, slot5")
```

Opens all channels on slots 3 and 5.

---

**Example 3**

---

```
channel.open("allslots")
```

Opens all channels on all slots.

---

**Also see**

---

[channel.close\(\)](#) (on page 7-17)  
[channel.exclusiveclose\(\)](#) (on page 7-22)  
[channel.exclusiveslotclose\(\)](#) (on page 7-23)  
[channel.getclose\(\)](#) (on page 7-24)  
[channel.getdelay\(\)](#) (on page 7-26)  
[channel.pattern.getimage\(\)](#) (on page 7-36)  
[channel.pattern.setimage\(\)](#) (on page 7-37)  
[channel.pattern.snapshot\(\)](#) (on page 7-39)  
[channel.getstate\(\)](#) (on page 7-32)  
[channel.setdelay\(\)](#) (on page 7-41)  
[channel.setforbidden\(\)](#) (on page 7-42)

---



---

## channel.pattern.catalog()

This function creates a list of the user-created channel patterns.

Type	TSP-Link accessible	Affected by	Where saved	Default value
Function	Yes			

### Usage

```
for name in channel.pattern.catalog() do
  ...
end
```

<i>name</i>	String representing the user-defined name of the channel pattern that is assigned by the catalog function during the <code>for</code> loop
-------------	--

### Details

This function allows you to print or delete all user-created channel patterns in the run-time environment. The entries that are returned are listed in random order.

### Example

<pre>channel.pattern.setimage("1A01,1A02",   "patternA") channel.pattern.setimage("1B01,1B02",   "patternB") channel.pattern.setimage("1C01,1C02",   "patternC")  for name in channel.pattern.catalog() do   print(name .. " = " ..     channel.pattern.getimage(name))   channel.pattern.delete(name) end</pre>	<p>This example prints the names and items associated with all user-created channel patterns. It then deletes the channel pattern.</p> <pre>patternC = 1C01,1C02 patternA = 1A01,1A02 patternB = 1B01,1B02</pre>
--	--

### Also see

[channel.pattern.delete\(\)](#) (on page 7-36)  
[channel.pattern.getimage\(\)](#) (on page 7-36)  
[channel.pattern.setimage\(\)](#) (on page 7-37)  
[channel.pattern.snapshot\(\)](#) (on page 7-39)

## channel.pattern.delete()

This function deletes a channel pattern.

Type	TSP-Link accessible	Affected by	Where saved	Default value
Function	Yes			

### Usage

```
channel.pattern.delete(name)
```

<i>name</i>	A string representing the name of the channel pattern to delete
-------------	---

### Details

An error is generated if the name does not exist as a channel pattern.

### Example

<code>channel.pattern.delete("Channels")</code>	Deletes a channel pattern called Channels.
---	--

### Also see

[channel.pattern.catalog\(\)](#) (on page 7-35)  
[channel.pattern.getimage\(\)](#) (on page 7-36)  
[channel.pattern.setimage\(\)](#) (on page 7-37)  
[channel.pattern.snapshot\(\)](#) (on page 7-39)

## channel.pattern.getimage()

This function queries a channel pattern for associated channels.

Type	TSP-Link accessible	Affected by	Where saved	Default value
Function	Yes	Instrument reset Channel reset Recall setup Pole setting change	Create configuration script Save setup	Not applicable

### Usage

```
channelList = channel.pattern.getimage(name)
```

<i>channelList</i>	A string specifying a list of channels that are represented by the name
<i>name</i>	A string representing the name of the channel pattern to query

### Details

The returned string lists the channels in the slot, row, column format, even if a channel pattern was used to create it. Results for multiple channel patterns are delimited by a semicolon (;). Commas delimit the specific channels in a single channel pattern in the string.

If you change a pole setting for a channel that is associated with a channel pattern, the channel pattern is deleted. Be sure to configure the pole setting for channels (`channel.setpole`) before creating a channel pattern.

**Example**

```
channel.pattern.setimage("1A01:1A05", "myPattern")
channel.pattern.setimage("1B01,1B03,1B05", "myRoute")

myImage = channel.pattern.getimage("myPattern")
print(myImage)
print(channel.pattern.getimage("myRoute"))
print(channel.pattern.getimage("myRoute, myPattern"))
```

Using a Model 7174 (or similar model) card in slot 1, this example creates two channel patterns and then queries these patterns.

**Output:**

```
1A01,1A02,1A03,1A04,1A05
1B01,1B03,1B05
1B01,1B03,1B05;1A01,1A02,1A03,1A04,1A05
```

**Also see**

[channel.pattern.catalog\(\)](#) (on page 7-35)  
[channel.pattern.delete\(\)](#) (on page 7-36)  
[channel.pattern.setimage\(\)](#) (on page 7-37)

## channel.pattern.setimage()

This function creates a channel pattern and associates it with the specified name.

Type	TSP-Link accessible	Affected by	Where saved	Default value
Function	Yes	Instrument reset Channel reset Recall setup Pole setting change	Create configuration script Save setup	Not applicable

**Usage**

```
channel.pattern.setimage(channelList, name)
```

<i>channelList</i>	A string listing the channels and channel patterns to use when creating the new channel pattern
<i>name</i>	A string representing the name to associate with the new channel pattern

**Details**

If *name* is used for an existing channel pattern, that pattern is overwritten with the new pattern channel image (if no errors occur). The previous image associated with the name is lost.

The channel pattern is not created if an error is detected. You can create a channel pattern with an empty *channelList* parameter. Once a channel pattern is created, the only way to add a channel to an existing pattern is to delete the old pattern and recreate the pattern with the new items.

If you change a pole setting for a channel that is associated with a channel pattern, the channel pattern is deleted. Be sure to configure the pole setting for channels (`channel.setpole`) before creating a channel pattern.

Channel patterns are stored when you run the `createconfigscript()` command or `setup.save()` command.

Channel patterns are lost when power is cycled. Use `setup.recall()` or a script created with `createconfigscript()` to restore them.

The following restrictions exist when naming a channel pattern:

- The name must contain only letters, numbers, or underscores
- The name must start with a letter
- The name is case sensitive

Examples of valid names:

- Channels
- Chans
- chans
- Path1
- Path20
- path\_3

Examples of invalid names:

- 1path (invalid because it starts with a number)
- my chans (invalid because it contains a space)
- My,chans (invalid because it contains a comma)
- Path1:10 (invalid because it contains a colon)

An error is generated if:

- The *name* parameter already exists as a label
- Any channel is forbidden to close
- Insufficient memory exists to create the channel pattern
- The parameter string contains `slotX` (where *X* equals 1 to 6 for Model 707B, or 1 for Model 708B) or `allslots`
- The name parameter contains a space character
- The pattern name exceeds 19 characters

### Example 1

```
channel.pattern.setimage("1A01:1A10", "Channels")

oldList = channel.pattern.getimage("Channels")
newList = oldList .. ", 1C11"
channel.pattern.delete("Channels")
channel.pattern.setimage(newList, "Channels")
channel.close("Channels, 1D11")

Items = channel.pattern.getimage("Channels")
channel.pattern.setimage(Items, "Pattern")
channel.pattern.delete("Channels")
```

For this example, assume there is a Keithley Model 7174 or similar card in slot 1.

Creates a pattern, appends a channel to the pattern by retrieving the pattern and recreating it, and then renames the pattern.

**Also see**

[createconfigscript\(\)](#) (on page 7-47)  
[channel.pattern.catalog\(\)](#) (on page 7-35)  
[channel.pattern.delete\(\)](#) (on page 7-36)  
[channel.pattern.getimage\(\)](#) (on page 7-36)  
[channel.pattern.snapshot\(\)](#) (on page 7-39)

**channel.pattern.snapshot()**

This function creates a channel pattern.

Type	TSP-Link accessible	Affected by	Where saved	Default value
Function	Yes	Instrument reset Channel reset Recall setup Pole setting change	Create configuration script Save setup	Not applicable

**Usage**

```
channel.pattern.snapshot ( name )
```

<i>name</i>	A string representing the name to associate with the present state of channels
-------------	--

**Details**

This command stores an image of presently closed channels and associates them with the *name* parameter.

If *name* is already used for an existing channel pattern, that pattern is overwritten with the new pattern channel image (if no errors occur).

The following restrictions exist when naming a channel pattern:

- The name must contain only letters, numbers, or underscores
- The name must start with a letter
- The name is case sensitive

Examples of valid names:

- Channels
- Chans
- chans
- Path1
- Path20
- path\_3

Examples of invalid names:

- 1path (invalid because it starts with a number)
- my chans (invalid because it contains a space)
- My , chans (invalid because it contains a comma)
- Path1 : 10 ( invalid because it contains a colon)

An error is generated if:

- The *name* parameter already exists as a label
- Insufficient memory exists to save the channel pattern and name in persistent memory
- The pattern name exceeds 19 characters or contains a space

Issuing this function on an existing pattern invalidates the existing scan list (the pattern may or may not be used in the current scan list). Creating a new pattern does not invalidate the existing scan list. Channel patterns are stored when you run the `createconfigscript()` command or `setup.save()` command.

Channel patterns are lost when power is cycled. Use `setup.recall()` or a script created with `createconfigscript()` to restore them.

If you change a pole setting for a channel that is associated with a channel pattern, the channel pattern is deleted. Be sure to configure the pole setting for channels (`channel.setpole`) before creating a channel pattern.

### Example

<code>channel.pattern.snapshot("voltagePath")</code>	Creates a pattern named <code>voltagePath</code> that contains the presently closed channels.
--	---

### Also see

[createconfigscript\(\)](#) (on page 7-47)  
[channel.pattern.catalog\(\)](#) (on page 7-35)  
[channel.pattern.delete\(\)](#) (on page 7-36)  
[channel.pattern.getimage\(\)](#) (on page 7-36)  
[channel.pattern.setimage\(\)](#) (on page 7-37)

## channel.reset()

This function resets the specified channel list items to factory default settings.

Type	TSP-Link accessible	Affected by	Where saved	Default value
Function	Yes			

### Usage

```
channel.reset(channelList)
```

<i>channelList</i>	A string that lists the items to reset; the string can include: <ul style="list-style-type: none"> <li>• <code>allslots</code></li> <li>• <code>slotX</code>, where <i>X</i> is the slot number</li> <li>• channel patterns</li> <li>• channels, including a range of channels</li> </ul>
--------------------	---

### Details

For the items specified in *channelList*, the following actions occur:

- Any closed channels open
- Additional user delay is set to zero (0)
- Labels are removed
- If the channel is forbidden to close, it is cleared from being forbidden to close
- If the channels are used in channel patterns, the channel patterns that contain the channels are deleted.

Using this function to reset a channel involved in scanning invalidates the existing scan list. The list has to be recreated before scanning again.

The rest of the instrument settings are unaffected. To reset the entire system to factory default settings, use the `reset()` command.

**Example 1**

<code>channel.reset("allslots")</code>	Performs a reset operation on all channels on the instrument.
--	---

**Example 2**

<code>channel.reset("slot1")</code>	Resets channels on slot 1 only.
-------------------------------------	---------------------------------

**Example 3**

<code>channel.reset("3A01:3A05")</code>	Resets only row 1, columns 1 through 5 on Slot 3.
---	---

**Example 4**

<code>channel.reset("5C05, 5D16")</code>	Resets row 3, column 5, and row 4 column 16, on slot 5.
--	---

**Also see**

[Channel functions and attributes](#) (on page 5-4)  
[reset\(\)](#) (on page 7-135)

## channel.setdelay()

This function sets additional delay time for specified channels.

Type	TSP-Link accessible	Affected by	Where saved	Default value
Function	Yes	Instrument reset Channel reset Recalls setup	Create configuration script Save setup	0

**Usage**

```
channel.setdelay(channelList, value)
```

<i>channelList</i>	A string listing the channels that need modifications to their delay time
<i>value</i>	Desired delay time for items in <i>channelList</i> . Minimum is 0 seconds

**Details**

The user delay is an additional delay that is added after a channel is closed. You can use this delay to allow additional settle time for a signal on that channel. For most cards, the resolution of the delay is 10  $\mu$ s. However, check the documentation for your card to verify. To see if the delay value was modified after setting, use the `channel.getdelay()` command to query.

Channel patterns get their delay from the channels that comprise the pattern. Therefore, specify the delay for a pattern through the channels. A pattern incurs the longest delay of all channels comprising that pattern.



An error message is generated if:

- The value is an invalid setting for the specified channel
- A channel pattern is specified
- The channel is for an empty slot

Command processing will stop as soon as an error is detected and no delay times will be modified.

## NOTE

Pseudocards do not replicate the additional delay time.

### Example 1

```
channel.setdelay("1A03, 1A05", 50e-6)
```

Sets row 1 and columns 3 and 5 of slot 1 for a delay time of 50 microseconds.

### Example 2

```
channel.setdelay("slot1", 0)
```

Sets the channels on slot 1 for 0 delay time.

### Also see

[channel.getdelay\(\)](#) (on page 7-26)

## channel.setforbidden()

This function prevents the closing of specified channels.

Type	TSP-Link accessible	Affected by	Where saved	Default value
Function	Yes	Instrument reset Channel reset Recall setup	Create configuration script Save setup	Not forbidden

### Usage

```
channel.setforbidden(channelList)
```

*channelList*

A string that lists the channels to make forbidden to close

### Details

The *channelList* parameter indicates the scope of channels affected and may include:

- `allslots` or `slotX` (where *X* equals 1 to 6 for Model 707B, or 1 for Model 708B)
- Channel ranges or individual channels

This function prevents all items contained in the channel list parameter from closing. It applies the "forbidden to close" attribute to the specified channels. To remove the "forbidden to close" attribute, use `channel.clearforbidden()`.

If a channel that is being set to forbidden is used in a channel pattern, the channel pattern is deleted when the channel is set to forbidden. Note that if the *channelList* parameter includes a channel pattern, the channel pattern will be deleted when the channels in the patterns are successfully set to forbidden to close.

The channels in the *channelList* parameter must be installed in the instrument.

If the scan list contains a channel that is forbidden, the scan list is invalidated.

**Example**

```
channel.pattern.setimage("1A01,1A02",
  "patternA")
channel.pattern.setimage("1B01,1B02",
  "patternB")
channel.pattern.setimage("1C01,1C02",
  "patternC")

for name in channel.pattern.catalog() do
  print(name .. " = " ..
    channel.pattern.getimage(name))
end

channel.setforbidden("1A02, 1B01")
for name in channel.pattern.catalog() do
  print(name .. " = " ..
    channel.pattern.getimage(name))
end
```

Create three channel patterns, and then print.

Set forbidden for one channel from patternA and patternB, then print the catalog again. Only patternC should remain.

Assuming no existing channel patterns, the output is:

```
patternC = 1C01,1C02
patternA = 1A01,1A02
patternB = 1B01,1B02
patternC = 1C01,1C02
```

**Also see**

[channel.clearforbidden\(\)](#) (on page 7-16)

[channel.getforbidden\(\)](#) (on page 7-27)

**channel.setlabel()**

This function sets the label associated with a channel.

Type	TSP-Link accessible	Affected by	Where saved	Default value
Function	Yes	Instrument reset Channel reset Recall setup	Create configuration script Save setup	No label

**Usage**

```
channel.setlabel(channelList, label)
```

<i>channelList</i>	A string that lists the channel to which to set the label
<i>label</i>	A string that represents the label for the channel in <i>channelList</i> , up to 19 characters

## Details

This command sets the label of the channel specified in *channelList* to the value specified in the *label* parameter. The channel attributes associated with each channel remain unchanged except for their labels.

The *label* parameter must be unique. In addition, it cannot be the same as the name of a channel pattern, row label, or column label. If you specify a label that already exists, an error message is generated that indicates a parameter error and channel that that is already associated the specified label.

To clear the label, set *label* to an empty string ( " ") or to a string with a space as the first character. After defining a label, you can use it to specify the channel instead of using the channel specifier.

An error is generated if:

- The card in the channel slot does not support a label setting
- The label contains a space; however, if the first character is a space, the label is cleared
- The label is already used to represent a channel pattern

The label does not persist through a power cycle.

### Example 1

```
channel.setlabel("1A01", "start")
channel.close("start")
print(channel.getclose("allslots"))
```

Sets the label for channel row 1 and column 01 on slot 1 to "start".  
Output:  
1A01

### Example 2

```
channel.setlabel("1A01", " ")
```

Clears the label for channel row 1 and column 01, slot 1 back to "1A01".

### Example 3

```
channel.setlabel("1A01", " ")
```

Also clears the label for channel row 1 and column 01, slot 1 back to "1A01".

### Also see

[channel functions and attributes](#) (on page 5-4)  
[channel.setlabelcolumn\(\)](#) (on page 7-44)  
[channel.setlabelrow\(\)](#) (on page 7-46)

## channel.setlabelcolumn()

This function assigns a label to a column.

Type	TSP-Link accessible	Affected by	Where saved	Default value
Function	Yes	Instrument reset Channel reset	Create configuration script	Empty string or blank

### Usage

```
channel.setlabelcolumn(channel, label)
```

<i>channel</i>	A string that specifies the channel that contains the column to which the label will be applied
<i>label</i>	A string that lists the label for the channel column, up to eight characters

## Details

A column label can be applied to columns of a matrix card. The label is then used on the display and can be accessed in a channel list (see [About channel commands](#) (on page 5-5)). For *channel*, you can specify any channel in the column. You cannot specify a channel pattern.

The row and column *label* parameters must be unique. In addition, they cannot be the same as the name of a channel pattern or channel label.

After defining a column label, you can use it with a row label to specify a channel instead of the channel specifier.

On the crosspoint display, the first four characters of the label are displayed. On the bottom display, the full label is displayed.

### NOTE

Since a column label is common to all channels in that column, you only need to assign the column label to one channel.

### Example 1

```
channel.setlabelrow("1B01", "SMU2")
channel.setlabelcolumn("1B02", "DUT2")
channel.close("SMU2+DUT2")
print(channel.getclose("allslots"))
```

Sets the label for the slot 1, row 2 to "SMU2" and slot 1, column 2 to "DUT2".  
Use the labels to close a channel.  
Output:  
1B02

### Example 2

```
channel.setlabelcolumn("1A01", "")
```

Clears the label for column 1 on slot 1 back to default.

### Example 3

```
channel.setlabelcolumn("1A01", " ")
```

Also clears the label for column 1 on slot 1 back to default.

### Example 4

```
channel.setlabelcolumn("2B01", "TwoC")
print(channel.getlabelcolumn("slot2"))
```

This example assumes a Model 7072 in slot 2.

Set the label to be TwoC, which assigns the label to all channels in the column. Output:

```
TwoC,,,,,,,,,,,,,TwoC,,,,,,,,,,,,,Tw
  oC,,,,,,,,,,,,,TwoC,,,,,,,,,,,,,T
  woC,,,,,,,,,,,,,TwoC,,,,,,,,,,,,,
TwoC,,,,,,,,,,,,,TwoC,,,,,,,,,,,,,
```

### Also see

[channel.getlabelcolumn\(\)](#) (on page 7-30)

[channel.getlabelrow\(\)](#) (on page 7-31)

[channel.setlabelrow\(\)](#) (on page 7-46)

## channel.setlabelrow()

This function assigns a label to a row.

Type	TSP-Link accessible	Affected by	Where saved	Default value
Function	Yes	Instrument reset Channel reset	Create configuration script	Empty string or blank

### Usage

```
channel.setlabelrow(channel, label)
```

<i>channel</i>	A string that specifies the channel that contains the row to which to apply a label.
<i>label</i>	A string that lists the label for the channel row, up to eight characters.

### Details

A row label can be applied to columns of a matrix card. The label is then used on the display and can be accessed in a channel list (see [About channel commands](#) (on page 5-5)). For *channel*, you can specify any channel in the row. You cannot specify a channel pattern.

The row and column *label* parameters must be unique. In addition, they cannot be the same as the name of a channel pattern.

You can only set labels for slots and channels that are installed in the instrument.

After defining a row label, you can use it to specify a channel instead of the default channel designation.

On the crosspoint display, the first four characters of the label are displayed. On the bottom display, the full label is displayed.

Labels can only be set for matrix cards.

## NOTE

Since a row label is common to all channels in that row, you only need to assign the row label to one channel.

### Example 1

```
channel.setlabelrow("1B01", "SMU2")
channel.setlabelcolumn("1B02", "DUT2")
channel.close("SMU2+DUT2")
print(channel.getclose("allslots"))
```

Sets the label for the slot 1, row 2 to "SMU2" and slot 1, column 2 to "DUT2".  
Use the labels to close a channel.  
Output:  
1B02

### Example 2

```
channel.setlabelrow("1A01", "")
```

Clears the label for row 1 on slot 1 back to default.

### Example 3

```
channel.setlabelrow("1A01", " ")
```

Also clears the label for row 1 on slot 1 back to default.

**Example 4**

```
channel.setlabelrow("2B01", "Row2")
print(channel.getlabelrow("slot2"))
```

This example assumes a 7072 in slot 2.

Set the label to be Row2, which assigns the label to all channels in the row. The output is now :

```

,Row2,Row2,Row2,Row2,Row2
,Row2,Row2,Row2,Row2,Row2,Row2,Row2,
,,,,,,,,,,,,,,,,,,,,,,,,,,,,,
,,,,,,,,,,,,,,,,,,,,,,,,,,,,,
,,,,,,,,
```

**Also see**

- [channel.getlabelcolumn\(\)](#) (on page 7-30)
- [channel.getlabelrow\(\)](#) (on page 7-31)
- [channel.setlabelcolumn\(\)](#) (on page 7-44)

---

## createconfigscript()

This function creates a setup file that captures most of the present settings of the instrument.

Type	TSP-Link accessible	Affected by	Where saved	Default value
Function	No			

**Usage**

```
createconfigscript(scriptName)
```

<i>scriptName</i>	A string that represents the name of the script that will be created
-------------------	--

**Details**

If *scriptName* is set to `autoexec`, the `autoexec` script in the instrument is replaced by the new configuration script.

If *scriptName* is set to the name of an existing script, the existing script is overwritten.

Once created, the script that contains the settings can be run and edited like any other script.

**Example**

```
createconfigscript("August2013")
```

Captures the present settings of the instrument into a script named `August2013`.

**Also see**

- [Create a configuration script](#) (on page 2-100)
- [Save the present configuration](#) (on page 2-98)

## dataqueue.add()

This function adds an entry to the data queue.

Type	TSP-Link accessible	Affected by	Where saved	Default value
Function	Yes			

### Usage

```
result = dataqueue.add(value)
result = dataqueue.add(value, timeout)
```

<i>result</i>	The resulting value of <code>true</code> or <code>false</code> based on the success of the function
<i>value</i>	The data item to add; <i>value</i> can be of any type
<i>timeout</i>	The maximum number of seconds to wait for space in the data queue

### Details

You cannot use the *timeout* value when accessing the data queue from a remote node (you can only use the *timeout* value while adding data to the local data queue).

The *timeout* value is ignored if the data queue is not full.

The `dataqueue.add()` function returns `false`:

- If the timeout expires before space is available in the data queue
- If the data queue is full and a *timeout* value is not specified

If the value is a table, a duplicate of the table and any subtables is made. The duplicate table does not contain any references to the original table or to any subtables.

### Example

<pre>dataqueue.clear() dataqueue.add(10) dataqueue.add(11, 2) result = dataqueue.add(12, 3) if result == false then   print("Failed to add 12 to the dataqueue") end print("The dataqueue contains:") while dataqueue.count &gt; 0 do   print(dataqueue.next()) end</pre>	<p>Clear the data queue. Each line adds one item to the data queue. Output: The dataqueue contains: 1.0000000e+01 1.1000000e+01 1.2000000e+01</p>
---	---

### Also see

- [dataqueue.CAPACITY](#) (on page 7-49)
- [dataqueue.clear\(\)](#) (on page 7-49)
- [dataqueue.count](#) (on page 7-50)
- [dataqueue.next\(\)](#) (on page 7-51)

## dataqueue.CAPACITY

This constant is the maximum number of entries that you can store in the data queue.

Type	TSP-Link accessible	Affected by	Where saved	Default value
Constant	Yes			

### Usage

```
count = dataqueue.CAPACITY
```

<code>count</code>	The variable that is assigned the value of <code>dataqueue.CAPACITY</code>
--------------------	--

### Details

This constant always returns the maximum number of entries that can be stored in the data queue.

### Example

```
MaxCount = dataqueue.CAPACITY
while dataqueue.count < MaxCount do
  dataqueue.add(1)
end
print("There are " .. dataqueue.count
  .. " items in the data queue")
```

This example fills the data queue until it is full and prints the number of items in the queue.  
Output:  
There are 128 items in the data queue

### Also see

[dataqueue.add\(\)](#) (on page 7-48)  
[dataqueue.clear\(\)](#) (on page 7-49)  
[dataqueue.count](#) (on page 7-50)  
[dataqueue.next\(\)](#) (on page 7-51)

## dataqueue.clear()

This function clears the data queue.

Type	TSP-Link accessible	Affected by	Where saved	Default value
Function	Yes			

### Usage

```
dataqueue.clear()
```

### Details

This function forces all `dataqueue.add()` commands that are in progress to time out and deletes all data from the data queue.



**Example**

```
MaxCount = dataqueue.CAPACITY
while dataqueue.count < MaxCount do
  dataqueue.add(1)
end
print("There are " .. dataqueue.count
  .. " items in the data queue")
dataqueue.clear()
print("There are " .. dataqueue.count
  .. " items in the data queue")
```

This example fills the data queue and prints the number of items in the queue. It then clears the queue and prints the number of items again.

Output:

```
There are 128 items in the data
  queue
There are 0 items in the data queue
```

**Also see**

[dataqueue.add\(\)](#) (on page 7-48)  
[dataqueue.CAPACITY](#) (on page 7-49)  
[dataqueue.count](#) (on page 7-50)  
[dataqueue.next\(\)](#) (on page 7-51)

**dataqueue.count**

This attribute contains the number of items in the data queue.

Type	TSP-Link accessible	Affected by	Where saved	Default value
Attribute (R)	Yes	Power cycle	Not saved	Not applicable

**Usage**

```
count = dataqueue.count
```

<code>count</code>	The number of items in the data queue
--------------------	---------------------------------------

**Details**

The count is updated as entries are added with `dataqueue.add()` and read from the data queue with `dataqueue.next()`. It is also updated when the data queue is cleared with `dataqueue.clear()`.

A maximum of `dataqueue.CAPACITY` items can be stored at any one time in the data queue.

**Example**

```
MaxCount = dataqueue.CAPACITY
while dataqueue.count < MaxCount do
  dataqueue.add(1)
end
print("There are " .. dataqueue.count
  .. " items in the data queue")
dataqueue.clear()
print("There are " .. dataqueue.count
  .. " items in the data queue")
```

This example fills the data queue and prints the number of items in the queue. It then clears the queue and prints the number of items again.

Output:

```
There are 128 items in the data queue
There are 0 items in the data queue
```

**Also see**

[dataqueue.add\(\)](#) (on page 7-48)  
[dataqueue.CAPACITY](#) (on page 7-49)  
[dataqueue.clear\(\)](#) (on page 7-49)  
[dataqueue.next\(\)](#) (on page 7-51)

## dataqueue.next()

This function removes the next entry from the data queue.

Type	TSP-Link accessible	Affected by	Where saved	Default value
Function	Yes			

### Usage

```
value = dataqueue.next()
value = dataqueue.next(timeout)
```

<i>value</i>	The next entry in the data queue
<i>timeout</i>	The number of seconds to wait for data in the queue

### Details

If the data queue is empty, the function waits up to the *timeout* value.

If data is not available in the data queue before the *timeout* expires, the return value is `nil`.

The entries in the data queue are removed in first-in, first-out (FIFO) order.

If the value is a table, a duplicate of the original table and any subtables is made. The duplicate table does not contain any references to the original table or to any subtables.

### Example

<pre>dataqueue.clear() for i = 1, 10 do   dataqueue.add(i) end print("There are " .. dataqueue.count   .. " items in the data queue")  while dataqueue.count &gt; 0 do   x = dataqueue.next()   print(x) end print("There are " .. dataqueue.count   .. " items in the data queue")</pre>	<p>Clears the data queue, adds ten entries, then reads the entries from the data queue. Note that your output may differ depending on the setting of <code>format.asciiprecision</code>.</p> <p><b>Output:</b></p> <pre>There are 10 items in the data queue 1.000000000e+00 2.000000000e+00 3.000000000e+00 4.000000000e+00 5.000000000e+00 6.000000000e+00 7.000000000e+00 8.000000000e+00 9.000000000e+00 1.000000000e+01 There are 0 items in the data queue</pre>
---	--

### Also see

[dataqueue.add\(\)](#) (on page 7-48)  
[dataqueue.CAPACITY](#) (on page 7-49)  
[dataqueue.clear\(\)](#) (on page 7-49)  
[dataqueue.count](#) (on page 7-50)  
[format.asciiprecision](#) (on page 7-89)

## delay()

This function delays the execution of the commands that follow it.

Type	TSP-Link accessible	Affected by	Where saved	Default value
Function	No			

### Usage

```
delay(seconds)
```

<i>seconds</i>	The number of seconds to delay (0 to 100,000 s)
----------------	---

### Details

The instrument delays execution of the commands for at least the specified number of seconds and fractional seconds. However, the processing time may cause the instrument to delay 5  $\mu$ s to 10  $\mu$ s (typical) more than the requested delay.

### Example

```
beeper.beep(0.5, 2400)
delay(0.250)
beeper.beep(0.5, 2400)
```

Emit a double-beep at 2400 Hz. The sequence is 0.5 s on, 0.25 s off, 0.5 s on.

### Also see

None

## digio.readbit()

This function reads one digital I/O line.

Type	TSP-Link accessible	Affected by	Where saved	Default value
Function	Yes			

### Usage

```
data = digio.readbit(N)
```

<i>data</i>	The state of the I/O line
<i>N</i>	Digital I/O line number to be read (1 to 14)

### Details

A returned value of zero (0) indicates that the line is low. A returned value of one (1) indicates that the line is high.

### Example

```
print(digio.readbit(4))
```

Assume line 4 is set high, and it is then read.  
Output:  
1.0000000e+00

**Also see**

[digio.readport\(\)](#) (on page 7-53)  
[digio.writebit\(\)](#) (on page 7-61)  
[digio.writeport\(\)](#) (on page 7-62)  
[Digital I/O port](#) (on page 2-7)

**digio.readport()**

This function reads the digital I/O port.

Type	TSP-Link accessible	Affected by	Where saved	Default value
Function	Yes			

**Usage**

```
data = digio.readport()
```

<i>data</i>	The present value of the input lines on the digital I/O port
-------------	--

**Details**

The binary equivalent of the returned value indicates the value of the input lines on the I/O port. The least significant bit (bit B1) of the binary number corresponds to line 1; bit B14 corresponds to line 14. For example, a returned value of 170 has a binary equivalent of 000000010101010, which indicates that lines 2, 4, 6, and 8 are high (1), and the other 10 lines are low (0).

**Example**

```
data = digio.readport()
print(data)
```

Assume lines 2, 4, 6, and 8 are set high when the I/O port is read.

Output:  
1.7000000e+02

This is binary 10101010

**Also see**

[digio.readbit\(\)](#) (on page 7-52)  
[digio.writebit\(\)](#) (on page 7-61)  
[digio.writeport\(\)](#) (on page 7-62)  
[Digital I/O port](#) (on page 2-7)

**digio.trigger[N].assert()**

This function asserts a trigger pulse on one of the digital I/O lines.

Type	TSP-Link accessible	Affected by	Where saved	Default value
Function	Yes			

**Usage**

```
digio.trigger[N].assert()
```

<i>N</i>	Digital I/O trigger line (1 to 14)
----------	------------------------------------

**Details**

The pulse width that is set determines how long the instrument asserts the trigger.

**Example**

```
digio.trigger[2].assert()
```

Asserts a trigger on digital I/O line 2.

**Also see**

[digio.trigger\[N\].pulsewidth](#) (on page 7-57)

**digio.trigger[N].clear()**

This function clears the trigger event on a digital I/O line.

Type	TSP-Link accessible	Affected by	Where saved	Default value
Function	Yes			

**Usage**

```
digio.trigger[N].clear()
```

<i>N</i>	Digital I/O trigger line (1 to 14)
----------	------------------------------------

**Details**

The event detector of a trigger enters the detected state when an event is detected. It is cleared when `digio.trigger[N].wait()` or `digio.trigger[N].clear()` is called.

`digio.trigger[N].clear()` clears the event detector of the specified trigger line, discards the history of the trigger line, and clears the `digio.trigger[N].overrun` attribute.

**Example**

```
digio.trigger[2].clear()
```

Clears the trigger event detector on I/O line 2.

**Also see**

[digio.trigger\[N\].overrun](#) (on page 7-57)

[digio.trigger\[N\].wait\(\)](#) (on page 7-61)

**digio.trigger[N].EVENT\_ID**

This constant identifies the trigger event generated by the digital I/O line *N*.

Type	TSP-Link accessible	Affected by	Where saved	Default value
Constant	Yes			

**Usage**

```
eventID = digio.trigger[N].EVENT_ID
```

<i>eventID</i>	The trigger event number
<i>N</i>	Digital I/O trigger line (1 to 14)

**Details**

To have another trigger object respond to trigger events generated by the trigger line, set the other object's stimulus attribute to the value of this constant.

**Example 1**

```
digio.trigger[5].stimulus = digio.trigger[3].EVENT_ID
```

Uses a trigger event on digital I/O trigger line 3 to be the stimulus for digital I/O trigger line 5.

**Example 2**

```
scan.trigger.arm.stimulus =
  digio.trigger[3].EVENT_ID
```

Uses a trigger event on digital I/O trigger line 3 to be the stimulus for starting a scan.

**Also see**

None

**digio.trigger[N].mode**

This attribute sets the mode in which the trigger event detector and the output trigger generator operate on the given trigger line.

Type	TSP-Link accessible	Affected by	Where saved	Default value
Attribute (RW)	Yes	Instrument reset Digital I/O trigger <i>N</i> reset Recall setup	Create configuration script	0 (digio.TRIG_BYPASS)

**Usage**

```
triggerMode = digio.trigger[N].mode
digio.trigger[N].mode = triggerMode
```

<i>triggerMode</i>	The trigger mode; see <b>Details</b> for values
<i>N</i>	Digital I/O trigger line (1 to 14)

## Details

---

Set *triggerMode* to one of the following values:

### Trigger mode values

<i>triggerMode</i>	Description
<code>digio.TRIG_BYPASS</code> or 0	Allows direct control of the line.
<code>digio.TRIG_FALLING</code> or 1	Detects falling-edge triggers as input; asserts a TTL-low pulse for output.
<code>digio.TRIG_RISING</code> or 2	If the programmed state of the line is high, the <code>digio.TRIG_RISING</code> mode behavior is similar to <code>digio.TRIG_RISINGA</code> . If the programmed state of the line is low, the <code>digio.TRIG_RISING</code> mode behavior is similar to <code>digio.TRIG_RISINGM</code> . This setting should only be used if necessary for compatibility with other Keithley Instruments products.
<code>digio.TRIG_EITHER</code> or 3	Detects rising- or falling-edge triggers as input. Asserts a TTL-low pulse for output.
<code>digio.TRIG_SYNCHRONOUS</code> or 4	Detects the falling-edge input triggers and automatically latches and drives the trigger line low. Asserting the output trigger releases the latched line.
<code>digio.TRIG_SYNCHRONOUSM</code> or 5	Detects the falling-edge input triggers and automatically latches and drives the trigger line low. Asserts a TTL-low pulse as an output trigger.
<code>digio.TRIG_SYNCHRONOUSA</code> or 6	Detects rising-edge triggers as input. Asserts a TTL-low pulse for output.
<code>digio.TRIG_RISINGA</code> or 7	Detects rising-edge triggers as input. Asserts a TTL-low pulse for output.
<code>digio.TRIG_RISINGM</code> or 8	Asserts a TTL-high pulse for output. Input edge detection is not possible in this mode.

When programmed to any mode except `digio.TRIG_BYPASS`, the output state of the I/O line is controlled by the trigger logic, and the user-specified output state of the line is ignored.

Use of either `digio.TRIG_SYNCHRONOUSA` or `digio.TRIG_SYNCHRONOUSM` is preferred over `digio.TRIG_SYNCHRONOUS`, because `digio.TRIG_SYNCHRONOUS` is provided for compatibility with the digital I/O and TSP-Link triggering on other Keithley Instruments products.

To control the line state, set the mode to `digio.TRIG_BYPASS` and use the `digio.writebit()` and `digio.writeport()` commands.

### Example

---

<code>digio.trigger[4].mode = 2</code>	Sets the trigger mode for I/O line 4 to <code>digio.TRIG_RISING</code> .
--	--

### Also see

---

[digio.trigger\[N\].clear\(\)](#) (on page 7-54)  
[digio.trigger\[N\].reset\(\)](#) (on page 7-58)  
[digio.writebit\(\)](#) (on page 7-61)  
[digio.writeport\(\)](#) (on page 7-62)  
[Scanning and triggering](#) (on page 3-1)

## digio.trigger[N].overrun

This attribute returns the event detector overrun status.

Type	TSP-Link accessible	Affected by	Where saved	Default value
Attribute (R)	Yes	Instrument reset Digital I/O trigger <i>N</i> clear Digital I/O trigger <i>N</i> reset Recall setup	Not saved	Not applicable

### Usage

```
overrun = digio.trigger[N].overrun
```

<i>overrun</i>	Trigger overrun state (true or false)
<i>N</i>	Digital I/O trigger line (1 to 14)

### Details

If this is `true`, an event was ignored because the event detector was already in the detected state when the event occurred.

This is an indication of the state of the event detector built into the line itself. It does not indicate if an overrun occurred in any other part of the trigger model or in any other detector that is monitoring the event.

### Example

```
overrun = digio.trigger[1].overrun
print(overrun)
```

If there is no trigger overrun, the following text is output:  
`false`

### Also see

[digio.trigger\[N\].clear\(\)](#) (on page 7-54)

[digio.trigger\[N\].reset\(\)](#) (on page 7-58)

## digio.trigger[N].pulsewidth

This attribute describes the length of time that the trigger line is asserted for output triggers.

Type	TSP-Link accessible	Affected by	Where saved	Default value
Attribute (RW)	Yes	Instrument reset Digital I/O trigger <i>N</i> reset Recall setup	Create configuration script	10e-6 (10 $\mu$ s)

### Usage

```
width = digio.trigger[N].pulsewidth
digio.trigger[N].pulsewidth = width
```

<i>width</i>	The pulse width (seconds)
<i>N</i>	Digital I/O trigger line (1 to 14)

### Details

Setting the pulse width to zero (0) seconds asserts the trigger indefinitely. To release the trigger line, use `digio.trigger[N].release()`.



**Example**

```
digio.trigger[4].pulsewidth = 20e-6
```

Sets the pulse width for trigger line 4 to 20  $\mu$ s.

**Also see**

[digio.trigger\[N\].assert\(\)](#) (on page 7-53)

[digio.trigger\[N\].reset\(\)](#) (on page 7-58)

[digio.trigger\[N\].release\(\)](#) (on page 7-58)

**digio.trigger[N].release()**

This function releases an indefinite length or latched trigger.

Type	TSP-Link accessible	Affected by	Where saved	Default value
Function	Yes			

**Usage**

```
digio.trigger[N].release()
```

<i>N</i>	Digital I/O trigger line (1 to 14)
----------	------------------------------------

**Details**

Releases a trigger that was asserted with an indefinite pulsewidth time. It also releases a trigger that was latched in response to receiving a synchronous mode trigger. Only the specified trigger line is affected.

**Example**

```
digio.trigger[4].release()
```

Releases digital I/O trigger line 4.

**Also see**

[digio.trigger\[N\].assert\(\)](#) (on page 7-53)

[digio.trigger\[N\].pulsewidth](#) (on page 7-57)

**digio.trigger[N].reset()**

This function resets trigger values to their factory defaults.

Type	TSP-Link accessible	Affected by	Where saved	Default value
Function	Yes			

**Usage**

```
digio.trigger[N].reset()
```

<i>N</i>	Digital I/O trigger line (1 to 14)
----------	------------------------------------

## Details

This function resets the following attributes to factory default settings:

- `digio.trigger[N].mode`
- `digio.trigger[N].pulsewidth`
- `digio.trigger[N].stimulus`

It also clears `digio.trigger[N].overrun`.

## Example

```
digio.trigger[3].mode = 2
digio.trigger[3].pulsewidth = 50e-6
digio.trigger[3].stimulus = digio.trigger[5].EVENT_ID
print(digio.trigger[3].mode, digio.trigger[3].pulsewidth,
      digio.trigger[3].stimulus)
digio.trigger[3].reset()
print(digio.trigger[3].mode, digio.trigger[3].pulsewidth,
      digio.trigger[3].stimulus)
```

Set the digital I/O trigger line 3 for a falling edge with a pulsewidth of 50 microseconds.

Use digital I/O line 5 to trigger the event on line 3.

Reset the line back to factory default values.

Output before reset:

```
2.0000000e+00      5.0000000e-05      5.0000000e+00
```

Output after reset:

```
0.0000000e+00      1.0000000e-05      0.0000000e+00
```

## Also see

[digio.trigger\[N\].mode](#) (on page 7-55)

[digio.trigger\[N\].overrun](#) (on page 7-57)

[digio.trigger\[N\].pulsewidth](#) (on page 7-57)

[digio.trigger\[N\].stimulus](#) (on page 7-59)

## digio.trigger[N].stimulus

This attribute selects the event that causes a trigger to be asserted on the digital output line.

Type	TSP-Link accessible	Affected by	Where saved	Default value
Attribute (RW)	Yes	Instrument reset Digital I/O trigger <i>N</i> reset Save setup	Create configuration script	0

## Usage

```
triggerStimulus = digio.trigger[N].stimulus
```

```
digio.trigger[N].stimulus = triggerStimulus
```

<i>triggerStimulus</i>	The event identifier for the triggering event.
<i>N</i>	Digital I/O trigger line (1 to 14).

## Details

---

Set this attribute to zero (0) to disable the automatic trigger output.

Do not use the stimulus attribute for generating output triggers under script control. Use `digio.trigger[N].assert()` instead.

The trigger stimulus for a digital I/O line may be set to one of the existing trigger event IDs, described in the following table.

### Trigger event IDs

Trigger event ID	Description
<code>digio.trigger[N].EVENT_ID</code>	An edge (either rising, falling, or either based on the configuration of the line) on the digital input line.
<code>display.trigger.EVENT_ID</code>	The trigger key on the front panel is pressed.
<code>trigger.EVENT_ID</code>	A *trg message on the active command interface. If GPIB is the active command interface, a GET message also generates this event.
<code>trigger.blender[N].EVENT_ID</code>	A combination of events has occurred.
<code>trigger.timer[N].EVENT_ID</code>	A delay expired.
<code>tsplink.trigger[N].EVENT_ID</code>	An edge (either rising, falling, or either based on the configuration of the line) on the TSP-Link trigger line.
<code>lan.trigger[N].EVENT_ID</code>	A LAN trigger event has occurred.
<code>scan.trigger.EVENT_SCAN_READY</code>	Scan ready event.
<code>scan.trigger.EVENT_SCAN_START</code>	Scan start event.
<code>scan.trigger.EVENT_CHANNEL_READY</code>	Channel ready event.
<code>scan.trigger.EVENT_SCAN_COMP</code>	Scan complete event.
<code>scan.trigger.EVENT_IDLE</code>	Idle event.

### Example 1

---

```
digio.trigger[3].stimulus = 0
```

Clear the trigger stimulus of digital I/O line 3.

### Example 2

---

```
digio.trigger[3].stimulus = scan.trigger.EVENT_CHANNEL_READY
```

Set the trigger stimulus of digital I/O line 3 to be the channel ready event during a scan.

### Also see

---

[digio.trigger\[N\].assert\(\)](#) (on page 7-53)

[digio.trigger\[N\].clear\(\)](#) (on page 7-54)

[digio.trigger\[N\].reset\(\)](#) (on page 7-58)

## digio.trigger[N].wait()

This function waits for a trigger.

Type	TSP-Link accessible	Affected by	Where saved	Default value
Function	Yes			

### Usage

```
triggered = digio.trigger[N].wait(timeout)
```

<i>triggered</i>	The value <code>true</code> if a trigger is detected, or <code>false</code> if no triggers are detected during the timeout period
<i>N</i>	Digital I/O trigger line (1 to 14)
<i>timeout</i>	Timeout in seconds

### Details

This function pauses for up to *timeout* seconds for an input trigger. If one or more trigger events are detected since the last time `digio.trigger[N].wait()` or `digio.trigger[N].clear()` was called, this function returns a value immediately. After waiting for a trigger with this function, the event detector is automatically reset and ready to detect the next trigger. This is true regardless of the number of events detected.

### Example

```
triggered = digio.trigger[4].wait(3)
print(triggered)
```

Waits up to three seconds for a trigger to be detected on trigger line 4, then outputs the results.  
 Output if no trigger is detected:  
`false`  
 Output if a trigger is detected:  
`true`

### Also see

[digio.trigger\[N\].clear\(\)](#) (on page 7-54)

## digio.writebit()

This function sets a digital I/O line high or low.

Type	TSP-Link accessible	Affected by	Where saved	Default value
Function	Yes			

### Usage

```
digio.writebit(N, data)
```

<i>N</i>	Digital I/O trigger line (1 to 14)
<i>data</i>	The value to write to the bit: <ul style="list-style-type: none"> <li>• 0 (low)</li> <li>• Non-zero (high)</li> </ul>

## Details

If the output line is write-protected using the `digio.writeprotect` attribute, the command is ignored.

The `reset()` function does not affect the present state of the digital I/O lines.

Use the `digio.writebit()` and `digio.writeport()` commands to control the output state of the synchronization line when trigger operation is set to `digio.TRIG_BYPASS`.

The data must be zero (0) to clear the bit. Any value other than zero (0) sets the bit.

## Example

```
digio.writebit(4, 0) Sets digital I/O line 4 low (0).
```

## Also see

[digio.readbit\(\)](#) (on page 7-52)  
[digio.readport\(\)](#) (on page 7-53)  
[digio.trigger\[N\].mode](#) (on page 7-55)  
[digio.writeport\(\)](#) (on page 7-62)  
[digio.writeprotect](#) (on page 7-63)

# digio.writeport()

This function writes to all digital I/O lines.

Type	TSP-Link accessible	Affected by	Where saved	Default value
Function	Yes			

## Usage

```
digio.writeport(data)
```

```
data Value to write to the port (0 to 16383)
```

## Details

The binary representation of *data* indicates the output pattern to be written to the I/O port. For example, a *data* value of 170 has a binary equivalent of 00000010101010. Lines 2, 4, 6, and 8 are set high (1), and the other 10 lines are set low (0).

Write-protected lines are not changed.

The `reset()` function does not affect the present states of the digital I/O lines.

Use the `digio.writebit()` and `digio.writeport()` commands to control the output state of the synchronization line when trigger operation is set to `digio.TRIG_BYPASS`.

## Example

```
digio.writeport(255) Sets digital I/O Lines 1 through 8 high (binary 00000011111111).
```

## Also see

[digio.readbit\(\)](#) (on page 7-52)  
[digio.readport\(\)](#) (on page 7-53)  
[digio.writebit\(\)](#) (on page 7-61)  
[digio.writeprotect](#) (on page 7-63)

## digio.writeprotect

This attribute contains the write-protect mask that protects bits from changes from the `digio.writebit()` and `digio.writeport()` functions.

Type	TSP-Link accessible	Affected by	Where saved	Default value
Attribute (RW)	Yes	Instrument reset Recall setup	Create configuration script	0

### Usage

```
mask = digio.writeprotect
digio.writeprotect = mask
```

<code>mask</code>	Sets the value that specifies the bit pattern for write-protect
-------------------	---

### Details

Bits that are set to one cause the corresponding line to be write-protected.

The binary equivalent of `mask` indicates the mask to be set for the I/O port. For example, a mask value of 7 has a binary equivalent of 00000000000111. This mask write-protects lines 1, 2, and 3.

### Example

<code>digio.writeprotect = 15</code>	Write-protects lines 1, 2, 3, and 4.
--------------------------------------	--------------------------------------

### Also see

[digio.writebit\(\)](#) (on page 7-61)  
[digio.writeport\(\)](#) (on page 7-62)

## display.clear()

This function clears all lines of the display.

Type	TSP-Link accessible	Affected by	Where saved	Default value
Function	Yes			

### Usage

```
display.clear()
```

### Details

This function switches to the user screen and then clears the display.

The `display.clear()`, `display.setcursor()`, and `display.settext()` functions are overlapped commands. That is, the script does not wait for one of these commands to complete. These functions do not immediately update the display. For performance considerations, they update the physical display as soon as processing time becomes available.

### Also see

[display.setcursor\(\)](#) (on page 7-77)  
[display.settext\(\)](#) (on page 7-79)

## display.getannunciators()

This function reads the annunciators (indicators) that are presently turned on.

Type	TSP-Link accessible	Affected by	Where saved	Default value
Function	Yes			

### Usage

```
annunciators = display.getannunciators()
```

<i>annunciators</i>	The bitmasked value that shows which indicators are turned on
---------------------	---

### Details

This function returns a bitmasked value showing which indicators are turned on. The 16-bit binary equivalent of the returned value is the bitmask. The return value is a sum of set annunciators, based on the weighted value, as shown in the following table.

Annunciator (indicator) bitmasked values and equivalent constants			
Indicator	Bit	Weighted value	Equivalent constant
FILT	1	1	display.ANNUNCIATOR_FILTER
MATH	2	2	display.ANNUNCIATOR_MATH
4W	3	4	display.ANNUNCIATOR_4_WIRE
AUTO	4	8	display.ANNUNCIATOR_AUTO
ARM	5	16	display.ANNUNCIATOR_ARM
TRIG	6	32	display.ANNUNCIATOR_TRIGGER
*(star)	7	64	display.ANNUNCIATOR_STAR
SMPL	8	128	display.ANNUNCIATOR_SAMPLE
EDIT	9	256	display.ANNUNCIATOR_EDIT
ERR	10	512	display.ANNUNCIATOR_ERROR
REM	11	1024	display.ANNUNCIATOR_REMOTE
TALK	12	2048	display.ANNUNCIATOR_TALK
LSTN	13	4096	display.ANNUNCIATOR_LISTEN
SRQ	14	8192	display.ANNUNCIATOR_SRQ
REAR	15	16384	display.ANNUNCIATOR_REAR
REL	16	32768	display.ANNUNCIATOR_REL

### Example 1

```
testAnnunciators = display.getannunciators()
print(testAnnunciators)

rem = bit.bitand(testAnnunciators, 1024)
if rem > 0 then
    print("REM is on")
else
    print("REM is off")
end
```

```
REM indicator is turned on.
Output:
1.2800000e+03
REM is on
```

**Example 2**

<pre>print(display.ANNUNCIATOR_EDIT)</pre>	Output: 2.5600000e+02
<pre>print(display.ANNUNCIATOR_TRIGGER)</pre>	3.2000000e+01
<pre>print(display.ANNUNCIATOR_AUTO)</pre>	8.0000000e+00

**Also see**

[bit.bitand\(\)](#) (on page 7-9)

**display.getcursor()**

This function reads the present position of the cursor on the front panel display.

Type	TSP-Link accessible	Affected by	Where saved	Default value
Function	Yes			

**Usage**

```
row, column, style = display.getcursor()
```

<i>row</i>	The row where the cursor is: 1 (top row); 2 (bottom row)
<i>column</i>	The column where the cursor is: <ul style="list-style-type: none"> <li>If the cursor is in the top row: 1 to 20</li> <li>If the cursor is in the bottom row: 1 to 32</li> </ul>
<i>style</i>	Visibility of the cursor: 0 (invisible cursor); 1 (blinking cursor)

**Details**

This function switches the display to the user screen (the text set by `display.settext()`), and then returns values to indicate the cursor's row and column position and cursor style.

Columns are numbered from left to right on the display.

**Example 1**

<pre>testRow, testColumn = display.getcursor() print(testRow, testColumn)</pre>	This example reads the cursor position into local variables and prints them. Example output: 1.0000000e+00      1.0000000e+00
---	---

**Example 2**

<pre>print(display.getcursor())</pre>	This example prints the cursor position directly. In this example, the cursor is in row 1 at column 3, with an invisible cursor: 1.0000000e+00    3.0000000e+00 0.0000000e+00
---------------------------------------	---

**Also see**

[display.gettext\(\)](#) (on page 7-67)

[display.screen](#) (on page 7-75)

[display.setcursor\(\)](#) (on page 7-77)

[display.settext\(\)](#) (on page 7-79)



## display.getlastkey()

This function retrieves the key code for the last pressed key.

Type	TSP-Link accessible	Affected by	Where saved	Default value
Function	Yes			

### Usage

```
keyCode = display.getlastkey()
```

<i>keyCode</i>	A returned value that represents the last front-panel key pressed; see <b>Details</b> for more information
----------------	--

### Details

A history of the key code for the last pressed front-panel key is maintained by the instrument. When the instrument is turned on, or when it is transitioning from local to remote operation, the key code is set to 0 (`display.KEY_NONE`).

Pressing the EXIT (LOCAL) key normally aborts a script. To use this function with the EXIT (LOCAL) key, you must set `display.locallockout` to `display.LOCK`.

The table below lists the *keyCode* value for each front-panel action.

#### Key codes

Value	Key list	Value	Key list
0	<code>display.KEY_NONE</code>	83	<code>display.KEY_RUN</code>
66	<code>display.KEY_DELETE</code>	84	<code>display.KEY_TRIG</code>
67	<code>display.KEY_EXIT</code>	86	<code>display.KEY_STEP</code>
69	<code>display.KEY_CLOSE</code>	87	<code>display.KEY_CHAN</code>
70	<code>display.KEY_SLOT</code>	90	<code>display.KEY_INSERT</code>
72	<code>display.KEY_DISPLAY</code>	91	<code>display.KEY_MENU</code>
74	<code>display.KEY_ENTER</code>	93	<code>display.KEY_OPEN</code>
76	<code>display.KEY_LOAD</code>	94	<code>display.KEY_PATT</code>
77	<code>display.KEY_SCAN</code>	97	<code>display.WHEEL_ENTER</code>
79	<code>display.KEY_OPENALL</code>	107	<code>display.WHEEL_LEFT</code>
80	<code>display.KEY_CONFIG</code>	114	<code>display.WHEEL_RIGHT</code>

## NOTE

When using this function, use built-in constants, such as `display.KEY_STEP`, rather than the numeric value, such as 86. This allows for better forward compatibility with firmware revisions.

**Example**

```
key = display.getlastkey()
print(key)
```

On the front panel, press the **MENU** key and then send the code shown here. This retrieves the key code for the last pressed key.

Output:  
6.8000000e+01

**Also see**

[display.locallockout](#) (on page 7-72)

[display.sendkey\(\)](#) (on page 7-76)

## display.gettext()

This function reads the text displayed on the instrument front panel.

Type	TSP-Link accessible	Affected by	Where saved	Default value
Function	Yes			

**Usage**

```
text = display.gettext()
text = display.gettext(embellished)
text = display.gettext(embellished, row)
text = display.gettext(embellished, row, columnStart)
text = display.gettext(embellished, row, columnStart, columnEnd)
```

<i>text</i>	The returned value, which contains the text that is presently displayed
<i>embellished</i>	Indicates type of returned text: <i>false</i> (simple text); <i>true</i> (text with embedded character codes)
<i>row</i>	Selects the row from which to read the text: 1 (row 1); 2 (row 2). If <i>row</i> is not included, both rows of text are read
<i>columnStart</i>	Selects the first column from which to read text; for row 1, the valid column numbers are 1 to 20; for row 2, the valid column numbers are 1 to 32; if nothing is selected, 1 is used
<i>columnEnd</i>	Selects the last column from which to read text; for row 1, the valid column numbers are 1 to 20; for row 2, the valid column numbers are 1 to 32; the default is 20 for row 1, and 32 for row 2

**Details**

Using the command without any parameters returns both lines of the display.

The  $\$N$  character code is included in the returned value to show where the top line ends and the bottom line begins. This is not affected by the value of *embellished*.

When *embellished* is set to *true*, all other character codes are returned along with the message. When *embellished* is set to *false*, only the message and the  $\$N$  character code is returned. For information on the embedded character codes, see [display.settext\(\)](#) (on page 7-79).

The display is not switched to the user screen (the screen set using `display.settext()`). Text will be read from the active screen.

**Example 1**

```
display.clear()
display.setcursor(1, 1)
display.settext("ABCDEFGH IJ$DKLMNOPQRST")
display.setcursor(2, 1)
display.settext("abcdefghi jklm$Bnopqrstuvwxyz$F123456")
print(display.gettext())
print(display.gettext(true))
print(display.gettext(false, 2))
print(display.gettext(true, 2, 9))
print(display.gettext(false, 2, 9, 10))
```

This example shows how to retrieve the display text in multiple ways. The output is:

```
ABCDEFGH IJDKLMNOPQRST$Nabcdefghi jklmnopqrstuvwxyz123456
$RABCDEFGH IJ$DKLMNOPQRST$N$Rabcdefghi jklm$Bnopqrstuvwxyz$F123456
abcdefghi jklmnopqrstuvwxyz123456
$Rijklm$Bnopqrstuvwxyz$F123456
ij
```

**Example 2**

```
display.clear()
display.settext("User Screen")
text = display.gettext()
print(text)
```

This outputs all text in both lines of the display:

```
User Screen      $N
```

This indicates that the message "User Screen" is on the top line. The bottom line is blank.

**Also see**

[display.clear\(\)](#) (on page 7-63)

[display.getcursor\(\)](#) (on page 7-65)

[display.setcursor\(\)](#) (on page 7-77)

[display.settext\(\)](#) (on page 7-79)

## display.inputvalue()

This function displays a formatted input field on the instrument display that the operator can edit.

Type	TSP-Link accessible	Affected by	Where saved	Default value
Function	Yes			

**Usage**

```
display.inputvalue(format)
display.inputvalue(format, default)
display.inputvalue(format, default, minimum)
display.inputvalue(format, default, minimum, maximum)
```

<i>format</i>	A string that defines how the input field is formatted; see Details for more information
<i>default</i>	The default value for the input value
<i>minimum</i>	The minimum input value
<i>maximum</i>	The maximum input value

## Details

The *format* parameter uses zeros (0), the decimal point, polarity sign, and exponents to define how the input field is formatted. The *format* parameter can include the options shown in the following table.

Option	Description	Examples
E	Include the E to display the value exponentially	0.00000e+0
+	Allows operators to enter positive or negative values; if the "+" sign is not included, the operator cannot enter a negative value	+0.00
0	Defines the digit positions for the value; you can use up to six zeros (0)	+00.0000e+00
.	Include to have a decimal point appear in the value	+0.00



The *default* parameter is the value shown when the value is first displayed.

The *minimum* and *maximum* parameters can be used to limit the values that can be entered. When + is not selected for *format*, the minimum limit must be more than or equal to zero (0). When limits are used, you cannot enter values above or below these limits.

The input value is limited to  $\pm 1e37$ .

Before calling `display.inputvalue()`, you should send a message prompt to the operator using `display.prompt()`. Make sure to position the cursor where the edit field should appear.

After this command is sent, script execution pauses until you enter a value and press the **ENTER** key.

For positive and negative entry (plus sign (+) used for the value field and/or the exponent field), polarity of a nonzero value or exponent can be toggled by positioning the cursor on the polarity sign and turning the navigation wheel . Polarity will also toggle when using the navigation wheel  to decrease or increase the value or exponent past zero. A zero (0) value or exponent (for example, +00) is always positive and cannot be toggled to negative polarity.

After executing this command and pressing the EXIT (LOCAL) key, the function returns `nil`.

## Example

```
display.clear()
display.setText("Enter value between$N -0.10 and 2.00: ")
value = display.inputvalue("+0.00", 0.5, -0.1, 2.0)
print("Value entered = ", value)
```

Displays an editable field (+0.50) for operator input. The valid input range is -0.10 to +2.00, with a default of 0.50.

Output:

```
Value entered = 1.350000e+00
```

## Also see

[display.prompt\(\)](#) (on page 7-74)

[display.setcursor\(\)](#) (on page 7-77)

[display.setText\(\)](#) (on page 7-79)

## display.loadmenu.add()

This function adds an entry to the USER TESTS menu, which can be accessed by pressing the **LOAD** key on the instrument front panel.

Type	TSP-Link accessible	Affected by	Where saved	Default value
Function	Yes			

### Usage

```
display.loadmenu.add(displayName, code)
display.loadmenu.add(displayName, code, memory)
```

<i>displayName</i>	The name that is added to the USER TESTS menu
<i>code</i>	The code that is run from the USER TESTS menu
<i>memory</i>	Determines if code is saved to nonvolatile memory: 0 or <code>display.DONT_SAVE</code> : Does not save the code to nonvolatile memory 1 or <code>display.SAVE</code> : Saves the code to nonvolatile memory (default)

### Details

After adding code to the load menu, you can run it from the front panel by pressing the **LOAD** key, then selecting **USER** to select from the available code to load. Pressing the **RUN** key will then run the script.

You can add items in any order. They are always displayed in alphabetic order when the menu is selected.

Any Lua code can be included in the *code* parameter. If *memory* is set to `display.SAVE`, the entry (name and code) is saved in nonvolatile memory. Scripts, functions, and variables used in the code are not saved by `display.SAVE`. Functions and variables need to be saved with the code. If the code is not saved in nonvolatile memory, it will be lost when the Models 707B and 708B is turned off. See **Example 2** below.

If you do not make a selection for *memory*, the code is automatically saved to nonvolatile memory.

### Quick Tip

You can create a script that defines several functions, and then use the `display.loadmenu.add()` command to add items that call those individual functions. This allows the operator to run tests from the front panel.

### Example 1

```
display.loadmenu.add("Test9", "Test9()")
```

Assume a user script named "Test9" has been loaded into the run-time environment. Adds the menu entry to the User menu to run the script after loading.

**Example 2**

```
display.loadmenu.add(
  "Test", "DUT1() beeper.beep(2, 500)",
  display.SAVE)
```

Assume a script with a function named "DUT1" has already been loaded into the instrument, and the script has NOT been saved in nonvolatile memory.

Now assume you want to add a test named "Test" to the USER TESTS menu. You want the test to run the function named "DUT1" and sound the beeper. This example adds "Test" to the menu, defines the code, and then saves the `displayName` and code in nonvolatile memory.

When "Test" is run from the front panel USER TESTS menu, the function named "DUT1" executes and the beeper beeps for two seconds.

Now assume you turn off instrument power. Because the script was not saved in nonvolatile memory, the function named "DUT1" is lost when you turn the instrument on. When "Test" is again run from the front panel, an error is generated because DUT1 no longer exists in the instrument as a function.

**Example 3**

```
display.loadmenu.add("Part1",
  "testpart([[Part1]], 5.0)", display.SAVE)
```

Adds an entry called "Part1" to the front panel "USER TESTS" load menu for the code `testpart([[Part1]], 5.0)`, and saves it in nonvolatile memory.

**Also see**

[display.loadmenu.delete\(\)](#) (on page 7-72)

**display.loadmenu.catalog()**

This function creates an iterator for the user menu items accessed using the LOAD key on the instrument front panel.

Type	TSP-Link accessible	Affected by	Where saved	Default value
Function	No			

**Usage**

```
for displayName in display.loadmenu.catalog() do body end
for displayName, code in display.loadmenu.catalog() do body end
```

<i>displayName</i>	The name displayed in the menu
<i>code</i>	The code associated with the <i>displayName</i>
<i>body</i>	The body of the code to process the entries in the loop

## Details

Each time through the loop, *displayName* and *code* will take on the values in the USER TESTS menu.

The instrument goes through the list in random order.

## Example

```
for displayName, code in
  display.loadmenu.catalog() do
  print(displayName, code)
end
```

Output:  
Test DUT1() beeper.beep(2, 500)  
Part1 testpart([[Part1]], 5.0)  
Test9 Test9()

## Also see

[display.loadmenu.add\(\)](#) (on page 7-70)  
[display.loadmenu.delete\(\)](#) (on page 7-72)

## display.loadmenu.delete()

This function removes an entry from the USER TESTS menu, which can be accessed using the **LOAD** key on the instrument front panel.

Type	TSP-Link accessible	Affected by	Where saved	Default value
Function	Yes			

## Usage

```
display.loadmenu.delete(displayName)
```

<i>displayName</i>	The name to be deleted from the USER TESTS menu
--------------------	---

## Details

If you delete an entry from the USER TESTS menu, you can no longer run it by pressing the **LOAD** key.

## Example

```
display.loadmenu.delete("Test9")
for displayName, code in
  display.loadmenu.catalog() do
  print(displayName, code)
end
```

Deletes the entry named "Test9"  
Output:  
Test DUT1() beeper.beep(2, 500)  
Part1 testpart([[Part1]], 5.0)

## Also see

[display.loadmenu.add\(\)](#) (on page 7-70)  
[display.loadmenu.catalog\(\)](#) (on page 7-71)

## display.locallockout

This attribute describes whether or not the EXIT (LOCAL) key on the instrument front panel is enabled.

Type	TSP-Link accessible	Affected by	Where saved	Default value
Attribute (RW)	Yes	Power cycle	Not saved	0 (display.UNLOCK)

## Usage

```
lockout = display.locallockout
display.locallockout = lockout
```

<i>lockout</i>	0 or display.UNLOCK: Unlocks EXIT (LOCAL) key 1 or display.LOCK: Locks out EXIT (LOCAL) key
----------------	--

## Details

Set `display.locallockout` to `display.LOCK` to prevent the user from interrupting remote operation by pressing the EXIT (LOCAL) key.

Set this attribute to `display.UNLOCK` to allow the EXIT (LOCAL) key to interrupt script or remote operation.

## Example

```
display.locallockout = display.LOCK
```

Disables the front-panel EXIT (LOCAL) key.

## Also see

None

# display.menu()

This function presents a menu on the front panel display.

Type	TSP-Link accessible	Affected by	Where saved	Default value
Function	Yes			

## Usage



```
selection = display.menu(name, items)
```

<i>selection</i>	Name of the variable that holds the selected menu item
<i>name</i>	Menu name to display on the top line
<i>items</i>	Menu items to display on the bottom line



## Details

The menu consists of the menu name string on the top line, and a selectable list of items on the bottom line. The menu items must be a single string with each item separated by whitespace. The name for the top line is limited to 20 characters.

After sending this command, script execution pauses for the operator to select a menu item. An item is selected by rotating the navigation wheel  to place the blinking cursor on the item, and then pressing the navigation wheel  (or the ENTER key). When an item is selected, the text of that selection is returned.

Pressing the EXIT (LOCAL) key will not abort the script while the menu is displayed, but it will return `nil`. The script can be aborted by calling the `exit` function when `nil` is returned.

## Example

```
selection = display.menu("Menu", "Test1 Test2 Test3")
print(selection)
```

Displays a menu with three menu items. If the second menu item is selected, selection is given the value `Test2`.  
Output:  
`Test2`

## Also see

None

# display.prompt()

This function prompts the user to enter a parameter from the front panel of the instrument.

Type	TSP-Link accessible	Affected by	Where saved	Default value
Function	Yes			

## Usage

```
display.prompt(format, units, help)
display.prompt(format, units, help, default)
display.prompt(format, units, help, default, minimum)
display.prompt(format, units, help, default, minimum, maximum)
```

<i>format</i>	A string that defines how the input field is formatted; see <b>Details</b> for more information
<i>units</i>	Set the units text string for the top line (eight characters maximum); this indicates the units (for example, "V" or "A") for the value
<i>help</i>	Text string to display on the bottom line (32 characters maximum)
<i>default</i>	The value that is shown when the value is first displayed
<i>minimum</i>	The minimum input value that can be entered
<i>maximum</i>	The maximum input value that can be entered (must be more than minimum)

## Details

This function creates an editable input field at the present cursor position, and an input prompt message on the bottom line. Example of a displayed input field and prompt:

```
0.00V
```

```
Input 0 to +2V
```

The *format* parameter uses zeros (0), the decimal point, polarity sign, and exponents to define how the input field is formatted.



The *format* parameter can include the options shown in the following table.

Option	Description	Examples
E	Include the E to display the value exponentially. Include a plus sign (+) for positive/negative exponent entry. Do not include the plus sign (+) to prevent negative value entry. 0 defines the digit positions for the exponent.	0.00000E+0
+	Allows operators to enter positive or negative values. If the plus sign (+) is not included, the operator cannot enter a negative value.	+0.00
0	Defines the digit positions for the value. You can use up to six zeros (0).	+00.0000E+00
.	The decimal point where needed for the value.	+0.00

The *minimum* and *maximum* parameters can be used to limit the values that can be entered. When a plus sign (+) is not selected for *format*, the minimum limit must be greater than or equal to zero (0). When limits are used, the operator cannot enter values above or below these limits.

The input value is limited to  $\pm 1e37$ .

After sending this command, script execution pauses for the operator to enter a value and press **ENTER**.

For positive and negative entry (plus sign (+) used for the value field and the exponent field), polarity of a nonzero value or exponent can be toggled by positioning the cursor on the polarity sign and turning the navigation wheel . Polarity will also toggle when using the navigation wheel  to decrease or increase the value or exponent past zero. A zero value or exponent (for example, +00) is always positive and cannot be toggled to negative polarity.

After executing this command and pressing the **EXIT (LOCAL)** key, the value returns `nil`.

## Example

```
value = display.prompt("0.00", "V", "Input 0 to +2V", 0.5, 0, 2)
print(value)
```

The above command prompts the operator to enter a voltage value. The valid input range is 0 to +2.00, with a default of 0.50:

```
0.50V
```

```
Input 0 to +2V
```

If the operator enters 0.70, the output is:

```
7.0000000e-01
```

## Also see

[display.inputvalue\(\)](#) (on page 7-68)

## display.screen

This attribute contains the selected display screen.

Type	TSP-Link accessible	Affected by	Where saved	Default value
Attribute (RW)	Yes	Instrument reset	Create configuration script	display.MAIN

## Usage

---

```
displayID = display.screen
display.screen = displayID
```

<i>displayID</i>	One of the following values: <ul style="list-style-type: none"> <li>1 or <code>display.MAIN</code>: Displays the main screen</li> <li>2 or <code>display.USER</code>: Displays the user screen.</li> </ul>
------------------	--

## Details

---

Setting this attribute selects the display screen for the front panel. This performs the same action as pressing the DISPLAY key on the front panel. The text for the display screen is set by `display.settext()`.

Read this attribute to determine which of the available display screens was last selected.

### NOTE

This does not support the CLOSED CHANNELS option that is available from the **DISPLAY** key.

## Example

---

```
display.screen = display.USER
```

Selects the user display.

## Also see

---

[display.settext\(\)](#) (on page 7-79)

---

## display.sendkey()

This function sends a code that simulates the action of a front panel control.

Type	TSP-Link accessible	Affected by	Where saved	Default value
Function	Yes			

## Usage

---

```
display.sendkey(keyCode)
```

<i>keyCode</i>	A parameter that specifies the key press to simulate; see <b>Details</b> for more information
----------------	---

## Details

---

This command simulates the pressing of a front panel key or navigation wheel, or the turning the navigation wheel one click to the left or right.

The table below lists the *keyCode* value for each front panel action.

Key codes			
Value	Key list	Value	Key list
0	<code>display.KEY_NONE</code>	83	<code>display.KEY_RUN</code>
66	<code>display.KEY_DELETE</code>	84	<code>display.KEY_TRIG</code>
67	<code>display.KEY_EXIT</code>	86	<code>display.KEY_STEP</code>
69	<code>display.KEY_CLOSE</code>	87	<code>display.KEY_CHAN</code>
70	<code>display.KEY_SLOT</code>	90	<code>display.KEY_INSERT</code>
72	<code>display.KEY_DISPLAY</code>	91	<code>display.KEY_MENU</code>
74	<code>display.KEY_ENTER</code>	93	<code>display.KEY_OPEN</code>
76	<code>display.KEY_LOAD</code>	94	<code>display.KEY_PATT</code>
77	<code>display.KEY_SCAN</code>	97	<code>display.WHEEL_ENTER</code>
79	<code>display.KEY_OPENALL</code>	107	<code>display.WHEEL_LEFT</code>
80	<code>display.KEY_CONFIG</code>	114	<code>display.WHEEL_RIGHT</code>

## NOTE

When using this function, send built-in constants, such as `display.KEY_STEP`, rather than the numeric value, such as 86. This allows for better forward compatibility with firmware revisions.

### Example

```
display.sendkey(display.KEY_RUN)
```

Simulates pressing the RUN key.

### Also see

None

## display.setcursor()

This function sets the position of the cursor.

Type	TSP-Link accessible	Affected by	Where saved	Default value
Function	Yes			

### Usage

```
display.setcursor(row, column)
```

```
display.setcursor(row, column, style)
```

<i>row</i>	The row number for the cursor (1 or 2)
<i>column</i>	The active column position to set; row 1 has columns 1 to 20, row 2 has columns 1 to 32
<i>style</i>	Set the cursor to invisible (0, default) or blinking (1)

---

## Details

---

Sending this command selects the user screen and then moves the cursor to the given location.

The `display.clear()`, `display.setcursor()`, and `display.settext()` functions are overlapped commands. That is, the script does not wait for one of these commands to complete.

These functions do not immediately update the display. For performance considerations, they update the physical display as soon as processing time becomes available.

An out-of-range parameter for `row` sets the cursor to row 2. An out-of-range parameter for `column` sets the cursor to column 20 for row 1, or 32 for row 2.

An out-of-range parameter for `style` sets it to 0 (invisible).

A blinking cursor is only visible when it is positioned over displayed text. It cannot be seen when positioned over a space character.

---

## Example

---

```
display.clear()
display.setcursor(1, 8)
display.settext("Hello")
display.setcursor(2, 14)
display.settext("World")
```

This example displays a message on the instrument front panel, approximately center. Note that the top line of text is larger than the bottom line of text.

The front panel of the instrument displays "Hello" on the top line and "World" on the second line.

---

## Also see

---

[display.clear\(\)](#) (on page 7-63)

[display.getcursor\(\)](#) (on page 7-65)

[display.gettext\(\)](#) (on page 7-67)

[display.screen](#) (on page 7-75)

[display.settext\(\)](#) (on page 7-79)

## display.settext()

This function displays text on the user screen.

Type	TSP-Link accessible	Affected by	Where saved	Default value
Function	Yes			

### Usage

```
display.settext(text)
```

<i>text</i>	Text message to be displayed, with optional character codes
-------------	---

### Details

This function selects the user display screen and displays the given text.

After the instrument is turned on, the first time you use a display command to write to the display, the message "User Screen" is cleared. After the first write, you need to use `display.clear()` to clear the message.

The `display.clear()`, `display.setcursor()`, and `display.settext()` functions are overlapped commands. That is, the script does not wait for one of these commands to complete. These functions do not immediately update the display. For performance considerations, they update the physical display as soon as processing time becomes available.

The text starts at the present cursor position. After the text is displayed, the cursor is after the last character in the display message.

Top line text does not wrap to the bottom line of the display automatically. Any text that does not fit on the current line is truncated. If the text is truncated, the cursor remains at the end of the line.

The text remains on the display until replaced or cleared.

The character codes described in the following table can be also be included in the text string.

#### Display character codes

Character Code	Description
\$N	Newline, starts text on the next line; if the cursor is already on line 2, text will be ignored after the \$N is received
\$R	Sets text to normal intensity, nonblinking
\$B	Sets text to blink
\$D	Sets text to dim intensity
\$F	Sets the text to background blink
\$\$	Escape sequence to display a single dollar symbol (\$)

### Example

```
display.clear()
display.settext("Normal $Bblinking$N")
display.settext("$DDim $FBackgroundBlink$R $$$ $ 2 dollars")
```

This example sets the display to:

```
Normal Blinking
Dim BackgroundBlink $$ 2 dollars
with the named effect on each word.
```

**Also see**

[display.clear\(\)](#) (on page 7-63)  
[display.getcursor\(\)](#) (on page 7-65)  
[display.gettext\(\)](#) (on page 7-67)  
[display.screen](#) (on page 7-75)  
[display.setcursor\(\)](#) (on page 7-77)

**display.trigger.clear()**

This function clears the front-panel trigger event detector.

Type	TSP-Link accessible	Affected by	Where saved	Default value
Function	Yes			

**Usage**

```
display.trigger.clear()
```

**Details**

The trigger event detector remembers if an event has been detected since the last `display.trigger.wait()` call. This function clears the trigger event detector and discards the previous history of TRIG key presses.

This attribute also clears the `display.trigger.overrun` attribute.

**Also see**

[display.trigger.overrun](#)  
[display.trigger.wait\(\)](#)

**display.trigger.EVENT\_ID**

This constant is the event ID of the event generated when the front-panel TRIG key is pressed.

Type	TSP-Link accessible	Affected by	Where saved	Default value
Constant	Yes			

**Usage**

```
eventID = display.trigger.EVENT_ID
```

<code>eventID</code>	The trigger event number
----------------------	--------------------------

**Details**

Set the stimulus of any trigger event detector to the value of this constant to have it respond to front-panel trigger key events.

**Example**

```
scan.trigger.channel.stimulus = display.trigger.EVENT_ID
```

Have the channel action of the trigger model be paced by a user pressing the front-panel TRIG key.

**Also see**

[scan.trigger.channel.stimulus](#) (on page 7-153)

## display.waitkey()

This function captures the key code value for the next front-panel action.



Type	TSP-Link accessible	Affected by	Where saved	Default value
Function	Yes			

### Usage

```
keyCode = display.waitkey()
```

keyCode	See <b>Details</b> for more information
---------	---

### Details

After you send this function, script execution pauses until a front-panel action (for example, pressing a key or the navigation wheel , or turning the navigation wheel ). After the action, the value of the key (or action) is returned.

If the EXIT (LOCAL) key is pressed while this function is waiting for a front-panel action, the script is not aborted.

A typical use for this function is to prompt the user to press the EXIT (LOCAL) key to abort the script or press any other key to continue. For example, if the `keyCode` value 75 is returned (the EXIT (LOCAL) key was pressed), the `exit()` function can be called to abort the script.

The table below lists the `keyCode` value for each front panel action.

Key codes			
Value	Key (or action)	Value	Key (or action)
0	display.KEY_NONE	82	display.KEY_ENTER
65	display.KEY_RANGEUP	85	display.KEY_RECALL
68	display.KEY_MENU	86	display.KEY_MEASA
69	display.KEY_MODEA	86	display.KEY_DIGITSA
70	display.KEY_RELA	88	display.KEY_OUTPUTA
71	display.KEY_RUN	92	display.KEY_TRIG
72	display.KEY_DISPLAY	93	display.KEY_LIMITA
73	display.KEY_AUTO	94	display.KEY_SPEEDA
75	display.KEY_EXIT	95	display.KEY_LOAD
77	display.KEY_FILTERA	97	display.WHEEL_ENTER
78	display.KEY_STORE	103	display.KEY_RIGHT
79	display.KEY_SRCA	104	display.KEY_LEFT
80	display.KEY_CONFIG	107	display.WHEEL_LEFT
81	display.KEY_RANGEDOWN	114	display.WHEEL_RIGHT

## NOTE

When using this function, use built-in constants, such as `display.KEY_RIGHT`, rather than the numeric value, such as 103. This allows for better forward compatibility with firmware revisions.



**Example**

```
key = display.waitkey()
print(key)
```

Pause script execution until the operator presses a key or the navigation wheel, or rotates the navigation wheel.

If the output is:

```
8.60000e+01
```

It indicates that the MEAS(A) key was pressed.

**Also see**

Capturing key-press codes  
[display.getlastkey\(\)](#) (on page 7-66)  
[display.sendkey\(\)](#) (on page 7-76)  
[display.settext\(\)](#) (on page 7-79)

**errorqueue.clear()**

This function clears all entries out of the error queue.

Type	TSP-Link accessible	Affected by	Where saved	Default value
Function	Yes			

**Usage**

```
errorqueue.clear()
```

**Details**

See the Error queue topic for additional information about the error queue.

**Also see**

[errorqueue.count](#) (on page 7-83)  
[errorqueue.next\(\)](#) (on page 7-83)

## errorqueue.count

This attribute gets the number of entries in the error queue.

Type	TSP-Link accessible	Affected by	Where saved	Default value
Attribute (R)	Yes	Power cycle Clearing error queue Reading error messages	Not applicable	Not applicable

### Usage

```
count = errorqueue.count
```

<code>count</code>	The number of entries in the error queue
--------------------	--

### Example

```
count = errorqueue.count
print(count)
```

Returns the number of entries in the error queue.

The output below indicates that there are four entries in the error queue:  
4.0000000e+00

### Also see

[errorqueue.clear\(\)](#) (on page 7-82)

[errorqueue.next\(\)](#) (on page 7-83)

## errorqueue.next()

This function reads the oldest entry from the error queue and removes it from the queue.

Type	TSP-Link accessible	Affected by	Where saved	Default value
Function	Yes			

### Usage

```
errorCode, message, severity, errorNode = errorqueue.next()
```

<code>errorCode</code>	The error code number for the entry
<code>message</code>	The message that describes the error code
<code>severity</code>	The severity level (0, 10, 20, 30, or 40); see <b>Details</b> for more information
<code>errorNode</code>	The node number where the error originated

### Details

Entries are stored in a first-in, first-out (FIFO) queue. This functions reads the oldest entry and removes it from the queue.

Error codes and messages are listed in the Error summary list.

If there are no entries in the queue, code 0, "Queue is Empty" is returned.

Returned severity levels are described in the following table.

#### Severity level descriptions

Number	Level	Description
0	Informational	Indicates that there are no entries in the queue.
10	Informational	Indicates a status message or minor error.
20	Recoverable	Indicates possible invalid user input; operation continues but action should be taken to correct the error.
30	Serious	Indicates a serious error that may require technical assistance, such as corrupted data.
40	Fatal	Instrument is not operational.

In an expanded system, each TSP-Link enabled instrument is assigned a node number. The variable *errorNode* stores the node number where the error originated.

#### Example

```
errorcode, message = errorqueue.next()
print(errorcode, message)
```

Reads the oldest entry in the error queue. The output below indicates that the queue is empty.  
Output:  
0.0000000e+00 Queue Is Empty

#### Also see

[errorqueue.clear\(\)](#) (on page 7-82)

[errorqueue.count](#) (on page 7-83)

## eventlog.all()

This function returns all entries from the event log as a single string and removes them from the event log.

Type	TSP-Link accessible	Affected by	Where saved	Default value
Function	Yes			

#### Usage

```
logString = eventlog.all()
```

<i>logString</i>	A listing of all event log entries
------------------	------------------------------------

#### Details

This function returns all events in the event log. Logged items are shown from oldest to newest. The response is a string that has the messages delimited with a new line character.

This function also clears the event log.

If there are no entries in the event log, this function returns the value *nil*.

**Example**

```
print(eventlog.all())
```

Get and print all entries from the event log and remove the entries from the log.

Output:

```
17:26:35.690 10 Oct 2007, LAN0, 192.168.1.102, LXI, 0, 1192037132,
1192037155.733269000, 0, 0x0
17:26:39.009 10 Oct 2007, LAN5, 192.168.1.102, LXI, 0, 1192037133,
1192037159.052777000, 0, 0x0
```

**Also see**

[eventlog.clear\(\)](#) (on page 7-85)  
[eventlog.count](#) (on page 7-86)  
[eventlog.enable](#) (on page 7-86)  
[eventlog.next\(\)](#) (on page 7-87)  
[eventlog.overwritemethod](#) (on page 7-88)

**eventlog.clear()**

This function clears the event log.

Type	TSP-Link accessible	Affected by	Where saved	Default value
Function	Yes			

**Usage**

```
eventlog.clear()
```

**Details**

This command removes all unread messages from the event log.

**Also see**

[eventlog.all\(\)](#) (on page 7-84)  
[eventlog.count](#) (on page 7-86)  
[eventlog.enable](#) (on page 7-86)  
[eventlog.next\(\)](#) (on page 7-87)  
[eventlog.overwritemethod](#) (on page 7-88)

## eventlog.count

This attribute returns the number of unread events in the event log.

Type	TSP-Link accessible	Affected by	Where saved	Default value
Attribute (R)	Yes	Instrument reset Clearing event log Reading event log	Not applicable	Not applicable

### Usage

```
N = eventlog.count
```

N	The number of events in the event log
---	---------------------------------------

### Example

```
print(eventlog.count)
```

Displays the present number of events in the instrument event log.  
Output looks similar to:  
3.0000000e+00

### Also see

[eventlog.all\(\)](#) (on page 7-84)  
[eventlog.clear\(\)](#) (on page 7-85)  
[eventlog.enable](#) (on page 7-86)  
[eventlog.next\(\)](#) (on page 7-87)  
[eventlog.overwritemethod](#) (on page 7-88)

## eventlog.enable

This attribute enables or disables the event log.

Type	TSP-Link accessible	Affected by	Where saved	Default value
Attribute (RW)	Yes	Instrument reset	Create configuration script	eventlog.ENABLE

### Usage

```
status = eventlog.enable
eventlog.enable = status
```

status	The enable status of the event log: 1 or eventlog.ENABLE: Event log enable 0 or eventlog.DISABLE: Event log disable
--------	---

### Details

When the event log is disabled (`eventlog.DISABLE` or 0), no new events are added to the event log. You can, however, read and remove existing events.

When the event log is enabled, new events are logged.

**Example**

```
print(eventlog.enable)
eventlog.enable = eventlog.DISABLE
print(eventlog.enable)
```

Displays the present status of the Model 707B or 708B event log.

Output:

```
1.0000000e+00
0.0000000e+00
```

**Also see**

[eventlog.all\(\)](#) (on page 7-84)  
[eventlog.clear\(\)](#) (on page 7-85)  
[eventlog.count](#) (on page 7-86)  
[eventlog.next\(\)](#) (on page 7-87)  
[eventlog.overwritemethod](#) (on page 7-88)

**eventlog.next()**

This function returns the oldest unread event message from the event log and removes it from the event log.

Type	TSP-Link accessible	Affected by	Where saved	Default value
Function	Yes			

**Usage**

```
logString = eventlog.next()
```

<i>logString</i>	The next log entry
------------------	--------------------

**Details**

Returns the next entry from the event log and removes it from the log.  
 If there are no entries in the event log, returns the value `nil`.

**Example 1**

```
print(eventlog.next())
```

Get the oldest message in the event log and remove that entry from the log.

Output:

```
17:28:22.085 10 Oct 2009, LAN2, 192.168.1.102, LXI, 0, 1192037134, <no time>, 0, 0x0
```

**Example 2**

```
print(eventlog.next())
```

If you send this command when there is nothing in the event log, you will get the following output:

```
nil
```

**Also see**

[eventlog.all\(\)](#) (on page 7-84)  
[eventlog.clear\(\)](#) (on page 7-85)  
[eventlog.count](#) (on page 7-86)  
[eventlog.enable](#) (on page 7-86)  
[eventlog.overwritemethod](#) (on page 7-88)

## eventlog.overwritemethod

This attribute controls how the event log processes events if the event log is full.

Type	TSP-Link accessible	Affected by	Where saved	Default value
Attribute (RW)	Yes	Instrument reset Recall setup	Create configuration script	1 (eventlog.DISCARD_OLDEST)

### Usage

```
method = eventlog.overwritemethod
eventlog.overwritemethod = method
```

*method*

Set to one of the following values:

- 0 or `eventlog.DISCARD_NEWEST`: New entries are not logged
- 1 or `eventlog.DISCARD_OLDEST`: Old entries are deleted as new events are logged

### Details

When this attribute is set to `eventlog.DISCARD_NEWEST`, new entries are not logged.

When this attribute is set to `eventlog.DISCARD_OLDEST`, the oldest entry is discarded when a new entry is added.

### Example

```
eventlog.overwritemethod = 0
```

When the log is full, the event log will ignore new entries.

### Also see

[eventlog.all\(\)](#) (on page 7-84)  
[eventlog.clear\(\)](#) (on page 7-85)  
[eventlog.count](#) (on page 7-86)  
[eventlog.enable](#) (on page 7-86)  
[eventlog.next\(\)](#) (on page 7-87)

## exit()

This function stops a script that is presently running.

Type	TSP-Link accessible	Affected by	Where saved	Default value
Function	No			

### Usage

```
exit()
```

### Details

Terminates script execution when called from a script that is being executed.

This command does not wait for overlapped commands to complete before terminating script execution. If overlapped commands are required to finish, use the `waitcomplete()` function before calling `exit()`.

### Also see

[waitcomplete\(\)](#) (on page 7-242)

## format.asciiprecision

This attribute sets the precision (number of digits) for all numbers returned in the ASCII format.

Type	TSP-Link accessible	Affected by	Where saved	Default value
Attribute (RW)	No	Instrument reset Recall setup	Create configuration script	10

### Usage

```
precision = format.asciiprecision
format.asciiprecision = precision
```

<i>precision</i>	A number representing the number of digits to be printed for numbers printed with the <code>print()</code> , <code>printbuffer()</code> , and <code>printnumber()</code> functions; must be a number between 1 and 16
------------------	---

### Details

This attribute specifies the precision (number of digits) for numeric data printed with the `print()`, `printbuffer()`, and `printnumber()` functions. The `format.asciiprecision` attribute is only used with the ASCII format. The precision value must be a number from 0 to 16.

Note that the precision is the number of significant digits printed. There is always one digit to the left of the decimal point; be sure to include this digit when setting the precision.

### Example

<pre>format.asciiprecision = 10 x = 2.54 printnumber(x) format.asciiprecision = 3 printnumber(x)</pre>	<pre>Output: 2.540000000000e+00 2.54e+00</pre>
--	--

### Also see

[format.byteorder](#) (on page 7-89)  
[format.data](#) (on page 7-90)  
[print\(\)](#) (on page 7-131)  
[printbuffer\(\)](#) (on page 7-132)  
[printnumber\(\)](#) (on page 7-134)

## format.byteorder

This attribute sets the binary byte order for the data that is printed using the `printnumber()` and `printbuffer()` functions.

Type	TSP-Link accessible	Affected by	Where saved	Default value
Attribute (RW)	Yes	Instrument reset Recall setup	Create configuration script Save setup	format.LITTLEENDIAN



## Usage

```
order = format.byteorder
format.byteorder = order
```

<code>order</code>	Byte order value as follows: <ul style="list-style-type: none"> <li>• Most significant byte first: 0, <code>format.NORMAL</code>, <code>format.NETWORK</code>, or <code>format.BIGENDIAN</code></li> <li>• Least significant byte first: 1, <code>format.SWAPPED</code> or <code>format.LITTLEENDIAN</code></li> </ul>
--------------------	--

## Details

This attribute selects the byte order in which data is written when you are printing data values with the `printnumber()` and `printbuffer()` functions. The byte order attribute is only used with the `format.SREAL`, `format.REAL`, `format.REAL32`, and `format.REAL64` data formats.

`format.NORMAL`, `format.BIGENDIAN`, and `format.NETWORK` select the same byte order. `format.SWAPPED` and `format.LITTLEENDIAN` select the same byte order. Selecting which to use is a matter of preference.

Select the `format.SWAPPED` or `format.LITTLEENDIAN` byte order when sending data to a computer with a Microsoft Windows operating system.

## Example

<pre>x = 1.23 format.data = format.REAL32 format.byteorder = format.LITTLEENDIAN printnumber(x) format.byteorder = format.BIGENDIAN printnumber(x)</pre>	Output depends on the terminal program you use, but will look something like: <pre>#0ap?? #0??pα</pre>
--	---

## Also see

[format.asciiprecision](#) (on page 7-89)  
[format.data](#) (on page 7-90)  
[printbuffer\(\)](#) (on page 7-132)  
[printnumber\(\)](#) (on page 7-134)

## format.data

This attribute sets the data format for data that is printed using the `printnumber()` and `printbuffer()` functions.

Type	TSP-Link accessible	Affected by	Where saved	Default value
Attribute (RW)	No	Instrument reset Recall setup	Create configuration script	1 (format.ASCII)

## Usage

```
value = format.data
format.data = value
```

<code>value</code>	The format to use for data, set to one of the following values: <ul style="list-style-type: none"> <li>• ASCII format: 1 or <code>format.ASCII</code></li> <li>• Single-precision IEEE Std 754 binary format: 2, <code>format.SREAL</code>, or <code>format.REAL32</code></li> <li>• Double-precision IEEE Std 754 binary format: 3, <code>format.REAL</code>, <code>format.REAL64</code>, or <code>format.DREAL</code></li> </ul>
--------------------	--

## Details

The precision of numeric values can be controlled with the `format.asciiprecision` attribute. The byte order of `format.SREAL`, `format.REAL`, `format.REAL32`, and `format.REAL64` can be selected with the `format.byteorder` attribute.

REAL32 and SREAL select the same single precision format. REAL and REAL64 select the same double precision format. They are alternative identifiers. Selecting which to use is a matter of preference.

The IEEE Std 754 binary formats use four bytes for single-precision values and eight bytes for double-precision values.

When data is written with any of the binary formats, the response message starts with #0 and ends with a new line. When data is written with the ASCII format, elements are separated with a comma and space.

## NOTE

Binary formats are not intended to be interpreted by humans.

## Example

```
format.asciiprecision = 10
x = 3.14159265
format.data = format.ASCII
printnumber(x)
format.data = format.REAL64
printnumber(x)
```

Output a number represented by `x` in ASCII using a precision of 10, then output the same number in binary using double precision format.

Output:  
3.141592650e+00  
#0ñÔÈSû! @

## Also see

[format.asciiprecision](#) (on page 7-89)

[format.byteorder](#) (on page 7-89)

[printbuffer\(\)](#) (on page 7-132)

[printnumber\(\)](#) (on page 7-134)

## gettimezone()

This function retrieves the local time zone.

Type	TSP-Link accessible	Affected by	Where saved	Default value
Function	Yes			

### Usage

```
timeZone = gettimezone()
```

<code>timeZone</code>	The local timezone of the instrument
-----------------------	--------------------------------------

### Details

See `settimezone()` for additional details about the time zone format and a description of the fields.

`timeZone` can be in either of the following formats:

- If one parameter was used with `settimezone()`, the format used is:  
GMThh:mm:ss
- If four parameters were used with `settimezone()`, the format used is:  
GMThh:mm:ssGMThh:mm:ss,Mmm.w.dw/hh:mm:ss,Mmm.w.dw/hh:mm:ss

### Example

<code>timezone = gettimezone()</code>	Reads the value of the local timezone.
---------------------------------------	--

### Also see

[settimezone\(\)](#) (on page 7-166)

## gpib.address

This attribute contains the GPIB address.

Type	TSP-Link accessible	Affected by	Where saved	Default value
Attribute (RW)	No	Not applicable	Nonvolatile memory	16

### Usage

```
address = gpib.address
gpib.address = address
```

<code>address</code>	The GPIB address of the instrument (1 to 30)
----------------------	--

## Details

---

The address can be set to any address value from 1 to 30. However, the address must be unique in the system. It cannot conflict with an address that is assigned to another instrument or to the GPIB controller.

A new GPIB address takes effect when the command to change it is processed. If there are response messages in the output queue when this command is processed, they must be read at the new address.

If command messages are being queued (sent before this command has executed), the new settings may take effect in the middle of a subsequent command message, so care should be exercised when setting this attribute from the GPIB interface.

You should allow ample time for the command to be processed before attempting to communicate with the instrument again. After sending this command, make sure to use the new address to communicate with the instrument.

The `reset()` function does not affect the GPIB address.

## Example

---

```
gpiB.address = 26
address = gpiB.address
print(address)
```

Sets the GPIB address and reads the address.

Output:  
2.60000000e+01

## Also see

---

[GPIB setup](#) (on page 2-30)

---

## lan.applysettings()

This function re-initializes the LAN interface with new settings.

Type	TSP-Link accessible	Affected by	Where saved	Default value
Function	Yes			

## Usage

---

```
lan.applysettings()
```

## Details

---

Disconnects all existing LAN connections to the instrument and re-initializes the LAN with the present configuration settings.

This function initiates a background operation. LAN configuration could be a lengthy operation. Although the function returns immediately, the LAN initialization continues to run in the background.

Even though the LAN configuration settings may not have changed since the LAN was last connected, new settings may take effect due to the dynamic nature of dynamic host configuration protocol (DHCP) or dynamic link local addressing (DLLA) configuration.

Re-initialization takes effect even if the configuration has not changed since the last time the instrument connected to the LAN.

**Example**

```
lan.applysettings() Re-initialize the LAN interface with new settings.
```

**Also see**

None

**lan.config.dns.address[N]**

Configures DNS server IP addresses.

Type	TSP-Link accessible	Affected by	Where saved	Default value
Attribute (RW)	Yes	LAN restore defaults	Nonvolatile memory	"0.0.0.0"

**Usage**

```
dnsAddress = lan.config.dns.address[N]
lan.config.dns.address[N] = dnsAddress
```

<i>dnsAddress</i>	DNS server IP address
<i>N</i>	Entry index (1 or 2)

**Details**

This attribute is an array of DNS (domain name system) server addresses. These addresses take priority for DNS lookups and are consulted before any server addresses that are obtained using DHCP. This allows local DNS servers to be specified that take priority over DHCP-configured global DNS servers.

You can specify up to two addresses. The address specified by 1 is consulted first for DNS lookups. *dnsAddress* must be a string specifying the DNS server's IP address in dotted decimal notation.

Unused entries are returned as "0.0.0.0" when read. To disable an entry, set its value to "0.0.0.0" or the empty string "".

Although only two addresses may be manually specified here, the instrument will use up to three DNS server addresses. If two are specified here, only one that is given by a DHCP server is used. If no entries are specified here, up to three addresses that are given by a DHCP server are used.

**Example**

```
dnsaddress = "164.109.48.173"
lan.config.dns.address[1] = dnsaddress
```

Configure DNS address 1 to "164.109.48.173"

**Also see**

[lan.config.dns.domain](#) (on page 7-95)  
[lan.config.dns.dynamic](#) (on page 7-95)  
[lan.config.dns.hostname](#) (on page 7-96)  
[lan.config.dns.verify](#) (on page 7-97)  
[lan.restoredefaults\(\)](#) (on page 7-101)

## lan.config.dns.domain

Configures the dynamic DNS domain.

Type	TSP-Link accessible	Affected by	Where saved	Default value
Attribute (RW)	Yes	LAN restore defaults	Nonvolatile memory	""

### Usage

```
domain = lan.config.dns.domain
lan.config.dns.domain = domain
```

<code>domain</code>	Dynamic DNS registration domain; use a string of 255 characters or less
---------------------	---

### Details

This attribute holds the domain to request during dynamic DNS registration. Dynamic DNS registration works with DHCP to register the domain specified in this attribute with the DNS server. The length of the fully qualified host name (combined length of the domain and host name with separator characters) must be less than or equal to 255 characters. Although up to 255 characters are allowed, you must make sure the combined length is also no more than 255 characters.

### Example

<pre>print(lan.config.dns.domain)</pre>	Outputs the present dynamic DNS domain. For example, if the domain is "Matrix", the response would be: Matrix
---	--

### Also see

[lan.config.dns.dynamic](#) (on page 7-95)  
[lan.config.dns.hostname](#) (on page 7-96)  
[lan.config.dns.verify](#) (on page 7-97)  
[lan.restoredefaults\(\)](#) (on page 7-101)

## lan.config.dns.dynamic

Enables or disables the dynamic DNS registration.

Type	TSP-Link accessible	Affected by	Where saved	Default value
Attribute (RW)	Yes	LAN restore defaults	Nonvolatile memory	1 (lan.ENABLE)

### Usage

```
state = lan.config.dns.dynamic
lan.config.dns.dynamic = state
```

<code>state</code>	The dynamic DNS registration state. It may be one of the following values: 1 or lan.ENABLE: Enabled 0 or lan.DISABLE: Disabled
--------------------	--

## Details

Dynamic DNS registration works with DHCP to register the host name with the DNS server. The host name is specified in the `lan.config.dns.hostname` attribute.

## Example

```
print(lan.config.dns.dynamic)
```

Outputs the dynamic registration state.

If dynamic DNS registration is enabled, the response is:

```
1.0000000e+00
```

## Also see

[lan.config.dns.hostname](#) (on page 7-96)

[lan.restoredefaults\(\)](#) (on page 7-101)

# lan.config.dns.hostname

This attribute defines the dynamic DNS host name.

Type	TSP-Link accessible	Affected by	Where saved	Default value
Attribute (RW)	Yes	Not applicable	Nonvolatile memory	Instrument specific (see <b>Details</b> )

## Usage

```
hostName = lan.config.dns.hostname
```

```
lan.config.dns.hostname = hostName
```

*hostName*

The host name to use for dynamic DNS registration; the host name must:

- be a string of 15 characters or less
- start with a letter
- end with a letter or digit
- contain only letters, digits, and hyphens

## Details

This attribute holds the host name to request during dynamic DNS registration. Dynamic DNS registration works with DHCP to register the host name specified in this attribute with the DNS server. The factory default value for *hostName* is "K-<model number>-<serial number>", where <model number> and <serial number> are replaced with the actual model number and serial number of the instrument (for example, "K-707B-1234567"). Note that hyphens separate the characters of *hostName*.

The length of the fully qualified host name (combined length of the domain and host name with separator characters) must be less than or equal to 255 characters. Although up to 15 characters can be entered here, care must be taken to be sure the combined length is no more than 255 characters. Setting this attribute to an empty string (in other words, setting this attribute to a string of length zero, or one consisting entirely of whitespace characters) will revert the host name to the factory default value.

## Example

```
print(lan.config.dns.hostname)
```

Outputs the present dynamic DNS host name.

**Also see**

[lan.config.dns.dynamic](#) (on page 7-95)  
[lan.restoredefaults\(\)](#) (on page 7-101)

## lan.config.dns.verify

This attribute defines the DNS host name verification state.

Type	TSP-Link accessible	Affected by	Where saved	Default value
Attribute (RW)	Yes	LAN restore defaults	Nonvolatile memory	1 (lan.ENABLE)

**Usage**

```
state = lan.config.dns.verify
lan.config.dns.verify = state
```

<i>state</i>	DNS hostname verification state: 1 or lan.ENABLE: DNS host name verification enabled 0 or lan.DISABLE: DNS host name verification disabled
--------------	--

**Details**

When this is enabled, the instrument performs DNS lookups to verify that the DNS host name matches the value specified by `lan.config.dns.hostname`.

**Example**

<pre>print(lan.config.dns.verify)</pre>	Outputs the present DNS host name verification state.  If it is enabled, the output is: 1.0000000e+00
---	--

**Also see**

[lan.config.dns.hostname](#) (on page 7-96)  
[lan.restoredefaults\(\)](#) (on page 7-101)

## lan.config.gateway

This attribute contains the LAN default gateway address.

Type	TSP-Link accessible	Affected by	Where saved	Default value
Attribute (RW)	Yes	LAN restore defaults	Nonvolatile memory	"0.0.0.0"

**Usage**

```
gatewayAddress = lan.config.gateway
lan.config.gateway = gatewayAddress
```

<i>gatewayAddress</i>	LAN default gateway address; must be a string specifying the default gateway's IP address in dotted decimal notation
-----------------------	--



## Details

This attribute specifies the default gateway IP address to use when manual or DLLA configuration methods are used to configure the LAN. If DHCP is enabled, this setting is ignored.

This attribute does not indicate the actual setting that is presently in effect. Use the `lan.status.gateway` attribute to determine the present operating state of the LAN.

The IP address must be formatted in four groups of numbers, each separated by a decimal.

## Example

```
print(lan.config.gateway)
```

Outputs the default gateway address. For example, you might see the output:  
192.168.0.1

## Also see

[lan.restoredefaults\(\)](#) (on page 7-101)

[lan.status.gateway](#) (on page 7-103)

---

## lan.config.ipaddress

This command specifies the LAN IP address.

Type	TSP-Link accessible	Affected by	Where saved	Default value
Attribute (RW)	Yes	LAN restore defaults	Nonvolatile memory	"192.168.0.2"

## Usage

```
ipAddress = lan.config.ipaddress
lan.config.ipaddress = ipAddress
```

<code>ipAddress</code>	LAN IP address; must be a string specifying the IP address in dotted decimal notation
------------------------	---

## Details

This command specifies the LAN IP address to use when the LAN is configured using the manual configuration method. This setting is ignored when DLLA or DHCP is used.

This attribute does not indicate the actual setting that is presently in effect. Use the `lan.status.ipaddress` attribute to determine the present operating state of the LAN.

## Example

```
ipaddress = lan.config.ipaddress
```

Retrieves the presently set LAN IP address.

## Also see

[lan.restoredefaults\(\)](#) (on page 7-101)

[lan.status.ipaddress](#) (on page 7-104)

---

## lan.config.method

This attribute contains the LAN settings configuration method.

Type	TSP-Link accessible	Affected by	Where saved	Default value
Attribute (RW)	Yes	LAN restore defaults	Nonvolatile memory	0 (lan.AUTO)

## Usage

---

```
method = lan.config.method
lan.config.method = method
```

<i>method</i>	The method for configuring LAN settings; it can be one of the following values: 0 or <code>lan.AUTO</code> : Selects automatic sequencing of configuration methods 1 or <code>lan.MANUAL</code> : Use only manually specified configuration settings
---------------	--

## Details

---

This attribute controls how the LAN IP address, subnet mask, default gateway address, and DNS server addresses are determined.

When `method` is `lan.AUTO`, the instrument first attempts to configure the LAN settings using dynamic host configuration protocol (DHCP). If DHCP fails, it tries dynamic link local addressing (DLLA). If DLLA fails, it uses the manually specified settings.

When `method` is `lan.MANUAL`, only the manually specified settings are used. Neither DHCP nor DLLA are attempted.

## Example

---

```
print(lan.config.method)
```

Outputs the current method.  
For example:  
1.0000000e+00

## Also see

---

[lan.restoredefaults\(\)](#) (on page 7-101)

---

## lan.config.subnetmask

This attribute contains the LAN subnet mask.

Type	TSP-Link accessible	Affected by	Where saved	Default value
Attribute (RW)	Yes	LAN restore defaults	Nonvolatile memory	"255.255.255.0"

## Usage

---

```
mask = lan.config.subnetmask
lan.config.subnetmask = mask
```

<i>mask</i>	String that specifies the LAN subnet mask value in dotted decimal notation
-------------	--

## Details

---

This attribute specifies the LAN subnet mask that will be used when the manual configuration method is used to configure the LAN. This setting is ignored when DLLA or DHCP is used.

This attribute does not indicate the actual setting presently in effect. Use the `lan.status.subnetmask` attribute to determine the present operating state of the LAN.

## Example

---

```
print(lan.config.subnetmask)
```

Outputs the LAN subnet mask, such as:  
255.255.255.0

**Also see**

[lan.restoredefaults\(\)](#) (on page 7-101)  
[lan.status.subnetmask](#) (on page 7-107)

## lan.lxidomain

This attribute contains the LXI domain.

Type	TSP-Link accessible	Affected by	Where saved	Default value
Attribute (RW)	Yes	LAN restore defaults	Nonvolatile memory	0

**Usage**

```
domain = lan.lxidomain
lan.lxidomain = domain
```

<code>domain</code>	The LXI domain number (0 to 255)
---------------------	----------------------------------

**Details**

This attribute sets the LXI domain number.

All outgoing LXI packets are generated with this domain number. All inbound LXI packets are ignored unless they have this domain number.

**Example**

<code>print(lan.lxidomain)</code>	Displays the LXI domain.
-----------------------------------	--------------------------

**Also see**

None

## lan.nagle

This attribute controls the state of the LAN Nagle algorithm.

Type	TSP-Link accessible	Affected by	Where saved	Default value
Attribute (RW)	Yes	Power cycle	Not saved	0 (lan.DISABLE)

**Usage**

```
state = lan.nagle
lan.nagle = state
```

<code>state</code>	1 or <code>lan.ENABLE</code> : Enable the LAN Nagle algorithm for TCP connections 0 or <code>lan.DISABLE</code> : Disable the Nagle algorithm for TCP connections
--------------------	--

**Details**

This attribute enables or disables the use of the LAN Nagle algorithm on transmission control protocol (TCP) connections.

**Also see**

[lan.restoredefaults\(\)](#) (on page 7-101)

## lan.reset()

This function resets the LAN interface.

Type	TSP-Link accessible	Affected by	Where saved	Default value
Function	Yes			

### Usage

```
lan.reset()
```

### Details

This function resets the LAN interface. It performs the commands `lan.restoredefaults()` and `lan.applysettings()`.

### Also see

[lan.applysettings\(\)](#) (on page 7-93)  
[lan.restoredefaults\(\)](#) (on page 7-101)

## lan.restoredefaults()

This function resets LAN settings to default values.

Type	TSP-Link accessible	Affected by	Where saved	Default value
Function	Yes			

### Usage

```
lan.restoredefaults()
```

### Details

The settings that are restored are shown in the following table.

Settings that are restored to default	
Attribute	Default setting
lan.config.dns.address[N]	"0.0.0.0"
lan.config.dns.domain	" "
lan.config.dns.dynamic	lan.ENABLE
lan.config.dns.hostname	"K-<model number>-<serial number>"
lan.config.dns.verify	lan.ENABLE
lan.config.gateway	"0.0.0.0"
lan.config.ipaddress	"0.0.0.0"
lan.config.method	lan.AUTO
lan.config.subnetmask	"255.255.255.0"
lan.lxidomain	0
localnode.password	"admin"

This command is run when `lan.reset()` is sent.

### Example

lan.restoredefaults()	Restores the LAN defaults.
-----------------------	----------------------------

**Also see**

[lan.reset\(\)](#) (on page 7-101)  
[localnode.password](#) (on page 7-121)

**lan.status.dns.address[N]**

This attribute contains the DNS server IP addresses.

Type	TSP-Link accessible	Affected by	Where saved	Default value
Attribute (R)	Yes	Not applicable	Not applicable	Not applicable

**Usage**

*dnsAddress* = lan.status.dns.address[N]

<i>dnsAddress</i>	DNS server IP address
<i>N</i>	Entry index (1, 2, or 3)

**Details**

This attribute is an array of DNS server addresses. The instrument can use up to three addresses. Unused or disabled entries are returned as "0.0.0.0" when read. The *dnsAddress* returned is a string specifying the IP address of the DNS server in dotted decimal notation.

You can only specify two addresses manually. However, the instrument uses up to three DNS server addresses. If two are specified, only the one given by a DHCP server is used. If no entries are specified, up to three address given by a DHCP server are used.

The value of `lan.status.dns.address[1]` is referenced first for all DNS lookups. The values of `lan.status.dns.address[2]` and `lan.status.dns.address[3]` are referenced second and third, respectively.

**Example**

```
print(lan.status.dns.address[1])
```

Outputs DNS server address 1, for example:  
164.109.48.173

**Also see**

[lan.status.dns.name](#) (on page 7-102)

**lan.status.dns.name**

This attribute contains the present DNS fully qualified host name.

Type	TSP-Link accessible	Affected by	Where saved	Default value
Attribute (R)	Yes	Not applicable	Not applicable	Not applicable

**Usage**

*hostName* = lan.status.dns.name

<i>hostName</i>	Fully qualified DNS host name that can be used to connect to the instrument
-----------------	---

## Details

A fully qualified domain name (FQDN), sometimes referred to as an absolute domain name, is a domain name that specifies its exact location in the tree hierarchy of the Domain Name System (DNS).

A FQDN is the complete domain name for a specific computer or host on the LAN. The FQDN consists of two parts: the host name and the domain name.

If the DNS host name for an instrument is not found, this attribute stores the IP address in dotted decimal notation.

## Example

```
print(lan.status.dns.name)
```

Outputs the dynamic DNS host name.

## Also see

[lan.config.dns.address\[N\]](#) (on page 7-94)

[lan.config.dns.hostname](#) (on page 7-96)

## lan.status.duplex

This attribute contains the duplex mode presently in use by the LAN interface.

Type	TSP-Link accessible	Affected by	Where saved	Default value
Attribute (R)	Yes	Not applicable	Not applicable	Not applicable

## Usage

```
duplex = lan.status.duplex
```

<i>duplex</i>	LAN duplex setting can be one of the following values: 0 or lan.HALF: half-duplex operation 1 or lan.FULL: full-duplex operation
---------------	--

## Example

```
print(lan.status.duplex)
```

Outputs the present LAN duplex mode, such as:  
1.0000000e+00

## Also see

None

## lan.status.gateway

This attribute contains the gateway address presently in use by the LAN interface.

Type	TSP-Link accessible	Affected by	Where saved	Default value
Attribute (R)	Yes	Not applicable	Not applicable	Not applicable

## Usage

```
gatewayAddress = lan.status.gateway
```

<i>gatewayAddress</i>	LAN gateway address presently being used
-----------------------	--

## Details

The value of *gatewayAddress* is a string that indicates the IP address of the gateway in dotted decimal notation.

## Example

```
print(lan.status.gateway)
```

Outputs the gateway address, such as:  
192.168.0.1

## Also see

[lan.config.gateway](#) (on page 7-97)

---

## lan.status.ipaddress

This attribute contains the LAN IP address presently in use by the LAN interface.

Type	TSP-Link accessible	Affected by	Where saved	Default value
Attribute (R)	Yes	Not applicable	Not applicable	Not applicable

## Usage

```
ipAddress = lan.status.ipaddress
```

```
ipAddress
```

LAN IP address specified in dotted decimal notation

## Details

The IP address is a character string that represents the IP address assigned to the instrument.

## Example

```
print(lan.status.ipaddress)
```

Outputs the LAN IP address currently in use, such as:  
192.168.0.2

## Also see

[lan.config.ipaddress](#) (on page 7-98)

---

## lan.status.macaddress

This attribute contains the LAN MAC address.

Type	TSP-Link accessible	Affected by	Where saved	Default value
Attribute (R)	Yes	Not applicable	Not applicable	Not applicable

## Usage

```
macAddress = lan.status.macaddress
```

```
macAddress
```

The instrument MAC address

## Details

The MAC address is a character string representing the MAC address of the instrument in hexadecimal notation. The string includes colons that separate the address octets (see Example).

**Example**

```
print(lan.status.macaddress)
```

Outputs the MAC address of the instrument, for example:  
00:60:1A:00:00:57

**Also see**

None

**lan.status.port.dst**

This attribute contains the LAN dead socket termination port number.

Type	TSP-Link accessible	Affected by	Where saved	Default value
Attribute (R)	Yes	Not applicable	Not applicable	Not applicable

**Usage**

```
port = lan.status.port.dst
```

<code>port</code>	Dead socket termination socket port number
-------------------	--

**Details**

This attribute holds the TCP port number used to reset all other LAN socket connections. To reset all LAN connections, open a connection to the DST port number.

**Example**

```
print(lan.status.port.dst)
```

Outputs the LAN dead socket termination port number, such as:  
5.0300000e+03

**Also see**

None

**lan.status.port.rawsocket**

This attribute contains the LAN raw socket connection port number.

Type	TSP-Link accessible	Affected by	Where saved	Default value
Attribute (R)	Yes	Not applicable	Not applicable	Not applicable

**Usage**

```
port = lan.status.port.rawsocket
```

<code>port</code>	Raw socket port number
-------------------	------------------------

**Details**

Stores the TCP port number used to connect the instrument and to control the instrument over a raw socket communication interface.



**Example**

```
print(lan.status.port.rawsocket)
```

Outputs the LAN raw socket port number, such as:  
5.02500e+03

**Also see**

None

**lan.status.port.telnet**

This attribute contains the LAN Telnet connection port number.

Type	TSP-Link accessible	Affected by	Where saved	Default value
Attribute (R)	Yes	Not applicable	Not applicable	Not applicable

**Usage**

```
port = lan.status.port.telnet
```

<i>port</i>	Telnet port number
-------------	--------------------

**Details**

This attribute holds the TCP port number used to connect to the instrument to control it over a Telnet interface.

**Example**

```
print(lan.status.port.telnet)
```

Get the LAN Telnet connection port number.  
Output:  
2.3000000e+01

**Also see**

None

**lan.status.port.vxi11**

This attribute contains the LAN VXI-11 connection port number.

Type	TSP-Link accessible	Affected by	Where saved	Default value
Attribute (R)	Yes	Not applicable	Not applicable	Not applicable

**Usage**

```
port = lan.status.port.vxi11
```

<i>port</i>	LAN VXI-11 port number
-------------	------------------------

**Details**

This attribute stores the TCP port number used to connect to the instrument over a VXI-11 interface.

**Example**

```
print(lan.status.port.vxi11)
```

Outputs the VXI-11 number, such as:  
1.02400e+03

**Also see**

None

---

**lan.status.speed**

This attribute contains the LAN speed.

Type	TSP-Link accessible	Affected by	Where saved	Default value
Attribute (R)	Yes	Not applicable	Not applicable	Not applicable

**Usage**

```
speed = lan.status.speed
```

<code>speed</code>	LAN speed in Mbps, either 10 or 100
--------------------	-------------------------------------

**Details**

This attribute indicates the transmission speed currently in use by the LAN interface.

**Example**

```
print(lan.status.speed)
```

Outputs the instrument's transmission speed presently in use, such as: 1.0000000e+02
---

**Also see**

None

---

**lan.status.subnetmask**

This attribute contains the LAN subnet mask that is presently in use by the LAN interface.

Type	TSP-Link accessible	Affected by	Where saved	Default value
Attribute (R)	Yes	Not applicable	Not applicable	Not applicable

**Usage**

```
mask = lan.status.subnetmask
```

<code>mask</code>	A string specifying the subnet mask in dotted decimal notation
-------------------	--

**Details**

Use this attribute to determine the present operating state of the LAN. This attribute will return the present LAN subnet mask value if the LAN is manually configured, or when DLLA or DHCP is used.

**Example**

```
print(lan.status.subnetmask)
```

Outputs the subnet mask of the instrument that is presently in use, such as: 255.255.255.0
---

**Also see**

[lan.config.subnetmask](#) (on page 7-99)

## lan.trigger[N].assert()

This function simulates the occurrence of the trigger and generates the corresponding event ID.

Type	TSP-Link accessible	Affected by	Where saved	Default value
Function	Yes			

### Usage

```
lan.trigger[N].assert()
```

<i>N</i>	The LAN event number (1 to 8)
----------	-------------------------------

### Details

Generates and sends a LAN trigger packet for the LAN event number specified.

Sets the pseudo line state to the appropriate state.

The following indexes provide the listed LXI events:

- 1:LAN0
- 2:LAN1
- 3:LAN2
- ...
- 8:LAN7

### Example

<code>lan.trigger[5].assert()</code>	Creates a trigger with LAN packet 5.
--------------------------------------	--------------------------------------

### Also see

[lan.lxidomain](#) (on page 7-100)  
[lan.trigger\[N\].clear\(\)](#) (on page 7-108)  
[lan.trigger\[N\].mode](#) (on page 7-112)  
[lan.trigger\[N\].overrun](#) (on page 7-113)  
[lan.trigger\[N\].stimulus](#) (on page 7-115)  
[lan.trigger\[N\].wait\(\)](#) (on page 7-117)

## lan.trigger[N].clear()

This function clears the event detector for a LAN trigger.

Type	TSP-Link accessible	Affected by	Where saved	Default value
Function	Yes			

### Usage

```
lan.trigger[N].clear()
```

<i>N</i>	The LAN event number (1 to 8) to clear
----------	--

### Details

The trigger event detector enters the detected state when an event is detected. This function clears a trigger event detector and discards the previous of the trigger packet.

This function clears all overruns associated with this LAN trigger.

**Example**

<code>lan.trigger[5].clear()</code>	Clears the event detector with LAN packet 5.
-------------------------------------	--

**Also see**

[lan.trigger\[N\].assert\(\)](#) (on page 7-108)  
[lan.trigger\[N\].overrun](#) (on page 7-113)  
[lan.trigger\[N\].stimulus](#) (on page 7-115)  
[lan.trigger\[N\].wait\(\)](#) (on page 7-117)

**lan.trigger[N].connect()**

This function prepares the event generator for outgoing trigger events.

Type	TSP-Link accessible	Affected by	Where saved	Default value
Function	Yes			

**Usage**

```
lan.trigger[N].connect()
```

<i>N</i>	The LAN event number (1 to 8)
----------	-------------------------------

**Details**

This command prepares the event generator to send event messages. For TCP connections, this opens the TCP connection.

The event generator automatically disconnects when either the protocol or IP address for this event is changed.

**Example**

<pre>lan.trigger[1].protocol = lan.MULTICAST lan.trigger[1].connect() lan.trigger[1].assert()</pre>	<p>Set the protocol for LAN trigger 1 to be multicast when sending LAN triggers. Then, after connecting the LAN trigger, send a message on LAN trigger 1 by asserting it.</p>
---	---

**Also see**

[lan.trigger\[N\].assert\(\)](#) (on page 7-108)  
[lan.trigger\[N\].ipaddress](#) (on page 7-111)  
[lan.trigger\[N\].overrun](#) (on page 7-113)  
[lan.trigger\[N\].protocol](#) (on page 7-114)  
[lan.trigger\[N\].stimulus](#) (on page 7-115)  
[lan.trigger\[N\].wait\(\)](#) (on page 7-117)

**lan.trigger[N].connected**

This attribute stores the LAN event connection state.

Type	TSP-Link accessible	Affected by	Where saved	Default value
Attribute (R)	Yes	Not applicable	Not applicable	Not applicable

## Usage

```
connected = lan.trigger[N].connected
```

<i>connected</i>	The LAN event connection state: <ul style="list-style-type: none"> <li>• true: Connected</li> <li>• false: Not connected</li> </ul>
<i>N</i>	The LAN event number (1 to 8)

## Details

This read-only attribute is set to `true` when the LAN trigger is connected and ready to send trigger events following a successful `lan.trigger[N].connect()` command; if the LAN trigger is not ready to send trigger events, this value is `false`.

This attribute is also `false` when either `lan.trigger[N].protocol` or `lan.trigger[N].ipaddress` attributes are changed or the remote connection closes the connection.

## Example

```
lan.trigger[1].protocol = lan.MULTICAST
print(lan.trigger[1].connected)
```

Outputs true if connected, or false if not connected.  
Example output:  
false

## Also see

[lan.trigger\[N\].connect\(\)](#) (on page 7-109)  
[lan.trigger\[N\].ipaddress](#) (on page 7-111)  
[lan.trigger\[N\].protocol](#) (on page 7-114)

## lan.trigger[N].disconnect()

This function disconnects the LAN trigger.

Type	TSP-Link accessible	Affected by	Where saved	Default value
Function	Yes			

## Usage

```
lan.trigger[N].disconnect()
```

<i>N</i>	The LAN event number (1 to 8)
----------	-------------------------------

## Details

For TCP connections, this closes the TCP connection.

The LAN trigger automatically disconnects when either the `lan.trigger[N].protocol` or `lan.trigger[N].ipaddress` attributes for this event are changed.

## Also see

[lan.trigger\[N\].ipaddress](#) (on page 7-111)  
[lan.trigger\[N\].protocol](#) (on page 7-114)

## lan.trigger[N].EVENT\_ID

This constant is the event identifier used to route the LAN trigger to other subsystems (using stimulus properties).

Type	TSP-Link accessible	Affected by	Where saved	Default value
Constant	Yes			

### Usage

```
lan.trigger[N].EVENT_ID
```

<i>N</i>	The LAN event number (1 to 8)
----------	-------------------------------

### Details

Set the stimulus of any trigger event detector to the value of this constant to have it respond to incoming LAN trigger packets.

### Example

<code>digio.trigger[14].stimulus = lan.trigger[1].EVENT_ID</code>	Route occurrences of triggers on LAN trigger 1 to digital I/O trigger 14.
---	---

### Also see

None

## lan.trigger[N].ipaddress

This attribute specifies the address (in dotted-decimal format) of UDP or TCP listeners.

Type	TSP-Link accessible	Affected by	Where saved	Default value
Attribute (RW)	Yes	Instrument reset LAN trigger N reset Recall setup	Create configuration script	"0.0.0.0"

### Usage

```
ipAddress = lan.trigger[N].ipaddress
lan.trigger[N].ipaddress = ipAddress
```

<i>ipAddress</i>	The LAN address for this attribute as a string in dotted decimal notation
<i>N</i>	The LAN event number (1 to 8)

### Details

Sets the IP address for outgoing trigger events.

Set to "0.0.0.0" for multicast.

After changing this setting, the `lan.trigger[N].connect()` command must be called before outgoing messages can be sent.

**Example**

```
lan.trigger[3].protocol = lan.TCP
lan.trigger[3].ipaddress = "192.168.1.100"
lan.trigger[3].connect()
```

Set the protocol for LAN trigger 3 to be `lan.TCP` when sending LAN triggers. Use IP address "192.168.1.100" to connect the LAN trigger.

**Also see**

[lan.trigger\[N\].connect\(\)](#) (on page 7-109)

**lan.trigger[N].mode**

This attribute sets the trigger operation and detection mode of the specified LAN event.

Type	TSP-Link accessible	Affected by	Where saved	Default value
Attribute (RW)	Yes	Instrument reset LAN trigger N reset Recall setup	Create configuration script	0 (lan.TRIG_EITHER)

**Usage**

```
mode = lan.trigger[N].mode
lan.trigger[N].mode = mode
```

<i>mode</i>	A number representing the trigger mode (0 to 7); see the <b>Details</b> section for more information
<i>N</i>	A number representing the LAN event number (1 to 8)

**Details**

This command controls how the trigger event detector and the output trigger generator operate on the given trigger. These settings are intended to provide behavior similar to the digital I/O triggers.

LAN trigger mode values			
Mode	Number	Trigger packets detected as input	LAN trigger packet generated for output with a...
lan.TRIG_EITHER	0	Rising or falling edge (positive or negative state)	negative state
lan.TRIG_FALLING	1	Falling edge (negative state)	negative state
lan.TRIG_RISING	2	Rising edge (positive state)	positive state
lan.TRIG_RISINGA	3	Rising edge (positive state)	positive state
lan.TRIG_RISINGM	4	Rising edge (positive state)	positive state
lan.TRIG_SYNCHRONOUS	5	Falling edge (negative state)	positive state
lan.TRIG_SYNCHRONOUSA	6	Falling edge (negative state)	positive state
lan.TRIG_SYNCHRONOUM	7	Rising edge (positive state)	negative state

`lan.TRIG_RISING` and `lan.TRIG_RISINGA` are the same.

`lan.TRIG_RISING` and `lan.TRIG_RISINGM` are the same.

Use of either `lan.TRIG_SYNCHRONOUSA` or `lan.TRIG_SYNCHRONOUSM` over `lan.TRIG_SYNCHRONOUS` is preferred, as `lan.TRIG_SYNCHRONOUS` is provided for compatibility with other Keithley Instruments products.

### Example

```
print(lan.trigger[1].mode)
```

Outputs the present LAN trigger mode of LAN event 1.

### Also see

Digital I/O  
[TSP-Link system](#) (on page 6-44)

## lan.trigger[N].overrun

This attribute contains the overrun status of the LAN event detector.

Type	TSP-Link accessible	Affected by	Where saved	Default value
Attribute (R)	Yes	LAN trigger N clear LAN trigger N reset Instrument reset Recall setup	Not applicable	Not applicable

### Usage

```
overrun = lan.trigger[N].overrun
```

<code>overrun</code>	The trigger overrun state for the specified LAN packet ( <code>true</code> or <code>false</code> )
<code>N</code>	The LAN event number (1 to 8)

### Details

This command indicates whether an event has been ignored because the event detector was already in the detected state when the event occurred.

This is an indication of the state of the event detector built into the synchronization line itself. It does not indicate if an overrun occurred in any other part of the trigger model, or in any other construct that is monitoring the event.

It also is not an indication of an output trigger overrun.

### Example

```
overrun = lan.trigger[5].overrun  
print(overrun)
```

Checks the overrun status of a trigger on LAN5 and outputs the value, such as:  
false

### Also see

[lan.trigger\[N\].assert\(\)](#) (on page 7-108)  
[lan.trigger\[N\].clear\(\)](#) (on page 7-108)  
[lan.trigger\[N\].stimulus](#) (on page 7-115)  
[lan.trigger\[N\].wait\(\)](#) (on page 7-117)



## lan.trigger[N].protocol

This attribute sets the LAN protocol to use for sending trigger messages.

Type	TSP-Link accessible	Affected by	Where saved	Default value
Attribute (RW)	Yes	Instrument reset LAN trigger N reset Recall setup	Create configuration script	0 (lan.TCP)

### Usage

```
protocol = lan.trigger[N].protocol
lan.trigger[N].protocol = protocol
```

<i>protocol</i>	The protocol to use for messages from the trigger: <ul style="list-style-type: none"> <li>0 or lan.TCP</li> <li>1 or lan.UDP</li> <li>2 or lan.MULTICAST</li> </ul>
<i>N</i>	The LAN event number (1 to 8)

### Details

The LAN trigger listens for trigger messages on all supported protocols, but uses the designated protocol for sending outgoing messages. After changing this setting, `lan.trigger[N].connect()` must be called before outgoing event messages can be sent.

When the `lan.MULTICAST` protocol is selected, the `lan.trigger[N].ipaddress` attribute is ignored and event messages are sent to the multicast address 224.0.23.159.

### Example

```
print(lan.trigger[1].protocol)
```

Get LAN protocol to use for sending trigger messages for LAN event 1.

### Also see

[lan.trigger\[N\].connect\(\)](#) (on page 7-109)

[lan.trigger\[N\].ipaddress](#) (on page 7-111)

## lan.trigger[N].pseudostate

This attribute sets the simulated line state for the LAN trigger.

Type	TSP-Link accessible	Affected by	Where saved	Default value
Attribute (RW)	Yes	Instrument reset LAN trigger N reset Recall setup	Create configuration script	1

### Usage

```
pseudostate = lan.trigger[N].pseudostate
lan.trigger[N].pseudostate = pseudostate
```

<i>pseudostate</i>	The simulated line state (0 or 1)
<i>N</i>	A number representing the LAN event number (1 to 8)

**Details**

This attribute can be set to initialize the pseudo line state to a known value. Setting this attribute does not cause the LAN trigger to generate any events or output packets.

**Example**

```
print(lan.trigger[1].pseudostate)
```

Get the present simulated line state for the LAN event 1.

**Also see**

None

**lan.trigger[N].stimulus**

This attribute specifies events that cause this trigger to assert.

Type	TSP-Link accessible	Affected by	Where saved	Default value
Attribute (RW)	Yes	Instrument reset LAN trigger N reset Recall setup	Create configuration script	0

**Usage**

```
triggerStimulus = lan.trigger[N].stimulus
lan.trigger[N].stimulus = triggerStimulus
```

<i>triggerStimulus</i>	The LAN event identifier used to trigger the event
<i>N</i>	A number specifying the trigger packet over the LAN for which to set or query the trigger source (1 to 8)

## Details

This attribute specifies which event causes a LAN trigger packet to be sent for this trigger. Set *triggerStimulus* to one of the existing trigger event IDs shown in the following table.

Trigger event IDs	
Trigger event ID	Description
<code>digio.trigger[N].EVENT_ID</code>	An edge (rising, falling, or either based on the configuration of the line) on the digital input line.
<code>display.trigger.EVENT_ID</code>	The trigger key on the front panel is pressed.
<code>trigger.EVENT_ID</code>	A *trg message on the active command interface. If GPIB is the active command interface, a GET message also generates this event.
<code>trigger.blender[N].EVENT_ID</code>	A combination of events has occurred.
<code>trigger.timer[N].EVENT_ID</code>	A delay expired.
<code>tsplink.trigger[N].EVENT_ID</code>	An edge (rising, falling, or either based on the configuration of the line) on the TSP-Link trigger line.
<code>lan.trigger[N].EVENT_ID</code>	A LAN trigger event has occurred.
<code>scan.trigger.EVENT_SCAN_READY</code>	A Scan Ready Event has occurred.
<code>scan.trigger.EVENT_SCAN_START</code>	A Scan Start Event has occurred.
<code>scan.trigger.EVENT_CHANNEL_READY</code>	A Channel Ready Event has occurred.
<code>scan.trigger.EVENT_SCAN_COMP</code>	A Scan Complete Event has occurred.
<code>scan.trigger.EVENT_IDLE</code>	An Idle Event has occurred.

Setting this attribute to zero disables automatic trigger generation.

If any events are detected prior to calling `lan.trigger[N].connect()`, the event is ignored and the action overrun is set.

## Example

<code>lan.trigger[5].stimulus = trigger.timer[1].EVENT_ID</code>	Use timer 1 trigger event as the source for LAN packet 5 trigger stimulus.
--	--

## Also see

[lan.trigger\[N\].assert\(\)](#) (on page 7-108)  
[lan.trigger\[N\].clear\(\)](#) (on page 7-108)  
[lan.trigger\[N\].connect\(\)](#) (on page 7-109)  
[lan.trigger\[N\].overrun](#) (on page 7-113)  
[lan.trigger\[N\].wait\(\)](#) (on page 7-117)

## lan.trigger[N].wait()

This function waits for an input trigger.

Type	TSP-Link accessible	Affected by	Where saved	Default value
Function	Yes			

### Usage

```
triggered = lan.trigger[N].wait(timeout)
```

<i>triggered</i>	Trigger detection indication (true or false)
<i>N</i>	The trigger packet over LAN to wait for (1 to 8)
<i>timeout</i>	Maximum amount of time in seconds to wait for the trigger event

### Details

If one or more trigger events have been detected since the last time `lan.trigger[N].wait()` or `lan.trigger[N].clear()` was called, this function returns immediately.

After waiting for a LAN trigger event with this function, the event detector is automatically reset and rearmed regardless of the number of events detected.

### Example

<code>triggered = lan.trigger[5].wait(3)</code>	Wait for a trigger with LAN packet 5 with a timeout of 3 seconds.
---	---

### Also see

[lan.trigger\[N\].assert\(\)](#) (on page 7-108)  
[lan.trigger\[N\].clear\(\)](#) (on page 7-108)  
[lan.trigger\[N\].overrun](#) (on page 7-113)  
[lan.trigger\[N\].stimulus](#) (on page 7-115)

## localnode.define.\*

These constants indicate the number of available features (of each feature type) for each local node instrument.

Type	TSP-Link accessible	Affected by	Where saved	Default value
CONSTANT (R)	--			
.MAX_TIMERS	Yes			
.MAX_DIO_LINES	Yes			
.MAX_TSPLINK_TRIGS	Yes			
.MAX_BLENDERS	Yes			
.MAX_BLENDER_INPUTS	Yes			
.MAX_LAN_TRIGS	Yes			

### Usage

```

maxNumber = localnode.define.MAX_TIMERS
maxNumber = localnode.define.MAX_DIO_LINES
maxNumber = localnode.define.MAX_TSPLINK_TRIGS
maxNumber = localnode.define.MAX_BLENDERS
maxNumber = localnode.define.MAX_BLENDER_INPUTS
maxNumber = localnode.define.MAX_LAN_TRIGS
maxNumber = localnode.define.MAX_CHANNEL_TRIGS

```

<i>maxNumber</i>	A variable assigned the value of the constant.; the constant equals the local node instrument's maximum number available for the specified feature
------------------	--

### Details

These read-only constants indicate the following types of features: timers, digital input/output lines, triggers, and blenders. They provide the number of features available (which is the maximum) for the specified local node feature.

When using this command from a remote node, `localnode` should be replaced with the node reference, for example `node[5].define.MAX_TIMERS`.

### Example

<code>maxNumber = localnode.define.MAX_TIMERS</code>	Reads the maximum number of timers that are available for the presently active instrument.
--	--

### Also see

None

---

## localnode.description

This attribute stores a user-defined description and mDNS service name of the instrument.

Type	TSP-Link accessible	Affected by	Where saved	Default value
Attribute (RW)	Yes	Not applicable	Nonvolatile memory	Instrument specific (see <b>Details</b> )

### Usage

```
localnode.description = description
description = localnode.description
```

<i>description</i>	User-defined description and mDNS service name of the instrument; use a string of 63 characters or less
--------------------	---

### Details

This attribute stores a string that contains a description of the instrument. This value appears on LXI welcome page of the instrument. The value of this attribute is also used as the mDNS service name of the instrument.

This attribute's default value contains *Keithley ModelNumber #SSSSSSSS*, where: *ModelNumber* is the instrument's model number, and *#SSSSSSSS* is the instrument's eight-digit serial number. You can change it to a value that makes sense for your system. Setting this attribute to an empty string (in other words, setting this attribute to a string of length zero, or one consisting entirely of whitespace characters) will revert the description to the factory default value.

When using this command from a remote node, `localnode` should be replaced with the node reference, for example `node[5].description`.

### Example

<pre>description = "System in Lab 05" localnode.description = description</pre>	Set description to "System in Lab 05".
---	--

### Also see

None

## node[N].execute()

This function starts test scripts on a remote TSP-Link node.

Type	TSP-Link accessible	Affected by	Where saved	Default value
Function	Yes (see <b>Details</b> )			

### Usage

```
node[N].execute(scriptCode)
```

<i>N</i>	The node number of this instrument (1 to 64)
<i>scriptCode</i>	A string containing the source code

### Details

This command is only applicable to TSP-Link systems. You can use this command to use the remote master node to run a script on the specified node. This function does not run test scripts on the master node; only on the subordinate node when initiated by the master node.

This function may only be called when the group number of the node is different than the node of the master.

This function does not wait for the script to finish execution.

### Example 1

<code>node[2].execute(sourcecode)</code>	Runs script code on node 2. The code is in a string variable called <code>sourcecode</code> .
--	---

### Example 2

<code>node[3].execute("x = 5")</code>	Runs script code in string constant ("x = 5") to set <code>x</code> equal to 5 on node 3.
---------------------------------------	---

### Example 3

<code>node[32].execute(TestDut.source)</code>	Runs the test script stored in the variable <code>TestDut</code> (previously stored on the master node) on node 32.
---	---

### Also see

[Using TSP to run test scripts simultaneously](#) (on page 6-48)  
[tsplink.group](#) (on page 7-214)

## node[N].getglobal()

This function returns the value of a global variable.

Type	TSP-Link accessible	Affected by	Where saved	Default value
Function	Yes			

### Usage

```
value = node[N].getglobal(name)
```

<i>value</i>	The value of the variable
<i>N</i>	The node number of this instrument (1 to 64)
<i>name</i>	The global variable name

## Details

This function retrieves the value of a global variable from the run-time environment of this node. Do not use this command to retrieve the value of a global variable from the local node. Instead, access the global variable directly. This command should only be used from a remote master when controlling this instrument over a TSP-Link<sup>®</sup> network.

## Example

```
print(node[5].getglobal("test_val"))
```

Retrieves and outputs the value of the global variable named test\_val from node 5.

## Also see

[node\[N\].setglobal\(\)](#) (on page 7-126)  
[Using TSP to run test scripts simultaneously](#) (on page 6-48)

## localnode.model

This attribute stores the model number.

Type	TSP-Link accessible	Affected by	Where saved	Default value
Attribute (R)	Yes	Not applicable	Not applicable	Not applicable

## Usage

```
model = localnode.model
```

```
model
```

The model number of the instrument

## Example

```
print(localnode.model)
```

Outputs the model number of the local node. For example:  
707B

## Also see

[localnode.serialno](#) (on page 7-126)

## localnode.password

This attribute stores the remote access password.

Type	TSP-Link accessible	Affected by	Where saved	Default value
Attribute (W)	Yes	LAN reset	Nonvolatile memory	"admin"

## Usage

```
localnode.password = "password"
```

```
password
```

A string that contains the remote interface password

## Details

This write-only attribute stores the password that is set for any remote interface. When password usage is enabled (`localnode.passwordmode`), you must supply a password to change the configuration or to control an instrument from a web page or other remote command interface.



The instrument continues to use the old password for all interactions until the command to change it executes. When changing the password, give the instrument time to execute the command before attempting to use the new password.

You can retrieve the password from the front panel through **MENU > LAN > STATUS > PASSWORD**.

You can reset the password by resetting the LAN from the front panel or by using the `lan.reset()` command.

When using this command from a remote node, `localnode` should be replaced with the node reference, for example, `node[5].password`.

### Example

<code>localnode.password = "N3wpa55w0rd"</code>	Changes the remote interface password to N3wpa55w0rd.
---	---

### Also see

[lan.reset\(\)](#) (on page 7-101)  
[localnode.passwordmode](#) (on page 7-122)

## localnode.passwordmode

This attribute stores the remote access password enable mode.

Type	TSP-Link accessible	Affected by	Where saved	Default value
Attribute (RW)	Yes	Not applicable	Nonvolatile memory	1 (localnode.PASSWORD_WEB)

### Usage

```
mode = localnode.passwordmode
localnode.passwordmode = mode
```

<code>mode</code>	The remote password enable mode
-------------------	---------------------------------

### Details

This attribute controls if and where remote access passwords are required. Set this attribute to one of the values below to enable password checking:

`localnode.PASSWORD_NONE` or 0: Disable passwords everywhere

`localnode.PASSWORD_WEB` or 1: Use passwords on the web interface only

`localnode.PASSWORD_LAN` or 2: Use passwords on the web interface and all LAN interfaces

`localnode.PASSWORD_ALL` or 3: Use passwords on the web interface and all remote command interfaces

When using this command from a remote node, `localnode` should be replaced with the node reference, for example `node[5].passwordmode`.

### Example

<code>mode = localnode.PASSWORD_WEB</code> <code>localnode.passwordmode = mode</code>	Sets value of <code>mode</code> to <code>PASSWORD_WEB</code> . Allows use of passwords on the web interface only.
--	--

### Also see

[localnode.password](#) (on page 7-121)

## localnode.prompts

This attribute determines if the instrument generates prompts in response to command messages.

Type	TSP-Link accessible	Affected by	Where saved	Default value
Attribute (RW)	Yes	Power cycle	Not saved	0 (disabled)

### Usage

```
prompting = localnode.prompts
localnode.prompts = prompting
```

<i>prompting</i>	Do not generate prompts: 1 Generate prompts: 0
------------------	---

### Details

When the prompting mode is enabled, the instrument generates prompts when the instrument is ready to take another command. Because the prompt is not generated until the previous command completes, enabling prompts provides handshaking with the instrument to prevent buffer overruns.

When prompting is enabled, the instrument might generate the following prompts:

- **TSP>**. The standard prompt, which indicates that the previous command completed normally.
- **TSP?**. The prompt that is issued if there are unread entries in the error queue when the prompt is issued. Like the TSP> prompt, it indicates that processing of the command is complete. It does not mean the previous command generated an error, only that there were still errors in the queue when the command processing was complete.
- **>>>>**. The continuation prompt, which occurs when downloading scripts. When downloading scripts, many command messages must be sent as a group. The continuation prompt indicates that the instrument is expecting more messages as part of the present command.

Commands do not generate prompts. The instrument generates prompts in response to command completion.

Prompts are enabled or disabled only for the remote interface that is active when you send the command. For example, if you enable prompts when the GPIB connection is active, they will not be enabled for a subsequent USB connection.

## NOTE

Do not disable prompting when using Test Script Builder. Test Script Builder requires prompts and sets the prompting mode automatically. If you disable prompting, the instrument will stop responding when you communicate using Test Script Builder because it is waiting for a common complete prompt from Test Script Builder.

### Example

```
localnode.prompts = 1 Enable prompting.
```

### Also see

[localnode.prompts4882](#) (on page 7-124)  
[localnode.showerrors](#) (on page 7-127)  
[tsplink.reset\(\)](#) (on page 7-217)

## localnode.prompts4882

This attribute enables and disables the generation of prompts for IEEE Std 488.2 common commands.

Type	TSP-Link accessible	Affected by	Where saved	Default value
Attribute (RW)	Yes	Power cycle	Not saved	1 (enabled)

### Usage

```
prompting = localnode.prompts4882
localnode.prompts4882 = prompting
```

<i>prompting</i>	IEEE Std 488.2 prompting mode: <ul style="list-style-type: none"> <li>• Disable prompting: 0</li> <li>• Enable prompting: 1</li> </ul>
------------------	--

### Details

When this attribute is enabled, the IEEE Std 488.2 common commands generate prompts if prompting is enabled with the `localnode.prompts` attribute. If `localnode.prompts4882` is enabled, limit the number of `*trg` commands sent to a running script to 50 regardless of the setting of the `localnode.prompts` attribute.

When this attribute is disabled, IEEE Std 488.2 common commands will not generate prompts. When using the `*trg` command with a script that executes `trigger.wait()` repeatedly, disable prompting to avoid problems associated with the command interface input queue filling.

### Example

```
localnode.prompts4882 = 0
```

Disables IEEE Std 488.2 common command prompting.

### Also see

[localnode.prompts](#) (on page 7-123)

## localnode.reset()

This function resets the local node instrument.

Type	TSP-Link accessible	Affected by	Where saved	Default value
Function	Yes			

### Usage

```
localnode.reset()
```

## Details

If you want to reset a specific instrument or a subordinate node, use the `node[X].reset()` command.

A local node reset includes a `channel.reset("allslots")` and a `scan.reset()`. In addition:

- Other settings are restored back to factory default settings
- Existing channel patterns are deleted
- All channels are opened

A `localnode.reset()` is different than a `reset()` because `reset()` resets the entire system.

When using this command from a remote node, `localnode` should be replaced with the node reference, for example `node[5].reset()`.

## Example

```
localnode.reset()
```

Resets the local node.

## Also see

[channel.reset\(\)](#) (on page 7-40)

[reset\(\)](#) (on page 7-135)

[scan.reset\(\)](#) (on page 7-146)

# localnode.revision

This attribute stores the firmware revision level.

Type	TSP-Link accessible	Affected by	Where saved	Default value
Attribute (R)	Yes	Not applicable	Not applicable	Not applicable

## Usage

```
revision = localnode.revision
```

```
revision
```

Firmware revision level

## Details

This attribute indicates the revision number of the firmware that is presently running in the instrument.

When using this command from a remote node, `localnode` should be replaced with the node reference. For example, `node[5].revision`.

## Example

```
print(localnode.revision)
```

Outputs the present revision level.  
Sample output:  
01.00a

## Also see

[localnode.description](#) (on page 7-119)

[localnode.model](#) (on page 7-121)

[localnode.serialno](#) (on page 7-126)

---

## localnode.serialno

This attribute stores the instrument's serial number.

Type	TSP-Link accessible	Affected by	Where saved	Default value
Attribute (R)	Yes	Not applicable	Not applicable	Not applicable

### Usage

```
serialno = localnode.serialno
```

<code>serialno</code>	The serial number of the instrument
-----------------------	-------------------------------------

### Details

This indicates the instrument serial number.

### Example

<code>display.clear()</code> <code>display.settext(localnode.serialno)</code>	Clears the instrument display. Places the serial number of the instrument on the top line of its display.
--	--

### Also see

[localnode.description](#) (on page 7-119)  
[localnode.model](#) (on page 7-121)  
[localnode.revision](#) (on page 7-125)

---

## node[N].setglobal()

This function sets the value of a global variable.

Type	TSP-Link accessible	Affected by	Where saved	Default value
Function	Yes			

### Usage

```
node[N].setglobal(name, value)
```

<i>N</i>	The node number of this instrument (1 to 64)
<i>name</i>	The global variable name to set
<i>value</i>	The value to assign to the variable

### Details

From a remote node, use this function to assign the given value to a global variable. Do not use this command to create or set the value of a global variable from the local node (set the global variable directly instead). This command should only be used from a remote master when controlling this instrument over a TSP-Link®.

**Example**

```
node[3].setglobal("x", 5)
```

 Sets the global variable `x` on node 3 to the value of 5.
**Also see**

[node\[N\].getglobal\(\)](#) (on page 7-120)  
[Using TSP to run test scripts simultaneously](#) (on page 6-48)

## localnode.showerrors

This attribute sets whether or not the instrument automatically sends generated errors.

Type	TSP-Link accessible	Affected by	Where saved	Default value
Attribute (RW)	Yes	Power cycle	Not saved	0 (disabled)

**Usage**

```
errorMode = localnode.showerrors
localnode.showerrors = errorMode
```

```
errorMode
```

 Enables (1) or disables (0) the show errors state
**Details**

If this attribute is set to 1, the instrument automatically sends any generated errors stored in the error queue, and then clears the queue. Errors are processed after executing a command message (just before issuing a prompt, if prompts are enabled).

If this attribute is set to 0, errors are left in the error queue and must be explicitly read or cleared.

When using this command from a remote node, `localnode` should be replaced with the node reference, for example, `node[5].showerrors`.

**Example**

```
localnode.showerrors = 1
```

 Enables sending of generated errors.
**Also see**

[localnode.prompts](#) (on page 7-123)

## makegetter()

This function creates a function to get the value of an attribute.

Type	TSP-Link accessible	Affected by	Where saved	Default value
Function	No			

**Usage**

```
getter = makegetter(table, attributeName)
```

<code>getter</code>	The return value
<code>table</code>	Read-only table where the attribute is located
<code>attributeName</code>	A string representing the name of the attribute

## Details

This function is useful for aliasing attributes to improve execution speed. Calling the function created with `makegetter()` executes faster than accessing the attribute directly.

Creating a getter function is only useful if it is going to be called several times. Otherwise, the overhead of creating the getter function outweighs the overhead of accessing the attribute directly.

## Example

```
getRule = makegetter(channel, "connectrule")
-- (intervening code)
r = getrule()
```

Creates a getter function called `getRule`.  
When `getRule()` is called, it returns the value of `connectrule`.

## Also see

[makesetter\(\)](#) (on page 7-128)

# makesetter()

This function creates a function that, when called, sets the value of an attribute.

Type	TSP-Link accessible	Affected by	Where saved	Default value
Function	No			

## Usage

```
setter = makesetter(table, attributeName)
```

<i>setter</i>	Function that sets the value of the attribute
<i>table</i>	Read-only table where the attribute is located
<i>attributeName</i>	The string name of the attribute

## Details

This function is useful for aliasing attributes to improve execution speed. Calling the `setter` function will execute faster than accessing the attribute directly.

Creating a `setter` function is only useful if it is going to be called several times. If you are not calling the `setter` function several times, it is more efficient to access the attribute directly.

## Example

```
setRule = makesetter(channel, "connectrule")
r = setrule(channel.BREAK_BEFORE_MAKE)
```

Creates a setter function called `setRule`.  
When `setRule()` is called, it configures the setting for `connectrule`. In this example, the connection rule is set to `break-before-make`.

## Also see

[makegetter\(\)](#) (on page 7-127)

## memory.available()

This function reads and returns the amount of memory that is available in the instrument overall for storing user scripts and channel patterns.

Type	TSP-Link accessible	Affected by	Where saved	Default value
Function	Yes			

### Usage

```
memoryAvailable = memory.available()
```

*memoryAvailable*

Comma-delimited string with percentages for available memory; the format is `systemMemory, scriptMemory, patternMemory`, where:

- `systemMemory`: The percentage of memory available in the instrument
- `scriptMemory`: The percentage of memory available in the instrument to store user scripts
- `patternMemory`: The percentage of memory available in the instrument to store channel patterns

### Details

Use this function to view the available memory in the overall instrument as well as the memory available for storing user scripts and channel patterns.

The response to this function is a single string that returns the overall instrument memory available, script memory available, and channel pattern memory available as comma-delimited percentages.

### Example: Available memory

```
memoryAvailable = memory.available()
print(memoryAvailable)
```

Reads and returns the amount of memory available in the instrument.

Output:

```
51.56, 92.84, 100.00
```

You can also use:

```
print(memory.available())
```

### Example: Used and available memory

```
print("Memory used:", memory.used())
print("Memory available: ",
      memory.available())
```

Reads and returns the amount memory used and memory available percentages.

Output:

```
Memory used: 69.14, 0.16, 12.74
```

```
Memory available: 30.86, 99.84, 87.26
```

### Also see

[memory.used\(\)](#) (on page 7-130)



---



---

## memory.used()

This function reports the amount of memory used in the instrument overall and for user scripts, and storing channel patterns.

Type	TSP-Link accessible	Affected by	Where saved	Default value
Function	Yes			

### Usage

---

```
memoryUsed = memory.used()
```

*memoryUsed*

A comma-delimited string with percentages for used memory; the format is `systemMemory, scriptMemory, patternMemory`, where:

- `systemMemory`: The percentage of memory used in the instrument
- `scriptMemory`: The percentage of memory used in the instrument to store user scripts
- `patternMemory`: The percentage of memory used in the instrument to store channel patterns

### Details

---

Use this function to view the used memory in the overall instrument, as well as the memory used for storing user scripts and channel patterns.

The response to this function is a single string that shows the overall instrument memory used, as well as the script memory used and channel pattern memory used as comma-delimited percentages.

### Example

---

```
MemUsed = memory.used()
print(MemUsed)
```

Reads the memory used in the instrument and returns out the percentages.

Output:

```
69.14, 0.16, 12.74
```

### Also see

---

[memory.available\(\)](#) (on page 7-129)

## opc()

This function sets the operation complete status bit when all overlapped commands are completed.

Type	TSP-Link accessible	Affected by	Where saved	Default value
Function	No			

### Usage

```
opc ( )
```

### Details

This function causes the operation complete bit in the Standard Event Status Register to be set when all previously started local overlapped commands are complete.

Note that each node independently sets its operation complete bits in its own status model. Any nodes that are not actively performing overlapped commands set their bits immediately. All remaining nodes set their own bits as they complete their own overlapped commands.

### Example

```
opc ( )
waitcomplete ( )
print ("1")
```

Output:  
1

### Also see

[Status model](#) (on page C-1, on page C-1)  
[waitcomplete\(\)](#) (on page 7-242)

## print()

This function generates a response message.

Type	TSP-Link accessible	Affected by	Where saved	Default value
Function	No			

### Usage

```
print (value1)
print (value1, value2)
print (value1, ..., valueN)
```

<i>value1</i>	The first argument to output
<i>value2</i>	The second argument to output
<i>valueN</i>	The last argument to output
...	One or more values separated with commas

## Details

TSP-enabled instruments do not have inherent query commands. Like any other scripting environment, the `print()` command and other related `print()` commands generate output. The `print()` command creates one response message.

The output from multiple arguments is separated with a tab character.

Numbers are printed using the `format.asciiprecision` attribute. If you want use Lua formatting, print the return value from the `tostring()` function.

### Example 1

```
x = 10
print(x)
```

Example of an output response message:  
1.0000000e+01  
Note that your output might be different if you set your ASCII precision setting to a different value.

### Example 2

```
x = true
print(tostring(x))
```

Example of an output response message:  
true

### Also see

[format.asciiprecision](#) (on page 7-89)

## printbuffer()

This function prints data from tables or reading buffer subtables.

Type	TSP-Link accessible	Affected by	Where saved	Default value
Function	No			

### Usage

```
printbuffer(startIndex, endIndex, bufferVar)
printbuffer(startIndex, endIndex, bufferVar, bufferVar2)
printbuffer(startIndex, endIndex, bufferVar, ..., bufferVarN)
```

<i>startIndex</i>	Beginning index of the buffer to print; this must be more than one and less than <i>endIndex</i>
<i>endIndex</i>	Ending index of the buffer to print; this must be more than <i>startIndex</i> and less than the index of the last entry in the tables
<i>bufferVar</i>	Name of first table or reading buffer subtable to print; may be a default buffer ( <code>defbuffer1</code> or <code>defbuffer2</code> ) or a user-defined buffer
<i>bufferVar2</i>	Second table or reading buffer subtable to print; may be a default buffer ( <code>defbuffer1</code> or <code>defbuffer2</code> ) or a user-defined buffer
<i>bufferVarN</i>	The last table or reading buffer subtable to print; may be a default buffer ( <code>defbuffer1</code> or <code>defbuffer2</code> ) or a user-defined buffer
...	One or more tables or reading buffer subtables separated with commas

## Details

---

If *startIndex* is set to less than 1 or if *endIndex* is more than the size of the index, 9.910000e+37 is returned for each value outside the allowed index and an event is generated.

If overlapped commands use the specified reading buffers and the commands are not complete (at least to the specified index), this function outputs data as it becomes available.

When there are outstanding overlapped commands to acquire data, *n* refers to the index that the last entry in the table has after all the readings have completed.

If you pass a reading buffer instead of a reading buffer subtable, the default subtable for that reading buffer is used.

This command generates a single response message that contains all data.

The `format.data` attribute controls the format of the response message.

You can use the *bufferVar* attributes that are listed in the following table with the print buffer command. For example, if *testData* is the buffer, you can use `testData.dates` attribute to print the date of each reading in the *testData* buffer.

You can use `bufferVar.n` to retrieve the number of readings in the specified reading buffer.

## Example 1

---

```
reset()
testData = buffer.make(200)
format.data = format.ASCII
format.asciiprecision = 6
trigger.model.load("SimpleLoop", 6, 0, testData)
trigger.model.initiate()
waitcomplete()
printbuffer(1, testData.n, testData.readings, testData.units,
  testData.relativetimestamps)
```

Reset the instrument.

Set the data format and ASCII precision.

Use trigger model SimpleLoop to create a 6 count loop with no delays that stores data in the reading buffer `testBuffer`.

Start the trigger model, wait for the commands to complete, and output the readings.

Use of `testData.n` (*bufferVar.n*) indicates that the instrument should output all readings in the reading buffer. In this example, `testBuffer.n` equals 6.

Example of output data:

```
1.10458e-11, Amp DC, 0.00000e+00, 1.19908e-11, Amp DC, 1.01858e-01, 1.19908e-11, Amp DC,
2.03718e-01, 1.20325e-11, Amp DC, 3.05581e-01, 1.20603e-11, Amp DC, 4.07440e-01, 1.20325e-
11, Amp DC, 5.09299e-01
```

## Example 2

---

```
for x = 1, testData.n do
printbuffer(x,x,testData, testData.units, testData.relativetimestamps)
end
```

Using the same buffer created in Example 1, output the readings, units and relative timestamps on a separate line for each reading.

```
1.10458e-11, Amp DC, 0.00000e+00
1.19908e-11, Amp DC, 1.01858e-01
1.19908e-11, Amp DC, 2.03718e-01
1.20325e-11, Amp DC, 3.05581e-01
1.20603e-11, Amp DC, 4.07440e-01
1.20325e-11, Amp DC, 5.09299e-01
```

**Also see**

[format.asciiprecision](#) (on page 7-89)  
[format.byteorder](#) (on page 7-89)  
[format.data](#) (on page 7-90)  
[printnumber\(\)](#) (on page 7-134)

**printnumber()**

This function prints numbers using the configured format.

Type	TSP-Link accessible	Affected by	Where saved	Default value
Function	No			

**Usage**

```
printnumber(value1)
printnumber(value1, value2)
printnumber(value1, ..., valueN)
```

<i>value1</i>	First value to print in the configured format
<i>value2</i>	Second value to print in the configured format
<i>valueN</i>	Last value to print in the configured format
...	One or more values separated with commas

**Details**

There are multiple ways to use this function, depending on how many numbers are to be printed. This function prints the given numbers using the data format specified by `format.data` and `format.asciiprecision`.

**Example**

<pre>format.asciiprecision = 10 x = 2.54 printnumber(x) format.asciiprecision = 3 printnumber(x, 2.54321, 3.1)</pre>	<p>Configure the ASCII precision to 10 and set <code>x</code> to 2.54.</p> <p>Read the value of <code>x</code> based on these settings.</p> <p>Change the ASCII precision to 3.</p> <p>View how the change affects the output of <code>x</code> and some numbers.</p> <p>Output:</p> <pre>2.540000000000e+00 2.54e+00, 2.54e+00, 3.10e+00</pre>
--	---

**Also see**

[format.asciiprecision](#) (on page 7-89)  
[format.byteorder](#) (on page 7-89)  
[format.data](#) (on page 7-90)  
[print\(\)](#) (on page 7-131)  
[printbuffer\(\)](#) (on page 7-132)

## reset()

This function resets commands to their default settings.

Type	TSP-Link accessible	Affected by	Where saved	Default value
Function	No			

### Usage

```
reset()
reset(system)
```

<i>system</i>	true: If the node is the master, the entire system is reset false: Only the local group is reset
---------------	---

### Details

The `reset()` command in its simplest form resets the entire TSP-enabled system, including the controlling node and all subordinate nodes.

If you want to reset a specific instrument, use either the `localnode.reset()` or `node[X].reset()` command. Use the `localnode.reset()` command for the local instrument. Use the `node[X].reset()` command to reset an instrument on a subordinate node.

When no value is specified for *system*, the default value is `true`.

You can only reset the entire system using `reset(true)` if the node is the master. If the node is not the master node, executing this command generates an error.

### Example

<code>reset(true)</code>	If the node is the master node, the entire system is reset; if the node is not the master node, an error is generated.
--------------------------	--

### Also see

[localnode.reset\(\)](#) (on page 7-124)

## scan.abort()

This function aborts a running background scan.

Type	TSP-Link accessible	Affected by	Where saved	Default value
Function	Yes			

### Usage

```
scan.abort()
```

### Details

If no scan is running, the call to this function is ignored.

## NOTE

When a scan is aborted, the channels remain in the opened or closed states that they were in when the scan was aborted.

**Example**

<code>scan.background()</code> <code>scan.abort()</code>	Starts background scan, and then aborts the scan.
---	---

**Also see**

[scan.background\(\)](#) (on page 7-139)  
[Scanning and triggering](#) (on page 3-1)

**scan.add()**

This function adds a scan step to the scan list.

Type	TSP-Link accessible	Affected by	Where saved	Default value
Function	Yes			

**Usage**

```
scan.add(channelList)
```

<i>channelList</i>	String specifying channels to add using normal channel list syntax
--------------------	--

**Details**

Use this function to add channels and channel patterns to the present scan list. If the scan list does not exist, it also creates a scan list. See `scan.create()` for information about creating a scan list. Channels and channel patterns added using the `scan.add()` function are added to the end of the present list (appended) in the same order as specified in *channelList*. Specifying multiple channels in *channelList* adds multiple steps to the scan.

If an error is encountered as channels are added to the list, subsequent channels in that channel list will not be added.

**Example 1**

<code>scan.create()</code>	Replaces the active scan list with an empty scan list.
<code>for column = 1,5 do</code>	Loops through columns 1 to 5.
<code>    scan.add(channel.createspecifier(1,1,column))</code>	Adds five channels to the scan list using the <code>channel.createspecifier()</code> command. The scan list now has row 1, columns 1 to 5 on slot 1 as the first five steps.
<code>end</code>	

---

**Example 2**

---

```
scan.create("1A01:1A08")
```

Replaces the active scan list with an empty scan list, and then adds row A, columns 1 through 8 on slot 1 to the new scan list.

```
scan.add("1A10")
```

Adds row A, column 10 on slot 1 to the end of the scan list.

```
scan.add("1A09")
```

Adds row A, column 9 on slot 1 to the end of the scan list.

Scan list now includes channels 1A01 through 1A10, with channels 1A01 through 1A08 in order, followed by channel 1A10, and then channel 1A09.

---

**Example 3**

---

```
scan.create(" ")
```

Clears the old scan list and creates a new empty scan list.

---

**Also see**

---

[scan.create\(\)](#) (on page 7-141)

[Scanning and triggering](#) (on page 3-1)



## scan.addimagestep()

This function allows you to include multiple channels in a single scan step.

Type	TSP-Link accessible	Affected by	Where saved	Default value
Function	Yes			

### Usage

```
scan.addimagestep(channelList)
```

<i>channelList</i>	String specifying a list of channels
--------------------	--------------------------------------

### Details

This function adds a list of channels to be closed simultaneously in a single step of a scan.

```
scan.create()
scan.add("1D01")
scan.addimagestep("1A01, 1B01, 1C03")
scan.add("1F03")
scan.addimagestep("1A03, 1B03, 1C03")
scan.addimagestep("1A05, 1B05, 1C03")
scan.addimagestep("1A07, 1B07, 1C03")
scan.addimagestep("1A09, 1B09, 1C03")
print(scan.list())
```

Generate a scan list that has multiple steps, with some steps that include multiple channels.

#### Output:

```
Init) OPEN...
  1) STEP: 1D01
      CLOSE: 1D01
  2) STEP: 1A01, 1B01, 1C03
      OPEN: 1D01
      CLOSE: 1A01 1B01 1C03
  3) STEP: 1F03
      OPEN: 1A01 1B01 1C03
      CLOSE: 1F03
  4) STEP: 1A03, 1B03, 1C03
      OPEN: 1F03
      CLOSE: 1A03 1B03 1C03
  5) STEP: 1A05, 1B05, 1C03
      OPEN: 1A03 1B03
      CLOSE: 1A05 1B05
  6) STEP: 1A07, 1B07, 1C03
      OPEN: 1A05 1B05
      CLOSE: 1A07 1B07
  7) STEP: 1A09, 1B09, 1C03
      OPEN: 1A07 1B07
      CLOSE: 1A09 1B09
```

### Also see

[scan.add\(\)](#) (on page 7-136)  
[Scanning and triggering](#) (on page 3-1)

## scan.background()

This function starts a scan and runs the scan in the background.

Type	TSP-Link accessible	Affected by	Where saved	Default value
Function	Yes			

### Usage

```
state, scanCount, stepCount = scan.background()
```

<i>state</i>	The result of scanning: scan.EMPTY or 0 scan.BUILDING or 1 scan.RUNNING or 2 scan.ABORTED or 3 scan.FAILED or 4 scan.FAILED_INIT or 5 scan.SUCCESS or 6
<i>scanCount</i>	The present number of scans completed
<i>stepCount</i>	The present number of steps completed

### Details

Before using this command, use `scan.create()` and `scan.add()` or `scan.addimagestep()` to set up a scan list.

When the scan is run in the background, you must use the `scan.state()` function to check the status of the scan.

### Example

<code>scan.background()</code>	Runs a scan in the background.
--------------------------------	--------------------------------

### Also see

[scan.add\(\)](#) (on page 7-136)  
[scan.create\(\)](#) (on page 7-141)  
[scan.execute\(\)](#) (on page 7-142)  
[scan.list\(\)](#) (on page 7-143)  
[scan.state\(\)](#) (on page 7-148)  
[Scanning and triggering](#) (on page 3-1)

## scan.bypass

This attribute indicates whether the first channel of the scan waits for the channel stimulus event to be satisfied before closing.

Type	TSP-Link accessible	Affected by	Where saved	Default value
Attribute (RW)	Yes	System reset Scan reset	Create configuration script	1 (scan.ON)

### Usage

```
bypass = scan.bypass
scan.bypass = bypass
```

*bypass*

The state of the bypass. Set to one of the following values:  
 scan.OFF or 0: Disabled  
 scan.ON or 1: Enabled

### Details

When *bypass* is ON and the `scan.trigger.arm.stimulus` is set to a non-zero value, the first channel of the scan closes (the `scan.trigger.channel.stimulus` setting is ignored).

For other channels (other than the first), the channel stimulus must be satisfied before the channel action takes place.

When *bypass* is OFF, every channel (including the first) must satisfy the `scan.trigger.channel.stimulus` setting before the channel action occurs for that step.

### Example

```
scan.bypass = scan.OFF
print(scan.bypass)
```

Disables the bypass option for scanning and displays the present bypass state.  
 Output:  
 0.000000000e+000

### Also see

[scan.trigger.arm.stimulus](#) (on page 7-150)  
[scan.trigger.channel.stimulus](#) (on page 7-153)  
[Scanning and triggering](#) (on page 3-1)

## scan.create()

This function deletes the existing scan list and creates a new list of channels and channel patterns to scan.

Type	TSP-Link accessible	Affected by	Where saved	Default value
Function	Yes			

### Usage

```
scan.create(channelList)
```

<i>channelList</i>	String specifying channels to add
--------------------	-----------------------------------

### Details

The existing scan list is lost after calling this function.

The items in *channelList* are scanned in the order listed.

If a forbidden channel is included in a range of channels or slot parameter (such as slot 1), the forbidden channel is ignored and no error is generated. If a forbidden channel is individually specified in the channel list, an error is generated.

If an error occurs, the scan list of channels or channel patterns is cleared, even though no new scan list is created.

The function `scan.reset()` clears the list. To clear the scan list without performing a scan reset, send an empty string for the *channelList* parameter.

### Example 1

```
scan.create("1A01:1A10")
```

Replaces the active scan list with an empty scan list, and then adds channels 1A01 through 1A10 on slot 1.

### Example 2

```
scan.create()

for column = 1, 10 do
    scan.add(channel.createspecifier(1,1,column))
end
```

Replaces the active scan list with an empty scan list.  
Loops through column 1 to 10 on row 1 of slot 1 to add ten channels to the scan list. The `channel.createspecifier()` command generates the parameters.  
The scan list now has, in order, row 1, columns 1 through 10, on slot 1.

### Also see

[scan.add\(\)](#) (on page 7-136)

[scan.reset\(\)](#) (on page 7-146)

[Scanning and triggering](#) (on page 3-1)

## scan.execute()

This function starts the scan immediately in the foreground with a configured scan list.

Type	TSP-Link accessible	Affected by	Where saved	Default value
Function	Yes			

### Usage

```
scanState, scanCount, stepCount = scan.execute()
```

<i>scanState</i>	The result of scanning: scan.EMPTY or 0 scan.BUILDING or 1 scan.RUNNING or 2 scan.ABORTED or 3 scan.FAILED or 4 scan.FAILED_INIT or 5 scan.SUCCESS or 6
<i>scanCount</i>	The present number of scans that have completed
<i>stepCount</i>	The present number of steps have completed

### Details

Before using this command, use `scan.create()` and `scan.add()` or `scan.addimagestep()` to set up a scan list.

Execution runs until the scan is complete or until the `abort` command is sent.

Because this function waits for the scan to complete, the `scan.state()` function cannot be used to see the current status of scanning.

### Example

<code>scan.execute()</code>	Runs a scan immediately.
-----------------------------	--------------------------

### Also see

- [scan.add\(\)](#) (on page 7-136)
- [scan.background\(\)](#) (on page 7-139)
- [scan.create\(\)](#) (on page 7-141)
- [scan.list\(\)](#) (on page 7-143)
- [scan.state\(\)](#) (on page 7-148)
- [Scanning and triggering](#) (on page 3-1)

---

## scan.list()

This function queries the active scan list.

Type	TSP-Link accessible	Affected by	Where saved	Default value
Function	Yes	Instrument reset Channel reset Scan reset Recall setup Change of channel or scan setting	Create configuration script Save setup	Empty list

### Usage

---

```
scanList = scan.list()
```

<i>scanList</i>	A string that lists the existing scan step information
-----------------	--

### Details

---

This function lists the existing scan list.

When you change a channel or scan attribute for an existing scan list item, the scan list is recreated based on this change. If the scan list cannot be rebuilt, an error is generated and the scan list is lost.

To avoid unintentional changes to an existing scan list, configure channel and scan settings before using the commands `scan.add()`, `scan.addimagestep()`, and `scan.create()` to build a scan list.

If the scan list is empty, the string "Empty Scan" is returned. Otherwise, the string lists each step in the scan along with its information for step, open, and close (see the example below).

**Example**

```
scan.create("1A07:1B03")  
print(scan.list())
```

Populate the scan list with the function `scan.create("1A07:1B03")`, then initiate the scan list to be output.

Outputs the existing scan list.

Output:

Init) OPEN...

1) STEP: 1A07

CLOSE: 1A07

2) STEP: 1A08

OPEN: 1A07

CLOSE: 1A08

3) STEP: 1A09

OPEN: 1A08

CLOSE: 1A09

4) STEP: 1A10

OPEN: 1A09

CLOSE: 1A10

5) STEP: 1A11

OPEN: 1A10

CLOSE: 1A11

6) STEP: 1A12

OPEN: 1A11

CLOSE: 1A12

7) STEP: 1B01

OPEN: 1A12

CLOSE: 1B01

8) STEP: 1B02

OPEN: 1B01

CLOSE: 1B02

9) STEP: 1B03

OPEN: 1B02

CLOSE: 1B03

**Also see**

[scan.create\(\)](#) (on page 7-141)

[Scanning and triggering](#) (on page 3-1)

---

## scan.mode

This attribute controls the scan mode setting.

Type	TSP-Link accessible	Affected by	Where saved	Default value
Attribute (RW)	Yes	System reset Scan reset	Create configuration script	0 (scan.MODE_OPEN_ALL)

### Usage

---

```
scanModeSetting = scan.mode
scan.mode = scanModeSetting
```

<i>scanModeSetting</i>	<p>The present scan mode setting. Set to one of the following values:</p> <ul style="list-style-type: none"> <li>• <code>scan.MODE_OPEN_ALL</code> or 0</li> <li>• <code>scan.MODE_OPEN_SELECTIVE</code> or 1: See Details</li> <li>•</li> </ul>
------------------------	--

### Details

---

When this attribute is set to `scan.MODE_OPEN_ALL`, all channels on all slots are opened before a scan starts.

When this attribute is set to `scan.MODE_OPEN_SELECTIVE`, an intelligent open is performed:

- All channels involved in scanning are opened
- Closed channels not involved in scanning remain closed during the scan

### Example

---

<code>scan.mode = scan.MODE_OPEN_SELECTIVE</code>	Sets the scan mode setting to open selective.
---	---

### Also see

---

[scan.reset\(\)](#) (on page 7-146)  
[Scanning and triggering](#) (on page 3-1)



## scan.reset()

This function resets the trigger model and scan list settings to their factory default settings.

Type	TSP-Link accessible	Affected by	Where saved	Default value
Function	Yes			

### Usage

```
scan.reset()
```

### Details

When `scan.reset()` is sent, the trigger model and scan settings that are reset to the factory defaults are:

- `scan.bypass`
- `scan.mode`
- `scan.scancount`
- `scan.trigger.arm.stimulus`
- `scan.trigger.channel.stimulus`

In addition, the scan list is cleared.

## NOTE

Sending this function only affects the trigger model and scan list settings. To reset all instrument settings to factory default settings, use the `reset()` command.

### Example

```
scan.reset()
```

Performs a reset on the trigger model and scan settings.

### Also see

- [channel.reset\(\)](#) (on page 7-40)
- [reset\(\)](#) (on page 7-135)
- [scan.bypass](#) (on page 7-140)
- [scan.mode](#) (on page 7-145)
- [scan.scancount](#) (on page 7-147)
- [scan.trigger.arm.stimulus](#) (on page 7-150)
- [scan.trigger.channel.stimulus](#) (on page 7-153)
- [Scanning and triggering](#) (on page 3-1)

---

## scan.scancount

This attribute sets the scan count in the trigger model.

Type	TSP-Link accessible	Affected by	Where saved	Default value
Attribute (RW)	Yes	Instrument reset Scan reset	Create configuration script	1

### Usage

```
scanCount = scan.scancount
scan.scancount = scanCount
```

<i>scanCount</i>	The present scan count value (1 to 2,000,000,000)
------------------	---

### Details

The scan count attribute setting indicates how many times the scan list is iterated through before the scan completes.

During a scan, the instrument iterates through the arm layer of the trigger model the specified number of times. After performing the specified number of iterations, the instrument returns to an idle state.

### Example

<code>scan.scancount = 5</code>	Sets the scan count to 5.
---------------------------------	---------------------------

### Also see

[Trigger model](#) (on page 3-1)  
[Scanning and triggering](#) (on page 3-1)

## scan.state()

This function provides the present state of a running background scan.

Type	TSP-Link accessible	Affected by	Where saved	Default value
Function	Yes			

### Usage

```
scanState, scanCount, stepCount = scan.state()
```

<i>scanState</i>	The present state of the scan running in the background. Possible states include: scan.EMPTY or 0 scan.BUILDING or 1 scan.RUNNING or 2 scan.ABORTED or 3 scan.FAILED or 4 scan.FAILED_INIT or 5 scan.SUCCESS or 6
<i>scanCount</i>	The current number of scans that have completed
<i>stepCount</i>	The current number of steps that have completed

### Details

*scanCount* is the number of the current iteration through the scan portion of the trigger model. This number does not increment until the scan begins. Therefore, if the instrument is waiting for an input to trigger a scan start, the scan count represents the previous number of scan iterations. If no scan has begun, the scan count is zero (0).

*stepCount* is the number of times the scan has completed a pass through the channel action portion of the trigger model. This number does not increment until after the action completes. Therefore, if the instrument is waiting for an input to trigger a channel action, the step count represents the previous step. If no step has yet completed, the step count is zero. If the step count has yet to complete the first step in a subsequent pass through a scan, the scan count represents the last step in the previous scan pass.

### Example

<pre>scan.background() scanState, scanCount, stepCount = scan.state() print(scanState)</pre>	<p>Runs a scan in the background. Check the present scan state. View value of <i>scanState</i>. Output shows that scan is running: 2.0000000e+00</p>
--	--

### Also see

[scan.background\(\)](#) (on page 7-139)  
[scan.mode](#) (on page 7-145)  
[Scanning and triggering](#) (on page 3-1)

## scan.stepcount

This attribute contains the number of steps in the present scan.

Type	TSP-Link accessible	Affected by	Where saved	Default value
Attribute (R)	Yes	Not applicable	Not applicable	Not applicable

### Usage

```
scanStepCount = scan.stepcount
```

<code>scanStepCount</code>	The present step count value
----------------------------	------------------------------

### Details

This is set by the number of steps in the active scan list. The value of this attribute is initially determined when the scan is created. Adding steps with the `scan.create()`, `scan.addimagestep()`, and `scan.add()` functions updates this attribute's value.

### Example

```
print(scan.stepcount)
```

Responds with the present step count.  
Output assuming there are five steps in the scan list:  
5.0000000e+00

### Also see

[scan.add\(\)](#) (on page 7-136)  
[scan.addimagestep\(\)](#) (on page 7-138)  
[scan.create\(\)](#) (on page 7-141)  
[Scanning and triggering](#) (on page 3-1)

## scan.trigger.arm.clear()

This function clears the arm event detector.

Type	TSP-Link accessible	Affected by	Where saved	Default value
Function	Yes			

### Usage

```
scan.trigger.arm.clear()
```

### Details

This function sets the trigger model's arm event detector to the undetected state.

### Example

```
scan.trigger.arm.clear()
```

Clears the arm event detector.

### Also see

[scan.trigger.arm.set\(\)](#) (on page 7-150)  
[scan.trigger.arm.stimulus](#) (on page 7-150)  
[Trigger model](#) (on page 3-1)  
[Scanning and triggering](#) (on page 3-1)

## scan.trigger.arm.set()

This function sets the arm event detector to the detected state.

Type	TSP-Link accessible	Affected by	Where saved	Default value
Function	Yes			

### Usage

```
scan.trigger.arm.set()
```

### Details

This function sets the arm event detector of the trigger model to the detected state.

### Example

<pre>scan.trigger.arm.set()</pre>	Sets the arm event detector to the detected state.
-----------------------------------	--

### Also see

[scan.trigger.arm.clear\(\)](#) (on page 7-149)  
[scan.trigger.arm.stimulus](#) (on page 7-150)  
[Trigger model](#) (on page 3-1)  
[Scanning and triggering](#) (on page 3-1)

## scan.trigger.arm.stimulus

This attribute determines which event starts the scan.

Type	TSP-Link accessible	Affected by	Where saved	Default value
Attribute (RW)	Yes	Instrument reset Recall setup Scan reset	Create configuration script Save setup	0

### Usage

```
eventID = scan.trigger.arm.stimulus
scan.trigger.arm.stimulus = eventID
```

<i>eventID</i>	Trigger stimulus used for the channel action (arm layer); see <b>Details</b>
----------------	--

### Details

This attribute selects which events cause the arm event detector to enter the detected state. Set this attribute to 0 to start the scan without waiting for an event.

*eventID* may be one of the following trigger event IDs.

- `digio.trigger[N].EVENT_ID`: An edge (either rising, falling, or either based on the configuration of the line) on the digital input line.
- `display.trigger.EVENT_ID`: The trigger key on the front panel is pressed.
- `trigger.EVENT_ID`: A \*trg message on the active command interface. If GPIB is the active command interface, a GET message will also generate this event.
- `trigger.blender[N].EVENT_ID`: A combination of configured events has occurred
- `trigger.timer[N].EVENT_ID`: A delay expired.

- `tsplink.trigger[N].EVENT_ID`: An edge (either rising, falling, or either based on the configuration of the line) on the `tsplink` trigger line.
- `lan.trigger[N].EVENT_ID`: Event identifier use to route the LAN trigger to other subsystems (using stimulus properties).
- `scan.trigger.EVENT_SCAN_READY`: Scan Ready Event.
- `scan.trigger.EVENT_SCAN_START`: Scan Start Event.
- `scan.trigger.EVENT_CHANNEL_READY`: Channel Ready Event.
- `scan.trigger.EVENT_SCAN_COMP`: Scan Complete Event.

`scan.trigger.EVENT_IDLE`: Idle Event.

## NOTE

Use one of the text trigger event IDs (for example, `digio.trigger[N].EVENT_ID`) to set the stimulus value rather than the numeric value. Doing this will make the code compatible for future upgrades.

### Example 1

```
scan.trigger.arm.stimulus =
  scan.trigger.EVENT_SCAN_READY
```

Sets trigger stimulus of the arm event detector to scan ready event.

### Example 2

```
scan.trigger.arm.stimulus = 0
```

The scan begins immediately.

### Example 3

```
scan.trigger.arm.stimulus = digio.trigger[3].EVENT_ID
```

The scan begins when the instrument receives a signal from digital I/O line 3.

### Also see

[scan.trigger.arm.clear\(\)](#) (on page 7-149)

[scan.trigger.arm.set\(\)](#) (on page 7-150)

[Trigger model](#) (on page 3-1)

[Scanning and triggering](#) (on page 3-1)

---



---

## scan.trigger.channel.clear()

This function clears the channel event detector.

Type	TSP-Link accessible	Affected by	Where saved	Default value
Function	Yes			

### Usage

```
scan.trigger.channel.clear()
```

### Details

This function clears the channel event detector of the trigger model (sets it to the undetected state).

### Example

<pre>scan.trigger.channel.clear()</pre>	Clears the channel event detector.
---	------------------------------------

### Also see

[scan.trigger.channel.set\(\)](#) (on page 7-152)  
[scan.trigger.channel.stimulus](#) (on page 7-153)  
[Trigger model](#) (on page 3-1)  
[Scanning and triggering](#) (on page 3-1)

---



---

## scan.trigger.channel.set()

This function sets the channel event detector to the detected state.

Type	TSP-Link accessible	Affected by	Where saved	Default value
Function	Yes			

### Usage

```
scan.trigger.channel.set()
```

### Details

This function sets the channel event detector of the trigger model to the detected state.

### Example

<pre>scan.trigger.channel.set()</pre>	Sets the channel event detector of the trigger model to the detected state.
---------------------------------------	---

### Also see

[scan.trigger.channel.clear\(\)](#) (on page 7-152)  
[scan.trigger.channel.stimulus](#) (on page 7-153)  
[Trigger model](#) (on page 3-1)  
[Scanning and triggering](#) (on page 3-1)

## scan.trigger.channel.stimulus

This attribute determines which trigger events cause the channel actions to occur.

Type	TSP-Link accessible	Affected by	Where saved	Default value
Attribute (RW)	Yes	Instrument reset Scan reset	Create configuration script	scan.trigger.EVENT_CHANNEL_READ Y

### Usage

```
eventID = scan.trigger.channel.stimulus
scan.trigger.channel.stimulus = eventID
```

<i>eventID</i>	Trigger stimulus used for the channel action; see <b>Details</b> for possible trigger event IDs
----------------	---

### Details

This attribute selects which events cause the channel event detector to enter the detected state. Set this attribute to 0 to start the channel action immediately at the default setting.

Set *eventID* to one of the existing trigger event IDs shown in the following table.

Trigger event IDs	
Trigger event ID	Description
channel.trigger[N].EVENT_ID or 41 to 48	The trigger event generated by the channel trigger <i>N</i> .
digio.trigger[N].EVENT_ID or 1 to 14	An edge (either rising, falling, or either based on the configuration of the line) on the digital input line.
display.trigger.EVENT_ID or 39	The trigger key (TRIG) on the front panel is pressed.
dmm.trigger.EVENT_LIMIT1_HIGH or 53	A DMM trigger event that indicates a measurement has exceed the high limit value on limit 1.
dmm.trigger.EVENT_LIMIT1_LOW or 52	A DMM trigger event that indicates a measurement has exceed the low limit value on limit 1.
dmm.trigger.EVENT_LIMIT2_HIGH or 55	A DMM trigger event that indicates a measurement has exceed the high limit value on limit 2.
dmm.trigger.EVENT_LIMIT2_LOW or 54	A DMM trigger event that indicates a measurement has exceed the low limit value on limit 2.
trigger.EVENT_ID or 40	A *trg message on the active command interface. If GPIB is the active command interface, a GET message also generates this event.



<code>trigger.blender[N].EVENT_ID</code> or 58 to 59	A combination of events has occurred.
<code>trigger.timer[N].EVENT_ID</code> or 20 to 23	A delay expired.
<code>tsplink.trigger[N].EVENT_ID</code> or 17 to 19	An edge (either rising, falling, or either based on the configuration of the line) on the TSP-Link trigger line.
<code>lan.trigger[N].EVENT_ID</code> or 29 to 36	A LAN trigger event has occurred.
<code>scan.trigger.EVENT_SCAN_READY</code> or 24	Scan ready event.
<code>scan.trigger.EVENT_SCAN_START</code> or 25	Scan start event.
<code>scan.trigger.EVENT_CHANNEL_READY</code> or 28	Channel ready event.
<code>scan.trigger.EVENT_MEASURE_COMP</code> or 56	Measure complete event.
<code>scan.trigger.EVENT_SEQUENCE_COMP</code> or 50	Sequence complete event.
<code>scan.trigger.EVENT_SCAN_COMP</code> or 26	Scan complete event.
<code>scan.trigger.EVENT_IDLE</code> or 27	Idle event.
<code>schedule.alarm[N].EVENT_ID</code> or 37 to 38	Trigger event generated by the alarm <i>N</i> .

## NOTE

Use one of the text trigger event IDs (for example, `digio.trigger[N].EVENT_ID`) to set the stimulus value rather than the numeric value. Doing this will make the code compatible for future upgrades.

### Example 1

```
scan.trigger.channel.stimulus =
scan.trigger.EVENT_SCAN_START
```

Sets the trigger stimulus of the channel event detector to scan start event.

### Example 2

```
scan.trigger.channel.stimulus = 0
print(scan.trigger.channel.stimulus)
```

Starts the channel action immediately after the Scan Start Event. This also resets the stimulus to the default.  
Output:  
5.000000000e+01

### Also see

[scan.trigger.channel.clear\(\)](#) (on page 7-152)  
[scan.trigger.channel.set\(\)](#) (on page 7-152)  
[Trigger model](#) (on page 3-1)  
[Scanning and triggering](#) (on page 3-1)

## scan.trigger.clear()

This function clears the trigger model.

Type	TSP-Link accessible	Affected by	Where saved	Default value
Function	Yes			

### Usage

```
scan.trigger.clear()
```

### Details

This function sets the arm and channel event detectors of the trigger model to the undetected state.

### Example

```
scan.trigger.clear()
```

Clears the trigger model.

### Also see

[scan.trigger.channel.set\(\)](#) (on page 7-152)  
[scan.trigger.channel.stimulus](#) (on page 7-153)  
[Scanning and triggering](#) (on page 3-1)  
[Trigger model](#) (on page 3-1)

## script.anonymous

This is a reference to the anonymous script.

Type	TSP-Link accessible	Affected by	Where saved	Default value
Attribute (R)	No	See <b>Details</b>	See <b>Details</b>	Not applicable

### Usage

```
scriptVar = script.anonymous
```

```
scriptVar
```

The name of the variable that references the script

### Details

You can use the `script.anonymous` script like any other script. Also, you can save the anonymous script as a user script by giving it a name.

This script is replaced by loading a script with the `loadscript` or `loadandrunscript` commands when they are used without a name.

### Example 1

```
script.anonymous.list()
```

Displays the content of the anonymous script.

**Example 2**

```
print (script.anonymous.source)
```

Retrieves the source of the anonymous script.

**Also see**

[scriptVar.autorun](#) (on page 7-160)  
[scriptVar.list\(\)](#) (on page 7-162)  
[scriptVar.name](#) (on page 7-162)  
[scriptVar.run\(\)](#) (on page 7-163)  
[scriptVar.save\(\)](#) (on page 7-164)  
[scriptVar.source](#) (on page 7-165)

**script.delete()**

This function deletes a script from nonvolatile memory.

Type	TSP-Link accessible	Affected by	Where saved	Default value
Function	No			

**Usage**

```
script.delete(scriptName)
```

```
scriptName
```

The string that represents the name of the script

**Example**

```
script.delete("test8")
```

Deletes a user script named "test8" from nonvolatile memory.

**Also see**

[Delete user scripts from the instrument](#) (on page 6-41)  
[scriptVar.save\(\)](#) (on page 7-164)

**script.new()**

This function creates a script.

Type	TSP-Link accessible	Affected by	Where saved	Default value
Function	No			

**Usage**

```

scriptVar = script.new(code)
scriptVar = script.new(code, name)

```

```
scriptVar
```

The name of the variable that will reference the script

```
code
```

A string containing the body of the script

```
name
```

The name of the script

---

## Details

---

The *name* parameter is the name that is added to the `script.user.scripts` table. If *name* is not given, an empty string will be used, and the script will be unnamed. If the name already exists in `script.user.scripts`, the existing script's `name` attribute is set to an empty string before it is replaced by the new script.

Note that *name* is the value that is used for the instrument front panel display. If this value is not defined, the script will not be available from the instrument front panel.

You must save the new script into nonvolatile memory to keep it when the instrument is turned off.

---

## Example 1

---

```
myTest8 = script.new(  
    "display.clear() display.settext('Hello from myTest8')", "myTest8")  
myTest8()
```

Creates a new script referenced by the variable `myTest8` with the name "myTest8".  
Runs the script. The instrument displays "Hello from myTest8".

---

## Example 2

---

```
autoexec = script.new(  
    "display.clear() display.settext('Hello from autoexec')", 'autoexec')
```

Creates a new `autoexec` script that clears the display when the instrument is turned on and displays "Hello from autoexec".

---

## Also see

---

[Create a script using the `script.new\(\)` command](#) (on page 6-35)

[Global variables and the `script.user.scripts` table](#) (on page 6-33)

[Named scripts](#) (on page 6-4)

[`scriptVar.save\(\)`](#) (on page 7-164)

[`script.newautorun\(\)`](#) (on page 7-158)

---



---

## script.newautorun()

This function is identical to the `script.new()` function, but it creates a script with the `autorun` attribute set to "yes".

Type	TSP-Link accessible	Affected by	Where saved	Default value
Function	No			

---

### Usage

```
scriptVar = script.newautorun(code)
scriptVar = script.newautorun(code, name)
```

<i>scriptVar</i>	The name of the variable that will reference the script
<i>code</i>	A string containing the body of the script
<i>name</i>	The name of the script

---

### Details

The `script.newautorun()` function is identical to the `script.new()` function, except that the `autorun` attribute of the script is set to `yes`. The script is also automatically run immediately after it is created.

---

### Example

```
NewAuto = script.newautorun("print('Hello from new auto run command')",
    'NewAuto')
print(NewAuto.autorun)
print(NewAuto.name)
```

Creates a new script called `NewAuto` that automatically has the `autorun` attribute set to `yes` after it is created. The `name` attribute's value is set to "NewAuto".

Output:

```
Hello from new auto run command
yes
NewAuto
```

---

### Also see

- [Create a script using the script.new\(\) command](#) (on page 6-35)
- [Global variables and the script.user.scripts table](#) (on page 6-33)
- [Named scripts](#) (on page 6-4)
- [script.new\(\)](#) (on page 7-156)
- [scriptVar.save\(\)](#) (on page 7-164)

---



---

## script.restore()

This function restores a script that was removed from the run-time environment.

Type	TSP-Link accessible	Affected by	Where saved	Default value
Function	No			

### Usage

```
script.restore(name)
```

<i>name</i>	The name of the script to be restored
-------------	---------------------------------------

### Details

This command copies the script from nonvolatile memory into the run-time environment. It also creates a global variable with the same name as the name of the script.

### Example

```
script.restore("test9")
```

Restores a script named "test9" from nonvolatile memory.
--

### Also see

[script.delete\(\)](#) (on page 7-156)

---



---

## script.run()

This function runs the anonymous script.

Type	TSP-Link accessible	Affected by	Where saved	Default value
Function	No			

### Usage

```
script.run()  
run()
```

### Details

Each time the `script.run()` command is given, the anonymous script is executed. This script can be run using this command many times without having to re-send it.

### Example

```
run()
```

Runs the anonymous script.
----------------------------

### Also see

[script.anonymous](#) (on page 7-155)

## script.user.catalog()

This function returns an iterator that can be used in a `for` loop to iterate over all the scripts stored in nonvolatile memory.

Type	TSP-Link accessible	Affected by	Where saved	Default value
Function	No			

### Usage

```
for name in script.user.catalog() do body end
```

<i>name</i>	String representing the name of the script
<i>body</i>	Code that implements the body of the <code>for</code> loop to process the names in the catalog

### Details

Accessing the catalog of scripts stored in nonvolatile memory allows you to process all scripts in nonvolatile memory. The entries will be enumerated in no particular order.

Each time the body of the function executes, *name* takes on the name of one of the scripts stored in nonvolatile memory. The `for` loop repeats until all scripts have been iterated.

### Example

<pre>for name in script.user.catalog() do   print(name) end</pre>	Retrieve the catalog listing for user scripts.
---	--

### Also see

None

## scriptVar.autorun

This attribute controls the autorun state of a script.

Type	TSP-Link accessible	Affected by	Where saved	Default value
Attribute (RW)	No	Not applicable	See <a href="#">Details</a>	See <a href="#">Details</a>

### Usage

```
scriptVar.autorun = state
state = scriptVar.autorun
```

<i>scriptVar</i>	The name of the variable that references the script
<i>state</i>	Whether or not the script runs automatically when powered on: <ul style="list-style-type: none"> <li>"yes" (script runs automatically)</li> <li>"no" (script does not run automatically)</li> </ul>

---

**Details**

---

Autorun scripts run automatically when the instrument is turned on. You can set any number of scripts to autorun.

The run order for autorun scripts is arbitrary, so make sure the run order is not important.

The default value for `scriptVar.autorun` depends on how the script was loaded. The default is "no" if the script was loaded with `loadscript` or `script.new()`. It is "yes" for scripts loaded with `loadandrunscript` or `script.newautorun()`.

**NOTE**

Make sure to save the script in nonvolatile memory after setting the `autorun` attribute so that the instrument will retain the setting.

---

**Example**

---

```
test5.autorun = "yes"  
test5.save()
```

Assume a script named "test5" is in the run-time environment.  
The next time the instrument is turned on, "test5" script automatically loads and runs.

---

**Also see**

---

None



---

## scriptVar.list()

This function generates a script listing.

Type	TSP-Link accessible	Affected by	Where saved	Default value
Function	No			

### Usage

```
scriptVar.list()
```

<i>scriptVar</i>	The name of variable that references the script
------------------	---

### Details

This function generates output in the form of a sequence of response messages (one message for each line of the script). It also generates output of the script control messages (`loadscript` or `loadandrunscript` and `endscript`).

### Example

```
test7 = script.new("display.clear() display.settext('Hello from my test')",
  "test7")
test7()
test7.save()
test7.list()
```

The above example code creates a script named "test7" that displays text on the front panel and lists the script with the following output:

```
loadscript test7
display.clear() display.settext("Hello from my test")
endscript
```

### Also see

[Retrieve source code one line at a time](#) (on page 6-39)

---

## scriptVar.name

This attribute contains the name of a script in the run-time environment.

Type	TSP-Link accessible	Affected by	Where saved	Default value
Attribute (RW)	No	Not applicable	Not applicable	Not applicable

### Usage

```
scriptVar.name = scriptName
scriptName = scriptVar.name
```

<i>scriptVar</i>	Name of the variable that references the script
<i>scriptName</i>	A string that represents the name of the script

**Details**

When setting the script name, this attribute renames the script that the variable *scriptVar* references.

This attribute must be either a valid Lua identifier or the empty string. Changing the name of a script changes the index that is used to access the script in the *script.user.scripts* table. Setting the attribute to an empty string removes the script from the table completely, and the script becomes an unnamed script.

As long as there are variables referencing an unnamed script, the script can be accessed through those variables. When all variables that reference an unnamed script are removed, the script will be removed from the run-time environment.

If the new name is the same as a name that is already used for another script, the name of the other script is set to an empty string, and that script becomes unnamed.

<b>NOTE</b>
Changing the name of a script does not change the name of any variables that reference that script. The variables will still reference the script, but the names of the script and variables may not match.

**Example**

```
test7 = script.new("display.clear() display.settext('Hello from my test')", "")
test7()
print(test7.name)

test7.name = "test7"
print(test7.name)

test7.save()
```

This example calls the *script.new()* function to create a script with no name, runs the script, names the script "test7", and then saves the script in nonvolatile memory.

**Also see**

- [Rename a script](#) (on page 6-37)
- [script.new\(\)](#) (on page 7-156)
- [scriptVar.save\(\)](#) (on page 7-164)

## scriptVar.run()

This function runs a script.

Type	TSP-Link accessible	Affected by	Where saved	Default value
Function	No			

**Usage**

```
scriptVar.run()
scriptVar()
```

<i>scriptVar</i>	The name of the variable that references the script
------------------	---

**Details**

The `scriptVar.run()` function runs the script referenced by `scriptVar`. You can also run the script by using `scriptVar()`.

**Example**

<code>test8.run()</code>	Runs the script referenced by the variable <code>test8</code> .
--------------------------	---

**Also see**

None

**scriptVar.save()**

This function saves the script to nonvolatile memory or to a USB flash drive.

Type	TSP-Link accessible	Affected by	Where saved	Default value
Function	No			

**Usage**

```
scriptVar.save()
scriptVar.save(filename)
```

<code>scriptVar</code>	The name of variable that references the script
<code>filename</code>	The file name to use when saving the script to a USB flash drive

**Details**

The `scriptVar.save()` function saves a script to nonvolatile memory or a USB flash drive. The root folder of the USB flash drive has the absolute path `/usb1/`.

If no `filename` is specified (the filename parameter is an empty string), the script is saved to internal nonvolatile memory. Only a script with `filename` defined can be saved to internal nonvolatile memory. If a `filename` is given, the script is saved to the USB flash drive.

If no `filename` is specified (the filename parameter is an empty string), the script is saved to internal nonvolatile memory. If a `filename` is given, the script is saved to the USB flash drive.

You can add the file extension, but it is not required. The only allowed extension is `.tsp` (see Example 2).

**Example 1**

<code>test8.save()</code>	Saves the script referenced by the variable <code>test8</code> to nonvolatile memory.
---------------------------	---

**Example 2**

<code>test8.save("/usb1/myScript.tsp")</code>	Saves the script referenced by the variable <code>test8</code> to a file named <code>myScript.tsp</code> on your USB flash drive.
---	---

**Also see**

[Save a user script](#) (on page 6-7)

---

## scriptVar.source

This attribute contains the source code of a script.

Type	TSP-Link accessible	Affected by	Where saved	Default value
Attribute (RW) (see <b>Details</b> )	No	Not applicable	Not saved	Not applicable

### Usage

```
code = scriptVar.source
scriptVar.source = nil
```

<i>scriptVar</i>	The name of the variable that references the script that contains the source code
<i>code</i>	The body of the script

### Details

The `loadscript` or `loadandrunscript` and `endscript` keywords are not included in the source code.

The body of the script is a single string with lines separated by the new line character.

The instrument automatically stores the source for all scripts that are loaded on the instrument. To free up memory or to obfuscate the code, assign `nil` to the source attribute of the script. Although this attribute is writable, it can only be set to the `nil` value.

### Example

```
test7 = script.new("display.clear() display.settext('Hello from my test')", "")
print(test7.source)
```

This example creates a script called "test7" that displays a message on the front panel and retrieves the source code.

Output:

```
display.clear() display.settext('Hello from my test')
```

### Also see

[scriptVar.list\(\)](#) (on page 7-162)

---

## settime()

This function sets the real-time clock (sets present time of the system).

Type	TSP-Link accessible	Affected by	Where saved	Default value
Function	Yes			

### Usage

```
settime(time)
```

<i>time</i>	The time in seconds since January 1, 1970 UTC
-------------	---

## Details

This function sets the date and time of the instrument based on the *time* parameter (specified in UTC time). UTC time is specified as the number of seconds since Jan 1, 1970, UTC. You can use UTC time from a local time specification, or you can use UTC time from another source (for example, your computer).

## Example

```
systemTime = os.time({year = 2010,
    month = 3,
    day = 31,
    hour = 14,
    min = 25})
settime(systemTime)
```

Sets the date and time to Mar 31, 2010 at 2:25 pm.

## Also see

[gettimezone\(\)](#) (on page 7-92)  
[settimezone\(\)](#) (on page 7-166)

## settimezone()

This function sets the local time zone.

Type	TSP-Link accessible	Affected by	Where saved	Default value
Function	No			

## Usage

```
settimezone(offset)
settimezone(offset, dstOffset, dstStart, dstEnd)
```

<i>offset</i>	String representing offset from UTC
<i>dstOffset</i>	String representing the daylight savings offset from UTC
<i>dstStart</i>	String representing when daylight savings time starts
<i>dstEnd</i>	String representing when daylight savings time ends

## Details

You only need to set the time zone if you use the `os.time()` and `os.date()` functions.

If only one parameter is given, the same time offset is used throughout the year. If four parameters are given, time is adjusted twice during the year for daylight savings time.

*offset* and *dstOffset* are strings of the form "[+|-]hh[:mm[:ss]]" that indicate how much time must be added to the local time to get UTC time:

- *hh* is a number between 0 and 23 that represents hours
- *mm* is a number between 0 and 59 that represents minutes
- *ss* is a number between 0 and 59 that represents seconds

The minute, second, +, and – fields are optional.

For example, to set the UTC-5 time zone, you specify the string "5", because UTC-5 is 5 hours behind UTC and you must add 5 hours to the local time to determine UTC time. To specify the time zone UTC4, you specify "-4", because UTC4 is 4 hours ahead of UTC and 4 hours must be subtracted from the local time to determine UTC.

*dstStart* and *dstEnd* are strings of the form "MM.w.dw/hh[:mm[:ss]]" that indicate when daylight savings time begins and ends respectively:

- *MM* is a number between 1 and 12 that represents the month
- *w* is a number between 1 and 5 that represents the week in the month
- *dw* is a number between 0 and 6 that represents the day of the week (where 0 is Sunday)

The rest of the fields represent the time of day that the change takes effect:

- *hh* represents hours
- *mm* represents minutes
- *ss* represents seconds

The minutes and seconds fields are optional.

The week of the month and day of the week fields are not specific dates.

### Example

```
settimezone("8", "1", "3.3.0/02", "11.2.0/02")
```

Sets *offset* to equal +8 hours, +1 hour for DST, starts on Mar 14 at 2:00 a.m, ends on Nov 7 at 2:00 a.m.

```
settimezone(offset)
```

Sets local time zone to *offset*.

### Also see

[gettimezone\(\)](#) (on page 7-92)

[settime\(\)](#) (on page 7-165)

---

## slot[X].idn

This attribute returns a string that contains information about the card in slot *x*.

Type	TSP-Link accessible	Affected by	Where saved	Default value
Attribute (R)	Yes	Not applicable	Not applicable	Not applicable

### Usage

```
idnString = slot[X].idn
```

<i>idnString</i>	The return string
<i>x</i>	Slot number (1 to 6)

### Details

The information that is returned depends on whether the card in the slot is an actual card or pseudocard.

For actual cards, this returns a comma-separated string that contains the model number, description, firmware revision, and serial number of the card installed in slot *x*.

For pseudocards, the response is `Pseudo`, followed by the model number, description, firmware revision, and `???` for the serial number.

### Example

```
print(slot[1].idn)
```

If a Model 7173 card is installed in slot 1, the response is:  
7173,4x12 Hi Freq Matrix AAAA,02.01a,99999999

### Also see

[Slot](#) (on page 5-13)

## slot[X].poles.four

This attribute indicates if a four-pole setting is supported for the channels on the card.

Type	TSP-Link accessible	Affected by	Where saved	Default value
Attribute (R)	Yes	Not applicable	Not applicable	Not applicable

### Usage

```
fourPole = slot[X].poles.four
```

<i>fourPole</i>	The return value
<i>X</i>	Slot number (1 to 6)

### Details

This attribute only exists if a card is installed and if the card supports four-pole settings for the channels on the card. If not, the value is nil. If supported, the value is 1.

### Example

```
fourPole3 = slot[3].poles.four
print(fourPole3)
```

Queries if Slot 3 supports four-pole settings for the channels on the card.

Output if card supports four pole:

```
1.000000000000e+00
```

Output if card does not support four pole:

```
nil
```

### Also see

[slot\[X\].poles.one](#) (on page 7-170)

[slot\[X\].poles.two](#) (on page 7-171)



## slot[X].poles.one

This attribute indicates if a one-pole setting is supported for the channels on the card.

Type	TSP-Link accessible	Affected by	Where saved	Default value
Attribute (R)	Yes	Not applicable	Not applicable	Not applicable

### Usage

```
onePole = slot[X].poles.one
```

<i>onePole</i>	The return value
<i>X</i>	Slot number (1 to 6)

### Details

This attribute only exists if a card is installed and if the card supports one-pole settings for the channels on the card. If not, the value is `nil`. If supported, the value is 1.

### Example

```
print(slot[3].poles.one)
```

Query to see if Slot 3 supports one-pole settings for the channels on the card.

Output if card supports one pole:

```
1.000000000000e+00
```

Output if card does not support one pole:

```
nil
```

### Also see

[slot\[X\].poles.four](#) (on page 7-169)

[slot\[X\].poles.two](#) (on page 7-171)

## slot[X].poles.two

This attribute indicates if a two-pole setting is supported for the channels on the card.

Type	TSP-Link accessible	Affected by	Where saved	Default value
Attribute (R)	Yes	Not applicable	Not applicable	Not applicable

### Usage

```
twoPole = slot[X].poles.two
```

<i>twoPole</i>	The return value
<i>X</i>	Slot number (1 to 6)

### Details

This attribute only exists is a card is installed and if the card supports a two-pole setting for the channels on the card.

If not, the value is `nil`. If supported, the value is `1`.

### Example

```
twoPole3 = slot[3].poles.two
print(twoPole3)
```

Query to see if Slot 3 supports two-pole settings for the channels on the card.

Output if card supports two pole:

```
1.000000000000e+00
```

Output if card does not support two pole:

```
nil
```

### Also see

[slot\[X\].poles.one](#) (on page 7-170)

[slot\[X\].poles.four](#) (on page 7-169)

## slot[X].pseudocard

This attribute specifies the corresponding pseudocard to implement for the designated slot.

Type	TSP-Link accessible	Affected by	Where saved	Default value
Attribute (RW)	Yes	Not applicable	Not applicable	See <b>Details</b>

### Usage

```
pseudoCard = slot[X].pseudocard
slot[X].pseudocard = pseudoCard
```

<i>pseudoCard</i>	The pseudocards available for Models 707B and 708B are: <ul style="list-style-type: none"> <li><code>slot.PSEUDO_NONE</code> or <code>0</code> for no pseudocard selection</li> <li>7072 for the Model 7072 8x12 Semiconductor Matrix Card</li> <li>70721 for the Model 7072-HV 8x12 High-Voltage Semiconductor Matrix Card</li> <li>7173 for the Model 7173-50 8x12 High-Frequency 2-Pole 4x12 Matrix Card</li> <li>7174 for the Model 7174A 8x12 Low-Current, High-Speed Matrix Card</li> </ul>
<i>X</i>	Slot number (1 to 6)

## Details

This attribute only exists for a slot if that slot has no card installed in it. If a card is installed, the response is `nil` when queried. If no card installed and the slot is empty, the response is 0.

After assigning a pseudocard, the valid commands and attributes based on that pseudocard exist for that slot. For example, the `slot[X].idn` attribute is valid.

Changing the pseudocard card assignment from a card to `slot.PSEUDO_NONE` invalidates existing scan lists that include that slot.

### Example 1

```
myPseudoCard = slot[3].pseudocard
if myPseudoCard == 7072 then
  print("Pseudo-7072 in Slot #3")
end
```

If slot 3 is configured to have a 7072 pseudocard, the following message is output:  
Pseudo-7072 in Slot #3

### Example 2

```
slot[1].pseudocard = 0
print(slot[1].idn)
slot[1].pseudocard = 7072
print(slot[1].idn)
```

This example requires an empty slot.

The slot is set to empty and then set to a valid value.

Output:

Empty Slot

7072,Pseudo 8x12 SemiMatrix,00.00a,????????

```
slot[1].pseudocard = 0
print(slot[1].idn)
slot[1].pseudocard = 7070
print(slot[1].idn)
```

To change the pseudocard, set the slot to empty again, then define the new card.

Output:

Empty Slot

7070,Universal Adapter Card,00.00a,????????

### Also see

[Slot](#) (on page 5-13)

[slot\[X\].idn](#) (on page 7-168)

## status.condition

This attribute stores the status byte condition register.

Type	TSP-Link accessible	Affected by	Where saved	Default value
Attribute (R)	Yes	Not applicable	Not saved	Not applicable

### Usage

```
statusByte = status.condition
```

*statusByte*

The status byte; a zero (0) indicates no bits set; other values indicate various bit settings

### Details

This attribute is used to read the status byte, which is returned as a numeric value. The binary equivalent of the value of this attribute indicates which register bits are set. In the binary equivalent, the least significant bit is bit B0, and the most significant bit is bit B7. For example, if a value of `1.29000e+02` (which is 129) is read as the value of this register, the binary equivalent is 1000 0001. This value indicates that bit B0 and bit B7 are set.

B7	B6	B5	B4	B3	B2	B1	B0
**	>	>	>	>	>	>	*
1	0	0	0	0	0	0	1

\* Least significant bit

\*\* Most significant bit

The returned value can indicate one or more status events occurred. When an enabled status event occurs, a summary bit is set in this register to indicate the event occurrence.

The individual bits of this register have the following meanings:

Bit	Value	Description
B0	<code>status.MEASUREMENT_SUMMARY_BIT</code> <code>status.MSB</code>	Set summary bit indicates that an enabled measurement event has occurred. Bit B0 decimal value: 1
B1	<code>status.SYSTEM_SUMMARY_BIT</code> <code>status.SSB</code>	Set summary bit indicates that an enabled system event has occurred. Bit B1 decimal value: 2
B2	<code>status.ERROR_AVAILABLE</code> <code>status.EAV</code>	Set summary bit indicates that an error or status message is present in the Error Queue. Bit B2 decimal value: 4
B3	<code>status.QUESTIONABLE_SUMMARY_BIT</code> <code>status.QSB</code>	Set summary bit indicates that an enabled questionable event has occurred. Bit B3 decimal value: 8
B4	<code>status.MESSAGE_AVAILABLE</code> <code>status.MAV</code>	Set summary bit indicates that a response message is present in the Output Queue. Bit B4 decimal value: 16
B5	<code>status.EVENT_SUMMARY_BIT</code> <code>status.ESB</code>	Set summary bit indicates that an enabled standard event has occurred. Bit B5 decimal value: 32
B6	<code>status.RQS</code> <code>status.MASTER_SUMMARY_STATUS</code> <code>status.MSS</code>	Request Service (RQS)/Master Summary Status (MSS). Depending on how it is used, bit B6 of the status byte register is either the Request for Service (RQS) bit or the Master Summary Status (MSS) bit: <ul style="list-style-type: none"> <li>When using the GPIB, USB, or VXI-11 serial poll sequence of the Models 707B and 708B to obtain the status byte (serial poll byte), B6 is the RQS bit. The set bit indicates that the Request Service (RQS) bit of the status byte (serial poll byte) is set and a serial poll (SRQ) has occurred.</li> <li>When using the <code>status.condition</code> register command or the <code>*STB?</code> common command to read the status byte, B6 is the MSS bit. Set bit indicates that an enabled summary bit of the status byte register is set.</li> </ul> Bit B6 decimal value: 64
B7	<code>status.OPERATION_SUMMARY_BIT</code> <code>status.OSB</code>	Set summary bit indicates that an enabled operation event has occurred. Bit B7 decimal value: 128

In addition to the above constants, when more than one bit of the register is set, *statusByte* equals the sum of their decimal weights. For example, if 129 is returned, bits B0 and B7 are set (1 + 128).

Bit	B7	B6	B5	B4	B3	B2	B1	B0
Binary value	0/1	0/1	0/1	0/1	0/1	0/1	0/1	0/1
Decimal	128	64	32	16	8	4	2	1
Weights	(2 <sup>7</sup> )	(2 <sup>6</sup> )	(2 <sup>5</sup> )	(2 <sup>4</sup> )	(2 <sup>3</sup> )	(2 <sup>2</sup> )	(2 <sup>1</sup> )	(2 <sup>0</sup> )

### Example

```
statusByte = status.condition
print(statusByte)
```

Returns statusByte.

Sample output:

```
1.29000e+02
```

Converting this output (129) to its binary equivalent yields 1000 0001

Therefore, this output indicates that the set bits of the status byte condition register are presently B0 (MSS) and B7 (OSB).

### Also see

[Status byte and service request \(SRQ\)](#) (on page C-16)

## status.node\_enable

This attribute stores the system node enable register.

Type	TSP-Link accessible	Affected by	Where saved	Default value
Attribute (RW)	Yes	Status reset	Not saved	0

### Usage

```
nodeEnableRegister = status.node_enable
status.node_enable = nodeEnableRegister
```

<i>nodeEnableRegister</i>	The status of the system node enable register; a zero (0) indicates no bits set (also send 0 to clear all bits); other values indicate various bit settings
---------------------------	---

### Details

This attribute is used to read or write to the system node enable register. Reading the system node enable register returns a value. The binary equivalent of the value indicates which register bits are set. In the binary equivalent, the least significant bit is bit B0, and the most significant bit is bit B7. For example, assume the value of 1.29000e+02 (which is 129) is returned for the system node enable register, the binary equivalent is 1000 0001. This value indicates that bit B0 and bit B7 are set.

B7	B6	B5	B4	B3	B2	B1	B0
**	>	>	>	>	>	>	*
1	0	0	0	0	0	0	1

\* Least significant bit

\*\* Most significant bit

Assigning a value to this attribute enables one or more status events. When an enabled status event occurs, a summary bit is set in the appropriate system summary register. The register and bit that is set depends on the TSP-Link node number assigned to this instrument.

For information about `.condition`, `.enable`, `.event`, `.ntr`, and `.ptr` registers, refer to [Status register set contents](#) (on page C-1) and [Enable and transition registers](#) (on page C-20). The individual bits of this register are defined in the following table.

Bit	Value	Description
B0	<code>status.MEASUREMENT_SUMMARY_BIT</code> <code>status.MSB</code>	Set summary bit indicates that an enabled measurement event has occurred. Bit B0 decimal value: 1
B1	Not used	Not applicable.
B2	<code>status.ERROR_AVAILABLE</code> <code>status.EAV</code>	Set summary bit indicates that an error or status message is present in the Error Queue. Bit B2 decimal value: 4
B3	<code>status.QUESTIONABLE_SUMMARY_BIT</code> <code>status.QSB</code>	Set summary bit indicates that an enabled questionable event has occurred. Bit B3 decimal value: 8
B4	<code>status.MESSAGE_AVAILABLE</code> <code>status.MAV</code>	Set summary bit indicates that a response message is present in the Output Queue. Bit B4 decimal value: 16
B5	<code>status.EVENT_SUMMARY_BIT</code> <code>status.ESB</code>	Set summary bit indicates that an enabled standard event has occurred. Bit B5 decimal value: 32
B6	<code>status.MASTER_SUMMARY_STATUS</code> <code>status.MSS</code>	Set bit indicates that an enabled Master Summary Status (MSS) bit of the Status Byte Register is set. Bit B6 decimal value: 64
B7	<code>status.OPERATION_SUMMARY_BIT</code> <code>status.OSB</code>	Set summary bit indicates that an enabled operation event has occurred. Bit B7 decimal value: 128

As an example, to set the B0 bit of the system node enable register, set `status.node_enable = status.MSB`.

In addition to the above values, `nodeEnableRegister` can be set to the numeric equivalent of the bit to set. To set more than one bit of the register, set `nodeEnableRegister` to the sum of their decimal weights. For example, to set bits B0 and B7, set `nodeEnableRegister` to 129 (1 + 128).

Bit	B7	B6	B5	B4	B3	B2	B1	B0
Binary value	0/1	0/1	0/1	0/1	0/1	0/1	0/1	0/1
Decimal	128	64	32	16	8	4	2	1
Weights	(2 <sup>7</sup> )	(2 <sup>6</sup> )	(2 <sup>5</sup> )	(2 <sup>4</sup> )	(2 <sup>3</sup> )	(2 <sup>2</sup> )	(2 <sup>1</sup> )	(2 <sup>0</sup> )

### Example 1

```
nodeEnableRegister = status.MSB + status.OSB
status.node_enable = nodeEnableRegister
```

Sets the MSB and OSB bits of the system node enable register using constants.

### Example 2

```
-- decimal 129 = binary 10000001
nodeEnableRegister = 129
status.node_enable = nodeEnableRegister
```

Sets the MSB and OSB bits of the system node enable register using a decimal value.

### Also see

[status.condition](#) (on page 7-172)  
[status.system.\\*](#) (on page 7-190)  
[Status byte and service request \(SRQ\)](#) (on page C-16)

## status.node\_event

This attribute stores the status node event register.

Type	TSP-Link accessible	Affected by	Where saved	Default value
Attribute (R)	Yes	Not applicable	Not saved	0

### Usage

```
nodeEventRegister = status.node_event
```

<i>nodeEventRegister</i>	The status of the node event register; a zero (0) indicates no bits set; other values indicate various bit settings
--------------------------	---

### Details

This attribute is used to read the status node event register, which is returned as a numeric value (reading this register returns a value). The binary equivalent of the value of this attribute indicates which register bits are set. In the binary equivalent, the least significant bit is bit B0, and the most significant bit is bit B7. For example, if a value of  $1.29000e+02$  (which is 129) is read as the value of this register, the binary equivalent is 1000 0001. This value indicates that bit B0 and bit B7 are set.

B7	B6	B5	B4	B3	B2	B1	B0
**	>	>	>	>	>	>	*
1	0	0	0	0	0	0	1

\* Least significant bit

\*\* Most significant bit

The returned value can indicate one or more status events occurred.

Bit	Value	Description
B0	status.MEASUREMENT_SUMMARY_BIT status.MSB	Set summary bit indicates that an enabled measurement event has occurred. Bit B0 decimal value: 1
B1	Not used	Not applicable
B2	status.ERROR_AVAILABLE status.EAV	Set summary bit indicates that an error or status message is present in the Error Queue. Bit B2 decimal value: 4
B3	status.QUESTIONABLE_SUMMARY_BIT status.QSB	Set summary bit indicates that an enabled questionable event has occurred. Bit B3 decimal value: 8
B4	status.MESSAGE_AVAILABLE status.MAV	Set summary bit indicates that a response message is present in the Output Queue. Bit B4 decimal value: 16
B5	status.EVENT_SUMMARY_BIT status.ESB	Set summary bit indicates that an enabled standard event has occurred. Bit B5 decimal value: 32
B6	status.MASTER_SUMMARY_STATUS status.MSS	Set bit indicates that an enabled Master Summary Status (MSS) bit of the Status Byte register is set. Bit B6 decimal value: 64
B7	status.OPERATION_SUMMARY_BIT status.OSB	Set summary bit indicates that an enabled operation event has occurred. Bit B7 decimal value: 128

In addition to the above constants, *nodeEventRegister* can be set to the decimal equivalent of the bits set. When more than one bit of the register is set, *nodeEventRegister* contains the sum of their decimal weights. For example, if 129 is returned, bits B0 and B7 are set (1 + 128).

Bit	B7	B6	B5	B4	B3	B2	B1	B0
Binary value	0/1	0/1	0/1	0/1	0/1	0/1	0/1	0/1
Decimal	128	64	32	16	8	4	2	1
Weights	(2 <sup>7</sup> )	(2 <sup>6</sup> )	(2 <sup>5</sup> )	(2 <sup>4</sup> )	(2 <sup>3</sup> )	(2 <sup>2</sup> )	(2 <sup>1</sup> )	(2 <sup>0</sup> )

**Example**

<pre>nodeEventRegister = status.node_event print(nodeEventRegister)</pre>	<p>Reads the status node event register.                  Sample output:                  1.29000e+02                  Converting this output (129) to its binary equivalent yields 1000 0001                  Therefore, this output indicates that the set bits of the status byte condition register are presently B0 (MSB) and B7 (OSB).</p>
---	--

**Also see**

- [Status byte and service request \(SRQ\)](#) (on page C-16)
- [status.condition](#) (on page 7-172)
- [status.system.\\*](#) (on page 7-190)

---

## status.operation.\*

These attributes manage the operation status register set of the status model.

Type	TSP-Link accessible	Affected by	Where saved	Default value
Attribute	--	--	--	--
.condition (R)	Yes	Not applicable	Not saved	Not applicable
.enable (RW)	Yes	Status reset	Not saved	0
.event (R)	Yes	Status reset	Not saved	0
.ntr (RW)	Yes	Status reset	Not saved	0
.ptr (RW)	Yes	Status reset	Not saved	22,528 (All bits set)

**Usage**

```
operationRegister = status.operation.condition
operationRegister = status.operation.enable
operationRegister = status.operation.event
operationRegister = status.operation.ntr
operationRegister = status.operation.ptr
status.operation.enable = operationRegister
status.operation.ntr = operationRegister
status.operation.ptr = operationRegister
```

<i>operationRegister</i>	The status of the operation status register; a zero (0) indicates no bits set (also send 0 to clear all bits); other values indicate various bit settings
--------------------------	---



**Details**

These attributes read or write the operation status registers.

Reading a status register returns a value. The binary equivalent of the returned value indicates which register bits are set. The least significant bit of the binary number is bit B0, and the most significant bit is bit B15. For example, if a value of 2.04800e+04 (which is 20,480) is read as the value of the condition register, the binary equivalent is 0101 0000 0000 0000. This value indicates that bit B14 (PROGRAM\_RUNNING) and bit B12 (USER) are set.

B15	B14	B13	B12	B11	B10	B9	B8	B7	B6	B5	B4	B3	B2	B1	B0
**	>	>	>	>	>	>	>	>	>	>	>	>	>	>	*
0	1	0	1	0	0	0	0	0	0	0	0	0	0	0	0

\* Least significant bit

\*\* Most significant bit

For information about .condition, .enable, .event, .ntr, and .ptr registers, refer to [Status register set contents](#) (on page C-1) and [Enable and transition registers](#) (on page C-20). The individual bits of this register are defined in the following table.

Bit	Value	Description
B0-B10	Not used	Not applicable
B11	status.operation.PROMPTS status.operation.PRMPPTS	Set bit indicates that command prompts are enabled. Bit B11 decimal value: 2,048
B12	status.USER	Set bit indicates that an enabled bit in the status.operation.user register is set. Bit B12 decimal value: 4,096
B13	Not used.	Not applicable.
B14	status.operation.PROGRAM_RUNNING status.operation.PROG	Set bit indicates that a program is running. Bit B14 decimal value: 16,384
B15	Not used	Not applicable

As an example, to set bit B12 of the operation status enable register, set `status.operation.enable = status.operation.USER`.

In addition to the above constants, `operationRegister` can be set to the numeric equivalent of the bit to set. To set more than one bit of the register, set `operationRegister` to the sum of their decimal weights. For example, to set bits B12 and B14, set `operationRegister` to 20,480 (which is the sum of 4,096 + 16,384).

Bit	B7	B6	B5	B4	B3	B2	B1	B0
Binary value	0/1	0/1	0/1	0/1	0/1	0/1	0/1	0/1
Decimal	128	64	32	16	8	4	2	1
Weights	(2 <sup>7</sup> )	(2 <sup>6</sup> )	(2 <sup>5</sup> )	(2 <sup>4</sup> )	(2 <sup>3</sup> )	(2 <sup>2</sup> )	(2 <sup>1</sup> )	(2 <sup>0</sup> )

Bit	B15	B14	B13	B12	B11	B10	B9	B8
Binary value	0/1	0/1	0/1	0/1	0/1	0/1	0/1	0/1
Decimal	32,768	16,384	8,192	4,096	2,048	1,024	512	256
Weights	(2 <sup>15</sup> )	(2 <sup>14</sup> )	(2 <sup>13</sup> )	(2 <sup>12</sup> )	(2 <sup>11</sup> )	(2 <sup>10</sup> )	(2 <sup>9</sup> )	(2 <sup>8</sup> )

**Example 1**

```
operationRegister = status.operation.USER +
    status.operation.PROG
status.operation.enable = operationRegister
```

Sets the USER and PROG bits of the operation status enable register using constants.

**Example 2**

```
-- decimal 20480 = binary 0101 0000 0000 0000
operationRegister = 20480
status.operation.enable = operationRegister
```

Sets the USER and PROG bits of the operation status enable register using a decimal value.

**Also see**

None

**status.operation.user.\***

These attributes manage the operation status user register set of the status model.

Type	TSP-Link accessible	Affected by	Where saved	Default value
Attribute	--	--	--	--
.condition (RW)	Yes	Status reset	Not saved	0
.enable (RW)	Yes	Status reset	Not saved	0
.event (R)	Yes	Status reset	Not saved	0
.ntr (RW)	Yes	Status reset	Not saved	0
.ptr (RW)	Yes	Status reset	Not saved	32,767 (All bits set)

**Usage**

```
operationRegister = status.operation.user.condition
operationRegister = status.operation.user.enable
operationRegister = status.operation.user.event
operationRegister = status.operation.user.ntr
operationRegister = status.operation.user.ptr
status.operation.user.condition = operationRegister
status.operation.user.enable = operationRegister
status.operation.user.ntr = operationRegister
status.operation.user.ptr = operationRegister
```

```
operationRegister
```

The status of the operation status user register; a zero (0) indicates no bits set (also send 0 to clear all bits); other values indicate various bit settings

**Details**

These attributes are used to read or write to the operation status user registers. Reading a status register returns a value. The binary equivalent of the value indicates which register bits are set. In the binary equivalent, the least significant bit is bit B0, and the most significant bit is bit B15. For example, if a value of 1.29000e+02 (which is 129) is read as the value of the condition register, the binary equivalent is 0000 0000 1000 0001. This value indicates that bits B0 and B7 are set.

B15	B14	B13	B12	B11	B10	B9	B8	B7	B6	B5	B4	B3	B2	B1	B0
**	>	>	>	>	>	>	>	>	>	>	>	>	>	>	*
0	0	0	0	0	0	0	0	1	0	0	0	0	0	0	1

\* Least significant bit  
 \*\* Most significant bit

For information about .condition, .enable, .event, .ntr, and .ptr registers, refer to [Status register set contents](#) (on page C-1) and [Enable and transition registers](#) (on page C-20). The individual bits of this register are defined in the following table.

Bit	Value	Description
B0	status.operation.user.BIT0	Bit B0 decimal value: 1
B1	status.operation.user.BIT1	Bit B1 decimal value: 2
B2	status.operation.user.BIT2	Bit B2 decimal value: 4
B3	status.operation.user.BIT3	Bit B3 decimal value: 8
B4	status.operation.user.BIT4	Bit B4 decimal value: 16
B5	status.operation.user.BIT5	Bit B5 decimal value: 32
B6	status.operation.user.BIT6	Bit B6 decimal value: 64
B7	status.operation.user.BIT7	Bit B7 decimal value: 128
B8	status.operation.user.BIT8	Bit B8 decimal value: 256
B9	status.operation.user.BIT9	Bit B9 decimal value: 512
B10	status.operation.user.BIT10	Bit B10 decimal value: 1,024
B11	status.operation.user.BIT11	Bit B11 decimal value: 2,048
B12	status.operation.user.BIT12	Bit B12 decimal value: 4,096
B13	status.operation.user.BIT13	Bit B13 decimal value: 8,192
B14	status.operation.user.BIT14	Bit B14 decimal value: 16,384
B15	Not used	Not applicable

As an example, to set bit B0 of the operation status user enable register, set `status.operation.user.enable = status.operation.user.BIT0`.

In addition to the above constants, `operationRegister` can be set to the numeric equivalent of the bit to set. To set more than one bit of the register, set `operationRegister` to the sum of their decimal weights. For example, to set bits B11 and B14, set `operationRegister` to 18,432 (which is the sum of 2,048 + 16,384).

Bit	B7	B6	B5	B4	B3	B2	B1	B0
Binary value	0/1	0/1	0/1	0/1	0/1	0/1	0/1	0/1
Decimal	128	64	32	16	8	4	2	1
Weights	(2 <sup>7</sup> )	(2 <sup>6</sup> )	(2 <sup>5</sup> )	(2 <sup>4</sup> )	(2 <sup>3</sup> )	(2 <sup>2</sup> )	(2 <sup>1</sup> )	(2 <sup>0</sup> )

Bit	B15	B14	B13	B12	B11	B10	B9	B8
Binary value	0/1	0/1	0/1	0/1	0/1	0/1	0/1	0/1
Decimal	32,768	16,384	8,192	4,096	2,048	1,024	512	256
Weights	(2 <sup>15</sup> )	(2 <sup>14</sup> )	(2 <sup>13</sup> )	(2 <sup>12</sup> )	(2 <sup>11</sup> )	(2 <sup>10</sup> )	(2 <sup>9</sup> )	(2 <sup>8</sup> )

**Example 1**

```
operationRegister = status.operation.user.BIT11 +
status.operation.user.BIT14
status.operation.user.enable = operationRegister
```

Uses constants to set bits B11 and B14 of the operation status user enable register.

**Example 2**

```
-- 18432 = binary 0100 1000 0000 0000
operationRegister = 18432
status.operation.enable = operationRegister
```

Uses a decimal value to set bits B11 and B14 of the operation status user enable register.

**Also see**

[status.operation.\\*](#) (on page 7-177)

**status.questionable.\***

These attributes manage the status model's questionable status register set.

Type	TSP-Link accessible	Affected by	Where saved	Default value
Attribute	--	--	--	--
.condition (R)	Yes	Not applicable	Not saved	Not applicable
.enable (RW)	Yes	Status reset	Not saved	0
.event (R)	Yes	Status reset	Not saved	0
.ntr (RW)	Yes	Status reset	Not saved	0
.ptr (RW)	Yes	Status reset	Not saved	32,256 (All bits set)

**Usage**

```
questionableRegister = status.questionable.condition
questionableRegister = status.questionable.enable
questionableRegister = status.questionable.event
questionableRegister = status.questionable.ntr
questionableRegister = status.questionable.ptr
status.questionable.enable = questionableRegister
status.questionable.ntr = questionableRegister
status.questionable.ptr = questionableRegister
```

*questionableRegister* The status of the questionable status register; a zero (0) indicates no bits set (also send 0 to clear all bits); other values indicate various bit settings

## Details

These attributes are used to read or write to the questionable status registers. Reading a status register returns a value. In the binary equivalent, the least significant bit is bit B0, and the most significant bit is bit B15. For example, if a value of 1.22880e+04 (which is 12,288) is read as the value of the condition register, the binary equivalent is 0011 0000 0000 0000. This value indicates that bits B12 and B13 are set.

B15	B14	B13	B12	B11	B10	B9	B8	B7	B6	B5	B4	B3	B2	B1	B0
**	>	>	>	>	>	>	>	>	>	>	>	>	>	>	*
0	0	1	1	0	0	0	0	0	0	0	0	0	0	0	0

\* Least significant bit

\*\* Most significant bit

For information about .condition, .enable, .event, .ntr, and .ptr registers, refer to [Status register set contents](#) (on page C-1) and [Enable and transition registers](#) (on page C-20). The individual bits of this register are defined in the following table.

Bit	Value	Description
B0-B8	Not used	Not available
B9	<code>status.questionable.S1THR</code> <code>status.questionable.SLOT1_THERMAL</code>	Bit B9 decimal value: 512
B10	<code>status.questionable.S2THR</code> <code>status.questionable.SLOT2_THERMAL</code>	Bit B10 decimal value: 1,024
B11	<code>status.questionable.S3THR</code> <code>status.questionable.SLOT3_THERMAL</code>	Bit B11 decimal value: 2,048
B12	<code>status.questionable.S4THR</code> <code>status.questionable.SLOT4_THERMAL</code>	Bit B12 decimal value: 4,096
B13	<code>status.questionable.S5THR</code> <code>status.questionable.SLOT5_THERMAL</code>	Bit B13 decimal value: 8,192
B14	<code>status.questionable.S6THR</code> <code>status.questionable.SLOT6_THERMAL</code>	Bit B14 decimal value: 16,384
B15	Not used	Not available

As an example, to set bit B9 of the questionable status enable register, set `status.questionable.enable = status.questionable.SLOT1_THERMAL`.

In addition to the above constants, `questionableRegister` can be set to the numeric equivalent of the bit to set. To set more than one bit of the register, set `questionableRegister` to the sum of their decimal weights. For example, to set bits B12 and B13, set `questionableRegister` to 12,288 (which is the sum of 4,096 + 8,192).

Bit	B7	B6	B5	B4	B3	B2	B1	B0
Binary value	0/1	0/1	0/1	0/1	0/1	0/1	0/1	0/1
Decimal	128	64	32	16	8	4	2	1
Weights	(2 <sup>7</sup> )	(2 <sup>6</sup> )	(2 <sup>5</sup> )	(2 <sup>4</sup> )	(2 <sup>3</sup> )	(2 <sup>2</sup> )	(2 <sup>1</sup> )	(2 <sup>0</sup> )
Bit	B15	B14	B13	B12	B11	B10	B9	B8
Binary value	0/1	0/1	0/1	0/1	0/1	0/1	0/1	0/1
Decimal	32,768	16,384	8,192	4,096	2,048	1,024	512	256
Weights	(2 <sup>15</sup> )	(2 <sup>14</sup> )	(2 <sup>13</sup> )	(2 <sup>12</sup> )	(2 <sup>11</sup> )	(2 <sup>10</sup> )	(2 <sup>9</sup> )	(2 <sup>8</sup> )

**Example 1**

```
questionableRegister = status.questionable.S1THR
+
  status.questionable.S3THR
status.questionable.enable = questionableRegister
```

Uses constants to set bits B9 and B11 of the status questionable enable register.

**Example 2**

```
-- decimal 2560 = binary 00001010 0000 0000
questionableRegister = 2560
status.questionable.enable = questionableRegister
```

Uses a decimal value to set bits B9 and B11 of the status questionable enable register.

**Also see**

None

**status.request\_enable**

This attribute stores the service request (SRQ) enable register.

Type	TSP-Link accessible	Affected by	Where saved	Default value
Attribute (RW)	Yes	Status reset	Not saved	0

**Usage**

```
requestSRQEnableRegister = status.request_enable
status.request_enable = requestSRQEnableRegister
```

<i>requestSRQEnableRegister</i>	The status of the service request (SRQ) enable register; a zero (0) indicates no bits set (also send 0 to clear all bits); other values indicate various bit settings
---------------------------------	---

**Details**

This attribute is used to read or write to the service request enable register. Reading the service request enable register returns a value. The binary equivalent of the value of this attribute indicates which register bits are set. In the binary equivalent, the least significant bit is bit B0, and the most significant bit is bit B7. For example, if a value of 1.29000e+02 (which is 129) is read as the value of this register, the binary equivalent is 1000 0001. This value indicates that bit B0 and bit B7 are set.

B7	B6	B5	B4	B3	B2	B1	B0
**	>	>	>	>	>	>	*
1	0	0	0	0	0	0	1

\* Least significant bit

\*\* Most significant bit

For information about .condition, .enable, .event, .ntr, and .ptr registers, refer to [Status register set contents](#) (on page C-1) and [Enable and transition registers](#) (on page C-20). The individual bits of this register are defined in the following table.

Bit	Value	Description
B0	status.MEASUREMENT_SUMMARY_BIT status.MSB	Set summary bit indicates that an enabled event in the Measurement Event Register has occurred. Bit B0 decimal value: 1
B1	status.SYSTEM_SUMMARY_BIT status.SSB	This bit is only available on Models 2601A/2602A/2611A/2612A/2635A/2636A. Set summary bit indicates that an enabled event in the System Summary Register has occurred. Bit B1 decimal value: 2
B2	status.ERROR_AVAILABLE status.EAV	Set summary bit indicates that an error or status message is present in the Error Queue. Bit B2 decimal value: 4
B3	status.QUESTIONABLE_SUMMARY_BIT status.QSB	Set summary bit indicates that an enabled event in the Questionable Status Register has occurred. Bit B3 decimal value: 8
B4	status.MESSAGE_AVAILABLE status.MAV	Set summary bit indicates that a response message is present in the Output Queue. Bit B4 decimal value: 16
B5	status.EVENT_SUMMARY_BIT status.ESB	Set summary bit indicates that an enabled event in the Standard Event Status Register has occurred. Bit B5 decimal value: 32
B6	Not used	Not applicable
B7	status.OPERATION_SUMMARY_BIT status.OSB	Set summary bit indicates that an enabled event in the Operation Status Register has occurred. Bit B7 decimal value: 128

As an example, to set bit B0 of the service request enable register, set `status.request_enable = status.MSB`.

In addition to the above values, `requestSRQEnableRegister` can be set to the numeric equivalent of the bit to set. To set more than one bit of the register, set `requestSRQEnableRegister` to the sum of their decimal weights. For example, to set bits B0 and B7, set `requestSRQEnableRegister` to 129 (1 + 128).

Bit	B7	B6	B5	B4	B3	B2	B1	B0
Binary value	0/1	0/1	0/1	0/1	0/1	0/1	0/1	0/1
Decimal	128	64	32	16	8	4	2	1
Weights	(2 <sup>7</sup> )	(2 <sup>6</sup> )	(2 <sup>5</sup> )	(2 <sup>4</sup> )	(2 <sup>3</sup> )	(2 <sup>2</sup> )	(2 <sup>1</sup> )	(2 <sup>0</sup> )

### Example 1

<pre>requestSRQEnableRegister = status.MSB +     status.OSB status.request_enable = requestSRQEnableRegister</pre>	Uses constants to set the MSB and OSB bits of the service request (SRQ) enable register.
--	--

**Example 2**

```
-- decimal 129 = binary 10000001
requestSRQEnableRegister = 129
status.request_enable = requestSRQEnableRegister
```

Uses a decimal value to set the MSB and OSB bits of the service request (SRQ) enable register.

**Also see**

[Status byte and service request \(SRQ\)](#) (on page C-16)  
[status.condition](#) (on page 7-172)  
[status.system.\\*](#) (on page 7-190)

**status.request\_event**

This attribute stores the service request (SRQ) event register.

Type	TSP-Link accessible	Affected by	Where saved	Default value
Attribute (R)	Yes	Not applicable	Not saved	0

**Usage**

```
requestSRQEventRegister = status.request_event
```

```
requestSRQEventRegister
```

The status of the request event register; a zero (0) indicates no bits set; other values indicate various bit settings

**Details**

This attribute is used to read the service request event register, which is returned as a numeric value. Reading this register returns a value. The binary equivalent of the value of this attribute indicates which register bits are set. In the binary equivalent, the least significant bit is bit B0, and the most significant bit is bit B7. For example, if a value of  $1.29000e+02$  (which is 129) is read as the value of this register, the binary equivalent is 1000 0001. This value indicates that bit B0 and bit B7 are set.

B7	B6	B5	B4	B3	B2	B1	B0
**	>	>	>	>	>	>	*
1	0	0	0	0	0	0	1

\* Least significant bit

\*\* Most significant bit

The returned value can indicate one or more status events occurred.



For information about `.condition`, `.enable`, `.event`, `.ntr`, and `.ptr` registers, refer to [Status register set contents](#) (on page C-1) and [Enable and transition registers](#) (on page C-20). The individual bits of this register are defined in the following table.

Bit	Value	Description
B0	<code>status.MEASUREMENT_SUMMARY_BIT</code> <code>status.MSB</code>	Set summary bit indicates that an enabled event in the Measurement Event Register has occurred. Bit B0 decimal value: 1
B1	<code>status.SYSTEM_SUMMARY_BIT</code> <code>status.SSB</code>	This bit is only available on Models 2601A/2602A/2611A/2612A/2635A/2636A. Set summary bit indicates that an enabled event in the System Summary Register has occurred. Bit B1 decimal value: 2
B2	<code>status.ERROR_AVAILABLE</code> <code>status.EAV</code>	Set summary bit indicates that an error or status message is present in the Error Queue. Bit B2 decimal value: 4
B3	<code>status.QUESTIONABLE_SUMMARY_BIT</code> <code>status.QSB</code>	Set summary bit indicates that an enabled event in the Questionable Status Register has occurred. Bit B3 decimal value: 8
B4	<code>status.MESSAGE_AVAILABLE</code> <code>status.MAV</code>	Set summary bit indicates that a response message is present in the Output Queue. Bit B4 decimal value: 16
B5	<code>status.EVENT_SUMMARY_BIT</code> <code>status.ESB</code>	Set summary bit indicates that an enabled event in the Standard Event Status Register has occurred. Bit B5 decimal value: 32
B6	Not used	Not applicable
B7	<code>status.OPERATION_SUMMARY_BIT</code> <code>status.OSB</code>	Set summary bit indicates that an enabled event in the Operation Status Register has occurred. Bit B7 decimal value: 128

In addition to the above constants, `requestEventRegister` can be set to the decimal equivalent of the bits set. When more than one bit of the register is set, `requestEventRegister` contains the sum of their decimal weights. For example, if 129 is returned, bits B0 and B7 are set (1 + 128).

Bit	B7	B6	B5	B4	B3	B2	B1	B0
Binary value	0/1	0/1	0/1	0/1	0/1	0/1	0/1	0/1
Decimal	128	64	32	16	8	4	2	1
Weights	(2 <sup>7</sup> )	(2 <sup>6</sup> )	(2 <sup>5</sup> )	(2 <sup>4</sup> )	(2 <sup>3</sup> )	(2 <sup>2</sup> )	(2 <sup>1</sup> )	(2 <sup>0</sup> )

### Example

```
requestEventRegister = status.request_event
print(requestEventRegister)
```

Reads the status request event register.

Sample output:

```
1.29000e+02
```

Converting this output (129) to its binary equivalent yields 1000 0001.

Therefore, this output indicates that the set bits of the status request event register are presently B0 (MSB) and B7 (OSB).

### Also see

[status.condition](#) (on page 7-172)

[status.system.\\*](#) (on page 7-190)

[Status byte and service request \(SRQ\)](#) (on page C-16)

## status.reset()

This function resets all bits in the status model.

Type	TSP-Link accessible	Affected by	Where saved	Default value
Function	Yes			

### Usage

```
status.reset()
```

### Details

This function clears all status data structure registers (enable, event, NTR, and PTR) to their default values. For information about .condition, .enable, .event, .ntr, and .ptr registers, refer to [Status register set contents](#) (on page C-1) and [Enable and transition registers](#) (on page C-20).

### Example

<code>status.reset()</code>	Resets the instrument status model.
-----------------------------	-------------------------------------

### Also see

[Status model](#) (on page C-1, on page C-1)

## status.standard.\*

These attributes manage the standard event status register set of the status model.

Type	TSP-Link accessible	Affected by	Where saved	Default value
Attribute	--	--	--	--
.condition (R)	Yes	Not applicable	Not saved	Not applicable
.enable (RW)	Yes	Status reset	Not saved	0
.event (R)	Yes	Status reset	Not saved	0
.ntr (RW)	Yes	Status reset	Not saved	0
.ptr (RW)	Yes	Status reset	Not saved	253 (All bits set)

### Usage

```
standardRegister = status.standard.condition
standardRegister = status.standard.enable
standardRegister = status.standard.event
standardRegister = status.standard.ntr
standardRegister = status.standard.ptr
status.standard.enable = standardRegister
status.standard.ntr = standardRegister
status.standard.ptr = standardRegister
```

<i>standardRegister</i>	The status of the standard event status register; a zero (0) indicates no bits set (also send 0 to clear all bits); other values indicate various bit settings
-------------------------	--

## Details

These attributes are used to read or write to the standard event status registers. Reading a status register returns a value. The binary equivalent of the returned value indicates which register bits are set. The least significant bit of the binary number is bit B0, and the most significant bit is bit B15. For example, if a value of  $1.29000e+02$  (which is 129) is read as the value of the condition register, the binary equivalent is 0000 0000 1000 0001. This value indicates that bit B0 and bit B7 are set.

B15	B14	B13	B12	B11	B10	B9	B8	B7	B6	B5	B4	B3	B2	B1	B0
**	>	>	>	>	>	>	>	>	>	>	>	>	>	>	*
0	0	0	0	0	0	0	0	1	0	0	0	0	0	0	1

\* Least significant bit

\*\* Most significant bit

For information about .condition, .enable, .event, .ntr, and .ptr registers, refer to [Status register set contents](#) (on page C-1) and [Enable and transition registers](#) (on page C-20). The individual bits of this register are defined in the following table.

Bit	Value	Description
B0	<code>status.standard.OPERATION_COMPLETE</code> <code>status.standard.OPC</code>	Set bit indicates that all pending selected instrument operations are completed and the instrument is ready to accept new commands. The bit is set in response to an *OPC command. The <code>opc()</code> function can be used in place of the *OPC command. Bit B0 decimal value: 1
B1	Not used	Not applicable
B2	<code>status.standard.QUERY_ERROR</code> <code>status.standard.QYE</code>	Set bit indicates that you attempted to read data from an empty Output Queue. Bit B2 decimal value: 4
B3	<code>status.standard.DEVICE_DEPENDENT_ERROR</code> <code>status.standard.DDE</code>	Set bit indicates that an instrument operation did not execute properly due to some internal condition. Bit B3 decimal value: 8
B4	<code>status.standard.EXECUTION_ERROR</code> <code>status.standard.EXE</code>	Set bit indicates that the instrument detected an error while trying to execute a command. Bit B4 decimal value: 16

Bit	Value	Description
B5	<code>status.standard.COMMAND_ERROR</code> <code>status.standard.CME</code>	Set bit indicates that a command error has occurred. Command errors include: <b>IEEE Std 488.2 syntax error:</b> Instrument received a message that does not follow the defined syntax of the IEEE Std 488.2 standard. <b>Semantic error:</b> Instrument received a command that was misspelled or received an optional IEEE Std 488.2 command that is not implemented. <b>GET error:</b> The instrument received a Group Execute Trigger (GET) inside a program message. Bit B5 decimal value: 32
B6	<code>status.standard.USER_REQUEST</code> <code>status.standard.URQ</code>	Set bit indicates that the LOCAL key on the instrument front panel was pressed. Bit B6 decimal value: 64
B7	<code>status.standard.POWER_ON</code> <code>status.standard.PON</code>	Set bit indicates that the instrument has been turned off and turned back on since the last time this register has been read. Bit B7 decimal value: 128
B8-B15	Not used	Not applicable

As an example, to set bit B0 of the standard event status enable register, set `status.standard.enable = status.standard.OPC`.

In addition to the above constants, `standardRegister` can be set to the numeric equivalent of the bit to set. To set more than one bit of the register, set `standardRegister` to the sum of their decimal weights. For example, to set bits B0 and B4, set `standardRegister` to 17 (which is the sum of 1 + 16).

Bit	B7	B6	B5	B4	B3	B2	B1	B0
Binary value	0/1	0/1	0/1	0/1	0/1	0/1	0/1	0/1
Decimal	128	64	32	16	8	4	2	1
Weights	(2 <sup>7</sup> )	(2 <sup>6</sup> )	(2 <sup>5</sup> )	(2 <sup>4</sup> )	(2 <sup>3</sup> )	(2 <sup>2</sup> )	(2 <sup>1</sup> )	(2 <sup>0</sup> )

### Example 1

```
standardRegister = status.standard.OPC
+ status.standard.EXE
status.standard.enable = standardRegister
```

Uses constants to set the OPC and EXE bits of the standard event status enable register.

### Example 2

```
-- decimal 17 = binary 0001 0001
standardRegister = 17
status.standard.enable = standardRegister
```

Uses a decimal value to set the OPC and EXE bits of the standard event status enable register.

### Also see

[Event summary bit \(ESB register\)](#) (on page C-9)

## status.system.\*

These attributes manage the TSP-Link® system summary register of the status model for nodes 1 through 14.

Type	TSP-Link accessible	Affected by	Where saved	Default value
Attribute	--	--	--	--
.condition (R)	Yes	Not applicable	Not saved	Not applicable
.enable (RW)	Yes	Status reset	Not saved	0
.event (R)	Yes	Status reset	Not saved	0
.ntr (RW)	Yes	Status reset	Not saved	0
.ptr (RW)	Yes	Status reset	Not saved	32,767 (All bits set)

### Usage

```
enableRegister = status.system.condition
enableRegister = status.system.enable
enableRegister = status.system.event
enableRegister = status.system.ntr
enableRegister = status.system.ptr
status.system.enable = enableRegister
status.system.ntr = enableRegister
status.system.ptr = enableRegister
```

<i>enableRegister</i>	The status of the system summary register; a zero (0) indicates no bits set; other values indicate various bit settings
-----------------------	---

### Details

In an expanded system (TSP-Link), these attributes are used to read or write to the system summary registers. They are set using a constant or a numeric value, but are returned as a numeric value. The binary equivalent of the value indicates which register bits are set. In the binary equivalent, the least significant bit is bit B0, and the most significant bit is bit B15. For example, if a value of 1.29000e+02 (which is 129) is read as the value of the condition register, the binary equivalent is 0000 0000 1000 0001. This value indicates that bit B0 and bit B7 are set.

B15	B14	B13	B12	B11	B10	B9	B8	B7	B6	B5	B4	B3	B2	B1	B0
**	>	>	>	>	>	>	>	>	>	>	>	>	>	>	*
0	0	0	0	0	0	0	0	1	0	0	0	0	0	0	1

\* Least significant bit

\*\* Most significant bit

For information about .condition, .enable, .event, .ntr, and .ptr registers, refer to [Status register set contents](#) (on page C-1) and [Enable and transition registers](#) (on page C-20). The individual bits of this register are defined in the following table.

Bit	Value	Description
B0	<code>status.system.EXTENSION_BIT</code> <code>status.system.EXT</code>	Bit B0 decimal value: 1
B1	<code>status.system.NODE1</code>	Bit B1 decimal value: 2
B2	<code>status.system.NODE2</code>	Bit B2 decimal value: 4
B3	<code>status.system.NODE3</code>	Bit B3 decimal value: 8
B4	<code>status.system.NODE4</code>	Bit B4 decimal value: 16
B5	<code>status.system.NODE5</code>	Bit B5 decimal value: 32
B6	<code>status.system.NODE6</code>	Bit B6 decimal value: 64
B7	<code>status.system.NODE7</code>	Bit B7 decimal value: 128
B8	<code>status.system.NODE8</code>	Bit B8 decimal value: 256
B9	<code>status.system.NODE9</code>	Bit B9 decimal value: 512
B10	<code>status.system.NODE10</code>	Bit B10 decimal value: 1,024
B11	<code>status.system.NODE11</code>	Bit B11 decimal value: 2,048
B12	<code>status.system.NODE12</code>	Bit B12 decimal value: 4,096
B13	<code>status.system.NODE13</code>	Bit B13 decimal value: 8,192
B14	<code>status.system.NODE14</code>	Bit B14 decimal value: 16,384
B15	Not used	Not applicable

As an example, to set bit B0 of the system summary status enable register, set `status.system.enable = status.system.enable.EXT`.

In addition to the above constants, `enableRegister` can be set to the numeric equivalent of the bit to set. To set more than one bit of the register, set `enableRegister` to the sum of their decimal weights. For example, to set bits B11 and B14, set `enableRegister` to 18,432 (which is the sum of 2,048 + 16,384).

Bit	B7	B6	B5	B4	B3	B2	B1	B0
Binary value	0/1	0/1	0/1	0/1	0/1	0/1	0/1	0/1
Decimal	128	64	32	16	8	4	2	1
Weights	(2 <sup>7</sup> )	(2 <sup>6</sup> )	(2 <sup>5</sup> )	(2 <sup>4</sup> )	(2 <sup>3</sup> )	(2 <sup>2</sup> )	(2 <sup>1</sup> )	(2 <sup>0</sup> )

Bit	B15	B14	B13	B12	B11	B10	B9	B8
Binary value	0/1	0/1	0/1	0/1	0/1	0/1	0/1	0/1
Decimal	32,768	16,384	8,192	4,096	2,048	1,024	512	256
Weights	(2 <sup>15</sup> )	(2 <sup>14</sup> )	(2 <sup>13</sup> )	(2 <sup>12</sup> )	(2 <sup>11</sup> )	(2 <sup>10</sup> )	(2 <sup>9</sup> )	(2 <sup>8</sup> )

### Example 1

```
enableRegister = status.system.NODE11 +
  status.system.NODE14
status.system.enable = enableRegister
```

Uses constants to set bits B11 and B14 of the system summary enable register.

### Example 2

```
-- decimal 18432 = binary 0100 1000 0000 0000
enableRegister = 18432
status.system.enable = enableRegister
```

Uses a decimal value to set bits B11 and B14 of the system summary enable register.

### Also see

[status.system2.\\*](#) (on page 7-192)  
[System summary bit \(System register\)](#) (on page C-5)

## status.system2.\*

These attributes manage the TSP-Link® system summary register of the status model for nodes 15 through 28.

Type	TSP-Link accessible	Affected by	Where saved	Default value
Attribute	--	--	--	--
.condition (R)	Yes	Not applicable	Not saved	Not applicable
.enable (RW)	Yes	Status reset	Not saved	0
.event (R)	Yes	Status reset	Not saved	0
.ntr (RW)	Yes	Status reset	Not saved	0
.ptr (RW)	Yes	Status reset	Not saved	32,767 (All bits set)

### Usage

```
enableRegister = status.system2.condition
enableRegister = status.system2.enable
enableRegister = status.system2.event
enableRegister = status.system2.ntr
enableRegister = status.system2.ptr
status.system2.enable = enableRegister
status.system2.ntr = enableRegister
status.system2.ptr = enableRegister
```

<i>enableRegister</i>	The status of the system summary 2 register; a zero (0) indicates no bits set; other values indicate various bit settings
-----------------------	---

### Details

In an expanded system (TSP-Link), these attributes are used to read or write to the system summary registers. They are set using a constant or a numeric value, but are returned as a numeric value. The binary equivalent of the value indicates which register bits are set. In the binary equivalent, the least significant bit is bit B0, and the most significant bit is bit B15. For example, if a value of  $1.29000e+02$  (which is 129) is read as the value of the condition register, the binary equivalent is 0000 0000 1000 0001. This value indicates that bit B0 and bit B7 are set.

B15	B14	B13	B12	B11	B10	B9	B8	B7	B6	B5	B4	B3	B2	B1	B0
**	>	>	>	>	>	>	>	>	>	>	>	>	>	>	*
0	0	0	0	0	0	0	0	1	0	0	0	0	0	0	1

\* Least significant bit  
 \*\* Most significant bit

For information about .condition, .enable, .event, .ntr, and .ptr registers, refer to [Status register set contents](#) (on page C-1) and [Enable and transition registers](#) (on page C-20). The individual bits of this register are defined in the following table.

Bit	Value	Description
B0	status.system2.EXTENSION_BIT status.system2.EXT	Bit B0 decimal value: 1
B1	status.system2.NODE15	Bit B1 decimal value: 2
B2	status.system2.NODE16	Bit B2 decimal value: 4
B3	status.system2.NODE17	Bit B3 decimal value: 8
B4	status.system2.NODE18	Bit B4 decimal value: 16
B5	status.system2.NODE19	Bit B5 decimal value: 32
B6	status.system2.NODE20	Bit B6 decimal value: 64
B7	status.system2.NODE21	Bit B7 decimal value: 128
B8	status.system2.NODE22	Bit B8 decimal value: 256
B9	status.system2.NODE23	Bit B9 decimal value: 512
B10	status.system2.NODE24	Bit B10 decimal value: 1,024
B11	status.system2.NODE25	Bit B11 decimal value: 2,048
B12	status.system2.NODE26	Bit B12 decimal value: 4,096
B13	status.system2.NODE27	Bit B13 decimal value: 8,192
B14	status.system2.NODE28	Bit B14 decimal value: 16,384
B15	Not used	Not applicable

As an example, to set bit B0 of the system summary 2 enable register, set `status.system2.enable = status.system2.EXT`.

In addition to the above constants, *enableRegister* can be set to the numeric equivalent of the bit to set. To set more than one bit of the register, set *enableRegister* to the sum of their decimal weights. For example, to set bits B11 and B14, set *enableRegister* to 18,432 (which is the sum of 2,048 + 16,384).

Bit	B7	B6	B5	B4	B3	B2	B1	B0
Binary value	0/1	0/1	0/1	0/1	0/1	0/1	0/1	0/1
Decimal	128	64	32	16	8	4	2	1
Weights	(2 <sup>7</sup> )	(2 <sup>6</sup> )	(2 <sup>5</sup> )	(2 <sup>4</sup> )	(2 <sup>3</sup> )	(2 <sup>2</sup> )	(2 <sup>1</sup> )	(2 <sup>0</sup> )
Bit	B15	B14	B13	B12	B11	B10	B9	B8
Binary value	0/1	0/1	0/1	0/1	0/1	0/1	0/1	0/1
Decimal	32,768	16,384	8,192	4,096	2,048	1,024	512	256
Weights	(2 <sup>15</sup> )	(2 <sup>14</sup> )	(2 <sup>13</sup> )	(2 <sup>12</sup> )	(2 <sup>11</sup> )	(2 <sup>10</sup> )	(2 <sup>9</sup> )	(2 <sup>8</sup> )

### Example 1

```
enableRegister = status.system2.NODE25 +
    status.system2.NODE28
status.system2.enable = enableRegister
```

Uses constants to set bits B11 and B14 of the system summary 2 enable register.



**Example 2**

```
-- decimal 18432 = binary 0100 1000 0000 0000
enableRegister = 18432
status.system2.enable = enableRegister
```

Uses a decimal value to set bits B11 and B14 of the system summary 2 enable register.

**Also see**

[status.system.\\*](#) (on page 7-190)

[status.system3.\\*](#) (on page 7-194)

[System summary bit \(System register\)](#) (on page C-5)

**status.system3.\***

These attributes manage the TSP-Link<sup>®</sup> system summary register of the status model for nodes 29 through 42.

Type	TSP-Link accessible	Affected by	Where saved	Default value
Attribute	--	--	--	--
.condition (R)	Yes	Not applicable	Not saved	Not applicable
.enable (RW)	Yes	Status reset	Not saved	0
.event (R)	Yes	Status reset	Not saved	0
.ntr (RW)	Yes	Status reset	Not saved	0
.ptr (RW)	Yes	Status reset	Not saved	32,767 (All bits set)

**Usage**

```
enableRegister = status.system3.condition
enableRegister = status.system3.enable
enableRegister = status.system3.event
enableRegister = status.system3.ntr
enableRegister = status.system3.ptr
status.system3.enable = enableRegister
status.system3.ntr = enableRegister
status.system3.ptr = enableRegister
```

<i>enableRegister</i>	The status of the system summary 3 register; a zero (0) indicates no bits set; other values indicate various bit settings
-----------------------	---

**Details**

In an expanded system (TSP-Link), these attributes are used to read or write to the system summary registers. They are set using a constant or a numeric value, but are returned as a numeric value. The binary equivalent of the value indicates which register bits are set. In the binary equivalent, the least significant bit is bit B0, and the most significant bit is bit B15. For example, if a value of 1.29000e+02 (which is 129) is read as the value of the condition register, the binary equivalent is 0000 0000 1000 0001. This value indicates that bit B0 and bit B7 are set.

B15	B14	B13	B12	B11	B10	B9	B8	B7	B6	B5	B4	B3	B2	B1	B0
**	>	>	>	>	>	>	>	>	>	>	>	>	>	>	*
0	0	0	0	0	0	0	0	1	0	0	0	0	0	0	1

\* Least significant bit  
 \*\* Most significant bit

For information about .condition, .enable, .event, .ntr, and .ptr registers, refer to [Status register set contents](#) (on page C-1) and [Enable and transition registers](#) (on page C-20). The individual bits of this register are defined in the following table.

Bit	Value	Description
B0	status.system3.EXTENSION_BIT status.system3.EXT	Bit B0 decimal value: 1
B1	status.system3.NODE29	Bit B1 decimal value: 2
B2	status.system3.NODE30	Bit B2 decimal value: 4
B3	status.system3.NODE31	Bit B3 decimal value: 8
B4	status.system3.NODE32	Bit B4 decimal value: 16
B5	status.system3.NODE33	Bit B5 decimal value: 32
B6	status.system3.NODE34	Bit B6 decimal value: 64
B7	status.system3.NODE35	Bit B7 decimal value: 128
B8	status.system3.NODE36	Bit B8 decimal value: 256
B9	status.system3.NODE37	Bit B9 decimal value: 512
B10	status.system3.NODE38	Bit B10 decimal value: 1,024
B11	status.system3.NODE39	Bit B11 decimal value: 2,048
B12	status.system3.NODE40	Bit B12 decimal value: 4,096
B13	status.system3.NODE41	Bit B13 decimal value: 8,192
B14	status.system3.NODE42	Bit B14 decimal value: 16,384
B15	Not used	Not applicable

As an example, to set bit B0 of the system summary 3 enable register, set `status.system3.enable = status.system3.EXT`.

In addition to the above constants, *enableRegister* can be set to the numeric equivalent of the bit to set. To set more than one bit of the register, set *enableRegister* to the sum of their decimal weights. For example, to set bits B11 and B14, set *enableRegister* to 18,432 (which is the sum of 2,048 + 16,384).

Bit	B7	B6	B5	B4	B3	B2	B1	B0
Binary value	0/1	0/1	0/1	0/1	0/1	0/1	0/1	0/1
Decimal	128	64	32	16	8	4	2	1
Weights	(2 <sup>7</sup> )	(2 <sup>6</sup> )	(2 <sup>5</sup> )	(2 <sup>4</sup> )	(2 <sup>3</sup> )	(2 <sup>2</sup> )	(2 <sup>1</sup> )	(2 <sup>0</sup> )

Bit	B15	B14	B13	B12	B11	B10	B9	B8
Binary value	0/1	0/1	0/1	0/1	0/1	0/1	0/1	0/1
Decimal	32,768	16,384	8,192	4,096	2,048	1,024	512	256
Weights	(2 <sup>15</sup> )	(2 <sup>14</sup> )	(2 <sup>13</sup> )	(2 <sup>12</sup> )	(2 <sup>11</sup> )	(2 <sup>10</sup> )	(2 <sup>9</sup> )	(2 <sup>8</sup> )

**Example 1**

<pre>enableRegister = status.system3.NODE39 +     status.system3.NODE42 status.system3.enable = enableRegister</pre>	<p>Uses constants to set bits B11 and B14 of the system summary 3 enable register.</p>
--	--

**Example 2**

```
-- decimal 18432 = binary 0100 1000 0000 0000
enableRegister = 18432
status.system3.enable = enableRegister
```

Uses a decimal value to set bits B11 and B14 of the system summary 3 enable register.

**Also see**

[status.system2.\\*](#) (on page 7-192)

[status.system4.\\*](#) (on page 7-196)

[System summary bit \(System register\)](#) (on page C-5)

**status.system4.\***

These attributes manage the TSP-Link<sup>®</sup> system summary register of the status model for nodes 43 through 56.

Type	TSP-Link accessible	Affected by	Where saved	Default value
Attribute	--	--	--	--
.condition (R)	Yes	Not applicable	Not saved	Not applicable
.enable (RW)	Yes	Status reset	Not saved	0
.event (R)	Yes	Status reset	Not saved	0
.ntr (RW)	Yes	Status reset	Not saved	0
.ptr (RW)	Yes	Status reset	Not saved	32,767 (All bits set)

**Usage**

```
enableRegister = status.system4.condition
enableRegister = status.system4.enable
enableRegister = status.system4.event
enableRegister = status.system4.ntr
enableRegister = status.system4.ptr
status.system4.enable = enableRegister
status.system4.ntr = enableRegister
status.system4.ptr = enableRegister
```

<i>enableRegister</i>	The status of the system summary 4 register; a zero (0) indicates no bits set; other values indicate various bit settings
-----------------------	---

**Details**

In an expanded system (TSP-Link), these attributes are used to read or write to the system summary registers. They are set using a constant or a numeric value, but are returned as a numeric value. The binary equivalent of the value indicates which register bits are set. In the binary equivalent, the least significant bit is bit B0, and the most significant bit is bit B15. For example, if a value of 1.29000e+02 (which is 129) is read as the value of the condition register, the binary equivalent is 0000 0000 1000 0001. This value indicates that bit B0 and bit B7 are set.

B15	B14	B13	B12	B11	B10	B9	B8	B7	B6	B5	B4	B3	B2	B1	B0
**	>	>	>	>	>	>	>	>	>	>	>	>	>	>	*
0	0	0	0	0	0	0	0	1	0	0	0	0	0	0	1

\* Least significant bit  
 \*\* Most significant bit

For information about .condition, .enable, .event, .ntr, and .ptr registers, refer to [Status register set contents](#) (on page C-1) and [Enable and transition registers](#) (on page C-20). The individual bits of this register are defined in the following table.

Bit	Value	Description
B0	status.system4.EXTENSION_BIT status.system4.EXT	Bit B0 decimal value: 1
B1	status.system4.NODE43	Bit B1 decimal value: 2
B2	status.system4.NODE44	Bit B2 decimal value: 4
B3	status.system4.NODE45	Bit B3 decimal value: 8
B4	status.system4.NODE46	Bit B4 decimal value: 16
B5	status.system4.NODE47	Bit B5 decimal value: 32
B6	status.system4.NODE48	Bit B6 decimal value: 64
B7	status.system4.NODE49	Bit B7 decimal value: 128
B8	status.system4.NODE50	Bit B8 decimal value: 256
B9	status.system4.NODE51	Bit B9 decimal value: 512
B10	status.system4.NODE52	Bit B10 decimal value: 1,024
B11	status.system4.NODE53	Bit B11 decimal value: 2,048
B12	status.system4.NODE54	Bit B12 decimal value: 4,096
B13	status.system4.NODE55	Bit B13 decimal value: 8,192
B14	status.system4.NODE56	Bit B14 decimal value: 16,384
B15	Not used	Not applicable

As an example, to set bit B0 of the system summary 4 enable register, set `status.system4.enable = status.system4.enable.EXT`.

In addition to the above constants, *enableRegister* can be set to the numeric equivalent of the bit to set. To set more than one bit of the register, set *enableRegister* to the sum of their decimal weights. For example, to set bits B11 and B14, set *enableRegister* to 18,432 (which is the sum of 2,048 + 16,384).

Bit	B7	B6	B5	B4	B3	B2	B1	B0
Binary value	0/1	0/1	0/1	0/1	0/1	0/1	0/1	0/1
Decimal	128	64	32	16	8	4	2	1
Weights	(2 <sup>7</sup> )	(2 <sup>6</sup> )	(2 <sup>5</sup> )	(2 <sup>4</sup> )	(2 <sup>3</sup> )	(2 <sup>2</sup> )	(2 <sup>1</sup> )	(2 <sup>0</sup> )

Bit	B15	B14	B13	B12	B11	B10	B9	B8
Binary value	0/1	0/1	0/1	0/1	0/1	0/1	0/1	0/1
Decimal	32,768	16,384	8,192	4,096	2,048	1,024	512	256
Weights	(2 <sup>15</sup> )	(2 <sup>14</sup> )	(2 <sup>13</sup> )	(2 <sup>12</sup> )	(2 <sup>11</sup> )	(2 <sup>10</sup> )	(2 <sup>9</sup> )	(2 <sup>8</sup> )

**Example 1**

```
enableRegister = status.system4.NODE53 +
    status.system4.NODE56
status.system2.enable = enableRegister
```

Uses constants to set bit B11 and bit B14 of the system summary 4 enable register.

**Example 2**

```
-- decimal 18432 = binary 0100 1000 0000 0000
enableRegister = 18432
status.system4.enable = enableRegister
```

Uses a decimal value to set bit B11 and bit B14 of the system summary 4 enable register.

**Also see**

[status.system3.\\*](#) (on page 7-194)

[status.system5.\\*](#) (on page 7-198)

[System summary bit \(System register\)](#) (on page C-5)

**status.system5.\***

These attributes manage the TSP-Link<sup>®</sup> system summary register of the status model for nodes 57 through 64.

Type	TSP-Link accessible	Affected by	Where saved	Default value
Attribute	--	--	--	--
.condition (R)	Yes	Not applicable	Not saved	Not applicable
.enable (RW)	Yes	Status reset	Not saved	0
.event (R)	Yes	Status reset	Not saved	0
.ntr (RW)	Yes	Status reset	Not saved	0
.ptr (RW)	Yes	Status reset	Not saved	510 (All bits set)

**Usage**

```
enableRegister = status.system5.condition
enableRegister = status.system5.enable
enableRegister = status.system5.event
enableRegister = status.system5.ntr
enableRegister = status.system5.ptr
status.system5.enable = enableRegister
status.system5.ntr = enableRegister
status.system5.ptr = enableRegister
```

<i>enableRegister</i>	The status of the system summary 5 register; a zero (0) indicates no bits set; other values indicate various bit settings
-----------------------	---

**Details**

In an expanded system (TSP-Link), these attributes are used to read or write to the system summary registers. They are set using a constant or a numeric value, but are returned as a numeric value. The binary equivalent of the value indicates which register bits are set. In the binary equivalent, the least significant bit is bit B0, and the most significant bit is bit B15. For example, if a value of 1.30000e+02 (which is 130) is read as the value of the condition register, the binary equivalent is 0000 0000 1000 0010. This value indicates that bit B1 and bit B7 are set.

B15	B14	B13	B12	B11	B10	B9	B8	B7	B6	B5	B4	B3	B2	B1	B0
**	>	>	>	>	>	>	>	>	>	>	>	>	>	>	*
0	0	0	0	0	0	0	0	1	0	0	0	0	0	1	0

\* Least significant bit  
 \*\* Most significant bit

For information about .condition, .enable, .event, .ntr, and .ptr registers, refer to [Status register set contents](#) (on page C-1) and [Enable and transition registers](#) (on page C-20). The individual bits of this register are defined in the following table.

Bit	Value	Description
B0	Not used	Not applicable
B1	status.system5.NODE57	Bit B1 decimal value: 2
B2	status.system5.NODE58	Bit B2 decimal value: 4
B3	status.system5.NODE59	Bit B3 decimal value: 8
B4	status.system5.NODE60	Bit B4 decimal value: 16
B5	status.system5.NODE61	Bit B5 decimal value: 32
B6	status.system5.NODE62	Bit B6 decimal value: 64
B7	status.system5.NODE63	Bit B7 decimal value: 128
B8	status.system5.NODE64	Bit B8 decimal value: 256
B9-B15	Not used	Not applicable

As an example, to set bit B1 of the system summary 5 enable register, set `status.system5.enable = status.system5.NODE57`.

In addition to the above constants, `enableRegister` can be set to the numeric equivalent of the bit to set. To set more than one bit of the register, set `enableRegister` to the sum of their decimal weights. For example, to set bits B1 and B4, set `enableRegister` to 18 (which is the sum of 2 + 16).

Bit	B7	B6	B5	B4	B3	B2	B1	B0
Binary value	0/1	0/1	0/1	0/1	0/1	0/1	0/1	0/1
Decimal	128	64	32	16	8	4	2	1
Weights	(2 <sup>7</sup> )	(2 <sup>6</sup> )	(2 <sup>5</sup> )	(2 <sup>4</sup> )	(2 <sup>3</sup> )	(2 <sup>2</sup> )	(2 <sup>1</sup> )	(2 <sup>0</sup> )

Bit	B15	B14	B13	B12	B11	B10	B9	B8
Binary value	0/1	0/1	0/1	0/1	0/1	0/1	0/1	0/1
Decimal	32,768	16,384	8,192	4,096	2,048	1,024	512	256
Weights	(2 <sup>15</sup> )	(2 <sup>14</sup> )	(2 <sup>13</sup> )	(2 <sup>12</sup> )	(2 <sup>11</sup> )	(2 <sup>10</sup> )	(2 <sup>9</sup> )	(2 <sup>8</sup> )

**Example 1**

```
enableRegister = status.system5.NODE57 +
    status.system5.NODE60
status.system2.enable = enableRegister
```

Uses constants to set bits B1 and B4 of the system summary 5 enable register.

**Example 2**

```
-- decimal 18 = binary 0000 0000 0001 0010
enableRegister = 18
status.system5.enable = enableRegister
```

Uses a decimal value to set bits B1 and B4 of the system summary 5 enable register.

**Also see**

[status.system4.\\*](#) (on page 7-196)  
[System summary bit \(System register\)](#) (on page C-5)

## timer.measure.t()

This function measures the elapsed time since the timer was last reset.

Type	TSP-Link accessible	Affected by	Where saved	Default value
Function	Yes			

**Usage**

```
time = timer.measure.t()
```

<i>time</i>	The elapsed time in seconds (1 $\mu$ s resolution)
-------------	--

**Example 1**

```
timer.reset()
-- (intervening code)
time = timer.measure.t()
print(time)
```

Resets the timer and measures the time since the reset.

Output:  
1.469077e+01

The output will vary. The above output indicates that `timer.measure.t()` was executed 14.69077 seconds after `timer.reset()`.

**Example 2**

```
beeper.beep(0.5, 2400)
print("reset timer")
timer.reset()
delay(0.5)
dt = timer.measure.t()
print("timer after delay:", dt)
beeper.beep(0.5, 2400)
```

Sets the beeper, resets the timer, sets a delay, then verifies the time of the delay before the next beeper.

Output:  
reset timer  
timer after delay: 5.00e-01

**Also see**

[timer.reset\(\)](#) (on page 7-200)

## timer.reset()

This function resets the timer to zero (0) seconds.

Type	TSP-Link accessible	Affected by	Where saved	Default value
Function	Yes			

**Usage**

```
timer.reset()
```

**Example**

```
timer.reset()
-- (intervening code)
time = timer.measure.t()
print(time)
```

Resets the timer and then measures the time since the reset.

Output:  
1.469077e+01

The above output indicates that `timer.measure.t()` was executed 14.69077 seconds after `timer.reset()`.

**Also see**

[timer.measure.t\(\)](#) (on page 7-200)

**trigger.blender[N].clear()**

This function clears the blender event detector and resets the overrun indicator of blender *N*.

Type	TSP-Link accessible	Affected by	Where saved	Default value
Function	Yes			

**Usage**

```
trigger.blender[N].clear()
```

<i>N</i>	The blender number (1 or 2)
----------	-----------------------------

**Details**

This command sets the blender event detector to the undetected state and resets the overrun indicator of the event detector.

**Example**

```
trigger.blender[2].clear()
```

Clears the event detector for blender 2.

**Also see**

None

**trigger.blender[N].EVENT\_ID**

This constant contains the trigger blender event number.

Type	TSP-Link accessible	Affected by	Where saved	Default value
Constant	Yes			

**Usage**

```
eventID = trigger.blender[N].EVENT_ID
```

<i>eventID</i>	Trigger event number
<i>N</i>	The blender number (1 or 2)



**Details**

Set the stimulus of any trigger object to the value of this constant to have the trigger object respond to trigger events from this trigger blender.

**Example**

```
digio.trigger[1].stimulus = trigger.blender[2].EVENT_ID
```

Set the trigger stimulus of digital I/O trigger 1 to be controlled by the trigger blender 2 event.

**Also see**

None

**trigger.blender[N].orenable**

This attribute selects whether the blender performs OR operations or AND operations.

Type	TSP-Link accessible	Affected by	Where saved	Default value
Attribute (RW)	Yes	Instrument reset Trigger blender N reset Recall setup	Create configuration script	false (AND mode)

**Usage**

```
orenable = trigger.blender[N].orenable
trigger.blender[N].orenable = orenable
```

<i>orenable</i>	The type of operation: <ul style="list-style-type: none"> <li>• true: OR operation</li> <li>• false: AND operation</li> </ul>
<i>N</i>	The blender number (1 or 2)

**Details**

This command selects whether the blender waits for any one event (OR) or waits for all selected events (AND) before signaling an output event.

**Example**

```
trigger.blender[1].orenable = true
trigger.blender[1].stimulus[1] = digio.trigger[3].EVENT_ID
trigger.blender[1].stimulus[2] = digio.trigger[5].EVENT_ID
```

Generate a trigger blender 1 event when a digital I/O trigger happens on line 3 or 5.

**Also see**

[trigger.blender\[N\].reset\(\)](#) (on page 7-203)

## trigger.blender[N].overrun

This attribute indicates whether or not an event was ignored because of the event detector state.

Type	TSP-Link accessible	Affected by	Where saved	Default value
Attribute (R)	Yes	Instrument reset Trigger blender <i>N</i> clear Trigger blender <i>N</i> reset	Not applicable	Not applicable

### Usage

```
overrun = trigger.blender[N].overrun
```

<i>overrun</i>	Trigger blender overrun state (true or false)
<i>N</i>	The blender number (1 or 2)

### Details

Indicates if an event was ignored because the event detector was already in the detected state when the event occurred. This is an indication of the state of the event detector that is built into the event blender itself.

This command does not indicate if an overrun occurred in any other part of the trigger model or in any other trigger object that is monitoring the event. It also is not an indication of an action overrun.

### Example

```
print(trigger.blender[1].overrun)
```

If an event was ignored, the output is true.  
If an event was not ignored, the output is false.

### Also see

[trigger.blender\[N\].reset\(\)](#) (on page 7-203)

## trigger.blender[N].reset()

This function resets some of the trigger blender settings to their factory defaults.

Type	TSP-Link accessible	Affected by	Where saved	Default value
Function	Yes			

### Usage

```
trigger.blender[N].reset()
```

<i>N</i>	The trigger event blender (1 or 2)
----------	------------------------------------

### Details

The `trigger.blender[N].reset()` function resets the following attributes to their factory defaults:

- `trigger.blender[N].orenable`
- `trigger.blender[N].stimulus[M]`

It also clears `trigger.blender[N].overrun`.

**Example**

```
trigger.blender[1].reset()
```

Resets the trigger blender 1 settings to factory defaults.

**Also see**

[trigger.blender\[N\].orenable](#) (on page 7-202)  
[trigger.blender\[N\].overrun](#) (on page 7-203)  
[trigger.blender\[N\].stimulus\[M\]](#) (on page 7-204)

**trigger.blender[N].stimulus[M]**

This attribute specifies which events trigger the blender.

Type	TSP-Link accessible	Affected by	Where saved	Default value
Attribute (RW)	Yes	Reset Recall setup Trigger blender N reset	Create configuration script	0

**Usage**

```
eventID = trigger.blender[N].stimulus[M]
trigger.blender[N].stimulus[M] = eventID
```

<i>eventID</i>	The event that triggers the blender action; see <b>Details</b>
<i>N</i>	An integer representing the trigger event blender (1 or 2)
<i>M</i>	An integer representing the stimulus index (1 to 4)

**Details**

There are four acceptors that can each select a different event. The *eventID* parameter can be the event ID of any trigger event. The *eventID* parameter may be one of the existing trigger event IDs shown in the following table.

Trigger event IDs	
Trigger event ID	Description
digio.trigger[N].EVENT_ID	An edge (rising, falling, or either based on the configuration of the line) on the digital input line
display.trigger.EVENT_ID	The trigger key on the front panel is pressed
trigger.EVENT_ID	A *trg message on the active command interface. If GPIB is the active command interface, a GET message also generates this event
trigger.blender[N].EVENT_ID	A combination of events has occurred
trigger.timer[N].EVENT_ID	A delay expired
tsplink.trigger[N].EVENT_ID	An edge (rising, falling, or either based on the configuration of the line) on the TSP-Link <sup>®</sup> trigger line
lan.trigger[N].EVENT_ID	A LAN trigger event has occurred
scan.trigger.EVENT_SCAN_READY	Scan ready event
scan.trigger.EVENT_SCAN_START	Scan start event
scan.trigger.EVENT_CHANNEL_READY	Channel ready event
scan.trigger.EVENT_SCAN_COMP	Scan complete event
scan.trigger.EVENT_IDLE	Idle event

**Example**

```

digio.trigger[3].mode = digio.TRIG_FALLING
digio.trigger[5].mode = digio.TRIG_FALLING
trigger.blender[1].orenable = true
trigger.blender[1].stimulus[1] = digio.trigger[3].EVENT_ID
trigger.blender[1].stimulus[2] = digio.trigger[5].EVENT_ID

```

Generate a trigger blender 1 event when a digital I/O trigger happens on line 3 or 5.

**Also see**

[trigger.blender\[N\].reset\(\)](#) (on page 7-203)

**trigger.blender[N].wait()**

This function waits for a blender trigger event to occur.

Type	TSP-Link accessible	Affected by	Where saved	Default value
Function	Yes			

**Usage**

```
triggered = trigger.blender[N].wait(timeout)
```

<i>triggered</i>	Trigger detection indication for blender
<i>N</i>	The trigger blender (1 or 2) on which to wait
<i>timeout</i>	Maximum amount of time in seconds to wait for the trigger blender event

**Details**

This function waits for an event blender trigger event. If one or more trigger events were detected since the last time `trigger.blender[N].wait()` or `trigger.blender[N].clear()` was called, this function returns immediately.

After detecting a trigger with this function, the event detector automatically resets and rearms. This is true regardless of the number of events detected.

**Example**

```

digio.trigger[3].mode = digio.TRIG_FALLING
digio.trigger[5].mode = digio.TRIG_FALLING
trigger.blender[1].orenable = true
trigger.blender[1].stimulus[1] = digio.trigger[3].EVENT_ID
trigger.blender[1].stimulus[2] = digio.trigger[5].EVENT_ID

print(trigger.blender[1].wait(3))

```

Generate a trigger blender 1 event when a digital I/O trigger happens either on line 3 or 5.

Wait three seconds while checking if trigger blender 1 event has occurred.

If the blender trigger event has happened, then `true` is output. If the trigger event has not happened, then `false` is output after the timeout expires.

**Also see**

[trigger.blender\[N\].clear\(\)](#) (on page 7-201)

---

## trigger.clear()

This function clears the command interface trigger event detector.

Type	TSP-Link accessible	Affected by	Where saved	Default value
Function	No			

### Usage

```
trigger.clear()
```

### Details

The trigger event detector indicates if a trigger event has been detected since the last `trigger.wait()` call. `trigger.clear()` clears the trigger event detector and discards the history of command interface trigger events.

### Also see

[trigger.wait\(\)](#) (on page 7-213)

---

## trigger.EVENT\_ID

This constant contains the command interface trigger event number.

Type	TSP-Link accessible	Affected by	Where saved	Default value
Constant	Yes			

### Usage

```
eventID = trigger.EVENT_ID
```

<code>eventID</code>	The event ID for the command interface triggers
----------------------	---

### Details

You can set the stimulus of any trigger object to the value of this constant to have the trigger object respond to command interface trigger events.

### Also see

None

---

## trigger.timer[N].clear()

This function clears the timer event detector and overrun indicator for the specified trigger timer number.

Type	TSP-Link accessible	Affected by	Where saved	Default value
Function	Yes			

### Usage

```
trigger.timer[N].clear()
```

<code>N</code>	Trigger timer number (1 to 4)
----------------	-------------------------------

**Details**

This command sets the timer event detector to the undetected state and resets the overrun indicator.

**Example**

```
trigger.timer[1].clear()
```

Clears trigger timer 1.

**Also see**

[trigger.timer\[N\].count](#) (on page 7-207)

**trigger.timer[N].count**

This attribute sets the number of events to generate each time the timer generates a trigger event.

Type	TSP-Link accessible	Affected by	Where saved	Default value
Attribute (RW)	Yes	Instrument reset Recall setup Trigger timer N reset	Create configuration script	1

**Usage**

```
count = trigger.timer[N].count
trigger.timer[N].count = count
```

<i>count</i>	Number of times to repeat the trigger (0 to 1,048,575)
<i>N</i>	Trigger timer number (1 to 4)

**Details**

If *count* is set to a number greater than 1, the timer automatically starts the next trigger timer delay at the expiration of the previous delay.

Set *count* to zero (0) to cause the timer to generate trigger events indefinitely.

**Example**

```
print(trigger.timer[1].count)
```

Read trigger count for timer number 1.

**Also see**

[trigger.timer\[N\].clear\(\)](#) (on page 7-206)

[trigger.timer\[N\].delay](#) (on page 7-208)

[trigger.timer\[N\].reset\(\)](#) (on page 7-211)

## trigger.timer[N].delay

This attribute sets and reads the timer delay.

Type	TSP-Link accessible	Affected by	Where saved	Default value
Attribute (RW)	Yes	Instrument reset Recall setup Trigger timer N reset	Create configuration script	10e-6 (10 $\mu$ s)

### Usage

```
interval = trigger.timer[N].delay
trigger.timer[N].delay = interval
```

<i>interval</i>	Delay interval in seconds (8e-6 to 100,000)
<i>N</i>	Trigger timer number (1 to 4)

### Details

Once the timer is enabled, each time the timer is triggered, it uses this delay period.

Assigning a value to this attribute is equivalent to:

```
trigger.timer[N].delaylist = {interval}
```

This creates a delay list of one value.

Reading this attribute returns the delay interval that will be used the next time the timer is triggered.

### Example

```
trigger.timer[1].delay = 50e-6
```

Set the trigger timer 1 to delay for 50  $\mu$ s.

### Also see

[trigger.timer\[N\].reset\(\)](#) (on page 7-211)

## trigger.timer[N].delaylist

This attribute sets an array of timer intervals.

Type	TSP-Link accessible	Affected by	Where saved	Default value
Attribute (RW)	Yes	Instrument reset Recall setup Trigger timer <i>N</i> reset	Create configuration script	{10e-6}

### Usage

```
intervals = trigger.timer[N].delaylist
trigger.timer[N].delaylist = intervals
```

<i>intervals</i>	Table of delay intervals in seconds
<i>N</i>	Trigger timer number (1 to 4)

**Details**

Each time the timer is triggered after it is enabled, it uses the next delay period from the array. The default value is an array with one value of 10  $\mu$ s.

After all elements in the array have been used, the delays restart at the beginning of the list.

If the array contains more than one element, the average of the delay intervals in the list must be  $\geq 50 \mu$ s.

**Example**

<pre>trigger.timer[3].delaylist = {50e-6, 100e-6, 150e-6}  DelayList = trigger.timer[3].delaylist for x = 1, table.getn(DelayList) do     print(DelayList[x]) end</pre>	<p>Set a delay list on trigger timer 3 with three delays (50 <math>\mu</math>s, 100 <math>\mu</math>s, and 150 <math>\mu</math>s).</p> <p>Read the delay list on trigger timer 3.</p> <p>Output (assuming the delay list was set to 50 <math>\mu</math>s, 100 <math>\mu</math>s, and 150 <math>\mu</math>s):                      5.000000000e-05                      1.000000000e-04                      1.500000000e-04</p>
---	---

**Also see**

[trigger.timer\[N\].reset\(\)](#) (on page 7-211)

---

## trigger.timer[N].EVENT\_ID

This constant specifies the trigger timer event number.

Type	TSP-Link accessible	Affected by	Where saved	Default value
Constant	Yes			

**Usage**

```
eventID = trigger.timer[N].EVENT_ID
```

<i>eventID</i>	The trigger event number
<i>N</i>	Trigger timer number (1 to 4)

**Details**

This constant is an identification number that identifies events generated by this timer.

Set the stimulus of any trigger object to the value of this constant to have the trigger object respond to events from this timer.

**Also see**

None



## trigger.timer[N].overrun

This attribute indicates if an event was ignored because of the event detector state.

Type	TSP-Link accessible	Affected by	Where saved	Default value
Attribute (R)	Yes	Instrument reset Recall setup Trigger timer N clear Trigger timer N reset	Not applicable	false

### Usage

```
overrun = trigger.timer[N].overrun
```

<i>overrun</i>	Trigger overrun state (true or false)
<i>N</i>	Trigger timer number (1 to 4)

### Details

This command indicates if an event was ignored because the event detector was already in the detected state when the event occurred.

This is an indication of the state of the event detector built into the timer itself. It does not indicate if an overrun occurred in any other part of the trigger model or in any other construct that is monitoring the delay completion event. It also is not an indication of a delay overrun.

### Example

```
print(trigger.timer[1].overrun)
```

If an event was ignored, the output is true.  
If the event was not ignored, the output is false.

### Also see

[trigger.timer\[N\].reset\(\)](#) (on page 7-211)

## trigger.timer[N].passthrough

This attribute enables or disables the timer trigger pass-through mode.

Type	TSP-Link accessible	Affected by	Where saved	Default value
Attribute (RW)	Yes	Instrument reset Recall setup Trigger timer N reset	Create configuration script	false (disabled)

### Usage

```
passthrough = trigger.timer[N].passthrough
trigger.timer[N].passthrough = passthrough
```

<i>passthrough</i>	The state of pass-through mode; set to to one of the following values: true: Enabled false: Disabled
<i>N</i>	Trigger timer number (1 to 4)

## Details

When pass-through mode is enabled, triggers are passed through immediately and initiate the delay. When disabled, a trigger only initiates a delay.

## Example

```
trigger.timer[1].passthrough = true
```

Enables pass-through mode on trigger timer 1.

## Also see

[trigger.timer\[N\].reset\(\)](#) (on page 7-211)

# trigger.timer[N].reset()

This function resets some of the trigger timer settings to their factory defaults.

Type	TSP-Link accessible	Affected by	Where saved	Default value
Function	Yes			

## Usage

```
trigger.timer[N].reset()
```

*N* Trigger timer number (1 to 4)

## Details

The `trigger.timer[N].reset()` function resets the following attributes to their factory defaults:

- `trigger.timer[N].count`
- `trigger.timer[N].delay`
- `trigger.timer[N].delaylist`
- `trigger.timer[N].passthrough`
- `trigger.timer[N].stimulus`

It also clears `trigger.timer[N].overrun`.

## Example

```
trigger.timer[1].reset()
```

Resets the attributes associated with timer 1 back to factory default values.

## Also see

[trigger.timer\[N\].count](#) (on page 7-207)  
[trigger.timer\[N\].delay](#) (on page 7-208)  
[trigger.timer\[N\].delaylist](#) (on page 7-208)  
[trigger.timer\[N\].overrun](#) (on page 7-210)  
[trigger.timer\[N\].passthrough](#) (on page 7-210)

## trigger.timer[N].stimulus

This attribute specifies which event starts the timer.

Type	TSP-Link accessible	Affected by	Where saved	Default value
Attribute (RW)	Yes	Reset Recall setup Trigger timer N reset	Create configuration script	0

### Usage

```
eventID = trigger.timer[N].stimulus
trigger.timer[N].stimulus = eventID
```

<i>eventID</i>	The event that triggers the timer delay
<i>N</i>	Trigger timer number (1 to 4)

### Details

The *eventID* parameter may be one of the trigger event IDs shown in the following table.

Trigger event IDs	
Trigger event ID	Description
digio.trigger[N].EVENT_ID	An edge (rising, falling, or either based on the configuration of the line) on the digital input line
display.trigger.EVENT_ID	The trigger key on the front panel is pressed
trigger.EVENT_ID	A *trg message on the active command interface. If GPIB is the active command interface, a GET message also generates this event
trigger.blender[N].EVENT_ID	A combination of events has occurred
trigger.timer[N].EVENT_ID	A delay expired
tsplink.trigger[N].EVENT_ID	An edge (rising, falling, or either based on the configuration of the line) on the TSP-Link <sup>®</sup> trigger line
lan.trigger[N].EVENT_ID	A LAN trigger event has occurred
scan.trigger.EVENT_SCAN_READY	Scan ready event
scan.trigger.EVENT_SCAN_START	Scan start event
scan.trigger.EVENT_CHANNEL_READY	Channel ready event
scan.trigger.EVENT_SCAN_COMP	Scan complete event
scan.trigger.EVENT_IDLE	Idle event

Set this attribute to the *eventID* of any trigger event to cause the timer to start when that event occurs.

Use zero (0) to disable event processing.

### Example

```
print(trigger.timer[1].stimulus)
```

Prints the event that will start a trigger 1 timer action.

### Also see

[trigger.timer\[N\].reset\(\)](#) (on page 7-211)

## trigger.timer[N].wait()

This function waits for a trigger.

Type	TSP-Link accessible	Affected by	Where saved	Default value
Function	Yes			

### Usage

```
triggered = trigger.timer[N].wait(timeout)
```

<i>triggered</i>	Trigger detection indication
<i>N</i>	Trigger timer number (1 to 4)
<i>timeout</i>	Maximum amount of time in seconds to wait for the trigger

### Details

If one or more trigger events were detected since the last time `trigger.timer[N].wait()` or `trigger.timer[N].clear()` was called, this function returns immediately.

After waiting for a trigger with this function, the event detector is automatically reset and rearmed. This is true regardless of the number of events detected.

### Example

```
triggered = trigger.timer[3].wait(10)
print(triggered)
```

Waits up to 10 s for a trigger on timer 3.  
If `false` is returned, no trigger was detected during the 10 s timeout.  
If `true` is returned, a trigger was detected.

### Also see

[trigger.timer\[N\].clear\(\)](#) (on page 7-206)

## trigger.wait()

This function waits for a command interface trigger event.

Type	TSP-Link accessible	Affected by	Where saved	Default value
Function	No			

### Usage

```
triggered = trigger.wait(timeout)
```

<i>triggered</i>	<code>true</code> : A trigger was detected during the timeout period <code>false</code> : No triggers were detected during the timeout period
<i>timeout</i>	Maximum amount of time in seconds to wait for the trigger

## Details

This function waits up to *timeout* seconds for a trigger on the active command interface. A command interface trigger occurs when:

- A GPIB GET command is detected (GPIB only)
- A VXI-11 device\_trigger method is invoked (VXI-11 only)
- A \*TRG message is received

If one or more of these trigger events were previously detected, this function returns immediately. After waiting for a trigger with this function, the event detector is automatically reset and rearmed. This is true regardless of the number of events detected.

## Example

```
triggered = trigger.wait(10)
print(triggered)
```

Waits up to 10 seconds for a trigger.  
If `false` is returned, no trigger was detected during the 10-second timeout.  
If `true` is returned, a trigger was detected.

## Also see

[trigger.clear\(\)](#) (on page 7-206)

# tsplink.group

This attribute contains the group number of a TSP-Link node.

Type	TSP-Link accessible	Affected by	Where saved	Default value
Attribute (RW)	Yes	Not applicable	Nonvolatile memory	0

## Usage

```
groupNumber = tsplink.group
tsplink.group = groupNumber
```

<i>groupNumber</i>	The group number of the TSP-Link node (0 to 64)
--------------------	---

## Details

To remove the node from all groups, set the attribute value to 0.

When the node is turned off, the group number for that node changes to 0.

The master node can be assigned to any group. You can also include other nodes in the group that includes the master. Note that any nodes that are set to 0 are automatically included in the group that contains the master node, regardless of the group that is assigned to the master node.

## Example

```
tsplink.group = 3
```

Assign the instrument to TSP-Link group number 3.

## Also see

[Using groups to manage nodes on TSP-Link network](#) (on page 6-48)

## tsplink.master

This attribute reads the node number assigned to the master node.

Type	TSP-Link accessible	Affected by	Where saved	Default value
Attribute (R)	Yes	Not applicable	Not applicable	Not applicable

### Usage

```
masterNodeNumber = tsplink.master
```

<code>masterNodeNumber</code>	The node number of the master node
-------------------------------	------------------------------------

### Details

After doing a TSP-Link reset (`tsplink.reset()`), use this attribute to access the node number of the master in a set of instruments connected over TSP-Link.

### Example

```
LinkMaster = tsplink.master
```

Store the TSP-Link master node number in a variable called LinkMaster.

### Also see

[tsplink.reset\(\)](#) (on page 7-217)

## tsplink.node

This attribute defines the node number.

Type	TSP-Link accessible	Affected by	Where saved	Default value
Attribute (RW)	Yes	Not applicable	Nonvolatile memory	2

### Usage

```
nodeNumber = tsplink.node
tsplink.node = nodeNumber
```

<code>nodeNumber</code>	The node number of the instrument or enclosure (1 to 64)
-------------------------	--

### Details

This attribute sets the TSP-Link node number and saves the value in nonvolatile memory. Changes to the node number do not take effect until `tsplink.reset()` from an earlier TSP-Link instrument is executed on any node in the system.

Each node connected to the TSP-Link system must be assigned a different node number.

### Example

```
tsplink.node = 3
```

Sets the TSP-Link node for this instrument to number 3.

### Also see

[tsplink.reset\(\)](#) (on page 7-217)

[tsplink.state](#) (on page 7-218)

## tsplink.readbit()

This function reads the state of a TSP-Link synchronization line.

Type	TSP-Link accessible	Affected by	Where saved	Default value
Function	Yes			

### Usage

```
data = tsplink.readbit(N)
```

<i>data</i>	The state of the synchronization line
<i>N</i>	The trigger line (1 to 3)

### Details

Returns a value of zero (0) if the line is low and 1 if the line is high.

### Example

```
data = tsplink.readbit(3)
print(data)
```

Assume line 3 is set high, and it is then read.  
Output:  
1.000000e+00

### Also see

[tsplink.readport\(\)](#) (on page 7-216)  
[tsplink.writebit\(\)](#) (on page 7-226)

## tsplink.readport()

This function reads the TSP-Link synchronization lines as a digital I/O port.

Type	TSP-Link accessible	Affected by	Where saved	Default value
Function	Yes			

### Usage

```
data = tsplink.readport()
```

<i>data</i>	Numeric value that indicates which lines are set
-------------	--

### Details

The binary equivalent of the returned value indicates the input pattern on the I/O port. The least significant bit of the binary number corresponds to line 1 and the value of bit 3 corresponds to line 3. For example, a returned value of 2 has a binary equivalent of 010. This indicates that line 2 is high (1), and that the other two lines are low (0).

**Example**

<pre>data = tsplink.readport() print(data)</pre>	<p>Reads state of all three TSP-Link lines. Assuming line 2 is set high, the output is: 2.000000e+00 (binary 010) The format of the output may vary depending on the ASCII precision setting.</p>
--	---

**Also see**

[tsplink.readbit\(\)](#) (on page 7-216)  
[tsplink.writebit\(\)](#) (on page 7-226)  
[tsplink.writeport\(\)](#) (on page 7-227)

**tsplink.reset()**

This function initializes (resets) all nodes (instruments) in the TSP-Link system.

Type	TSP-Link accessible	Affected by	Where saved	Default value
Function	No			

**Usage**

```
nodesFound = tsplink.reset()
nodesFound = tsplink.reset(expectedNodes)
```

<i>nodesFound</i>	The number of nodes actually found on the system
<i>expectedNodes</i>	The number of nodes expected on the system (1 to 64)



## Details

This function erases all information regarding other nodes connected on the TSP-Link system and regenerates the system configuration. This function must be called at least once before any remote nodes can be accessed. If the node number for any instrument is changed, the TSP-Link must be reset again.

If *expectedNodes* is not given, this function generates an error if no other nodes are found on the TSP-Link network.

If *nodesFound* is less than *expectedNodes*, an error is generated. Note that the node on which the command is running is counted as a node. For example, giving an expected node count of 1 will not generate any errors, even if there are no other nodes on the TSP-Link network.

Also returns the number of nodes found.

## Example

```
nodesFound = tsplink.reset(2)
print("Nodes found = " .. nodesFound)
```

Perform a TSP-Link reset and indicate how many nodes are found.

Sample output if two nodes are found:

```
Nodes found = 2
```

Sample output if fewer nodes are found and if `localnode.showerrors = 1`:

```
1219, TSP-Link found fewer nodes
    than expected
Nodes found = 1
```

## Also see

[localnode.showerrors](#) (on page 7-127)

[tsplink.node](#) (on page 7-215)

[tsplink.state](#) (on page 7-218)

## tsplink.state

This attribute describes the TSP-Link online state.

Type	TSP-Link accessible	Affected by	Where saved	Default value
Attribute (R)	Yes	Not applicable	Not applicable	Not applicable

## Usage

```
state = tsplink.state
```

```
state TSP-Link state (online or offline)
```

## Details

When the instrument power is first turned on, the state is `offline`. After `tsplink.reset()` is successful, the state is `online`.

## Example

```
state = tsplink.state
print(state)
```

Read the state of the TSP-Link system. If it is online, the output is:

```
online
```

## Also see

[tsplink.node](#) (on page 7-215)

[tsplink.reset\(\)](#) (on page 7-217)

## tsplink.trigger[N].assert()

This function simulates the occurrence of the trigger and generates the corresponding event ID.

Type	TSP-Link accessible	Affected by	Where saved	Default value
Function	Yes			

### Usage

```
tsplink.trigger[N].assert()
```

<i>N</i>	The trigger line (1 to 3)
----------	---------------------------

### Details

The set pulse width determines how long the trigger is asserted.

### Example

<code>tsplink.trigger[2].assert()</code>	Asserts trigger on trigger line 2.
--	------------------------------------

### Also see

[tsplink.trigger\[N\].clear\(\)](#) (on page 7-219)  
[tsplink.trigger\[N\].mode](#) (on page 7-220)  
[tsplink.trigger\[N\].overrun](#) (on page 7-222)  
[tsplink.trigger\[N\].pulsewidth](#) (on page 7-223)  
[tsplink.trigger\[N\].release\(\)](#) (on page 7-223)  
[tsplink.trigger\[N\].stimulus](#) (on page 7-224)  
[tsplink.trigger\[N\].wait\(\)](#) (on page 7-225)

## tsplink.trigger[N].clear()

This function clears the event detector for a LAN trigger.

Type	TSP-Link accessible	Affected by	Where saved	Default value
Function	Yes			

### Usage

```
tsplink.trigger[N].clear()
```

<i>N</i>	The trigger line (1 to 3) to clear
----------	------------------------------------

### Details

The trigger event detector enters the detected state when an event is detected.

`tsplink.trigger[N].clear()` clears a trigger event detector, discards the history of the trigger line, and clears the `tsplink.trigger[N].overrun` attribute.

**Example**

```
tsplink.trigger[2].clear()
```

Clears trigger event on synchronization line 2.

**Also see**

[tsplink.trigger\[N\].mode](#) (on page 7-220)  
[tsplink.trigger\[N\].overrun](#) (on page 7-222)  
[tsplink.trigger\[N\].release\(\)](#) (on page 7-223)  
[tsplink.trigger\[N\].stimulus](#) (on page 7-224)  
[tsplink.trigger\[N\].wait\(\)](#) (on page 7-225)

**tsplink.trigger[N].EVENT\_ID**

This constant identifies the number that is used for the trigger events.

Type	TSP-Link accessible	Affected by	Where saved	Default value
Constant	Yes			

**Usage**

```
eventID = tsplink.trigger[N].EVENT_ID
```

<i>eventID</i>	The trigger event number
<i>N</i>	The trigger line (1 to 3)

**Details**

This number is used by the TSP-Link trigger line when it detects an input trigger.

Set the stimulus of any trigger object to the value of this constant to have the trigger object respond to trigger events from this line.

**Example**

```
trigger.timer[1].stimulus = tsplink.trigger[2].EVENT_ID
```

Sets the trigger stimulus of trigger timer 1 to the TSP-Link trigger 2 event.

**Also see**

None

**tsplink.trigger[N].mode**

This attribute defines the trigger operation and detection mode.

Type	TSP-Link accessible	Affected by	Where saved	Default value
Attribute (RW)	Yes	Instrument reset Recall setup TSP-Link trigger N reset	Create configuration script	0 (tsplink.TRIG_BYPASS)

**Usage**

```
mode = tsplink.trigger[N].mode  
tsplink.trigger[N].mode = mode
```

<i>mode</i>	The trigger mode
<i>N</i>	The trigger line (1 to 3)

## Details

This attribute controls the mode in which the trigger event detector and the output trigger generator operate on the given trigger line.

The setting for *mode* can be one of the following values:

Mode	Number value	Description
<code>tsplink.TRIG_BYPASS</code>	0	Allows direct control of the line as a digital I/O line.
<code>tsplink.TRIG_FALLING</code>	1	Detects falling-edge triggers as input. Asserts a TTL-low pulse for output.
<code>tsplink.TRIG_RISING</code>	2	If the programmed state of the line is high, the <code>tsplink.TRIG_RISING</code> mode behaves similarly to <code>tsplink.TRIG_RISINGA</code> . If the programmed state of the line is low, the <code>tsplink.TRIG_RISING</code> mode behaves similarly to <code>tsplink.TRIG_RISINGM</code> . Use <code>tsplink.TRIG_RISINGA</code> if the line is in the high output state. Use <code>tsplink.TRIG_RISINGM</code> if the line is in the low output state.
<code>tsplink.TRIG_EITHER</code>	3	Detects rising- or falling-edge triggers as input. Asserts a TTL-low pulse for output.
<code>tsplink.TRIG_SYNCHRONOUSA</code>	4	Detects the falling-edge input triggers and automatically latches and drives the trigger line low.
<code>tsplink.TRIG_SYNCHRONOUS</code>	5	Detects the falling-edge input triggers and automatically latches and drives the trigger line low. Asserts a TTL-low pulse as an output trigger.
<code>tsplink.TRIG_SYNCHRONOUSH</code>	6	Detects rising-edge triggers as an input. Asserts a TTL-low pulse for output.
<code>tsplink.TRIG_RISINGA</code>	7	Detects rising-edge triggers as input. Asserts a TTL-low pulse for output.
<code>tsplink.TRIG_RISINGM</code>	8	Edge detection as an input is not available. Generates a TTL-high pulse as an output trigger.

When programmed to any mode except `tsplink.TRIG_BYPASS`, the output state of the I/O line is controlled by the trigger logic, and the user-specified output state of the line is ignored.

When the trigger mode is set to `tsplink.TRIG_RISING`, the user-specified output state of the line is examined. If the output state selected when the mode is changed is high, the actual mode used will be `tsplink.TRIG_RISINGA`. If the output state selected when the mode is changed is low, the actual mode used will be `tsplink.TRIG_RISINGM`.

*mode* stores the trigger mode as a numeric value when the attribute is read.

To control the line state, use the `tsplink.TRIG_BYPASS` mode with the `tsplink.writebit()` and the `tsplink.writeport()` commands.

## Example

```
tsplink.trigger[3].mode = tsplink.TRIG_RISINGM
```

Sets the trigger mode for synchronization line 3 to `tsplink.TRIG_RISINGM`.

**Also see**

[digio.writebit\(\)](#) (on page 7-61)  
[digio.writeport\(\)](#) (on page 7-62)  
[tsplink.trigger\[N\].assert\(\)](#) (on page 7-219)  
[tsplink.trigger\[N\].clear\(\)](#) (on page 7-219)  
[tsplink.trigger\[N\].overrun](#) (on page 7-222)  
[tsplink.trigger\[N\].release\(\)](#) (on page 7-223)  
[tsplink.trigger\[N\].reset\(\)](#) (on page 7-224)  
[tsplink.trigger\[N\].stimulus](#) (on page 7-224)  
[tsplink.trigger\[N\].wait\(\)](#) (on page 7-225)

**tsplink.trigger[N].overrun**

This attribute indicates if the event detector ignored an event while in the detected state.

Type	TSP-Link accessible	Affected by	Where saved	Default value
Attribute (R)	Yes	Instrument reset Recall setup TSP-Link trigger N clear TSP-Link trigger N reset	Not applicable	Not applicable

**Usage**

```
overrun = tsplink.trigger[N].overrun
```

<i>overrun</i>	Trigger overrun state
<i>N</i>	The trigger line (1 to 3)

**Details**

This command indicates whether an event has been ignored because the event detector was already in the detected state when the event occurred.

This is an indication of the state of the event detector built into the synchronization line itself.

It does not indicate if an overrun occurred in any other part of the trigger model, or in any other construct that is monitoring the event. It also is not an indication of an output trigger overrun.

**Example**

```
print(tsplink.trigger[1].overrun)
```

If an event was ignored, displays `true`; if an event was not ignored, displays `false`.

**Also see**

[tsplink.trigger\[N\].assert\(\)](#) (on page 7-219)  
[tsplink.trigger\[N\].clear\(\)](#) (on page 7-219)  
[tsplink.trigger\[N\].mode](#) (on page 7-220)  
[tsplink.trigger\[N\].release\(\)](#) (on page 7-223)  
[tsplink.trigger\[N\].reset\(\)](#) (on page 7-224)  
[tsplink.trigger\[N\].stimulus](#) (on page 7-224)  
[tsplink.trigger\[N\].wait\(\)](#) (on page 7-225)

## tsplink.trigger[N].pulsewidth

This attribute sets the length of time that the trigger line is asserted for output triggers.

Type	TSP-Link accessible	Affected by	Where saved	Default value
Attribute (RW)	Yes	Reset TSP-Link trigger N reset	Create configuration script	10e-6 (10 µs)

### Usage

```
width = tsplink.trigger[N].pulsewidth
tsplink.trigger[N].pulsewidth = width
```

<i>width</i>	The pulse width (in seconds)
<i>N</i>	The trigger line (1 to 3)

### Details

Setting the pulse width to 0 (seconds) asserts the trigger indefinitely.

### Example

```
tsplink.trigger[3].pulsewidth = 20e-6 Sets pulse width for trigger line 3 to 20 µs.
```

### Also see

[tsplink.trigger\[N\].release\(\)](#) (on page 7-223)

## tsplink.trigger[N].release()

This function releases a latched trigger on the given TSP-Link trigger line.

Type	TSP-Link accessible	Affected by	Where saved	Default value
Function	Yes			

### Usage

```
tsplink.trigger[N].release()
```

<i>N</i>	The trigger line (1 to 3)
----------	---------------------------

### Details

Releases a trigger that was asserted with an indefinite pulse width. It also releases a trigger that was latched in response to receiving a synchronous mode trigger.

### Example

```
tsplink.trigger[3].release() Releases trigger line 3.
```

### Also see

[tsplink.trigger\[N\].assert\(\)](#) (on page 7-219)  
[tsplink.trigger\[N\].clear\(\)](#) (on page 7-219)  
[tsplink.trigger\[N\].mode](#) (on page 7-220)  
[tsplink.trigger\[N\].overrun](#) (on page 7-222)  
[tsplink.trigger\[N\].pulsewidth](#) (on page 7-223)  
[tsplink.trigger\[N\].stimulus](#) (on page 7-224)  
[tsplink.trigger\[N\].wait\(\)](#) (on page 7-225)

## tsplink.trigger[N].reset()

This function resets some of the TSP-Link trigger attributes to their factory defaults.

Type	TSP-Link accessible	Affected by	Where saved	Default value
Function	Yes			

### Usage

```
tsplink.trigger[N].reset()
```

<i>N</i>	The trigger line (1 to 3)
----------	---------------------------

### Details

The `tsplink.trigger[N].reset()` function resets the following attributes to their factory defaults:

- `tsplink.trigger[N].mode`
- `tsplink.trigger[N].stimulus`
- `tsplink.trigger[N].pulsewidth`

This also clears `tsplink.trigger[N].overrun`.

### Example

```
tsplink.trigger[3].reset()
```

Resets TSP-Link trigger line 3 attributes back to factory default values.

### Also see

- [tsplink.trigger\[N\].mode](#) (on page 7-220)
- [tsplink.trigger\[N\].overrun](#) (on page 7-222)
- [tsplink.trigger\[N\].pulsewidth](#) (on page 7-223)
- [tsplink.trigger\[N\].stimulus](#) (on page 7-224)

## tsplink.trigger[N].stimulus

This attribute specifies the event that causes the synchronization line to assert a trigger.

Type	TSP-Link accessible	Affected by	Where saved	Default value
Attribute (RW)	Yes	Reset Recall setup TSP-Link trigger N reset	Create configuration script	0

### Usage

```
eventID = tsplink.trigger[N].stimulus
tsplink.trigger[N].stimulus = eventID
```

<i>eventID</i>	The event identifier for the triggering event
<i>N</i>	The trigger line (1 to 3)

## Details

To disable automatic trigger assertion on the synchronization line, set this attribute to zero (0).

Do not use this attribute when triggering under script control. Use `tsplink.trigger[N].assert()` instead.

The *eventID* parameter may be one of the existing trigger event IDs shown in the following table.

Trigger event IDs	
Trigger event ID	Description
<code>digio.trigger[N].EVENT_ID</code>	An edge (rising, falling, or either based on the configuration of the line) on the digital input line
<code>display.trigger.EVENT_ID</code>	The trigger key on the front panel is pressed
<code>trigger.EVENT_ID</code>	A *trg message on the active command interface. If GPIB is the active command interface, a GET message also generates this event
<code>trigger.blender[N].EVENT_ID</code>	A combination of events has occurred
<code>trigger.timer[N].EVENT_ID</code>	A delay expired
<code>tsplink.trigger[N].EVENT_ID</code>	An edge (rising, falling, or either based on the configuration of the line) on the TSP-Link <sup>®</sup> trigger line
<code>lan.trigger[N].EVENT_ID</code>	A LAN trigger event has occurred
<code>scan.trigger.EVENT_SCAN_READY</code>	Scan ready event
<code>scan.trigger.EVENT_SCAN_START</code>	Scan start event
<code>scan.trigger.EVENT_CHANNEL_READY</code>	Channel ready event
<code>scan.trigger.EVENT_SCAN_COMP</code>	Scan complete event
<code>scan.trigger.EVENT_IDLE</code>	Idle event

## Example

```
print(tsplink.trigger[3].stimulus)
```

Prints the event that will start TSP-Link trigger line 3 action.

## Also see

[tsplink.trigger\[N\].assert\(\)](#) (on page 7-219)

[tsplink.trigger\[N\].reset\(\)](#) (on page 7-224)

## tsplink.trigger[N].wait()

This function waits for a trigger.

Type	TSP-Link accessible	Affected by	Where saved	Default value
Function	Yes			

## Usage

```
triggered = tsplink.trigger[N].wait(timeout)
```

<i>triggered</i>	Trigger detection indication; set to one of the following values: true: A trigger is detected during the timeout period false: A trigger is not detected during the timeout period
<i>N</i>	The trigger line (1 to 3)
<i>timeout</i>	The timeout value in seconds



## Details

This function waits up to the timeout value for an input trigger. If one or more trigger events were detected since the last time `tsplink.trigger[N].wait()` or `tsplink.trigger[N].clear()` was called, this function returns immediately.

After waiting for a trigger with this function, the event detector is automatically reset and rearmed. This is true regardless of the number of events detected.

## Example

```
triggered = tsplink.trigger[3].wait(10)
print(triggered)
```

Waits up to 10 seconds for a trigger on TSP-Link<sup>®</sup> line 3. If `false` is returned, no trigger was detected during the 10-second timeout. If `true` is returned, a trigger was detected.

## Also see

[tsplink.trigger\[N\].clear\(\)](#) (on page 7-219)

## tsplink.writebit()

This function sets a TSP-Link synchronization line high or low.

Type	TSP-Link accessible	Affected by	Where saved	Default value
Function	Yes			

## Usage

```
tsplink.writebit(N, data)
```

<i>N</i>	The trigger line (1 to 3)
<i>data</i>	The value to write to the bit: <ul style="list-style-type: none"> <li>Low: 0</li> <li>High: 1</li> </ul>

## Details

Use `tsplink.writebit()` and `tsplink.writeport()` to control the output state of the trigger line when trigger operation is set to `tsplink.TRIG_BYPASS`.

If the output line is write-protected by the `tsplink.writeprotect` attribute, this command is ignored.

The reset function does not affect the present states of the TSP-Link trigger lines.

## Example

```
tsplink.writebit(3, 0)      Sets trigger line 3 low (0).
```

## Also see

[tsplink.readbit\(\)](#) (on page 7-216)  
[tsplink.readport\(\)](#) (on page 7-216)  
[tsplink.writeport\(\)](#) (on page 7-227)  
[tsplink.writeprotect](#) (on page 7-227)

## tsplink.writeport()

This function writes to all TSP-Link synchronization lines.

Type	TSP-Link accessible	Affected by	Where saved	Default value
Function	Yes			

### Usage

```
tsplink.writeport(data)
```

<i>data</i>	Value to write to the port (0 to 7)
-------------	-------------------------------------

### Details

The binary representation of *data* indicates the output pattern that is written to the I/O port. For example, a *data* value of 2 has a binary equivalent of 010. Line 2 is set high (1), and the other two lines are set low (0).

Write-protected lines are not changed.

Use the `tsplink.writebit()` and `tsplink.writeport()` commands to control the output state of the synchronization line when trigger operation is set to `tsplink.TRIG_BYPASS`.

The `reset()` function does not affect the present states of the trigger lines.

### Example

<code>tsplink.writeport(3)</code>	Sets the synchronization lines 1 and 2 high (binary 011).
-----------------------------------	---

### Also see

[tsplink.readbit\(\)](#) (on page 7-216)  
[tsplink.writebit\(\)](#) (on page 7-226)  
[tsplink.writeprotect](#) (on page 7-227)

## tsplink.writeprotect

This attribute contains the write-protect mask that protects bits from changes by the `tsplink.writebit()` and `tsplink.writeport()` functions.

Type	TSP-Link accessible	Affected by	Where saved	Default value
Attribute (RW)	Yes	Instrument reset Recall setup	Create configuration script	0

### Usage

```
mask = tsplink.writeprotect  
tsplink.writeprotect = mask
```

<i>mask</i>	An integer that specifies the value of the bit pattern for write-protect; set bits to 1 to write-protect the corresponding TSP-Link trigger line
-------------	--

### Details

The binary equivalent of *mask* indicates the mask to be set for the TSP-Link trigger line. For example, a *mask* value of 5 has a binary equivalent of 101. This *mask* write-protects TSP-Link trigger lines 1 and 3.

**Example**

```
tspnet.writeprotect = 5
```

Write-protects TSP-Link trigger lines 1 and 3.

**Also see**

[tspnet.readbit\(\)](#) (on page 7-216)

[tspnet.readport\(\)](#) (on page 7-216)

[tspnet.writebit\(\)](#) (on page 7-226)

[tspnet.writeport\(\)](#) (on page 7-227)

**tspnet.clear()**

This function clears any pending output data from the instrument.

Type	TSP-Link accessible	Affected by	Where saved	Default value
Function	No			

**Usage**

```
tspnet.clear(connectionID)
```

```
connectionID
```

The connection ID returned from `tspnet.connect()`

**Details**

This function clears any pending output data from the device. No data is returned to the caller and no data is processed.

**Example**

```
tspnet.write(testdevice, "print([[hello]])")
print(tspnet.readavailable(testdevice))
```

Write data to a device, then print how much is available.

Output:  
6.0000000e+00

```
tspnet.clear(testdevice)
print(tspnet.readavailable(testdevice))
```

Clear data and print how much data is available again.

Output:  
0.0000000e+00

**Also see**

[tspnet.connect\(\)](#) (on page 7-229)

[tspnet.readavailable\(\)](#) (on page 7-233)

[tspnet.write\(\)](#) (on page 7-239)

## tspnet.connect()

This function establishes a network connection with another LAN instrument or device through the LAN interface.

Type	TSP-Link accessible	Affected by	Where saved	Default value
Function	No			

### Usage

```
connectionID = tspnet.connect(ipAddress)
connectionID = tspnet.connect(ipAddress, portNumber, initString)
```

<i>connectionID</i>	The connection ID to be used as a handle in all other <code>tspnet</code> function calls
<i>ipAddress</i>	IP address to which to connect in a string
<i>portNumber</i>	Port number (default 5025)
<i>initString</i>	Initialization string to send to <i>ipAddress</i>

### Details

This command connects a device to another device through the LAN interface. If the *portNumber* is 23, the interface uses the Telnet protocol and sets appropriate termination characters to communicate with the device.

If a *portNumber* and *initString* are provided, it is assumed that the remote device is not TSP-enabled. The Model 707B or 708B does not perform any extra processing, prompt handling, error handling, or sending of commands. In addition, the `tspnet.tsp.*` commands cannot be used on devices that are not TSP-enabled.

If neither a *portNumber* nor an *initString* is provided, the remote device is assumed to be a Keithley Instruments TSP-enabled device. Depending on the state of the `tspnet.tsp.abortonconnect` attribute, the Model 707B or 708B sends an `abort` command to the remote device on connection.

The Model 707B or 708B also enables TSP prompts on the remote device and error management. The Model 707B or 708B places remote errors from the TSP-enabled device in its own error queue and prefaces these errors with `Remote Error`, followed by an error description.

Do not manually change either the prompt functionality (`localnode.prompts`) or show errors by changing `localnode.showerrors` on the remote TSP-enabled device. If you do this, subsequent `tspnet.tsp.*` commands using the connection may fail.

You can simultaneously connect to a maximum of 32 remote devices.

### Example 1

<pre>instrumentID = tspnet.connect("192.0.2.1") if instrumentID then   -- Use instrumentID as needed here   tspnet.disconnect(instrumentID) end</pre>	Connect to a TSP-enabled device.
---	----------------------------------

**Example 2**

<pre>instrumentID = tspnet.connect("192.0.2.1", 1394, "*rst\r\n") if instrumentID then   -- Use instrumentID as needed here   tspnet.disconnect(instrumentID) end</pre>	Connect to a device that is not TSP-enabled.
---	--

**Also see**

[localnode.prompts](#) (on page 7-123)  
[localnode.showerrors](#) (on page 7-127)  
[tspnet.tsp.abortonconnect](#) (on page 7-236)  
[tspnet.disconnect\(\)](#) (on page 7-230)

**tspnet.disconnect()**

This function disconnects a specified TSP-Net session.

Type	TSP-Link accessible	Affected by	Where saved	Default value
Function	No			

**Usage**

```
tspnet.disconnect(connectionID)
```

<i>connectionID</i>	The connection ID returned from <code>tspnet.connect()</code>
---------------------	---

**Details**

This function disconnects the two devices by closing the connection. The *connectionID* is the session handle returned by `tspnet.connect()`.

For TSP-enabled devices, this aborts any remotely running commands or scripts.

**Example**

<pre>testID = tspnet.connect("192.0.2.0") -- Use the connection tspnet.disconnect(testID)</pre>	<p>Create a TSP-Net session.</p> <p>Close the session.</p>
---	--

**Also see**

[tspnet.connect\(\)](#) (on page 7-229)

## tspnet.execute()

This function sends a command string to the remote device.

Type	TSP-Link accessible	Affected by	Where saved	Default value
Function	No			

### Usage

```
tspnet.execute(connectionID, commandString)
value1 = tspnet.execute(connectionID, commandString, formatString)
value1, value2 = tspnet.execute(connectionID, commandString, formatString)
value1, ..., valueN = tspnet.execute(connectionID, commandString, formatString)
```

<i>connectionID</i>	The connection ID returned from <code>tspnet.connect()</code>
<i>commandString</i>	The command to send to the remote device
<i>value1</i>	The first value decoded from the response message
<i>value2</i>	The second value decoded from the response message
<i>valueN</i>	The <i>N</i> th value decoded from the response message; there is one return value for each format specifier in the format string
...	One or more values separated with commas
<i>formatString</i>	Format string for the output

### Details

This command sends a command string to the remote instrument. A termination is added to the command string when it is sent to the remote instrument (`tspnet.termination()`). You can also specify a format string, which causes the command to wait for a response from the remote instrument. The Models 707B and 708B decodes the response message according to the format specified in the format string and returns the message as return values from the function (see `tspnet.read()` for format specifiers).

When this command is sent to a TSP-enabled instrument, the Model 707B or 708B suspends operation until a timeout error is generated or until the instrument responds. The TSP prompt from the remote instrument is read and discarded. The Model 707B or 708B places any remotely generated errors into its error queue. When the optional format string is not specified, this command is equivalent to `tspnet.write()`, except that a termination is automatically added to the end of the command.

### Example 1

```
tspnet.execute(instrumentID, "runScript()")
```

Command the remote device to run a script named `runScript`.

### Example 2

```
tspnet.termination(instrumentID, tspnet.TERM_CRLF)
tspnet.execute(instrumentID, "*idn?")
print("tspnet.execute returns:", tspnet.read(instrumentID))
```

Print the `*idn?` string from the remote device.

### Also see

[tspnet.connect\(\)](#) (on page 7-229)  
[tspnet.read\(\)](#) (on page 7-232)  
[tspnet.termination\(\)](#) (on page 7-234)  
[tspnet.write\(\)](#) (on page 7-239)

## tspnet.idn()

This function retrieves the response of the remote device to \*IDN?.

Type	TSP-Link accessible	Affected by	Where saved	Default value
Function	No			

### Usage

```
idnString = tspnet.idn(connectionID)
```

<i>idnString</i>	The returned *IDN? string
<i>connectionID</i>	The connection ID returned from <code>tspnet.connect()</code>

### Details

This function retrieves the response of the remote device to \*IDN?.

### Example

```
deviceID = tspnet.connect("192.0.2.1")
print(tspnet.idn(deviceID))
tspnet.disconnect(deviceID)
```

Assume the instrument is at IP address 192.0.2.1. The output that is produced when you connect to the instrument and read the IDN string may appear as:  
KEITHLEY INSTRUMENTS INC.,MODEL  
707B,00000170,01.10h

### Also see

[tspnet.connect\(\)](#) (on page 7-229)

## tspnet.read()

This function reads data from a remote device.

Type	TSP-Link accessible	Affected by	Where saved	Default value
Function	No			

### Usage

```
value1 = tspnet.read(connectionID)
value1 = tspnet.read(connectionID, formatString)
value1, value2 = tspnet.read(connectionID, formatString)
value1, ..., valueN = tspnet.read(connectionID, formatString)
```

<i>value1</i>	The first value decoded from the response message
<i>value2</i>	The second value decoded from the response message
<i>valueN</i>	The nth value decoded from the response message; there is one return value for each format specifier in the format string
...	One or more values separated with commas
<i>connectionID</i>	The connection ID returned from <code>tspnet.connect()</code>
<i>formatString</i>	Format string for the output, maximum of 10 specifiers

## Details

This command reads available data from the remote instrument and returns responses for the specified number of arguments.

The format string can contain the following specifiers:

<code>%[width]s</code>	Read data until the specified length
<code>%[max width]t</code>	Read data until the specified length or until punctuation is found, whichever comes first
<code>%[max width]n</code>	Read data until a newline or carriage return
<code>%d</code>	Read a number (delimited by punctuation)

A maximum of 10 format specifiers can be used for a maximum of 10 return values.

If *formatString* is not provided, the command returns a string that contains the data until a new line is reached. If no data is available, the Model 707B or 708B pauses operation until the requested data is available or until a timeout error is generated. Use `tspnet.timeout` to specify the timeout period.

When the Model 707B or 708B reads from a TSP-enabled remote instrument, the Model 707B or 708B removes Test Script Processor (TSP<sup>®</sup>) prompts and places any errors it receives from the remote instrument into its own error queue. The Model 707B or 708B prefaces errors from the remote device with "Remote Error," followed by the error number and error description.

## Example

```
tspnet.write(deviceID, "*idn?\r\n")
```

```
print("write/read returns:", tspnet.read(deviceID))
```

Send the "\*idn?\r\n" message to the instrument connected as deviceID.

Display the response that is read from deviceID (based on the \*idn? message).

## Also see

[tspnet.connect\(\)](#) (on page 7-229)  
[tspnet.readavailable\(\)](#) (on page 7-233)  
[tspnet.timeout](#) (on page 7-235)  
[tspnet.write\(\)](#) (on page 7-239)

## tspnet.readavailable()

This function checks to see if data is available from the remote device.

Type	TSP-Link accessible	Affected by	Where saved	Default value
Function	No			

## Usage

```
bytesAvailable = tspnet.readavailable(connectionID)
```

<i>bytesAvailable</i>	The number of bytes available to be read from the connection
<i>connectionID</i>	The connection ID returned from <code>tspnet.connect()</code>

## Details

This command checks to see if any output data is available from the device. No data is read from the instrument. This allows TSP scripts to continue to run without waiting on a remote command to finish.



**Example**

<pre>ID = tspnet.connect("192.0.2.1") tspnet.write(ID, "*idn?\r\n")  repeat bytes = tspnet.readavailable(ID) until bytes &gt; 0  print(tspnet.read(ID)) tspnet.disconnect(ID)</pre>	<p>Send commands that will create data.</p> <p>Wait for data to be available.</p>
---	---

**Also see**

[tspnet.connect\(\)](#) (on page 7-229)

[tspnet.read\(\)](#) (on page 7-232)

**tspnet.reset()**

This function disconnects all TSP-Net sessions.

Type	TSP-Link accessible	Affected by	Where saved	Default value
Function	No			

**Usage**

```
tspnet.reset()
```

**Details**

This command disconnects all remote instruments connected through TSP-Net. For TSP-enabled devices, this causes any commands or scripts running remotely to be terminated.

**Also see**

None

**tspnet.termination()**

This function sets the device line termination sequence.

Type	TSP-Link accessible	Affected by	Where saved	Default value
Function	No			

**Usage**

```
type = tspnet.termination(connectionID)
type = tspnet.termination(connectionID, termSequence)
```

<i>type</i>	An enumerated value indicating the termination type: <ul style="list-style-type: none"> <li>1 or <code>tspnet.TERM_LF</code></li> <li>4 or <code>tspnet.TERM_CR</code></li> <li>2 or <code>tspnet.TERM_CRLF</code></li> <li>3 or <code>tspnet.TERM_LFCR</code></li> </ul>
<i>connectionID</i>	The connection ID returned from <code>tspnet.connect()</code>
<i>termSequence</i>	The termination sequence

## Details

This function sets and gets the termination character sequence that is used to indicate the end of a line for a TSP-Net connection.

Using the *termSequence* parameter sets the termination sequence. The present termination sequence is always returned.

For the *termSequence* parameter, use the same values listed in the table above for type. There are four possible combinations, all of which are made up of line feeds (LF or 0x10) and carriage returns (CR or 0x13). For TSP-enabled devices, the default is `tspnet.TERM_LF`. For devices that are not TSP-enabled, the default is `tspnet.TERM_CRLF`.

## Example

```
deviceID = tspnet.connect("192.0.2.1")
if deviceID then
    tspnet.termination(deviceID, tspnet.TERM_LF)
end
```

Sets termination type for IP address 192.0.2.1 to TERM\_LF.

## Also see

[tspnet.connect\(\)](#) (on page 7-229)  
[tspnet.disconnect\(\)](#) (on page 7-230)

## tspnet.timeout

This attribute sets the timeout value for the `tspnet.connect()`, `tspnet.execute()`, and `tspnet.read()` commands.

Type	TSP-Link accessible	Affected by	Where saved	Default value
Attribute (RW)	No	Instrument reset Recall setup	Create configuration script Save setup	20.0 (20 s)

## Usage

```
value = tspnet.timeout
tspnet.timeout = value
```

<i>value</i>	The timeout duration in seconds (0.001 to 30.0 s)
--------------	---

## Details

This attribute sets the amount of time the `tspnet.connect()`, `tspnet.execute()`, and `tspnet.read()` commands will wait for a response.

The time is specified in seconds. The timeout may be specified to millisecond resolution, but is only accurate to the nearest 10 ms.

## Example

```
tspnet.timeout = 2.0
```

Sets the timeout duration to 2 s.

## Also see

[tspnet.connect\(\)](#) (on page 7-229)  
[tspnet.execute\(\)](#) (on page 7-231)  
[tspnet.read\(\)](#) (on page 7-232)

## tspnet.tsp.abort()

This function causes the TSP-enabled instrument to stop executing any of the commands that were sent to it.

Type	TSP-Link accessible	Affected by	Where saved	Default value
Function	No			

### Usage

```
tspnet.tsp.abort(connectionID)
```

<i>connectionID</i>	Integer value used as a handle for other <code>tspnet</code> commands
---------------------	---

### Details

This function is appropriate only for TSP-enabled instruments.  
Sends an abort command to the remote instrument.

### Example

<code>tspnet.tsp.abort(testConnection)</code>	Stops remote instrument execution on <code>testConnection</code> .
---	--

### Also see

None

## tspnet.tsp.abortonconnect

This attribute contains the setting for abort on connect to a TSP-enabled instrument.

Type	TSP-Link accessible	Affected by	Where saved	Default value
Attribute (RW)	No	Instrument reset Recall setup	Create configuration script	1 (enable)

### Usage

```
tspnet.tsp.abortonconnect = value
value = tspnet.tsp.abortonconnect
```

<i>value</i>	<ul style="list-style-type: none"> <li>• Enable: 1</li> <li>• Disable: 0</li> </ul>
--------------	---

## Details

This setting determines if the instrument sends an abort message when it attempts to connect to a TSP-enabled instrument using the `tspnet.connect()` function.

When you send the abort command on an interface, it causes any other active interface on that instrument to close. If you do not send an abort command (or if `tspnet.tsp.abortonconnect` is set to 0) and another interface is active, connecting to a TSP-enabled remote instrument results in a connection. However, the instrument will not respond to subsequent reads or executes because control of the instrument is not obtained until an abort command has been sent.

## Example

```
tspnet.tsp.abortonconnect = 0
```

Configure the instrument so that it does not send an abort command when connecting to a TSP-enabled instrument.

## Also see

[tspnet.connect\(\)](#) (on page 7-229)

## tspnet.tsp.rhtablecopy()

This function copies a reading buffer synchronous table from a remote instrument to a TSP-enabled instrument.

Type	TSP-Link accessible	Affected by	Where saved	Default value
Function	No			

## Usage

```
table = tspnet.tsp.rhtablecopy(connectionID, name)
table = tspnet.tsp.rhtablecopy(connectionID, name, startIndex, endIndex)
```

<i>table</i>	A copy of the synchronous table or a string
<i>connectionID</i>	Integer value used as a handle for other <code>tspnet</code> commands
<i>name</i>	The full name of the reading buffer name and synchronous table to copy
<i>startIndex</i>	Integer start value
<i>endIndex</i>	Integer end value

## Details

This function is only appropriate for TSP-enabled instruments.

This function reads the data from a reading buffer on a remote instrument and returns an array of numbers or a string representing the data. The *startIndex* and *endIndex* parameters specify the portion of the reading buffer to read. If no index is specified, the entire buffer is copied.

The function returns a table if the table is an array of numbers; otherwise a comma-delimited string is returned.

This command is limited to transferring 50,000 readings at a time.

## Example 1

```
t =
    tspnet.tsp.rhtablecopy(testConnection,
        "testRemotebuffername.readings", 1, 3)
print(t[1], t[2], t[3])
```

Copies the specified readings table for buffer items 1 through 3, then displays the first three readings. Example output:

```
4.5653423423e-1
4.5267523423e-1
4.5753543423e-1
```

**Example 2**

```
times =
    tspnet.tsp.rhtablecopy(testTspdevice,
        "testRemotebuffername.timestamps", 1, 3)
print(times)
```

Copy the specified timestamps table for items 1 through 3, then display the table. Example output:

```
01/01/2011
    10:10:10.0000013,01/01/2011
    10:10:10.0000233,01/01/2011
    10:10:10.0000576
```

**Also see**

None

**tspnet.tsp.runscript()**

This function loads and runs a script on a remote TSP-enabled instrument.

Type	TSP-Link accessible	Affected by	Where saved	Default value
Function	Yes			

**Usage**

```
tspnet.tsp.runscript(connectionID, script)
tspnet.tsp.runscript(connectionID, name, script)
```

<i>connectionID</i>	Integer value used as an identifier for other <code>tspnet</code> commands
<i>name</i>	The name that is assigned to the script
<i>script</i>	The body of the script as a string

**Details**

This function is appropriate only for TSP-enabled instruments.

This function downloads a script to a remote instrument and runs it. It automatically adds the appropriate `loadscript` and `endscript` commands around the script, captures any errors, and reads back any prompts. No additional substitutions are done on the text.

The script is automatically loaded, compiled, and run.

Any output from previous commands is discarded.

This command does not wait for the script to complete.

If you do not want the script to do anything immediately, make sure the script only defines functions for later use. Use the `tspnet.execute()` function to execute those functions at a later time.

If no name is specified, the script is loaded as the anonymous script.

**Example**

```
tspnet.tsp.runscript(myconnection, "mytest",
    "print([[start]]) for d = 1, 10 do print([[work]]) end print([[end]])")
```

Load and run a script entitled `mytest` on the TSP-enabled instrument connected with `myconnection`.

**Also see**

[tspnet.execute\(\)](#) (on page 7-231)

## tspnet.write()

This function writes a string to the remote instrument.

Type	TSP-Link accessible	Affected by	Where saved	Default value
Function	No			

### Usage

```
tspnet.write(connectionID, inputString)
```

<i>connectionID</i>	The connection ID returned from <code>tspnet.connect()</code>
<i>inputString</i>	The string to be written

### Details

The `tspnet.write()` function sends *inputString* to the remote instrument. It does not wait for command completion on the remote instrument.

The Model 707B or 708B sends *inputString* to the remote instrument exactly as indicated. The *inputString* must contain any necessary new lines, termination, or other syntax elements needed to complete properly.

Because `tspnet.write()` does not process output from the remote instrument, do not send commands that generate too much output without processing the output. This command can stop executing if there is too much unprocessed output from previous commands.

### Example

```
tspnet.write(myID, "runscript()\r\n")
```

Commands the remote instrument to execute a command or script named `runscript()` on a remote device identified in the system as `myID`.

### Also see

[tspnet.connect\(\)](#) (on page 7-229)

[tspnet.read\(\)](#) (on page 7-232)

## userstring.add()

This function adds a user-defined string to nonvolatile memory.

Type	TSP-Link accessible	Affected by	Where saved	Default value
Function	No			

### Usage

```
userstring.add(name, value)
```

<i>name</i>	The name of the string; the key of the key-value pair
<i>value</i>	The string to associate with <i>name</i> ; the value of the key-value pair

## Details

This function associates the string *value* with the string *name* and stores this key-value pair in nonvolatile memory.

Use the `userstring.get()` function to retrieve the *value* associated with the specified *name*.

You can use the `userstring` functions to store custom, instrument-specific information in the instrument, such as department number, asset number, or manufacturing plant location.

## Example

```
userstring.add("assetnumber", "236")
userstring.add("product", "Widgets")
userstring.add("contact", "John Doe")
for name in userstring.catalog() do
  print(name .. " = " ..
        userstring.get(name))
end
```

Stores user-defined strings in nonvolatile memory and recalls them from the instrument using a for loop.

## Also see

[userstring.catalog\(\)](#) (on page 7-240)

[userstring.delete\(\)](#) (on page 7-241)

[userstring.get\(\)](#) (on page 7-242)

---

# userstring.catalog()

This function creates an iterator for the user-defined string catalog.

Type	TSP-Link accessible	Affected by	Where saved	Default value
Function	No			

## Usage

```
for name in userstring.catalog() do body end
```

<i>name</i>	The name of the string; the key of the key-value pair
<i>body</i>	Code to execute in the body of the for loop

## Details

The catalog provides access for user-defined string pairs, allowing you to manipulate all the key-value pairs in nonvolatile memory. The entries are enumerated in no particular order.

## Example 1

```
for name in userstring.catalog() do
  userstring.delete(name)
end
```

Deletes all user-defined strings in nonvolatile memory.

**Example 2**

```

for name in userstring.catalog() do
  print(name .. " = " ..
        userstring.get(name))
end

```

Prints all `userstring` key-value pairs.

**Output:**

```

product = Widgets
assetnumber = 236
contact = John Doe

```

The above output lists the user-defined strings added in the example for the `userstring.add()` function. Notice the key-value pairs are not listed in the order they were added.

**Also see**

[userstring.add\(\)](#) (on page 7-239)  
[userstring.delete\(\)](#) (on page 7-241)  
[userstring.get\(\)](#) (on page 7-242)

**userstring.delete()**

This function deletes a user-defined string from nonvolatile memory.

Type	TSP-Link accessible	Affected by	Where saved	Default value
Function	No			

**Usage**

```
userstring.delete(name)
```

<i>name</i>	The name (key) of the key-value pair of the user-defined string to delete
-------------	---

**Details**

This function deletes the string that is associated with *name* from nonvolatile memory.

**Example**

```

userstring.delete("assetnumber")
userstring.delete("product")
userstring.delete("contact")

```

Deletes the user-defined strings associated with the `assetnumber`, `product`, and `contact` names.

**Also see**

[userstring.add\(\)](#) (on page 7-239)  
[userstring.catalog\(\)](#) (on page 7-240)  
[userstring.get\(\)](#) (on page 7-242)



---

## userstring.get()

This function retrieves a user-defined string from nonvolatile memory.

Type	TSP-Link accessible	Affected by	Where saved	Default value
Function	No			

### Usage

```
value = userstring.get(name)
```

<i>value</i>	The value of the user-defined string key-value pair
<i>name</i>	The name (key) of the user-defined string

### Details

This function retrieves the string that is associated with *name* from nonvolatile memory.

### Example

```
value = userstring.get("assetnumber")
print(value)
```

Read the value associated with a user-defined string named "assetnumber". Store it in a variable called *value*, then print the variable value.  
Output:  
236

### Also see

[userstring.add\(\)](#) (on page 7-239)  
[userstring.catalog\(\)](#) (on page 7-240)  
[userstring.delete\(\)](#) (on page 7-241)

---

## waitcomplete()

This function waits for all overlapped commands to complete.

Type	TSP-Link accessible	Affected by	Where saved	Default value
Function	No			

### Usage

```
waitcomplete()
waitcomplete(group)
```

<i>group</i>	Specifies which TSP-Link group on which to wait
--------------	---

---

**Details**

---

This function will wait for all previously started overlapped commands to complete.

Currently, the Models 707B and 708B have no overlapped commands implemented. However, other TSP-enabled products, such as the Series 2600A System SourceMeter<sup>®</sup> Instruments, have overlapped commands. Therefore, when the Model 707B or 708B is a TSP master to a subordinate device with overlapped commands, use this function to wait until all overlapped operations are completed.

A group number may only be specified when this node is the master node.

If no *group* is specified, the local group is used.

If zero (0) is specified for the *group*, this function waits for all nodes in the system.

**NOTE**

Any nodes that are not assigned to a group (group number is 0) are part of the master node's group.

---

**Example 1**

---

<code>waitcomplete()</code>	Waits for all nodes in the local group.
-----------------------------	---

---

**Example 2**

---

<code>waitcomplete(G)</code>	Waits for all nodes in group G.
------------------------------	---------------------------------

---

**Example 3**

---

<code>waitcomplete(0)</code>	Waits for all nodes on the TSP-Link network.
------------------------------	--

---

**Also see**

---

None



---

## Troubleshooting guide

### In this section:

---

Troubleshooting guide.....	8-1
Error and status messages .....	8-1
USB troubleshooting .....	8-2
Troubleshooting GPIB interfaces .....	8-5
Troubleshooting LAN interfaces .....	8-5
Testing the display, keys, and channel matrix.....	8-9
Update drivers.....	8-10
Contacting support.....	8-10

## Troubleshooting guide

This section provides information to help you troubleshoot problems with your instrument.

## Error and status messages

This section includes information on error levels and how to read errors.

### Error summary

Error and status messages are assigned a level of severity, as listed in the table below.

Severity level descriptions		
Number	Level	Description
0	<b>Informational</b>	Indicates that there are no entries in the queue
10	<b>Informational</b>	Indicates a status message or minor error
20	<b>Recoverable</b>	Indicates possible invalid user input; operation continues but action should be taken to correct the error
30	<b>Serious</b>	Indicates a serious error that may require technical assistance, such as corrupted data
40	<b>Fatal</b>	Instrument is not operational

## Effects of errors on scripts

Most errors will not abort a running script. The only time a script is aborted is when a Lua runtime error (error number –286) is detected.

Runtime errors are caused by actions such as trying to index into a variable that is not a table.

Syntax errors (error number -285) in a script or command will not abort the script, but will prevent the script or command from being executed.

## Retrieving errors

When errors occur, the error messages are placed in the error queue. Use error queue commands to request error message information. For example, the following commands request the next complete error information from the error queue and return the code, message, severity, and node for that error:

```
errorCode, message, severity, errorNode = errorqueue.next()
print(errorCode, message, severity, errorNode)
```

The following table lists the commands associated with the error queue.

Remote commands associated with the error queue	
Command	Description
<a href="#">errorqueue.clear()</a> (on page 7-82)	Clear error queue of all errors
<a href="#">errorqueue.count</a> (on page 7-83)	Number of messages in the error queue
<a href="#">errorqueue.next()</a> (on page 7-83)	Request next error message from queue

## USB troubleshooting

This section provides information checks you can perform if the USB communication with the instrument is not working.

### Check driver for the USB Test and Measurement Device

1. Open Device Manager.



#### Quick Tip

From the Start menu, you can enter `Devmgmt.msc` in the Run box or the Windows 7 search box to start Device Manager.

2. Under USB Test and Measurement Devices, look for USB Test and Measurement Device.

If the device is not there, either VISA is not installed or the instrument is not plugged in and switched on.

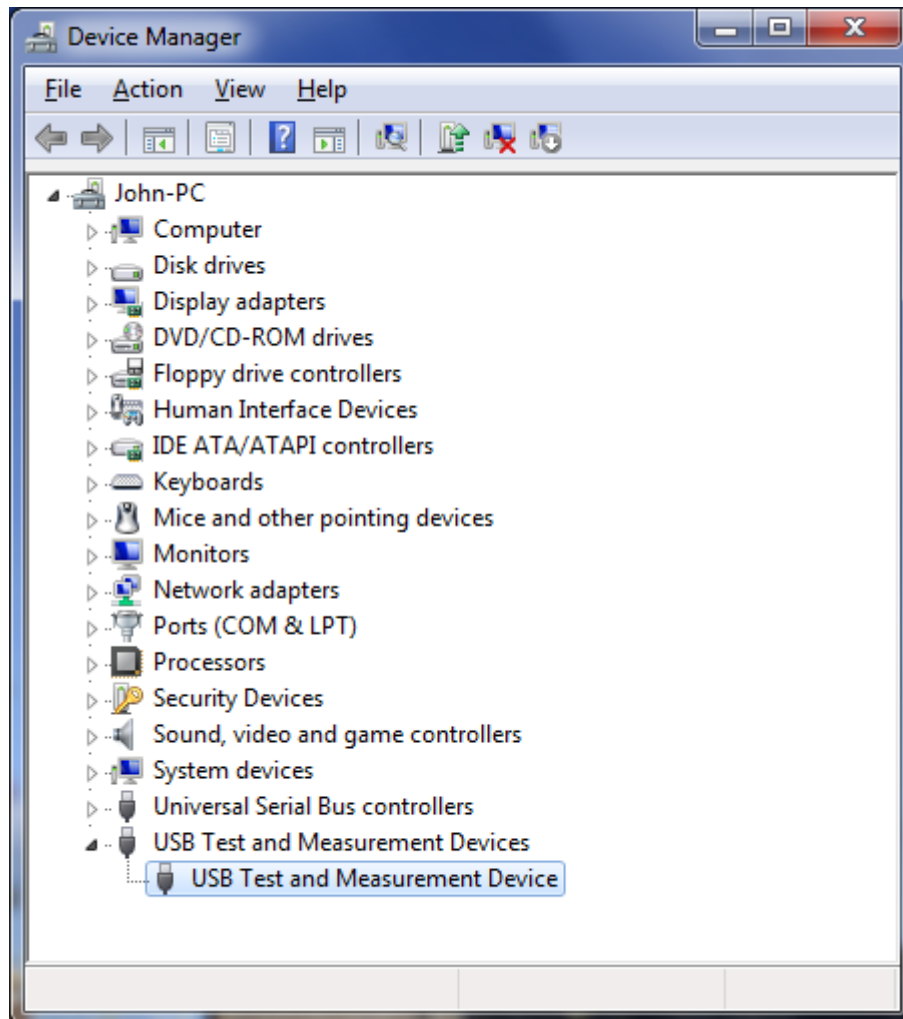
**Figure 96: Device Manager dialog box showing USB Test and Measurement Device**

3. Right-click the device.
4. Select Properties.
5. Select the Driver tab.
6. Click **Driver Details**.
7. Verify that the device driver is the winusb.sys. driver from Microsoft.

Figure 97: Driver File Details dialog box

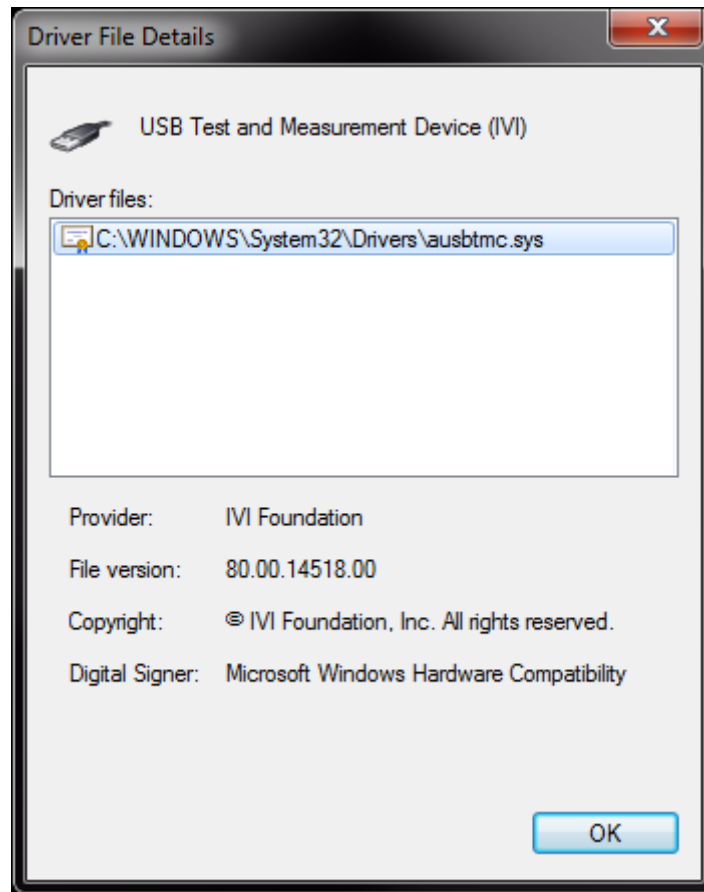

8. If the incorrect driver is installed, click **OK**.
9. On the Driver tab, click **Update Driver**.
10. Browse for the driver; select the `C:\windows\inf` folder. Locate the `winusb.inf` file. Select this and make sure the driver is now in use.
11. If this does not work, uninstall VISA, unplug the instrument and follow the steps to reinstall VISA in the section [Modifying, repairing, or removing Keithley I/O Layer software](#) (on page 2-61).

## Troubleshooting GPIB interfaces

### Controller (hardware) not recognized

If the hardware is not recognized by the computer:

1. Uninstall the software drivers.
2. Reboot the computer.
3. Check for newer drivers on the vendor's website. Check that the drivers are valid for the operating system you have and any updates that might be necessary. This information is typically found in the readme file that comes with the drivers.
4. Install software drivers.
5. Reboot the computer.
6. Plug in the hardware.

If it is still not recognized, you can try a different computer using a different operating system to rule out operating system issues.

If this does not resolve the issue, contact the vendor of the GPIB controller for assistance.

### Timeout errors

If your GPIB controller is recognized by the operating system, but you get a timeout error when you try to communicate with the instrument, check the following:

1. Confirm that the GPIB address you assigned to the instrument is unique and between the range of 0 to 30. It should not be 0 or 21 because they are common controller addresses.
2. Check cabling connection. GPIB cables are heavy and can fall out of the connectors if they are not screwed in securely.
3. Substitute cables to verify cable integrity. For example, if you can send and receive ASCII text, but you cannot do a binary transfer, check your program and the decoding of the binary data. If that does not resolve the problem, try another cable. ASCII text only uses seven data lines in the cable; the binary transfer requires all eight lines.

## Troubleshooting LAN interfaces

This section provides information on troubleshooting LAN interfaces.

For detailed information on setting up remote interfaces see [Remote communications interfaces](#) (on page 4-4).



## Verify connections and settings

If you are unable to connect to the instrument's internal web page, check the following items:

- Verify that the crossover cable is in the correct LAN port on the instrument. Do not connect to one of the TSP-Link ports.
- Verify that the crossover cable is in the correct port on the computer. The Ethernet port of a laptop may be disabled while the computer is in a docking station.
- Verify that the correct Ethernet card configuration information was used during the setup procedure.
- Verify that the computer's network card is enabled.
- Verify the instrument IP address is compatible with the IP address on the computer.
- Verify the instrument subnet mask address is the same as the computer's subnet mask address.
- Turn the instrument power off, and then on.
- Reboot the computer.

## Use Ping to test the connection

Ping is a computer network administration utility that you can use to test whether a particular host can be reached across an Internet Protocol (IP) network. It also measures the round-trip time for packets sent from the local host to a destination computer, including the local host's own interfaces.

To run Ping:

1. From the Windows Start menu, type cmd in the Run box or Search box. The Command window is displayed.
2. At the > prompt, type ping followed by the IP address. For example:

```
ping 169.254.52.51
```

Beware that some network devices, especially LXI instruments, can disable the ping response to prevent denial of service attacks. This prevents hackers from pinging your instrument indefinitely, which causes the instrument to become so busy it cannot respond to a web browser or instrument driver.

If you cannot ping an instrument from the computer, you will not be able to communicate with the instrument. You will need to check the LAN settings from the front panel of the instrument to see if they match the configuration of your network.

If you can ping your instrument, you should be able to bring up the web page in the instrument from a browser by typing the IP address in the address (URL) field.

## Open ports on firewalls

A firewall is a part of a computer system or network that is designed to block unauthorized access while permitting authorized communications. It is a device or set of devices that are configured to permit or deny applications based on a set of rules and other criteria.

If you have a firewall in the network between your computer and the instrument, you need to make sure the following ports are opened for UDP and TCP packets:

- Port 80: Web server. This is normally open.
- Port 1024: VXI-11 connection for sending and receiving commands from the instrument.
- Port 5025: Raw socket connection for sending and receiving commands from the instrument.

## Web page problems

All LXI instruments have a web server. The LAN configuration information on these pages is mandated by the LXI consortium. For Keithley's LXI instruments, the standard LXI pages use standard HTML.

The added value pages that Keithley has added to control the instruments use Java. If Java is not installed when you select one of these instrument-specific web pages, the web page prompts you to install it. To do this, your computer must have access to the Internet so it can access the web browser plug-in Sun Java Runtime Environment Version 6 or higher. Installation files are available at the [Java download site](http://www.java.com/en/download/manual.jsp) (<http://www.java.com/en/download/manual.jsp>).

When you connect to the instrument web page for the first time, several things can happen:

- If the security settings are high, scripting might be disabled and the browser will prompt you to enable ActiveX and scripting.
- If Java is not installed, the browser will prompt you to install it and provide a link to the download. If you do not have an Internet connection, you must download it elsewhere and install it on the computer that it connected to the instrument.
- When the Java applet from the instrument gets downloaded into the browser it will ask you if you trust this active content from Keithley Instruments. Select Yes.

If you have resolved the problems, the instrument control pages should work and if you try to perform an action, such as closing a relay, you are prompted for the password (the default is "admin").

### NOTE

If you update the firmware for the instrument using the web page (not available for all instruments), you need to flush the browser cache so that a fresh Java Applet gets downloaded the next time you access the web page.

## LXI LAN status indicator

Most LAN network interface cards have two LEDs, one that indicates LAN traffic and one that designates the LAN speed (10 Mbits, 100 Mbits, 1 Gbits) through the color of the LED. LXI goes one level higher than this and states that all LXI compliant devices need a LAN status indicator. This can be an LED or an indicator on a display. It shows if the instrument has a valid IP address or is in a fault state.

When diagnosing a LAN connection issue with an LXI instrument, see if the LAN status indicator is signaling a valid or fault condition. If there is an error, you cannot communicate with the instrument through the LAN connection. In this case, you need to check the LAN parameter settings from the front panel of the instrument. Make sure if you change a LAN setting through the front panel that you select the “Apply LAN Settings” for the changes to take affect.

## Initialize the LAN configuration

The LXI specification mandates that all instruments that conform to LXI need a LAN reset mechanism. This can be a recessed switch or a menu option on the front panel that will put all the LAN settings back to known defaults. If you cannot communicate with your instrument, perform this reset.

If you perform a reset, the instrument is returned to DHCP and Auto-IP enabled. If you set your computer to match, you should be able to use a discovery tool to determine the IP address and communicate with the instrument again. Also check the LAN status indicator to verify that there are no faults.

To reset the Model 707B or 708B, from the front panel, select **MENU**, then select **LAN > RESET**.

## Install LXI Discovery Browser software on your computer

You can use the LXI Discovery Browser to identify the IP addresses of LXI-certified instruments. Once identified, you can double-click the IP address in the LXI Discovery Browser to open the web interface for the instrument.

The Keithley LXI Discovery Browser is available on the [Keithley Instruments website](http://www.keithley.com) (<http://www.keithley.com>).

*To locate the Keithley LXI Discovery Browser on the Keithley website:*

1. Select the **Support** tab.
2. In the model number box, type 707B.
3. From the list, select **Software** and click the search icon. A list of software applications for the instrument is displayed.
4. See the readme file included with the application for more information.

For more information about the LXI Consortium, see the [LXI Consortium website](http://www.lxistandard.org) (<http://www.lxistandard.org>).

## Communicate using VISA communicator

There are several interactive communication utilities that you can use to communicate with LAN instruments:

- The KIOIOL installs the Keithley Communicator.
- NI VISA (full version) installs the NI VISA Interactive Control utility, which can also be launched from NI-MAX.
- Agilent has a similar utility called Interactive IO that gets installed with their IO Libraries Suite.

All these utilities require you to enter the VISA resource string for your instrument. See [Communicate with the instrument](#) (on page 2-23) for more information on the VISA resource string formats.

HyperTerminal, which comes with Microsoft Windows, also allows you to connect to the raw socket port of the instrument.

## WireShark

WireShark is an open source LAN packet sniffer. You can run it to spy on all the packets going across a network. It allows you to filter what you spy on so that you can narrow the content down to just what you are interested in. For example, you could check just web page packets (http) or all packets being sent by a device on a certain IP address.

Refer to the WireShark documentation for information. WireShark can be downloaded from [www.wireshark.org](http://www.wireshark.org) (<http://www.wireshark.org>).

## Testing the display, keys, and channel matrix

You can test operation of the keys, display, and crosspoint display (707B only) from the front panel of the instrument.

### Verify front panel key operation

You can verify that the instrument is properly reading front panel key presses.

**To verify key operation:**

1. From the front panel, select **MAIN MENU > DISPLAY > TEST > KEYS**. The message "No keys pressed" is displayed.
2. Press a key. The name of the key is displayed. For a list of key values, see [display.sendkey\(\)](#) (on page 7-76).
3. Press **EXIT (LOCAL)** twice to return to the menu.

### Verify display operation

You can verify that all the pixels on the vacuum fluorescent display (VFD) are working.

**To verify VFD operation:**

1. From the front panel, select **MAIN MENU > DISPLAY > TEST > DISPLAY-PATTERNS**. A pattern is displayed.
2. Press the navigation wheel to display the next pattern.
3. When you have viewed the patterns, press **EXIT** to return to the menu.

## Verify crosspoint display operation (707B only)

You can verify that the LEDs and displays on the crosspoint display are working properly.

### *To verify crosspoint display operation:*

1. From the front panel, select **MAIN MENU > DISPLAY > TEST > LED-PATTERNS**. The text "ALPH NUMERIC COL LEDS" is displayed.
2. Press the navigation wheel to display first test. The name of the test is displayed on the bottom display.
3. After each test, press the navigation wheel to move to the next test.
4. On the last tests (STEP COL GRIP LED WHEEL TO DIAL), use the navigation wheel to check the matrix LEDs and the slot LEDs.
5. When you have viewed the patterns, press **EXIT** to return to the menu.

## Update drivers

For the latest drivers and additional support information, see the Keithley Instruments support website.

### *To see what drivers are available for your instrument:*

1. Go to the [Keithley Instruments support website](http://www.keithley.com/support) (<http://www.keithley.com/support>).
2. Enter the model number of your instrument.
3. Select **Software Driver** from the list.

For LabVIEW™, you can also go to the National Instrument website and search their instrument driver database.

## Contacting support

If you have any questions after reviewing this information, please contact your local Keithley Instruments representative or call Keithley Instruments corporate headquarters (toll-free inside the U.S. and Canada only) at 800-935-5595, or from outside the U.S. at +1-440-248-0400. For worldwide contact numbers, visit the [Keithley Instruments website](http://www.keithley.com) <http://www.keithley.com>.

When contacting Keithley, please have ready:

- The serial number of the instrument.
- The firmware revision of the instrument.
- The model and firmware revision of all installed cards.

When you call, have the information available, and, if possible, be near the instrument.

### Locating serial number or firmware revision

The serial number is on the rear panel of the instrument. You can also use the front panel **MENU** option to display the serial number and firmware version.

#### *To display serial number or firmware revision on the front panel:*

1. If the Model 707B or 708B is in remote mode, press the **EXIT (LOCAL)** key once to place the instrument in local mode.
2. Press the **MENU** key.
3. Use the navigation wheel  to scroll to the **UNIT-INFO** menu.
4. Press the **ENTER** key.

On the UNIT INFORMATION menu, scroll to the **SERIAL#** or **FIRMWARE** option and press the **ENTER** key. The Model 707B or 708B serial number is displayed.

### Locating information on the installed cards

#### *To identify installed switching cards from the front panel:*

Press the **SLOT** key to scroll through the model numbers, descriptions, and firmware revisions of the installed switching cards.

#### *To identify installed switching cards from the web interface:*

1. Select the **Unit** page.
2. In the Report area, select the slots that you want information about.
3. Select **Firmware Revision**.
4. Click **Generate Report**. Information about the cards in the slots is displayed below the button.

#### *To identify installed switching cards from the remote command interface:*

Use `print(slot[X].idn)` to query and identify installed switching cards:

```
print(slot[X].idn)
```

Where: *X* = slot number (from 1 to 6)

#### **Example**

To get a list of all switching cards installed in the slots of a Model 707B or 708B, send the following command over the remote command interface:

```
for x=1,6 do print (slot[x].idn) end
```

The response will be similar to the following:

```
7174, 8x12 Fast Low-I Matrix, 01.00a, <Module Serial Number>
7072, 8x12 Semi Matrix, 01.00a, <Module Serial Number>
Empty Slot
Empty Slot
Empty Slot
Empty Slot
```



---

## Frequently asked questions

### In this section:

---

Frequently asked questions ..... 9-1

## Frequently asked questions

### How do I get my LAN or web connection to work?

For troubleshooting suggestions, see [Troubleshooting LAN interfaces](#) (on page 8-5).

For more detailed information on remote interface connections, see [Remote communications interfaces](#) (on page 4-4).

### Why can't I close a channel?

The channel might be set to be forbidden to close.

***To check the forbidden state of a channel from the front panel:***

1. Display a channel (you might need to press **DISPLAY**).
2. Use the navigation wheel  to select the channel you want to check.
3. Press **CONFIG**, then press **CHAN**.
4. Select **FORBID**.
5. Press **ENTER**.
6. **Yes** and **No** are displayed. The current selection blinks. To change the setting to allow the channel to close, select **No**.

***To check the forbidden state of a channel from the web interface:***

1. From the list on the left, select the slot that contains the channel.
2. Right-click the channel. The Channel Configuration dialog box is displayed.



Figure 98: Channel configuration dialog box

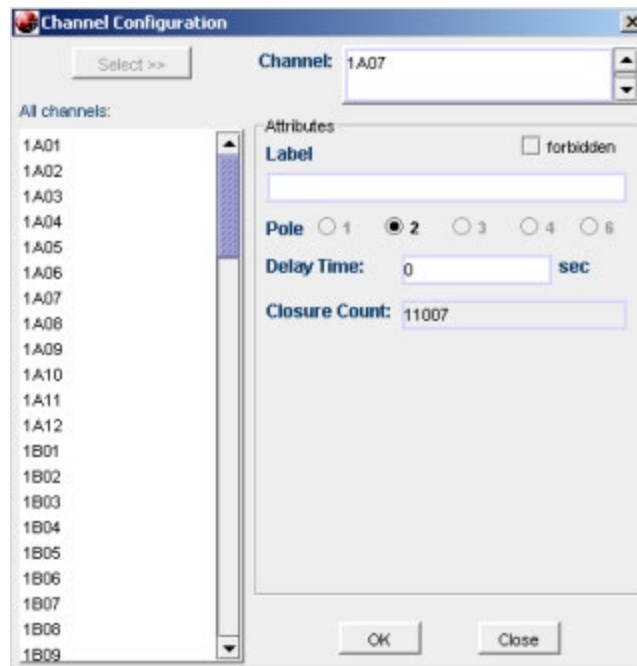

3. If the forbidden box is selected, the channel is forbidden to close. To allow the channel to close, clear the box.
4. Click **OK** to save the change.

**To check the forbidden state of a channel from a remote interface:**

You can also clear, check, and set the forbidden state of channels using the following commands:

- [channel.clearforbidden\(\)](#) (on page 7-16)
- [channel.getforbidden\(\)](#) (on page 7-27)
- [channel.setforbidden\(\)](#) (on page 7-42)

## How do I know if an error has occurred on my instrument?

If you are using TSB Embedded, error messages are displayed in the Instrument Output box when they occur.

If you are using another remote interface, you might need to use commands to retrieve the error messages. You can use the commands [errorqueue.count](#) (on page 7-83) and [errorqueue.next\(\)](#) (on page 7-83) to retrieve the number of messages and the text of the messages.

To set the instrument to automatically send generated errors, set [localnode.showerrors](#) (on page 7-127) to 1 (enabled).

To set the instrument to automatically send prompts after each command message, set [localnode.prompts](#) (on page 7-123) to 1 (enabled).

## How do I find the serial number and firmware version of the instrument?

The serial number is on the rear panel of the instrument. You can also use the front panel **MENU** option to display the serial number and firmware version.

***To display serial number or firmware revision on the front panel:***

1. If the Model 707B or 708B is in remote mode, press the **EXIT (LOCAL)** key once to place the instrument in local mode.
2. Press the **MENU** key.
3. Use the navigation wheel  to scroll to the **UNIT-INFO** menu.
4. Press the **ENTER** key.

On the UNIT INFORMATION menu, scroll to the **SERIAL#** or **FIRMWARE** option and press the **ENTER** key. The Model 707B or 708B serial number is displayed.



**In this section:**

---

[Additional Models 707B and 708B information.....](#) 10-1

## **Additional Models 707B and 708B information**

For additional information about the Model 707B or 708B, refer to:

- The Product Information CD-ROM (ships with the product): Contains software tools, drivers, and product documentation
- The [Keithley Instruments website](http://www.keithley.com) <http://www.keithley.com>: Contains the most up-to-date information. From the website, you can access:
  - The Knowledge Center, which contains the following handbooks:
    - *The Low Level Measurements Handbook: Precision DC Current, Voltage, and Resistance Measurements*
    - *Switching Handbook: A Guide to Signal Switching in Automated Test Systems*
  - Application notes
  - Updated drivers
  - Information about related products, including:
    - Switch cards, including the Models 7072, 7072-HV, 7173-50, and 7174A
    - The Series 2600A System SourceMeter<sup>®</sup> Instruments
    - The Model 4200-SCS Semiconductor Characterization System
- Your local Field Applications Engineer can help you with product selection, configuration, and usage. Check the website for contact information.



---

# Maintenance

## In this appendix:

---

Maintenance.....A-1

## Maintenance

### Upgrading firmware

You can upgrade the instrument firmware from the web interface.

**To upgrade the firmware from the web interface:**

1. From the left navigation area, select **Unit**.
2. Log in if necessary.
3. From the Unit buttons, click **Upgrade Firmware**.
4. A confirmation message is displayed. Click **OK**.
5. A version message is displayed. Select the appropriate option..
6. Select the file.
7. Click **Open**. A progress dialog box is displayed. When the upgrade begins, the front panel display will also display the progress.  
During the upgrade, you will see messages that indicate that the connection has been lost. This is normal.
8. After the instrument power automatically turns off and then turns on again, it will be ready for use.

### NOTE

If you have a GPIB or USB connection, you can also use TSB to upgrade the firmware. See the TSB help files for information.

## Check fan status

You can check the status of the fan from the front panel of the Model 707B.

In addition, if the fan is not operating on power up, the message "Failed to sense fan" is displayed.

### To check the fan status:

1. From the front panel, select **MAIN MENU > UNIT-INFO > FAN**.
2. Press the navigation wheel. The status is displayed:
  - Fan Normal: Fan is operating normally.
  - Fan Failure: Fan is not moving.
3. Press **EXIT** to return to the menu.

If the fan is not operating, contact Keithley Instruments. See [Contacting support](#) (on page 8-10).

## Fuse replacement

The fuses on the Model 707B or 708B are located on the rear panel of the instrument, as shown below.

Replacement fuses are listed in the following table.

Replacement fuses		
Model	Rating	Keithley Instruments part number
707B	250V, dual 2.0A slow blow	Two FU-106-2.0
708B	250V / 1.0A slow blow	One FU-72

### WARNING

*Disconnect all external power from the equipment and the line cord before performing any maintenance on the Model 707B or 708B.*

*Failure to disconnect all power may expose you to hazardous voltages, that, if contacted, could cause personal injury or death. Use appropriate safety precautions when working with hazardous voltages.*

### To replace a fuse:

1. Use a small flat-tip screwdriver to lift the tab at the bottom of the fuse module.
2. Pull the fuse module out.
3. Replace the fuse.
4. Re-install the fuse module.

If the fuse continues to blow, a circuit malfunction exists and must be corrected. Return the instrument to Keithley Instruments for repair. See [Contacting support](#) (on page 8-10).

Figure 99: 707B fuse location

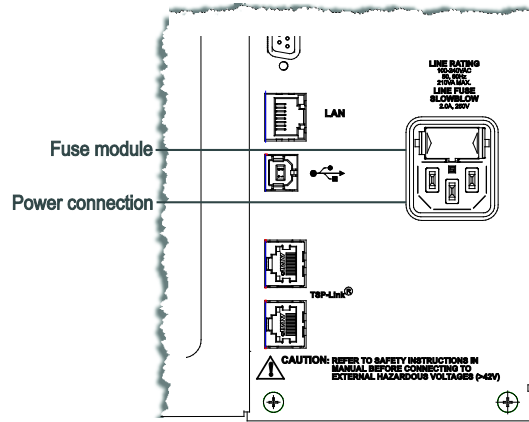
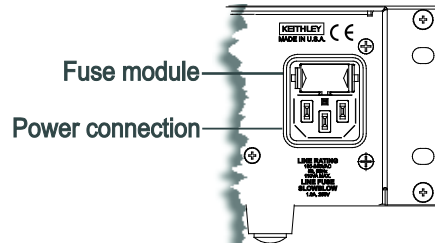

Figure 100: 708B fuse module location





## Fixed rack installation

The Model 707B ships with a fixed rack-mounting kit. The following table lists the included hardware for a fixed mounting of the Model 707B in a 48.26 cm wide × 60.96 cm tall × 76.20 cm deep (19 in. × 24 in. × 30 in.) rack. Verify that you have all the necessary parts before beginning the installation procedure.

### NOTE

The Model 708B ships without a rack-mount kit. To rack mount a Model 708B, contact your local Keithley Instruments office, sales partner, or distributor to order the Model 4299-6 Fixed Rack-Mount Kit. Installation instructions are included with the kit.

#### Parts list for Model 707B rack mounting

Item	Description	Keithley Part Number	Quantity
A	Chassis support (left)	707-321	1
B	Chassis support (right)	707-322	1
C	Nut, #10-32 captive	FA-148	4
	Bracket kit consisting of:	BR-31	1
D	Rear support bracket	--	2
E	Spacer bar	--	2
F	Nut bar	--	4
G	Screw, #10-32 × 1/2 in. Phillips Binder hardware	--	12

## Rack preparation

#### *To prepare the rack for Model 707B installation:*

1. Select a position in the rack. In most cases, the weight of the instrument dictates a position in the lower half of the rack. The Model 707B fills 35.56 cm (14 in.) of vertical space.

### NOTE

The mainframe must be mounted at a height that is an increment of 4.45 cm (1.75 in.) from the top or bottom of the rack. Attempting to mount the mainframe at a nonincremental height will cause difficulties with hole alignment.

- As shown in the following figure, install two captive nuts (item C) on each front rack flange at holes 28.89 cm (11.38 in.) and 33.05 cm (13.13 in.) from the top of the selected space.

**Figure 101: Captive nut installation**

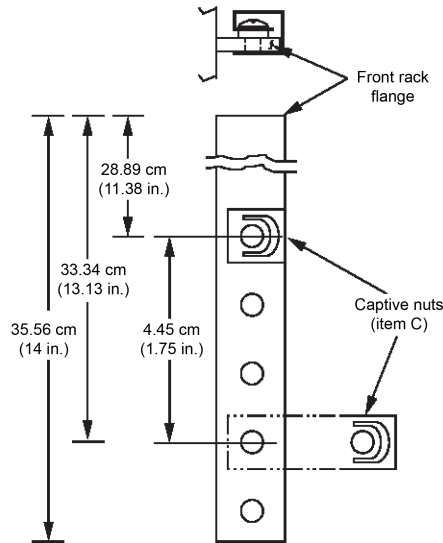

- Loosely attach a nut bar (item F) to each rear rack flange with two binder head screws (item G) (see the following figure). Mount the nut bars with the outer holes at the same level as the captive nuts. Note that the hole pattern on the nut bar is not symmetrical.

**Figure 102: Nut bar on flange**

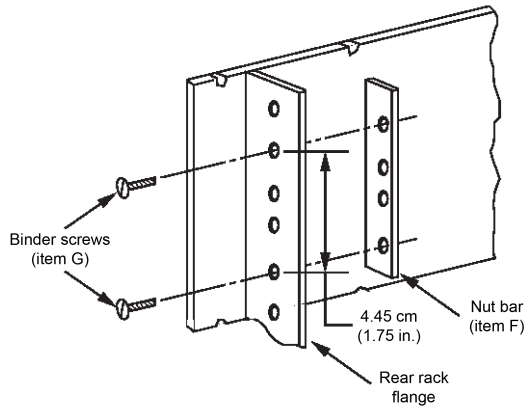

## Chassis support preparation

**To prepare the chassis support for Model 707B or 708B installation:**

1. Place a rear support bracket (item D) on the left chassis support (item A) and temporarily install the two pieces in the rack by sliding them apart until the flanged ends fit as shown in the following figure. Note which holes will be used to attach the two pieces together.

**Figure 103: Chassis support sizing**

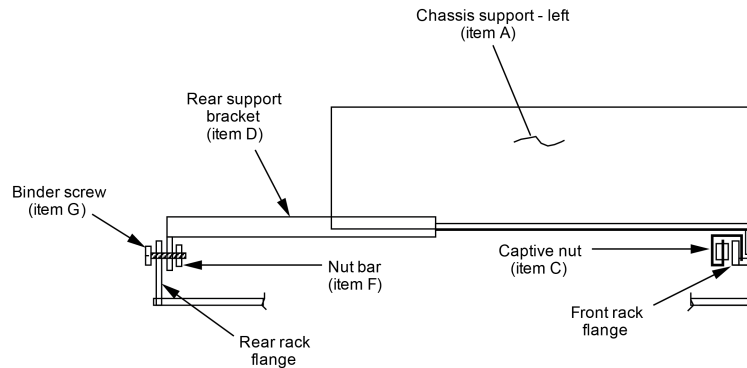

2. Use a spacer bar, nut bar, and two binder head screws (items E, F, and G) to loosely attach each rear support bracket to a chassis support. The following figure shows the left side support.

**Figure 104: Chassis support assembly**

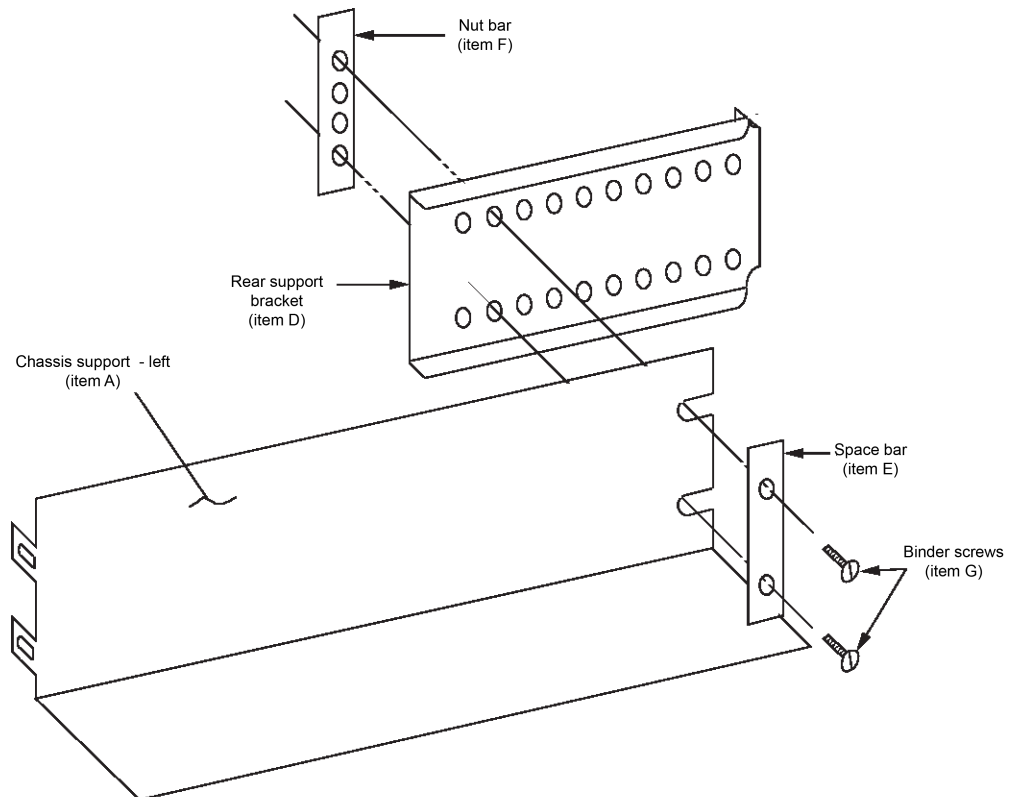

## Chassis support mounting

---

### *To mount the chassis support:*

1. Reinstall the chassis support assemblies in the rack and secure them to the captive nuts with binder head screws. Also tighten the binder screws at the rear rack flange.
2. Tighten the screws attaching the two pieces of the chassis support assemblies.

## Mainframe installation

---

### *To install the mainframe in the rack:*

1. Lift the Model 707B or 708B mainframe onto the chassis supports and slide it into the rack.
2. The mainframe can be secured to the front rack flanges with user-supplied captive nuts and binder head screws (four each).

## NOTE

The chassis supports hold the Model 707B or 708B in place while you are mounting the mainframe to the front rack flanges. Once the instrument is secured, there may be a gap between the mainframe and the chassis supports.



# Using Models 707A and 708A compatibility mode

### In this appendix:

---

[Using Models 707A and 708A compatibility mode .....B-1](#)

## Using Models 707A and 708A compatibility mode

### Model A to Model B differences

You can use a Model 707B or 708B in an existing Model 707A or 708A application. The units are compatible with the following exceptions:

- Master/subordinate operation is not supported.
- The digital I/O is limited to twelve bits for all models.
- Relay test is not supported.
- Some commands operate differently (see [Models 707A and 708A commands](#) (on page B-3)).

When using Model 707A or 708A compatibility mode, the only compatible remote interface is GPIB.

You can select one of two options when enabling Model 707A or 708A DDC compatibility mode:

- **70xA-VERSION:** This option most closely matches Model 707A or 708A operation. Use this version if you are transferring applications directly from a Model 707A or 708A with few changes.
- **70xB-VERSION:** This options provides enhanced operation, including error checking and more robust settling time operation. Use this version if you are updating existing applications.

#### ***To enable Model 707A or 708A DDC compatibility mode:***

1. From the front panel, select **MENU**.
2. Select **DDC**.
3. Select **ENABLE**.
4. Select the version.
5. Press **ENTER**.
6. Cycle instrument power.

### Front-panel relay closure indicators

---

When you are using Model 707A or 708A compatibility mode, the channel information is displayed on the updated display. For information on the display, see [Front-panel operation](#) (on page 2-11).

## NOTE

Models 707B and 708B channel notation is different than on the Models 707A and 708A. For Models 707A and 708A, the slot number is built into the column number. For Models 707B and 708B, the slot number is the first number of the channel notation. For example, in Models 707A and 708A, crosspoint "A56" refers to slot 5, row A, column 8. This same crosspoint appears as "5A08" on the Models 707B and 708B front-panel display. However, with DDC emulation enabled, the Models 707B and 708B will accept "A56" and close the correct crosspoint.

### Timing issues

---

The Models 707B and 708B run much faster than their predecessors. When using code from an older switch model, be aware that timing problems could be introduced into the system.

### Digital interface

---

When you are using Model 707A or 708A compatibility mode, the digital I/O is fixed as follows:

- Digital input: Digital I/O lines 1 to 6
- Digital output: Digital I/O lines 7 to 12
- External trigger: Digital I/O line 13
- Matrix ready: Digital I/O line 14

Refer to [Digital I/O port](#) (on page 2-7) for the pinout diagram for the digital I/O connector.

### Memory setups

---

Memory setups are handled as a single channel pattern when you use Model 707A or 708A compatibility mode.

The Model 707B or 708B supports 100 memory setups, in addition to the channel patterns normally available in the Model 707B or 708B.

The memory patterns are named MEMSETUP<sub>xxx</sub>, where <sub>xxx</sub> is between 001 and 100.

Memory patterns are created as they are used.

You can work with memory patterns through TSP as you do with channel patterns. See [Channel patterns](#) (on page 2-92).

## Models 707A and 708A commands

Models 707A and 708A commands		
Command	Description	Differences in Models 707B and 708B
An	Edge for which an externally generated pulse executes a trigger	None.
Bn	Select logic sense of matrix ready	Actual matrix ready signal may have different timing characteristics. If a relay does not change state, the matrix ready signal does not include the relay settle time.
Crc(,rc)..(,rc)	Close crosspoints in a setup	Actual ready and matrix ready signals may have different timing characteristics. The Ready signal includes the relay settle time. Subordinate units are not supported. In the case of multiple commands, all crosspoints are closed simultaneously.
Dnnnnnn	Set text on the display	Only available on Model 707B. The display character limit has been increased to 20 and the text is displayed on the first line of the VFD display.
Db,s	Set digital output	Only available on Model 708B. The actual digital output settings will not function for bits that are outside of the physical interface specifications (see <a href="#">Digital interface</a> (on page B-2)).
En	Specify setup number	None.
Fn	Enable or disable triggers	None.
Gn	Output format	None.
Hn	Front panel key	Only Model 707A. This command has no effect and does not issue an error message when used.
In	Insert blank setup	None.
Jn	Self-test	There is no self-test for the Models 707B and 708B.
Kn	EOI and hold off	Actual ready and matrix ready signals may have different timing characteristics. The Ready signal on the Model 707B or 708B includes the relay settle time. The Models 707A and 708A could hold off the GPIB bus on the specific 'X' character. To increase performance, the Models 707B and 708B use a message-based system. Therefore, the hold off has been changed to 'hold off on end of message'. When the 'X' is at the end of the message, the functionality is identical.
Lbbbb...X	Download setup	None.
Mn	SRQ and Serial Poll Byte	Performing a self-test or pressing a key does not clear the SRQ Ready bit.
Nrc(,rc)...(,rc)	Open crosspoint	Actual ready and matrix ready signals may have different timing characteristics. The ready signal on the Model 707B or 708B includes the relay settle time. Subordinate units are not supported. All crosspoints are opened. For example, for the command "NA1NA2NA3", all three crosspoints are opened. All crosspoints are opened simultaneously.
Ovvv	Digital output	The actual digital output settings will not function for bits that are outside the physical interface specifications (see <a href="#">Digital interface</a> (on page B-2)).
Pn	Clear crosspoints	None.
Qn	Delete setup	None.
Rn	Restore defaults	None.
Sn	Programmable settle time	Works as intended in 70xB-VERSION. For 70xA-VERSION, settle time is always zero (0).



Tn	Trigger source	The trigger source 0/1 (GPIB Talk) is not available for the Models 707B and 708B. The factory default address for the Models 707B and 708B is 16. The trigger source 8/9 (front panel key) is not implemented.
Un	Instrument Config/Status	For U0, the last pressed key always reads 05. For U1, the Self-Test, PowerUp, and Master/Subordinate Loop bits always read zero. For U4, the number is always zero. For U5, the subordinates always read zero. For U7, though compatible bits are returned, the actual digital input settings read zero for those bits outside of the physical interface specifications (see digital input/output difference). For U8, the test relay is not supported and always reads 15.
Vabcdefgh	Make before break	None.
Wabcdefgh	Break before make	None.
<cmd>X	Execute	None.
Yn	Change line terminate	None.
Zm,n	Copy setup	None.
<space>	Model and version	Sending a <space> only in a message causes the unit to return the model and version number.
*idn?	Unit identification	For compatibility, the version number is A03 (version number of DDC compatibility, not the firmware version). For example, on the Model 707A, the return string is "707A03".

There is a limit of 64 commands per execution.

For more detail on the Model 707A and 708A commands, see the appropriate instruction manual:

- For the Model 707A: 707A-901-01 (A - Sep 1998)(Instruction).pdf
- For the Model 708A: 708A-901-01 (A - Sep 1998)(Instruction).pdf

These instruction manuals are available on the [Keithley Instruments support website \(http://www.keithley.com/support\)](http://www.keithley.com/support).

---

## Status model

### In this appendix:

---

Status model .....	C-1
--------------------	-----

## Status model

### Overview

Each Keithley Instruments Models 707B and 708B provides a number of status registers and queues that are collectively referred to as the status model. Through manipulation and monitoring of these registers and queues, you can view and control various instrument events. You can include commands in your test program that can determine if a service request (SRQ) event has occurred and the cause of the event.

The heart of the status model is the Status Byte Register. All status model registers and queues flow into the Status Byte Register.

The entire status model is illustrated in the Status model diagrams.

### Status Byte Register

---

The Status Byte Register receives summary bits from the other status register sets and queues, and also from itself (which sets the Master Summary Status, or MSS, bit). For details, see [Status Byte Register](#) (on page C-16).

### Status register set contents

Typically, a status register set contains the following registers:

- **Condition** (.condition): A read-only register that is constantly updated to reflect the present operating conditions of the instrument.
- **Enable Register** (.enable): A read-write register that allows a summary bit to be set when an enabled event occurs.
- **Event Register** (.event): A read-only register that sets a bit to 1 when the applicable event occurs. If the enable register bit for that event is also set, the summary bit of the register will set to 1.
- **Negative Transition Register (NTR)** (.ntr): When a bit is set in this read-write register, it enables a 1 to 0 change in the corresponding bit of the condition register to cause the corresponding bit in the event register to be set.
- **Positive Transition Register (PTR)** (.ptr): When a bit is set in this read-write register, it enables a 0 to 1 change in the corresponding bit of the condition register to cause the corresponding bit in the event register to be set.

An event is represented by a condition register bit changing from a 1 to 0 or 0 to 1. When an event occurs and the appropriate NTR or PTR bit is set, the corresponding event register bit is set to 1. The event bit remains latched to 1 until the event register is read or the status model is reset. When an event register bit is set and its corresponding enable bit is set, the summary bit of the register is set to 1. This, in turn, sets a bit in a higher-level condition register, potentially cascading to the associated summary bit of the Status Byte Register.

### Summary bit

The summary bit of each register is either set (1) or clear (0). A set summary bit indicates that one (or more) of the enabled events in that register has occurred.

### Queues

The Models 707B and 708B uses queues to store messages. The queues include:

- Output queue: Holds response messages.
- Error queue: Holds error and status messages.

When a queue contains data, it sets the condition bit for that queue in one of the registers. The condition bits are:

- Command queue: CAV in the Operation Status Remote Summary Register
- Output queue: MAV in the Status Byte Register
- Error queue: EAV in the Status Byte Register

The CAV, MAV, and EAV bits in the registers are cleared when the queue is empty. Queues empty when:

- Commands are executed
- Errors are read from the error queue
- Response messages are read from the instrument

All Models 707B and 708B queues are first-in, first-out (FIFO).

The [Status Byte Register overview](#) (on page C-4) shows how the queues are structured with the other registers.

### Output queue

When the instrument is in the remote state, the output queue holds data that pertains to the normal operation of the instrument. For example, when a `print()` command is sent, the response message is placed in the output queue.

When data is placed in the output queue, the Message Available (MAV) bit in the status byte register is set. A response message is cleared from the output queue when it is read. The output queue is considered cleared when it is empty. An empty output queue clears the MAV bit in the status byte register.

A message is read from the output queue by addressing the instrument to talk.

## Status model diagrams

The register sets (and queues) monitor various instrument events. When an enabled event occurs in one of the five registers, it sets the associated summary bit in the Status Byte register. When a summary bit of the Status Byte is set and its corresponding enable bit is set (as programmed using `status.request_enable`), the MSS bit will set to indicate that an SRQ has occurred. View the master summary bit using `status.condition` attribute. In an expanded system (TSP-link), setting the `status.node_enable` attribute allows the System registers to be shared by all nodes in the TSP-Link system. The following figures and topics illustrate the relationships of the individual registers and queues with the Status Byte register.

## Status Byte Register overview

Figure 105: Status Byte register

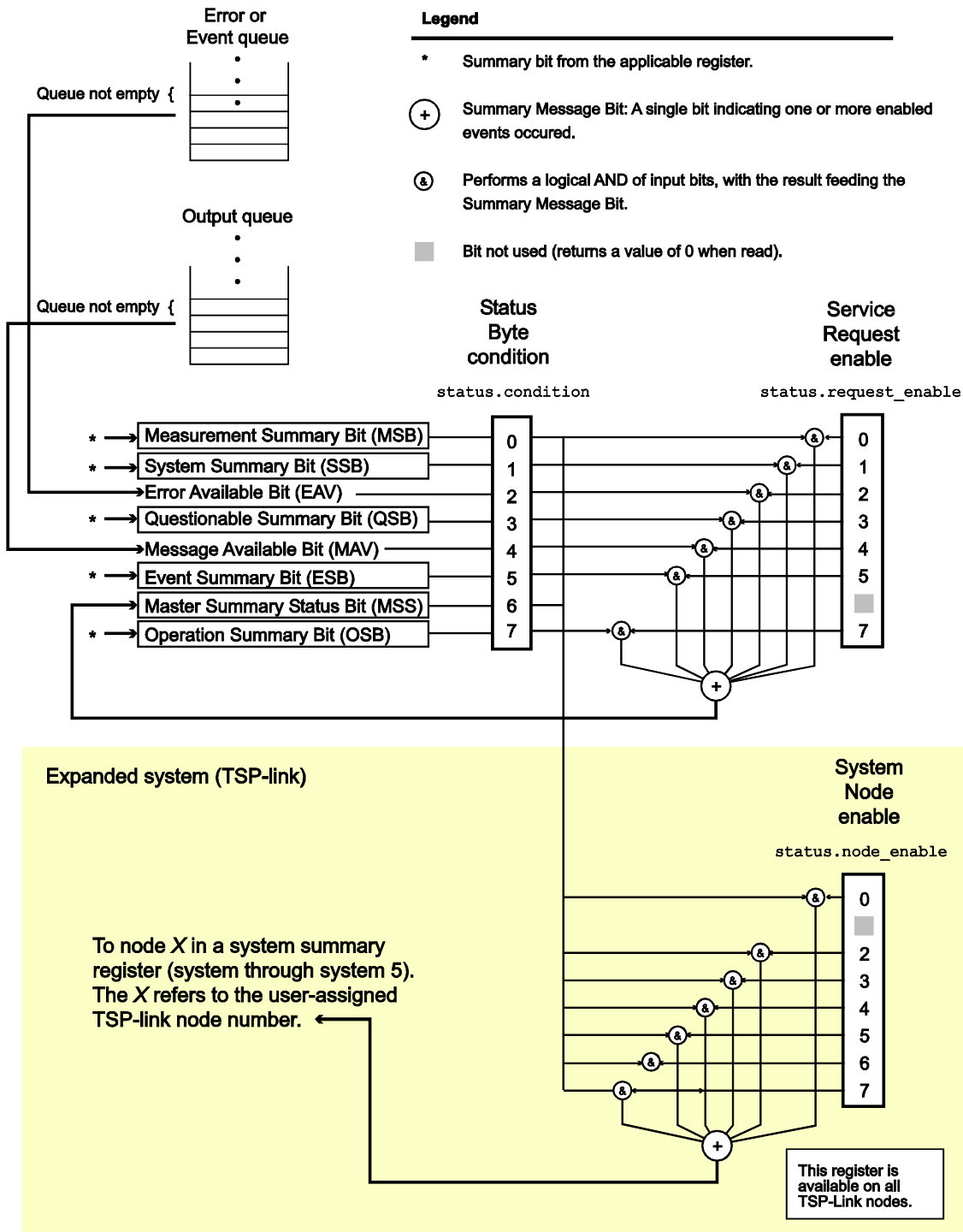

---

**Measurement summary bit (Measurement event register)**

---

The summary bit of the measurement event register provides enabled summary information to Bit B0 (MSB) of the status byte. Since the Models 707B and 708B has no internal measurement capabilities, none of the bits in the measurement registers are defined. Therefore, this bit is always 0.

---

**System summary bit (System register)**

---

The summary bit of the system register provides enabled summary information to Bit B1 (SSB) of the status byte.

Figure 106: System summary bit (System register)

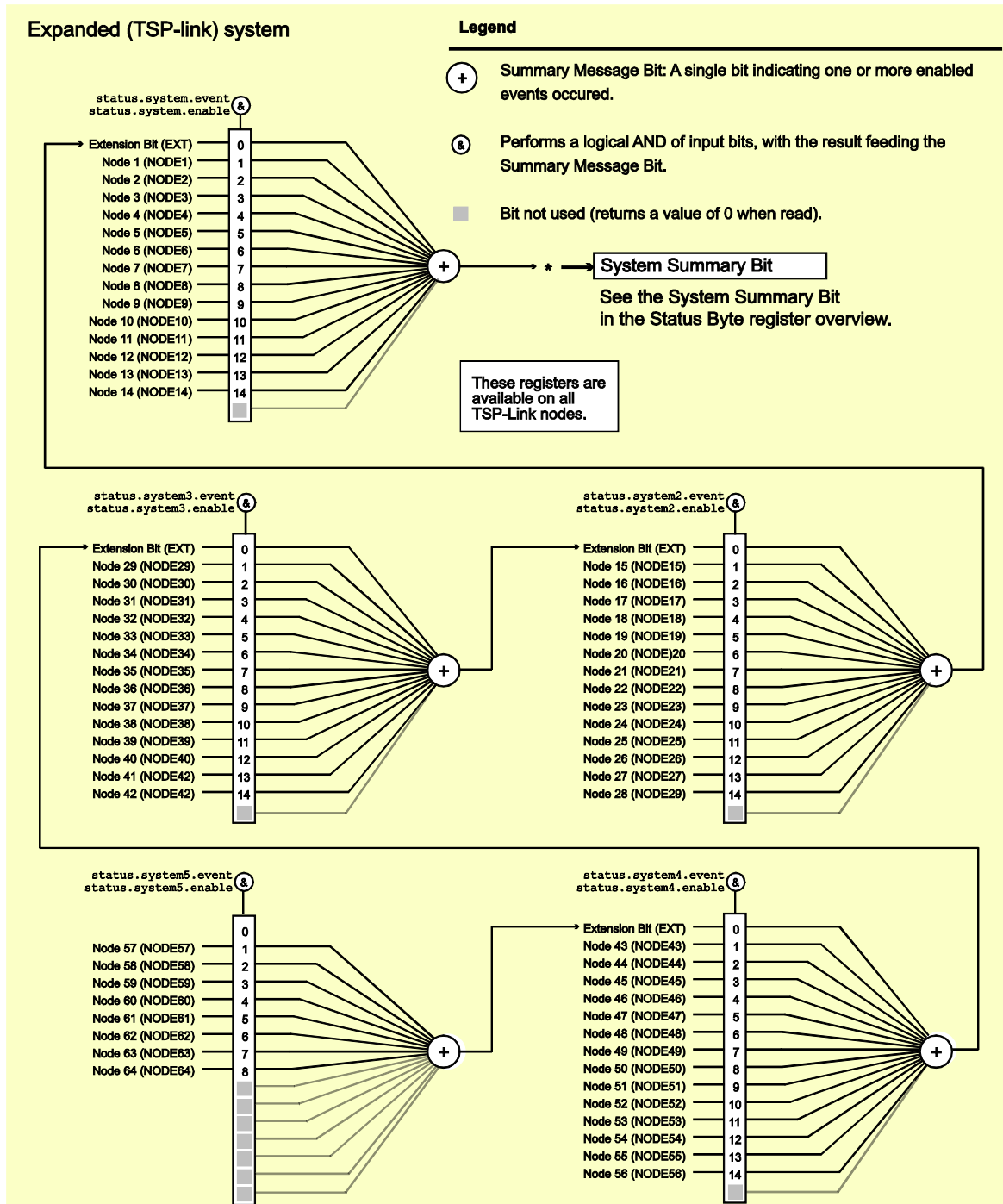

As shown above, there are five register sets associated with System Event Status. These registers summarize system status for various nodes connected to the TSP-Link. Note that all nodes on the TSP-Link share a copy of the system summary registers once the TSP-Link has been initialized. This feature allows all nodes to access the status models of other nodes, including SRQ.

In a TSP-Link system, the status model can be configured such that a status event in any node in the system can set the RQS (Request for Service) bit of the Master Node Status Byte. See [TSP-Link system status](#) (on page C-21) for details on using the status model in a TSP-Link system.

Attributes are summarized in [status.system.\\*](#) (on page 7-190), [status.system2.\\*](#) (on page 7-192), [status.system3.\\*](#) (on page 7-194), [status.system4.\\*](#) (on page 7-196), and [status.system5.\\*](#) (on page 7-198).

For example, any of the following commands will set the EXT enable bit:

```
status.system.enable = status.system.EXT
status.system.enable = status.system.EXTENSION_BIT
status.system.enable = 1
```

When reading a register, a numeric value is returned. The binary equivalent of this value indicates which bits in the register are set. For details, see [Reading registers](#) (on page C-15). For example, the following command will read the system enable register:

```
print(status.system.enable)
```

The bits used in the system register sets are described as follows:

- **Bit B0, Extension Bit (EXT):** Set bit indicates that an extension bit from another system status register is set.
- **Bits B1-B14\* NODEN:** Indicates a bit on TSP-Link node n has been set ( $N = 1$  to 64).
- **Bits B15:** Not used.

\*status.system5 does not use bits B9 through B15.

Refer to the following table for available  $N$  values:

Command	$N$ value
status.system.*	1 to 14
status.system2.*	15 to 28
status.system3.*	29 to 42
status.system4.*	43 to 56
status.system5.*	57 to 64

## Error available bit (Error or Event queue)

The summary bit of the Error or Event queue provides enabled summary information to Bit B2 (EAV) of the status byte.

The Error Available Bit (EAV) is set when a message defining an error (or status) is placed in the Error or Event queue. The Error or Event queue is one of the two Switching Matrix queues associated with the status model. The other queue sets the Message available bit (Output queue). Both queues are first-in, first-out (FIFO) queues. The Error queue holds error and status messages. The status model shows how these queues are structured with regard to the other registers.



The following sequence outlines typical events associated with this queue:

1. When an error or status event occurs, a message defining the error (or status) is placed in the Error queue.
2. The Error Available (EAV) bit in the Status Byte Register is set.
3. Through programming, the error (or status) message is read. This clears the error (or status) from the Error Queue. The Error queue is considered cleared when it is empty.
4. An empty Error queue clears the EAV bit in the Status Byte Register.

The commands to control the Error queue are listed below. When you read a single message in the Error queue, the oldest message is read and then removed from the queue. On power-up, the Error queue is initially empty. If there are problems detected during power-on, entries will be placed in the queue. If no problems are detected, the error number 0 and “No Error” will be returned.

Error queue command	Description
<code>errorqueue.clear()</code>	Clear error queue of all errors.
<code>errorqueue.count</code>	Number of messages in the error/event queue.
<code>errorqueue.next()</code>	Request error message.

Messages in the Error queue include a code number, message text, severity, and TSP-Link node number. For example, the following commands request the next complete error information from the error queue and displays the code, message, severity and node of the next error:

```
errorcode, message, severity, errornode = errorqueue.next()
print(errorcode, message, severity, errornode)
```

The error messages, as well as error numbers, are listed in the Error summary list.

### Questionable summary bit (Questionable event register)

The summary bit of the questionable event register provides enabled summary information to Bit B3 (QSB) of the status byte.

**Figure 107: Questionable summary bit (Questionable event register)**

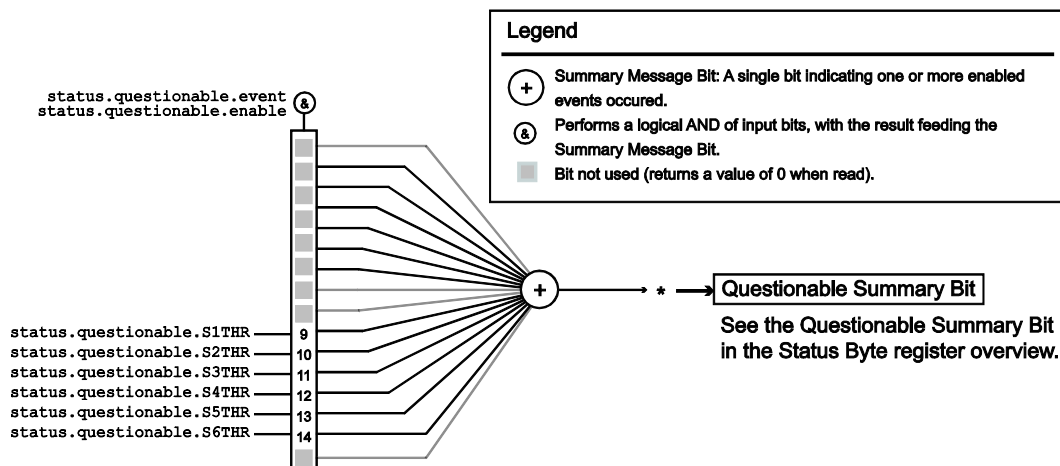

As shown above, there is only one register set associated with the questionable status. Attributes are summarized in [status.questionable.\\*](#) (on page 7-181). Keep in mind that bits can also be set by using numeric parameter values. For details, see [Programming enable and transition registers](#) (on page C-14).

For example, any of the following statements will set the thermal aspect enable bit of a card in slot 1:

```
status.questionable.enable = status.questionable.S1THR
status.questionable.enable = status.questionable.SLOT1_THERMAL
status.questionable.enable = 512
```

The following command will request the questionable enable register value in numeric form:

```
print(status.questionable.enable)
```

The bits used in this register set are described as follows:

- **SxTHR:** Set bit indicates the thermal aspect of the card in slot x is in question, where x = 1 to 6.

### Message available bit (Output queue)

The summary bit of the output queue provides enabled summary information to Bit B4 (MAV) of the status byte.

The Message Available Bit (MAV) is set when the Output queue holds data that pertains to the normal operation of the instrument. The Output queue is one of the two Switching Matrix queues associated with the status model. The other queue sets the [Error Available Bit \(Error or Event queue\)](#) (on page C-7). Both queues are first-in, first-out (FIFO) queues. The [Status Byte Register overview](#) (on page C-4) shows how these queues are structured with regard to the other registers.

As an example, when a print command is sent, the response message is placed in the Output queue. When data is placed in the Output queue, the Message Available (MAV) bit in the Status Byte Register sets. A response message is cleared from the Output queue when it is read. The Output queue is considered cleared when it is empty. An empty Output queue clears the MAV bit in the Status Byte Register.

A message is read from the Output queue by addressing the Switching Matrix to talk.

### Event summary bit (ESB register)

The summary bit of the Standard event register provides enabled summary information to Bit B5 (OSB) of the status byte.

Figure 108: Event summary bit (Standard event register)

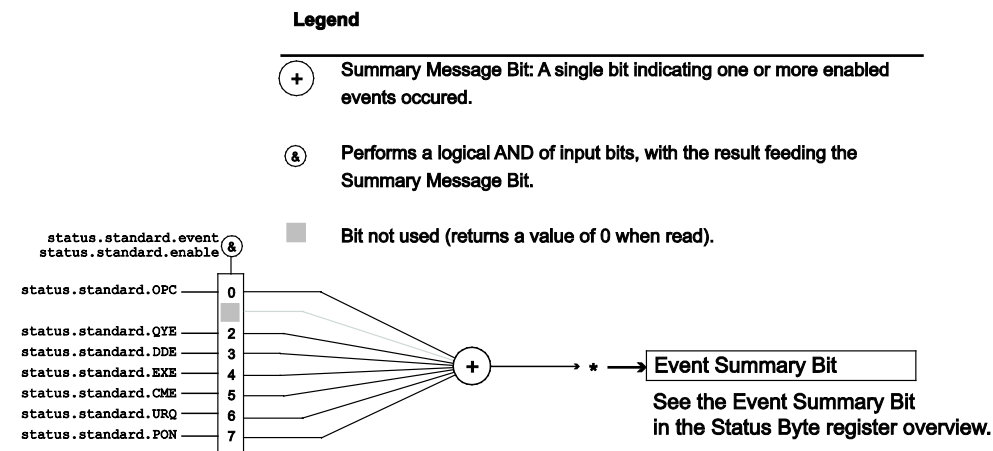

As shown above, there is only one register set associated with the event status register. Attributes are summarized in [status.standard.\\*](#) (on page 7-187). Keep in mind that bits can also be set by using numeric parameter values. For details, see [Programming enable and transition registers](#) (on page C-14).

For example, any of the following statements will set the operation complete enable bit:

```
standardRegister = status.standard.OPC
status.questionable.enable = status.standard.OPERATION_COMPLETE
status.questionable.enable = 1
```

The bits used in this register set are described as follows:

- **Bit B0, Operation Complete (OPC):** Set bit indicates that all pending selected device operations are completed and the instrument is ready to accept new commands. The bit is set in response to an \*OPC command. The remote command `opc ( )` can be used in place of the \*OPC command.
- **Bit B1:** Not used.
- **Bit B2, Query Error (QYE):** Set bit indicates that you attempted to read data from an empty Output queue.
- **Bit B3, Device-Dependent Error (DDE):** Set bit indicates that an instrument operation did not execute properly due to some internal condition.
- **Bit B4, Execution Error (EXE):** Set bit indicates that the instrument detected an error while trying to execute a command.
- **Bit B5, Command Error (CME):** Set bit indicates that a command error has occurred. Command errors include:
  - IEEE-488.2 syntax error: The instrument received a message that does not follow the defined syntax of the IEEE-488.2 standard.
  - Semantic error: instrument received a command that was misspelled or received an optional IEEE-488.2 command that is not implemented.
  - GET error: The instrument received a Group Execute Trigger (GET) inside a program message.
- **Bit B6, User Request (URQ):** Set bit indicates that the LOCAL key on the instrument front panel was pressed.
- **Bit B7, Power ON (PON):** Set bit indicates that the instrument has been turned off and turned back on since the last time this register has been read.

### Master summary status bit (MSS bit register)

The master summary status bit provides summary information to Bit B6 (MSS) of the status byte. Although this bit is always enabled for the status byte, it has to be enabled (using `status.node_enable`) if needed in an expanded system (TSP-link).

The Master Summary Status Bit (MSS) is set when an enabled summary bit of the Status Byte Register is set. This bit (B6) may also be interpreted as a Request Service (RQS) bit. Depending on how it is used, Bit B6 of the Status Byte Register is either the Request for Service (RQS) bit or the Master Summary Status (MSS) bit.

When using the GPIB serial poll sequence of the Switching Matrix to obtain the status byte (serial poll byte), B6 is the RQS bit. See [Serial polling and SRQ](#) (on page C-18) for details on using the serial poll sequence. For common and script commands (Status Byte Register), B6 is the MSS (Message Summary Status) bit. The serial poll, although automatically resetting the RQS bit, does not clear MSS. The MSS remains set until all Status Byte summary bits are reset.

## Operation summary bit (Operation event register)

The summary bit of the operation event register provides enabled summary information to Bit B7 (OSB) of the status byte.

Figure 109: Operation summary bit (Operation event register)

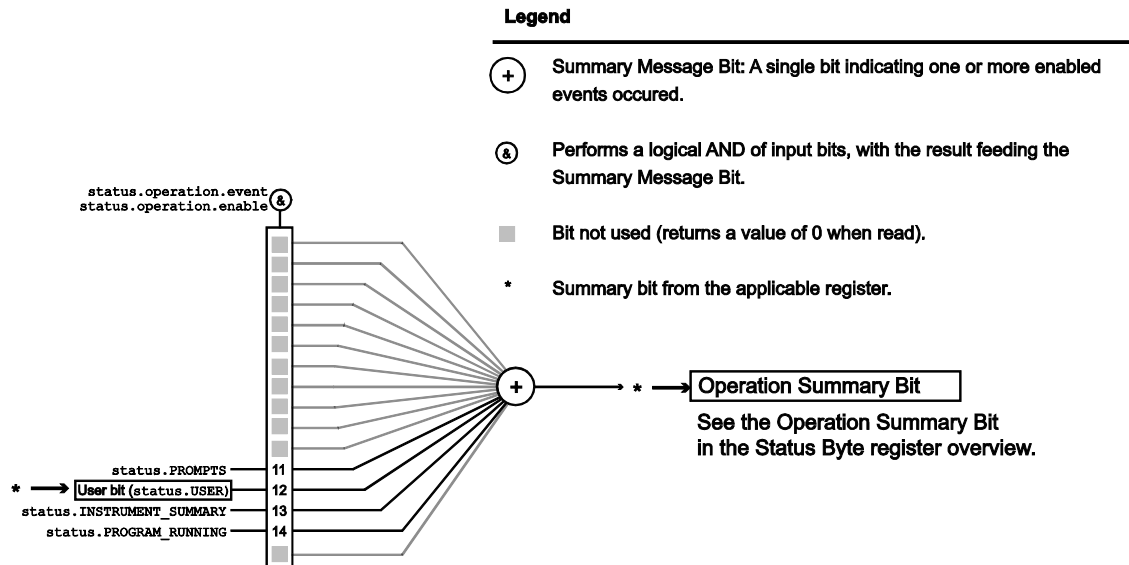

The bits used in this register set are described as follows:

- **Bits B1-B10:** Not used.
- **Bit B11, Remote Summary (REM):** Set bit indicates that an enabled in the Operation Status Remote Summary Register is set.
- **Bit B12, User (USER):** Set bit indicates that an enabled bit in the operation status user register is set.
- **Bit B13, Instrument Summary (INST):** Set bit indicates that an enabled bit in the operation status instrument summary register is set.
- **Bit B14:** Not used.

### Operation user bit (Operation user register)

The summary bit of the operation user register provides the user bit (User) (Bit B12) to the operation status register. In turn, the summary bit of the operation status register will provide the operation summary bit (OSB) (Bit B7) to the status byte.

Figure 110: Operation user summary bit (Operation user register)

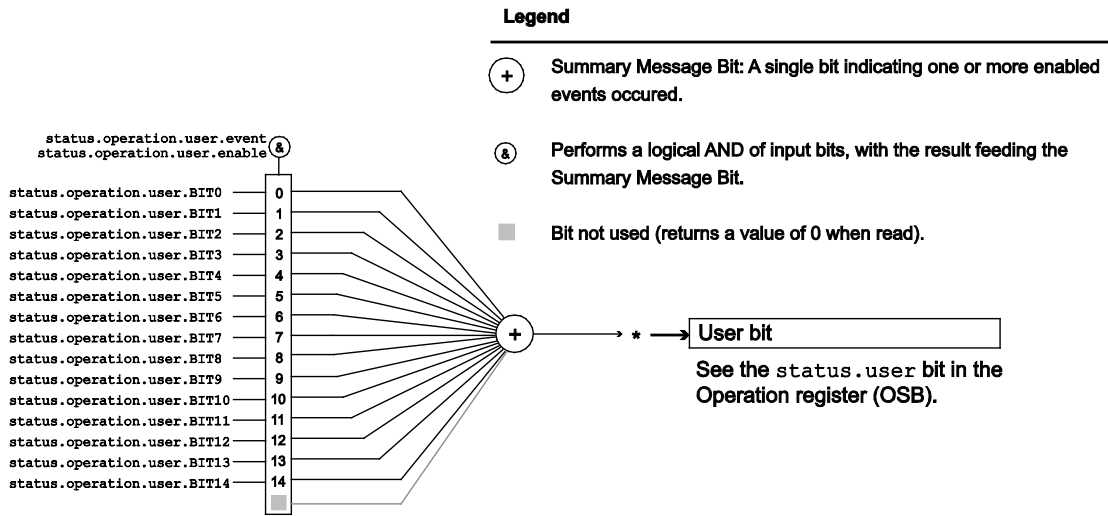

The bits used in this register set are described as follows:

- **Bits B0-B14:** status.operation.user.BIT0 through status.operation.user.BIT14
- **Bits B15:** Not used.

## Status function summary

The following functions and attributes control and read the various registers. Additional information is included in the command listings for the various register sets.

### Status function summary

Type	Function or attribute*
System summary	<a href="#">status.condition</a> (on page 7-172) <a href="#">status.node_event</a> (on page 7-176) <a href="#">status.node_enable</a> (on page 7-174) <a href="#">status.request_event</a> (on page 7-185) <a href="#">status.request_enable</a> (on page 7-183) <a href="#">status.reset()</a> (on page 7-187)
Operation event	<a href="#">status.operation.*</a> (on page 7-177) <a href="#">status.operation.user.*</a> (on page 7-179)
Questionable event	<a href="#">status.questionable.*</a> (on page 7-181)
Standard event	<a href="#">status.standard.*</a> (on page 7-187)
System events	<a href="#">status.system.*</a> (on page 7-190) <a href="#">status.system2.*</a> (on page 7-192) <a href="#">status.system3.*</a> (on page 7-194) <a href="#">status.system4.*</a> (on page 7-196) <a href="#">status.system5.*</a> (on page 7-198)

## Clearing registers

Commands to reset the status registers are listed in the table below.

In addition to these commands, you can reset the enable registers and the NTR to 0. To do this, send the individual command to program the register with a 0 as its parameter value. The PTR registers can be reset to their defaults by programming them with all bits on. Note that the event registers are not programmable but can be cleared by reading them.

Commands to reset registers	
Command	Description
<b>To reset registers:</b> *CLS  status.reset()	Reset bits of the event and NTR registers to 0 and set all PTR register bits on. Also clears the output queue.  Reset bits of the event and NTR registers to 0 and set all PTR register bits on.

## Startup state

When the Switching Matrix is turned on, various register status elements are set as follows:

- The power on (PON) bit in the `status.operation.condition` register is set.
- Other bits are set appropriately based on the instrument's power-on configuration.
- All enable registers (`.enable`) are set to 0.
- All negative transition registers (`.ntr`) are set to 0.
- All used positive transition registers (`.ptr`) bits are set to 1.
- The two queues are empty.

## Programming and reading registers

### Programming enable and transition registers

The only registers that you can program are the enable and transition registers. All other registers in the status structure are read-only registers. The following explains how to determine the parameter values for the various commands used to program enable registers. The actual commands are summarized in [Status function summary](#) (on page C-13).

A command to program an event enable or transition register is sent with a parameter value that determines the desired state (0 or 1) of each bit in the appropriate register. The bit positions of the register (see the following figure) indicate the binary parameter value and decimal equivalent. To program one of the registers, send the decimal value for the bits to be set. The registers are discussed further in [Enable and transition registers](#) (on page C-20).

**Figure 111: 16-bit status register**

Bit position	B7	B6	B5	B4	B3	B2	B1	B0
Binary value	0/1	0/1	0/1	0/1	0/1	0/1	0/1	0/1
Decimal	128	64	32	16	8	4	2	1
Weights	(2 <sup>7</sup> )	(2 <sup>6</sup> )	(2 <sup>5</sup> )	(2 <sup>4</sup> )	(2 <sup>3</sup> )	(2 <sup>2</sup> )	(2 <sup>1</sup> )	(2 <sup>0</sup> )

#### A. Bits 0 through 7

Bit position	B15	B14	B13	B12	B11	B10	B9	B8
Binary alue	0/1	0/1	0/1	0/1	0/1	0/1	0/1	0/1
Decimal	32768	16384	8192	4096	2048	1024	512	256
Weights	(2 <sup>15</sup> )	(2 <sup>14</sup> )	(2 <sup>13</sup> )	(2 <sup>12</sup> )	(2 <sup>11</sup> )	(2 <sup>10</sup> )	(2 <sup>9</sup> )	(2 <sup>8</sup> )

#### B. Bits 8 through 15

When using a numeric parameter, registers are programmed by including the appropriate <mask> value. For example:

```
*ese 1169
status.standard.enable = 1169
```

To convert from decimal to binary, use the information shown in the above figure. For example, to set bits B0, B4, B7, and B10, a decimal value of 1169 would be used for the mask parameter ( $1169 = 1 + 16 + 128 + 1024$ ).

## Reading registers

---

Any register in the status structure can be read either by sending the common command query (where applicable), or by including the script command for that register in either the `print()` or `print(tostring())` command. The `print()` command outputs a numeric value; the `print(tostring())` command outputs the string equivalent. For example, any of the following commands requests the Service Request Enable Register value:

```
*SRE?
print(tostring(status.request_enable))
print(status.request_enable)
```

The response message will be a decimal value that indicates which bits in the register are set. That value can be converted to its binary equivalent using the information in [Programming enable and transition registers](#) (on page C-14). For example, for a decimal value of 37 (binary value of 100101), bits B5, B2, and B0 are set.

## Register programming example

---

The command sequence below programs the instrument to generate a service request (SRQ) and set the system summary bit in all TSP-Link nodes when the current limit on channel A is exceeded.

```
-- Clear all registers.
status.reset()

-- Enable SLOT1_THERMAL bit in questionable register.
status.questionable.enable = status.questionable.SLOT1_THERMAL

-- Set the system summary node QSB enable bit.
status.node_enable = status.QSB

-- Set the QSB bit of the service request enable register.
status.request_enable = status.QSB
```



## Status byte and service request (SRQ)

Service requests (SRQs) allow an instrument to indicate that it needs attention or that some event has occurred. When the controller receives an SRQ, it allows the controller to interrupt tasks to perform other tasks in order to address the request for service.

For example, you might program your instrument to send an SRQ when:

- All instrument operations are complete
- An instrument error occurs
- A specific operation has occurred

Two 8-bit registers control service requests, the Status Byte Register and the Service Request Enable Register. The [Status Byte Register](#) (on page C-16) topic describes the structure of these registers.

Service requests affect GPIB, USB, and VXI-11 connections. On a GPIB connection, the SRQ line is asserted. On a VXI-11 or USB connection, an SRQ event is generated.

---

### Service Request Enable Register

The Service Request Enable Register controls the generation of a service request. This register is programmed by the user and is used to enable or disable the setting of bit B6 (RQS/MSS) by the Status Summary Message bits (B0, B1, B2, B3, B4, B5, and B7) of the Status Byte Register. As shown in the [Status Byte Register](#) (on page C-16) topic, a logical AND operation is performed on the summary bits (&) with the corresponding enable bits of the Service Request Enable Register. When a logical AND operation is performed with a set summary bit (1) and with an enabled bit (1) of the enable register, the logic "1" output is applied to the input of the logical OR gate and, therefore, sets the MSS/RQS bit in the Status Byte Register.

The individual bits of the Service Request Enable Register can be set or cleared by using the `*SRE` common command or `status.request_enable`. To read the Service Request Enable Register, use the `*SRE?` query or `print(status.request_enable)`. The Service Request Enable Register clears when power is cycled or a parameter value of 0 is sent with a status request enable command (for example, a `*SRE 0` or `status.request_enable = 0` is sent). The commands to program and read the SRQ Enable Register are listed in [Status byte and service request commands](#) (on page C-20).

---

### Status Byte Register

The summary messages from the status registers and queues are used to set or clear the appropriate bits (B0, B1, B2, B3, B4, B5, and B7) of the Status Byte Register. These summary bits do not latch, and their states (0 or 1) are dependent upon the summary messages (0 or 1). For example, if the Standard Event Register is read, its register will clear. As a result, its summary message will reset to 0, which will then reset the ESB bit in the Status Byte Register.

The Status Byte Register also receives summary bits from itself, which sets the Master Summary Status, or MSS, bit.

Figure 112: Status byte and service request (SRQ)

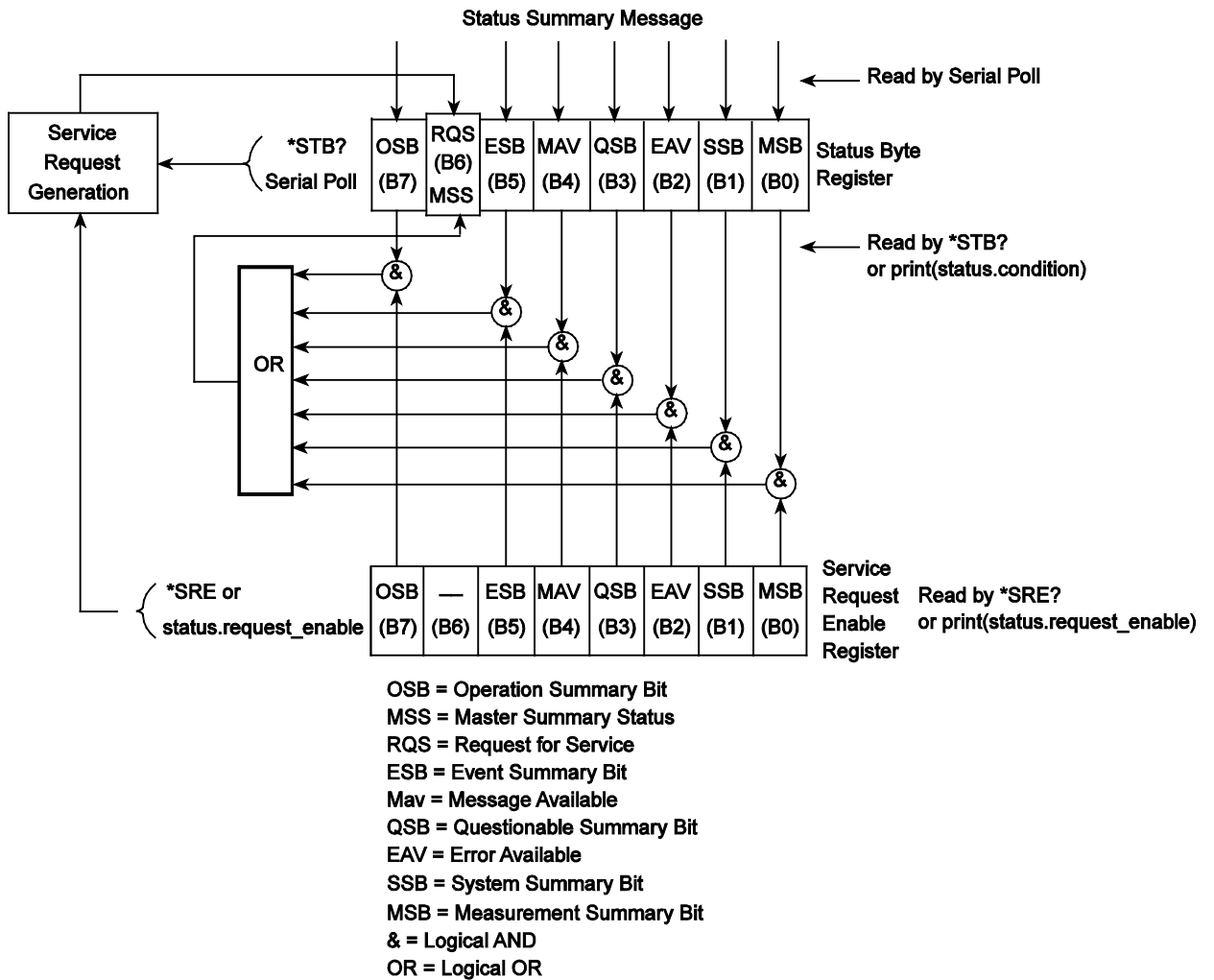

The bits of the Status Byte Register are described as follows:

- **Bit B0, Measurement Summary Bit (MSB):** Set summary bit indicates that an enabled measurement event has occurred.
- **Bit B1, System Summary Bit (SSB):** Set summary bit indicates that an enabled system event has occurred.
- **Bit B2, Error Available (EAV):** Set bit indicates that an error or status message is present in the error queue.
- **Bit B3, Questionable Summary Bit (QSB):** Set summary bit indicates that an enabled questionable event has occurred.
- **Bit B4, Message Available (MAV):** Set bit indicates that a response message is present in the output queue.
- **Bit B5, Event Summary Bit (ESB):** Set summary bit indicates that an enabled standard event has occurred.
- **Bit B6, Request Service (RQS)/Master Summary Status (MSS):** Set bit indicates that an enabled summary bit of the Status Byte Register is set. Depending on how it is used, bit B6 of the Status Byte Register is either the Request for Service (RQS) bit or the Master Summary Status (MSS) bit:
  - When using the GPIB, USB, or VXI-11 serial poll sequence of the Models 707B and 708B to obtain the status byte (serial poll byte), B6 is the RQS bit. See [Serial polling and SRQ](#) (on page C-18) for details on using the serial poll sequence.
  - When using the \*STB? common command or status.condition [Status byte and service request commands](#) (on page C-20) to read the status byte, B6 is the MSS bit.
- **Bit B7, Operation Summary (OSB):** Set summary bit indicates that an enabled operation event has occurred.

---

## Serial polling and SRQ

Any enabled event summary bit that goes from 0 to 1 sets bit B6 and generates a service request (SRQ).

In your test program, you can periodically read the Status Byte to check if an SRQ has occurred and what caused it. If an SRQ occurs, the program can, for example, branch to an appropriate subroutine that will service the request.

SRQs can be managed by the serial poll sequence of the instrument. If an SRQ does not occur, bit B6 (RQS) of the Status Byte Register remains cleared, and the program proceeds normally after the serial poll is performed. If an SRQ does occur, bit B6 of the Status Byte Register is set, and the program can branch to a service subroutine when the SRQ is detected by the serial poll.

The serial poll automatically resets RQS of the Status Byte Register. This allows subsequent serial polls to monitor bit B6 for an SRQ occurrence that is generated by other event types.

For common commands and TSP commands, B6 is the MSS (Message Summary Status) bit. The serial poll does not clear the MSS bit. The MSS bit remains set until all enabled Status Byte Register summary bits are reset.

---

## SPE, SPD (serial polling)

For the GPIB interface only, the SPE and SPD general bus commands are used to serial poll the Switching Matrix. Serial polling obtains the serial poll byte (status byte). Typically, serial polling is used by the controller to determine which of several instruments has requested service with the SRQ line.

## **Service requests**

---

Service requests (SRQs) affect both the GPIB and the VXI-11 connections. On a GPIB connection, the SRQ line is asserted. On a VXI-11 connection, an SRQ event is generated.

## Status byte and service request commands

The commands to program and read the Status Byte Register and Service Request Enable Register are listed in [Status byte and service request commands](#) (on page C-20). Note that the table includes both common commands and their script command equivalents. For details on programming and reading registers, see [Programming enable and transition registers](#) (on page C-14) and [Reading registers](#) (on page C-15).

To reset the bits of the Service Request Enable Register to 0, use 0 as the parameter value for the command (for example, `*SRE 0` or `status.request_enable = 0`).

### Status Byte and Service Request Enable Register commands

Command	Description
*STB? or <code>print(status.condition)</code>	Read the Status Byte Register.
*SRE <mask> or <code>status.request_enable = &lt;mask&gt;</code>	Program the Service Request Enable Register where <mask> = 0 to 255.
*SRE? or <code>print(status.request_enable)</code>	Read the Service Request Enable Register.

## Enable and transition registers

In general, there are three types of user-writable registers that are used to configure which bits feed the register summary bit and when it occurs. The registers are identified in each applicable command (as listed in TSP commands) as follows:

- **Enable register** (identified as `.enable` in each attribute's command listing): Allows various associated events to be included in the summary bit for the register.
- **Negative-transition register** (identified as `.ntr` in each attributes command listing): A particular bit in the event register will be set when the corresponding bit in the NTR is set, and the corresponding bit in the condition register transitions from 1 to 0.
- **Positive-transition register** (identified as `.ptr` in each attributes command listing): A particular bit in the event register will be set when the corresponding bit in the PTR is set, and the corresponding bit in the condition register transitions from 0 to 1.

## Controlling node and SRQ enable registers

Attributes to control system node and service request (SRQ) enable bits and read associated registers are summarized in the [Status byte register overview](#) (on page C-4). For example, either of the following will set the system node QSB enable bit:

```
status.node_enable = status.QSB
status.node_enable = 8
```

## TSP-Link system status

The TSP-Link<sup>®</sup> expansion interface allows instruments to communicate with each other. The test system can be expanded to include up to 32 TSP-enabled instruments. In a TSP-Link system, one node (instrument) is the master and the other nodes are the subordinates. The master can control the other nodes (subordinates) in the system. See TSP-Link system expansion interface for details about the TSP-Link system.

The system summary registers, shown in the [System summary bit \(System register\)](#) (on page C-5), are shared by all nodes in the TSP-Link system. A status event that occurs at a subordinate node can generate an SRQ (service request) in the master node. After detecting the service request, your program can then branch to an appropriate subroutine that will service the request. See [Status byte and service request \(SRQ\)](#) (on page C-16) for details.

### Status model configuration example

---

The following example illustrates the status model configuration for a TSP-Link system. In this example, a Node 15 thermal aspect event will set the RQS bit of the Status Byte of the master Node.

When the thermal aspect event occurs on Node 15, the following sequence of events will occur:

1. On Node 15, with Bit B9 of the Questionable event register enabled, when the thermal aspect event occurs, Bit B9 bit sets (`status.questionable.condition`) which causes Bit B9 to be set in `status.questionable.event`. This in turn causes the Questionable event summary bit (QSB) to set.
2. With QSB set, and Bit B3 of the System node enabled (`status.node_enable`), Bit B3 of the Status Byte register (Node 15) sets. This in turn causes the System node summary bit to set.
3. With the System node summary bit set, and Bit B1 of the System2 summary event register enabled (which is Node 15), Bit B1 of the System2 register sets. This in turn causes the System2 event summary bit (EXT) to set.
4. With EXT set, and Bit B0 of the System summary event register enabled, Bit B0 of the System register sets. This in turn causes the System event summary bit (SSB) to set.
5. With SSB set, and Bit B1 of the Service request enable register enabled, Bit B6 of the Status Byte register sets. This in turn initiates a request for service (SRQ).
6. When your program performs the next serial poll of the Master Node, it will detect the interlock event and can branch to a routine to service the request.

## NOTE

The System Summary Registers are shared by all nodes in the TSP-Link system. When a bit in a system register of Node 15 sets, the same bit in the master node system register also sets.

The following commands (sent from the master node) enable the appropriate register bits for the above example:

Node 15 status registers: The following commands enable the events for Node 15:

```
node[15].status.questionable.enable = status.questionable.S1THR  
node[15].status.node_enable = status.QSB
```

The affected status registers for the above commands are indicated by labels (1) and (2) (see the "TSP-Link status model configuration example" figure below).

System registers: The following commands enable the required system summary bits for Node 15:

```
status.system2.enable = status.system2.NODE15  
status.system.enable = status.system.EXT
```

The affected system registers for the above commands are indicated by labels (3) and (4) (see the "TSP-Link status model configuration example" figure below).

Master Node service request: The following command enables the service request for the measurement event:

```
status.request_enable = status.SSB
```

The affected status register for the above command is indicated by labels (5) and (6) (see the "TSP-Link status model configuration example" figure below).

Figure 113: TSP-Link status model configuration example

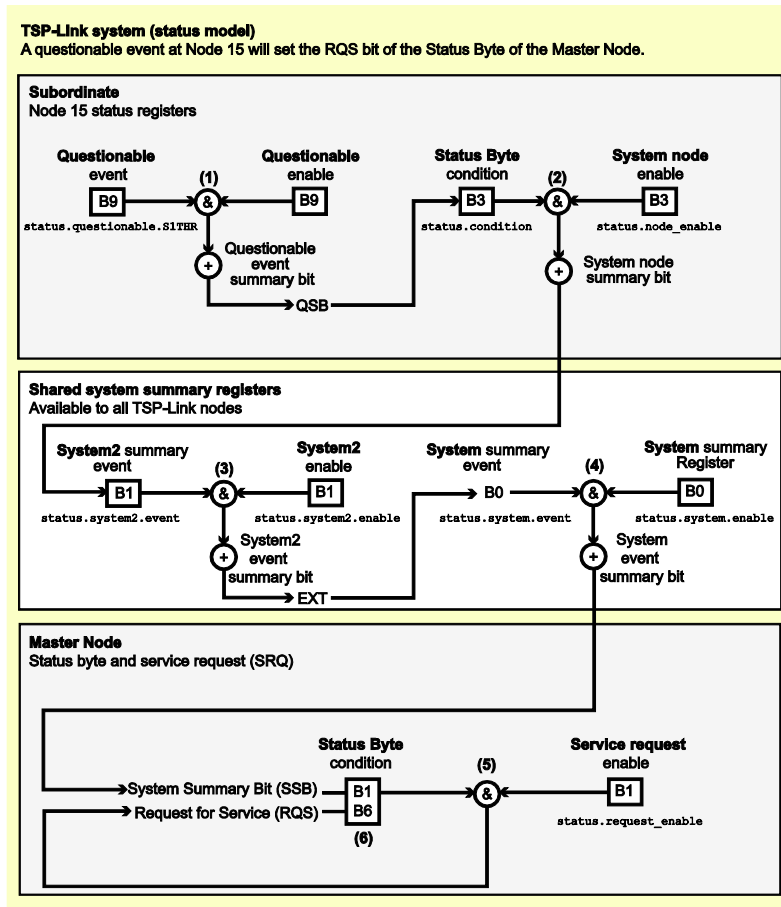





---

# Index

- :
- :SYSTEM
  - POSetup
    - rack mounting • A-4
- <
- <ch\_list> queries • 2-82
- A**
  - acceptor trigger mode • 3-15, 3-19
  - anonymous script • 6-5
  - arrays • 6-24
  - attribute • 5-2
    - assigning a value to • 5-2
    - reading • 5-2
  - autoexec script • 6-7
  - autorun scripts • 6-6
- B**
  - background scan execution • 3-7
  - base library functions • 6-25
  - basic scan procedure • 3-5
  - beeper • 5-3, 7-8
  - bit • 5-4
  - bit functions • 7-9, 7-10, 7-11, 7-12, 7-13, 7-14, 7-15, 7-64
  - Break-Before-Make • 2-82
  - bus operation
    - scanning • 3-8
- C**
  - channel
    - break before make • 5-27, 7-18
    - close/open operations and commands • 7-17, 7-18
    - connect rule • 2-82
    - designations • 2-80
    - existing scan • 3-6
    - forbidden to close • 7-16, 7-42
    - list parameter • 2-81
    - make before break • 5-27, 7-18
    - patterns • 2-92
  - channel commands
    - channel.clearforbidden() • 7-16
    - channel.close() • 7-17
    - channel.connectrule • 7-18
    - channel.connectsequential • 7-19
    - channel.createspecifier() • 7-20
    - channel.exclusiveclose() • 7-22
    - channel.exclusiveslotclose() • 7-23
    - channel.getclose() • 7-24
    - channel.getcount() • 7-25
    - channel.getdelay() • 7-26
    - channel.getforbidden() • 7-27
    - channel.getlabel() • 7-28
    - channel.getlabelcolumn() • 7-30
    - channel.getlabelrow() • 7-31
    - channel.getstate() • 7-32
    - channel.gettype() • 7-33
    - channel.open() • 7-33
    - channel.pattern.catalog() • 7-35
    - channel.pattern.delete() • 7-36
    - channel.pattern.getimage() • 7-36
    - channel.pattern.setimage() • 7-37
    - channel.pattern.snapshot() • 7-39
    - channel.reset() • 7-40
    - channel.setdelay() • 7-41
    - channel.setforbidden() • 7-42
    - channel.setlabel() • 7-43
    - channel.setlabelcolumn() • 7-44
    - channel.setlabelrow() • 7-46
  - channel patterns • 2-92
  - clear • 7-63, 7-228
  - close
    - close channel operations • 7-17, 7-22, 7-23, 7-24, 7-33
  - command • 5-1
    - device control • 6-54
    - ICL commands • 3-8
    - programming notes • 7-1
    - queries • 5-3
    - reference • 7-1
  - conditional branching • 6-18
  - configuration
    - CONFIG key • 2-16
    - createconfigscript() • 7-47
    - script • See createconfigscript()
  - connecting multiple instruments
    - run simultaneous scripts • 6-48
    - TSP-Link • 6-44, 6-48
  - connection
    - connect rule (channel) • 7-18
    - methods • 2-82

contact information • 1-1  
 counts • 3-4  
 createconfigscript() • 7-47  
 crosspoint • 2-14  
   display (crosspoint) • 2-15  
 cursor • 7-65

**D**

data queue • 6-51  
 dataqueue functions and attributes • 5-7  
 digital I/O  
   port • 2-7  
   reading lines (digital I/O) • 2-8  
 digital I/O port  
   +5V output • 2-8  
   bit weighting • 2-9  
 display  
   DISPLAY key • 2-16  
   Model 707B front panel • 2-11  
   Model 708B front panel • 2-11  
 DMM  
   attributes, existing scan • 3-6  
 dry-clamp open lead detector  
   event log • 5-9

**E**

either edge trigger mode • 3-16  
 error messages  
   retrieving • 8-2  
 errors  
   effects on scripts • 8-2  
   summary • 8-1  
 ethernet connector (RJ-45) • 2-4  
 event blenders • 3-21  
 examples  
   script • 6-53  
   using attributes • 5-2  
 extended warranty • 1-1

**F**

falling edge trigger mode • 3-14  
 foreground scan execution • 3-7  
 front panel  
   display • 2-14, 2-16, 2-18  
   keys • 2-16  
   Model 707B front panel • 2-11  
   Model 708B front panel • 2-11  
   scanning • 3-6  
 functions • 5-1  
   Lua • 6-14

**G**

gpib attribute  
   gpib.address • 7-92

groups, TSP-Link  
   assigning • 6-49  
   coordinating overlapped operations • 6-50  
   leader • 6-49  
   manage nodes • 6-48

**H**

hot switching • 7-18

**K**

Keithley I/O layer • 2-59  
 Keithley website • 10-1  
 keys • 2-16

**L**

LAN  
   events • 3-21  
   MAC address • 7-104  
   status light • 2-18  
 libraries, standard • 6-25  
 local group • 7-135  
 logical  
   logical AND operation • 7-9  
   logical OR operation • 7-9  
 loop control • 6-20  
 Lua • 6-11  
   reference • 6-11

**M**

MAC address • 7-104  
 make-before-break • 2-82  
 manuals • 10-1  
 master  
   node reset • 7-135  
   node, TSP-Link • 6-49  
   trigger mode • 3-15, 3-17  
 math  
   library functions • 6-28  
 matrix card notation • 2-81  
 memory functions  
   memory.available() • 7-129  
   memory.used() • 7-130  
 modules  
   identify installed • 2-85  
 multiple instruments, connecting  
   run simultaneous scripts • 6-48  
   TSP-Link • 6-44, 6-48

**N**

named scripts  
   overview • 6-4  
   running • 6-5, 6-6  
 navigation wheel • 2-16  
 node

- assign number • 6-46
- master overview • 6-49
- nonvolatile memory
  - storage of scripts • 6-2

**O**

- operator precedence • 6-18
- operators (Lua) • 6-16
- overlapped operations • 6-50
- overlapped operations in remote groups,
  - coordinating • 6-50

**P**

- parallel test scripts • 6-49
- power
  - blinking • 7-65
- POWER switch • 2-16
- programming • 5-3, See command
  - interaction • 6-33
  - script model • 6-3
- pseudocards • 2-98

**Q**

- queries • 5-3
- queues • C-2
  - error • C-2
  - event • C-2
  - output • C-2

**R**

- reading buffer
  - removing stale values • 6-52
- registers
  - enable and transition • C-20
  - programming example • C-15
  - reading • C-15
  - serial polling and SRQ • C-18
  - service request enable (registers) • C-16
- relay closure count • 2-85
- remote programming
  - command reference • 7-1
  - remote commands • 5-1
- reset
  - digio trigger • 7-58
  - lan • 7-101
  - localnode • 7-124
  - reset • 7-135
  - scan • 7-146
  - status • 7-187
  - timer • 7-200
- rising edge
  - acceptor trigger mode • 3-15
  - master trigger mode • 3-15
  - trigger mode • 3-15

- RJ-45
  - Ethernet connector • 2-4
- run-time environment
  - script, restoring • 6-42
  - storage of scripts • 6-2

**S**

- scanning
  - counts • 3-4
  - execution, foreground and background • 3-7
  - fundamentals • 3-1
- script editor • 6-33
- scripts • 5-3, 6-2
  - autoexec • 6-7
  - autorun scripts • 6-6
  - deleting • 6-41
  - error effects • 8-2
  - examples • 6-53
  - function, using • 6-16
  - interactive • 6-3
  - name attribute • 7-162
  - named • 6-4, 6-6
  - parallel test, running • 6-49
  - restoring in run-time environment • 6-42
  - run • 6-5, 6-6, 6-49
  - script editor • 6-33
  - test scripts across the TSP-Link network • 6-51
  - unnamed • 6-5
  - user • 6-3, 6-5, 6-39
- scripts, error effects • 8-2
- serial polling • C-18
- slot
  - slot list description • 2-14
- SRQ (service request) • C-16
- state • 6-52
- status
  - LAN status indicator • 2-18
- status byte and service request (SRQ) • C-16
  - commands • C-20
- status model • C-1
  - clearing registers and queues • C-13
  - programming registers and queues • C-13
  - queues • C-2
  - reading registers • C-15
  - status byte and SRQ • C-1, C-16
  - status register sets • C-1
  - TSP-Link system • C-21
- status register sets • C-1
- step counts • 3-4
- string library functions • 6-26
- substring • 6-26
- synchronous
  - acceptor trigger mode • 3-19
  - master trigger mode • 3-17
  - trigger mode • 3-19

triggering modes, understanding • 3-17

## T

Test Script Builder • 6-31

time • 7-165, 7-166

trigger mode • 3-15, 3-19

access trigger mode • 3-15, 3-19

either edge • 3-16

falling edge • 3-14

rising edge acceptor • 3-15

rising edge master • 3-15

synchronous • 3-19

synchronous acceptor • 3-19

synchronous master • 3-17

syntax rules • 7-2

Trigger model

components • 3-3

Described • 3-1

troubleshooting

web page • 2-66

TSB Embedded

installing software • 6-32

TSP • 5-1

programming methods • 6-1

TSP-Link • 6-44, 6-48

advanced features • 6-44

communicating between TSP-enabled  
instruments • 6-54

groups • 6-48, 6-49, 6-50

initialization • 6-46

node numbers • 6-46

nodes • 6-48

reset • 6-46

## U

unnamed scripts • 6-5

USB

setup, USB • 2-23

user scripts

creating • 6-3

modifying • 6-39

running • 6-5

save • 6-7

userstring functions • 6-48

add • 7-239

catalog • 7-240

delete • 7-241

get • 7-242

UTC • 7-165

## V

variables • 6-12

## W

warranty • 1-1

web interface

Home page • 2-66

Specifications are subject to change without notice.  
All Keithley trademarks and trade names are the property of Keithley Instruments.  
All other trademarks and trade names are the property of their respective companies.

Keithley Instruments  
Corporate Headquarters • 28775 Aurora Road • Cleveland, Ohio 44139 • 440-248-0400 • Fax: 440-248-6168 • 1-800-935-5595 • [www.keithley.com](http://www.keithley.com)

---



A Greater Measure of Confidence