

# Model DMM6500 6½-Digit Multimeter

## User's Manual

DMM6500-900-01 Rev. B / August 2019



DMM6500-900-01B

Model DMM6500  
6½ Digit Multimeter  
User's Manual

© 2019, Keithley Instruments, LLC

Cleveland, Ohio, U.S.A.

All rights reserved.

Any unauthorized reproduction, photocopy, or use of the information herein, in whole or in part, without the prior written approval of Keithley Instruments, LLC, is strictly prohibited.

These are the original instructions in English.

TSP®, TSP-Link®, and TSP-Net® are trademarks of Keithley Instruments, LLC. All Keithley Instruments product names are trademarks or registered trademarks of Keithley Instruments, LLC.

Other brand names are trademarks or registered trademarks of their respective holders.

The Lua 5.0 software and associated documentation files are copyright © 1994 - 2015, Lua.org, PUC-Rio. You can access terms of license for the Lua software and associated documentation at the Lua licensing site (<http://www.lua.org/license.html>).

Microsoft, Visual C++, Excel, and Windows are either registered trademarks or trademarks of Microsoft Corporation in the United States and/or other countries.

Document number: DMM6500-900-01 Rev. B / August 2019

The following safety precautions should be observed before using this product and any associated instrumentation. Although some instruments and accessories would normally be used with nonhazardous voltages, there are situations where hazardous conditions may be present.

This product is intended for use by personnel who recognize shock hazards and are familiar with the safety precautions required to avoid possible injury. Read and follow all installation, operation, and maintenance information carefully before using the product. Refer to the user documentation for complete product specifications.

If the product is used in a manner not specified, the protection provided by the product warranty may be impaired.

The types of product users are:

**Responsible body** is the individual or group responsible for the use and maintenance of equipment, for ensuring that the equipment is operated within its specifications and operating limits, and for ensuring that operators are adequately trained.

**Operators** use the product for its intended function. They must be trained in electrical safety procedures and proper use of the instrument. They must be protected from electric shock and contact with hazardous live circuits.

**Maintenance personnel** perform routine procedures on the product to keep it operating properly, for example, setting the line voltage or replacing consumable materials. Maintenance procedures are described in the user documentation. The procedures explicitly state if the operator may perform them. Otherwise, they should be performed only by service personnel.

**Service personnel** are trained to work on live circuits, perform safe installations, and repair products. Only properly trained service personnel may perform installation and service procedures.

Keithley products are designed for use with electrical signals that are measurement, control, and data I/O connections, with low transient overvoltages, and must not be directly connected to mains voltage or to voltage sources with high transient overvoltages. Measurement Category II (as referenced in IEC 60664) connections require protection for high transient overvoltages often associated with local AC mains connections. Certain Keithley measuring instruments may be connected to mains. These instruments will be marked as category II or higher.

Unless explicitly allowed in the specifications, operating manual, and instrument labels, do not connect any instrument to mains.

Exercise extreme caution when a shock hazard is present. Lethal voltage may be present on cable connector jacks or test fixtures. The American National Standards Institute (ANSI) states that a shock hazard exists when voltage levels greater than 30 V RMS, 42.4 V peak, or 60 VDC are present. A good safety practice is to expect that hazardous voltage is present in any unknown circuit before measuring.

Operators of this product must be protected from electric shock at all times. The responsible body must ensure that operators are prevented access and/or insulated from every connection point. In some cases, connections must be exposed to potential human contact. Product operators in these circumstances must be trained to protect themselves from the risk of electric shock. If the circuit is capable of operating at or above 1000 V, no conductive part of the circuit may be exposed.

Do not connect switching cards directly to unlimited power circuits. They are intended to be used with impedance-limited sources. NEVER connect switching cards directly to AC mains. When connecting sources to switching cards, install protective devices to limit fault current and voltage to the card.

Before operating an instrument, ensure that the line cord is connected to a properly-grounded power receptacle. Inspect the connecting cables, test leads, and jumpers for possible wear, cracks, or breaks before each use.

When installing equipment where access to the main power cord is restricted, such as rack mounting, a separate main input power disconnect device must be provided in close proximity to the equipment and within easy reach of the operator.

For maximum safety, do not touch the product, test cables, or any other instruments while power is applied to the circuit under test. ALWAYS remove power from the entire test system and discharge any capacitors before: connecting or disconnecting cables or jumpers, installing or removing switching cards, or making internal changes, such as installing or removing jumpers.

Do not touch any object that could provide a current path to the common side of the circuit under test or power line (earth) ground. Always make measurements with dry hands while standing on a dry, insulated surface capable of withstanding the voltage being measured.

For safety, instruments and accessories must be used in accordance with the operating instructions. If the instruments or accessories are used in a manner not specified in the operating instructions, the protection provided by the equipment may be impaired.

Do not exceed the maximum signal levels of the instruments and accessories. Maximum signal levels are defined in the specifications and operating information and shown on the instrument panels, test fixture panels, and switching cards.

When fuses are used in a product, replace with the same type and rating for continued protection against fire hazard.

Chassis connections must only be used as shield connections for measuring circuits, NOT as protective earth (safety ground) connections.

If you are using a test fixture, keep the lid closed while power is applied to the device under test. Safe operation requires the use of a lid interlock.

If a  screw is present, connect it to protective earth (safety ground) using the wire recommended in the user documentation.

The  symbol on an instrument means caution, risk of hazard. The user must refer to the operating instructions located in the user documentation in all cases where the symbol is marked on the instrument.

The  symbol on an instrument means warning, risk of electric shock. Use standard safety precautions to avoid personal contact with these voltages.

The  symbol on an instrument shows that the surface may be hot. Avoid personal contact to prevent burns.

The  symbol indicates a connection terminal to the equipment frame.

If this  symbol is on a product, it indicates that mercury is present in the display lamp. Please note that the lamp must be properly disposed of according to federal, state, and local laws.

The **WARNING** heading in the user documentation explains hazards that might result in personal injury or death. Always read the associated information very carefully before performing the indicated procedure.

The **CAUTION** heading in the user documentation explains hazards that could damage the instrument. Such damage may invalidate the warranty.

The **CAUTION** heading with the  symbol in the user documentation explains hazards that could result in moderate or minor injury or damage the instrument. Always read the associated information very carefully before performing the indicated procedure. Damage to the instrument may invalidate the warranty.

Instrumentation and accessories shall not be connected to humans.

Before performing any maintenance, disconnect the line cord and all test cables.

To maintain protection from electric shock and fire, replacement components in mains circuits — including the power transformer, test leads, and input jacks — must be purchased from Keithley. Standard fuses with applicable national safety approvals may be used if the rating and type are the same. The detachable mains power cord provided with the instrument may only be replaced with a similarly rated power cord. Other components that are not safety-related may be purchased from other suppliers as long as they are equivalent to the original component (note that selected parts should be purchased only through Keithley to maintain accuracy and functionality of the product). If you are unsure about the applicability of a replacement component, call a Keithley office for information.

Unless otherwise noted in product-specific literature, Keithley instruments are designed to operate indoors only, in the following environment: Altitude at or below 2,000 m (6,562 ft); temperature 0 °C to 50 °C (32 °F to 122 °F); and pollution degree 1 or 2.

To clean an instrument, use a cloth dampened with deionized water or mild, water-based cleaner. Clean the exterior of the instrument only. Do not apply cleaner directly to the instrument or allow liquids to enter or spill on the instrument. Products that consist of a circuit board with no case or chassis (e.g., a data acquisition board for installation into a computer) should never require cleaning if handled according to instructions. If the board becomes contaminated and operation is affected, the board should be returned to the factory for proper cleaning/servicing.

Safety precaution revision as of June 2017.

# Table of contents

---

<b>Introduction .....</b>	<b>1-1</b>
Welcome .....	1-1
Introduction to this manual .....	1-1
Contact information .....	1-2
Extended warranty .....	1-2
Documentation set .....	1-2
Organization of manual sections .....	1-3
Application examples .....	1-3
<b>Front-panel overview .....</b>	<b>2-1</b>
Front-panel overview .....	2-1
Instrument power .....	2-3
Connect the power cord .....	2-3
Turn the DMM6500 on or off .....	2-4
Touchscreen display .....	2-4
Select items on the touchscreen .....	2-5
Scroll bars .....	2-5
Enter information .....	2-6
Adjust the backlight brightness and dimmer .....	2-6
Review event messages .....	2-7
Interactive swipe screens .....	2-7
Swipe screen heading bar .....	2-7
FUNCTIONS swipe screen .....	2-9
SETTINGS swipe screen .....	2-9
STATISTICS swipe screen .....	2-10
SECONDARY swipe screen .....	2-10
USER swipe screen .....	2-11
GRAPH swipe screen .....	2-12
SCAN swipe screen .....	2-12
Menu overview .....	2-14
Channel menu .....	2-14
Measure menu .....	2-15
Views menu .....	2-15
Trigger menu .....	2-16
Scripts menu .....	2-16
System menu .....	2-17
<b>Using a remote interface .....</b>	<b>3-1</b>
Remote communications interfaces .....	3-1
Supported remote interfaces .....	3-1
LAN communications .....	3-2
Set up LAN communications on the instrument .....	3-3
Set up LAN communications on the computer .....	3-4
USB communications .....	3-5

Connect a computer to the DMM6500 using USB.....	3-6
Communicate with the instrument .....	3-6
<b> GPIB communications.....</b>	<b>3-10</b>
Install the KTTI-GPIB accessory card .....	3-10
Set the GPIB address .....	3-13
<b> RS-232 .....</b>	<b>3-13</b>
Install the KTTI-RS232 accessory card.....	3-14
<b> TSP-Link .....</b>	<b>3-16</b>
Install the KTTI-TSP accessory card.....	3-16
<b> Using the web interface.....</b>	<b>3-18</b>
Connect to the instrument web interface.....	3-18
LAN troubleshooting suggestions.....	3-18
Web interface Home page.....	3-19
Identify the instrument.....	3-20
<b> Determining the command set you will use .....</b>	<b>3-20</b>
<b> Making basic front-panel measurements .....</b>	<b>4-1</b>
Introduction .....	4-1
Equipment required for this example .....	4-1
Device connections .....	4-1
Basic front-panel measurements .....	4-2
View measurement data .....	4-3
<b> Measuring DC voltage with high accuracy .....</b>	<b>5-1</b>
Introduction .....	5-1
Equipment required.....	5-1
Device connections .....	5-1
Measuring DCV with high accuracy .....	5-3
Using the front panel.....	5-4
Using SCPI commands .....	5-5
Using TSP commands .....	5-5
Test results.....	5-6
<b> Measuring 4-wire resistance with offset compensation.....</b>	<b>6-1</b>
Introduction .....	6-1
Equipment required.....	6-2
Device connections .....	6-2
Measuring 4-wire resistance with offset compensation .....	6-4
Using the front panel .....	6-4
Using SCPI commands .....	6-5
Using TSP commands .....	6-5
Test results.....	6-6
<b> Scanning temperature at a set time interval.....</b>	<b>7-1</b>
Introduction .....	7-1

Equipment required.....	7-1
Device connections.....	7-2
Sample temperatures at a specific time interval.....	7-4
Using the front panel.....	7-4
Using SCPI commands.....	7-5
Using TSP.....	7-6
Test results.....	7-8
<b>Grading and binning resistors.....</b>	<b>8-1</b>
Introduction.....	8-1
Equipment required.....	8-1
Device connections.....	8-1
Resistor grading and binning test.....	8-3
Trigger model template settings for the grade and binning test.....	8-4
Using SCPI commands.....	8-4
Using TSP commands.....	8-6
<b>Measuring power using digitizing and TSP-Link.....</b>	<b>9-1</b>
Introduction.....	9-1
Equipment required.....	9-2
Device connections.....	9-2
Measuring power using digitizing and TSP-Link.....	9-4
Using SCPI commands.....	9-4
Setting up the nodes for TSP code.....	9-4
Using TSP commands.....	9-5
Results.....	9-7
<b>Troubleshooting FAQs.....</b>	<b>10-1</b>
About this section.....	10-1
Where can I find updated drivers?.....	10-1
Is there any software to help me get started?.....	10-2
How do I upgrade the firmware?.....	10-2
Why can't the DMM6500 read my USB flash drive?.....	10-2
How do I change the command set?.....	10-3
How do I save the present state of the instrument?.....	10-5
Why did my settings change?.....	10-2
How do I save what is displayed on the screen?.....	10-6
What is the ethernet port number?.....	10-6
<b>Next steps.....</b>	<b>11-1</b>
Additional DMM6500 information.....	11-1



---

## Introduction

### In this section:

Welcome .....	1-1
Introduction to this manual .....	1-1
Contact information .....	1-2
Extended warranty .....	1-2
Documentation set .....	1-2
Organization of manual sections .....	1-3
Application examples .....	1-3

## Welcome

Thank you for choosing a Keithley Instruments product. The DMM6500 is a 6½ digit bench/system digital multimeter with scanning that expands standard DMM functions with high-speed digitizing and large graphical color touchscreen display. This DMM offers a broad range of measurement capabilities, including 15 measurement functions. In addition to industry-leading DC accuracies, functions such as capacitance, 10 A current, and 16-bit current and voltage digitizing are included. Tying all these features together is a large 5-inch color touchscreen display that brings you an unprecedented combination of data visualization and interaction, enabling you to gain deeper insight into your measurements.

The DMM6500 provides superior measurement accuracy and the speed necessary for a broad range of applications, from system applications and production testing to benchtop applications. The DMM6500 meets application requirements for production engineers, research and development engineers, test engineers, and scientists.

## Introduction to this manual

This manual provides detailed applications to help you achieve success with your Keithley Instruments DMM6500. It also provides information about the basics of the front panel to familiarize you with the instrument.

Each application includes an overview, followed by instructions to complete the application using the front panel, SCPI code, TSP® code, or Keithley KickStart Software.

More information about the commands that are used in these applications is available. Refer to the SCPI and TSP command reference sections of the *Model DMM6500 Reference Manual*. This manual is available at [tek.com/keithley](http://tek.com/keithley).

## Contact information

If you have any questions after you review the information in this documentation, please contact your local Keithley Instruments office, sales partner, or distributor. You can also call the corporate headquarters of Keithley Instruments (toll-free inside the U.S. and Canada only) at 1-800-935-5595, or from outside the U.S. at +1-440-248-0400. For worldwide contact numbers, visit the [Keithley Instruments website](http://tek.com/keithley) ([tek.com/keithley](http://tek.com/keithley)).

## Extended warranty

Additional years of warranty coverage are available on many products. These valuable contracts protect you from unbudgeted service expenses and provide additional years of protection at a fraction of the price of a repair. Extended warranties are available on new and existing products. Contact your local Keithley Instruments office, sales partner, or distributor for details.

## Documentation set

The documentation for the DMM6500 is available on the [Keithley Instruments website](http://tek.com/keithley) ([tek.com/keithley](http://tek.com/keithley)). The documentation includes:

- **Quick Start Guide:** Provides unpacking instructions, describes basic connections, reviews basic operation information, and provides a quick test procedure to ensure the instrument is operational.
- **User's Manual:** Provides application examples that you can use as a starting point to create your own applications.
- **Reference Manual:** Includes advanced operation topics, maintenance information, troubleshooting procedures, and in-depth descriptions of programming commands.
- **Accessories information:** Documentation for accessories that are available for the DMM6500.

For the latest drivers and additional support information, see [tek.com/keithley](http://tek.com/keithley).

## Organization of manual sections

This manual is organized into the following sections:

- [Front-panel overview](#): (on page 2-1) Describes the basics of using the front-panel interface.
- [Using the remote interface](#): (on page 3-1) Describes the basics of remote communications and using the instrument web interface.
- Application examples (see below): Provides detailed examples of how to use the DMM6500 in some typical situations.
- [Troubleshooting FAQs](#): (on page 10-1) Provides answers to frequently asked questions to help you troubleshoot common problems encountered with the DMM6500.
- [Next steps](#): (on page 11-1) Provides information about additional resources that can help you use the DMM6500.

## Application examples

This manual provides application examples that show you how to perform tests from the front panel and over a remote interface. The applications include:

- [Making basic front-panel measurements](#): (on page 4-1) Shows the basic measure functionality using a single DMM6500 and a two-terminal device under test.
- [Measuring DC voltage with high accuracy](#): (on page 5-1) Shows how to use a DMM6500 to make a high-accuracy DC voltage measurement.
- [Measuring 4-wire resistance with offset compensation](#): (on page 6-1) Shows how to use the DMM6500 to accurately measure a resistance device.
- [Scanning temperature at a set time interval](#): (on page 7-1) Shows how to use the DMM6500 to log temperature measurement data every minute over a 24-hour period.
- [Grading and binning resistors](#): (on page 8-1) Shows how to use the DMM6500 to perform benchtop binning operations using the trigger model and digital I/O to control external component-handling devices.
- [Measuring power using digitizing and TSP-Link](#): (on page 9-1) Shows how to configure two DMM6500s to measure the power consumed by a Bluetooth® low-energy device using TSP-Link®.

## Front-panel overview

### In this section:



Front-panel overview.....	2-1
Instrument power .....	2-3
Touchscreen display .....	2-4
Interactive swipe screens .....	2-7
Menu overview .....	2-14





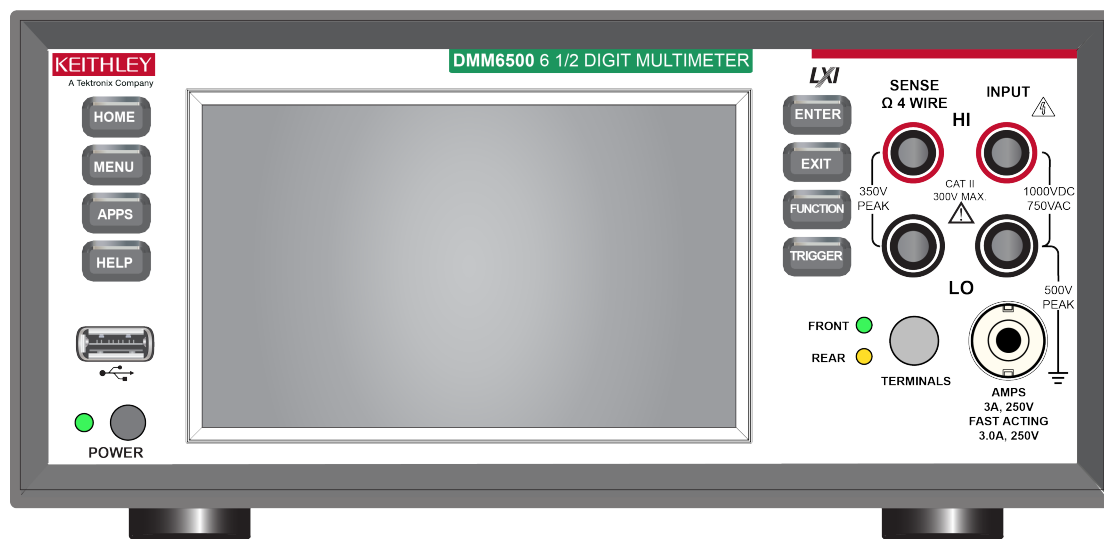



## Front-panel overview

The front panel of the DMM6500 is shown below. Descriptions of the controls on the front panel follow the figure.

Figure 1: DMM6500 front panel

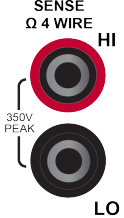
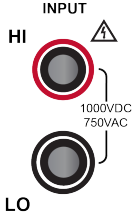

<b>POWER switch</b>	 POWER	Turns the instrument on or off. To turn the instrument on, press the power switch. To turn it off, press and hold the power switch. The LED is green when the instrument is on and the LED is amber when turned off.
<b>HOME key</b>		Returns the display to the home screen.
<b>MENU key</b>		Opens the main menu. Press the icons on the main menu to open channel, measure, views, trigger, scripts, and system screens. For details, refer to <a href="#">Menu overview</a> (on page 2-14).

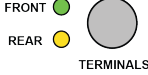
<b>APPS key</b>		Opens a menu of of preconfigured TSP scripts with a graphical user interface.
<b>HELP key</b>		Opens help for the area or item that is selected on the display. If there is no selection when you press the <b>HELP</b> key, it displays overview information for the screen you are viewing. To display help, hold the on-screen button while pressing the <b>HELP</b> key.
<b>USB port</b>		Saves reading buffer data and screen snapshots to a USB flash drive. You can also store and retrieve scripts to and from a USB flash drive. The flash drive must be formatted as a FAT or FAT32 drive.
<b>Touchscreen</b>		The DMM6500 has a high-resolution, five-inch color touchscreen display. The touchscreen accesses swipe screens and menu options. You can access additional screens by pressing the front-panel <b>MENU</b> , <b>APPS</b> , and <b>FUNCTION</b> keys. Refer to <a href="#">Touchscreen display</a> (on page 2-4) for details.
<b>ENTER key</b>		Selects the highlighted choice or allows you to edit the selected field.
<b>EXIT key</b>		Returns to the previous screen or closes a dialog box. For example, press the <b>EXIT</b> key when the main menu is displayed to return to the home screen. When you are viewing a subscreen (for example, the Event Log screen), press the <b>EXIT</b> key to return to the main menu screen.
<b>TRIGGER key</b>		Accesses trigger-related settings and operations. The action of the <b>TRIGGER</b> key depends on the instrument state. For details, see "Switching between measurement methods" in the <i>Model DMM6500 Reference Manual</i> .
<b>SENSE terminals</b>		Use the SENSE HI and SENSE LO terminals and the INPUT terminals with the 4-wire resistance, 3-wire and 4-wire RTD temperature, and DC voltage ratio functions.
<b>INPUT terminals</b>		Use the INPUT HI and INPUT LO terminals for all measurements except current.
<b>AMPS</b>		Use the AMPS connection with the INPUT LO terminal to measure $\leq 3A$ DC or $AC_{RMS}$ current.
<b>TERMINALS switch</b>		Activates the terminals on the front or rear panel. Selecting the rear panel provides the proper connections to an inserted scanner card. When the front-panel terminals are active, the green LED is visible. When the rear-panel terminals are active, the amber LED is visible.

## Instrument power

Follow the steps below to connect the DMM6500 to line power and turn on the instrument. The DMM6500 operates from a line voltage of 100 V to 240 V at a frequency of 50 Hz, 60 Hz, or 400 Hz. It automatically senses line frequency. Make sure the operating voltage in your area is compatible.

The fuse is set to the expected voltage at the factory. Make sure that the correct line voltage is displayed on the power module. See "Line voltage verification" in the *Model DMM6500 Reference Manual* for more information.

---

### NOTE

You must turn on the DMM6500 and allow it to warm up for at least 30 minutes to achieve rated accuracies.

---

### CAUTION

**Operating the instrument on an incorrect line voltage may cause damage to the instrument, possibly voiding the warranty.**

---

### WARNING

**The power cord supplied with the DMM6500 contains a separate protective earth (safety ground) wire for use with grounded outlets. When proper connections are made, the instrument chassis is connected to power-line ground through the ground wire in the power cord. In the event of a failure, not using a properly grounded protective earth and grounded outlet may result in personal injury or death due to electric shock.**

**Do not replace detachable mains supply cords with inadequately rated cords. Failure to use properly rated cords may result in personal injury or death due to electric shock.**

**Before installing the instrument, disconnect all external power from the equipment and disconnect the line cord. Failure to disconnect all power may expose you to hazardous voltages, which, if contacted, could cause personal injury or death.**

---

## Connect the power cord

When you connect the power cord, the instrument may power on, depending on the state of the front-panel POWER switch.

### ***To connect the power cord:***

1. Connect the female end of the supplied power cord to the AC receptacle on the rear panel.
2. Connect the male end of the power cord to a grounded AC outlet.

## Turn the DMM6500 on or off

---

### NOTE

On some sensitive or easily damaged devices under test (DUTs), the instrument power-up and power-down sequence can apply transient signals to the DUT that may affect or damage it. When testing this type of DUT, do not make final connections to it until the instrument has completed its power-up sequence and is in a known operating state. When testing this type of DUT, disconnect it from the instrument before turning the instrument off.

To prevent any human contact with a live conductor, connections to the DUT must be fully insulated and the final connections to the DUT must only use safety-rated safety jack socket connectors that do not allow bodily contact.

---

#### ***To turn a DMM6500 on:***

1. Disconnect any devices under test (DUTs) from the DMM6500.
2. Press the front-panel **POWER** switch to place it in the on position.

The instrument displays a status bar as the instrument powers on. The home screen is displayed when power on is complete.

#### ***To turn a DMM6500 off:***

1. Press and hold the front-panel **POWER** switch to place it in the off position.

## Touchscreen display

The touchscreen display gives you quick front-panel access to measure settings, system configuration, instrument and test status, reading buffer information, and other instrument functionality. The display has multiple swipe screens that you can access by swiping the front panel. You can access additional interactive screens by pressing the front-panel MENU, APPS, and FUNCTION keys.

---

### CAUTION

**Do not use sharp metal objects, such as tweezers or screwdrivers, or pointed objects, such as pens or pencils, to touch the touchscreen. It is strongly recommended that you use only fingers to operate the instrument. Use of clean-room gloves to operate the touchscreen is supported.**

---

## Select items on the touchscreen

To select an item on the displayed screen, press the corresponding icon on the screen.

The following topics describe the DMM6500 touchscreen in more detail.

## Scroll bars

Some of the interactive screens have additional options that are only visible when you scroll down the screen. A scroll indicator on the right side of the touchscreen identifies these screens. Swipe the screen up or down to view the additional options.

The figure below shows a screen with a scroll bar.

Figure 2: Scroll bar

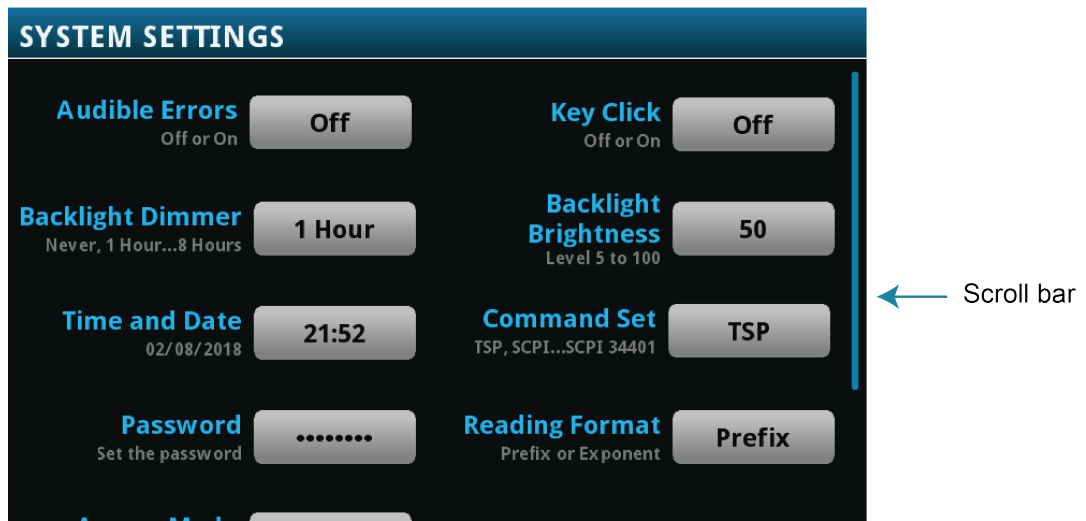



## Enter information

Some of the menu options open a keypad or keyboard that you can use to enter information. For example, if you are creating a new reading buffer from the front panel, you see the keypad shown in the following figure.

Figure 3: DMM6500 front-panel keyboard for information entry



You can enter information by touching the screen to select characters and options from the keypad or keyboard. You can move the cursor in the entry box by touching the screen. The cursor is moved to the spot in the entry box where you touched the screen.

## Adjust the backlight brightness and dimmer

You can adjust the brightness of the DMM6500 touchscreen display and buttons from the front panel or over a remote interface. You can also set the backlight to dim after a specified time has passed with no front-panel activity (available from the front-panel display only). The backlight settings set through the front-panel display are saved through a reset or power cycle.

---

### NOTE

Screen life is affected by how long the screen is on at full brightness. The higher the brightness setting and the longer the screen is bright, the shorter the screen life.

---

**To adjust the backlight brightness from the front panel:**

1. Press the **MENU** key.
2. Under System, select **Settings**.
3. Select the **Backlight Brightness**. The Backlight Brightness dialog box opens.
4. Drag the adjustment to set the backlight.
5. Select **OK**.

**To set the backlight dimmer from the front panel:**

1. Press the **MENU** key.
2. Under System, select **Settings**.
3. Select **Backlight Dimmer**. The Backlight Dimmer dialog box opens.
4. Select a dimmer setting.

## Review event messages

During operation and programming, front-panel messages may be briefly displayed. Messages are either information, warning, or error notifications. For information on event messages, refer to "Using the event log" in the *Model DMM6500 Reference Manual*.

**Figure 4: Example front-panel event message**

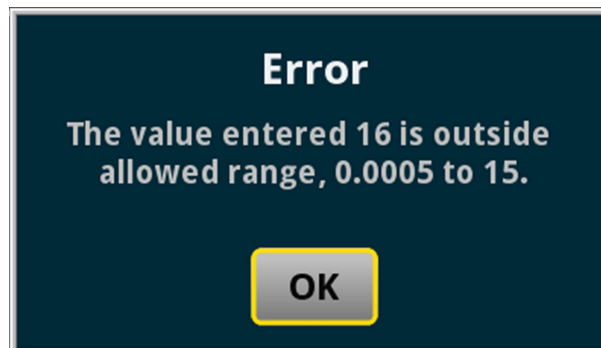

## Interactive swipe screens







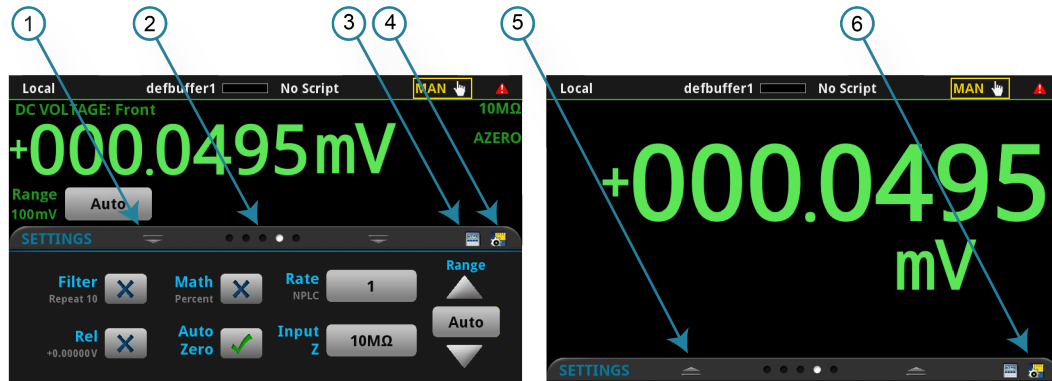

The DMM6500 touchscreen display has multiple screens that you can access by swiping left or right on the lower half of the display. The options available in the swipe screens are described in the following topics.

### Swipe screen heading bar

The heading bar of the swipe screen contains the following options.

Figure 5: DMM6500 swipe screens, maximized and minimized



#	Screen element	Description
1	Minimize indicator 	You can swipe down to minimize the swipe screens.
2	Swipe screen indicator 	Each circle represents one swipe screen. As you swipe right or left, a different circle changes color, indicating where you are in the screen sequence. Select a circle to move the swipe screen without swiping.
3	Calculations shortcut 	Select to open the CALCULATION SETTINGS menu. Only available when TERMINALS is set to FRONT.
4	Measure Settings shortcut 	Select to open the MEASURE SETTINGS menu for the selected function. Only available when TERMINALS is set to FRONT.
5	Restore indicator 	Indicates that you can swipe up to display the swipe screen.
6	Graph shortcut 	Select to open the Graph screen.
	Channel Settings shortcut 	Not shown. Select to open the CHANNEL SETTINGS screen. This shortcut is on the settings swipe screen when there is an active closed channel and the terminals are set to rear.
	Scan shortcut 	Not shown. Select to open the SCAN screen. This shortcut is available when the terminals are set to rear.
	Channel control shortcut 	Not shown. Select to open the CHANNEL CONTROL screen. This shortcut is available when the terminals are set to rear.

## FUNCTIONS swipe screen

The FUNCTIONS swipe screen highlights the selected measure function and allows you to select a different function.

Figure 6: FUNCTIONS swipe screen



## SETTINGS swipe screen

The SETTINGS swipe screen gives you front-panel access to some instrument settings for the selected measure function. It shows you the present settings and allows you to change them. The available settings depend on which measure function is active.

Figure 7: SETTINGS swipe screen

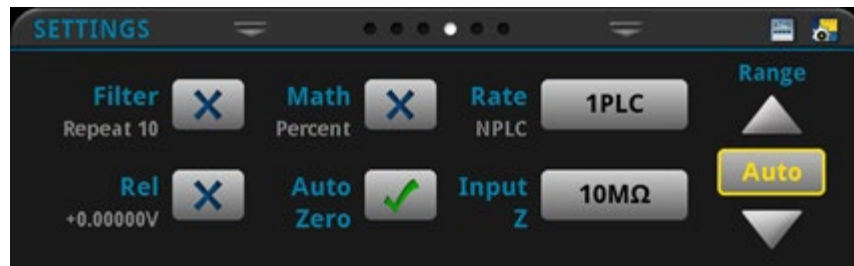

To disable or enable a setting, select the box next to the setting so that it shows an X (disabled) or a check mark (enabled).

For descriptions of the settings, select a button, then press the **HELP** key.

## STATISTICS swipe screen

The STATISTICS swipe screen contains information about the readings in the active reading buffer. When the reading buffer is configured to fill continuously and overwrite old data with new data, the buffer statistics include the data that was overwritten. To get statistics that do not include data that has been overwritten, define a large buffer size that will accommodate the number of readings you will make. You can use the **Clear Active Buffer** button on this screen to clear the data from the active reading buffer.

If multiple watch channels are set up, you can use the Channel arrows to change the display to show the statistics for each watch channel.

Figure 8: STATISTICS swipe screen

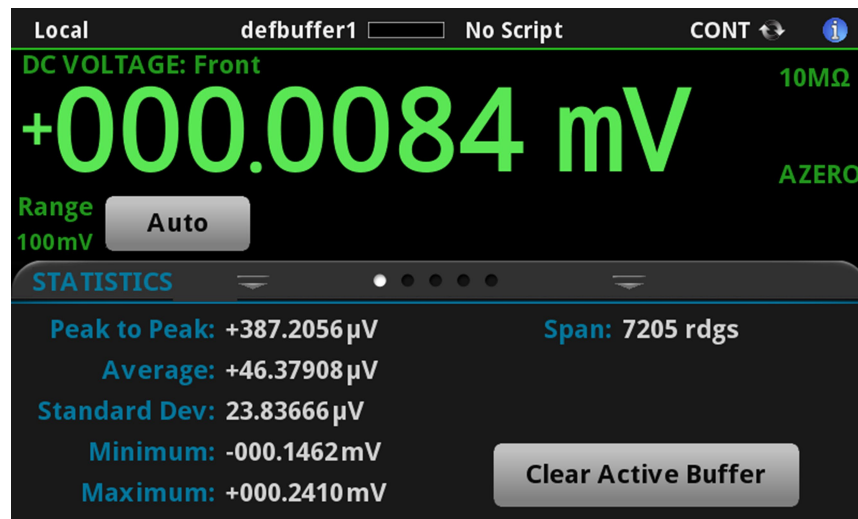

## SECONDARY swipe screen

The SECONDARY swipe screen allows you to display the results of two measurements on the front-panel display.

To start displaying secondary measurements, select the **Second Function** and select **Secondary Measure**. Secondary measurements are only available in Continuous Measurement Mode and Manual Trigger Mode. This feature is only available from the front panel of the instrument.

Refer to "Display results of two measure functions" in the *Model DMM6500 Reference Manual*.

Figure 9: SECONDARY swipe screen

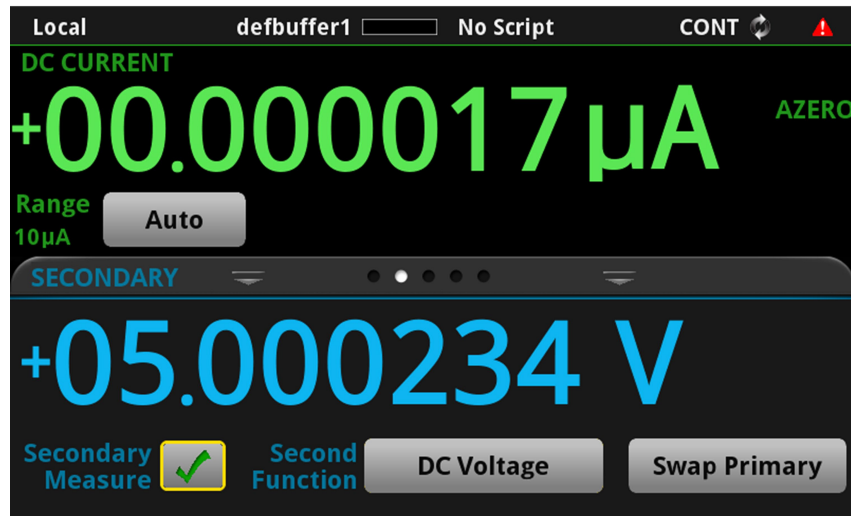

**NOTE**

Depending on the selected functions, a relay may click when the instrument switches between the measurement types. Leaving secondary measurements on for extended periods may shorten the life of the relays.

**USER swipe screen**

If you program custom text, it is displayed on the USER swipe screen. For example, you can program the DMM6500 to show that a test is in process. This swipe screen is only displayed if custom text has been defined. Refer to “Customizing a message for the USER swipe screen” in the *Model DMM6500 Reference Manual*.

Figure 10: USER swipe screen

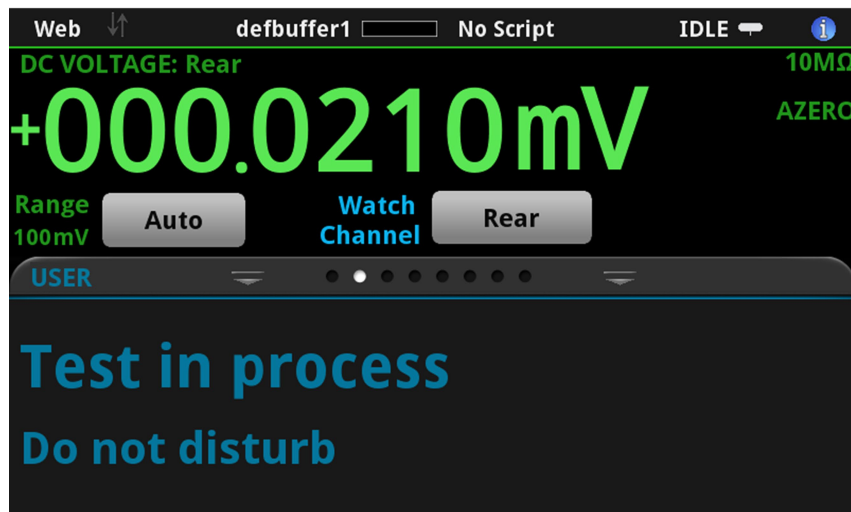

## GRAPH swipe screen

The GRAPH swipe screen shows a graphical representation of the readings in the presently selected reading buffer.

Figure 11: GRAPH swipe screen

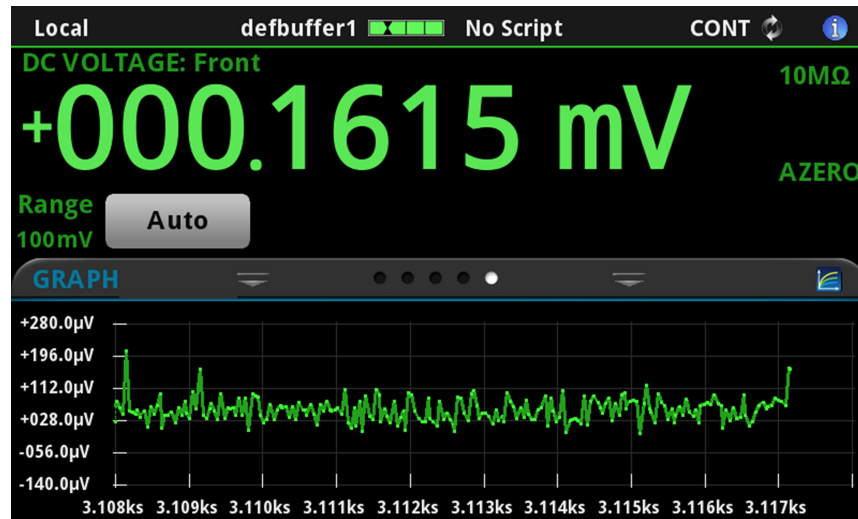

To view the graph in the full screen and to access graph settings, select the graph icon on the right side of the swipe screen header. You can also open the full-function Graph screen by pressing the **MENU** key and selecting **Graph** under Views.

For more information about graphing measurements, see “Graphing” in the *Model DMM6500 Reference Manual*.

## SCAN swipe screen

The SCAN swipe screen gives you front-panel access to build a scan, edit a scan, start a scan, step through a scan, and display scan results. You can also save the scan results to a USB flash drive.

The icon on the right side of the swipe screen heading bar is a shortcut to the Channel Scan menu. You can also use the Channel Scan menu to build or edit a scan.

When a scan is running, the remaining time and scan count are displayed.

For more information about viewing a scan preview and editing or running a scan, see “Channel scan menu” in the *Model DMM6500 Reference Manual*.

Figure 12: SCAN swipe screen - initial view

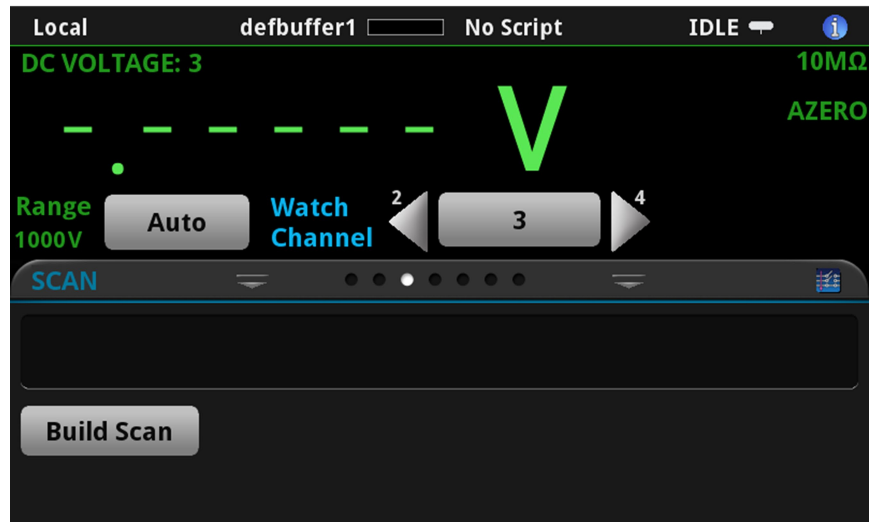
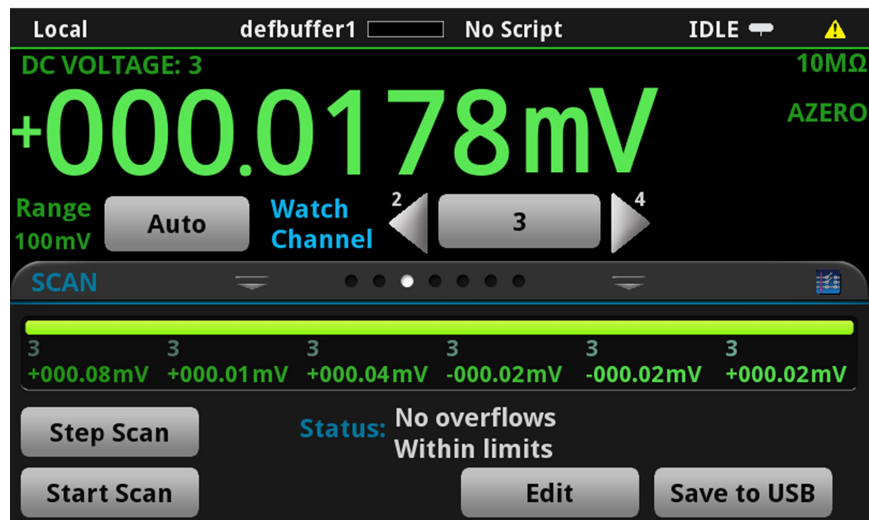

Figure 13: SCAN swipe screen - scan results



The SCAN swipe screen has the following control options:

Button	Description
Abort Scan	Stop the scan.
Build Scan	Opens the SCAN screen, where you can set up a new scan.
Edit	Opens the SCAN screen, where you can change the setup of a scan.
Pause Scan	Pauses the scan until Resume Scan is selected.
Resume Scan	Resumes a paused scan.
Save to USB	Saves the data in the scan reading buffer to a CSV file on the USB flash drive.
Start Scan	Runs a scan.
Step Scan	Incrementally steps through a scan, channel by channel.



## Menu overview

To access the main menu, press the **MENU** key on the DMM6500 front panel. The figure below shows the organization of the main menu.

Figure 14: DMM6500 main menu

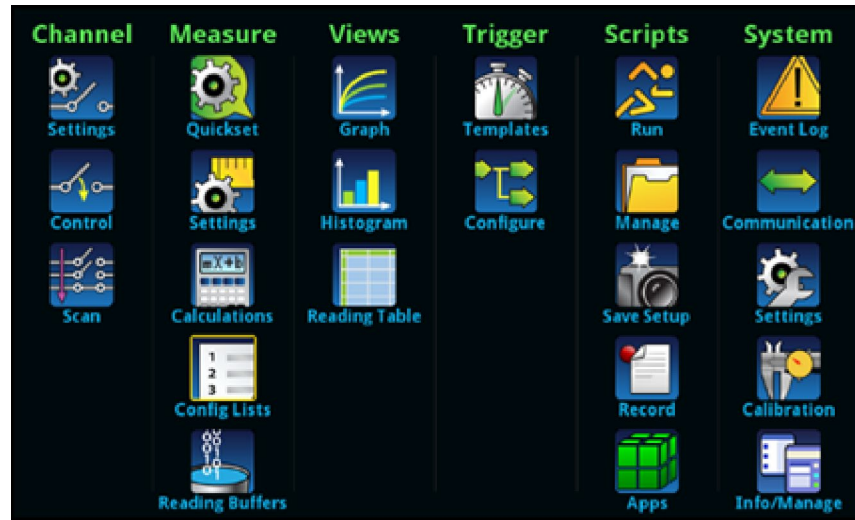

The main menu includes submenus that are labeled in green across the top of the display. Selecting an option in a submenu opens an interactive screen.

## Channel menu

The Channel menus allow you to set up and control channels and scans from the front panel.



The Channel **Settings** menu contains options to set up the measurement functions for each channel.



The Channel **Control** menu contains options to open and close channels.



The Channel **Scan** menu contains options to set up and run scans. Options include control of groups, which are channels that are sequential and have the same functions applied to them.

## Measure menu

The Measure menus allow you to select, configure, and perform measure operations from the front panel.



The **QuickSet** menu allows you to change the function and adjust performance.



The Measure **Settings** menu contains settings for the presently selected measure function, which is identified by the function indicator in the upper right corner of the menu. The available settings depend on the front-panel **FUNCTION** key selection.

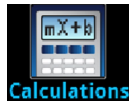

The **Calculations** menu contains settings that specify the way measurement information is processed and returned.



The **Config Lists** menu allows you to select an existing measure configuration list, create a new list, load configuration settings to and from the instrument, and view the settings of an index in a configuration list.



The **Reading Buffers** menu allows you to view the list of existing reading buffers and select one to be the active buffer. You can also create, save, delete, resize, and clear buffers from this screen.

## Views menu

The Views menus allow you to select, configure, and view data that was gathered from measure operations.



The **Graph** menu opens a screen that displays a graph of the measurements in selected reading buffers as traces. It also contains tabs that you use to customize the graph display.

You can also select the trigger mode and initiate the trigger model or scan from this screen.



The **Histogram** menu allows you to graph the distribution of measurement data in the selected reading buffer. It also contains tabs that you use to customize the histogram.



This menu allows you to view data in the selected reading buffer.

## Trigger menu

The Trigger menus allow you to configure the trigger model from the front panel.



The **Templates** menu allows you to choose from one of several preprogrammed trigger models. When you select a template, settings you can specify for that template are shown in the lower part of the screen.



The **Configure** menu allows you to view and modify the structure and parameters of a trigger model. You can also monitor trigger model operation.

## Scripts menu

The Scripts menus allow you to configure, run, and manage scripts from the front panel. Scripts are blocks of commands that the instrument can run as a group.



The **Run** menu contains a list of scripts that you can select to run immediately. You can also copy a script to a script that runs each time the instrument power is turned on. You can access scripts that are in the instrument or on a USB flash drive.



The **Manage** menu allows you to copy scripts to and from the instrument and the USB flash drive. You can also delete scripts from the instrument or USB flash drive.



The **Save Setup** menu allows you to save the present settings and configuration lists of the instrument into a configuration script. You can use this script to recall the settings.



The options in the **Record** menu allow you to record your actions and store them in a macro script. The script can be run and managed like any other script using the options in the Scripts menu or remote commands. Note that only settings are stored; no key presses or front-panel only options are stored.

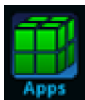

Open the APPS MANAGER, which allows you to manage prebuilt TSP® applications. TSP applications are Keithley-developed programs that enable the DMM6500 to use specialized functions, test automation, and visualize information on the user interface. TSP applications are available when the instrument is used in the TSP or SCPI command set. Many of the applications are pre-installed on your DMM6500.

## System menu

The menus under System in the main menu allow you to configure general instrument settings from the DMM6500 front panel. Among these settings are the event log, communications, backlight, time, and password settings, calibration, and system information.



The **Event Log** menu allows you to view and clear event log entries. You can also adjust which events are displayed or logged.



The **Communication** menu opens a set of tabs that contain information about the communications settings. Most of the tabs contain settings that you can change.



The **Settings** menu contains general instrument settings. It includes beeper and key click, backlight brightness and timer, time and date, system access level, password, and reading format settings.



The **Calibration** menu displays factory calibration information, including the last adjustment date, the last calibration date, and the number of times the instrument has been adjusted.



The **Info/Manage** menu gives you access to version and serial number information and settings for instrument firmware and reset functions.

---

## Using a remote interface

### In this section:

Remote communications interfaces .....	3-1
Supported remote interfaces .....	3-1
LAN communications .....	3-2
USB communications .....	3-5
GPIB communications .....	3-10
RS-232 .....	3-13
TSP-Link .....	3-16
Using the web interface .....	3-18
Determining the command set you will use .....	3-20

## Remote communications interfaces

You can choose from one of several communication interfaces to send commands to and receive responses from the DMM6500.

The instrument automatically detects the type of communications interface (LAN, USB, GPIB, RS-232, or TSP-Link®) when you connect to the respective port on the rear panel of the instrument. The GPIB, RS-232, and TSP-Link options require an optional accessory card. In most cases, you do not need to configure anything on the instrument. In addition, you do not need to reboot if you change the type of interface that is connected.

You can only use one communications interface to control the DMM6500 at a time. The USB connection takes precedence over LAN connections. For other communications interfaces, the first interface on which the instrument receives a message takes control of the instrument. If another interface sends a message, that interface can take control of the instrument. You may need to enter a password to change the interface, depending on the selected interface access.

## Supported remote interfaces

The DMM6500 supports the following remote interfaces:

- **GPIB:** IEEE-488 instrumentation general purpose interface bus
- **Ethernet:** Local-area-network communications
- **RS-232:** Serial communication data standard
- **USB:** Type B USB port
- **TSP-Link:** A high-speed trigger synchronization and communications bus that test system builders can use to connect multiple instruments in a master-and-subordinate configuration

## NOTE

The GPIB, RS-232, and TSP-Link interfaces require an optional communications accessory card to be installed in the instrument. Accessory cards include the KTTI-GPIB, KTTI-TSP, and KTTI-RS232.

For details about TSP-Link, see “TSP-Link System Expansion Interface” in the *Model DMM6500 Reference Manual*.

The rear-panel connections for the remote communication interfaces are shown in the following figure.

**Figure 15: DMM6500 remote interface connections**

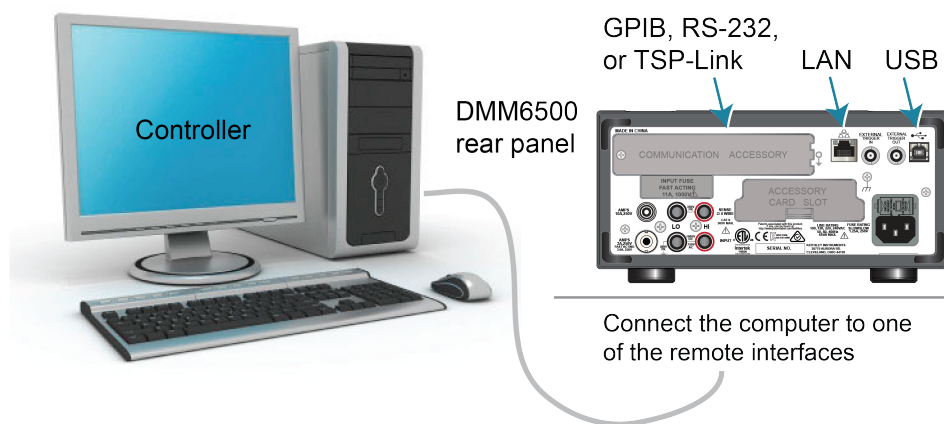

## LAN communications

You can communicate with the instrument using a local area network (LAN).

When you connect using a LAN, you can use a web browser to access the internal web page of the instrument and change some of the instrument settings. For more information, see [Using the web interface](#) (on page 3-18).

The DMM6500 is a version 1.5 LXI Device Specification 2016 instrument that supports TCP/IP and complies with IEEE Std 802.3 (ethernet LAN). There is one LAN port on the rear panel of the instrument that supports full connectivity on a 10 Mbps or 100 Mbps network. The DMM6500 automatically detects the speed.

The DMM6500 also supports Multicast DNS (mDNS) and DNS Service Discovery (DNS-SD), which are useful on a LAN with no central administration.

## NOTE

Contact your network administrator to confirm your specific network requirements before setting up a LAN connection.

If you have problems setting up the LAN, refer to [LAN troubleshooting suggestions](#) (on page 3-18).

## Set up LAN communications on the instrument

This section describes how to set up manual or automatic LAN communications on the instrument.

### Check communication settings

Before setting up the LAN configuration, you can check the communication settings on the instrument without making any changes.

*To check communication settings on the instrument:*

1. Press the **MENU** key.
2. Under System, select **Communication**. The SYSTEM COMMUNICATIONS window opens.
3. Select **LAN** to see the settings for that interface.
4. Press the **EXIT** key to leave the SYSTEM COMMUNICATION window without making any changes.

### Set up automatic LAN configuration

If you are connecting to a LAN that has a DHCP server or if you have a direct connection between the instrument and a host computer, you can use automatic IP address selection.

If you select Auto, the instrument attempts to get an IP address from a DHCP server. If this fails, it reverts to an IP address in the range of 169.254.1.0 through 169.254.254.255.

---

## NOTE

Both the host computer and the instrument should be set to use automatic LAN configuration. Though it is possible to have one set to manual configuration, it is more complicated to set up.

---

*To set up automatic IP address selection using the front panel:*

1. Press the **MENU** key.
2. Under System, select **Communication**.
3. Select the **LAN** tab.
4. For TCP/IP Mode, select **Auto**.
5. Select **Apply Settings** to save your settings.

## Set up manual LAN configuration

If necessary, you can set the IP address on the instrument manually.

You can also enable or disable the DNS settings and assign a host name to the DNS server.

---

### NOTE

Contact your corporate information technology (IT) department to secure a valid IP address for the instrument when placing the instrument on a corporate network.

The instrument IP address has leading zeros, but the computer IP address cannot.

---

#### *To set up manual IP address selection on the instrument:*

1. Press the **MENU** key.
2. Under System, select **Communication**.
3. Select the **LAN** tab.
4. For TCP/IP Mode, select **Manual**.
5. Enter the **IP Address**.
6. Enter the **Gateway** address.
7. Enter the **Subnet** mask.
8. Select **Apply Settings** to save your settings.

## Set up LAN communications on the computer

This section describes how to set up the LAN communications on your computer.

---

### NOTE

Do not change your IP address without consulting your system administrator. If you enter an incorrect IP address, it can prevent your computer from connecting to your corporate network or it may cause interference with another networked computer.

Record all network configurations before modifying any existing network configuration information on the network interface card. Once the network configuration settings are updated, the previous information is lost. This may cause a problem reconnecting the host computer to a corporate network, particularly if DHCP is disabled.

Be sure to return all settings to their original configuration before reconnecting the host computer to a corporate network. Contact your system administrator for more information.

---



## Verify the LAN connection on the DMM6500

Make sure that your DMM6500 is connected to the network by confirming that your instrument was assigned an IP address.

### *To verify the LAN connection:*

1. Press the **MENU** key.
2. Under System, select **Communication**.
3. Select the **LAN** tab.

A green LAN status indicator on the lower left of the LAN tab confirms that your instrument was assigned an IP address.

## Use the LXI Discovery Tool

To find the IP address of the DMM6500, use the LXI Discovery Tool, a utility that is available from the Resources tab of the [LXI Consortium website \(lxistandard.org\)](http://lxistandard.org).

## USB communications

To use the rear-panel USB port, you must have the Virtual Instrument Software Architecture (VISA) layer on the host computer. See “How to install the Keithley I/O Layer” in the *Model DMM6500 Reference Manual* for more information.

VISA contains a USB-class driver for the USB Test and Measurement Class (USBTMC) protocol that, once installed, allows the Microsoft® Windows® operating system to recognize the instrument.

When you connect a USB device that implements the USBTMC or USBTMC-USB488 protocol to the computer, the VISA driver automatically detects the device. Note that the VISA driver only automatically recognizes USBTMC and USBTMC-USB488 devices. It does not recognize other USB devices, such as printers, scanners, and storage devices.

In this section, “USB instruments” refers to devices that implement the USBTMC or USBTMC-USB488 protocol.

## Connect a computer to the DMM6500 using USB

To communicate from a computer to the instrument, you need a USB cable with a USB Type B connector end and a USB type A connector end. You need a separate USB cable for each instrument you plan to connect to the computer at the same time using the USB interface.

### *To connect an instrument to a computer using USB:*

1. Connect the Type A end of the cable to the computer.
2. Connect the Type B end of the cable to the instrument.
3. Turn on the instrument power. When the computer detects the new USB connection, the Found New Hardware Wizard starts.
4. If the “Can Windows connect to Windows Update to search for software?” dialog box opens, select **No**, and then select **Next**.
5. On the “USB Test and Measurement device” dialog box, select **Next**, and then select **Finish**.

## Communicate with the instrument

For the instrument to communicate with the USB device, you must use NI-VISA™. VISA requires a resource string in the following format to connect to the correct USB instrument:

```
USB0::0x05e6::0x6500::[serial number]::INSTR
```

Where:

- 0x05e6: The Keithley vendor ID
- 0x6500: The instrument model number
- [serial number]: The serial number of the instrument (the serial number is also on the rear panel)
- INSTR: Use the USBTMC protocol

The resource string is displayed on the bottom right of the System Communications screen when the USB connection is active. Select **Menu**, then **Communication** to open the System Communications menu and select the **USB** tab.

You can also retrieve the resource string by running the Keithley Configuration Panel, which automatically detects all instruments connected to the computer.

If you installed the Keithley I/O Layer, you can access the Keithley Configuration Panel through the Microsoft® Windows® Start menu.

---

## NOTE

If you have a USB connection, you cannot switch to a LAN connection while the USB is connected. USB takes precedence over LAN.

---

To use the Keithley Configuration Panel to determine the VISA resource string:

1. Click **Start > Keithley Instruments > Keithley Configuration Panel**. The Select Operation dialog box is displayed.

Figure 16: Select Operation dialog box

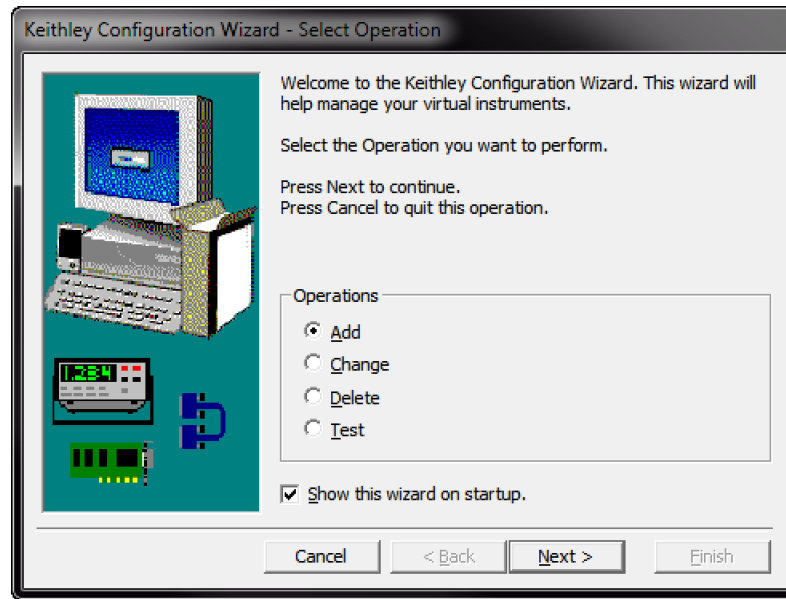

2. Select **Add**.
3. Select **Next**. The Select Communication Bus dialog box is displayed.

Figure 17: Select Communication Bus dialog box

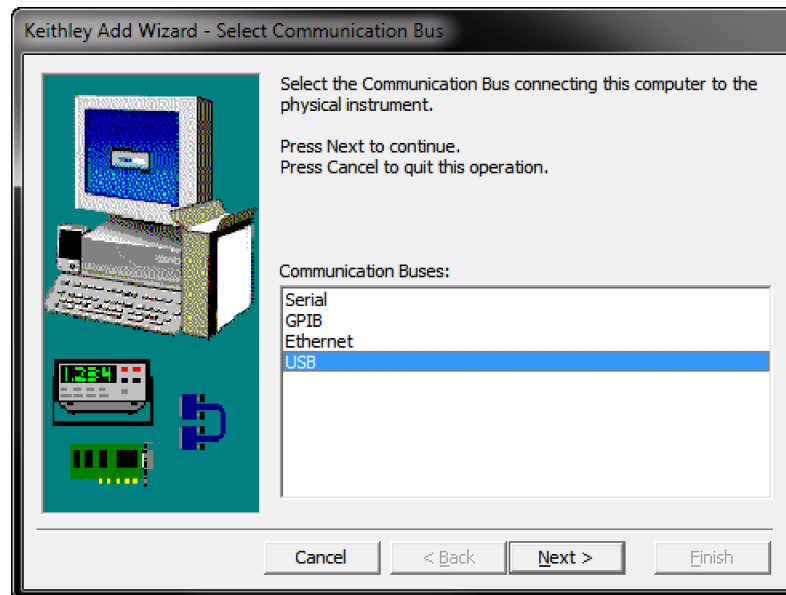

4. Select **USB**.
5. Click **Next**. The Select Instrument Driver dialog box is displayed.

**Figure 18: Select Instrument Driver dialog box**

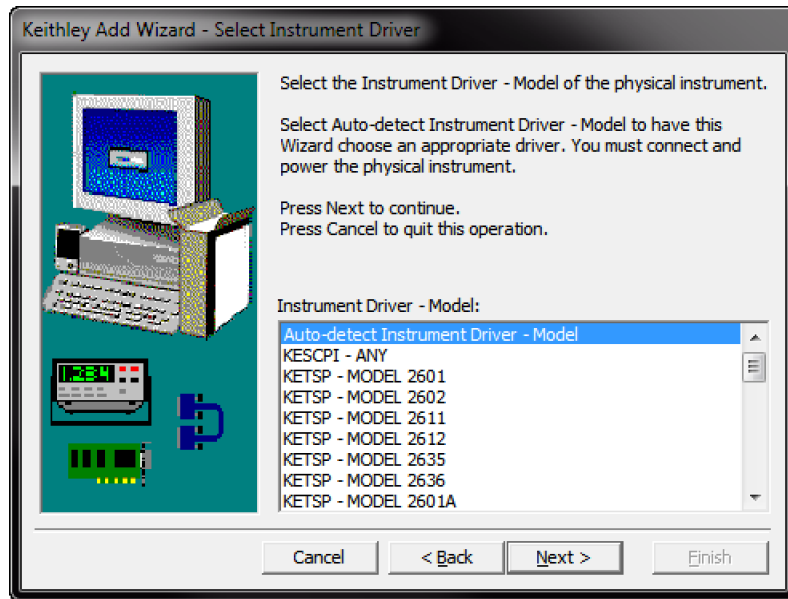

6. Select **Auto-detect Instrument Driver - Model**.
7. Click **Next**. The Configure USB Instrument dialog box is displayed with the detected instrument VISA resource string visible.
8. Click **Next**. The Name Virtual Instrument dialog box is displayed.

**Figure 19: Name Virtual Instrument dialog box**

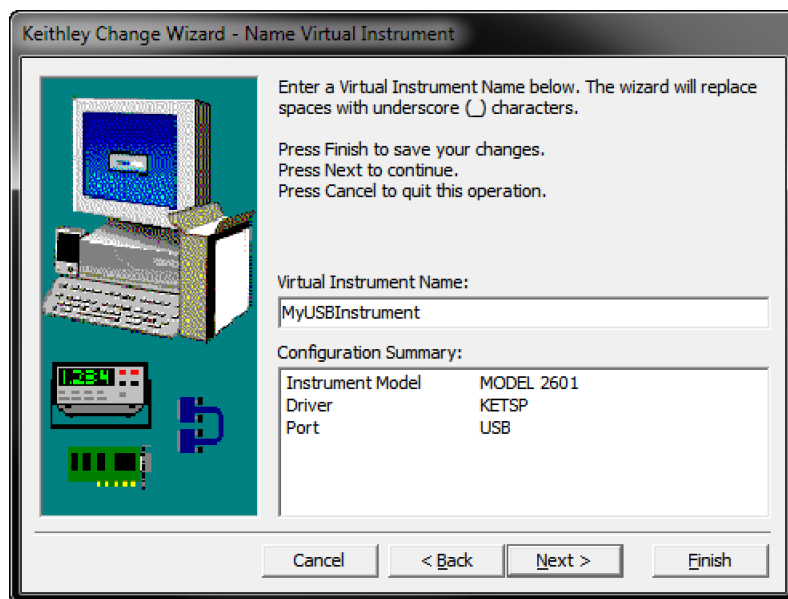

9. In the Virtual Instrument Name box, enter a name that you want to use to refer to the instrument.
10. Select **Finish**.
11. Select **Cancel** to close the Wizard.
12. Save the configuration. From the Keithley Configuration Panel, select **File > Save**.

**Verify the instrument through the Keithley Communicator:**

1. Set the instrument to use the SCPI command set. Refer to [How do I change the command set?](#) (on page 3-20) for instruction.
2. Click **Start > Keithley Instruments > Keithley Communicator**.
3. Select **File > Open Instrument** to open the instrument you just named.

**Figure 20: Keithley Communicator Open an Instrument**

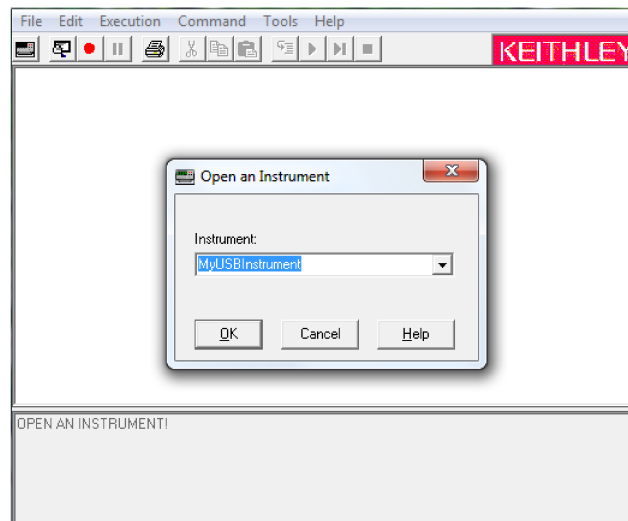

4. Click **OK**.
5. Send a command to the instrument and see if it responds.

---

## NOTE

If you have a full version of NI-VISA on your system, you can run NI-MAX or the VISA Interactive Control utility. See the National Instruments documentation for information.

---

## GPIB communications

The DMM6500 GPIB interface is IEEE Std 488.1 compliant and supports IEEE Std 488.2 common commands and status model topology.

You can have up to 15 devices connected to a GPIB interface, including the controller. The maximum cable length is the lesser of either:

- The number of devices multiplied by 2 m (6.5 ft)
- 20 m (65.6 ft)

You may see erratic bus operation if you ignore these limits.

---

### NOTE

GPIB communications require the KTTI-GPIB communications accessory card to be installed in the instrument.

---

## Install the KTTI-GPIB accessory card

Figure 21: KTTI-GPIB connector view

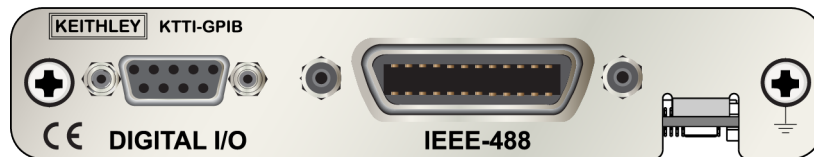

## Unpack and inspect

---

### CAUTION

**Make sure to handle the KTTI-GPIB card carefully. Always grasp the card by the side edges. Do not touch board surfaces, components, or areas adjacent to electrical contacts. Contamination from foreign materials such as dirt, dust, and body oils can substantially degrade card performance.**

---

#### *To unpack and inspect your card:*

1. Inspect the box for damage.
2. Open the box.
3. Remove the card and inspect for any obvious signs of physical damage.
4. Report any damage to the shipping agent immediately.

## Installation

### **⚠ WARNING**

Slot covers must be installed on unused slots to prevent personal contact with high-voltage circuits. Failure to recognize and observe standard safety precautions could result in personal injury or death due to electric shock.

#### ***To install the communications card:***

1. Turn the instrument off and disconnect the power line cord and any other cables connected to the rear panel.
2. Position the instrument so that you are facing the rear panel.
3. Remove the slot cover plate from the slot on the back of the instrument. Retain the plate and screws for future use.
4. Align the card with the connector toward the inside edge of the slot and slide the card into the chassis. For the last ¼ inch, press in firmly to mate the card to the connector.
5. On each side of the card, there is a spring-loaded mounting screw. Tighten these two screws, either by hand or with a Phillips-head screwdriver, to secure the card in the case. Do not overtighten.
6. Reconnect the power line cable and any other cables to the rear panel.
7. Turn on the instrument.

## Connect GPIB cables to your instrument

To connect a DMM6500 to the GPIB interface, use a cable equipped with standard GPIB connectors, as shown below.

Figure 22: GPIB connector

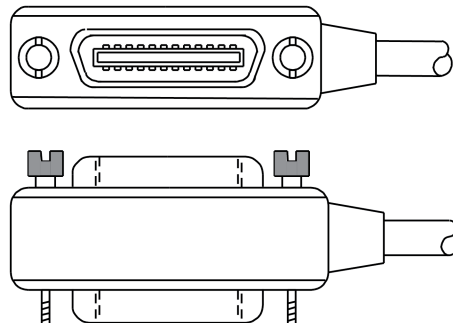

To allow many parallel connections to one instrument, stack the connectors. Each connector has two screws on it to ensure that connections remain secure. The figure below shows a typical connection diagram for a test system with multiple instruments.

## CAUTION

To avoid possible mechanical damage, stack no more than three connectors on any one instrument. To minimize interference caused by electromagnetic radiation, use only shielded GPIB cables. Contact Keithley Instruments for shielded cables.

Figure 23: DMM6500 instrument GPIB connections

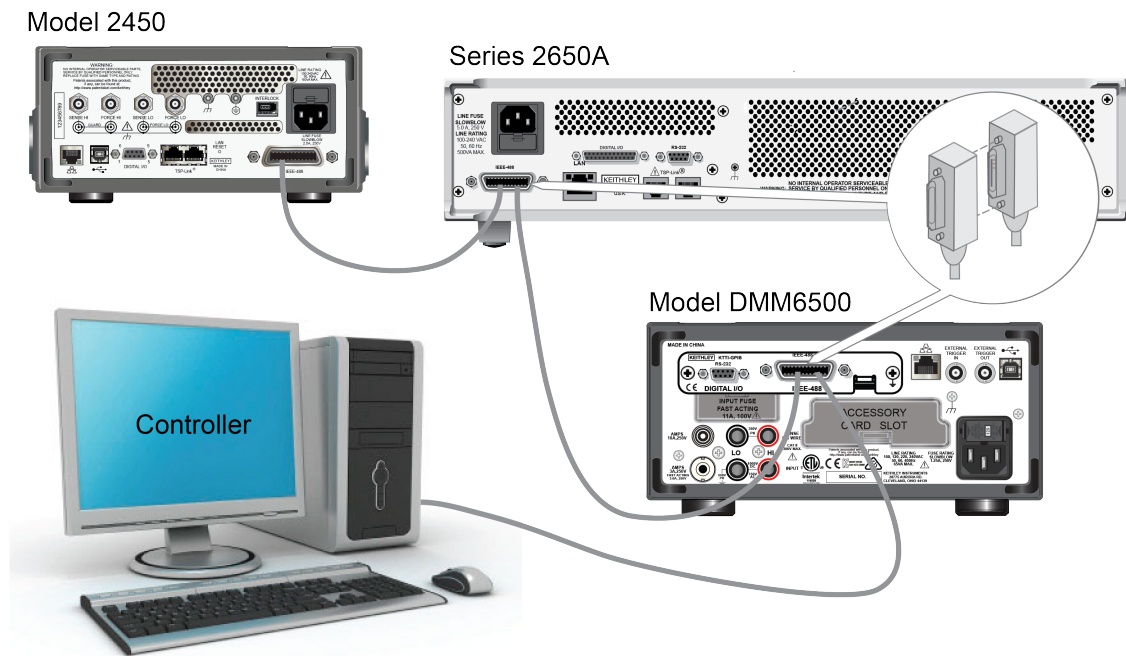

## Additional information

Additional information is available in the *KTTI-GPIB Communication and Digital I/O Accessory Instruction Sheet*, part number 0771437XX, where XX is the document revision number.



## Set the GPIB address

The default GPIB address is 16. You can set the address from 1 to 30 if it is unique in the system. This address cannot conflict with an address that is assigned to another instrument or to the GPIB controller.

---

### NOTE

GPIB controllers are usually set to 0 or 21. To be safe, do not configure any instrument to have an address of 21.

---

The instrument saves the address in nonvolatile memory. It does not change when you send a reset command or when you turn the power off and on again.

#### *To set the GPIB address from the front panel:*

1. Press the **MENU** key.
2. Select **Communication**.
3. Select the **GPIB** tab.
4. Set the GPIB **Address**.
5. Select **OK**.

---

### NOTE

You can also set the GPIB address using remote commands. Set the GPIB address with the SCPI command `:SYSTem:GPIB:ADDRess` or the TSP command `gpib.address`.

---

## RS-232

You can communicate with the instrument using RS-232 if a KTTI-RS232 communications accessory card is installed in the instrument.

The card provides six independently configurable digital input/output lines that can be used to control external digital circuitry, for example, a handler that is used to perform binning operations. The digital I/O port is a standard female DB-9 connector. You can also use these lines for triggering. The instrument can generate output trigger pulses and detect input trigger pulses.

## Install the KTTI-RS232 accessory card

Figure 24: KTTI-RS232 panel view



### Unpack and inspect

#### CAUTION

Make sure to handle the KTTI-RS232 card carefully. Always grasp the card by the side edges. Do not touch board surfaces, components, or areas adjacent to electrical contacts. Contamination from foreign materials such as dirt, dust, and body oils can substantially degrade card performance.

#### *To unpack and inspect your card:*

1. Inspect the box for damage.
2. Open the box.
3. Remove the card and inspect for any obvious signs of physical damage.
4. Report any damage to the shipping agent immediately.

### Installation

#### ⚠ WARNING

Slot covers must be installed on unused slots to prevent personal contact with high-voltage circuits. Failure to recognize and observe standard safety precautions could result in personal injury or death due to electric shock.

#### *To install the communications card:*

1. Turn the instrument off and disconnect the power line cord and any other cables connected to the rear panel.
2. Position the instrument so that you are facing the rear panel.
3. Remove the slot cover plate from the slot on the back of the instrument. Retain the plate and screws for future use.
4. Align the card with the connector toward the inside edge of the slot and slide the card into the chassis. For the last ¼ inch, press in firmly to mate the card to the connector.
5. On each side of the card, there is a spring-loaded mounting screw. Tighten these two screws, either by hand or with a Phillips-head screwdriver, to secure the card in the case. Do not overtighten.

6. Reconnect the power line cable and any other cables to the rear panel.
7. Turn on the instrument.

## Making connections

The RS-232 serial port can be connected to the serial port of a controller using a straight-through RS232 cable terminated with DB-9 connectors. Do not use a null modem cable.

The serial port uses the transmit (TXD), receive (RXD), CTS and RTS (if flow control is enabled), and signal ground (GND) lines of the RS232 standard. The figure below shows the rear-panel connector for the RS232 interface. The table below shows the pinouts for the connector.

Figure 25: KTTI-RS232 panel view

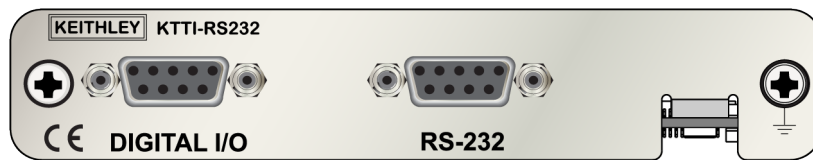
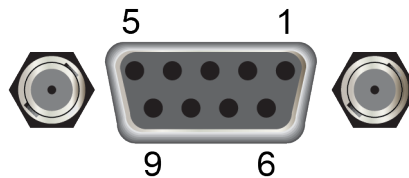

Figure 26: RS-232 panel connector



Pin	Description
1	No connection
2	TXD, transmit data
3	RXD, receive data
4	No connection
5	GND, signal ground
6	No connection
7	RTS, ready to send
8	CTS, clear to send
9	No connection

## Additional information

Additional information is available in the *KTTI-RS232 Communication and Digital I/O Accessory Instruction Sheet*, part number 0771436XX, where XX is the document revision number.

## TSP-Link

You can communicate with the instrument using TSP-Link® if a KTTI-TSP communications accessory card is installed in the instrument.

Keithley Instruments TSP-Link is a high-speed trigger synchronization and communication bus that test-system builders can use to connect multiple instruments in a master and subordinate configuration. Once connected, all the instruments that are equipped with TSP-Link in a system can be programmed and operated under the control of the master instrument or instruments. This allows the instruments to run tests more quickly because they can be decoupled from frequent computer interaction. The test system can have multiple master and subordinate groups, which can be used to handle multidevice testing in parallel. Combining TSP-Link with a flexible programmable trigger model ensures speed.

Using TSP-Link, multiple instruments are connected and can be used as if they are part of the same physical unit for simultaneous multichannel testing. The test system can be expanded to include up to 32 TSP-Link-enabled instruments.

The card provides six independently configurable digital input/output lines that can be used to control external digital circuitry, for example, a handler that is used to perform binning operations. The digital I/O port is a standard female DB-9 connector. You can also use these lines for triggering. The instrument can generate output trigger pulses and detect input trigger pulses.

## Install the KTTI-TSP accessory card

Figure 27: KTTI-TSP panel view

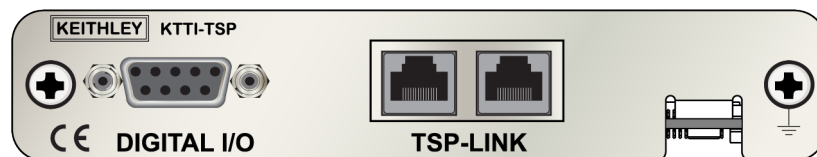

## Unpack and inspect

### CAUTION

Make sure to handle the KTTI-TSP card carefully. Always grasp the card by the side edges. Do not touch board surfaces, components, or areas adjacent to electrical contacts. Contamination from foreign materials such as dirt, dust, and body oils can substantially degrade card performance.

**To unpack and inspect your card:**

1. Inspect the box for damage.
2. Open the box.
3. Remove the card and inspect for any obvious signs of physical damage.
4. Report any damage to the shipping agent immediately.

## Installation

---

** WARNING**

**Slot covers must be installed on unused slots to prevent personal contact with high-voltage circuits. Failure to recognize and observe standard safety precautions could result in personal injury or death due to electric shock.**

---

**To install the communications card:**

1. Turn the instrument off and disconnect the power line cord and any other cables connected to the rear panel.
2. Position the instrument so that you are facing the rear panel.
3. Remove the slot cover plate from the slot on the back of the instrument. Retain the plate and screws for future use.
4. Align the card with the connector toward the inside edge of the slot and slide the card into the chassis. For the last ¼ inch, press in firmly to mate the card to the connector.
5. On each side of the card, there is a spring-loaded mounting screw. Tighten these two screws, either by hand or with a Phillips-head screwdriver, to secure the card in the case. Do not overtighten.
6. Reconnect the power line cable and any other cables to the rear panel.
7. Turn on the instrument.

## Making connections

The TSP-Link expansion interface uses CAT5 and RJ-45 connectors to connect up to 32 devices.

## Additional information

Additional information is available in the *KTTI-TSP Communication and Digital I/O Accessory Instruction Sheet*, part number 0771438XX, where XX is the document revision number.

## Using the web interface

The DMM6500 web interface allows you to make settings and control your instrument through a web page. The web page includes:

- Instrument status.
- The instrument model, serial number, firmware revision, and the last LXI message.
- An ID button to help you locate the instrument.
- A virtual front panel and command interface that you can use to control the instrument.
- Ability to download data from specific reading buffers into a CSV file.
- Administrative options and LXI information.

The instrument web page resides in the firmware of the instrument. Changes you make through the web interface are immediately made in the instrument.

## Connect to the instrument web interface

When the LAN and instrument establish a connection, you can open the web page for the instrument.

### ***To access the web interface:***

1. Open a web browser on the host computer.
2. Enter the IP address of the instrument in the address box of the web browser. For example, if the instrument IP address is 192.168.1.101, enter 192.168.1.101 in the browser address box.
3. Press **Enter** on the computer keyboard to open the instrument web page.
4. If prompted, enter a user name and password. The default is `admin` for both.

## LAN troubleshooting suggestions

If you are unable to connect to the web interface of the instrument, check the following items:

- The network cable is in the LAN port on the rear panel of the instrument, not one of the TSP-Link® ports.
- The network cable is in the correct port on the computer. The LAN port of a laptop may be disabled when the laptop is in a docking station.
- The setup procedure used the configuration information for the correct ethernet card.
- The network card of the computer is enabled.
- The IP address of the instrument is compatible with the IP address on the computer.

- The subnet mask address of the instrument is the same as the subnet mask address of the computer.
- Make sure there is no USB cable attached between the instrument and your computer. USB communications take precedence over LAN.

You can also try restarting the computer and the instrument.

**To restart the instrument:**

1. Turn the power to the instrument off, and then on.
2. Wait at least 60 seconds for the network configuration to be completed.

**To set up LAN communications:**

1. Press the **MENU** key.
2. Under System, select **Communication**.
3. Select the **LAN** tab.
4. Verify the settings.

If the above actions do not correct the problem, contact your system administrator.

## Web interface Home page

Figure 28: DMM6500 web interface

The screenshot shows the web interface for the Keithley DMM6500. The header includes the Keithley logo and 'A Tektronix Company' text. The main content area displays the instrument model and manufacturer information. A table lists the following details:

Instrument Model:	DMM6500		
Manufacturer:	Keithley Instruments		
Serial Number:	64340296	Firmware Revision:	1.7.0
TCP Raw Socket:	5025	Telnet Port:	23

Below the table, the 'Last LXI Message' section shows: 'Reading buffer defbuffer1 is 0% filled'. At the bottom of the interface, there is an image of the physical DMM6500 multimeter displaying '+03.689 V' on its screen.

The Home page of the instrument provides information about the instrument. It includes:

- The instrument model number, manufacturer, serial number, and firmware revision number.
- The TCP Raw Socket number and Telnet Port number.
- The last LXI message. The history link opens the LXI Home page.
- The ID button, which allows you to identify the instrument. Refer to [Identify the instrument](#) (on page 3-20).

## Identify the instrument

If you have a bank of instruments, you can select the ID button to determine which one you are communicating with.

Before trying to identify the instrument, make sure you have a remote connection to the instrument.

### *To identify the instrument:*

1. On each instrument in the bank, select **MENU**, then **Communication**.
2. Select the **LAN** tab.
3. On the web interface Home or LXI Home page, select the **ID** button. The button turns green and the LXI LAN indicator on the instrument LAN tab blinks.
4. Select the **ID** button again to turn off the ID feature.

## Determining the command set you will use

You can change the command set that you use with the DMM6500. The remote command sets that are available include:

- SCPI: An instrument-specific language built on the SCPI standard.
- TSP: A scripting programming language that contains instrument-specific control commands that can be executed from a stand-alone instrument. You can use TSP to send individual commands or use it to combine commands into scripts.
- SCPI2000: An instrument-specific language that allows you to run code developed for Keithley Instruments Series 2000 instruments.
- SCPI34401: An instrument-specific language that allows you to run code developed for Keysight Model 34401 instruments.

If you change the command set, reboot the instrument.

You cannot combine the command sets.

---

### NOTE

As delivered from Keithley Instruments, the DMM6500 is set to work with the SCPI command set.

---



---

## NOTE

If you choose the SCPI2000 or SCPI34401 command set, you will not have access to some of the extended ranges and other features that are now available using the default SCPI command set. In addition, some Series 2000 or Keysight 34401 code will work differently in the DMM6500 than it did in the earlier instrument. For information about the differences between the DMM6500 and the Series 2000, refer to *DMM6500 in a Model 2000 Application*, Keithley Instruments document number 0771466XX. For information about the differences between the DMM6500 and the Keysight 34401, refer to *DMM6500 in a Keysight Model 34401 Application*, Keithley Instruments document number 0771467XX.

---

### ***To set the command set from the front panel:***

1. Press the **MENU** key.
2. Under System, select **Settings**.
3. Select the appropriate **Command Set**.

You are prompted to confirm the change to the command set and reboot.

### ***To verify which command set is selected from a remote interface:***

Send the command:

```
*LANG?
```

### ***To change to the SCPI command set from a remote interface:***

Send the command:

```
*LANG SCPI
```

Reboot the instrument.

### ***To change to the TSP command set from a remote interface:***

Send the command:

```
*LANG TSP
```

Reboot the instrument.

---

## Making basic front-panel measurements

### In this section:

Introduction .....	4-1
Equipment required for this example.....	4-1
Device connections .....	4-1
Basic front-panel measurements.....	4-2
View measurement data .....	4-3

## Introduction

This example application makes a 2-wire resistance measurement using the front panel of the instrument.

---

### NOTE

Set the function before making other instrument settings. Many of the settings are related to a specific measure function. The applications in this manual use the order of operations to produce the best results.

---

## Equipment required for this example

Equipment required to perform this test:

- One DMM6500
- Two insulated banana cables
- One resistor to test; the example uses a resistor with a 9.75 k $\Omega$  rating

## Device connections

Connect the DMM6500 to the resistor in a 2-wire (local sense) configuration. In this configuration, the device is connected between the INPUT HI and INPUT LO terminals.

**To make the connections:**

1. Power off the DMM6500.
2. Connect the test leads to the front-panel INPUT HI and INPUT LO terminals, as shown in the following figure.
3. Connect the test leads to the resistor.

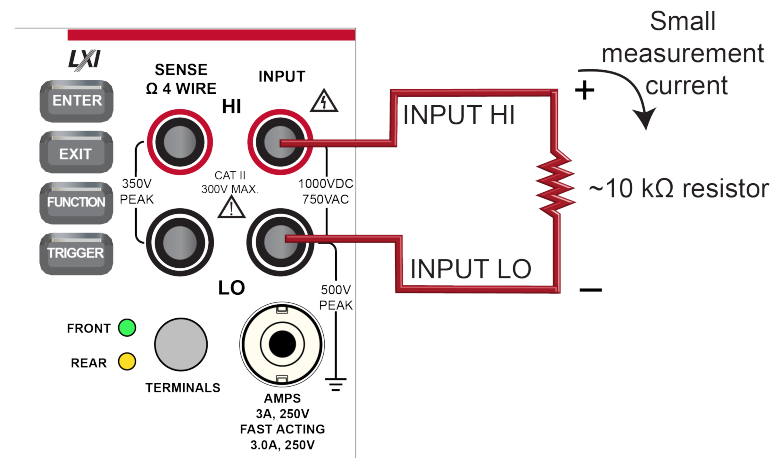
**Figure 29: DMM6500 front-panel 2-wire resistance measurement**

## Basic front-panel measurements

The following procedures show you how to make a measurement, access settings for the measurement, and view measurement data in a reading buffer.

You can make measurements continuously or manually. When you make continuous measurements, the instrument makes measurements as quickly as possible. When you make manual measurements, the instrument makes measurements when you press the TRIGGER key.

**To make a measurement from the front panel:**

1. Press the **POWER** switch on the front panel to turn on the instrument.
2. Make sure the TERMINALS switch is set to **FRONT**.
3. From the Functions swipe screen, select **2W Ω**. Measurements begin to display on the top half of the home screen.
4. If measurements are not displayed, press the **TRIGGER** key for a few seconds and select **Continuous Measurement**.

**To change the measure settings:**

1. Press the **MENU** key.
2. Under Measure, select **Settings**.
3. Select **Display Digits**.
4. Select **3.5 Digits**.
5. Press the **HOME** key. The measurement now shows 3½ digits.

**To make a single measurement:**

1. Press the front-panel **TRIGGER** key for a few seconds.
2. Select **Manual Trigger Mode**.
3. Press the **TRIGGER** key to initiate a single reading using the selected measure function.

**Figure 30: Basic measurement test results**

## View measurement data

You can view data from the reading buffers through the front panel using the Reading Table. The Reading Table displays the following information:

- **Index:** The sequential number of the reading.
- **Time:** The data and time of the reading.
- **Reading:** The data that was measured.
- **Extra:** Only displayed for buffers that are set to Full. The extra value that is stored with a reading, such as the ratio component of a DCV ratio measurement.
- **Terminal:** The terminals (Front or Rear) that were used to make the readings. When using Rear terminals with a switch card installed and you close a channel on that switch card, the Terminal is listed as Rear with the channel number of the closed channels in parenthesis. For example, if you close channel 3, Terminal displays Rear (3).

If you select a data point, additional detail about that data point is displayed, including the function, math, and limits.

To jump to a specific spot in the data, select the menu in the upper left and select **Jump to Index**. The selected data point is displayed at the top of the reading table.

To save the data, select the menu in the upper left and select **Save to USB**.

When TERMINALS is set to **REAR**, you can filter the data using channels and watch channels. The options include:

- **Filter by Watch Channels (Active Buffer):** Filters the data by watch channels. After selecting this option, select **Edit Watch Channels** to select specific channels.
- **Edit Watch Channels (Active Buffer):** Select which channels are watched channels.
- **Filter by Channels:** Allows you to limit the data in the reading table. After selecting **Filter by Channels**, select **Edit Channels** to specify the channels to display.
- **Edit Channels:** Allows you to select the channels that are displayed in the reading table.
- **No Filtering:** Removes filters from the reading table and displays all data for the selected buffer.

**Using the front panel to view the contents of a reading buffer:**

1. Press the **MENU** key.
2. Under **Views**, select **Reading Table**. Data for the active reading buffer is displayed.

**Figure 31: Reading table**

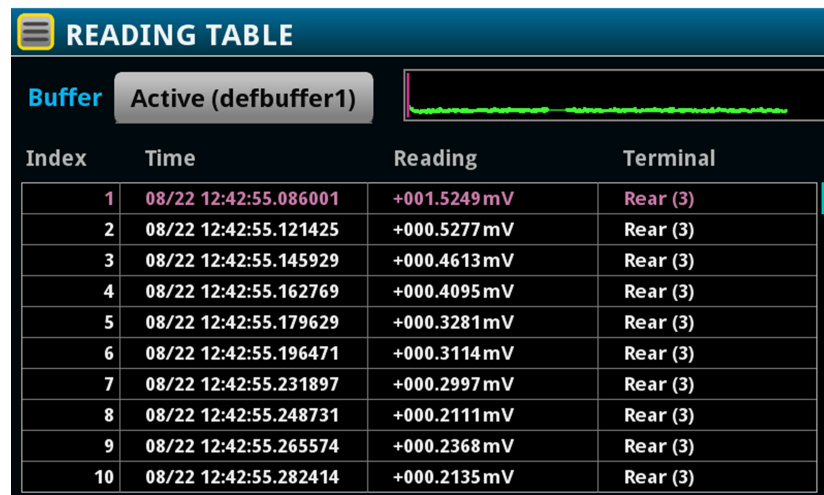

Index	Time	Reading	Terminal
1	08/22 12:42:55.086001	+001.5249 mV	Rear (3)
2	08/22 12:42:55.121425	+000.5277 mV	Rear (3)
3	08/22 12:42:55.145929	+000.4613 mV	Rear (3)
4	08/22 12:42:55.162769	+000.4095 mV	Rear (3)
5	08/22 12:42:55.179629	+000.3281 mV	Rear (3)
6	08/22 12:42:55.196471	+000.3114 mV	Rear (3)
7	08/22 12:42:55.231897	+000.2997 mV	Rear (3)
8	08/22 12:42:55.248731	+000.2111 mV	Rear (3)
9	08/22 12:42:55.265574	+000.2368 mV	Rear (3)
10	08/22 12:42:55.282414	+000.2135 mV	Rear (3)

3. To display data for a different reading buffer, select the new buffer.
4. To view details for a specific data point, swipe the table up or down and select the data point to view the Reading Details. If there are many data points, select an area on the reading preview graph in the upper right corner of the screen to get closer to the data you want, and then scroll to the data point. You can also select the menu and select **Jump to Index** to go to a specific point.
5. Press the **HOME** key to return to the home screen.

---

# Measuring DC voltage with high accuracy

## In this section:

Introduction .....	5-1
Equipment required.....	5-1
Device connections .....	5-1
Measuring DCV with high accuracy .....	5-3

## Introduction

This example application demonstrates how to use a DMM6500 to make high-accuracy DC voltage measurements.

This type of test is often done in metrology laboratories where high accuracy is required for calibration and verification.

## Equipment required

- One DMM6500
- One computer set up for communication with the instrument
- Two insulated banana cables
- One device or component to be tested

## Device connections

This example uses the DMM6500 to measure DC voltage using either the front or rear input terminals. Both the front and rear-panel input terminals are safety banana jacks.

---

### NOTE

You must use either the front or the rear terminals. You cannot mix the front and rear connections.

---

Make sure that the front-panel **TERMINALS** switch is set to the terminals you are using. The light for FRONT or REAR indicates which terminals are being used.

**Connecting devices to the instrument:**

1. Connect the test leads to the INPUT HI and LO terminals.
2. Connect the test leads to the device under test (DUT).

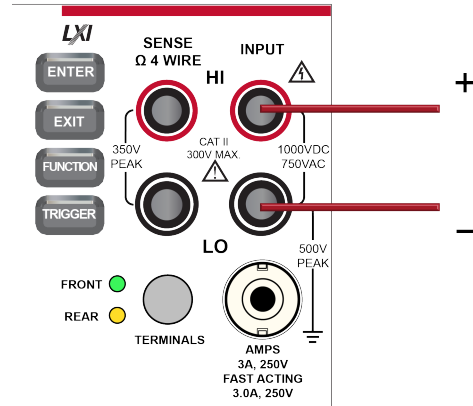
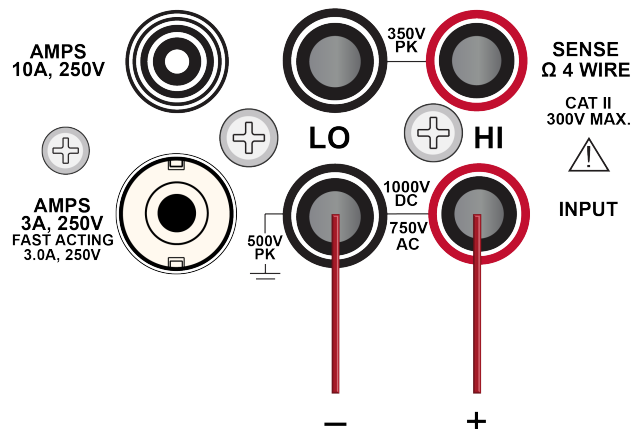
**Figure 32: Front-panel connections****Figure 33: Rear-panel connections****⚠ WARNING**

To prevent electric shock, test connections must be configured such that the user cannot come in contact with test leads or any device under test (DUT) that is in contact with the conductors. It is good practice to disconnect DUTs from the instrument before powering the instrument. Safe installation requires proper shields, barriers, and grounding to prevent contact with test leads.

---

**⚠ WARNING**

There is no internal connection between protective earth (safety ground) and the LO terminals of the DMM6500. Therefore, hazardous voltages (more than 30 V<sub>RMS</sub>) can appear on LO terminals. This can occur when the instrument is operating in any mode. To prevent hazardous voltage from appearing on the LO terminals, connect the LO terminal to protective earth (safety ground) if your application allows it. You can connect the LO terminal to the chassis ground terminal on the front panel or the chassis ground screw terminal on the rear panel. Note that the front-panel terminals are isolated from the rear-panel terminals. Therefore, if you are using the front-panel terminals, ground to the front-panel LO terminal. If you are using the rear-panel terminals, ground to the rear-panel LO terminal. Failure to follow these guidelines can result in injury, death, or instrument damage.

---

## Measuring DCV with high accuracy

This application demonstrates how to use the DMM6500 to make high-accuracy DC voltage measurements. You can make the measurements from the front-panel interface or over the remote interface using SCPI code or TSP code. For information about setting up remote communications, see [Remote communications interfaces](#) (on page 3-1).

For this application, you will:

- Restart the instrument.
- Verify that the DC voltage function is selected.
- Set the range to 10 V.
- Set the integration rate to 1 power line cycle (PLC) at 60 Hz line frequency; 1 PLC provides an aperture of 16.67 ms.
- Turn on autozero. This allows the instrument to optimize the accuracy of readings by checking reference measurements.
- Enable a repeating filter with a count of 100. This reduces noise error because the results are more stable when the measurements are averaged.
- Generate readings from the front panel or the remote interface.



## Using the front panel

*To run this example from the front panel:*

1. Press the **POWER** switch on the front panel to turn on the instrument.
2. Select the **REAR** terminals.
3. On the FUNCTIONS swipe screen, select **DCV**.
4. On the top half of the home screen, set the Range to **10 V**.
5. Swipe to the **SETTINGS** screen.
6. Set the Rate to **1**.
7. Select **OK**.
8. Verify that **Auto Zero** is selected.
9. Press the **MENU** key.
10. Under Measure, select **Calculations**.
11. Set Filter to **On**.
12. Select the **Settings** icon.
13. Set the Type to **Repeat**.
14. Set the Count to **100**.
15. Select **OK**.
16. Press the **HOME** key.

---

### NOTE

If measurements are not updating, press the **TRIGGER** key for a few seconds. Verify that the trigger mode is set to Continuous Measurement.

---

The measurements are displayed in the top area of the home screen. There are a few seconds between readings.

With a repeating filter count of 100 and NPLC of 1, the measurement cycle time is slow but accurate. By reducing the values of these settings, you can get faster but less accurate readings. The balance between speed and accuracy depends on the needs of your specific application.

## Using SCPI commands

This sequence of SCPI commands makes a single high-accuracy DC voltage measurement.

You may need to make changes so that this code will run in your programming environment. In the table, the SCPI commands have a light gray background.

**Send the following commands for this example application:**

Commands	Descriptions
<pre>*RST :SENS:FUNC "VOLT:DC" :SENS:VOLT:RANG 10 :SENS:VOLT:INP AUTO :SENS:VOLT:NPLC 10 :SENS:VOLT:AZER ON :SENS:VOLT:AVER:TCON REP :SENS:VOLT:AVER:COUN 100 :SENS:VOLT:AVER ON :READ?</pre>	<ul style="list-style-type: none"> <li>■ Reset the DMM6500</li> <li>■ Set the instrument to measure DC voltage</li> <li>■ Set the measure range to 10 V</li> <li>■ Set the input impedance to automatic so the instrument selects 10 <math>\Omega</math> for the 10 V range</li> <li>■ Set the integration rate (NPLCs) to 10</li> <li>■ Enable autozero</li> <li>■ Set the averaging filter type to repeating</li> <li>■ Set the filter count to 100</li> <li>■ Enable the filter</li> <li>■ Read the voltage value; it is a few seconds before the reading is returned</li> </ul>

## Using TSP commands

The following TSP code is designed to be run from Keithley Instruments Test Script Builder (TSB). TSB is a software tool that is available from [tek.com/keithley](http://tek.com/keithley). You can install and use TSB to write code and develop scripts for TSP-enabled instruments. Information about how to use TSB is in the online help for TSB and in the "Introduction to TSP operation" section of the *Model DMM6500 Reference Manual*.

To use other programming environments, you may need to make changes to the example TSP code.

By default, the DMM6500 uses the SCPI command set. You must select the TSP command set before sending TSP commands to the instrument.

**To enable TSP commands:**

1. Press the **MENU** key.
2. Under System, select **Settings**.
3. Set the Command Set to **TSP**.
4. At the prompt to reboot, select **Yes**.

This sequence of TSP commands makes a single high-accuracy DC voltage measurement. After the code executes, the data is displayed in the Instrument Console of Test Script Builder.

**Send the following commands for this example application:**

```
-- Reset the instrument to the default settings.
reset()
-- Set the measure function to DC voltage.
dmm.measure.func = dmm.FUNC_DC_VOLTAGE
-- Set the measurement range to 10 V.
dmm.measure.range = 10
-- Set the number of power line cycles to 10.
dmm.measure.nplc = 10
-- Set the input impedance to auto so it selects 10 Gohm for the 10 V range.
dmm.measure.inputimpedance = dmm.IMPEDANCE_AUTO
-- Enable autozero.
dmm.measure.autozero.enable = dmm.ON
-- Set the averaging filter type to repeating.
dmm.measure.filter.type = dmm.FILTER_REPEAT_AVG
-- Set filter count to 100.
dmm.measure.filter.count = 100
-- Enable the filter.
dmm.measure.filter.enable = dmm.ON
-- Read the voltage value.
print(dmm.measure.read())
```

## Test results

The following table shows the trade-off between accuracy and measurement speed based on the integration rate (NPLC), averaging filter, and autozero settings. The first row of data is measured using the setup documented in this example. The other rows show the results as the integration rate, filter, and autozero settings are changed.

DC voltage	Measurement time (seconds)	Integration rate (NPLC)	Filter	Auto Zero
4.999985	33.542816	10	On	On
4.999982	0.335426	10	Off	On
4.999979	0.035426	1	Off	On
4.999990	0.017023	1	Off	Off

**Figure 34: DC voltage high-accuracy test results**



---

# Measuring 4-wire resistance with offset compensation

## In this section:

Introduction .....	6-1
Equipment required .....	6-2
Device connections .....	6-2
Measuring 4-wire resistance with offset compensation .....	6-4

## Introduction

This application example demonstrates how to use the DMM6500 to accurately measure resistance.

Typically, when resistance measurements are made using the 2-wire method, the instrument sources current through the test leads and the device under test (DUT). The voltage is measured and the resistance is calculated.

It is difficult to obtain accurate 2-wire resistance measurements when the DUT has a resistance value of less than 100  $\Omega$ . Typical lead resistances are from 1 m $\Omega$  to 10 m $\Omega$ . When the 2-wire method is applied to low-resistance measurements, there is a small but significant voltage drop across the resistance of each test lead. The voltage measured by the instrument is not the same as the voltage directly across the DUT.

The 4-wire method is preferred for low-resistance measurements. With this configuration, the test current is sourced through the DUT using one set of test leads, while a second set of SENSE leads measures the voltage across the DUT. Connect the voltage-sensing leads as close to the DUT as possible to avoid including the resistance of the test leads in the measurement.

Thermoelectric voltages (EMFs) can seriously affect low-resistance measurement accuracy. The DMM6500 can apply the offset-compensated ohms method (OCOMP), which makes one normal resistance measurement and one using the lowest current source setting to eliminate EMFs.

For this example, you use a 20  $\Omega$  resistor. Fixed measurement ranges are applied to optimize scanning speed and OCOMP is applied to correct for any EMF effects.

---

## NOTE

For comprehensive information on 4-wire resistance measurements, thermoelectric EMFs, and offset compensation methods, see the *Low Level Measurements Handbook*, available on [tek.com/keithley](http://tek.com/keithley).

---

## Equipment required

- One DMM6500
- One computer set up for communication with the instrument
- Four insulated banana cables
- One device to be tested (the application shown uses a 20  $\Omega$  resistor)

## Device connections

This example application uses the DMM6500 to perform a 4-wire resistance-device measurement using offset compensation. Both the front and rear-panel connections are safety banana jacks. You can use either the front or the rear input terminals.

### NOTE

You must use either the front or the rear terminals. You cannot mix the front and rear connections.

Make sure that the front-panel TERMINALS switch is set to the terminals you are using. The light for FRONT or REAR indicates which terminals are being used.

#### To use the 4-wire connection method:

1. Connect one set of test leads to the INPUT HI and INPUT LO terminals.
2. Connect the other set of test leads to the SENSE HI and SENSE LO terminals.

**Figure 35: Front-panel connections for 4-wire resistance measurements**

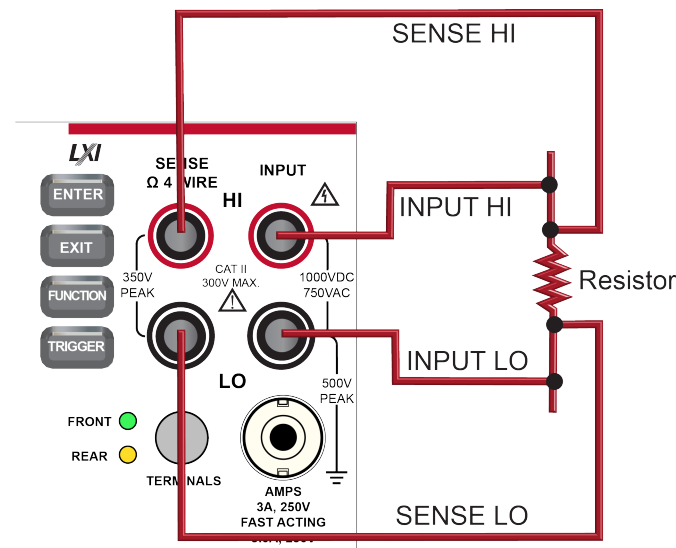
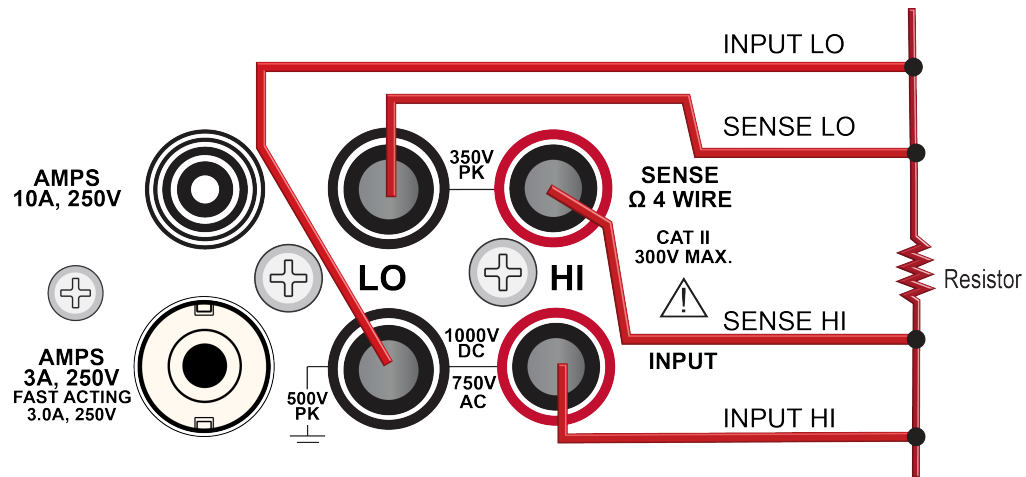

Figure 36: Rear-panel connections for 4-wire resistance measurements



3. Connect the INPUT HI and SENSE HI connections to one of the device-under-test (DUT) leads. Connect the sense connection as close to the DUT as possible.
4. Connect the INPUT LO and SENSE LO to the other DUT lead. Connect the sense connection as close to the DUT as possible.

## **⚠ WARNING**

To prevent electric shock, test connections must be configured such that the user cannot come in contact with test leads or any device under test (DUT) that is in contact with the conductors. It is good practice to disconnect DUTs from the instrument before powering the instrument. Safe installation requires proper shields, barriers, and grounding to prevent contact with test leads.

There is no internal connection between protective earth (safety ground) and the LO terminals of the DMM6500. Therefore, hazardous voltages (more than  $30 V_{RMS}$ ) can appear on LO terminals. This can occur when the instrument is operating in any mode. To prevent hazardous voltage from appearing on the LO terminals, connect the LO terminal to protective earth (safety ground) if your application allows it. You can connect the LO terminal to the chassis ground terminal on the front panel or the chassis ground screw terminal on the rear panel. Note that the front-panel terminals are isolated from the rear-panel terminals. Therefore, if you are using the front-panel terminals, ground to the front-panel LO terminal. If you are using the rear-panel terminals, ground to the rear-panel LO terminal. Failure to follow these guidelines can result in injury, death, or instrument damage.

## Measuring 4-wire resistance with offset compensation

This application demonstrates how to use the DMM6500 to measure the resistance of a device or component. You can make this measurement from the front panel or over the remote interface using SCPI or TSP code. For information about setting up remote communications, see [Remote communications interfaces](#) (on page 3-1).

For this application, you:

- Reset the instrument.
- Select the 4-wire resistance function. This method eliminates the effect of the lead resistance on measurement accuracy.
- Enable offset compensation.
- Make measurements from the front panel or the remote interface.

### Using the front panel

---

#### NOTE

Auto Zero is automatically set to On, and NPLC is automatically set to 1.

---

#### *To set up the application from the front panel:*

1. Press the **POWER** switch on the front panel to turn on the instrument.
2. On the FUNCTIONS swipe screen, select **4W Ω** to select the 4-wire resistance measure function.
3. Press the **MENU** key.
4. Under Measure, select **Settings**.
5. Set Range to **10kΩ**.
6. Select Offset Compensation and select **On**.
7. Press the **HOME** key.

The measurement readings are displayed in the top area of the home screen.

## Using SCPI commands

This sequence of SCPI commands measures the resistance of a device or component.

You may need to make changes so that this code will run in your programming environment. In the following table, the SCPI commands have a light gray background.

**Send the following commands for this example application:**

Commands	Descriptions
*RST :SENS:FUNC "FRES" :SENS:FRES:RANG: AUTO ON :SENS:FRES:OCOM ON :SENS:FRES:AZER ON :SENS:FRES:NPLC 1 :READ?	<ul style="list-style-type: none"> <li>▪ Reset the DMM6500.</li> <li>▪ Set the function to 4-wire measurement.</li> <li>▪ Enable autorange.</li> <li>▪ Enable offset compensation.</li> <li>▪ Enable autozero.</li> <li>▪ Set NPLC to 1.</li> <li>▪ Read the resistance value.</li> </ul>

## Using TSP commands

The following TSP code is designed to be run from Keithley Instruments Test Script Builder (TSB). TSB is a software tool that is available from [tek.com/keithley](http://tek.com/keithley). You can install and use TSB to write code and develop scripts for TSP-enabled instruments. Information about how to use TSB is in the online help for TSB and in the “Introduction to TSP operation” section of the *Model DMM6500 Reference Manual*.

To use other programming environments, you may need to make changes to the example TSP code.

By default, the DMM6500 uses the SCPI command set. You must select the TSP command set before sending TSP commands to the instrument.

**To enable TSP commands:**

1. Press the **MENU** key.
2. Under System, select **Settings**.
3. Set the Command Set to **TSP**.
4. At the prompt to reboot, select **Yes**.

This sequence of TSP commands initiates one resistance reading. After the code is executed, the data is displayed in the Instrument Console of Test Script Builder.



**Send the following commands for this example application:**

```
-- Reset the Model DMM6500 to the default settings.
reset()
-- Set the measure function to 4-wire resistance.
dmm.measure.func = dmm.FUNC_4W_RESISTANCE
-- Enable autorange.
dmm.measure.autorange = dmm.ON
-- Enable autozero.
dmm.measure.autozero.enable = dmm.ON
-- Enable offset compensation.
dmm.measure.offsetcompensation.enable = dmm.ON
-- Set the number of power line cycles to 1.
dmm.measure.nplc = 1
-- Read the resistance value.
print(dmm.measure.read())
```

## Test results

The results of a low-resistance measurement test using a 20 Ω resistor are shown in the table below.

For example, if the resistor specification has a tolerance of  $\pm 0.1\%$  and a temperature coefficient of  $\pm 15$  ppm per °C, a compliant resistor measures between 19.97 Ω and 20.03 Ω.

Offset compensation	Resistance
Off	19.992460878
On	19.991394395

**Figure 37: 4-wire resistance test results**



# Scanning temperature at a set time interval

## In this section:

Introduction .....	7-1
Equipment required.....	7-1
Device connections .....	7-2
Sample temperatures at a specific time interval.....	7-4

## Introduction

This application example demonstrates how to use the DMM6500 to log temperature measurement data from multiple scan-card channels, one every minute for 24 hours. The data is saved to a USB flash drive.

During production or storage, the temperature of the testing environment can be important. You can use the DMM6500 to monitor temperature at a fixed time interval for an extended period.

This application requires a Keithley Instruments 2001-TCSCAN card. The 2001-TCSCAN provides connections for up to nine channels of thermocouple temperature measurements.

For this application example, the card is connected to a type K thermocouple on each channel.

## Equipment required

- One DMM6500
- One 2001-TCSCAN card
- One computer set up for communication with the instrument
- One USB flash drive
- One device or component to be tested

## Device connections

The 2001-TCSCAN scan provides up to nine channels of thermocouple temperature measurements. For this example, each channel of the card is connected to a type K thermocouple. The card is then inserted into the rear of the DMM6500.

**To set up and install the 2001-TCSCAN card:**

1. Power off the instrument.
2. Make connections to the 2001-TCSCAN card as shown in the following figure.

**Figure 38: 2001-TCSCAN card**

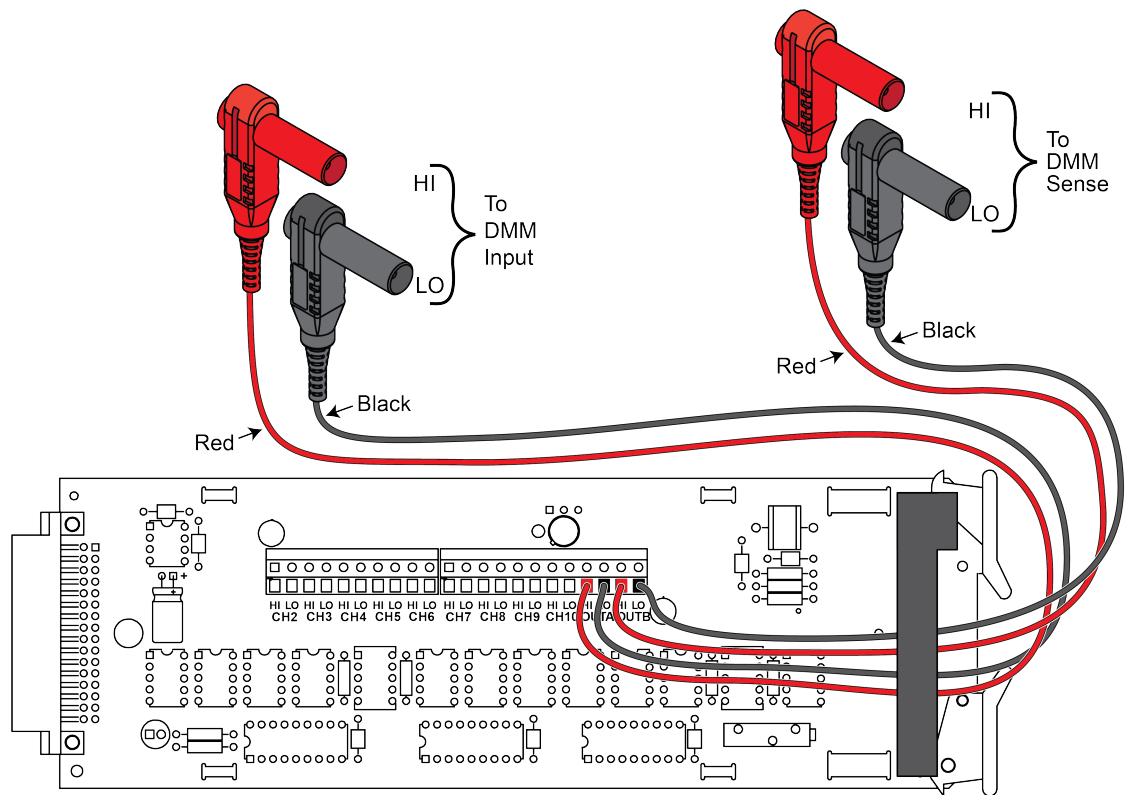

3. Install the 2001-TCSCAN card into the accessory card slot of the DMM6500. For information on installing the 2001-TCSCAN card, refer to the *Model 2001-TCSCAN Scanner Card for use with the DMM6500 User's Manual*, part number 2001-TCSCAN-900-01.

Figure 39: DMM6500 rear panel with TCSCAN card installed

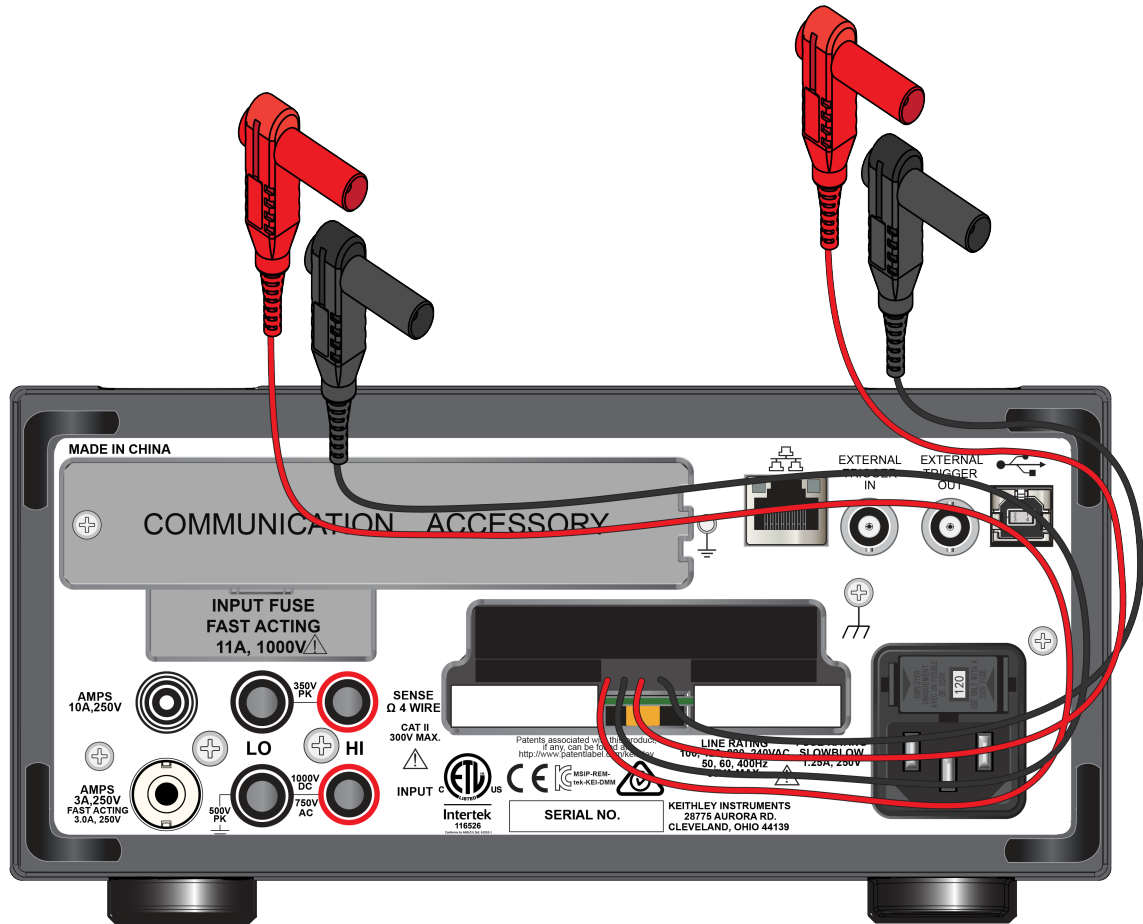

4. Power on the instrument.
5. Set the TERMINALS switch on the front panel of the instrument to **REAR**.

## **⚠ WARNING**

To prevent electric shock, test connections must be configured such that the user cannot come in contact with test leads or any device under test (DUT) that is in contact with the conductors. It is good practice to disconnect DUTs from the instrument before powering the instrument. Safe installation requires proper shields, barriers, and grounding to prevent contact with test leads.

---

## WARNING

There is no internal connection between protective earth (safety ground) and the LO terminals of the DMM6500. Therefore, hazardous voltages (more than 30 V<sub>RMS</sub>) can appear on LO terminals. This can occur when the instrument is operating in any mode. To prevent hazardous voltage from appearing on the LO terminals, connect the LO terminal to protective earth (safety ground) if your application allows it. You can connect the LO terminal to the chassis ground terminal on the front panel or the chassis ground screw terminal on the rear panel. Note that the front-panel terminals are isolated from the rear-panel terminals. Therefore, if you are using the front-panel terminals, ground to the front-panel LO terminal. If you are using the rear-panel terminals, ground to the rear-panel LO terminal. Failure to follow these guidelines can result in injury, death, or instrument damage.

---

## Sample temperatures at a specific time interval

This example application uses the DMM6500 to scan a set of channels, measuring temperature at a fixed interval. You can control the instrument from the front panel or over the remote interface using SCPI code or TSP code. For information about setting up remote communications, see [Remote communications interfaces](#) (on page 3-1).

For this application, you will:

- Power on the instrument.
- Configure channels two through ten to measure temperature using type K thermocouples and the internal reference junction.
- Use the Scan menu to set up a temperature scan of channels 2 to 10 that occurs every minute for 24 hours for a total of 1440 scans.

## Using the front panel

### *To set up the application through the front panel:*

1. Press the **POWER** button on the front panel to turn on the instrument.
2. Select the **REAR** terminals.
3. Swipe to the SCAN screen, then select **Build Scan**. The SCAN screen opens.
4. Select the **+** button.
5. Select channel **1**, then select **OK**.
6. On the Measure Functions dialog box, select **Temperature**.
7. On the settings tab, set the Transducer to **CJC 2001**.
8. Select the **+** button.
9. Select channels **2** through **10** and select **OK**.
10. From the Function dialog box, select **Temperature**.

11. On the Settings tab, select the following:
  - Transducer: **TC**
  - Thermocouple: **K**
  - Unit: **Celsius**
  - NPLC: **1**
12. Select the **Scan** tab.
13. Set the Scan Count to **1440** (24 hours \* 60 minutes).
14. Set the Scan to Scan Interval to **60 s**.
15. Set Export to USB to **After Each Scan**.
16. Set the Filename to **scan24hr** and select **OK**.
17. Select **OK** on the File Content dialog box.
18. Set Power Loss Restart to **On**.
19. Select **Start** on the SCAN screen.
20. To view the results, select **View Scan Status**, which opens the SCAN swipe screen on the home screen.

## Using SCPI commands

This sequence of SCPI commands executes a thermocouple-based temperature scan every minute for 24 hours.

You may need to make changes so that this code runs in your programming environment. In the following table, the SCPI commands have a light gray background.

Make sure the TERMINALS switch is set to **REAR**.

**Send the following commands for this example application:**

---

### NOTE

The scan count is  $24 * 60$ ; the channel count (`chanCount`) is 10. The total number of readings (`totalRdgs`) is `scanCount * chanCount`.

---

Commands	Descriptions
<pre> *RST TRAC:CLE "defbuffer1" TRAC:POIN 12960, "defbuffer1" FUNC "TEMP", (@1:10) TEMP:UNIT CELS, (@1:10) TEMP:TRAN CJC2001, (@1) TEMP:TRAN TC, (@2:10) TEMP:TC:TYPE K, (@2:10) TEMP:TC:RJUN:RSEL EXT, (@2:10) TEMP:NPLC 1, (@2:10) ROUT:SCAN:INT 60 ROUT:SCAN:COUN:SCAN 1440 ROUT:SCAN:CRE (@1:10) ROUT:SCAN:EXP "/usb1/scan24hr", SCAN, ALL ROUT:SCAN:REST ON INIT *WAI TRAC:DATA? 1, totalRdgs, "defbuffer1\", READ </pre>	<ul style="list-style-type: none"> <li>■ Reset the DMM6500</li> <li>■ Clear the data buffer</li> <li>■ Set the scan count to 12,960</li> <li>■ Set the function to temperature</li> <li>■ Set up all channels to use degrees Celsius</li> <li>■ Set up channel 1 reference junction</li> <li>■ Set the transducer type to thermocouple</li> <li>■ Set thermocouple type to K</li> <li>■ Set the reference junction to external</li> <li>■ Set NPLC to 1</li> <li>■ Set the scan-to-scan delay to 60 seconds</li> <li>■ Set the scan count to 1440 (24 hr * 60 s)</li> <li>■ Set the scan list</li> <li>■ Prepare the scan to export the buffer to the USB flash drive after each scan</li> <li>■ Enable restart on power loss</li> <li>■ Start the scan</li> <li>■ Suspend the scan</li> <li>■ Return data from the buffer after the scan completes</li> </ul>

## Using TSP

The following TSP code is designed to be run from Keithley Instruments Test Script Builder (TSB). TSB is a software tool that is available from [tek.com/keithley](http://tek.com/keithley). You can install and use TSB to write code and develop scripts for TSP-enabled instruments. Information about how to use TSB is in the online help for TSB and in the "Introduction to TSP operation" section of the *Model DMM6500 Reference Manual*.

To use other programming environments, you may need to make changes to the example TSP code.

By default, the DMM6500 uses the SCPI command set. You must select the TSP command set before sending TSP commands to the instrument.

### To enable TSP commands:

1. Press the **MENU** key.
2. Under System, select **Settings**.
3. Set the Command Set to **TSP**.
4. At the prompt to reboot, select **Yes**.

This sequence of TSP commands makes a series of temperature measurements. After the code executes, the data is displayed in the Instrument Console of Test Script Builder.

Make sure the TERMINALS switch is set to **REAR**.

**Send the following commands for this example application:**

```
-- Reset the instrument to the default settings.
reset()

-- Establish variables to make a measurement every 60 seconds 1440 times (24 hours).
local scanCnt = 24 * 60 -- 1440 minutes = 24 hours
local chanCnt = 10
local totalRdgs = scanCnt * chanCnt

-- Empty the buffer and set it to the capacity calculated by totalRdgs.
defbuffer1.clear()
defbuffer1.capacity = totalRdgs

-- Set up the channels to measure temperature using type K thermocouples using internal
  reference junction.
channel.setdmm("1:10", dmm.ATTR_MEAS_FUNCTION, dmm.FUNC_TEMPERATURE)
channel.setdmm("1:10", dmm.ATTR_MEAS_UNIT, dmm.UNIT_CELSIUS)
channel.setdmm("1:10", dmm.ATTR_MEAS_NPLC, 1)
channel.setdmm("1:10", dmm.ATTR_MEAS_DIGITS, dmm.DIGITS_5_5)
channel.setdmm("1", dmm.ATTR_MEAS_TRANSDUCER, dmm.TRANS_CJC2001)
channel.setdmm("2:10", dmm.ATTR_MEAS_TRANSDUCER, dmm.TRANS_THERMOCOUPLE)
channel.setdmm("2:10", dmm.ATTR_MEAS_THERMOCOUPLE, dmm.THERMOCOUPLE_K)
channel.setdmm("2:10", dmm.ATTR_MEAS_REF_JUNCTION, dmm.REFJUNCT_EXTERNAL)

-- Set up the scan; channel 2 is first available channel on a 2001-TCSCAN card.
scan.create("2:10")
scan.scancount = scanCnt

-- Set the amount of time for each scan.
scan.scaninterval = 60.0

-- Write the data to a USB flash drive at the end of the scan.
scan.export("/usb1/scan24hr", scan.WRITE_AFTER_SCAN, buffer.COL_ALL)

-- Enable scan restart on power loss
scan.restart = scan.ON

-- Start the scan.
trigger.model.initiate()
waitcomplete()

-- Get the data.
printbuffer(1, defbuffer1.n, defbuffer1)
```



## Test results

The following figures show a sample graph and final test measurement for this application.

Figure 40: DMM6500 graph of temperature measurements

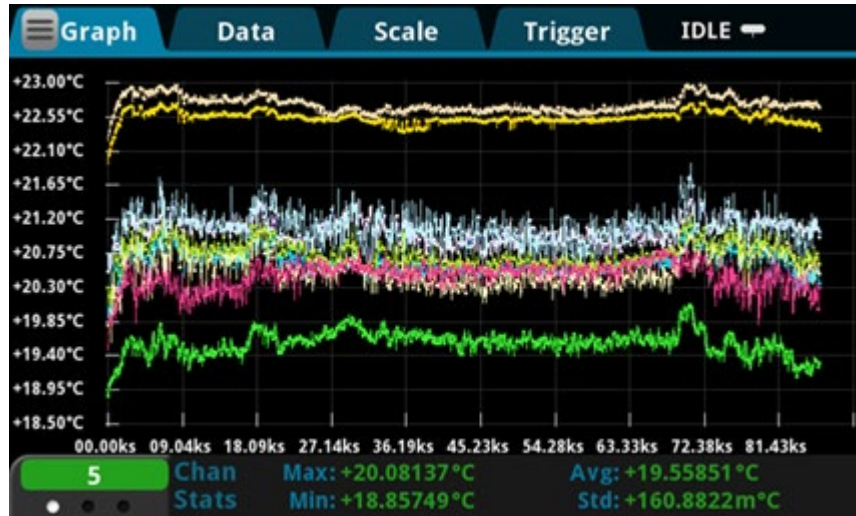

Figure 41: DMM6500 final temperature measurement



---

## Grading and binning resistors

### In this section:

Introduction .....	8-1
Equipment required.....	8-1
Device connections .....	8-1
Resistor grading and binning test.....	8-3

## Introduction

This application example demonstrates how to use the DMM6500 to perform benchtop binning operations. It uses the trigger model and digital I/O to control external component-handling devices.

The DMM6500 can do simple pass-or-fail testing as well as grading and sorting. Grading resistors is a common application that is done by monitoring multiple limits until the first failure. Binning resistors is also common, but unlike grading, binning involves monitoring limits until the first pass is received.

## Equipment required

- One DMM6500
- One computer set up for communication with the instrument
- One device or component to be tested

## Device connections

This example application uses a DMM6500 to perform benchtop binning operations. Output signals (grading results) are sent from the instrument to the component handler, which bins the devices.

The figure below shows the rear-panel connections from the DMM6500 to the test fixture and the digital lines to the component handler. The optional GPIB communication card connects the controller and the component handler.

---

### NOTE

Digital lines and GPIB communications require the KTTI-GPIB communications accessory card.

---

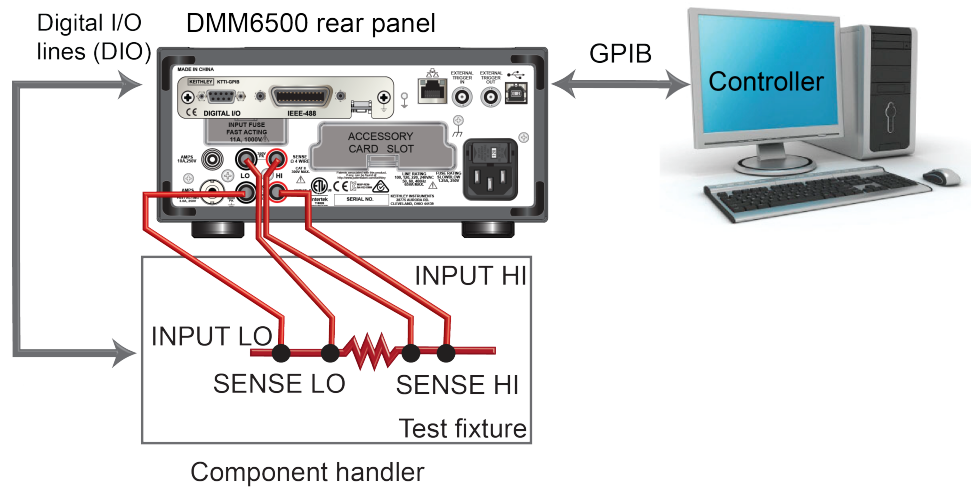
**Figure 42: Device connections for component binning**

---

## **⚠ WARNING**

To prevent electric shock, test connections must be configured such that the user cannot come in contact with test leads or any device under test (DUT) that is in contact with the conductors. It is good practice to disconnect DUTs from the instrument before powering the instrument. Safe installation requires proper shields, barriers, and grounding to prevent contact with test leads.

There is no internal connection between protective earth (safety ground) and the LO terminals of the DMM6500. Therefore, hazardous voltages (more than 30 V<sub>RMS</sub>) can appear on LO terminals. This can occur when the instrument is operating in any mode. To prevent hazardous voltage from appearing on the LO terminals, connect the LO terminal to protective earth (safety ground) if your application allows it. You can connect the LO terminal to the chassis ground terminal on the front panel or the chassis ground screw terminal on the rear panel. Note that the front-panel terminals are isolated from the rear-panel terminals. Therefore, if you are using the front-panel terminals, ground to the front-panel LO terminal. If you are using the rear-panel terminals, ground to the rear-panel LO terminal. Failure to follow these guidelines can result in injury, death, or instrument damage.

---

## Resistor grading and binning test

This resistance-grading application uses limit tests to inspect a single resistor under test against multiple limits until the first failure occurs. When the resistor fails, it is placed into a designated resistance tolerance bin, as defined by the limits.

Resistors are placed into bins based on the bit patterns that are assigned to the limits. In this example, the DMM6500 GradeBinning trigger model template is used to simplify the application. This trigger model template grades components into four tolerance levels (for example, 20%, 10%, 5%, and 1%) as defined by limits 1 to 4. A single spot measurement is inspected against multiple limits, which tighten progressively around the same nominal value. Since there is no need to continue checking limits once the appropriate tolerance level for a resistor under test is determined, this application typically bins the tested resistors immediately.

Because the limits are inspected in ascending numeric order, the measured resistance is checked first against Limit 1, which is the 20% limit. If the resistor fails this limit inspection, its resistance value is outside of the 20% tolerance band, and the trigger model outputs the Limit 1 Fail Pattern, which causes the component handler to place the resistor in the Limit 1 fail bin (20% fail bin).

If a resistor passes the 20% limit test, the resistance value is checked against Limit 2, which is the 10% limit value. If the resistor fails this limit inspection, the resistance is outside of the 10% tolerance band. The trigger model outputs the Limit 2 Fail Pattern, which causes the component handler to place the resistor in the Limit 2 fail bin (10% fail bin).

If a resistor passes the 10% limit test, the resistance value is checked against Limit 3, which is the 5% limit value. If a resistor passes all the limit tests, the trigger model outputs the Overall Pass Bit Pattern, which causes the component handler to place the resistor in the bin for components that have passed all the limit checks.

For this example, the same fail pattern is assigned to both the lower and upper bounds of the limits. Therefore, a fail bin contains resistance values in the range  $R-P\%$  to  $R+P\%$ .  $P$  in this example is 20, 10, 5, or 1. You can assign different bit patterns for different limit values.

For this application, you:

- Reset the instrument.
- Select the 4-wire resistance function.
- Enable offset compensation.
- Set autozero to once.
- Set up digital I/O lines one to four as outputs to component handler.
- Set up digital I/O line five for trigger-model control, detecting the trigger as the start-of-test input.
- Set up digital I/O line six as the end-of-test output notification.
- Initiate the GradeBinning trigger-model template.
- Display "Test Completed" on the front panel.

## Trigger model template settings for the grade and binning test

The trigger model template contains the settings for the number of components, digital I/O, and limits. The command parameters for the template are described in the following command and table.

### SCPI command usage:

```
:TRIGger:LOAD "GradeBinning", <components>, <startInLine>, <startDelay>, <endDelay>,
<limit1High>, <limit1Low>, <limit1Pattern>, <allPattern>, <limit2High>,
<limit2Low>, <limit2Pattern>, <limit3High>, <limit3Low>, <limit3Pattern>,
<limit4High>, <limit4Low>, <limit4Pattern>, "<bufferName>"
```

### TSP command usage:

```
trigger.model.load("GradeBinning", components, startInLine, startDelay, endDelay,
limit1High, limit1Low, limit1Pattern, allPattern, limit2High, limit2Low,
limit2Pattern, limit3High, limit3Low, limit3Pattern, limit4High, limit4Low,
limit4Pattern, bufferName)
```

### Parameter list

<i>components</i>	100
<i>startInLine</i>	Digital I/O line 5
<i>startDelay</i>	100 ms
<i>endDelay</i>	100 ms
<i>limit1High</i>	$R = 100 \Omega$ , $P = 20\%$ , $100+20\% = 120 \Omega$
<i>limit1Low</i>	$R = 100 \Omega$ , $P = 20\%$ , $100-20\% = 80 \Omega$
<i>limit1Pattern</i>	Bin 1 Fail Pattern 15: Drive all digital I/O lines high (1111)
<i>allPattern</i>	All Pass Pattern 4: Drive line 3 high (0100)
<i>limit2High</i>	$R = 100 \Omega$ , $P = 10\%$ , $100+10\% = 110 \Omega$
<i>limit2Low</i>	$R = 100 \Omega$ , $P = 10\%$ , $100-10\% = 90 \Omega$
<i>limit2Pattern</i>	Bin 2 Fail Pattern 1: Drive line 1 high (0001)
<i>limit3High</i>	$R = 100 \Omega$ , $P = 5\%$ , $100+5\% = 105 \Omega$
<i>limit3Low</i>	$R = 100 \Omega$ , $P = 5\%$ , $100-5\% = 95 \Omega$
<i>limit3Pattern</i>	Bin 3 Fail Pattern 2: Drive line 2 high (0010)
<i>limit4High</i>	$R = 100 \Omega$ , $P = 1\%$ , $100+1\% = 101 \Omega$
<i>limit4Low</i>	$R = 100 \Omega$ , $P = 1\%$ , $100-1\% = 99 \Omega$
<i>limit4Pattern</i>	Bin 4 Fail Pattern 3: Drive line 1 and 2 high (0011)
<i>bufferName</i>	The reading buffer is set to <i>bufferVar</i>

## Using SCPI commands

This sequence of SCPI commands grades resistors into bins based on measured accuracy.

You may need to make changes so that this code will run in your programming environment.

**Send the following commands for this example application:**

```

*RST
:TRAC:MAKE "bufferVar", 1000000
:TRAC:CLE "bufferVar"
:SENS:FUNC "FRES"
:SENS:FRES:NPLC 1
:SENS:AZER:ONCE
:SENS:FRES:OCOM ON
:DIGital:LINE1:MODE DIG, OUT
:DIG:LINE2:MODE DIG, OUT
:DIG:LINE3:MODE DIG, OUT
:DIG:LINE4:MODE DIG, OUT
:DIG:LINE1:STAT 0
:DIG:LINE2:STAT 0
:DIG:LINE3:STAT 0
:DIG:LINE4:STAT 0
:DIG:LINE5:MODE TRIG, IN
:TRIG:DIG5:IN:EDGE FALL
:DIG:LINE6:MODE TRIG, OUT
:TRIG:DIG6:OUT:LOG NEG
:TRIG:DIG6:OUT:PULS 10e-6
:TRIG:DIG6:OUT:STIM NOT1
:TRIG:LOAD "GradeBinning", 100, 5, .1, .1, 120, 80, 15, 4, 110, 90, 1, 105, 95, 2, 101,
    99, 3, "bufferVar"
INIT
*WAI
:DISP:USER1: TEXT "Test Completed"
:DISP:SCR SWIPE_USER

```

- Reset the DMM6500
- Make a buffer named `bufferVar` with a capacity of 1,000,000 readings
- Clear `bufferVar`
- Set instrument to measure 4-wire resistance
- Set the number of power line cycles (NPLC) to 1
- Immediately update autozero reference measurements and then disable the autozero function
- Enable offset compensation for more accurate resistance readings
- Configure digital I/O lines 1 through 4 as digital outputs; these are used to output binning code to the component handler
- Set the states of digital I/O lines 1 through 4 to bit low
- Configure digital I/O line 5 as trigger input to detect start-of-test trigger
- Set trigger detector to detect falling edge on digital I/O line 5
- Configure digital I/O line 6 as a trigger output used to send end-of-test trigger with negative logic and output pulse width of 10  $\mu$ s
- The trigger pulse occurs when the Notify block generates an event
- Define the GradeBinning trigger model template
- Initiate the trigger model
- Wait for the trigger model to complete
- Display "Test Completed" when the binning test is complete
- Set the front-panel display to the USER swipe screen

## Using TSP commands

The following TSP code is designed to be run from Keithley Instruments Test Script Builder (TSB). TSB is a software tool that is available from [tek.com/keithley](http://tek.com/keithley). You can install and use TSB to write code and develop scripts for TSP-enabled instruments. Information about how to use TSB is in the online help for TSB and in the “Introduction to TSP operation” section of the *Model DMM6500 Reference Manual*.

To use other programming environments, you may need to make changes to the example TSP code.

By default, the DMM6500 uses the SCPI command set. You must select the TSP command set before sending TSP commands to the instrument.

### **To enable TSP commands:**

1. Press the **MENU** key.
2. Under System, select **Settings**.
3. Set the Command Set to **TSP**.
4. At the prompt to reboot, select **Yes**.

This sequence of TSP commands will grade resistors into established bins of accuracy. After the code executes, the data is displayed in the Instrument Console of Test Script Builder.

### **Send the following commands for this example application:**

```
-- Reset the instrument to default settings
reset()
-- Create a user-defined reading buffer that can store up to 1 million readings
bufferVar = buffer.make(1000000)
-- Clear the buffer.
bufferVar.clear()
-- Set the measure function to 4-wire resistance
dmm.measure.func = dmm.FUNC_4W_RESISTANCE
-- Set the number of power line cycles to 1
dmm.measure.nplc = 1
-- Immediately update autozero reference measurements and then disable the autozero
  function
dmm.measure.autozero.once()
-- Enable offset compensation for more accurate resistance reading
dmm.measure.offsetcompensation.enable = dmm.ON
-- Configure digital I/O lines 1 through 4 as digital outputs. These I/O lines are used
  to output binning code to component handler
digio.line[1].mode = digio.MODE_DIGITAL_OUT
digio.line[2].mode = digio.MODE_DIGITAL_OUT
digio.line[3].mode = digio.MODE_DIGITAL_OUT
digio.line[4].mode = digio.MODE_DIGITAL_OUT
-- Clear digital I/O lines to 0
digio.line[1].state = digio.STATE_LOW
digio.line[2].state = digio.STATE_LOW
digio.line[3].state = digio.STATE_LOW
digio.line[4].state = digio.STATE_LOW
```

```
-- Configure digital I/O line 5 as a trigger input used to detect
-- the start-of-test trigger from the component handler
digio.line[5].mode = digio.MODE_TRIGGER_IN
-- Set trigger detector to detect falling edge
trigger.digin[5].edge = trigger.EDGE_FALLING
-- Configure digital I/O line 6 as a trigger output used to send
-- an end-of-test trigger to the component handler
digio.line[6].mode = digio.MODE_TRIGGER_OUT
-- Output a falling edge trigger
trigger.digout[6].logic = trigger.LOGIC_NEGATIVE
-- Set width of output trigger pulse to 10 us
trigger.digout[6].pulsewidth = 10e-6
-- Trigger pulse is output when the Notify Block generates an event
trigger.digout[6].stimulus = trigger.EVENT_NOTIFY2
-- Load Component Binning trigger model template
trigger.model.load("GradeBinning", 100, 5, .1, .1, 120, 80, 15, 4, 110, 90, 1, 105, 95,
    2, 101, 99, 3, bufferVar)
-- Initiate trigger model and wait until finished
trigger.model.initiate()
waitcomplete()
-- Display message on front-panel USER swipe screen after binning test completes
display.settext(display.TEXT1, "Test Completed")
display.changescreen(display.SCREEN_USER_SWIPE)
```



---

## Measuring power using digitizing and TSP-Link

### In this section:

Introduction .....	9-1
Equipment required.....	9-2
Device connections .....	9-2
Measuring power using digitizing and TSP-Link.....	9-4

## Introduction

This application example demonstrates how to configure two DMM6500 instruments to use TSP-Link® to measure the power consumed by a Bluetooth® low-energy (BLE) device.

For this example, one DMM6500 measures digitized voltage while the other instrument measures digitized current. Using TSP-Link, these measurements are made simultaneously and the results communicated between the two instruments. Using TSP scripting, the average power consumption during the test period is calculated using the following formula in which  $P_{ave}$  is the average power and  $n$  is the number of points.

$$P_{ave} = \frac{I_1V_1 + I_2V_2 + \dots + I_nV_n}{n}$$

This application example calculates power at each point along the waveform by multiplying corresponding currents and voltages, adding them together, and dividing them by the total number of data points to find the average power usage.

Average power measurements provide insight into device performance. This is more accurate than multiplying the average current by the average voltage to find average power.

Some applications calculate power by measuring current measurements and then multiplying them by the known battery voltage. The advantage of digitizing both current and voltage simultaneously is increased accuracy, because the exact voltage is known at each current measurement.

These measurements are especially important when the device under test (DUT) requires a battery to operate, because minimizing power consumption maximizes battery life.

## Equipment required

This application requires the following equipment:

- Two DMM6500 instruments
- Two KTTI-TSP communication and digital I/O accessory cards
- One computer set up for communication with the instrument
- One ethernet crossover cable
- Several insulated banana cables
- One device or component to be tested

## Device connections

This application requires two KTTI-TSP communication and digital I/O accessory cards.

1. Insert one card into the accessory card slot on the rear panel of each instrument. Refer to [Install the KTTI-TSP accessory](#) (on page 3-16) card for installation instructions.
2. Connect the instruments with a crossover cable connected to the communication cards.

**Figure 43: Two DMMs connected with TSP-Link**



3. Connect the computer to the DMM6500 that is set to node one.
4. Connect the test leads of the instrument measuring voltage in parallel with the battery of the device.
5. Connect the test leads of the instrument measuring current in series with the battery of the device.

**Figure 44: Two nodes measuring current and voltage**

Node 1: Voltage

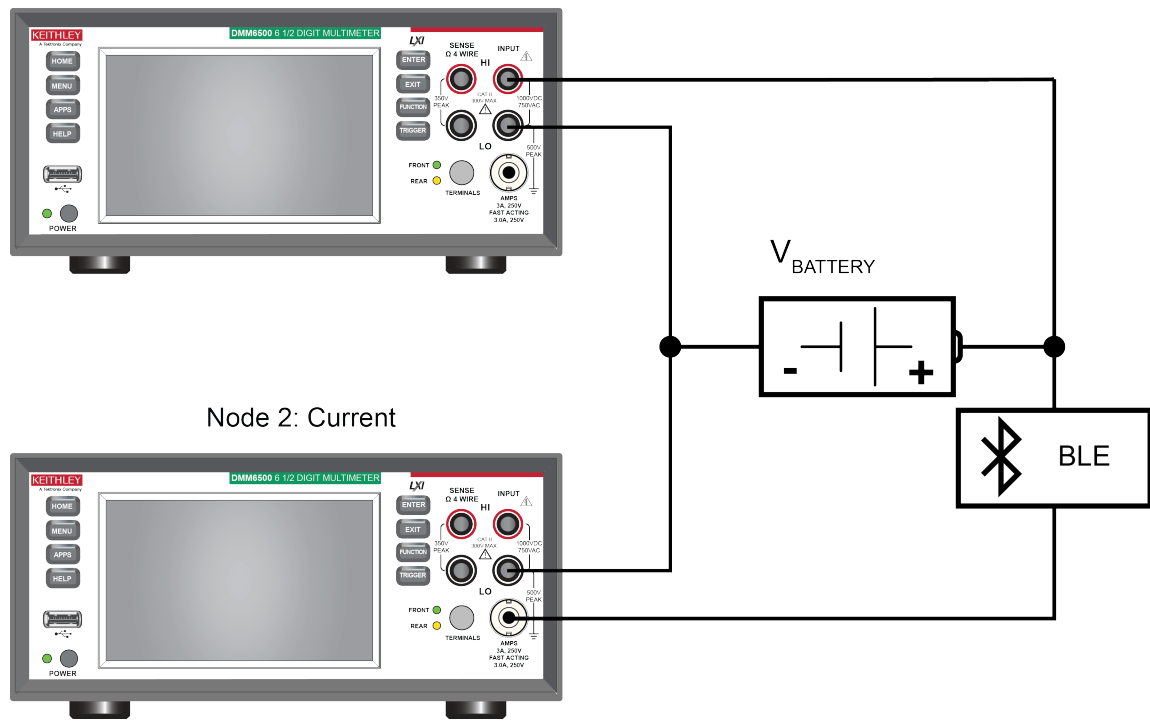
**⚠ WARNING**

To prevent electric shock, test connections must be configured such that the user cannot come in contact with test leads or any device under test (DUT) that is in contact with the conductors. It is good practice to disconnect power before connecting DUTs. Safe installation requires proper shields, barriers, and grounding to prevent contact with test leads.

There is no internal connection between protective earth (safety ground) and the LO terminals of the DMM6500. Therefore, hazardous voltages (more than 30 V<sub>RMS</sub>) can appear on LO terminals. This can occur when the instrument is operating in any mode. To prevent hazardous voltage from appearing on the LO terminals, connect the LO terminal to protective earth (safety ground) if your application allows it. You can connect the LO terminal to the chassis ground terminal on the front panel or the chassis ground screw terminal on the rear panel. Note that the front-panel terminals are isolated from the rear-panel terminals. Therefore, if you are using the front-panel terminals, ground to the front-panel LO terminal. If using the rear-panel terminals, ground to the rear panel LO terminal. Failure to follow these guidelines can result in injury, death, or instrument damage. Failure to recognize and observe normal safety precautions could result in personal injury or death.

## Measuring power using digitizing and TSP-Link

For this application, you will:

- Set the TSP-Link nodes for the DMM6500 instruments to 1 and 2.
- Reset the instruments.
- Initialize TSP-Link.
- Configure the input and output TSP-Link triggers for the DMM6500 instruments.
- Set up the digitize function.
- Set up trigger models on both instruments.
- Initiate measurements on both DMM6500 instruments.
- Use buffer statistics to find the average current and voltage.
- Find the average power usage of a Bluetooth device.
- Print the results to the USER swipe screen.

### Using SCPI commands

This example cannot be replicated in SCPI code because TSP-Link events and commands are only available through the TSP command language.

However, you can use other instrument trigger interfaces, such as digital I/O or external trigger I/O, to replace TSP-Link and achieve similar operation.

### Setting up the nodes for TSP code

Before executing the TSP code, you must set up the nodes on the instruments and configure the TSP-Link network.

#### *To set up TSP-Link on the DMM6500:*

1. Press the **MENU** key.
2. Under System, select **Communication**.
3. Select the **TSP-Link** tab.
4. Set the Node to **1** on the instrument that is used to measure voltage
5. Repeat these steps on the other instrument and set the Node to **2** on the instrument that is used to measure current.
6. Select **Initialize** on each instrument.

---

## NOTE

The communication from the computer is made directly to the first DMM6500 (node 1) in the following TSP code. This code makes the first DMM6500 the master in this TSP-Link network, with the second DMM6500 as the subordinate. You can change the master to be the second DMM6500, but you must modify the code and modify how the TSP-Link network is initialized. The master node does not require the `node[x].` prefix.

If you need to improve program execution speed, remove the `node[1]` prefixes in the following TSP code.

---

## Using TSP commands

The following TSP code is designed to be run from Keithley Instruments Test Script Builder (TSB). TSB is a software tool that is available from [tek.com/keithley](http://tek.com/keithley). You can install and use TSB to write code and develop scripts for TSP-enabled instruments. Information about how to use TSB is in the online help for TSB and in the “Introduction to TSP operation” section of the *Model DMM6500 Reference Manual*.

To use other programming environments, you may need to make changes to the example TSP code.

By default, the DMM6500 uses the SCPI command set. You must select the TSP command set before sending TSP commands to the instrument.

### **To enable TSP commands:**

1. Press the **MENU** key.
2. Under System, select **Settings**.
3. Set the Command Set to **TSP**.
4. At the prompt to reboot, select **Yes**.

This sequence of TSP commands measures power using the digitize function and TSP-Link. After the code executes, the data is displayed in the Instrument Console of Test Script Builder.

### **Send the following commands for this example application:**

```
-- Initiate the tsp-link network.
tsplink.initialize()
-- Set a delay of 0.5 seconds.
delay(0.5)
-- Reset master instrument at node 1.
node[1].reset()
-- Set up TSP-link trigger line 1 to trigger the subordinate node digitize function.
node[1].tsplink.line[1].mode = tsplink.MODE_TRIGGER_OPEN_DRAIN
node[1].trigger.tsplinkout[1].stimulus = trigger.EVENT_NOTIFY1
-- Set up digitize voltage function settings.
node[1].dmm.digitize.func = dmm.FUNC_DIGITIZE_VOLTAGE
node[1].dmm.digitize.samplerate = 5000
```

```
-- Set up digitize voltage range based on voltage applying to the BLE device.
node[1].dmm.digitize.range = 10
-- Set up reading buffers.
node[1].defbuffer1.capacity = 50000
-- Set up trigger model.
node[1].trigger.model.setblock(1, trigger.BLOCK_NOTIFY, trigger.EVENT_NOTIFY1)
node[1].trigger.model.setblock(2, trigger.BLOCK_WAIT, trigger.EVENT_TSPLINK1)
node[1].trigger.model.setblock(3, trigger.BLOCK_MEASURE_DIGITIZE, defbuffer1, 50000)

-- Reset instrument at node 2.
node[2].reset()
-- Set up TSP-link trigger line 1 to receive a trigger from master node.
node[2].tsplink.line[1].mode = node[2].tsplink.MODE_TRIGGER_OPEN_DRAIN
-- Set up digitize current function settings.
node[2].dmm.digitize.func = node[2].dmm.FUNC_DIGITIZE_CURRENT
node[2].dmm.digitize.samplerate = 5000
-- Set up digitize current range based on maximum current the BLE device can draw.
node[2].dmm.digitize.range = 1
-- Set up reading buffers.
node[2].defbuffer1.capacity = 50000
-- Set up trigger model.
node[2].trigger.model.setblock(1, node[2].trigger.BLOCK_WAIT,
    node[2].trigger.EVENT_TSPLINK1)
node[2].trigger.model.setblock(2, node[2].trigger.BLOCK_MEASURE_DIGITIZE,
    defbuffer1, 50000)

-- Show graph of measurements on swipe screens.
node[1].display.changescreen(node[1].display.SCREEN_GRAPH_SWIPE)
node[2].display.changescreen(node[2].display.SCREEN_GRAPH_SWIPE)
delay(1.0)
-- Initiate trigger model on both instruments.
node[2].trigger.model.initiate()
trigger.model.initiate()
-- Wait for test to complete.
waitcomplete()

-- Retrieve buffer statistics.
voltage_buffer = node[1].defbuffer1
voltage_stats = node[1].buffer.getstats(voltage_buffer)
avgVolt = voltage_stats.mean
print(avgVolt .. " Volts")

current_buffer = node[2].defbuffer1
current_stats = node[2].buffer.getstats(current_buffer)
avgCurr = current_stats.mean
print(avgCurr .. " Amps")

-- Print results to the USER swipe screen.
node[1].display.changescreen(display.SCREEN_USER_SWIPE)
node[1].display.settext(display.TEXT1, "AVG V: " .. string.format("%.2e", avgVolt) ..
    " V")
node[1].display.settext(display.TEXT2, "Average Power: Calculating... ")
node[2].display.changescreen(display.SCREEN_USER_SWIPE)
node[2].display.settext(display.TEXT1, "AVG I: " .. string.format("%.2e", avgCurr) ..
    " A")
node[2].display.settext(display.TEXT2, "Average Power: Calculating... ")
```

```

-- Calculate power using reading index-based method.
power_total = 0
num_readings = current_buffer.n

-- Iterate through each current and voltage reading, and calculate power.
for i = 1, num_readings do
    current = current_buffer.readings[i]
    voltage = voltage_buffer.readings[i]

    -- Keep track of the total power
    power_total = power_total + current*voltage
end

-- Find average power by dividing total power by the number of readings.
average_power = power_total / num_readings
print(average_power .. " Watts")

-- Print results to USER swipe screen.
node[1].display.changescreen(display.SCREEN_USER_SWIPE)
node[1].display.settext(display.TEXT2, "Average Power: ".. string.format("%8f",
    average_power) .. " W")
node[2].display.settext(display.TEXT2, "Average Power: ".. string.format("%8f",
    average_power) .. " W")

```

## Results

The voltage and current waveforms captured on the DMM6500 show the power consumption resulting from the use of the DUT. You can identify the transmission state of the device by the areas of high current consumption and the visible drop in voltage from the battery. Because these measurements are triggered within 2  $\mu$ s of each other, the voltage and current data is synchronized nearly point-for-point.

You can expand on this example by importing the data from the reading buffer from each of the instruments to a computer and analyzing the data more closely.

**Figure 45: Master node measuring voltage**



Figure 46: Master node voltage waveform

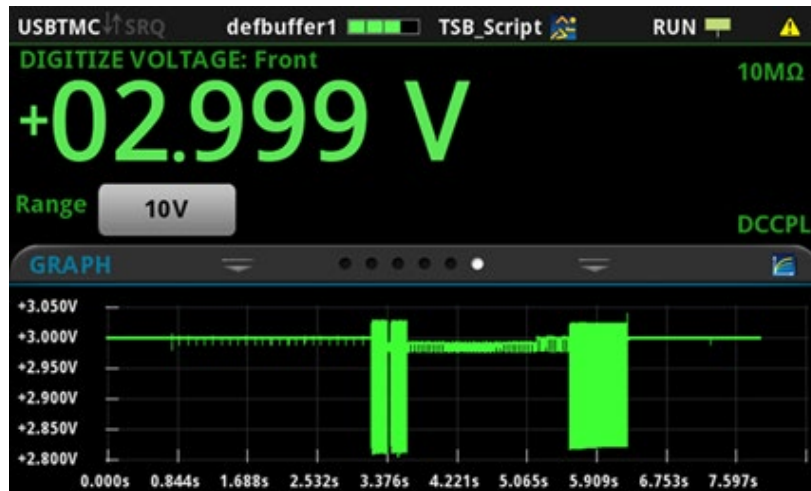
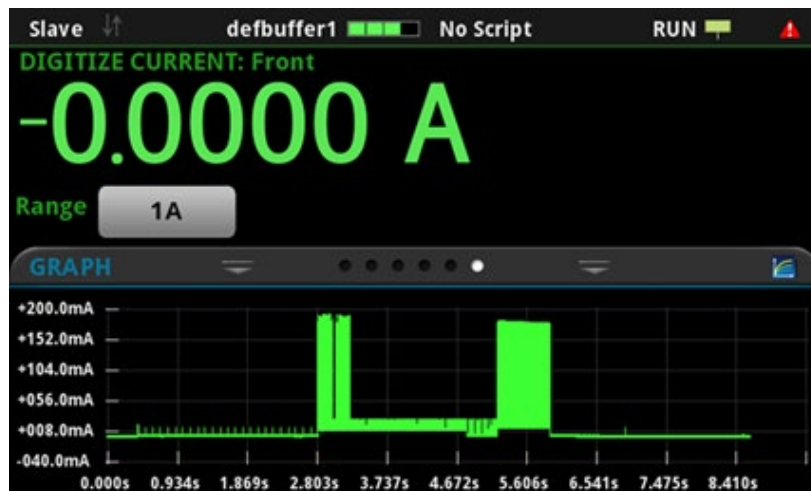

Figure 47: Subordinate node measuring current



Figure 48: Subordinate node current waveform





---

## Troubleshooting FAQs

### In this section:

About this section .....	10-1
Where can I find updated drivers?.....	10-1
Is there any software to help me get started?.....	10-2
How do I upgrade the firmware? .....	10-2
Why can't the DMM6500 read my USB flash drive? .....	10-3
How do I change the command set? .....	10-3
How do I save the present state of the instrument? .....	10-5
Why did my settings change?.....	10-6
How do I save what is displayed on the screen? .....	10-6
What is the ethernet port number? .....	10-6

## About this section

This section helps you find answers to the most common questions encountered with the DMM6500.

## Where can I find updated drivers?

For the latest drivers and additional support information, see the Keithley Instruments support website.

### *To see what drivers are available for your instrument:*

1. Go to [tek.com/support](http://tek.com/support).
2. Enter the model number of your instrument.
3. Select **Software** from the filter list.
4. Select **Driver** from the filter list.

---

## NOTE

If you use the native LabVIEW™ or IVI driver, you must configure the DMM6500 to use the SCPI command set. For information on changing the command set, refer to [How do I change the command set?](#) (on page 3-20)

---

## Is there any software to help me get started?

Yes. Keithley provides KickStart Software and Test Script Builder to help you get started with the DMM6500.

KickStart Software is a program that allows you to set up your instrument and run a test without using any programming languages.

Test Script Builder (TSB) is a software tool that simplifies building test scripts if you are using the Test Script Processor (TSP®) scripting engine.

Both software options are available on [tek.com/keithley](http://tek.com/keithley).

## Why did my settings change?

Many of the commands in the DMM6500 are saved with the measure function that was active when you set them. For example, assume you have the measure function set to current and you set a value for display digits. When you change the measure function to voltage, the display digits value changes to the value that was last set for the voltage measure function. When you return to the current measure function, the display digits value returns to the value you set previously.

## Why can't the DMM6500 read my USB flash drive?

Verify that the flash drive is formatted with the FAT32 file system. The DMM6500 only supports FAT and FAT32 drives using Master Boot Record (MBR).

In Microsoft® Windows®, you can check the file system by checking the properties of the USB flash drive.

---

### NOTE

Higher capacity USB drives take longer to be read and loaded by the instrument.

---

## How do I upgrade the firmware?

---

### CAUTION

Do not turn off power or remove the USB flash drive until the upgrade process is complete.

---

### NOTE

The firmware file must be in the root subdirectory of the USB flash drive and must be the only firmware file in that location. You can upgrade or downgrade the firmware from the front panel or from the virtual front panel. Refer to “Using the DMM6500 virtual front panel” in the *Model DMM6500 Reference Manual* for information.

---

**From the front panel:**

1. Copy the firmware file (.upg file) to a USB flash drive.
2. Verify that the firmware file is in the root subdirectory of the flash drive and that it is the only firmware file in that location.
3. Disconnect any terminals that are attached to the instrument.
4. Turn the instrument power off. Wait a few seconds.
5. Turn the instrument power on.
6. Insert the flash drive into the USB port on the front panel of the instrument.
7. From the instrument front panel, press the **MENU** key.
8. Under System, select **Info/Manage**.
9. Choose an upgrade option:
  - To upgrade to a newer version of firmware, select **Upgrade to New**.
  - To return to a previous version of firmware, select **Downgrade to Older**.
10. If the instrument is controlled remotely, a message is displayed. Select **Yes** to continue.
11. When the upgrade is complete, reboot the instrument.

A message is displayed while the upgrade is in progress.

Upgrade files are available on [tek.com/keithley](http://tek.com/keithley).

## How do I change the command set?

You can change the command set that you use with the DMM6500. The remote command sets that are available include:

- SCPI: An instrument-specific language built on the SCPI standard.
- TSP: A scripting programming language that contains instrument-specific control commands that can be executed from a stand-alone instrument. You can use TSP to send individual commands or use it to combine commands into scripts.
- SCPI2000: An instrument-specific language that allows you to run code developed for Keithley Instruments Series 2000 instruments.
- SCPI34401: An instrument-specific language that allows you to run code developed for Keysight Model 34401 instruments.

If you change the command set, reboot the instrument.

You cannot combine the command sets.

---

## NOTE

As delivered from Keithley Instruments, the DMM6500 is set to work with the SCPI command set.

---

## NOTE

If you choose the SCPI2000 or SCPI34401 command set, you will not have access to some of the extended ranges and other features that are now available using the default SCPI command set. In addition, some Series 2000 or Keysight 34401 code will work differently in the DMM6500 than it did in the earlier instrument. For information about the differences between the DMM6500 and the Series 2000, refer to *DMM6500 in a Model 2000 Application*, Keithley Instruments document number 0771466XX. For information about the differences between the DMM6500 and the Keysight 34401, refer to *DMM6500 in a Keysight Model 34401 Application*, Keithley Instruments document number 0771467XX.

---

### ***To set the command set from the front panel:***

1. Press the **MENU** key.
2. Under System, select **Settings**.
3. Select the appropriate **Command Set**.

You are prompted to confirm the change to the command set and reboot.

### ***To verify which command set is selected from a remote interface:***

Send the command:

```
*LANG?
```

### ***To change to the SCPI command set from a remote interface:***

Send the command:

```
*LANG SCPI
```

Reboot the instrument.

### ***To change to the TSP command set from a remote interface:***

Send the command:

```
*LANG TSP
```

Reboot the instrument.

## How do I save the present state of the instrument?

You can save the settings in the instrument as a script using the front-panel menus or from a remote interface. After they are saved, you can recall the script or copy it to a USB flash drive.

### ***From the front panel:***

1. Configure the DMM6500 to the settings that you want to save.
2. Press the **MENU** key.
3. Under Scripts, select **Save Setup**.
4. Select **Create**. A keyboard is displayed.
5. Use the keyboard to enter the name of the script.
6. Select the **OK** button on the displayed keyboard. The script is added to internal memory.

### ***Using SCPI commands:***

Configure the instrument to the settings that you want to save. To save the setup, send the command:

```
*SAV <n>
```

Where <n> is an integer from 0 to 4.

---

## NOTE

In the front-panel script menus, the setups saved with the \*SAV command have the name Setup0x, where x is the value you set for <n>.

---

### ***Using TSP commands:***

Configure the instrument to the settings that you want to save. To save the setup, send the command:

```
createconfigscript("setupName")
```

Where *setupName* is the name of the setup script that is created.

## How do I save what is displayed on the screen?

You can save a screen capture of the front-panel display to a graphic file on a USB flash drive. The instrument saves the graphic file in PNG file format.

***To save a screen capture:***

1. Insert a USB flash drive into the USB port on the front panel of the instrument.
2. Navigate to the screen you want to capture.
3. Press the **HOME** and **ENTER** keys. The instrument displays "Saving screen capture."
4. Release the keys.

## What is the ethernet port number?

The port number is 5025.

### In this section:

[Additional DMM6500 information](#) ..... 11-1

## Additional DMM6500 information

This manual has prepared you to start using your new DMM6500 6½ Digit Multimeter for your application. For more detailed information, refer to the Keithley Instruments *Model DMM6500 Reference Manual*.

Also see [tek.com/keithley](http://tek.com/keithley) for support and additional information about the instrument. From the website, you can access:

- The Knowledge Center, which contains the following handbooks:
  - *The Low Level Measurements Handbook: Precision DC Current, Voltage, and Resistance Measurements*
  - *Switching Handbook: A Guide to Signal Switching in Automated Test Systems*
- Application notes
- Updated drivers
- Information about related products

Your local Field Applications Engineer can help you with product selection, configuration, and usage. Check the website for contact information.

Specifications are subject to change without notice.  
All Keithley trademarks and trade names are the property of Keithley Instruments.  
All other trademarks and trade names are the property of their respective companies.

Keithley Instruments  
Corporate Headquarters • 28775 Aurora Road • Cleveland, Ohio 44139 • 440-248-0400 • Fax: 440-248-6168 • 1-800-935-5595 • [tek.com/keithley](http://tek.com/keithley)

---

