

2260B Series

Multi-Range Programmable DC Power Supplies

User Manual

077-1046-01/ August 2015

A Greater Measure of Confidence



ADDENDUM

Please replace the “Set up” section on page 40 through page 41 of the 2260B user manual with the following replacement:

Set Up

Line Voltage Connection – 1080W Models

Background The 1080W (2260B-30-108/80-40/ 250-13/800-4) models use a universal power input that can be used with 100 and 200 VAC systems. To connect or replace the power cord, use the procedure below:



The following procedure should only be attempted by competent persons.

Ensure the AC power cord is not connected to power.

Removal 1. Turn off the power switch.

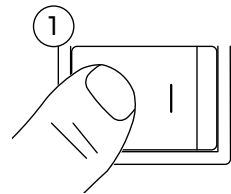

2. Unscrew the power cord strain relief.

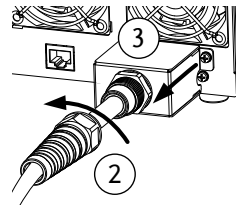

3. Remove the 2 screws holding the power cord cover and remove.

4. Slide the cover off the AC terminals.

5. Remove the AC power cord wires.

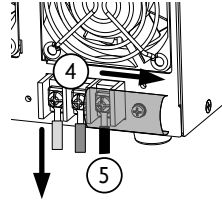

Installation

1. Thread the power cord through the strain relief and through the power cord cover.

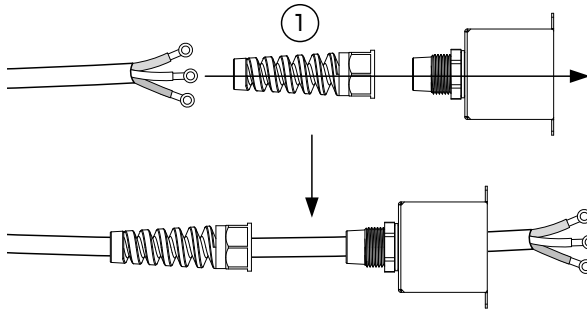

2. Connect the AC power cord wires to the AC input terminals.

- White/Blue /Black(India)
→ Neutral (N)
- Green/Green-yellow
→ GND (\perp)
- Black/Brown/Red(India)
→ Line (L)

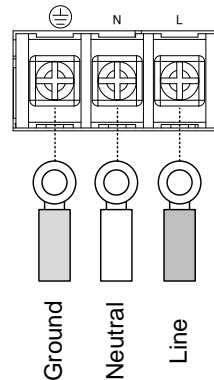

3. Set the cover over the AC terminals.

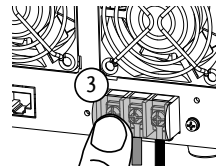

4. Screw the power cord cover onto the rear panel using the supplied screws.

5. Screw the strain relief onto the power cord cover.

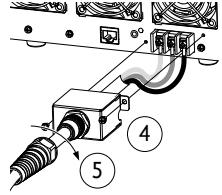

Series 2260B

Multi-Range Programmable DC Power Supplies

USER MANUAL



ISO-9001 CERTIFIED MANUFACTURER

This manual contains proprietary information, which is protected by copyright. All rights are reserved. No part of this manual may be photocopied, reproduced or translated to another language without prior written consent.

The information in this manual was correct at the time of printing. However, we continue to improve products and reserves the rights to change specification, equipment, and maintenance procedures at any time without notice.

Table of Contents

SAFETY INSTRUCTIONS	5
GETTING STARTED.....	9
2260B Series Overview.....	11
Appearance.....	18
Theory of Operation.....	25
OPERATION	38
Set Up	40
Basic Operation	60
Parallel / Series Operation.....	75
Test Sequence.....	90
CONFIGURATION.....	102
Configuration.....	103
ANALOG CONTROL.....	122
Analog Remote Control Overview.....	123
Remote Monitoring.....	139
COMMUNICATION INTERFACE	144
Interface Configuration	145
FIRMWARE UPGRADE PROCEDURE	158
Firmware Update	159
Check the Firmware Version.....	162
Kernel Update.....	164
Check the Kernel Version	167
MAINTENANCE	169

FAQ..... 171

APPENDIX..... 173

 2260B Default Settings 173

 Error Messages & Messages 176

 LED Display Format 176

 2260B Specifications..... 177

 2260B Dimensions 194







INDEX..... 201

SAFETY INSTRUCTIONS

This chapter contains important safety instructions that you must follow during operation and storage. Read the following before any operation to insure your safety and to keep the instrument in the best possible condition.

Safety Symbols

These safety symbols may appear in this manual or on the instrument.

	WARNING	Warning: Identifies conditions or practices that could result in injury or loss of life.
	CAUTION	Caution: Identifies conditions or practices that could result in damage to the instrument or to other properties.
		DANGER High Voltage
		Attention Refer to the Manual
		Protective Conductor Terminal
		Earth (ground) Terminal



Do not dispose electronic equipment as unsorted municipal waste. Please use a separate collection facility or contact the supplier from which this instrument was purchased.

Safety Guidelines

General Guideline



CAUTION

- Do not place any heavy object on the instrument.
- Avoid severe impact or rough handling that leads to damaging the instrument.
- Do not discharge static electricity to the instrument.
- Use only mating connectors, not bare wires, for the terminals.
- Do not block the cooling fan opening.
- Do not disassemble the instrument unless you are qualified.

(Measurement categories) EN 61010-1:2010 and EN 61010-2-030 specify the measurement categories and their requirements as follows. The 2260B falls under category II.

- Measurement category IV is for measurement performed at the source of low-voltage installation.
- Measurement category III is for measurement performed in the building installation.
- Measurement category II is for measurement performed on the circuits directly connected to the low voltage installation.
- 0 is for measurements performed on circuits not directly connected to Mains.

Power Supply



WARNING

- To avoid electrical shock connect the protective grounding conductor of the AC power cord to an earth ground.
-

- Cleaning the Instrument
- Disconnect the power cord before cleaning.
 - Use a soft cloth dampened in a solution of mild detergent and water. Do not spray any liquid.
 - Do not use chemicals containing harsh material such as benzene, toluene, xylene, and acetone.
-

- Operation Environment
- Location: Indoor, no direct sunlight, dust free, almost non-conductive pollution (Note below)
 - Relative Humidity: 20%~ 85%
 - Altitude: < 2000m
 - Temperature: 0°C to 50°C
- (Pollution Degree) EN 61010-1:2010 and EN 61010-2-030 specify the pollution degrees and their requirements as follows. The Instrument falls under degree 2.
- Pollution refers to “addition of foreign matter, solid, liquid, or gaseous (ionized gases), that may produce a reduction of dielectric strength or surface resistivity”.
- Pollution degree 1: No pollution or only dry, non-conductive pollution occurs. The pollution has no influence.
 - Pollution degree 2: Normally only non-conductive pollution occurs. Occasionally, however, a temporary conductivity caused by condensation must be expected.
 - Pollution degree 3: Conductive pollution occurs, or dry, non-conductive pollution occurs which becomes conductive due to condensation which is expected. In such conditions, equipment is normally protected against exposure to direct sunlight, precipitation, and full wind pressure, but neither temperature nor humidity is controlled.
-

- Storage environment
- Location: Indoor
 - Temperature: -25°C to 70°C
 - Relative Humidity: <90%
-

Disposal



Do not dispose this instrument as unsorted municipal waste. Please use a separate collection facility or contact the supplier from which this instrument was purchased. Please make sure discarded electrical waste is properly recycled to reduce environmental impact.

Power cord for the United Kingdom

When using the power supply in the United Kingdom, make sure the power cord meets the following safety instructions.

NOTE: This lead/appliance must only be wired by competent persons

 **WARNING: THIS APPLIANCE MUST BE EARTHED**

IMPORTANT: The wires in this lead are coloured in accordance with the following code:

Green/ Yellow:	Earth
Blue:	Neutral
Brown:	Live (Phase)



As the colours of the wires in main leads may not correspond with the coloured marking identified in your plug/appliance, proceed as follows:

The wire which is coloured Green & Yellow must be connected to the Earth terminal marked with either the letter E, the earth symbol  or coloured Green/Green & Yellow.

The wire which is coloured Blue must be connected to the terminal which is marked with the letter N or coloured Blue or Black.

The wire which is coloured Brown must be connected to the terminal marked with the letter L or P or coloured Brown or Red.

If in doubt, consult the instructions provided with the equipment or contact the supplier.

This cable/appliance should be protected by a suitably rated and approved HBC mains fuse: refer to the rating information on the equipment and/or user instructions for details. As a guide, a cable of 0.75mm² should be protected by a 3A or 5A fuse. Larger conductors would normally require 13A types, depending on the connection method used.

Any exposed wiring from a cable, plug or connection that is engaged in a live socket is extremely hazardous. If a cable or plug is deemed hazardous, turn off the mains power and remove the cable, any fuses and fuse assemblies. All hazardous wiring must be immediately destroyed and replaced in accordance to the above standard.

GETTING STARTED

This chapter describes the power supply in a nutshell, including its main features and front / rear panel introduction. After going through the overview, please read the theory of operation to become familiar with the operating modes, protection modes and other safety considerations.



2260B Series Overview	11
Series lineup	11
Main Features	12
Accessories.....	13
2260B-30/80 Accessories	13
2260B-250/800 Accessories	15
Package Contents.....	17
Appearance	18
2260B Front Panel.....	18
Rear Panel.....	21
Theory of Operation	25
Operating Area Description	25
CC and CV Mode	28
Slew Rate.....	30
Bleeder Control.....	30
Internal Resistance.....	31
Alarms.....	32

Considerations 33
Grounding 36

2260B Series Overview

Series lineup

The 2260B series consists of 12 models, divided into 3 different model types covering 3 power capacities: 360W models, 720W models and 1080W models.



Note

Throughout the user manual, 2260B-30, 2260B-80, 2260B-250 or 2260B-800 will refer to any of the 2260B models with a maximum voltage rating of 30V, 80V, 250V or 800V, respectively.

Model name	Type	Voltage Rating	Current Rating	Power
2260B-30-36	360W models	0~30V	0~36A	360W
2260B-80-13	360W models	0~80V	0~13.5A	360W
2260B-250-4	360W models	0~250V	0~4.5A	360W
2260B-800-1	360W models	0~800V	0~1.44A	360W
2260B-30-72	720W models	0~30V	0~72A	720W
2260B-80-27	720W models	0~80V	0~27A	720W
2260B-250-9	720W models	0~250V	0~9A	720W
2260B-800-2	720W models	0~800V	0~2.88A	720W
2260B-30-108	1080W models	0~30V	0~108A	1080W
2260B-80-40	1080W models	0~80V	0~40.5A	1080W
2260B-250-13	1080W models	0~250V	0~13.5A	1080W
2260B-800-4	1080W models	0~800V	0~4.32A	1080W

Apart from the differences in output, each unit differs in size. The 720W and 1080W models are larger than the 360W models to accommodate the increase in power.

360 W models



720 W models



1080 W models



Main Features

Performance

- High performance/power
 - Power efficient switching type power supply
 - Low impact on load devices
 - Fast transient recovery time of 1ms
 - Fast output response time
-

Features

- OVP, OCP and OTP protection
 - Adjustable voltage and current slew rates
 - User adjustable bleeder control to quickly dissipate the power after shutdown to safe levels.
 - Extensive remote monitoring and control options
 - Support for series* and parallel connections.
*(30, 80 volt models only)
 - Power on configuration settings.
 - Web server monitoring and control
-



- Interface
- Ethernet port
 - Analog connector for analog voltage and current monitoring
 - USB host and device port

Accessories

Please check the contents before using the 2260B.

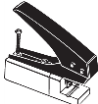

2260B-30/80 Accessories

Standard Accessories	Part number	Description
	196353000	Test Leads x1 (10AWG, Max. 45A, Max.600V)
	174627900	USB Cable
	020312300	Basic Accessories Kit:(360W, 720W) M4 terminal screws and washers x2, M8 terminal bolts, nuts and washers x2, Air filter x1, Analog control protection dummy x1, Analog control lock lever x1, Output terminal cover (top & bottom)
	060316400	Basic Accessories Kit:(1080W) M4 terminal screws and washers x2, M8 terminal bolts, nuts and washers x2, Air filter x1, Analog control protection dummy x1, Analog control lock lever x1, Output terminal cover (top & bottom), Strain relief.
	063453401	CD-R 2260B Manuals & Drivers
	071305502	Quick Start Guide
	PWRKI A*_	Power cord
	071305700	China RoHS Declaration
	001163200	Calibration of Traceable Certificate

001163300 Packing Check List		
Optional Accessories	Part number	Description
	2260-001	Accessory Kit: Pin contact x10, Socket x1, Protection cover x1
	2260-002	Simple IDC Tool 
	2260-003	Contact Removal Tool 
	2260-004	Basic Accessory Kit: M4 terminal screws and washers x2, M8 terminal bolts, nuts and washers x2, Air filter x1, Analog control protection dummy x1, Analog control lock lever x1, Output terminal cover (top & bottom), Strain relief
	2260-005	Cable for 2 units in Series connection.
	2260-006	Cable for 2 units in Parallel connection.
	2260-007	Cable for 3 units in Parallel connection.
	2260-008	Test Lead Set with Lugs
	2260B-EXTERM	Extended terminal
	2260B-RMK-JIS	Rack mount adapter (JIS)
	2260B-RMK-EIA	Rack mount adapter (EIA)
	2260B-GPIB-USB	GPIB to USB adapter
Download	Name	Description
	keithley_2260B.inf	USB driver

2260B-250/800 Accessories

Standard Accessories	Part number	Description
	196353900	Test Leads x1 (20AWG, Max. 9A, Max. 3kV)
	174627900	USB Cable
	020315700	Basic Accessories Kit: (360W, 720W) Air filter x1, Analog control protection dummy x1, Analog control lock lever x1, Output terminal cover (top & bottom), High voltage output terminal
	060316500	Basic Accessories Kit: (1080W) Air filter x1, Analog control protection dummy x1, Analog control lock lever x1, Output terminal cover (top & bottom), High voltage output terminal, Strain relief
	063453401	CD-R 2260B Manuals & Drivers
	071305502	Quick Start Guide
	PWRKI A*_	Power cord
	071305700	China RoHS Declaration
	001163200	Calibration of Traceable Certificate
	001163300	Packing Check List

Optional Accessories	Part number	Description
	2260-001	Accessory Kit: Pin contact x10, Socket x1, Protection cover x1
	2260-002	Simple IDC Tool 
	2260-003	Contact Removal Tool 
	2260-005	Cable for 2 units in Series connection.
	2260-006	Parallel operation cable for 2 units.
	2260-007	Parallel operation cable for 3 units.
	2260-009	Test Leads (for High Voltage)
	2260-010	Basic Accessories Kit: Air filter x1, Analog control protection dummy x1, Analog control lock lever x1, Output terminal cover (top & bottom), High voltage output terminal, Strain relief
	2260B-EXTERM-HV	Extended terminal (For 250V/800V HV models)
	2260B-RMK-JIS	Rack mount adapter (JIS)
	2260B-RMK-EIA	Rack mount adapter (EIA)
	2260B-GPIB-USB	GPIB to USB adapter
Download	Name	Description
	keithley_2260B.inf	USB driver

Package Contents

Check the contents before using the 2260B.

Opening the box

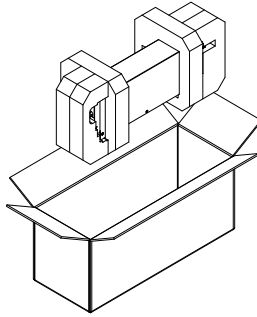

Contents
(single unit)

- Main unit
- Test leads x1
- USB cable
- Basic Accessories Kit
- CD-R Manual
- Quick Start Guide
- Power cord x1
- China RoHS Declaration
- Calibration of Traceable Certificate
- Packing Check List

Appearance

2260B Front Panel

2260B-30-72, 80-27, 250-9, 800-2 (720W)

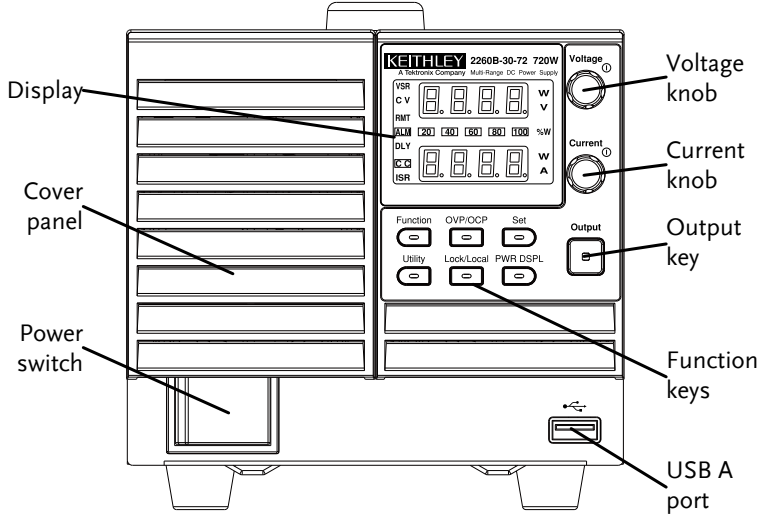

2260B-30-108, 80-40, 250-13, 800-4 (1080W)

2260B-30-36, 80-13, 250-4, 800-1 (360W)

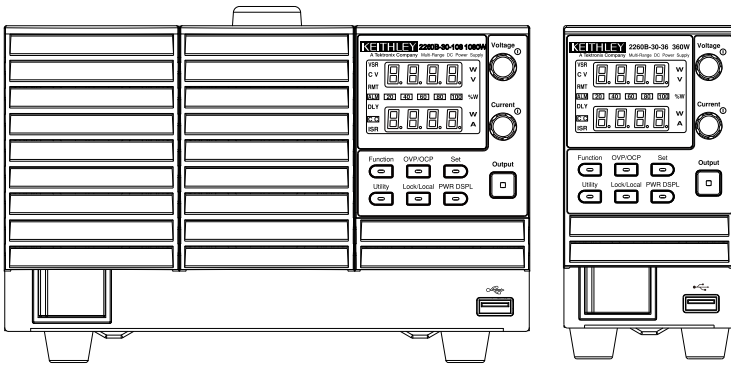

Function Keys The Function keys along with the Output key will light up when a key is active.

Function



The Function key is used to configure the power supply.

OVP/OCPP



Set the overcurrent or overvoltage protection levels.

Set



Sets the current and voltage limits.

Utility



Used to run customized Test sequence for testing.

Lock/Local



Locks or unlocks the panel keys to prevent accidentally changing panel settings.

PWR DSPL



Toggles the display from viewing V/A → V/W or A/W*.

*Press the Voltage knob for V/W, press the Current knob for A/W.

Display Indicators

VSR

Voltage Slew Rate

C V

Constant Voltage Mode

RMT

Remote Control Mode

ALM

Alarm on

DLY

Delay Output

C C

Constant Current Mode

ISR

Current Slew Rate

20 **40** **60**

Power bar

80 **100** % W

Indicates the current power output as a percentage.

Voltage Knob

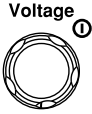

Sets the voltage.

Current Knob

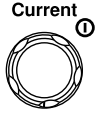

Sets the current.

Output



Press to turn on the output. The Output key will light up when the output is active.

USB

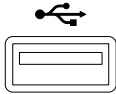

The USB A port is used to update the firmware. The firmware can only be updated at a service center.

Power Switch

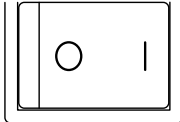

Used to turn the power on/off.

Rear Panel

2260B-30-72, 80-27 (720W)

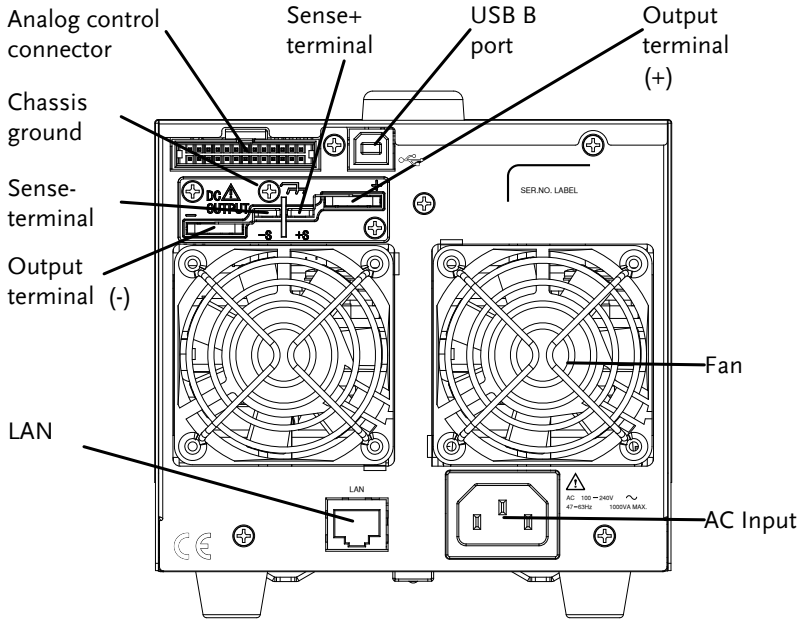

2260B-30-108, 80-40 (1080W)

2260B-30-36, 80-13 (360W)

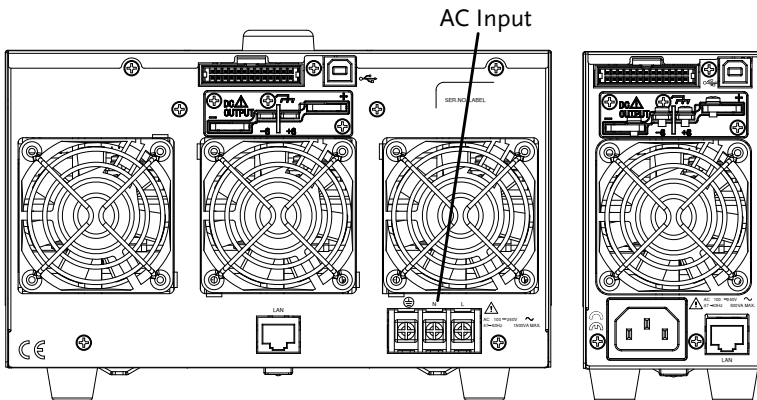

2260B-250-9, 800-2 (720W)

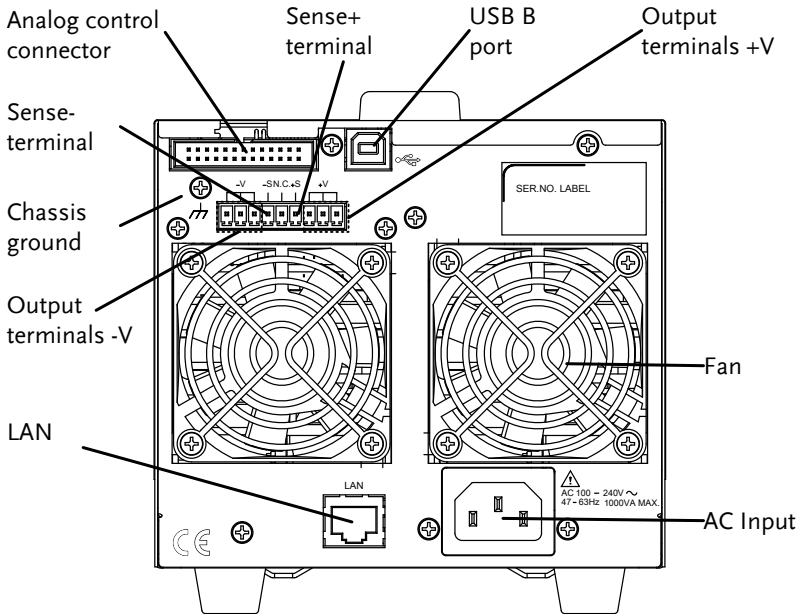

2260B-250-13, 800-4 (1080W)

2260B-250-4, 800-1 (360W)

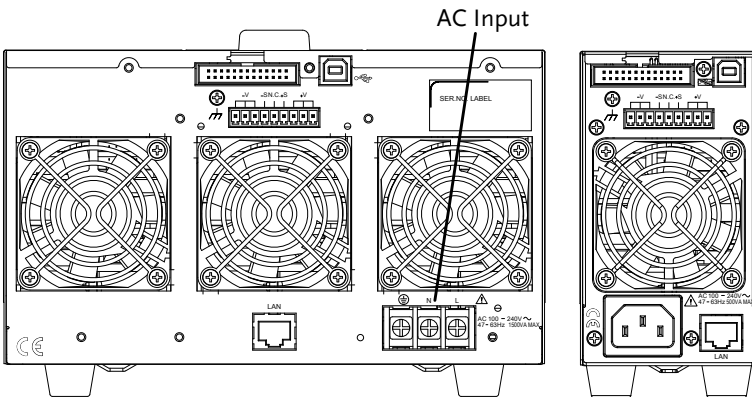

Analog Control Connector



Standard 26 pin MIL connector (OMRON XG4 IDC plug).

The analog control connector is used to monitor current and voltage output, machine status (OVP, OCP, OTP etc.), and for analog control of the current and voltage output.

Use an OMRON XG5 IDC socket as the mating socket.

Output Terminals (30, 80 volt models)

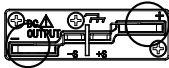

Positive (+) and negative (-) output terminals.

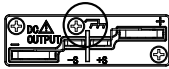

Chassis ground

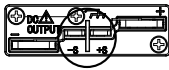

Sense (-S) and Sense (+S) terminals.

Output Terminals (250, 800 volt models)

The 250 and 800 volt models use a 9 pin connector and a plug for the output and sense terminal connections. The plug is a MC420-38109Z plug by DECA SwitchLab Inc. This plug is also available separately.

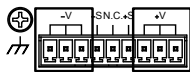

Positive (V+) and negative (V-) output terminals (3 of each).

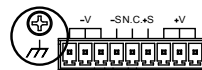

Chassis ground



Sense (-S) and Sense (+S) terminals.

USB B port

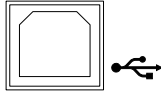

The USB B port is used for remote control.

Fans



Temperature controlled fans

Ethernet Port

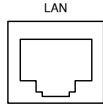

The Ethernet port is used for remote control and digital monitoring from a PC.

Line Voltage Input

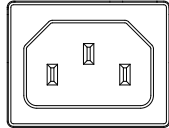

360W models:
2260B-30-36/80-13/250-4/ 800-1
720W models:
2260B-30-72/80-27/250-9/ 800-2

- Voltage Input: 100~240 VAC
- Line frequency: 50Hz/60 Hz (Automatically switchable)
- AC Input voltage range: 85VAC~265VAC
- Frequency: 47Hz~63Hz

Line Voltage Input

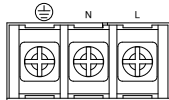

1080W models:
2260B-30-108/80-40/250-13/800-4

- Voltage Input: 100~240 VAC
- Line frequency: 50Hz/60 Hz (Automatically switchable)

Theory of Operation

The theory of operation chapter describes the basic principles of operation, protection modes and important considerations that must be taken into account before use.

Operating Area Description

Background

The 2260B power supplies are regulated DC power supplies with a high voltage and current output. These operate in CC (Constant current) or CV (Constant voltage) mode within a wide operating range limited only by the output power.

The operating area of each power supply is determined by the rated output power as well as the voltage and current rating. For example the operating area and rated power output for the 2260B- 30-36 is shown below.

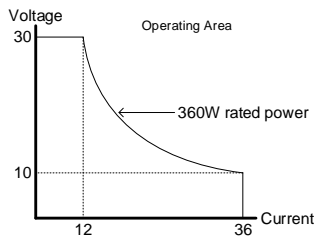

When the power supply is configured so that the total output (current x voltage output) is less than the rated power output, the power supply functions as a typical constant current, constant voltage power supply.

If however, the power supply is configured such that the total output (current x voltage

output) exceeds the rated power output, the effective output is actually limited to the power limit of the unit. In this case the output current and voltage then depend purely on the load value.

Below is a comparison of the operating areas of each power supply.

2260B 800V Series Operating Area

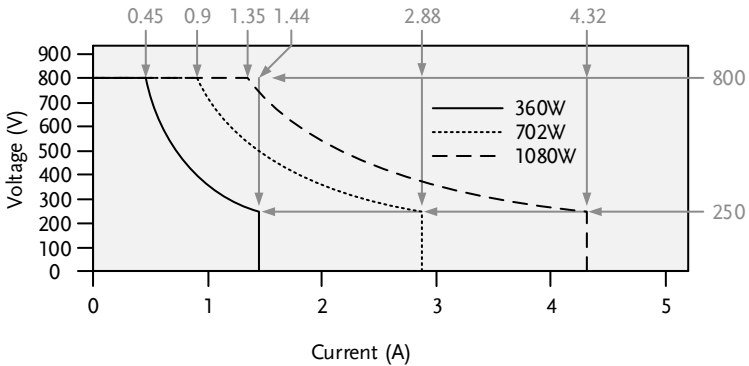

2260B 250V Series Operating Area

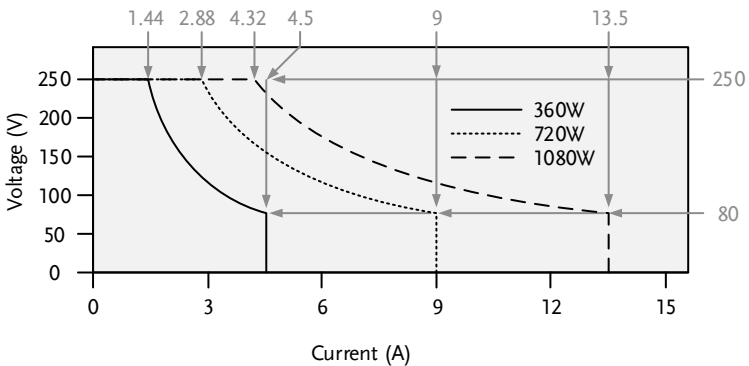

2260B 80V Series Operating Area

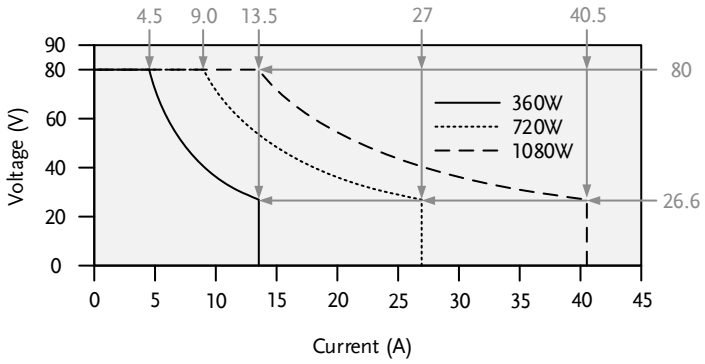

2260B 30V Series Operating Area

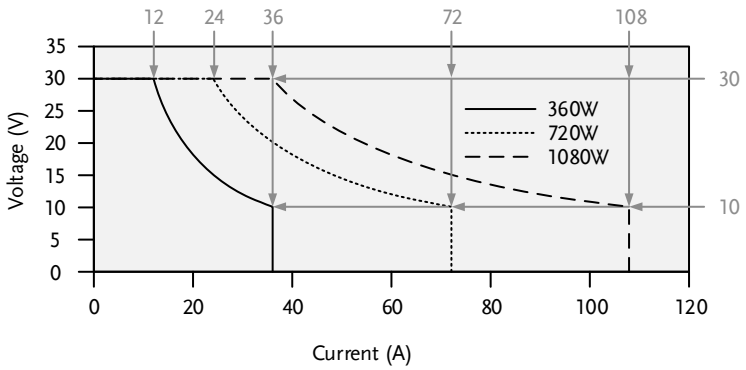

CC and CV Mode

CC and CV mode Description When the power supply is operating in constant current mode (CC) a constant current will be supplied to the load. When in constant current mode the voltage output can vary, while the current remains constant. When the load resistance increases to the point where the current limit (I_{SET}) can no longer be sustained the power supply switches to CV mode. The point where the power supply switches modes is the crossover point.

When the power supply is operating in CV mode, a constant voltage will be supplied to the load, while the current will vary as the load varies. At the point that the load resistance is too low to maintain a constant voltage, the power supply will switch to CC mode and maintain the set current limit.

The conditions that determine whether the power supply operates in CC or CV mode depends on the set current (I_{SET}), the set voltage (V_{SET}), the load resistance (R_L) and the critical resistance (R_C). The critical resistance is determined by V_{SET}/I_{SET} . The power supply will operate in CV mode when the load resistance is greater than the critical resistance. This means that the voltage output will be equal to the V_{SET} voltage but the current will be less than I_{SET} . If the load resistance is reduced to the point that the current output reaches the I_{SET} level, the power supply switches to CC mode.

Conversely the power supply will operate in CC mode when the load resistance is less than the critical resistance. In CC mode the current output is equal to I_{SET} and the voltage output is less than V_{SET} .

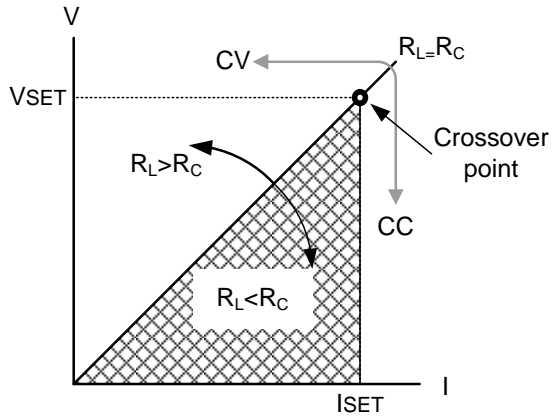

Slew Rate

Theory

The 2260B has selectable slew rates for CC and CV mode. This gives the 2260B power supply the ability to limit the current/voltage draw of the power supply. Slew rate settings are divided into High Speed Priority and Slew Rate Priority. High Speed Priority mode disables slew rate settings for CC or CV mode. Slew Rate Priority mode allows for user adjustable slew rates for CC or CV mode. The rising and falling slew rate can be set independently.

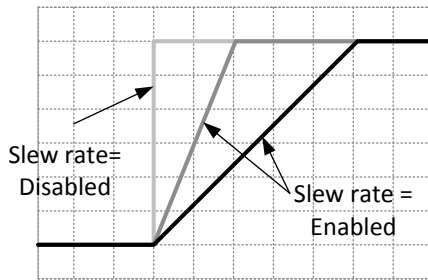

Bleeder Control

Background

The 2260B DC power supplies employ a bleed resistor in parallel with the output terminals.

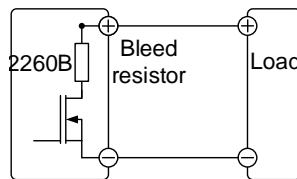

Bleed resistors are designed to dissipate the power from the power supply filter capacitors

when power is turned off and the load is disconnected. Without a bleed resistor, power may remain charged on the filter capacitors for some time and be potentially hazardous.

In addition, bleed resistors also allow for smoother voltage regulation of the power supply as the bleed resistor acts as a minimum voltage load.

The bleed resistance can be turned on or off using the configuration settings.



Note

By default the bleed resistance is on. For battery charging applications, be sure to turn the bleed resistance off as the bleed resistor can discharge the connected battery when the unit is off.

Internal Resistance

Background

On the 2260B, the internal resistance of the power supply can be user-defined in software. (Internal Resistance Setting, page 31). When the internal resistance is set it can be seen as a resistance in series with the positive output terminal. This allows the power supply to simulate power sources that have internal resistances such as lead acid batteries.

Internal Resistance Range

Unit Model	Internal Resistance Range
2260B-30-36	0.000 ~ 0.833Ω
2260B-30-72	0.000 ~ 0.417Ω
2260B-30-108	0.000 ~ 0.278Ω
2260B-80-13	0.000 ~ 5.926Ω
2260B-80-27	0.000 ~ 2.963Ω
2260B-80-40	0.000 ~ 1.975Ω
2260B-250-4	0.00 ~ 55.55Ω
2260B-250-9	0.00 ~ 27.77Ω
2260B-250-13	0.00 ~ 18.51Ω

2260B-800-1	0.0 ~ 555.5 Ω
2260B-800-2	0.0 ~ 277.8 Ω
2260B-800-4	0.0 ~ 185.1 Ω

Alarms

The 2260B power supplies have a number of protection features. When one of the protection alarms are set, the ALM icon on the display will be lit. For details on how to set the protection modes, please see page 60.

OVP	Overvoltage protection (OVP) prevents a high voltage from damaging the load.
OCP	Overcurrent protection prevents high current from damaging the load.
OTP	Overtemperature protection protects the instrument from overheating.
Power Switch Trip	When the Power Switch Trip configuration setting is enabled, the power supply will automatically shut down when a protection setting has been tripped (OCP, OVP, OTP).
Alarm output	Alarms are output via the analog control connector. The alarm output is an isolated open-collector photo coupler output.

Considerations

The following situations should be taken into consideration when using the power supply.

Inrush current When the power supply switch is first turned on, an inrush current is generated. Ensure there is enough power available for the power supply when first turned on, especially if a number of units are turned on at the same time.



Allow at least 15 seconds between cycling the power. Cycling the power on and off quickly can cause the inrush current limiting circuit to fail as well as reduce the working life of the input fuse and power switch.

Pulsed or Peaked loads When the load has current peaks or is pulsed, it is possible for the maximum current to exceed the mean current value. The 2260B power supply ammeter only indicates mean current values, which means for pulsed current loads, the actual current can exceed the indicated value. For pulsed loads, the current limit must be increased, or a power supply with a greater capacity must be chosen. As shown below, a pulsed load may exceed the current limit and the indicated current on the power supply ammeter.

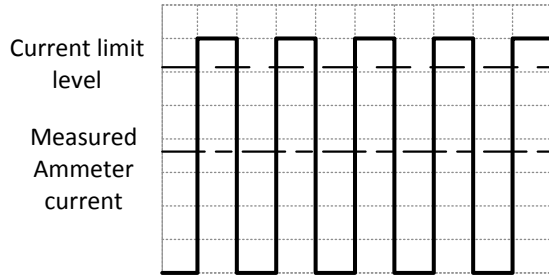

**Reverse Current:
Regenerative load**

When the power supply is connected to a regenerative load such as a transformer or inverter, reverse current will feed back to the power supply. The 2260B power supply cannot absorb reverse current. For loads that create reverse current, connect a resistor in parallel to the power supply to bypass the reverse current. This description only applies when the bleed resistance is off.

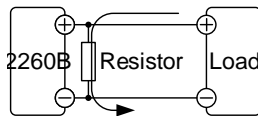

Reverse current

 **Note**

The current output will decrease by the amount of current absorbed by the resistor.

Ensure the resistor used can withstand the power capacity of the power supply/load.

Reverse Current:
Accumulative
energy.

When the power supply is connected to a load such as a battery, reverse current may flow back to the power supply. To prevent damage to the power supply, use a reverse-current-protection diode in series between the power supply and load.

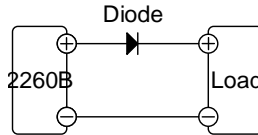

 CAUTION

Ensure the reverse withstand voltage of the diode is able to withstand 2 times the rated output voltage of the power supply and the forward current capacity can withstand 3 to 10 times the rated output current of the power supply.

Ensure the diode is able to withstand the heat generated in the following scenarios.

When the diode is used to limit reverse voltage, remote sensing cannot be used.

Grounding

The output terminals of the 2260B power supplies are isolated with respect to the protective grounding terminal. The insulation capacity of the load, the load cables and other connected devices must be taken into consideration when connected to the protective ground or when floating.

Floating

As the output terminals are floating, the load and all load cables must have an insulation capacity that is greater than the isolation voltage of the power supply.

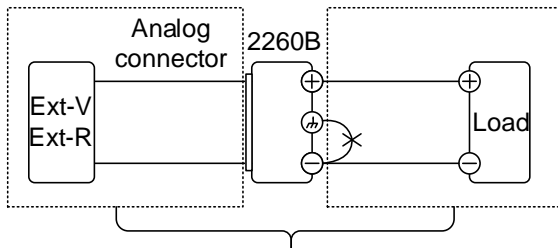

(-----) Insulation capacity \geq isolation voltage
of power supply



WARNING

If the insulation capacity of the load and load cables is not greater than the isolation voltage of the power supply, electric shock may occur.

Grounded output terminal

If the positive or negative terminal is connected to the protective ground terminal, the insulation capacity needed for the load and load cables is greatly reduced. The insulation capacity only needs to be greater than the maximum output voltage of the power supply with respect to ground.

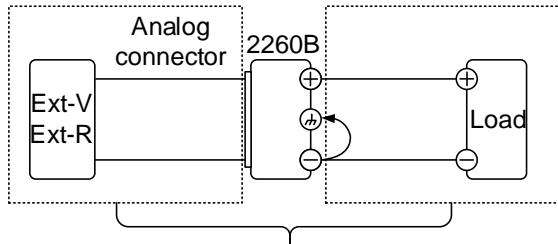

(-----) Insulation capacity \geq voltage of power supply with respect to ground

 CAUTION

If using external voltage control, do not ground the external voltage terminal as this will create a short circuit.

O PERATION

Set Up	40
Line Voltage Connection – 1080W Models.....	40
Filter Installation.....	42
Power Up.....	43
Wire Gauge Considerations.....	44
Output Terminals 2260B-30/80.....	45
Using the Output Terminal Cover 2260B-30/80.....	47
Output Terminals 2260B-250/800.....	49
Using the Output Terminal Cover 2260B-250/800.....	53
Using the Rack Mount Kit.....	54
How to Use the Instrument.....	54
Reset to Factory Default Settings.....	56
View System Version and Build Date.....	57
Basic Operation	60
Setting OVP/OCP Levels.....	60
Set to CV Mode.....	63
Set to CC Mode.....	66
Display Modes.....	69
Panel Lock.....	70
Remote Sense.....	71
Parallel / Series Operation	75
Master-Slave Parallel Overview.....	76
Master-Slave Parallel Connection.....	79
Master-Slave Parallel Operation.....	81
Master-Slave Series Overview.....	84
Master-Slave Series Connection.....	86
Master-Slave Series Operation.....	88
Test Sequence	90
Test Sequence File Format.....	91
Test Sequence Settings.....	94
Setting the Test Sequence Settings.....	95
Load Test Sequence from USB.....	96
Run Test Sequence.....	97
Export Test Sequence to USB.....	98

Remove Test Sequence.....99
Test Sequence Error Messages..... 100

Set Up

Line Voltage Connection – 1080W Models

Background The 1080W (2260B-30-108/80-40/ 250-13/800-4) models use a universal power input that can be used with 100 and 200 VAC systems. To connect or replace the power cord, use the procedure below:



The following procedure should only be attempted by competent persons.

Ensure the AC power cord is not connected to power.

Removal

1. Turn off the power switch.

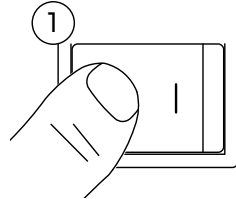

2. Unscrew the power cord protective sheath.
3. Remove the 2 screws holding the power cord cover and remove.

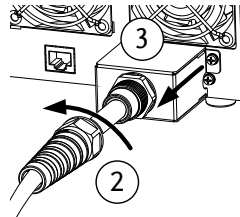

4. Slide the cover off the AC terminals.
5. Remove the AC power cord wires.

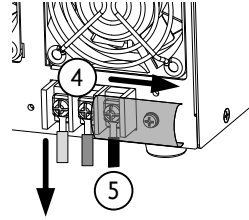

Installation

1. Connect the AC power cord wires to the AC input terminals.

- White/Blue → Neutral (N)
- Green/Green-yellow → GND (⊕)
- Black/Brown → Line (L)

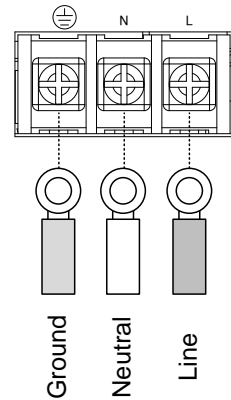

2. Set the cover back over the AC terminals.

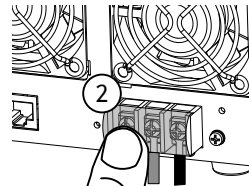

3. Re-install the power cord cover.

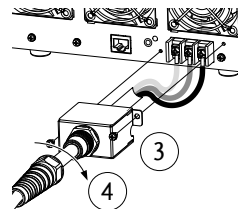

4. Screw the power cord sheath back onto the cover.

Filter Installation

Background The 2260B has a small filter that must first be inserted under the control panel before operation. The small filter must be inserted for all models types (360W/720W/1080W).

- Steps**
1. Insert the small filter in the open area under the control panel.
 2. The unit is now ready to power up.

Power Up

Steps

1. 360W or 720W models:
Connect the power cord to
the rear panel socket.

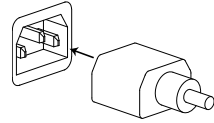

1080W models: Connect the power cord to the universal power input. Page 40

2. Press the POWER key. If used for the first time, the default settings will appear on the display, otherwise the 2260B recovers the state right before the power was last turned OFF.
For default configuration settings, see page 173.

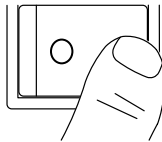

CAUTION

The power supply takes around 8 seconds to fully turn on and shutdown.

Do not turn the power on and off quickly. Please wait for the display to fully turn off.

Wire Gauge Considerations

Background

Before connecting the output terminals to a load, the wire gauge of the cables should be considered.

It is essential that the current capacity of the load cables is adequate. The rating of the cables must equal or exceed the maximum current rated output of the instrument.

Recommended wire gauge	Wire Gauge	Nominal Cross Section	Maximum Current
	20	0.5	9
	18	0.75	11
	18	1	13
	16	1.5	18
	14	2.5	24
	12	4	34
	10	6	45
	8	10	64
	6	16	88
	4	25	120
	2	32	145
	1	50	190
	0	70	240
	0	95	290
	0	120	340

The maximum temperature rise can only be 60 degrees above the ambient temperature. The ambient temperature must be less than 30 deg.

Output Terminals 2260B-30/80

Background

Before connecting the output terminals to the load, first consider whether voltage sense will be used, the gauge of the cable wiring and the withstand voltage of the cables and load.

The output terminals can be connected to load cables using M4 sized screws or M8 sized bolts.



WARNING

Dangerous voltages. Ensure that the power to the instrument is disabled before handling the power supply output terminals. Failing to do so may lead to electric shock.

Steps

1. Turn the power switch off.

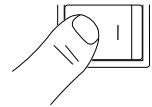

2. Remove the output terminal cover. Page 47

3. If necessary, screw the chassis ground terminal to either the positive or negative terminal. See the grounding chapter for details. Page 36

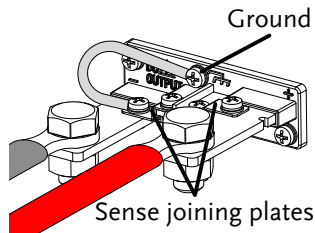

4. Choose a suitable wire gauge for the load cables. Page 44

5. Choose a suitable crimp for the terminals.
6. If using voltage sense, remove the Page 71 sense terminal joining plates and connect sensing wires to the load(s).
7. Connect the positive load cable to the positive output terminal and the negative cable to the negative output terminal.
8. Reattach the output terminal Page 47 cover.

Connection with local sense wiring

Using M4 screws

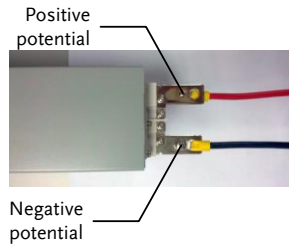

Using M8 bolts

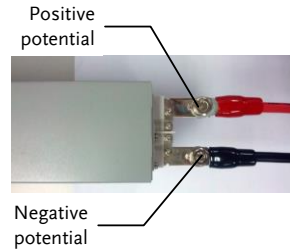

Connection with voltage sense wiring

Using M4 screws

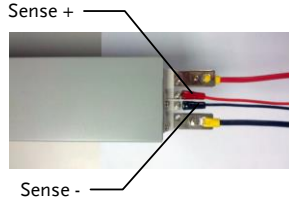

Using M8 bolts

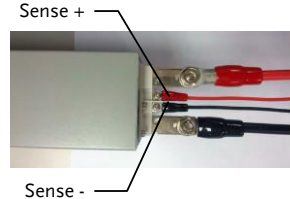

Using the Output Terminal Cover 2260B-30/80

- Steps
1. Remove the screw holding the top cover to the bottom cover.
 2. Line-up the bottom cover with the notches in the output terminals.
 3. Place the top terminal cover over the bottom cover.

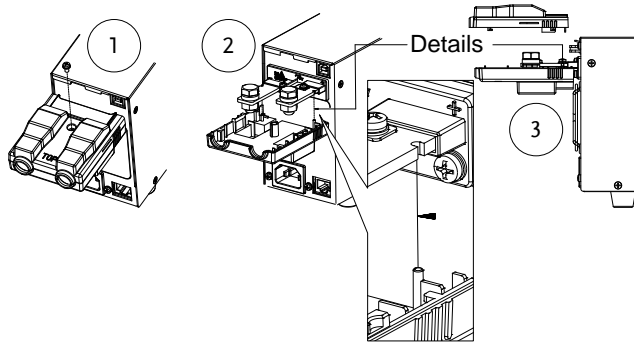

4. Use your thumb to slide the terminal covers shut, as shown in the diagram below.
5. When the top and bottom covers are flush, re-insert the screw that was removed in step 1.

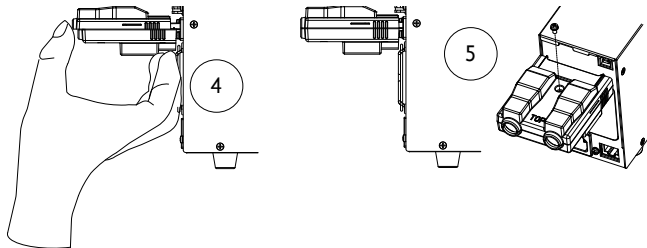

Removal Reverse the procedure to remove the terminal covers.

Output Terminals 2260B-250/800

Background The high voltage models (2260B-250 and 2260B-800 models) use a 9 pin socket for the output voltage and sense connections. The corresponding plugs should be used to connect the terminals to the appropriate cable.

Before connecting the output terminals to the load, first consider whether voltage sense will be used, the gauge of the cable wiring and the withstand voltage of the cables and load.



WARNING

Dangerous voltages. Ensure that the power to the instrument is disabled before handling the power supply output terminals. Failing to do so may lead to electric shock.

Please note the wire gauge used and the capacity of the plug/socket. It may be necessary to wire the load to a number of terminals to offset the capacity over a number of terminals.

Output Connector Overview When using the output connector make sure the wires that are used follow the following guidelines:

Wire gauge:	AWG 26 to AWG 16
Strip length	6.5mm // 0.26 in.
Current rating	10A
Insulation resistance	AC 2000V min
Insulation withstand voltage	>2000MΩ DC500V
Operation Temperature	-40°C to +105°C

Output Connector
Pinout

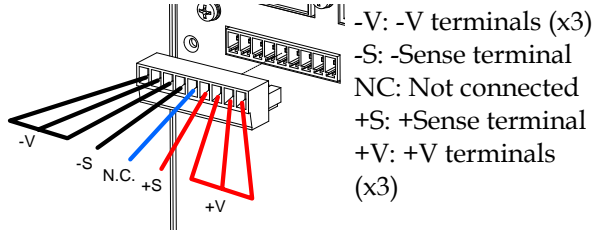

Wiring the
Connector Plug

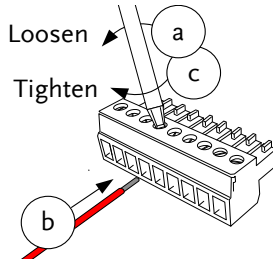

- a. Unscrew the appropriate terminal anticlockwise to release the receptacle.
- b. Insert a wire that has had at least ~7mm stripped from the insulation.
- c. Tighten the receptacle by screwing clockwise.

Steps

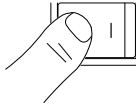
1. Turn the power switch off. 
2. Remove the output terminal cover. Page 53
3. Choose a suitable wire gauge for the load cables. Page 44
4. Strip ~7mm from one end of each load cable.
5. Connect the positive load cable to one of the +V pins and the negative cable to one of the -V pins.



WARNING

Please note the wire gauge used and the capacity of the plug/socket. It may be necessary to wire the load to a number of terminals to offset the capacity over a number of terminals.

6. If using local sense, connect the -S pin to a -V pin, and connect the +S pin to a +V pin.

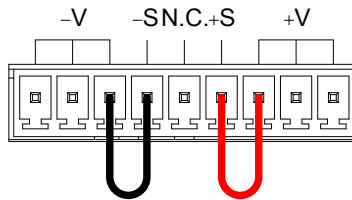

7. If not using local sense, see the remote sense section to wire the sense terminals for remote sensing. Page 71

8. If necessary, connect the chassis ground terminal to either the -V or +V pin. See the grounding chapter for details. Page 36

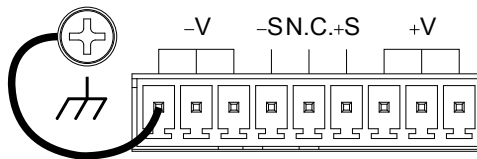

9. Reattach the output terminal cover. Page 53

Local Sense
Wiring

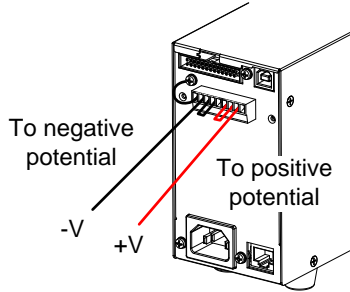

Remote Sense
Wiring

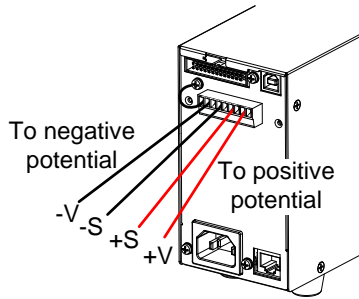

Using the Output Terminal Cover 2260B-250/800

Steps

1. Screw the bottom cover onto the rear panel using the two M4 screws.

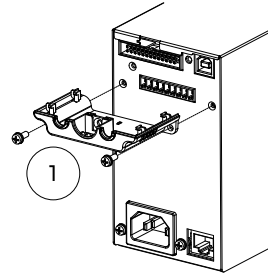

2. Slide the top cover over the bottom cover.

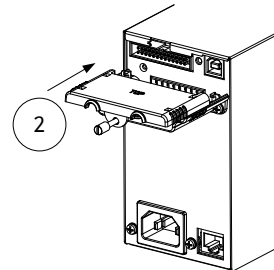

3. Finally, secure the top cover with the screw in the center of the top cover.

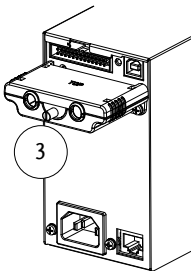

Removal

Reverse the procedure to remove the terminal covers.

Using the Rack Mount Kit

Background The 2260B series has an optional Rack Mount Kit (Part number: [JIS] 2260B-RMK-JIS , [EIA] 2260B-RMK-EIA) that can be used to hold 6x 2260B 360W models, 3x 720W models, 2x 1080W models or a combination of all models (1x 360W, 1x 720W and 1x 1080W).

Rack mount diagram

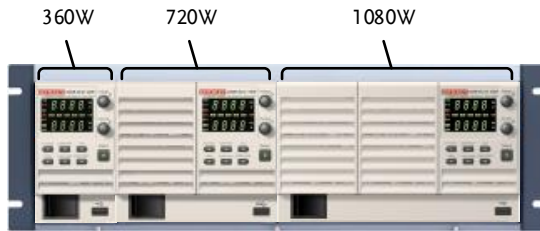

How to Use the Instrument

Background The 2260B power supplies use a novel method of configuring parameter values only using the Voltage or Current knobs. The knobs are used to quickly edit parameter values at 0.01, 0.1 or 1 unit steps at a time.

When the user manual says to set a value or parameter, use the steps below.

Example Use the Voltage knob to set a voltage of 10.05 volts.

4. Repeatedly press the Voltage knob until the last digit is highlighted. This will allow the voltage to be edited in 0.01 volt steps.

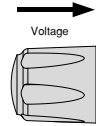

5. Turn the Voltage knob till 0.05 volts is shown.

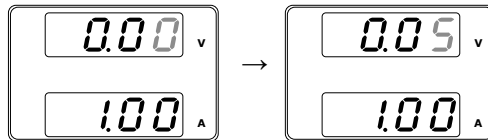
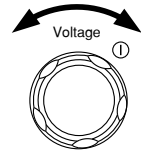

6. Repeatedly press the Voltage knob until the first digit is highlighted. This will allow the voltage to be edited in 1 volt steps.
7. Turn the Voltage knob until 10.05 is shown.

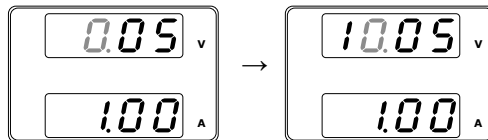





Notice the Set key becomes illuminated when setting the current or voltage.

If the Voltage or Current knobs are unresponsive, press the Set key first.

Reset to Factory Default Settings

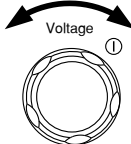
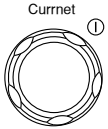
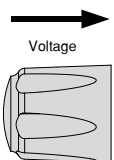
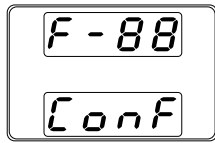
Background The F-88 configuration setting allows the 2260B to be reset back to the factory default settings. See page 173 for the default factory settings.

- | | | |
|--------------|---|---|
| Steps | <p>8. Press the Function key. The Function key will light up.</p> | <p>Function</p>  |
| | <p>9. The display should show F-01 on the top and the configuration setting for F-01 on the bottom.</p> |  |
| | <p>10. Rotate the Voltage knob to change the F setting to F-88 (Factory Set Value).</p> |  |
| | <p>11. Use the Current knob to set the F-88 setting to 1 (Return to factory settings).</p> |  |
| | <p>12. Press the Voltage knob to confirm. ConF will be displayed when successful.</p> |  |
| |  | |
| | <p>13. Press the Function key again to exit. The function key light will turn off.</p> | <p>Function</p>  |

View System Version and Build Date

Background The F-89 configuration setting allows you to view the 2260B version number, build date, keyboard version, analog-control version and kernel build.

Steps 14. Press the Function key. The Function key will light up.



15. The display should show F-01 on the top and the configuration setting for F-01 on the bottom.



16. Rotate the Voltage knob to change the F setting to F-89 (Show Version).

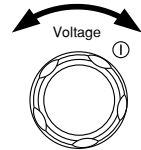

17. Rotate the Current knob to view the version and build date for the various items.

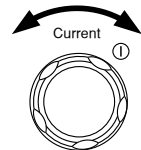

- F-89
- 0-XX: Main Program Version
 - 1-XX: Main Program Version
 - 2-XX: Main Program Build On-Year.
 - 3-XX: Main Program Build On-Year.
 - 4-XX: Main Program Build On-Month.
 - 5-XX: Main Program Build On-Day.
 - 6-XX: Keyboard CPLD version.
 - 7-XX: Keyboard CPLD version.
 - 8-XX: Analog CPLD version.
 - 9-XX: Analog CPLD version.
 - A-XX: Reserved.
 - B-XX: Reserved.
 - C-XX: Kernel Build On-Year.
 - D-XX: Kernel Build On-Year.
 - E-XX: Kernel Build On-Month.
 - F-XX: Kernel Build On-Day.

18. Press the Function key again to exit. The function key light will turn off.

Function



Example Main Program Version: Vt1.50, 2014/08-03

- 0-t1: Main Program Version
- 1-50: Main Program Version
- 2-20: Main Program Build On-Year.
- 3-14: Main Program Build On-Year.
- 4-08: Main Program Build On-Month.
- 5-03: Main Program Build On-Day.

Example Keyboard CPLD Version: 0x030c

- 6-03: Keyboard CPLD Version.
- 7-0c: Keyboard CPLD Version.

Example Analog CPLD Version: 0x0427

- 8-04: Analog CPLD Version.
 - 9-27: Analog CPLD Version.
-

Example Kernel Version: 2013/03/22

 C-20: Kernel Build On-Year.
 D-13: Kernel Build On-Year.
 E-03: Kernel Build On-Month.
 F-22: Kernel Build On-Day.

Basic Operation

This section describes the basic operations required to operate the power supply.

- Setting OVP/OCP → from page 60
- CV mode → from page 63
- CC mode → from page 66
- Display modes → page 69
- Panel lock → page 70
- Remote sensing → from page 71

Before operating the power supply, please see the Getting Started chapter, page 9.

Setting OVP/OCP Levels

Background

For most models the OVP level has a selectable range of approximately* 10% to 110% of the rated output voltage. Likewise the OCP level for most models has a selectable range of approximately* 10%~ 110% of the rated output current. The OVP and OCP level is set to the maximum by default. The OCP level can also be turned off.

*Note that the *actual* setting range differs for each model.

When one of the protection measures are on, ALM is shown on the panel display. By default, the power switch will turn off when any of the protection levels are tripped.

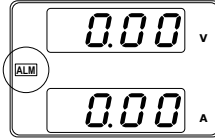

Before setting the OVP or OCP level:

- Ensure the load is not connected.
- Ensure the output is set to off.

Setting Ranges

2260B (360W)	30-36	80-13	250-4	800-1
OVP Range (V)	3-33	8-88	20-275	20-880
OCP Range (A)	3.6-39.6	1.35-14.85	0.45-4.95	0.144-1.584
2260B (720W)	30-72	80-27	250-9	800-2
OVP Range (V)	3-33	8-88	20-275	20-880
OCP Range (A)	5-79.2	2.7-29.7	0.9-9.9	0.288-3.168
2260B (1080W)	30-108	80-40	250-13	800-4
OVP Range (V)	3-33	8-88	20-275	20-880
OCP Range (A)	5-118.8	4.05-44.55	1.35-14.85	0.432-4.752

Steps

1. Press the OVP/OCP key. The OVP/OCP key lights up. 
2. The OVP setting will be displayed on the top and the OCP setting (or OFF) will be displayed on the bottom.

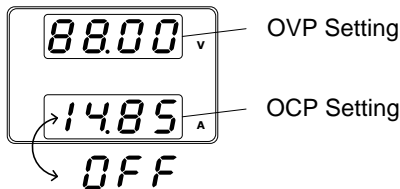

OVP Level

- Use the Voltage knob to set the OVP level.

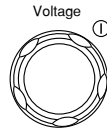

OCP Level

- Use the Current knob to set the OCP level.

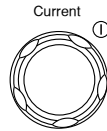

- Press OVP/OCP again to exit. The OVP/OCP indicator will turn off.



Power switch trip

Set F-95 (Power switch trip) to 1 (to disable the power switch trip) or to 0 (to enable the power switch trip) and save. Page 120

F-95 1 (Disable) or 0 (Enable)

Clear OVP/OCP protection

The OVP or OCP protection can be cleared after it has been tripped by holding the OVP/OCP button for 2 seconds.

(Only applicable when the power switch trip setting is disabled [F-95 = 1])



Set to CV Mode

When setting the power supply to constant voltage mode, a current limit must also be set to determine the crossover point. When the current exceeds the crossover point, the mode switches to CC mode. For details about CV operation, see page 25. CC and CV mode have two selectable slew rates: High Speed Priority and Slew Rate Priority. High Speed Priority will use the fastest slew rate for the instrument while Slew Rate Priority will use a user-configured slew rate.

Background Before setting the power supply to CV mode, ensure:

- The output is off.
- The load is connected.

Steps 1. Press the Function key. The Function key will light up.

Function



2. The display should show F-01 on the top and the configuration setting for F-01 on the bottom.



3. Rotate the Voltage knob to change the F setting to F-03 (V-I Mode Slew Rate Select).

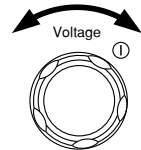

4. Use the Current knob to set the F-03 setting.

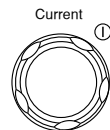

Set F-03 to 0 (CV High Speed Priority) or 2 (CV Slew Rate Priority).

F-03 0 = CV High Speed Priority
 2 = CV Slew Rate Priority

5. Press the Voltage knob to save the configuration setting. ConF will be displayed when successful.

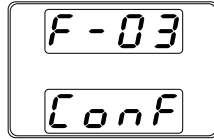
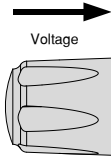

6. If CV Slew Rate Priority was chosen as the operating mode in steps 3~5, set F-04 (Rising Voltage Slew Rate) and F-05 (Falling Voltage Slew Rate) and save.

F-04 / F-05 0.1V/s~60V/s (2260B-30-XX)
 0.1V/s~160V/s (2260B-80-XX)
 0.1V/s~500.0V/s (2260B-250-XX)
 1V/s~1600V/s (2260B-800-XX)

7. Press the Function key again to exit the configuration settings. The function key light will turn off.



8. Use the Current knob to set the current limit (crossover point). Push in the knob to highlight a digit. Turn the knob to the desired digit to adjust. Rotate the knob to the desired current.

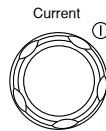

9. Use the Voltage knob to set the voltage. Push in the knob to highlight a digit. Turn the knob to the desired digit to adjust. Rotate the knob to the desired voltage.

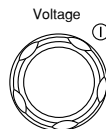

**Note**

Notice the Set key becomes illuminated when setting the current or voltage. If the Voltage or Current knobs are unresponsive, press the Set key first.

10. Press the Output key. The Output key becomes illuminated.

Output

CV and the Power Bar will become illuminated (top left & center)

**Note**

Only the voltage level can be altered when the output is on. The current level can only be changed by pressing the Set key.

For more information on the Normal Function Settings (F-00 ~ F-61, F-88~F-89) see page 108.

Set to CC Mode

When setting the power supply to constant current mode, a voltage limit must also be set to determine the crossover point. When the voltage exceeds the crossover point, the mode switches to CV mode. For details about CC operation, see page 25. CC and CV mode have two selectable slew rates: High Speed Priority and Slew Rate Priority. High Speed Priority will use the fastest slew rate for the instrument while Slew Rate Priority will use a user-configured slew rate.

Background Before setting the power supply to CC mode, ensure:

- The output is off.
- The load is connected.

Steps 1. Press the Function key. The Function key will light up.

Function



2. The display should show F-01 on the top and the configuration setting for F-01 on the bottom.



3. Rotate the Voltage knob to change the F setting to F-03 (V-I Mode Slew Rate Select).

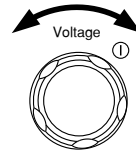

4. Use the Current knob to set the F-03 setting.

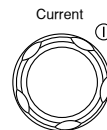

Set F-03 to 1 (CC High Speed Priority) or 3 (CC Slew Rate Priority) and save.

F-03 1 = CC High Speed Priority
 3 = CC Slew Rate Priority

5. Press the Voltage knob to save the configuration setting. ConF will be displayed when successful.

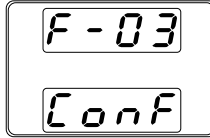
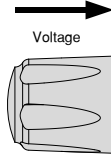

6. If CC Slew Rate Priority was chosen as the operating mode, set F-06 (Rising Current Slew Rate) and F-07 (Falling Current Slew Rate) and save.

F-06 / F-07 0.01A/s~72.00A/s (2260B-30-36)
 0.1A/s~144.0A/s (2260B-30-72)
 0.1A/s~216.0A/s (2260B-30-108)
 0.01A/s~27.00A/s (2260B-80-13)
 0.01A/s~54.00A/s (2260B-80-27)
 0.01A/s~81.00A/s (2260B-80-40)
 0.001A/s~9.000A/s (2260B-250-4)
 0.01A/s~18.00A/s (2260B-250-9)
 0.01A/s~27.00A/s (2260B-250-13)
 0.001A/s~2.880A/s (2260B-800-1)
 0.001A/s~5.760A/s (2260B-800-2)
 0.001A/s~8.640A/s (2260B-800-4)

7. Press the Function key again to exit the configuration settings. The function key light will turn off.



8. Use the Voltage knob to set the voltage limit (crossover point). Push in the knob to highlight a digit. Turn the knob to the desired digit to adjust. Rotate the knob to the desired voltage.

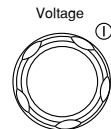

9. Use the Current knob to set the current.

Push in the knob to highlight a digit. Turn the knob to the desired digit to adjust. Rotate the knob to the desired current.

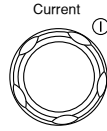

Note

Notice the Set key becomes illuminated when setting the current or voltage. If the Voltage or Current knobs are unresponsive, press the Set key first.

10. Press the Output key. The Output key becomes illuminated.

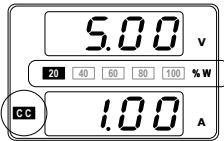

CC and the Power Bar will become illuminated (bottom left & center)



Note

Only the current level can be altered when the output is on. The voltage level can only be changed by pressing the Set key.

For more information on the Normal Function Settings (F-00 ~ F-61, F-88~F-89) see page 108.

Display Modes

The 2260B power supplies allow you to view the output in three different modes: voltage and current, voltage and power or current and power.

- Steps
11. Press the PWR/DSPL key. The PWR DSPL key lights up. 
 12. The display changes to voltage and power (V/W).
 13. To switch between displaying A/W and V/W, simply press the corresponding Voltage or Current knob.

For example: when in A/W mode, press the Voltage knob to display V/W. Conversely when in V/W mode, press the Current knob to display A/W.

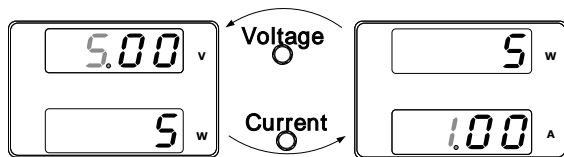



- When V/W is displayed, the Voltage knob can still be used to change the voltage level.
- When A/W is displayed, the Current knob can still be used to change the current level.

- Exit
- Press the PWR/DSPL key again to return to normal display mode. The PWR DSPL light will turn off. 

Panel Lock

The panel lock feature prevents settings from being changed accidentally. When activated, the Lock/Local key will become illuminated and all keys and knobs except the Lock/Local key and Output key (if active) will be disabled.

If the instrument is remotely controlled via the USB/LAN interface, the panel lock is automatically enabled.

Activate the panel lock	Press the Lock/Local key to activate the panel lock. The key will become illuminated.	Lock/Local 
Disable the panel lock	Hold the Lock/Local key for ~3 seconds to disable the panel lock. The Lock/Local light turns off.	Lock/Local 

Remote Sense

Remote sense is used to compensate for the voltage drop seen across load cables due to the resistance inherent in the load cables. The remote sense terminals are connected to the load terminals to determine the voltage drop across the load cables.

Remote sense can compensate up to 0.6 volts for 30V/80V models and 1V for 250V/800V models (compensation voltage). Load cables should be chosen with a voltage drop less than the compensation voltage.



WARNING

Ensure the output is off before connecting any sense cables.

Use sense cables with a voltage rating exceeding the isolation voltage of the power supply.

Never connect sensing cables when the output is on. Electric shock or damage to the power supply could result.



Note

Be sure to remove the Sense joining plates so the units are not using local sensing.

Single Load

1. Connect the Sense+ terminal to the positive potential of the load. Connect the Sense- terminal to the negative potential of the load.

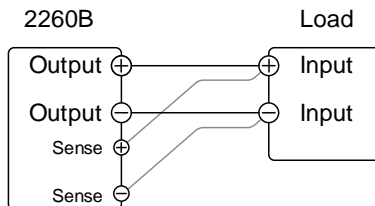

Page 45

- Operate the instrument as normal. Page 60
See the Basic Operation chapter for details.

Parallel 2260B Units

- Connect the Sense+ terminals to the positive potential of the load. Connect the Sense- terminals to the negative potential of the load.

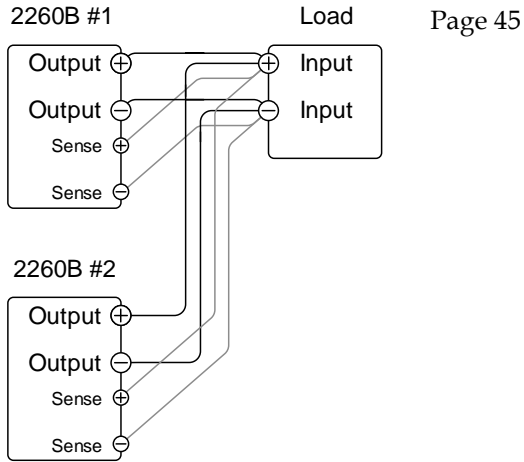

- Operate the instrument as normal. Page 76
See the Parallel Operation chapter for details.

Serial 2260B
Units

1. a. Connect the 1st Sense+ terminal to the positive potential of the load.
- b. Connect the 1st Sense- terminal to the positive output terminal of the second 2260B unit.
- c. Connect the 2nd Sense+ terminal to the positive terminal of the second 2260B unit.
- d. Connect the 2nd Sense- terminal to negative terminal of the load.

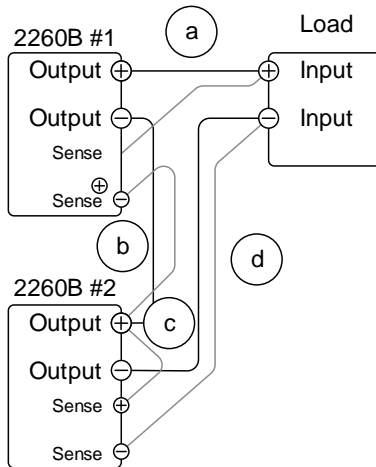

Page 45

2. Operate the instrument as normal. See the Serial Operation chapter for details. Page 84

Wire Shielding
and Load line
impedance

To help to minimize the oscillation due to the inductance and capacitance of the load cables, use an electrolytic capacitor in parallel with the load terminals.

To minimize the effect of load line impedance use twisted wire pairing.

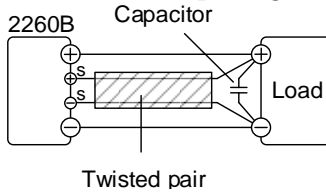

Parallel / Series Operation

This section describes the basic operations required to operate the power supply in series or parallel. Operating the 2260B power supplies in parallel increases the total power output of the power supply units. When used in series, the total output voltage of the power supplies can be increased.

The number of the power supplies that can be connected in series or parallel depends on the model and the mode:

- Series Mode: 2 units maximum; 30V and 80V models only.
Parallel Mode: 3 units maximum

**CAUTION**

250V and 800V models do not support series operation!

To use the power supplies in series or parallel, units must be used in a Master-Slave configuration. In the master-slave configuration a “master” power supply controls any other connected “slave” power supplies.

- Master-Slave Parallel overview → from page 76
- Parallel connection → from page 79
- Parallel operation → from page 81
- Master-Slave Series overview → page 84
- Series connection → page 86
- Series operation → from page 88

Before operating the power supply, please see the Getting Started chapter, page 9.

Master-Slave Parallel Overview

Background

When connecting the 2260B power supplies in parallel, up to 3 units can be used in parallel and all units must be of the same model.

When the units are used in parallel, a number of precautions and limitations apply. Please read this overview before operating the power supplies in parallel.

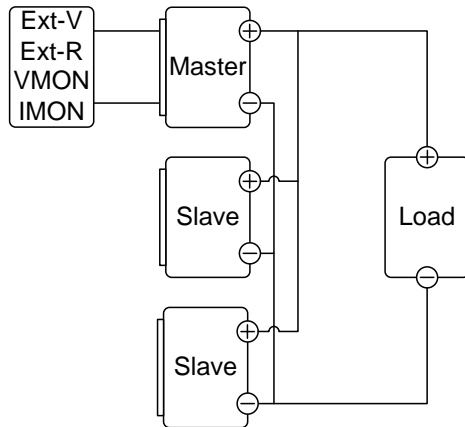

Limitations

Display

- Only the master unit will display the voltage and current.

OVP/ OCP

- The master unit can shut down slave units when OVP/OCP is tripped on the master unit (if the slave connector is wired for shut down on alarm).
- OVP/OCP can be independently tripped on each slave unit, however the shutdown of the power or output of the unit is disabled. Only the alarm will be enabled.

Remote monitoring

- Voltage monitoring (VMON) and current monitoring (IMON) are only supported on the master unit.
- The IMON current represents the total current of the all the parallelized units.

Remote Sense

- Please see the remote sense chapter for details, page 71.

External Voltage and Resistance Control

- Voltage/Resistance controlled remote control can only be used with the master unit.

Slew Rate

- Only the master unit's current or voltage slew rate settings apply.
- The *settable current* slew rate is double or triple that of a single unit, depending on the number of units that are used in parallel.

For example:

The 2260B-30-36 has a maximum settable current slew rate of 72A/S. When two 2260-30-36 units are used in parallel, the maximum settable slew rate setting is 144A/S.

Internal Resistance

- Only the master unit’s internal resistance settings apply.
- For 2 units in parallel, the internal resistance is actually half of the setting value.
- For 3 units in parallel, the internal resistance is actually a third of the setting value.

Bleeder Control

- The Master unit is used to control the bleeder settings. The bleeder resistors in all the slave units are always turned off when in parallel mode.

	Model	Single unit	2 units	3 units
Output Voltage/ Output Current	2260B-30-36	30V	30V	30V
		36A	72A	108A
	2260B-80-13	80V	80V	80V
		13.5A	27A	40.5A
	2260B-250-4	250V	250V	250V
		4.5A	9A	13.5A
	2260B-800-1	800V	800V	800V
		1.44A	2.88A	4.32A
	2260B-30-72	30V	30V	30V
		72A	144A	216A
	2260B-80-27	80V	80V	80V
		27A	54A	81A
	2260B-250-9	250V	250V	250V
		9A	18A	27A
	2260B-800-2	800V	800V	800V
		2.88A	5.76A	8.64A
	2260B-30-108	30V	30V	30V
		108A	216A	324A
	2260B-80-40	80V	80V	80V
		40.5A	81A	121.5A
	2260B-250-13	250V	250V	250V
		13.5A	27A	40.5A
	2260B-800-4	800V	800V	800V
		4.32A	8.64A	12.96A

Master-Slave Parallel Connection

Master-Slave Connector

The Analog Control Connector is used for both serial and parallel connections. The way the connector is configured determines the behavior of the master and slave units. For the complete connector pin assignment, see page 123.

Analog Connector Connection

To operate the power supplies in parallel, connect the analog connectors on the master and slave units as shown in the diagrams below.

Alternatively pre-configured cables (optional) can be used. The 2260B-006 is used for two units in parallel. The 2260B-007 is used for 3 units in parallel.

Master with 2 slave units:

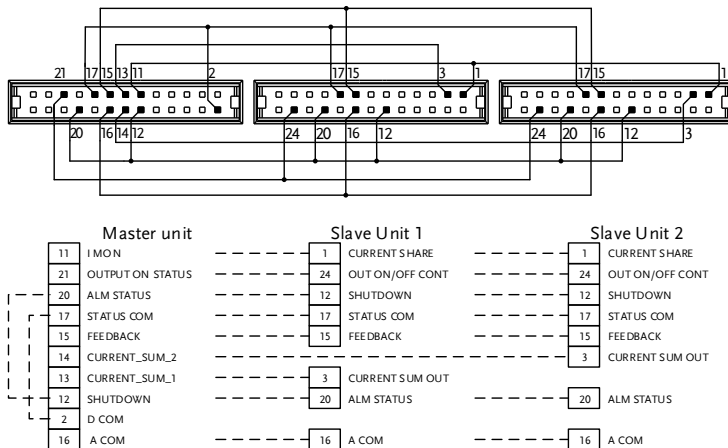

Master with 1 slave unit:

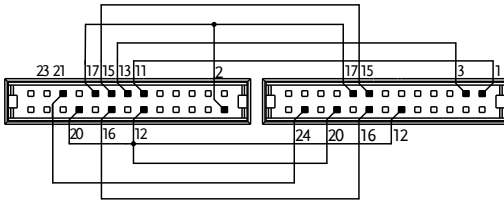

Master unit		Slave Unit 1		
11	I MON	---	1	CURRENT SHARE
21	OUTPUT ON STATUS	---	24	OUT ON/OFF CONT
20	ALM STATUS	---	12	SHUTDOWN
17	STATUS COM	---	17	STATUS COM
15	FEEDBACK	---	15	FEEDBACK
13	CURRENT_SUM_1	---	3	CURRENT SUM OUT
12	SHUTDOWN	---	20	ALM STATUS
2	D COM	---		
16	A COM	---	16	A COM

Parallel Output Connection

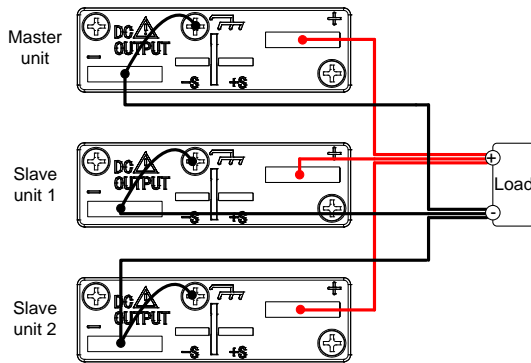

Steps

1. Ensure the power is off on all power supplies.
2. Choose a master and a slave unit(s).
3. Connect the analog connectors for the master and slave unit as shown above.
4. Remove the Output Terminal covers and the protection dummy plug from the analog control connector.

5. Connect the master and slave unit in parallel as shown above.

6. Reattach the terminal covers. Page 47



Note

Ensure the load cables have sufficient current capacity. Page 44

Re-attach the Protection dummy plug when not in use.

Master-Slave Parallel Operation

Master-Slave Configuration Before using the power supplies in parallel, the master and slave units need to be configured.

- Steps 1. Configure the OVP and OCP settings for the master unit. Page 60

2. For each unit, hold the Function key while turning the power on to enter the power on configuration settings.

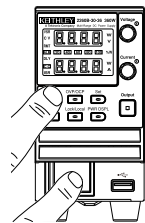

3. Configure F-93 (Master/Slave) setting for each master/slave unit. Page 120

Unit	F-93
Master (with 1 slave in parallel)	1
Master (with 2 slaves in parallel)	2
Slave unit (parallel slave)	3

4. Cycle the power on the units (reset the power).



Note

Configuration settings can be checked for both the master and slave units by pressing the Function key and checking F-93.

Only the Master OVP and OCP level is used for over voltage and current protection. Slave OVP and OCP level is disregarded.

OTP works independently for each unit.

Master-Slave
Operation

Only operate the power supplies in parallel if the units are configured correctly.

1. Turn on the master and slave units. The slave unit(s) will show a blank display.

Master unit



Slave units

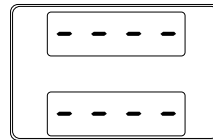

2. Operation of all units is controlled via the master unit. Operation of the master unit is the same as for a single unit. See the Basic Operation chapter.

3. Press the Output key to begin.

Output



Caution

Only operate the power supplies in parallel if using units of the same model number.

Only a maximum of 3 units can be used in parallel.



Note

The panel controls are disabled on slave units, including the output key. On slave units only the Function key can be used to view the current settings.

Master-Slave Series Overview

Background

When connecting 2260B power supplies in series, up to 2 units can be used in series and all units must be of the same model.

When the units are used in series, a number of precautions and limitations apply. Please read this overview before operating the power supplies in series.

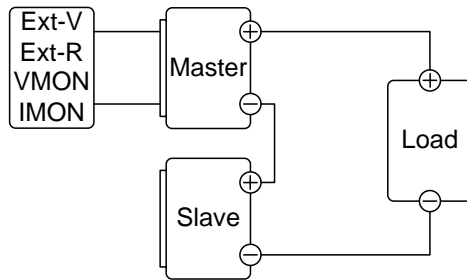

Limitations

Display

- Only the master unit will display the current.
- Master and slave units display the voltage. The total voltage is the sum of the units.

OVP/OCP

- The master unit can shut down the slave unit when OVP/OCP is tripped on the master unit (if the slave connector is wired for shut down on alarm).
- OVP and OCP level is determined by the master OVP and OCP level. The OVP and OCP level on the slave unit is ignored.

Remote monitoring

- Voltage monitoring (VMON) and current monitoring (IMON) are only supported on the master unit.
- The VMON voltage represents the total voltage of the all the serialized units.

Remote Sense

- Please see the remote sense chapter for details, page 71.

External Voltage and Resistance Control

- Voltage/Resistance controlled remote control can only be used with the master unit.

Slew Rate

- The voltage slew rate is actually double that of the setting slew rate. I.e., A voltage slew rate setting of 60.00V/s is actually 120V/s when in series.

Internal Resistance

- The internal resistance is actually twice that of the setting value.
- Only the master unit's internal resistance settings apply.

Bleeder Control

- The Master unit is used to control the bleeder settings. The bleeder resistor is always turned on for the slave unit in series mode.

	Model	Single unit	2 units
Output Voltage/ Output Current	2260B-30-36	30V	60V
		36A	36A
	2260B-80-13	80V	160V
		13.5A	13.5A
	2260B-30-72	30V	60V
		72A	72A
	2260B-80-27	80V	160V
		27A	27A
	2260B-30-108	30V	60V
		108A	108A
	2260B-80-40	80V	160V
		40.5A	40.5A

Master-Slave Series Connection

Master-Slave Connector The Analog Control Connector is used for both serial and parallel connections. The way the connector is configured determines the behavior of the master and slave units. For the connector pin assignment, see page 123.

Analog Connector Connection To operate the power supplies in series, connect the analog connectors on the master and slave unit as shown in the diagram below.

Alternatively, the optional 2260B-005 cable is pre-configured for serial use.

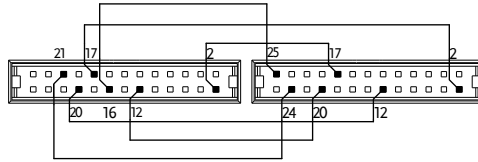

Master unit		Slave Unit 1	
16	A COM	25	SER SLV IN
21	OUTPUT ON STATUS	24	OUT OFF/ON CONT
20	ALM STATUS	12	SHUTDOWN
17	STATUS COM	2	D COM
12	SHUTDOWN	20	ALM STATUS
2	D COM	17	STATUS COM

Series Output Connection

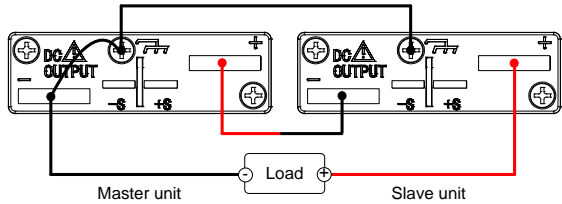

Steps

1. Ensure the power is off on both power supplies.
2. Choose a master and slave unit.
3. Connect the analog connectors for the master and slave unit as shown above.
4. Remove the output terminal cover [Page 47](#) and the protection dummy plug from the analog control connector.
5. Connect the master and slave unit in series as shown above.
6. Reattach the terminal cover. [Page 47](#)



Note

Ensure load cables have sufficient current capacity. Page 44

Re-attach the protection dummy plug when not in use.

Master-Slave Series Operation

Master-Slave Configuration

Before using the power supplies in series, the master and slave units need to be configured.

1. Configure the OVP and OCP settings for the master unit. Page 60

2. For each unit, hold the Function key while turning the power on to enter the power on configuration settings.

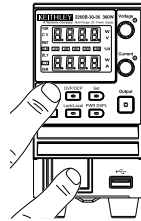

3. Configure F-93 (Master/Slave) setting for each master/slave unit. Page 120

Unit	F-93
Master (local or series operation)	0
Slave unit (series)	4

4. Cycle the power on the units (reset the power).



Note

Configuration settings can be checked for both the master and slave units by pressing the Function key.

**Master-Slave
Operation**

Only operate the power supplies in series if the units are configured correctly.

1. Turn on the master and slave unit. The slave unit will only show the voltage of its own unit. The master unit will show the combined voltage of both units and the current.

Master unit



Slave unit

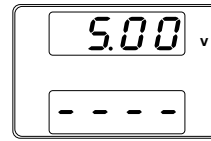

2. Operation of all units is controlled via the master unit. Operation of the master unit is the same as for a single unit. Please see the basic operation chapter for details.
3. Press the Output key to begin.

Output

 **CAUTION**

Only operate the power supplies in series if using units of the same model number. 250V and 800V models do not support series operation!

Only a maximum of 2 units can be used in series.

 **Note**

The panel controls are disabled on slave units, including the output key.

Test Sequence

This section describes how to use the Utility function to run, load and save test sequences for automated testing. The Utility function is useful if you want to perform a number of tests automatically. The 2260B utility function can store ten test sequences in memory.

- Test Sequence File Format → from page 91
- Test Sequence Settings → from page 91
- Setting the Test Sequence Settings → from page 95
- Load Test Sequence → from page 96
- Run Test Sequence → from page 97
- Run Test Sequence → from page 97
- Export Test Sequence → from page 98
- Remove Test Sequence → from page 99
- Test Sequence Error Codes → from page 100

Test Sequence File Format

A test sequence file describes a sequence of steps that are output when the test sequence is run. The test sequence file is created on a PC in a *.CSV (comma separated values) format. In a CSV file each field is delimited by a comma.

Each file should be saved as tXXX.csv, where XXX is the save file number 001~010. The save file number is important as it designates which memory slot the test file can be loaded into, see page 96.

Below is an example of a simple test file created in a spreadsheet.

	A	B	C	D
Cycle Header	1	2	3	5
Step Header	Step	Time(sec)	Voltage (V)	Current (A)
	1	1	MIN	MIN
	4	1	0.15	0.15
	5	1	0.2	0.2
Step number	6	1	0.25	0.25
	7	1	0.3	0.3
	8	1	0.35	0.35
	Time(sec)	Voltage (V)	Current (A)	

A test file contains the following fields in the following order:

Line 1:

Cycle Header: This field contains the “Cycle” header text. Required. Do not remove or alter from this location.

Cycle Repeat: Determines the number of times to repeat a sequence of steps. It has a range of 1~999 or 0 | INF. A setting of 1 will pass through the cycle once. A setting of 0 or INF (case insensitive) will repeat the cycle infinitely.

Cycle Step Start: Determines the starting step for the Cycle Repeat field. Range: 1~999. The Cycle Step Start field must be less than the Cycle Step End field.

Cycle Step End: Determines the ending step for the Cycle Repeat field. Range: 2~1000. The Cycle Step End field must be greater than the Cycle Step Start field.

Line 2:

Step Header: This field contains the "Step" header text. Required. Do not remove from this location.

Time(sec) Header: This field contains the "Time(sec)" header text. Required. Do not remove or alter from this location.

Voltage (V) Header: This field contains the "Voltage (V)" header text. Required. Do not remove or alter from this location.

Current (A) Header: This field contains the "Current (A)" header text. Required. Do not remove or alter from this location.

Line 3+:

Step Number: The Step Number field numbers each step in the test function. It has a range of 1~1000. All steps must be numbered in numerical order. No step number can be "skipped" between the first and last step.

Time(sec): Designates the duration time of the corresponding step in seconds. It has a range of 0.05 seconds to 20 days. It has a step resolution of 0.05 seconds (50ms). A setting of 0 will skip the step.

Voltage (V): Designates the voltage of the corresponding steps in volts. MIN or MAX can be used to set the voltage to minimum or maximum, respectively.

Current (A): Designates the current of the corresponding steps in amps. MIN or MAX can be used to set the current to minimum or maximum, respectively.

Example: In the example below there are 10 steps in total. As designated by the Cycle fields, steps 3~5 are repeated twice.

In total the steps will run as follows:

Step: 1>2>3>4>5>3>4>5>6>7>8>9>10

Steps 3~5 are repeated twice

File: T001.csv

Cycle	2	3	5
Step	Time(sec)	Voltage (V)	Current (A)
1	1	MIN	MIN
2	1	0.05	0.05
3	1	0.1	0.1
4	1	0.15	0.15
5	1	0.2	0.2
6	1	0.25	0.25
7	1	0.3	0.3
8	1	0.35	0.35
9	1	0.4	0.4
10	1	0.45	0.45

Test Sequence Settings

Test sequence Run	Runs the chosen test sequence from the internal memory. A test sequence must first be loaded into the internal memory before it can be run. See the Utility function "Test Sequence Load", below.
	The test sequence will run as soon as the utility function is started.
	T-01 1~10
Test sequence Load	Loads a test sequence from the USB drive to the designated save slot in memory. A test sequence must first be loaded into internal memory before it can be run.
	T-02 1~10 (USB→2260B)
Test Export	Exports a test sequence from the designated memory save slot to the USB drive.
	T-03 1~10 (2260B→USB)
Test sequence Remove	Deletes the chosen test sequence file from the 2260B internal memory.
	T-04 1~10

Exit Press the Utility key again to exit the Test sequence settings. The Utility key light will turn off.



Load Test Sequence from USB

Overview Before a test sequence can be run, it must first be loaded into a one of the 10 memory save slots. Before loading a test sequence into memory:

- Ensure the test sequence file is placed in the root directory.
- Ensure the file name number corresponds to the memory number that you wish to save to.

For example: A test sequence file named t001.csv can only be saved to memory number 01, t002.csv can only be saved to memory number 02, and so on.

Steps 1. Insert a USB flash drive into the front panel USB-A slot. Ensure the flash drive contains a test sequence file in the root directory.



2. Turn on the power. MS (Mass Storage) will be displayed on the screen after a few seconds if the USB drive is recognized.

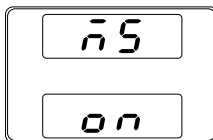



Note

If the USB drive is not recognized, check to see that the function settings for F-20 = 1 (page 113). If not, reinsert the USB flash drive.

3. Configure T-02 (Test sequence Load) to 1~10 (save memory slot) Page 95
T-02 range 1~10 (t001 ~t010)
4. The test sequence will now be available in the memory slot the test sequence was saved to.



Note

Error messages: If you load a file that is not present on the USB drive “Err 002” will be displayed on the display.



Run Test Sequence

Overview

A test sequence can be run from one of ten memory slots.

Steps

1. Before a test sequence can be run, it must first be loaded into one of the 10 memory slots. Page 96
2. Configure T-01 (Run Test sequence) to 1~10 (save memory slot) Page 95
T-01 range 1~10
3. The test sequence will automatically start to run.



Note

Error messages: If you try to run a test sequence from an empty memory location “Err 003” will be displayed on the display.

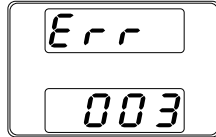

Note

When a test sequence starts to run, there is no way to abort the test sequence. Pressing the Output key has no effect. If you wish to stop a test early, turn the power off.

Export Test Sequence to USB

Overview

The Export test sequence function saves a test sequence file to the root directory of a USB flash drive.

- Test Sequence Files will be saved as tXXX.csv where XXX is the memory number 001~010 from which the test sequence was exported from.
- Test Sequence Files of the same name on the USB flash drive will be written over.

Steps

1. Insert a USB flash drive into the front panel USB-A slot.

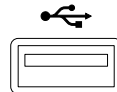

2. Turn on the power. MS (Mass Storage) will be displayed on the screen after a few seconds if the USB drive is recognized.

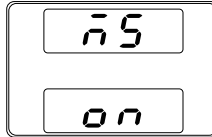

Note

If the USB drive is not recognized, check to see that the function settings for F-20 = 1 (page 113). If not, reinsert the USB flash drive.

3. Configure T-03 (Test Sequence Export) from 0~10 (internal memory slot) Page 95
 T-03 range 1~10

4. The test sequence file will now be copied to the USB flash drive.



Note

Error messages: If you try to export a test sequence from an empty memory location “Err 003” will be displayed on the display.



Remove Test Sequence

Overview

The Remove Test Sequence function will delete a test sequence from the internal memory slot.

- Steps
1. Select T-04 (Test Sequence Remove) and choose which test sequence to remove from the internal memory.
T-04 range 1~10
 2. The test sequence will be removed from the internal memory slot.



Note

Error messages: If you try to remove a test sequence from an empty memory location “Err 003” will be displayed on the display.

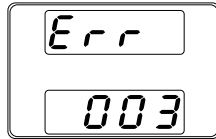

Test Sequence Error Messages

Overview

The following error code numbers may appear on the display when trying to run a test sequence. Use the error code numbers determine the cause of the error.

For example: If Error # -52 appears on the display, it indicates that one of the Time(sec) fields is over range for the test sequence.

Error #	Details
-1	_SEQ_ERR_FILE_NOT_FOUND
-2	_SEQ_ERR_FILE_IS_TOO_LARGE
-3	_SEQ_ERR_ALLOCATE_MEMORY_ERROR
-4	_SEQ_ERR_OPEN_THE_FILE_ERROR
-5	_SEQ_ERR_READ_DATA_ERROR
-6	_SEQ_ERR_USING
-7	_SEQ_ERR_FORMAT_ERROR

-8	_SEQ_ERR_PARAMETER_DATA_TO_LONG
-10	_SEQ_ERR_CYCLE_START_GREATER_THAN_CYCLE_END
-11	_SEQ_ERR_CYCLE_TIMES_ERROR
-12	_SEQ_ERR_CYCLE_TIMES_OVER_RANGE
-13	_SEQ_ERR_NO_CYCLE_TIMES
-14	_SEQ_ERR_CYCLE_START_ERROR
-15	_SEQ_ERR_CYCLE_START_OVER_RANGE
-16	_SEQ_ERR_NO_CYCLE_START
-17	_SEQ_ERR_CYCLE_END_ERROR
-18	_SEQ_ERR_CYCLE_END_OVER_RANGE
-19	_SEQ_ERR_NO_CYCLE_END
-20	_SEQ_ERR_STEP_DATA_ERROR
-21	_SEQ_ERR_STEP_DATA_OVER_RANGE
-22	_SEQ_ERR_NO_STEP_DATA
-30	_SEQ_ERR_POINT_DATA_ERROR
-31	_SEQ_ERR_START_POINT_GREATER_THAN_END_POINT
-32	_SEQ_ERR_START_POINT_REPEAT
-33	_SEQ_ERR_END_POINT_REPEAT
-40	_SEQ_ERR_OUTPUT_DATA_ERROR
-50	_SEQ_ERR_TIME_DATA_ERROR
-51	_SEQ_ERR_NEGATIVE_TIME
-52	_SEQ_ERR_TIME_OVER_RANGE
-60	_SEQ_ERR_VOLTAGE_DATA_ERROR
-61	_SEQ_ERR_NEGATIVE_VOLTAGE
-62	_SEQ_ERR_VOLTAGE_TOO_LARGE
-63	_SEQ_ERR_VOLTAGE_TOO_SMALL
-70	_SEQ_ERR_CURRENT_DATA_ERROR
-71	_SEQ_ERR_NEGATIVE_CURRENT
-72	_SEQ_ERR_CURRENT_TOO_LARGE
-73	_SEQ_ERR_CURRENT_TOO_SMALL

CONFIGURATION

Configuration.....	103
Configuration Table	103
Normal Function Settings	108
USB/GPIB Settings	113
LAN Settings	114
System Settings.....	115
Power On Configuration Settings.....	116
Calibration.....	117
Setting Normal Function Settings.....	118
Setting Power On Configuration Settings	120

Configuration

Configuration of the 2260B power supplies is divided into five different configuration settings: Normal Function, USB/GPIB, LAN, Power ON Configuration, Calibration Settings and System Settings. Power ON Configuration differs from the other settings in that the settings used with Power ON Configuration settings can only be set during power up. The other configuration settings can be changed when the unit is already on. This prevents some important configuration parameters from being changed inadvertently. Power On Configuration settings are numbered F-90 to F-95 and the other configuration settings are numbered F-00 to F-61 and F-88 to F-89.

Configuration Table

Please use the configuration settings listed below when applying the configuration settings.

Normal Function		
Settings	Setting	Setting Range
Output ON delay time	F-01	0.00s~99.99s
Output OFF delay time	F-02	0.00s~99.99s
V-I mode slew rate select	F-03	0 = CV high speed priority 1 = CC high speed priority 2 = CV slew rate priority 3 = CC slew rate priority
Rising voltage slew rate	F-04	0.01V/s~60.00V/s (2260B-30-XX) 0.1V/s~160.0V/s (2260B-80-XX) 0.1V/s~500.0V/s (2260B-250-XX) 1V/s~1600V/s (2260B-800-XX)
Falling voltage slew rate	F-05	0.01V/s~60.00V/s (2260B-30-XX) 0.1V/s~160.0V/s (2260B-80-XX) 0.1V/s~500.0V/s (2260B-250-XX) 1V/s~1600V/s (2260B-800-XX)

Rising current slew rate	F-06	0.01A/s~72.00A/s (2260B-30-36)
		0.1A/s~144.0A/s (2260B-30-72)
		0.1A/s~216.0A/s (2260B-30-108)
		0.01A/s~27.00A/s (2260B-80-13)
		0.01A/s~54.00A/s (2260B-80-27)
		0.01A/s~81.00A/s (2260B-80-40)
		0.001A/s~9.000A/s (2260B-250-4)
		0.01A/s~18.00A/s (2260B-250-9)
		0.01A/s~27.00A/s (2260B-250-13)
		0.001A/s~2.880A/s (2260B-800-1)
		0.001A/s~5.760A/s (2260B-800-2)
0.001A/s~8.640A/s (2260B-800-4)		
Falling current slew rate	F-07	0.01A/s~72.00A/s (2260B-30-36)
		0.1A/s~144.0A/s (2260B-30-72)
		0.1A/s~216.0A/s (2260B-30-108)
		0.01A/s~27.00A/s (2260B-80-13)
		0.01A/s~54.00A/s (2260B-80-27)
		0.01A/s~81.00A/s (2260B-80-40)
		0.001A/s~9.000A/s (2260B-250-4)
		0.01A/s~18.00A/s (2260B-250-9)
		0.01A/s~27.00A/s (2260B-250-13)
		0.001A/s~2.880A/s (2260B-800-1)
		0.001A/s~5.760A/s (2260B-800-2)
0.001A/s~8.640A/s (2260B-800-4)		
Internal resistance setting	F-08	0.000Ω~0.833Ω (2260B-30-36)
		0.000Ω~0.417Ω (2260B-30-72)
		0.000Ω~0.278Ω (2260B-30-108)
		0.000Ω~5.926Ω (2260B-80-13)
		0.000Ω~2.963Ω (2260B-80-27)
		0.000Ω~1.975Ω (2260B-80-40)
		0.00Ω~55.55Ω (2260B-250-4)
		0.00Ω~27.77Ω (2260B-250-9)
		0.00Ω~18.51Ω (2260B-250-13)
		0.0Ω~555.5Ω (2260B-800-1)
		0.0Ω~277.8Ω (2260B-800-2)
0.0Ω~185.1Ω (2260B-800-4)		
Bleeder circuit control	F-09	0 = OFF, 1 = ON, 2 = AUTO
Buzzer ON/OFF control	F-10	0 = OFF, 1 = ON
Measurement Average Setting	F-17	0 = Low, 1 = Middle, 2 = High

Lock Mode	F-19	0 = Panel lock: allow output off 1 = Panel lock: allow output on/off
USB/GPIB settings		
Front panel USB State	F-20	0 = Absent, 1 = Mass Storage
Rear panel USB State	F-21	0 = Absent, 2 = USB-CDC, 3 = GPIB-USB adapter
Rear panel USB mode	F-22	0 = Disable, 1 = GPIB-USB adapter, 2 = USB CDC, Auto Detect Speed, 3 = USB CDC, Full Speed Only
GPIB address	F-23	0~30
LAN settings		
MAC Address-1	F-30	0x00~0xFF
MAC Address-2	F-31	0x00~0xFF
MAC Address-3	F-32	0x00~0xFF
MAC Address-4	F-33	0x00~0xFF
MAC Address-5	F-34	0x00~0xFF
MAC Address-6	F-35	0x00~0xFF
LAN	F-36	0 = Disable, 1 = Enable
DHCP	F-37	0 = Disable, 1 = Enable
IP Address-1	F-39	0~255
IP Address-2	F-40	0~255
IP Address-3	F-41	0~255
IP Address-4	F-42	0~255
Subnet Mask-1	F-43	0~255
Subnet Mask-2	F-44	0~255
Subnet Mask-3	F-45	0~255
Subnet Mask-4	F-46	0~255
Gateway-1	F-47	0~255
Gateway-2	F-48	0~255
Gateway-3	F-49	0~255
Gateway-4	F-50	0~255
DNS address -1	F-51	0~255
DNS address -2	F-52	0~255
DNS address-3	F-53	0~255
DNS address-4	F-54	0~255
Sockets active	F-57	0 = Disable, 1 = Enable
Web Server active	F-59	0 = Disable, 1 = Enable
Web password active	F-60	0 = Disable, 1 = Enable
Web setting password	F-61	0000~9999
System Settings		

Factory Set Value	F-88	0 = Disable 1 = Return to factory settings
Show Version	F-89	0, 1 = 2260B version 2, 3 = 2260B build year 4, 5 = 2260B build month/day 6, 7 = Keyboard CPLD version 8, 9 = Analog-Control CPLD version A, B = Reserved C, D = Kernel build year E, F = Kernel build month/day
Power On Configuration Settings*		
CV Control	F-90	0 = Panel control (local) 1 = External voltage control 2 = External resistance control (Ext- $R \searrow 10k\Omega = V_o, \max$) 3 = External resistance control (Ext- $R \triangleright 10k\Omega = 0$)
CC Control	F-91	0 = Panel control (local) 1 = External voltage control 2 = External resistance control (Ext- $R \searrow 10k\Omega = I_o, \max$) 3 = External resistance control (Ext- $R \triangleright 10k\Omega = 0$)
Power-ON Output	F-92	0 = OFF at startup 1 = ON at startup T001 ~ T010 = Run Test Sequence TXX at start up
Master/Slave	F-93	0 = Master/Local 1 = Master/Parallel1 2 = Master/Parallel2 3 = Slave/Parallel 4 = Slave/Series (Only 30V, 80V models)
External Out Logic	F-94	0 = High ON, 1 = Low ON
Power Switch trip	F-95	0 = Enable , 1 = Disable
Calibration Settings*		
Calibration	F-00	0000 ~ 9999



*Note

Power On and Calibration settings can only be set during power up.

Normal Function Settings

Output ON Delay Time Delays turning the output on for a designated amount of time. The Delay indicator will light when the Delay time is not 0.

Note: The Output ON Delay Time setting has a maximum deviation (error) of 20ms.

The Output ON Delay Time setting is disabled when the output is set to external control.

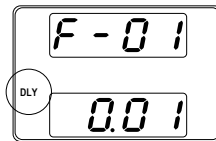

F-01 0.00s~99.99s

Output OFF Delay Time Delays turning the output off for a designated amount of time. The Delay indicator will light when the Delay time is not 0.

Note: The Output OFF Delay Time setting has a maximum deviation (error) of 20ms.

The Output OFF Delay Time setting is disabled when the output is set to external control.

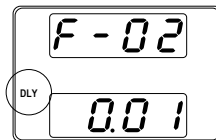

F-02 0.00s~99.99s

V-I Mode Selects High Speed Priority or Slew Rate Priority for CV or CC mode. The voltage or current slew rate can only be edited if CC/CV Slew Rate Priority is selected. The ISR indicator will be lit for CC Slew Rate Priority and the VSR indicator will be lit for CV Slew Rate Priority.

Note: CC and CV Slew Rate Priority mode are disabled when voltage/current output is set to external control.

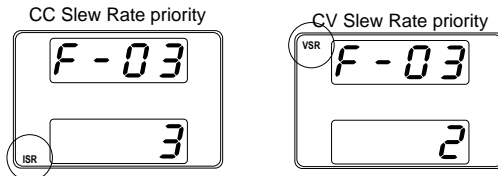

F-03 0 = CV high speed priority
 1 = CC high speed priority
 2 = CV slew rate priority
 3 = CC slew rate priority

Rising Voltage Slew Rate Sets the rising voltage slew rate. Only applicable if V-I Mode is set to CV Slew Rate Priority.

F-04 0.01V/s~60V/s (2260B-30-XX)
 0.1V/s~160V/s (2260B-80-XX)
 0.1V/s~500.0V/s (2260B-250-XX)
 1V/s~1600V/s (2260B-800-XX)

Falling Voltage Slew Rate Sets the falling voltage slew rate. Only applicable if V-I Mode is set to CV Slew Rate Priority.

F-05 0.01V/s~60V/s (2260B-30-XX)
 0.1V/s~160V/s (2260B-80-XX)
 0.1V/s~500.0V/s (2260B-250-XX)
 1V/s~1600V/s (2260B-800-XX)

**Rising Current
Slew Rate**

Sets the rising current slew rate. Only applicable if V-I Mode is set to CC Slew Rate Priority.

F-06	0.01A/s~72.00A/s (2260B-30-36)
	0.1A/s~144.0A/s (2260B-30-72)
	0.1A/s~216.0A/s (2260B-30-108)
	0.01A/s~27.00A/s (2260B-80-13)
	0.01A/s~54.00A/s (2260B-80-27)
	0.01A/s~81.00A/s (2260B-80-40)
	0.001A/s~9.000A/s (2260B-250-4)
	0.01A/s~18.00A/s (2260B-250-9)
	0.01A/s~27.00A/s (2260B-250-13)
	0.001A/s~2.880A/s (2260B-800-1)
	0.001A/s~5.760A/s (2260B-800-2)
	0.001A/s~8.640A/s (2260B-800-4)

**Falling Current
Slew Rate**

Sets the falling current slew rate. Only applicable if V-I Mode is set to CC Slew Rate Priority.

F-07	0.01A/s~72.00A/s (2260B-30-36)
	0.1A/s~144.0A/s (2260B-30-72)
	0.1A/s~216.0A/s (2260B-30-108)
	0.01A/s~27.00A/s (2260B-80-13)
	0.01A/s~54.00A/s (2260B-80-27)
	0.01A/s~81.00A/s (2260B-80-40)
	0.001A/s~9.000A/s (2260B-250-4)
	0.01A/s~18.00A/s (2260B-250-9)
	0.01A/s~27.00A/s (2260B-250-13)
	0.001A/s~2.880A/s (2260B-800-1)
	0.001A/s~5.760A/s (2260B-800-2)
	0.001A/s~8.640A/s (2260B-800-4)

Internal Resistance Settings	Sets the internal resistance of the power supply.
F-08	<p>0.000Ω~0.833Ω (2260B-30-36)</p> <p>0.000Ω~0.417Ω (2260B-30-72)</p> <p>0.000Ω~0.278Ω (2260B-30-108)</p> <p>0.000Ω~5.926Ω (2260B-80-13)</p> <p>0.000Ω~2.963Ω (2260B-80-27)</p> <p>0.000Ω~1.975Ω (2260B-80-40)</p> <p>0.00Ω~ 55.55Ω (2260B-250-4)</p> <p>0.00Ω~ 27.77Ω (2260B-250-9)</p> <p>0.00Ω~ 18.51Ω (2260B-250-13)</p> <p>0.0Ω~ 555.5Ω (2260B-800-1)</p> <p>0.0Ω~ 277.8Ω (2260B-800-2)</p> <p>0.0Ω~ 185.1Ω (2260B-800-4)</p>

Bleeder Control	<p>Bleeder control turns ON/OFF the bleeder resistor. When set to AUTO the bleeder resistor is automatically turned on when the output is turned on and turned off when the output is turned off. Bleeder resistors discharge the filter capacitors after power is turned off as a safety measure.</p> <p>The AUTO setting is only applicable to firmware version 1.59 or above.</p>
F-09	0 = OFF, 1 = ON, 2 = AUTO

Buzzer ON/OFF	<p>Turns the buzzer sound on or off. The buzzer is associated with alarm sounds and keypad entry sounds.</p>
F-10	0 = OFF, 1 = ON

Measurement Average Setting	<p>Determines the level of smoothing for the average setting.</p> <p>Only available for firmware version 1.5 or above.</p>
F-17	0 = Low, 1 = Middle, 2 = High

Example
measurement
times

If the output voltage changes, the time for the measurements to update for the three settings will be approximately:

Low	Middle	High
0.25sec	1.5sec	2.5sec

Lock Mode

Determines the behavior of the Output key when the panel lock is on.

Only available for firmware version 1.54 or above.

F-19

0 = Panel lock: allow output off,

1 = Panel lock: allow output on/off

USB/GPIB Settings

Front Panel USB State	Displays the front panel USB-A port state. This setting is not configurable.
F-20	0 = Absent, 1 = Mass Storage
Rear Panel USB State	Displays the rear panel USB-B port state. This setting is not configurable.
F-21	0 = Absent, 2 = USB-CDC, 3 = GPIB-USB adapter
Rear Panel USB Mode	Sets the rear panel USB mode. Note: Option#3, USB CDC Full Speed Only, can be used to reduce the data transmission speed when there are sources of interference in the operating environment. This option is only available for firmware version 1.66 and above.
F-22	0 = Disable, 1 = GPIB-USB adapter (for 2260B-GPIB-USB), 2 = USB CDC, Auto Detect Speed, 3 = USB CDC, Full Speed Only
GPIB Address	Sets the GPIB address.
F-23	0~30

LAN Settings

MAC Address-1~6	Displays the MAC address 1~6. This setting is not configurable. F-30~F-35 0x00~0xFF
LAN	Turns Ethernet on or off. F-36 0 = Disable, 1 = Enable
DHCP	Turns DHCP on or off. F-37 0 = Disable, 1 = Enable
IP Address-1~4	Sets the default IP address. IP address 1~4 splits the IP address into four sections. (F-39 : F-40 : F-41 : F-42) (0~255 : 0~255 : 0~255 : 0~255)
Subnet Mask 1~4	Sets the subnet mask. The subnet mask is split into four parts. (F-43 : F-44 : F-45: F-46) (0~255 : 0~255 : 0~255 : 0~255)
Gateway 1~4	Sets the gateway address. The gateway address is split into 4 parts. (F-47 : F-48 : F-49 : F-50) (0~255 : 0~255 : 0~255 : 0~255)
DNS Address 1~4	Sets the DNS address. The DNS address is split into 4 parts. (F-51 : F-52 : F-53 : F-54) (0~255 : 0~255 : 0~255 : 0~255)
Sockets active	Enables WebSocket connections. F-57 0 = Disable, 1 = Enable
Web server active	Turns Web server control on/off. F-59 0 = Disable, 1 = Enable

Web Password active	Turns a web password on/off. F-60	0 = Disable, 1 = Enable
Web Password	Sets the Web password. F-61	0000 ~ 9999

System Settings

Factory Set Value	Returns the 2260B to the factory default settings. See page 173 for a list of the default settings. F-88	0 = Disable, 1 = Return to factory default settings.
Show Version	Displays the 2260B version number, build date, keyboard version, analog-control version and kernel build. F-89	0, 1 = Version 2, 3 = Build year 4, 5 = Build month/day 6, 7 = Keyboard CPLD version 8, 9 = Analog-Control CPLD version A, B = Reserved C, D = Kernel build year E, F = Kernel build month/day

Power On Configuration Settings

CV Control	<p>Sets the constant voltage (CV) control mode between local and external voltage/resistance control. For external voltage control, see page 125 (External Voltage Control of Voltage Output) and page 130 (External Resistance Control of Voltage Output).</p> <p>F-90 0= Panel control (local) 1 = External voltage control 2 = External resistance control (Ext-R \searrow 10kΩ = $V_{o,max}$) 3 = External resistance control (Ext-R \triangleright 10kΩ = 0)</p>
<hr/>	
CC Control	<p>Sets the constant current (CC) control mode between local and external voltage/resistance control. For details on external voltage control, see page 128 (External Voltage Control of Current Output) and 132 (External Resistance Control of Current Output).</p> <p>F-91 0= Panel control (local) 1 = External voltage control 2 = External resistance control (Ext-R \searrow 10kΩ = $I_{o,max}$) 3 = External resistance control (Ext-R \triangleright 10kΩ = 0)</p>
<hr/>	
Power-ON Output	<p>Sets the power supply to turn the output on or off at power up.</p> <p>F-92 0 = OFF at startup, 1 = On at start up</p>
<hr/>	

Master/Slave	Sets the power supply as master or slave. See the parallel/series operation for details, page 75.
F-93	0 = Master/Local 1 = Master/Parallel1 2 = Master/Parallel2 3 = Slave/Parallel 4 = Slave/Series
External Out Logic	Sets the external logic as active high or low.
F-94	0= High ON, 1 = Low ON
Power Switch Trip	Turns the power off if enabled when the protection settings are tripped.
F-95	1 = Disable, 0 = Enable

Calibration

Programmable Calibration	The calibration password is used to access the local mode calibration or other special functions. The password used determines which function is accessed. Please see your distributor for details.
F-00	0000 ~ 9999

Setting Normal Function Settings

The normal function settings (F-01~F-61, F-88~F-89) can be easily configured with the Function key.

- Ensure the load is not connected.
- Ensure the output is off.



Note

Function setting F-89 (Show Version) can only be viewed, not edited.

Configuration settings F-90~F-95 cannot be edited in the Normal Function Settings. Use the Power On Configuration Settings. See page 120 for details.

Steps

1. Press the Function key. The function key will light up.

Function



2. The display will show F-01 on the top and the configuration setting for F-01 on the bottom.



3. Rotate the Voltage knob to change the F setting.

Range F-00~ F-61, F-88~F-89

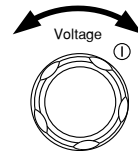

4. Use the Current knob to set the parameter for the chosen F setting.

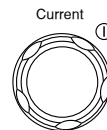

5. Press the Voltage knob to save the configuration setting. ConF will be displayed when successful.

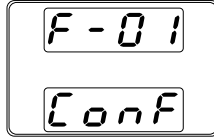
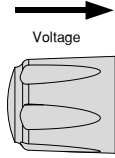

Exit

Press the Function key again to exit the configuration settings. The function key light will turn off.



Setting Power On Configuration Settings

Background

The Power On configuration settings can only be changed during power up to prevent the configuration settings being inadvertently changed.

- Ensure the load is not connected.
- Ensure the power supply is off.

Steps

1. Hold the Function key while turning the power on.
2. The display will show F-90 on the top and the configuration setting for F-90 on the bottom.

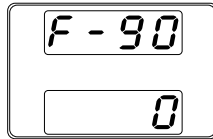
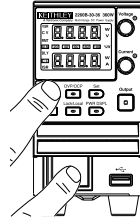

3. Rotate the Voltage knob to change the F setting.

Range F-90~ F-95

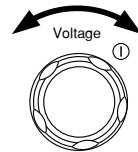

4. Use the Current knob to set the parameter for the chosen F setting.

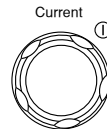

5. Press the Voltage knob to save the configuration setting. ConF will be displayed when successful.

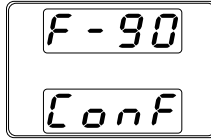
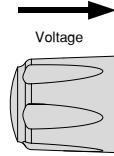

Exit

Cycle the power to save and exit the configuration settings.

ANALOG CONTROL

The Analog Control chapter describes how to control the voltage or current output using an external voltage or resistance, monitor the voltage or current output as well as remotely turning off the output or shutting down the power supply.

Analog Remote Control Overview	123
Analog Control Connector Overview	123
External Voltage Control of Voltage Output	125
External Voltage Control of Current Output	128
External Resistance Control of Voltage Output	130
External Resistance Control of Current Output	132
External Control of Output	134
External control of Shutdown	137
Remote Monitoring	139
External Voltage and Current Monitoring	139
External Operation and Status Monitoring	141

Analog Remote Control Overview

The 2260B power supply series have a number of analog control options. The Analog Control connectors are used to control output voltage and current using external voltage or resistance. The power supply output and power switch can also be controlled using external switches.

- Analog Control connector overview → from page 123
- External voltage control of voltage output → from page 125
- External voltage control of current output → from page 128
- External resistance control of voltage output → from page 130
- External resistance control of current output → from page 132
- External control of output → from page 134
- External control of the power switch → from page 137

Analog Control Connector Overview

Overview The Analog Control Connector is a standard Mil 26 pin connector (OMRON XG4 IDC plug). The connector is used for all analog remote control. The pins used determine what remote control mode is used.



WARNING

To prevent electric shock, ensure that the cover for the Analog Control Connector is used when the connector is not in use.

Pin Assignment

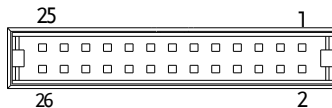

Pin name	Pin number	Description
Current Share	1	Used when operating 2 or more units in parallel.

D COM	2	Connected to the (-S) sense- terminal when remote sense is used. Connected to the negative output terminal when remote sense is not used.
CURRENT SUM OUT	3	Current sum output signal when used in parallel mode.
EXT-V CV CONT	4	External voltage control of the voltage output. A voltage of 0~10V is used to control the full scale voltage output (0%~100%) of the instrument.
EXT-V CC CONT	5	External voltage control of the current output. A voltage of 0~10V is used to control the full scale current output (0%~100%) of the instrument
EXT-R CV CONT PIN1	6	External resistance control of the voltage output. A resistance of 0k Ω ~ 10k Ω is used to control the full scale voltage output (0%~100%) of the instrument.
EXT-R CV CONT PIN2	7	External resistance control of the voltage output. A resistance of 0k Ω ~ 10k Ω is used to control the full scale voltage output (0%~100%) of the instrument.
EXT-R CC CONT PIN1	8	External resistance control of the current output. A resistance of 0k Ω ~ 10k Ω is used to control the full scale current output (0%~100%) of the instrument.
EXT-R CC CONT PIN2	9	External resistance control of the current output. A resistance of 0k Ω ~ 10k Ω is used to control the full scale current output (0%~100%) of the instrument.
V MON	10	Voltage Monitor Output. Outputs the full scale voltage (0~100%) as a voltage (0V~10V).
I MON	11	Current Monitor Output. Outputs the full scale current (0~100%) as a voltage (0V~10V).
SHUTDOWN	12	The shut down signal will turn off the output or power when a low TTL signal is applied. The shutdown signal is pulled up to 5V with a 10k Ω pull-up resistor.
CURRENT_SUM_1	13	Master unit current sum input signal from first slave CURRENT SUM OUTPUT. Used in parallel mode only.
CURRENT_SUM_2	14	Master unit current sum input signal from second slave CURRENT SUM OUTPUT. Used in parallel mode only.

FEEDBACK	15	Parallel control signal during master-slave parallel operation.
A COM	16	Analog signal common. Connected to the sense-terminal when remote sense is used. Connected to the negative output terminal when remote sense is not used.
STATUS COM	17	Common for status signals 18, 19, 20, 21 and 22.
CV STATUS	18	Turns on when CV mode is active. (photo coupled open collector output)
CC STATUS	19	Turns on when CC mode is active. (photo coupled open collector output)
ALM STATUS	20	Turns on when any of the protection modes are tripped (OVP, OCP) or if a shutdown signal is input. (photo coupled open collector output)
OUTPUT ON STATUS	21	Turns on when the output has been turned on. (photo coupled open collector output)
POWER OFF STATUS	22	Turns on when the power switch is turned off.
N.C.	23	Not connected
OUT ON/OFF CONT	24	Turns the output on/off when (default setting) a low TTL signal is applied. Internally, the circuit is pulled up to +5V with 10kΩ resistance.
SER SLV IN	25	Series slave input during master-slave series operation. (30V/80V models only)
N.C.	26	Not connected

External Voltage Control of Voltage Output

Background

External voltage control of the voltage output is accomplished using the MIL-26 connector on the rear panel. A voltage of 0~10V is used to control the full scale voltage of the instrument, where:

Output voltage = full scale voltage × (external voltage/10)

Connection

When connecting the external voltage source to the MIL connectors, use shielded or twisted paired wiring.

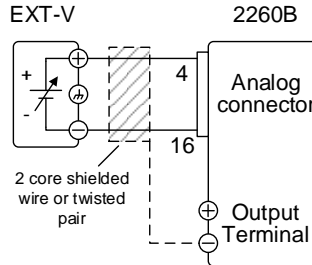

- Pin16 → EXT-V (-)
- Pin4 → EXT-V (+)
- Wire shield → negative (-) output terminal

Connection- alt. shielding

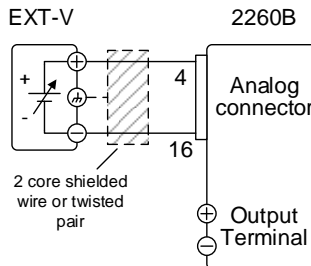

If the wire shield needs to be grounded at the voltage source (EXT-V), then the shield cannot also be grounded at the negative (-) terminal output of the 2260B power supply. This would short the output.



- Pin16 → EXT-V(-)
- Pin4 → EXT-V(+)
- Wire shield → EXT-V ground (GND)

Panel operation

1. Connect the external voltage according to the connection diagrams above.

2. Set the F-90 power on configuration setting to 1 (CV control – Ext voltage). Page 120
 - Be sure to cycle the power after the power on configuration has been set.
3. Press the Function key and confirm the new configuration settings (F-90=1). Function

4. Press the Output key. The voltage can now be controlled with the External voltage. Output



Note

The input impedance for external voltage control is 10kΩ.

Use a stable voltage supply for the external voltage control.



Note

CV and CC Slew Rate Priority are disabled for V-I mode (F-03) when using external voltage control. See the normal function settings on page 108.



CAUTION

Ensure no more than 10.5 volts are input into the external voltage input.

Ensure the voltage polarity is correct when connecting the external voltage.

External Voltage Control of Current Output

Background External voltage control of the current output is accomplished using the MIL-26 connector on the rear panel. A voltage of 0~10V is used to control the full scale current of the instrument, where:

$$\text{Output current} = \text{full scale current} \times (\text{external voltage}/10)$$

Connection When connecting the external voltage source to the MIL connectors, use shielded or twisted paired wiring.

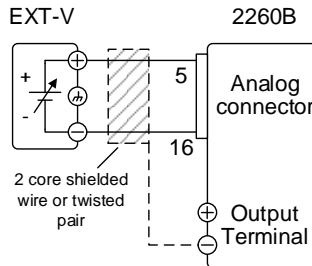

- Pin16 → EXT-V (-)
- Pin5 → EXT-V (+)
- Wire shield → negative (-) output terminal

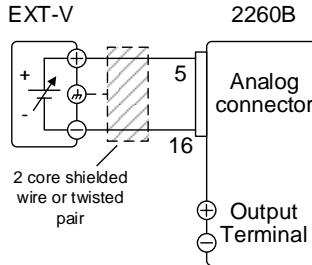

Connection- alt. shielding

If the wire shield needs to be grounded at the voltage source (EXT-V), then the shield cannot also be grounded at the negative (-) terminal output of the 2260B power supply. This would short the output.



- Pin16 → EXT-V (-)
- Pin5 → EXT-V (+)
- Wire shield → EXT-V ground (GND)

Steps

1. Connect the external voltage according to the connection diagrams above.
2. Set the F-91 power on configuration setting to 1 (CC control - Ext voltage). Page 120
 - Be sure to cycle the power after the power on configuration has been set.
3. Press the Function key and confirm the new configuration settings (F-91=1). Function

4. Press the Output key. The current can now be controlled with the External voltage. Output



Note

The input impedance for external voltage control is 10k Ω .

Use a stable voltage supply for the external voltage control.



Note

CV and CC Slew Rate Priority are disabled for V-I mode (F-03) when using external voltage control. See the normal function settings on page 108.



CAUTION

Ensure the voltage polarity is correct when connecting the external voltage.

Ensure no more than 10.5 volts are input into the external voltage input.

External Resistance Control of Voltage Output

Background

External resistance control of the voltage output is accomplished using the MIL-26 connector on the rear panel. A resistance of 0k Ω ~10k Ω is used to control the full scale voltage of the instrument.

The output voltage (0 to full scale) can be controlled with the external resistance going up (Ext-R \swarrow) 0k Ω ~10k Ω (10k Ω = $V_{o,max}$) or down (Ext-R \searrow) 10k Ω ~0k Ω (10k Ω = 0).

For 0k Ω ~10k Ω : Output voltage = full scale voltage \times (external resistance/10)

For 10k Ω ~0k Ω : Output voltage = full scale voltage \times ([10-external resistance]/10)



Note

The Ext-R ∇ configuration is recommended for safety reasons. In the event that the cables become accidentally disconnected, the voltage output will drop to zero. Under similar circumstances using Ext-R \sphericalangle , an unexpected high voltage would be output.

If switches are used to switch between fixed resistances, use switches that avoid creating open circuits. Use short-circuit or continuous resistance switches.

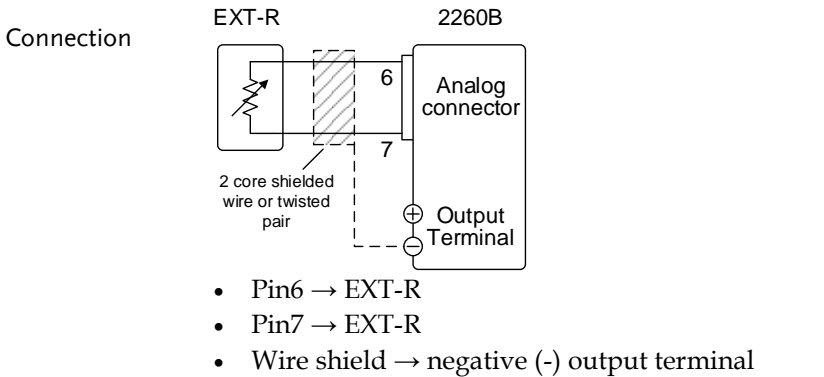

- Steps
1. Connect the external resistance according to the connection diagrams above.
 2. Set the F-90 (CV Control) Page 120
configuration settings to 2 for Ext-R \sphericalangle or 3 for Ext-R ∇ .
 - Be sure to cycle the power after the power on configuration has been set.
 3. Press the Function key and confirm Function
the new configuration settings (F-90=2 or 3).

4. Press the Output key. The voltage can now be controlled with the External resistance.



Ensure the resistor(s) and cables used exceed the isolation voltage of the power supply. For example: insulation tubes with a withstand voltage higher than the power supply can be used.

When choosing an external resistor ensure the resistor can withstand a high degree of heat.



CV and CC Slew Rate Priority are disabled for V-I mode (F-03) when using external resistance control. See the normal function settings on page 108.

External Resistance Control of Current Output

Background

External resistance control of the current output is accomplished using the MIL-26 connector on the rear panel. A resistance of $0\text{k}\Omega\sim 10\text{k}\Omega$ is used to control the full scale current of the instrument.

The output current (0 to full scale) can be controlled with the external resistance going up (Ext-R \swarrow) $0\text{k}\Omega\sim 10\text{k}\Omega$ ($10\text{k}\Omega = V_{o,max}$) or down (Ext-R \searrow) $10\text{k}\Omega\sim 0\text{k}\Omega$ ($10\text{k}\Omega = 0$).

For $0\text{k}\Omega\sim 10\text{k}\Omega$: Output current = full scale current \times (external resistance/10)

For $10\text{k}\Omega\sim 0\text{k}\Omega$: Output current = full scale current \times ([10-external resistance]/10)



Note

The Ext-R ∇ configuration is recommended for safety reasons. In the event that the cables become accidentally disconnected, the current output will drop to zero. Under similar circumstances using Ext-R \sloperight , an unexpected high current would be output.

If switches are used to switch between fixed resistances, use switches that avoid creating open circuits. Use short-circuit or continuous resistance switches.

Connection

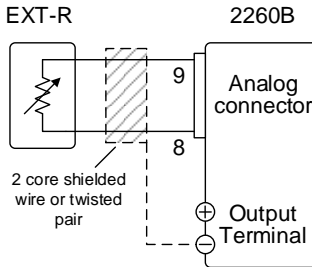

- Pin9 → EXT-R
- Pin8 → EXT-R
- Wire shield → negative (-) output terminal

Steps

1. Connect the external resistance according to the connection diagrams above.
2. Set the F-91 (CC Control) Page 120
configuration settings to 2 for Ext-R \sloperight or 3 for Ext-R ∇ .
- Be sure to cycle the power after the power on configuration has been set.
3. Press the Function key and confirm the new configuration settings (F-91=2 or 3). Function 

4. Press the Output key. The current can now be controlled with the External resistance.



Ensure the resistor(s) and cables used exceed the isolation voltage of the power supply. For example: insulation tubes with a withstand voltage higher than the power supply can be used.

When choosing an external resistor ensure the resistor can withstand a high degree of heat.



CV and CC Slew Rate Priority are disabled for V-I mode (F-03) when using external resistance control. See the normal function settings on page 108.

External Control of Output

Background

The output can be turned on or off externally using a switch. The analog control connector can be set to turn the output on from a high or low signal. The voltage across pins 2 and 24 are internally pulled to +5V \pm 5% @ 500uA with 10k Ω pull-up resistor. A short (closed switch) produces a low signal.

When set to High = On, the output is turned on when the pins 2-24 are open.

When Low = On, the output is turned on when pins 2-24 are shorted.

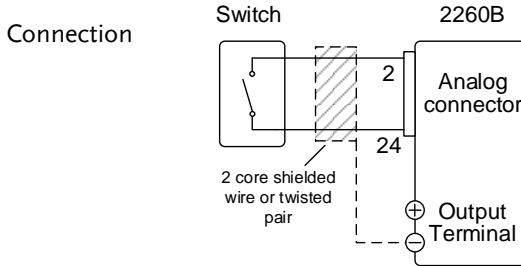

- Pin2 → Switch
- Pin24 → Switch
- Wire shield → negative (-) output terminal

Steps

1. Connect the external switch according to the connection diagrams above.

Set F-94 (External output logic) in Page 120 the power on configuration settings to 0 (High = On) or 1 (Low = On).

- Be sure to cycle the power after setting the power on configuration settings.
2. Press the Function key and confirm the new configuration settings.  Function
 3. The switch is now ready to set the output on or off.



Note

When using a switch over long distances, please use a switch relay to extend the line from the coil side of the relay.

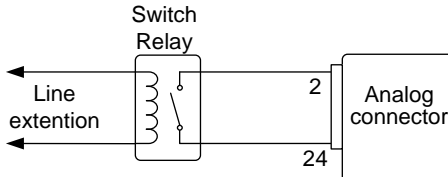

If a single switch control is to be used for multiple units, please isolate each instrument. This can be achieved by using a relay.



Warning

Ensure the cables used and the switch exceed the isolation voltage of the power supply. For example: insulation tubes with a withstand voltage higher than the power supply can be used.



Note

Messages: If F-94 = 0 (High = on) and the pin 24 is low (0) "MSG 001" will be displayed on the display.

If F-94 = 1 (Low = on) and the pin 24 is high (1) "MSG 002" will be displayed on the display.

Output off (High=on)



Output off (Low=on)



Note

Output ON/OFF Delay Time (F-01, F-02) are disabled when the output is set to external control. See the normal function settings on 108 for details.

External control of Shutdown

Background The output of the power supplies can be configured to shut down via an external switch. The ability to externally shut down the power supply must first be enabled in the power on configuration settings. The voltage across pins 2 and 12 are internally pulled to +5V $\pm 5\%$ @ 500uA with 10k Ω pull-up resistor.

Connection

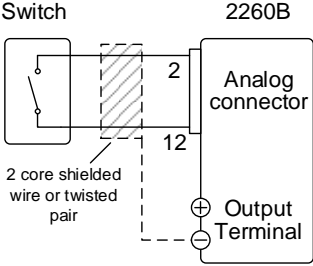

- Pin2 → Switch
- Pin12 → Switch
- Wire shield → negative (-) output terminal

- Steps**
1. Connect the external switches according to the connection diagrams above.
 2. Set F-95 to in the configuration settings to 0 (Enable). This will allow the external control of shutdown. Page 120
 3. Press the function key and confirm the new configuration settings. Function 
 4. The switch will now shut down the power supply when shorted.



Note

When using a switch over long distances, please use a switch relay to extend the line from the coil side of the relay.

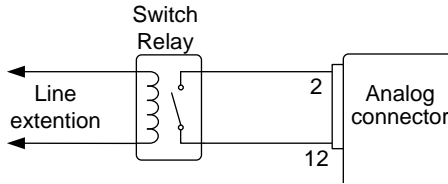

If a single switch control is to be used for multiple units, please isolate each instrument. This can be achieved by using a relay.



Warning

Ensure the cables and switch used exceed the isolation voltage of the power supply. For example: insulation tubes with a withstand voltage higher than the power supply can be used.

Remote Monitoring

The 2260B power supplies have remote monitoring support for current and voltage output. They also support monitoring of operation and alarm status.

- External monitoring of output voltage and current → from page 139
- External monitoring of operation mode and alarm status → from page 141

External Voltage and Current Monitoring

Background

The MIL 26 pin connector is used to monitor the current (IMON) or voltage (VMON) output.

An output of 0~10V represents the voltage or current output of 0~ rated current/voltage output.

- $IMON = (\text{current output}/\text{full scale}) \times 10$
- $VMON = (\text{voltage output}/\text{full scale}) \times 10$

External voltage and current monitoring doesn't need to be enabled in the configuration settings.

VMON
Connection

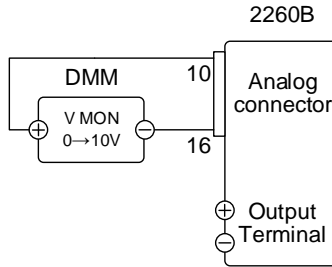

- Pin16 → Neg (-)
- Pin10 → Pos (+)

IMON
Connection

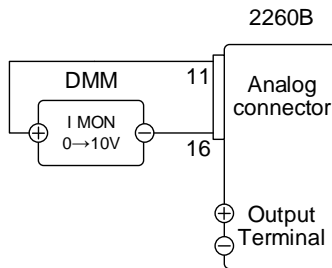

- Pin16 → Neg (-)
- Pin11 → Pos (+)



Note

The output impedance of the voltage (VMON) and current (IMON) monitor pins is $1k\Omega$.

Maximum current is 10mA.

The monitor outputs are strictly DC and should not be used to monitor analog components such as transient voltage response or ripple etc.



CAUTION

Ensure IMON(pin 11) and VMON(pin 10) are not shorted together. This will cause damage to the unit.

External Operation and Status Monitoring

Background

The MIL 26 pin connector can also be used to monitor the status operation and alarm status of the instrument.

The pins are isolated from the power supply internal circuitry by photo couplers. Status Com (Pin 17) is a photo coupler emitter output, while pins 18~22 are photo coupler collector outputs.

A maximum of 30V and 8mA can be applied to each pin.

Name and Pin	Description
STATUS COM 17	Common (photo coupler emitter) for status signals 18, 19, 20, 21 and 22.
CV STATUS 18	Low when CV mode is active.
CC STATUS 19	Low when CC mode is active.
ALM STATUS 20	Low when any of the protection modes are tripped (OVP, OCP). Active low.
OUT ON STATUS 21	Low when the output is on.
PWR OFF STATUS 22	Active low.

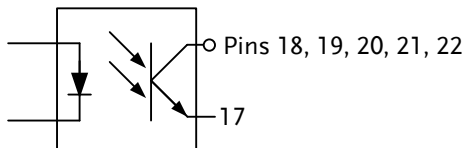

Timing diagrams Below are 4 example timing diagrams covering a number of scenarios. Note that pins 18~22 are all active low.

CV MODE:
Output turned on The diagram below shows the timing diagram when the output is turned on when the 2260B is set to CV mode.

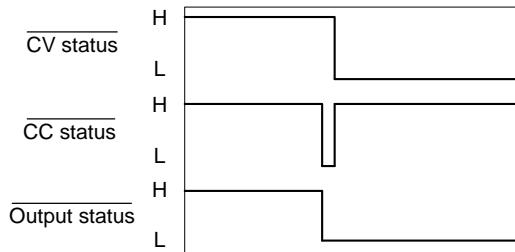

CV MODE:
Output turned off The diagram below shows the output status lines when the output is turned off in CV mode.

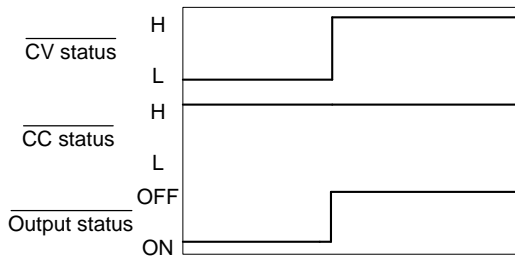

CC MODE:
Output turned on

The diagram below shows the timing diagram when the output is turned on when the 2260B is set to CC mode.

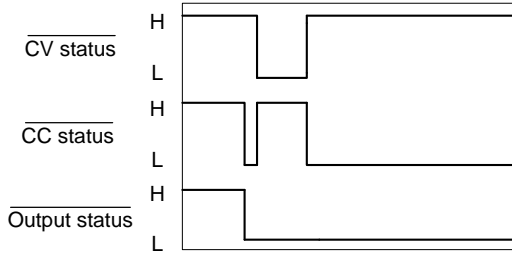

CC MODE:
Output turned off

The diagram below shows the output status lines when the output is turned off in CC mode.

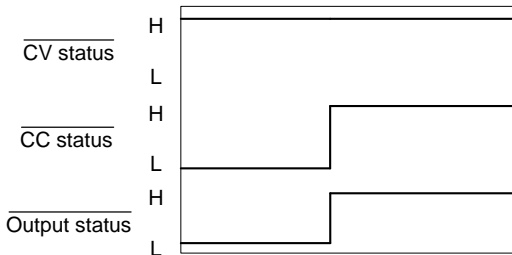

COMMUNICATION

INTERFACE

This chapter describes basic configuration of IEEE488.2 based remote control. For a command list, refer to the programming manual.

Interface Configuration	145
USB Remote Interface	145
Configure GPIB Interface.....	145
Configure Ethernet Connection	147
Web Server Configuration	147
Sockets Server Configuration	148
USB Function Check	149
Web Server Remote Control Function Check.....	152
Socket Server Function Check	153

Interface Configuration

USB Remote Interface

USB configuration	PC side connector	Type A, host
	2260B side connector	Rear panel Type B, slave
	Speed	1.1/2.0 (full speed/high speed)
	USB Class	CDC (communications device class)

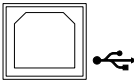
- Steps
1. Connect the USB cable to the rear panel USB B port. 
 2. Change the Rear panel-USB (F-22) setting to USB-CDC (2). [Page 118](#)

Configure GPIB Interface

To use GPIB, the optional GPIB to USB (2260B-GPIB-USB) adapter must be used. Only one GPIB address can be used at a time.

- Configure GPIB
1. Ensure the 2260B is off before proceeding.
 2. Connect the USB cable from the rear panel USB B port on the 2260B to the USB A port on the GPIB to USB adapter.
 3. Connect a GPIB cable from a GPIB controller to the GPIB port on the adapter.

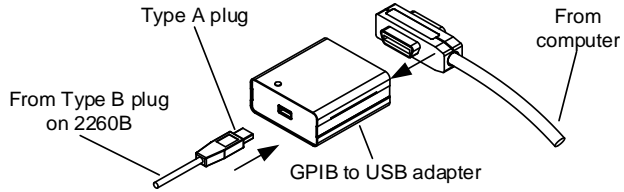

4. Turn the 2260B on.
5. Press the Function key to enter the Page 118 Normal configuration settings.

Set the following GPIB settings

- | | |
|-------------|---|
| F-22 = 1 | Set the rear panel USB port to GPIB-USB |
| F-23 = 0~30 | Set the GPIB address (0~30) |

GPIB constraints

- Maximum 15 devices altogether, 20m cable length, 2m between each device
- Unique address assigned to each device
- At least 2/3 of the devices turned On
- No loop or parallel connection

Configure Ethernet Connection

The Ethernet interface can be configured for a number of different applications. Ethernet can be configured for basic remote control or monitoring using a web server or it can be configured as a socket server.

The 2260B series supports both DHCP connections so the instrument can be automatically connected to an existing network or alternatively, network settings can be manually configured.

Ethernet configuration Parameters	For details on how to configure the Ethernet settings, please see the configuration chapter on page 114.
MAC Address (display only)	LAN
DHCP	IP Address
Subnet Mask	Gateway
DNS Address	Sockets Active
Web Server Active	Web Password Active
Web set password	0000–9999 (default 0000)

Web Server Configuration

Configuration This configuration example will configure the 2260B as a web server and use DHCP to automatically assign an IP address to the 2260B.

1. Connect an Ethernet cable from the network to the rear panel Ethernet port.

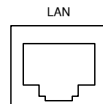

2. Press the Function key to enter the Page 118 Normal configuration settings.

Set the following LAN settings:

F-36 = 1	Enable LAN
F-37 = 1	Turn DHCP to enable
F-59 = 1	Turn the web server on



Note

It may be necessary to cycle the power or refresh the web browser to connect to a network.

Sockets Server Configuration

Configuration This configuration example will configure the 2260B socket server.

The following configuration settings will manually assign the 2260B an IP address and enable the socket server. By default, the socket server port number is 2268 and cannot be configured.

1. Connect an Ethernet cable from the network to the rear panel Ethernet port.

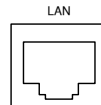

2. Press the Function key to enter the Page 118 Normal configuration settings.

Set the following LAN settings:

F-36 = 1	Enable LAN
F-37 = 0	Disable DHCP
F-39 = 172	IP Address part 1 of 4
F-40 = 16	IP Address part 2 of 4
F-41 = 5	IP Address part 3 of 4
F-42 = 133	IP Address part 4 of 4
F-43 = 255	Subnet Mask part 1 of 4
F-44 = 255	Subnet Mask part 2 of 4

F-45 = 128	Subnet Mask part 3 of 4
F-46 = 0	Subnet Mask part 4 of 4
F-43 = 172	Gateway part 1 of 4
F-44 = 16	Gateway part 2 of 4
F-45 = 21	Gateway part 3 of 4
F-46 = 101	Gateway part 4 of 4
F-57 = 1	Enable Sockets

USB Function Check

Background	To test the USB functionality, National Instruments Measurement and Automation Explorer can be used. This program is available on the NI website, www.ni.com , via a search for the VISA Run-time Engine page, or “downloads” at the following URL, http://www.ni.com/visa/
------------	---

Requirements	Operating System: Windows 7, XP
--------------	---------------------------------



The 2260B will appear as a COM port on the PC.

To check the COM port No, see the Device Manager in the PC. For Win 7; Control panel → Hardware and Sound → Device Manager.

Functionality check	1. Start the NI Measurement and Automation Explorer (MAX) program. Using Windows, press:
---------------------	--

Start>All Programs>National Instruments>Measurement & Automation



2. From the Configuration panel access;

My System>Devices and Interfaces

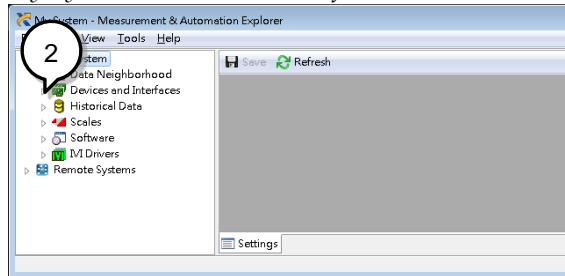

3. Select "COM7".

4. Press Open VISA Test Panel.

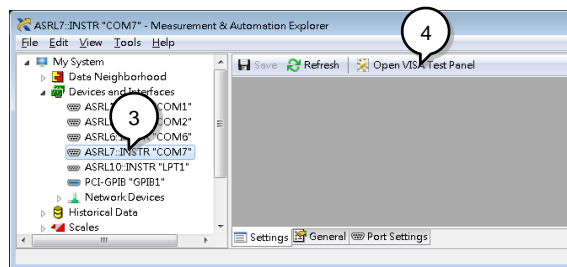

Note

The displayed COM port No. may differ with the

picture shown here. It depends on the virtual COM port number in your system. Here "COM7" is the Virtual COM port assigned to the 2260B.

5. Click the *Configuration* icon.
6. In the *I/O Settings* tab, select the *Enable Termination Character* check box. Ensure *Line Feed - \n* is selected as the line feed character.
7. Click *Apply Changes*.

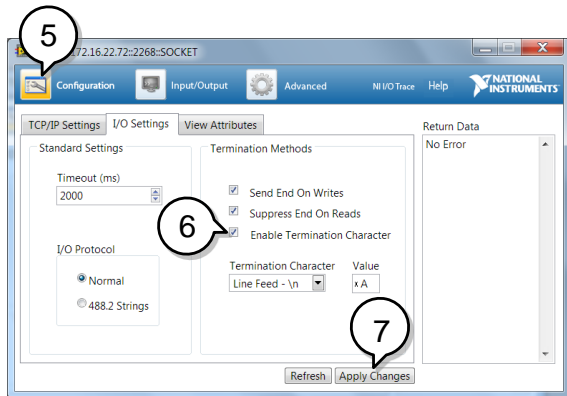

8. Click the *Input/Output* icon.
9. Ensure **IDN?\n* is selected in the *Select or Enter Command* dropdown text box.
10. Click the *Query* button.
11. The **IDN?* query should be returned to the buffer area:

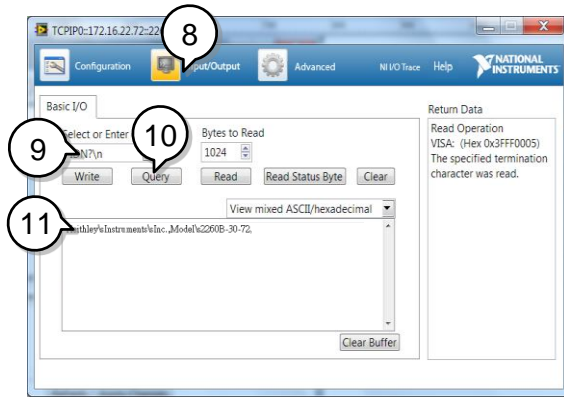

Note

For further details, please see the programming manual.

Web Server Remote Control Function Check

Functionality
check

Enter the IP address of the power supply in a web browser after the instrument has been configured as a web server (page 147).

`http:// XXX.XXX.XXX.XXX`

The web browser interface appears.



Note

For further details, please see the programming manual.

Socket Server Function Check

Background To test the socket server functionality, National Instruments Measurement and Automation Explorer can be used. This program is available on the NI website, www.ni.com, via a search for the VISA Run-time Engine page, or “downloads” at the following URL, <http://www.ni.com/visa/>

Requirements Operating System: Windows 7, XP

Functionality check 1. Start the NI Measurement and Automation Explorer (MAX) program. Using Windows, press:

Start>All Programs>National Instruments>Measurement & Automation



2. From the Configuration panel access;

My System>Devices and Interfaces>Network Devices

3. Click *Create New...*

4. Select *Visa TCP/IP Resource*.

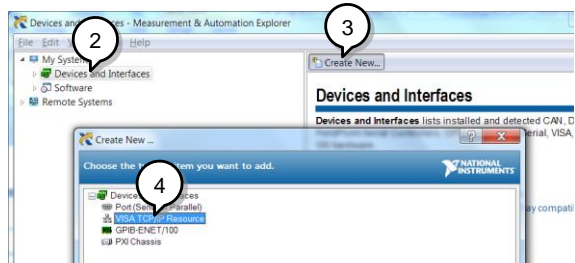

5. Select *Manual Entry of Raw Socket* from the popup window.
6. Click *Next*.

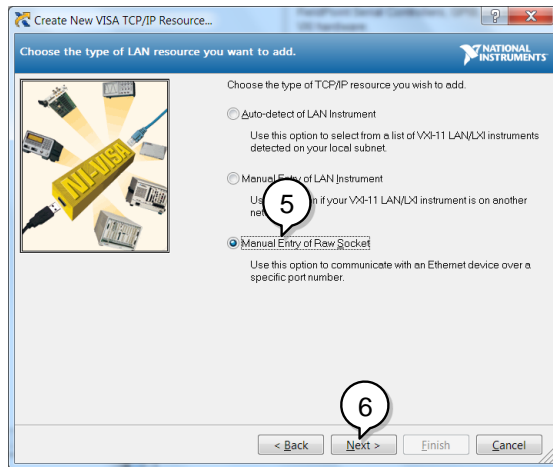

7. Enter the IP address and the port number of the 2260B. The port number is fixed at 2268.
8. Click the Validate button. A popup box will appear when successful.
9. Click *Next*.

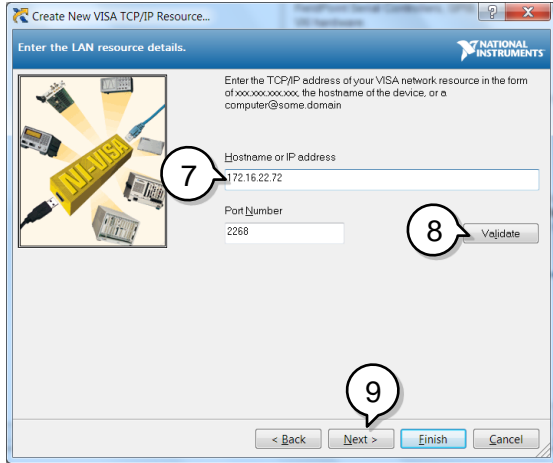

10. Next configure the Alias (name) of the 2260B connection. In this example the Alias is: PS_DC1

11. Click finish.

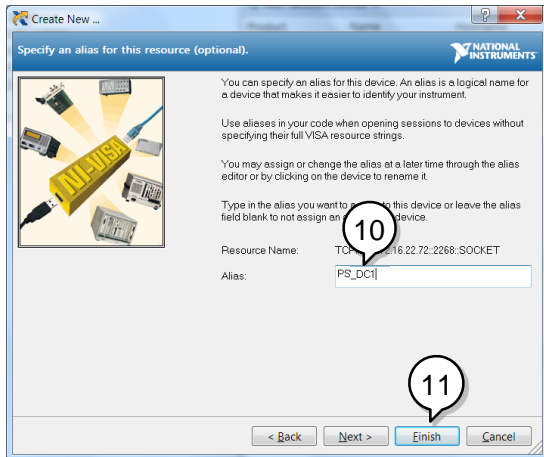

12. The IP address of the 2260B will now appear under Network Devices in the configuration panel. Select this icon now.

13. Press *Open VISA Test Panel*.

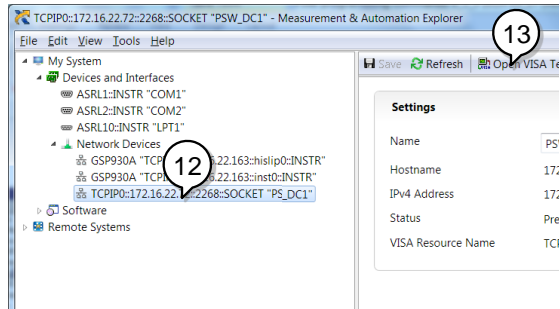

14. Click *Configuration* icon.

15. In the *I/O Settings* tab, select the *Enable Termination Character* check box. Ensure *Line Feed - \n* is selected as the line feed character.

16. Click *Apply Changes*.

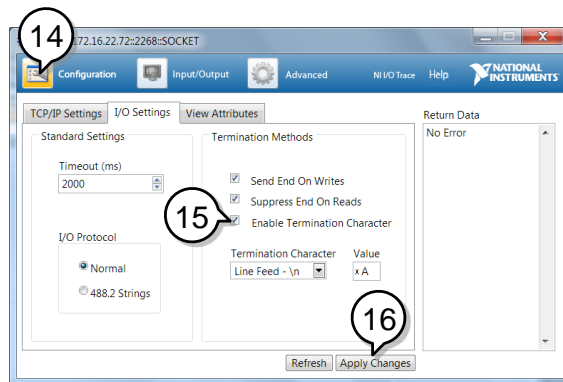

17. Click the *Input/Output* icon.

18. Ensure **IDN? \n* is selected in the *Select or Enter Command* dropdown text box.

19. Click the *Query* button.

20. The *IDN? query should be returned to the buffer area.

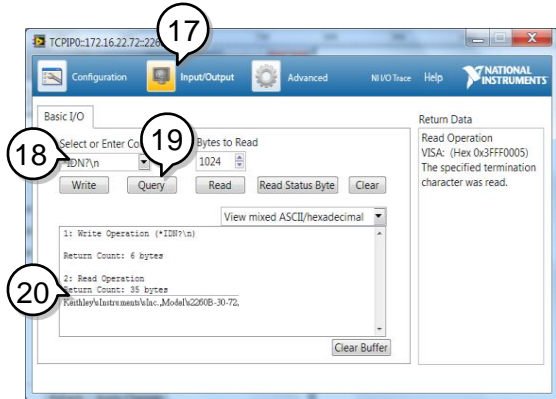

Note

For further details, please see the programming manual.

FIRMWARE UPGRADE PROCEDURE

Firmware Update	159
Check the Firmware Version	162
Kernel Update	164
Check the Kernel Version	167

Firmware Update

Background The firmware can be upgraded using the USB A port on the front panel.



Note

- Ensure the load is not connected.
- Ensure the output is off.

1. Insert a USB Flash Drive into the USB port on the front panel of the Keithley 2260B. Uncompress this zipped file to the root directory (USB\). The root directory needs to contain the **keithley** folder.

2. Press the Function key. The function key will light up.



3. The display will show F-01 on the top and the configuration setting for F-01 on the bottom.

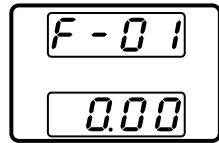

4. Rotate the voltage knob to change the F setting to F-00.

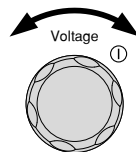

5. The display will show F-00 on the top and the 0000 for the Password for F-00.

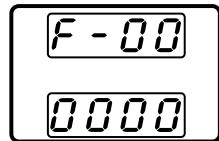

6. Use the current knob to set the Password for the F-00 setting. The Password is "5 0 0 4".

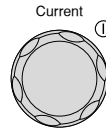

7. Press the Voltage knob to enter the Special Mode. SF- 1 will be displayed when successful.

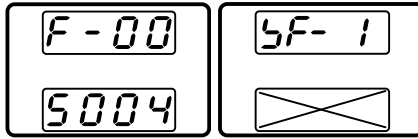
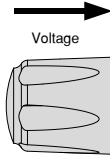

X can be anything in the display

8. Rotate the voltage knob to change the SF setting to SF- 2.

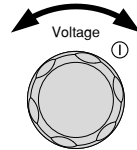

9. The display will show SF- 2 on the top.

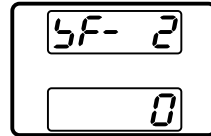

10. Use the current knob to set SF- 2 to "1".

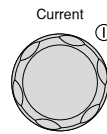

11. Press the Voltage knob to copy the new firmware to the 2260B.

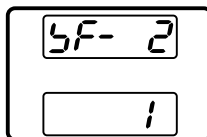
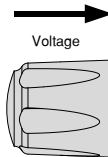

12. On progressing, the display will look as shown below.

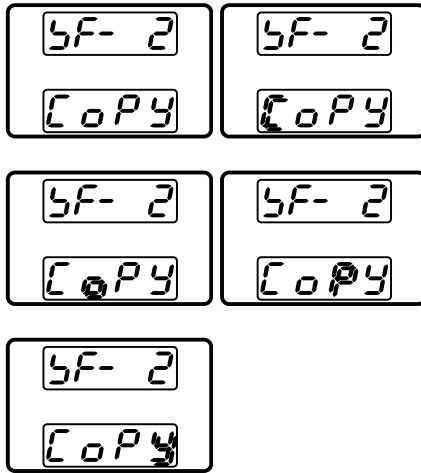

13. When the display looks as shown below, the system will reboot automatically.

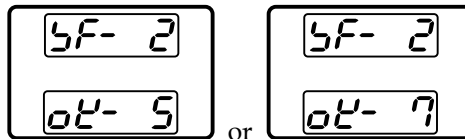

Check the Firmware Version

Background The F-89 configuration setting allows you to view the 2260B version number, build date, keyboard version, analog-control version and kernel build.

Steps

1. Press the Function key. The Function key will light up.

Function



2. The display should show F-01 on the top and the configuration setting for F-01 on the bottom.

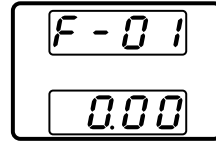

3. Rotate the Voltage knob to change the F setting to F-89 (Show Version).

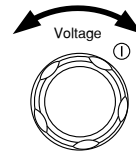

4. Rotate the Current knob to view the version and build date for the various items.

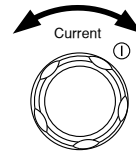

- F-89
- 0-XX: Main Program Version
 - 1-XX: Main Program Version
 - 2-XX: Main Program Build On-Year.
 - 3-XX: Main Program Build On-Year.
 - 4-XX: Main Program Build On-Month.
 - 5-XX: Main Program Build On-Day.
 - 6-XX: Keyboard CPLD version.
 - 7-XX: Keyboard CPLD version.
 - 8-XX: Analog CPLD version.
 - 9-XX: Analog CPLD version.
 - A-XX: Reserved.
 - B-XX: Reserved.
 - C-XX: Kernel Build On-Year.
 - D-XX: Kernel Build On-Year.
 - E-XX: Kernel Build On-Month.
 - F-XX: Kernel Build On-Day.

5. Press the Function key again to exit. The function key light will turn off.



Example

Main Program Version: Vt1.50, 2014/08-03

- 0-t1: Main Program Version
- 1-50: Main Program Version
- 2-20: Main Program Build On-Year.
- 3-14: Main Program Build On-Year.
- 4-08: Main Program Build On-Month.
- 5-03: Main Program Build On-Day.

Kernel Update



Note

- Ensure the load is not connected.
- Ensure the output is off.

1. Insert the USB Flash Drive with **keithley**.
2. The **keithley** folder includes **ps_os.blk**.



3. Press the Function key. The function key will light up.

Function



4. The display will show F-01 on the top and the configuration setting for F-01 on the bottom.

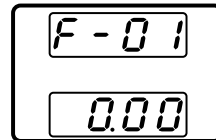

5. Rotate the voltage knob to change the F setting to F-00.

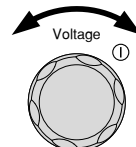

6. The display will show F-00 on the top and 0000 for the Password for F-00.

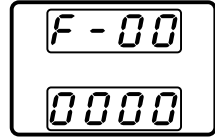

7. Use the current knob to set the Password for the F-00 setting. The Password is "5 0 0 4".

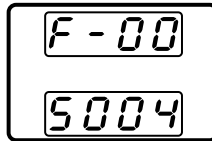
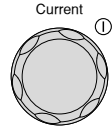

8. Press the Voltage knob to enter the Special Mode. SF- 1 will be displayed when successful.

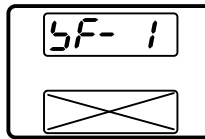
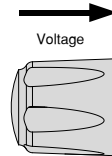

X = the display can be anything

9. Rotate the voltage knob to change the SF setting to SF- 6.

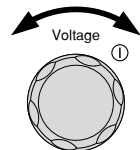

10. The display will show SF- 6 on the top.

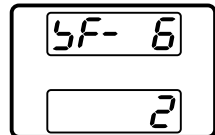

11. Use the current knob to set the value for SF- 6. The value is "2".

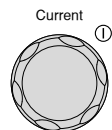

12. Press the Voltage knob to copy the new kernel to the 2260B.

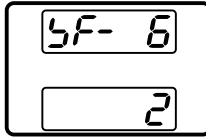
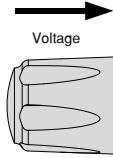

13. On progressing, the display will look as follows.

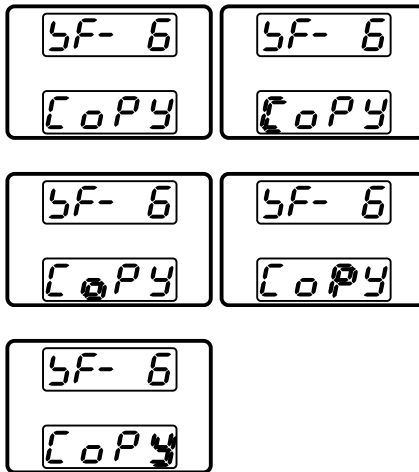

14. After the update has finished, SF- 6 and ok will be displayed.

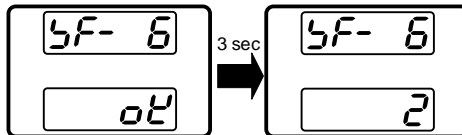

15. Cycle Power to complete this procedure.

Check the Kernel Version

Background The F-89 configuration setting allows you to view the 2260B version number, build date, keyboard version, analog-control version and kernel build.

Steps

1. Press the Function key. The Function key will light up.

Function



2. The display should show F-01 on the top and the configuration setting for F-01 on the bottom.

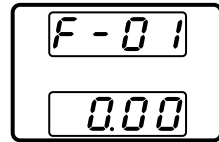

3. Rotate the Voltage knob to change the F setting to F-89 (Show Version).

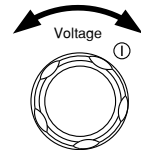

4. Rotate the Current knob to view the version and build date for the various items.

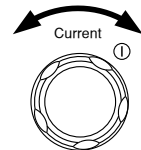

- F-89
 - 0-XX: Main Program Version
 - 1-XX: Main Program Version
 - 2-XX: Main Program Build On-Year.
 - 3-XX: Main Program Build On-Year.
 - 4-XX: Main Program Build On-Month.
 - 5-XX: Main Program Build On-Day.
 - 6-XX: Keyboard CPLD version.
 - 7-XX: Keyboard CPLD version.
 - 8-XX: Analog CPLD version.
 - 9-XX: Analog CPLD version.
 - A-XX: Reserved.
 - B-XX: Reserved.
 - C-XX: Kernel Build On-Year.
 - D-XX: Kernel Build On-Year.
 - E-XX: Kernel Build On-Month.
 - F-XX: Kernel Build On-Day.

5. Press the Function key again to exit. The function key light will turn off.



Example

Kernel Version: 2014/08/03

- C-20: Kernel Build On-Year.
- D-14: Kernel Build On-Year.
- E-08: Kernel Build On-Month.
- F-03: Kernel Build On-Day.

MAINTENANCE

The 2260B power supply filters should be replaced on a periodic schedule to maintain performance and specification characteristics.

Replacing the Dust Filter 170

Replacing the Dust Filter

The dust filter should be replaced at least 2 times a year. Not replacing the filter on a regular basis will reduce performance and may cause the unit to overheat.

- Front panel filter (all models)
1. Turn the instrument off.
 2. Pull the filter out from the bottom of the front panel.
 3. Replace the filter.
- Side panel filters (720W & 1080W)
1. Lift the side panel up and away from the case.
 2. Remove the filter from the grill and replace with a new filter.

FAQ

- The power supply won't let me change the mode (CV mode ↔ CC mode).
- The OVP voltage is triggered earlier than expected.
- Can I combine more than 1 cable together for the output wiring?
- The accuracy does not match the specification.

The power supply won't let me change the mode (CV mode ↔ CC mode).

To set the power supply to CC or CV mode, the Function key must be held when the power is turned on to enter the Power On Configuration Mode. See page 120.

The OVP voltage is triggered earlier than expected.

When setting the OVP voltage, take into account the voltage drop from the load cables. As the OVP level is set from the output terminals and not the load terminals, the voltage at the load terminals may be slightly lower.

Can I combine more than 1 cable together for the output wiring?

Yes. Cables can be used together (in parallel) if the current capacity of a single cable is insufficient. However the withstand voltage should also be taken into account. Ensure the cables are twisted together and are the same length.

The accuracy does not match the specification.

Make sure the device is powered On for at least 30 minutes, within +20°C~+30°C. This is necessary to stabilize the unit to match the specification.

For more information, contact your local Tektronix-Keithley representative.

APPENDIX

2260B Default Settings

The following default settings are the factory configuration settings for the power supply (Function settings/Test settings).

For details on how to return to the factory default settings, see page 56.

Initial Settings	Default Setting	
Output	Off	
LOCK	0 (Disabled)	
Voltage	0V	
Current	0A	
OVP	Maximum	
OCP	Maximum	
Normal Function Settings	Setting	Default Setting
Output ON delay time	F-01	0.00s
Output OFF delay time	F-02	0.00s
V-I mode slew rate select	F-03	0 = CV high speed priority
Rising voltage slew rate	F-04	60.00V/s (2260B-30-XX)
		160.0V/s (2260B-80-XX)
		500.0V/s (2260B-250-XX)
		1600V/s (2260B-800-XX)
Falling voltage slew rate	F-05	60.00V/s (2260B-30-XX)
		160.0V/s (2260B-80-XX)
		500.0V/s (2260B-250-XX)
		1600V/s (2260B-800-XX)

Rising current slew rate	F-06	72.00A/s (2260B-30-36)		
		144.0A/s (2260B-30-72)		
		216.0A/s (2260B-30-108)		
		27.00A/s (2260B-80-13)		
		54.00A/s (2260B-80-27)		
		81.00A/s (2260B-80-40)		
		9.000A/s (2260B-250-4)		
		18.00A/s (2260B-250-9)		
		27.00A/s (2260B-250-13)		
		2.880A/s (2260B-800-1)		
		5.760A/s (2260B-800-2)		
		8.640A/s (2260B-800-4)		
		Falling current slew rate	F-07	72.00A/s (2260B-30-36)
				144.0A/s (2260B-30-72)
216.0A/s (2260B-30-108)				
27.00A/s (2260B-80-13)				
54.00A/s (2260B-80-27)				
81.00A/s (2260B-80-40)				
9.000A/s (2260B-250-4)				
18.00A/s (2260B-250-9)				
27.00A/s (2260B-250-13)				
2.880A/s (2260B-800-1)				
5.760A/s (2260B-800-2)				
8.640A/s (2260B-800-4)				
Internal resistance setting	F-08			0.000Ω
Bleeder circuit control	F-09			1 = ON
Buzzer ON/OFF control	F-10	1 = ON		
Measurement Average Setting	F-17	0 = Low		
Lock Mode	F-19	0 = Panel lock: allow output off		
USB/GPIB setting				
Rear Panel USB Mode	F-22	2 = USB CDC, Auto Detect Speed		
GPIB address	F-23	8		
LAN setting				
LAN	F-36	1 = Enable		
DHCP	F-37	1 = Enable		
Sockets active	F-57	1 = Enable		
Web Server active	F-59	1 = Enable		
Web password active	F-60	1 = Enable		

Web setting password	F-61	0000
Power On Configuration		
CV Control	F-90	0= Panel control (local)
CC Control	F-91	0= Panel control (local)
Power-ON Output	F-92	0 = OFF at startup
Master/Slave	F-93	0 = Master/Local
External Out Logic	F-94	0= High ON
Power Switch trip	F-95	0 = Enable

Error Messages & Messages

The following error messages or messages may appear on the 2260B screen during operation.

Error Messages	Description
Err 001	USB Mass Storage is not present
Err 002	No (such)file in USB mass storage
Err 003	Empty memory location
Err 004	File access error
 Note	For error messages other than Err 001 to Err 004, please contact your distributor for service repair.
Messages	Description
MSG 001	External control of output. Output off (F-94=0, High=on)
MSG 002	External control of output. Output off (F-94=1, Low=on)
MSG 003	F-93 is not zero. Unable to calibrate.

LED Display Format

Use the following table to read the LED display messages.

0	1	2	3	4	5	6	7	8	9	A	B	C	D
0	1	2	3	4	5	6	7	8	9	A	b	C	d
E	F	G	H	I	J	K	L	M	N	O	P	Q	R
E	F	G	H	I	J	K	L	M	N	O	P	Q	r
S	T	U	V	W	X	Y	Z	()	+	-	,	
S	t	U	V	W	X	Y	Z	()	+	-	,	

2260B Specifications

The specifications apply when the 2260B is powered on for at least 30 minutes.

2260B 360W

2260B-30-36, 2260B-80-13, 2260B-250-4, 2260B-800-1

Model	Unit	2260B-30-36	2260B-80-13	2260B-250-4	2260B-800-1
Rated Output Voltage	V	30	80	250	800
Rated Output Current	A	36	13.5	4.5	1.44
Rated Output Power	W	360	360	360	360
Power Ratio	--	3	3	3.125	3.2
Constant Voltage Mode					
Line Regulation (*1)	mV	18	43	128	403
Load Regulation (*2)	mV	20	45	130	405
Ripple and Noise (*3)					
p-p (*4)	mV	60	60	80	150
r.m.s (*5)	mV	7	7	15	30
Temperature coefficient	ppm/°C	100ppm/°C of rated output voltage, after a 30 minute warm-up.			
Remote sense compensation voltage (single wire)	V	0.6	0.6	1	1
Rise Time (*6)					
Rated Load	ms	50	50	100	150
No Load	ms	50	50	100	150
Fall Time (*7)					
Rated Load	ms	50	50	150	300
No Load	ms	500	500	1200	2000
Transient response time (*8)	ms	1	1	2	2
Constant Current Mode					
Line regulation (*1)	mA	41	18.5	9.5	6.44
Load regulation (*9)	mA	41	18.5	9.5	6.44
Ripple and noise					
r.m.s (*5)	mA	72	27	10	5
Temperature coefficient	ppm/°C	200ppm/°C of rated output current, after a 30 minute warm-up.			

Protection Function						
Over voltage protection (OVP)						
Setting range	V	3-33	8-88	20-275	20-880	
Setting accuracy		± (2% of rated output voltage)				
Over current protection (OCP)						
Setting range	A	3.6-39.6	1.35-14.85	0.45-4.95	0.144-1.584	
Setting accuracy		± (2% of rated output current)				
Over temperature protection (OTP)						
Operation	Turn the output off.					
Low AC input protection (AC-FAIL)						
Operation	Turn the output off.					
Power limit (POWER LIMIT)						
Operation	Over power limit.					
Value (fixed)	Approx. 105% of rated output power					
Analog Programming and Monitoring						
External voltage control output voltage at 23°C±5°C	Accuracy and linearity: ±0.5% of rated output voltage.					
External voltage control output current at 23°C±5°C	Accuracy and linearity: ±1% of rated output current.					
External resistor control output voltage at 23°C±5°C	Accuracy and linearity: ±1.5% of rated output voltage.					
External resistor control output current at 23°C±5°C	Accuracy and linearity: ±1.5% of rated output current.					
Output voltage monitor at 23°C±5°C						
Accuracy	%	±1	±1	±2	±2	
Output current monitor at 23°C±5°C						
Accuracy	%	±1	±1	±2	±2	
Shutdown control	Turns the output off with a LOW (0V to 0.5V) or short-circuit.					
Output on/off control	Possible logic selections: Turn the output on using a LOW (0V to 0.5V) or short-circuit, turn the output off using a HIGH (4.5V to 5V) or open-circuit. Turn the output on using a HIGH (4.5V to 5V) or open-circuit, turn the output off using a LOW (0V to 0.5V) or short-circuit.					

CV/CC/ALM/PWR ON/OUT ON indicator	Photocoupler open collector output; Maximum voltage 30V, maximum sink current 8mA.
--------------------------------------	--

Front Panel						
Display, 4 digits						
Voltage accuracy at 23°C±5°C; ±(0.1% +)						
mV	20	20	200	400		
Current accuracy at 23°C±5°C; ±(0.1% +)						
mA	40	20	5	2		
Indications						
GREEN LED's: CV, CC, VSR, ISR, DLY, RMT, 20, 40, 60, 80, 100, %W, W, V, A						
RED LED's: ALM						
Buttons						
Function, OVP/OCP, Set, Test, Lock/Local, PWR DSPL, Output						
Knobs						
Voltage, Current						
USB port						
Type A USB connector						
Programming and Measurement (USB, LAN, GPIB)						
Output voltage programming accuracy at 23°C±5°C; ±(0.1% +)						
mV	10	10	200	400		
Output current programming accuracy at 23°C±5°C; ±(0.1% +)						
mA	30	10	5	2		
Output voltage programming resolution						
mV	1	2	5	14		
Output current programming resolution						
mA	1	1	1	1		
Output voltage measurement accuracy at 23°C±5°C; ±(0.1% +)						
mV	10	10	200	400		
Output current measurement accuracy at 23°C±5°C; ±(0.1% +)						
mA	30	10	5	2		
Output voltage measurement resolution						
mV	1	2	5	14		
Output current measurement resolution						
mA	1	1	1	1		
Series and Parallel Capability						
Parallel number						
Units	3	3	3	3		
Series Number						
Units	2	2	None	None		
Input Characteristics						
Nominal input rating						
100Vac to 240Vac, 50Hz to 60Hz, single phase						
Input voltage range						
85Vac ~ 265Vac						
Input voltage range						
47Hz ~ 63Hz						
Maximum input current						
100Vac	A	5				

200Vac	A	2.5				
Inrush current		Less than 25A.				
Maximum input power	VA	500				
Power factor						
100Vac		0.99				
200Vac		0.97				
Efficiency						
100Vac	%	77	78	79	80	
200Vac	%	79	80	81	82	
Hold-up time		20ms or greater				
Interface Capabilities						
USB		TypeA: Host, TypeB: Slave, Speed: 1.1/2.0, USB Class: CDC(Communications Device Class)				
LAN		MAC Address, DNS IP Address, User Password, Gateway IP Address, Instrument IP Address, Subnet Mask				
GPIB		Optional: GUG-001 (GPIB to USB Adapter)				
Environmental Conditions						
Operating temperature		0°C to 50°C				
Storage temperature		-25°C to 70°C				
Operating humidity		20% to 85% RH; No condensation				
Storage humidity		90% RH or less; No condensation				
Altitude		Maximum 2000m				
General Specifications						
Weight (main unit only)	kg	Approx. 3kg				
Dimensions (WxHxD)	mm ³	71×124×350				
Cooling		Forced air cooling by internal fan.				
EMC		Complies with the European EMC directive 2004/108/EC for Class A test and measurement products.				
Safety		Complies with the European Low Voltage Directive 2006/95/EC and carries the CE-marking.				
Withstand voltage		Between input and chassis: No abnormalities at 1500 Vac for 1 minute. Between input and output: No abnormalities at 3000 Vac for 1 minute. Between output and chassis: No abnormalities at 500 Vdc for 1 minute for 30V and 80V models. No abnormalities at 1500 Vdc for 1 minute for 250V, 800V models.				

Insulation resistance	Between input and chassis: 500 Vdc, 100M Ω or more
	Between input and output: 500 Vdc, 100M Ω or more
	Between output and chassis: 500 Vdc, 100M Ω or more for 30V, 80V and 250V models.
	1000Vdc, 100M Ω or more for 800V models.

*1: At 85 ~ 132Vac or 170 ~ 265Vac, constant load.

*2: From No-load to Full-load, constant input voltage. Measured at the sensing point in Remote Sense.

*3: Measure with JEITA RC-9131B (1:1) probe

*4: Measurement frequency bandwidth is 10Hz to 20MHz.

*5: Measurement frequency bandwidth is 5Hz to 1MHz.

*6: From 10% to 90% of rated output voltage, with rated resistive load.

*7: From 90% to 10% of rated output voltage, with rated resistive load.

*8: Time for output voltage to recover within 0.1% + 10mV of its rated output for a load change from 50 to 100% of its rated output current.

*9: For load voltage change, equal to the unit voltage rating, constant input voltage.

2260B 720W

2260B-30-72, 2260B-80-27, 2260B-250-9, 2260B-800-2

Model	Unit	2260B-30-72	2260B-80-27	2260B-250-9	2260B-800-2
Rated Output Voltage	V	30	80	250	800
Rated Output Current	A	72	27	9	2.88
Rated Output Power	W	720	720	720	720
Power Ratio	--	3	3	3.125	3.2
Constant Voltage Mode					
Line Regulation (*1)	mV	18	43	128	403
Load Regulation (*2)	mV	20	45	130	405
Ripple and Noise (*3)					
p-p (*4)	mV	80	80	100	200
r.m.s (*5)	mV	11	11	15	30
Temperature coefficient	ppm/°C	100ppm/°C of rated output voltage, after a 30 minute warm-up.			
Remote sense compensation voltage (single wire)	V	0.6	0.6	1	1
Rise Time (*6)					
Rated Load	ms	50	50	100	150
No Load	ms	50	50	100	150
Fall Time (*7)					
Rated Load	ms	50	50	150	300
No Load	ms	500	500	1200	2000
Transient response time (*8)	ms	1	1	2	2
Constant Current Mode					
Line regulation (*1)	mA	77	32	14	7.88
Load regulation (*9)	mA	77	32	14	7.88
Ripple and noise					
r.m.s (*5)	mA	144	54	20	10
Temperature coefficient	ppm/°C	200ppm/°C of rated output current, after a 30 minute warm-up.			
Protection Function					
Over voltage protection (OVP)					
Setting range	V	3-33	8-88	20-275	20-880
Setting accuracy		± (2% of rated output voltage)			
Over current protection (OCP)					

Setting range	A				0.288-
		5-79.2	2.7-29.7	0.9-9.9	3.168
Setting accuracy		± (2% of rated output current)			
Over temperature protection (OTP)					
Operation		Turn the output off.			
Low AC input protection (AC-FAIL)					
Operation		Turn the output off.			
Power limit (POWER LIMIT)					
Operation		Over power limit.			
Value (fixed)		Approx. 105% of rated output power			
Analog Programming and Monitoring					
External voltage control output voltage at 23°C±5°C		Accuracy and linearity: ±0.5% of rated output voltage.			
External voltage control output current at 23°C±5°C		Accuracy and linearity: ±1% of rated output current.			
External resistor control output voltage at 23°C±5°C		Accuracy and linearity: ±1.5% of rated output voltage.			
External resistor control output current at 23°C±5°C		Accuracy and linearity: ±1.5% of rated output current.			
Output voltage monitor at 23°C±5°C					
Accuracy	%	±1	±1	±2	±2
Output current monitor at 23°C±5°C					
Accuracy	%	±1	±1	±2	±2
Shutdown control					
		Turns the output off with a LOW (0V to 0.5V) or short-circuit.			
Output on/off control					
		Possible logic selections: Turn the output on using a LOW (0V to 0.5V) or short-circuit, turn the output off using a HIGH (4.5V to 5V) or open-circuit. Turn the output on using a HIGH (4.5V to 5V) or open-circuit, turn the output off using a LOW (0V to 0.5V) or short-circuit.			
CV/CC/ALM/PWR ON/OUT ON indicator					
		Photocoupler open collector output; Maximum voltage 30V, maximum sink current 8mA.			

Front Panel					
Display, 4 digits					
Voltage accuracy at 23°C±5°C; ±(0.1% +)	mV	20	20	200	400
Current accuracy at 23°C±5°C; ±(0.1% +)	mA	70	40	10	4
Indications	GREEN LED's: CV, CC, VSR, ISR, DLY, RMT, 20, 40, 60, 80, 100, %W, W, V, A RED LED's: ALM				
Buttons	Function, OVP/OCP, Set, Test, Lock/Local, PWR DSPL, Output				
Knobs	Voltage, Current				
USB port	Type A USB connector				
Programming and Measurement (USB, LAN, GPIB)					
Output voltage programm- ing accuracy at 23°C±5°C; ±(0.1% +)	mV	10	10	200	400
Output current programm- ing accuracy at 23°C±5°C; ±(0.1% +)	mA	60	30	10	4
Output voltage programming resolution	mV	1	2	5	14
Output current programming resolution	mA	2	2	1	1
Output voltage measure- ment accuracy at 23°C±5°C; ±(0.1% +)	mV	10	10	200	400
Output current measure- ment accuracy at 23°C±5°C; ±(0.1% +)	mA	60	30	10	4
Output voltage measurement resolution	mV	1	2	5	14
Output current measurement resolution	mA	2	2	1	1
Series and Parallel Capability					
Parallel number	Units	3	3	3	3
Series Number	Units	2	2	None	None
Input Characteristics					
Nominal input rating	100Vac to 240Vac, 50Hz to 60Hz, single phase				
Input voltage range	85Vac ~ 265Vac				
Input voltage range	47Hz ~ 63Hz				
Maximum input current					
100Vac	A	10			

200Vac	A	5				
Inrush current		Less than 50A.				
Maximum input power	VA	1000				
Power factor						
100Vac		0.99				
200Vac		0.97				
Efficiency						
100Vac	%	77	78	79	80	
200Vac	%	79	80	81	82	
Hold-up time		20ms or greater				

Interface Capabilities	
USB	TypeA: Host, TypeB: Slave, Speed: 1.1/2.0, USB Class: CDC(Communications Device Class)
LAN	MAC Address, DNS IP Address, User Password, Gateway IP Address, Instrument IP Address, Subnet Mask
GPIB	Optional: GUG-001 (GPIB to USB Adapter)
Environmental Conditions	
Operating temperature	0°C to 50°C
Storage temperature	-25°C to 70°C
Operating humidity	20% to 85% RH; No condensation
Storage humidity	90% RH or less; No condensation
Altitude	Maximum 2000m
General Specifications	
Weight (main unit only)	kg Approx. 5.3kg
Dimensions (WxHxD)	mm ³ 142×124×350
Cooling	Forced air cooling by internal fan.
EMC	Complies with the European EMC directive 2004/108/EC for Class A test and measurement products.
Safety	Complies with the European Low Voltage Directive 2006/95/EC and carries the CE-marking.
Withstand voltage	Between input and chassis: No abnormalities at 1500 Vac for 1 minute. Between input and output: No abnormalities at 3000 Vac for 1 minute. Between output and chassis: No abnormalities at 500 Vdc for 1 minute for 30V and 80V models. No abnormalities at 1500 Vdc for 1 minute for 250V, 800V models.
Insulation resistance	Between input and chassis: 500 Vdc, 100MΩ or more Between input and output: 500 Vdc, 100MΩ or more Between output and chassis: 500 Vdc, 100MΩ or more for 30V, 80V and 250V models. 1000Vdc, 100MΩ or more for 800V models.

*1: At 85 ~ 132Vac or 170 ~ 265Vac, constant load.

*2: From No-load to Full-load, constant input voltage. Measured at the sensing point in Remote Sense.

- *3: Measure with JEITA RC-9131B (1:1) probe
 - *4: Measurement frequency bandwidth is 10Hz to 20MHz.
 - *5: Measurement frequency bandwidth is 5Hz to 1MHz.
 - *6: From 10% to 90% of rated output voltage, with rated resistive load.
 - *7: From 90% to 10% of rated output voltage, with rated resistive load.
 - *8: Time for output voltage to recover within 0.1% + 10mV of its rated output for a load change from 50 to 100% of its rated output current.
 - *9: For load voltage change, equal to the unit voltage rating, constant input voltage.
-

2260B 1080W

2260B-30-108, 2260B-80-40, 2260B-250-13, 2260B-800-4

Model	Unit	2260B-30-108	2260B-80-40	2260B-250-13	2260B-800-4
Rated Output Voltage	V	30	80	250	800
Rated Output Current	A	108	40.5	13.5	4.32
Rated Output Power	W	1080	1080	1080	1080
Power Ratio	--	3	3	3.125	3.2
Constant Voltage Mode					
Line Regulation (*1)	mV	18	43	128	403
Load Regulation (*2)	mV	20	45	130	405
Ripple and Noise (*3)					
p-p (*4)	mV	100	100	120	200
r.m.s (*5)	mV	14	14	15	30
Temperature coefficient	ppm/°C	100ppm/°C of rated output voltage, after a 30 minute warm-up.			
Remote sense compensation voltage (single wire)	V	0.6	0.6	1	1
Rise Time (*6)					
Rated Load	ms	50	50	100	150
No Load	ms	50	50	100	150
Fall Time (*7)					
Rated Load	ms	50	50	150	300
No Load	ms	500	500	1200	2000
Transient response time (*8)	ms	1	1	2	2
Constant Current Mode					
Line regulation (*1)	mA	113	45.5	18.5	9.32
Load regulation (*9)	mA	113	45.5	18.5	9.32
Ripple and noise					
r.m.s (*5)	mA	216	81	30	15
Temperature coefficient	ppm/°C	200ppm/°C of rated output current, after a 30 minute warm-up.			

Protection Function						
Over voltage protection (OVP)						
Setting range	V	3-33	8-88	20-275	20-880	
Setting accuracy		± (2% of rated output voltage)				
Over current protection (OCP)						
Setting range						0.432-
	A	5-118.8	4.05-44.55	1.35-14.85	4.752	
Setting accuracy		± (2% of rated output current)				
Over temperature protection (OTP)						
Operation	Turn the output off.					
Low AC input protection (AC-FAIL)						
Operation	Turn the output off.					
Power limit (POWER LIMIT)						
Operation	Over power limit.					
Value (fixed)	Approx. 105% of rated output power					
Analog Programming and Monitoring						
External voltage control output voltage at 23°C±5°C	Accuracy and linearity: ±0.5% of rated output voltage.					
External voltage control output current at 23°C±5°C	Accuracy and linearity: ±1% of rated output current.					
External resistor control output voltage at 23°C±5°C	Accuracy and linearity: ±1.5% of rated output voltage.					
External resistor control output current at 23°C±5°C	Accuracy and linearity: ±1.5% of rated output current.					
Output voltage monitor at 23°C±5°C						
Accuracy	%	±1	±1	±2	±2	
Output current monitor at 23°C±5°C						
Accuracy	%	±1	±1	±2	±2	
Shutdown control						
	Turns the output off with a LOW (0V to 0.5V) or short-circuit.					
Output on/off control						
	Possible logic selections: Turn the output on using a LOW (0V to 0.5V) or short-circuit, turn the output off using a HIGH (4.5V to 5V) or open-circuit. Turn the output on using a HIGH (4.5V to 5V) or open-circuit, turn the output off using a LOW (0V to 0.5V) or short-circuit.					

CV/CC/ALM/PWR ON/OUT ON indicator	Photocoupler open collector output; Maximum voltage 30V, maximum sink current 8mA.				
Front Panel					
Display, 4 digits					
Voltage accuracy at 23°C±5°C; ±(0.1% +)	mV	20	20	200	400
Current accuracy at 23°C±5°C; ±(0.1% +)	mA	100	50	20	6
Indications	GREEN LED's: CV, CC, VSR, ISR, DLY, RMT, 20, 40, 60, 80, 100, %W, W, V, A RED LED's: ALM				
Buttons	Function, OVP/OCP, Set, Test, Lock/Local, PWR DSPL, Output				
Knobs	Voltage, Current				
USB port	Type A USB connector				
Programming and Measurement (USB, LAN, GPIB)					
Output voltage programm- ing accuracy at 23°C±5°C; ±(0.1% +)	mV	10	10	200	400
Output current programm- ing accuracy at 23°C±5°C; ±(0.1% +)	mA	100	40	15	6
Output voltage programming resolution	mV	1	2	5	14
Output current programming resolution	mA	3	3	1	1
Output voltage measure- ment accuracy at 23°C±5°C; ±(0.1% +)	mV	10	10	200	400
Output current measure- ment accuracy at 23°C±5°C; ±(0.1% +)	mA	100	40	15	6
Output voltage measurement resolution	mV	1	2	5	14
Output current measurement resolution	mA	3	3	1	1
Series and Parallel Capability					
Parallel number	Units	3	3	3	3
Series Number	Units	2	2	None	None

Input Characteristics					
Nominal input rating	100Vac to 240Vac, 50Hz to 60Hz, single phase				
Input voltage range	85Vac ~ 265Vac				
Input voltage range	47Hz ~ 63Hz				
Maximum input current					
100Vac	A	15			
200Vac	A	7.5			
Inrush current	Less than 75A.				
Maximum input power	VA	1500			
Power factor					
100Vac	0.99				
200Vac	0.97				
Efficiency					
100Vac	%	77	78	79	80
200Vac	%	79	80	81	82
Hold-up time	20ms or greater				
Interface Capabilities					
USB	TypeA: Host, TypeB: Slave, Speed: 1.1/2.0, USB Class: CDC(Communications Device Class)				
LAN	MAC Address, DNS IP Address, User Password, Gateway IP Address, Instrument IP Address, Subnet Mask				
GPIB	Optional: GUG-001 (GPIB to USB Adapter)				
Environmental Conditions					
Operating temperature	0°C to 50°C				
Storage temperature	-25°C to 70°C				
Operating humidity	20% to 85% RH; No condensation				
Storage humidity	90% RH or less; No condensation				
Altitude	Maximum 2000m				

General Specifications	
Weight (main unit only)	kg Approx. 7.5kg
Dimensions (WxHxD)	mm ³ 214×124×350
Cooling	Forced air cooling by internal fan.
EMC	Complies with the European EMC directive 2004/108/EC for Class A test and measurement products.
Safety	Complies with the European Low Voltage Directive 2006/95/EC and carries the CE-marking.
Withstand voltage	Between input and chassis: No abnormalities at 1500 Vac for 1 minute. Between input and output: No abnormalities at 3000 Vac for 1 minute. Between output and chassis: No abnormalities at 500 Vdc for 1 minute for 30V, 80V models. No abnormalities at 1500 Vdc for 1 minute for 250V, 800V models.
Insulation resistance	Between input and chassis: 500 Vdc, 100MΩ or more Between input and output: 500 Vdc, 100MΩ or more Between output and chassis: 500 Vdc, 100MΩ or more for 30V, 80V and 250V models. 1000Vdc, 100MΩ or more for 800V models.

*1: At 85 ~ 132Vac or 170 ~ 265Vac, constant load.

*2: From No-load to Full-load, constant input voltage. Measured at the sensing point in Remote Sense.

*3: Measure with JEITA RC-9131B (1:1) probe

*4: Measurement frequency bandwidth is 10Hz to 20MHz.

*5: Measurement frequency bandwidth is 5Hz to 1MHz.

*6: From 10% to 90% of rated output voltage, with rated resistive load.

*7: From 90% to 10% of rated output voltage, with rated resistive load.

*8: Time for output voltage to recover within 0.1% + 10mV of its rated output for a load change from 50 to 100% of its rated output current.

*9: For load voltage change, equal to the unit voltage rating, constant input voltage.

2260B Dimensions

360W

2260B-80-13/2260B-30-36 (scale: mm)

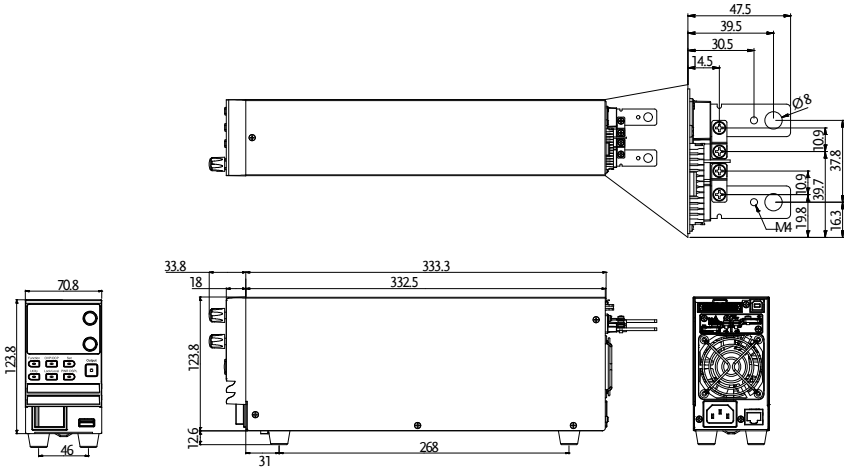

360W

2260B-250-4/2260B-800-1 (scale: mm)

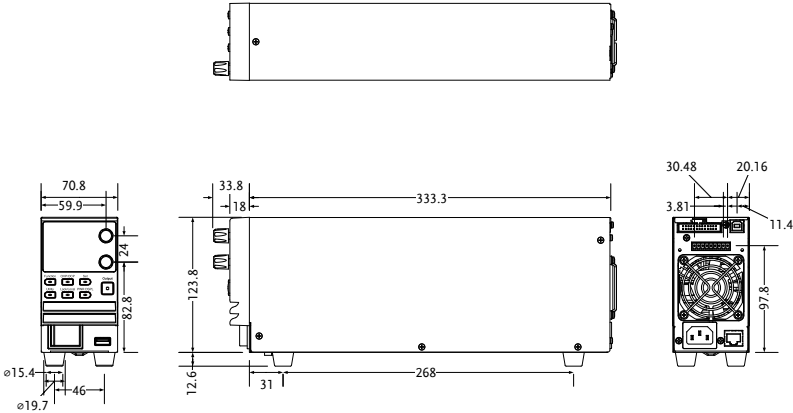

720W

2260B-80-27/2260B-30-72 (scale: mm)

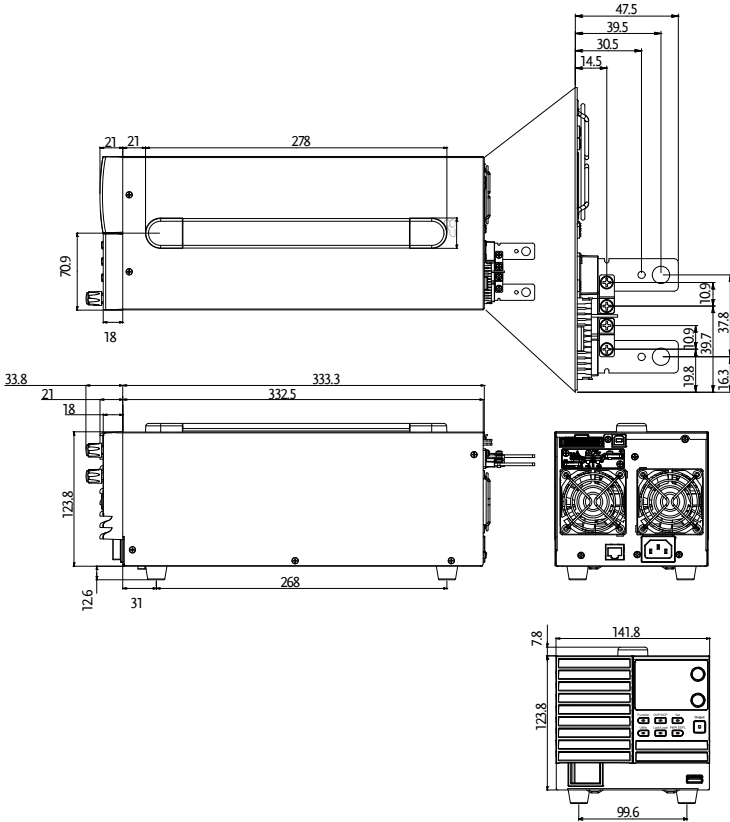

720W

2260B-250-9/2260B-800-2 (scale: mm)

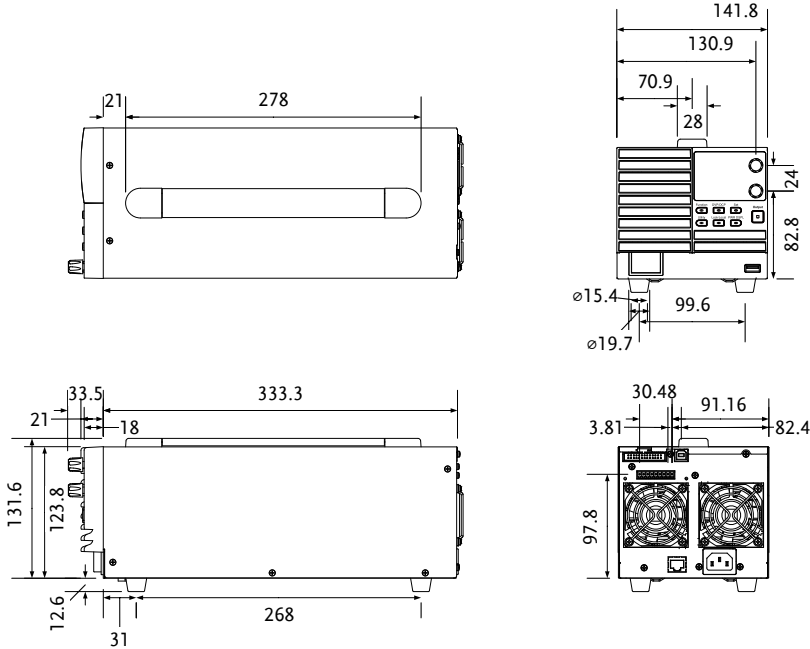

1080W

2260B-80-40/2260B-30-108 (scale: mm)

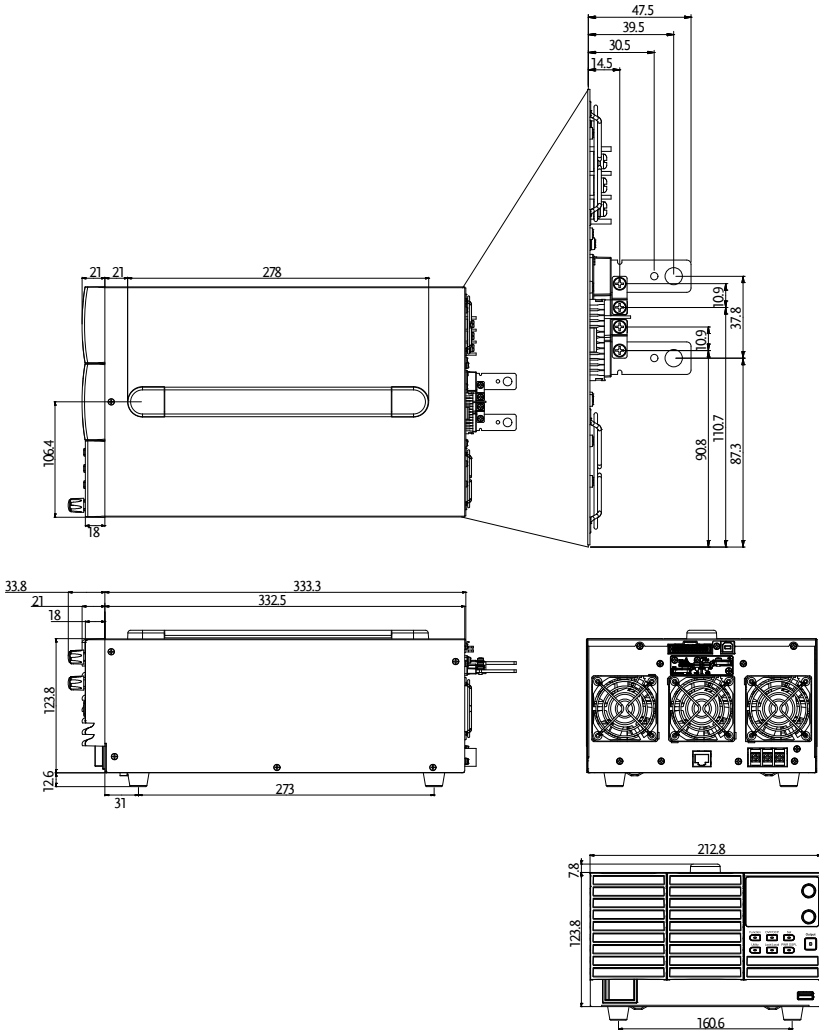

1080W

2260B-250-13/2260B-800-4 (scale: mm)

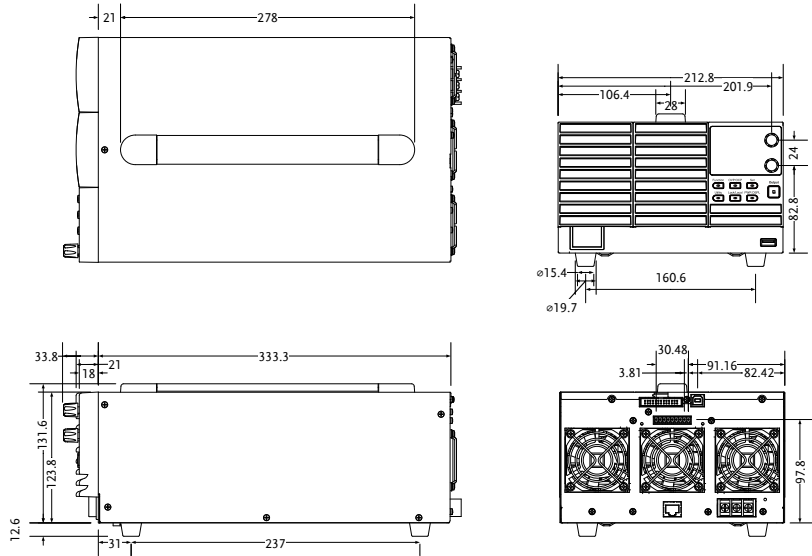

Declaration of Conformity

We declare that the below mentioned product

Type of Product: Multi-Range DC Power Supply

Model Number: 2260B-30-36, 2260B-80-13, 2260B-30-72, 2260B-80-27, 2260B-30-108, 2260B-80-40, 2260B-250-4, 2260B-800-1, 2260B-250-9, 2260B-800-2, 2260B-250-13, 2260B-800-4

are herewith confirmed to comply with the requirements set out in the Council Directive on the Approximation of the Law of Member States relating to Electromagnetic Compatibility (2004/108/EC) and Low Voltage Directive (2006/95/EC).

For the evaluation regarding the Electromagnetic Compatibility and Low Voltage Directive, the following standards were applied:

⊙ EMC	
EN 61326-1: EN 61326-2-1:	Electrical equipment for measurement, control and laboratory use -- EMC requirements (2006)
Conducted & Radiated Emission EN 55011: 2009+A1:2010	Electrostatic Discharge EN 61000-4-2: 2009
Current Harmonics EN 61000-3-2: 2006+A1: 2009+A2: 2009	Radiated Immunity EN 61000-4-3: 2006+A1:2008+A2:2010
Voltage Fluctuations EN 61000-3-3: 2008	Electrical Fast Transients IEC 61000-4-4: 2004+A1:2010
-----	Surge Immunity EN 61000-4-5: 2006
-----	Conducted Susceptibility EN 61000-4-6: 2009
-----	Power Frequency Magnetic Field EN 61000-4-8: 2010
-----	Voltage Dip/ Interruption EN 61000-4-11: 2004

Low Voltage Equipment Directive 2006/95/EC	
Safety Requirements	EN 61010-1: 2010 EN 61010-2-030: 2010

INDEX

- Accessories 13
- Alarm
 - description.....32
- Analog connector
 - pin assignment.....123
- Analog control
 - output control134
 - overview122
 - remote monitoring.....139
 - resistance control – current
 - output.....132
 - resistance control – voltage
 - output.....130
 - shutdown control137
 - status monitoring.....141
 - voltage control – current output128
 - voltage control – voltage output125
- Bleeder control
 - Description.....30
- Build date
 - view.....57, 162, 167
- Caution symbol..... 5
- CC and CV mode
 - description.....28
- CC mode
 - operation.....66
- Cleaning the instrument 7
- Configuration
 - calibration settings.117
 - LAN settings114
 - Normal function settings.....108
 - normal function settings
 - operation..... 118, 159, 164
 - overview103
 - power on configuration operation120
 - power on configuration settings.116
 - System settings115
 - table.....103
 - test sequence settings.....94
- USB/GPIB settings113
- utility function settings 95
- Connector plug manufacturer23, 49
- Conventions.....54
- CV mode
 - operation..... 63
- DECA SwitchLab 23, 49
- Declaration of conformity200
- Default settings173
- reset..... 56
- Dimensions
 - diagram194
- Display format.....176
- Display mode
 - operation..... 69
- Disposal instructions7
- EN61010
 - measurement category 6
 - pollution degree7
- Environment
 - safety instruction.....7
- Error messages176
- test sequences100
- Ethernet
 - interface.....147
 - sockets148
 - web server.....147
- FAQ.....171
- Filter installation42
- Front panel diagram18
- Ground
 - symbol.....5
- Grounding36
- Internal resistance
 - description 31
- LCD conversion.....176
- Line voltage
 - 2260B 30-108/80-40.5/160-21.6... 40

List of features	12	Operation.....	88
Load connection		overview	84
2260B-250/800	49	Service operation	
2260B-30/80/160	45	about disassembly	6
Maintenance		contact	172
replacing the filter	170	Slew rate	
Marketing		description.....	30
contact.....	172	Socket server function check	149, 153
Messages.....	176	Specifications.....	177
Model differences.....	11	2260B 160-14.4	183
OCP level.....	60	2260B 160-21.6	189
Operating area description	25	2260B 160-7.2	177
Operation considerations	33	2260B 250-13.5	189
floating output.....	36	2260B 250-4.5	177
inrush current	33	2260B 250-9.....	183
Pulsed loads.....	33	2260B 30-108.....	189
reverse current.....	34	2260B 30-36	177
Output connector pinout.....	50	2260B 30-72	183
Output connector wiring.....	50	2260B 800-1.44	177
OVP level.....	60	2260B 800-2.88	183
Package contents	17	2260B 800-4.32	189
Panel lock	70	2260B 80-13.5	177
Parallel mode		2260B 80-27	183
connection	79	2260B 80-40.5	189
operation	81	System version	
overview.....	76	view	57, 162, 167
Power on/off		Terminal cover	
safety instruction.....	24	2260B-30/80/160.....	47
Power up	43	Test sequence	
Rack mount		error messages.....	100
description	54	Export.....	98
Rear panel diagram.....	21	Load.....	96
Remote control.....	144	remove/delete test sequence.....	99
interface configuration	145	Run	97
Remote sense		UK power cord.....	8
connection	74	USB driver version	
operation	71	view	57, 162, 167
Series mode		Warning symbol	5
connection.....	86	Web server function check	152
		Wire gauge chart.....	44

Specifications are subject to change without notice.
All Keithley trademarks and trade names are the property of Keithley Instruments, Inc.
All other trademarks and trade names are the property of their respective companies.

Keithley Instruments, Inc.

Corporate Headquarters • 28775 Aurora Road • Cleveland, Ohio 44139 • 440-248-0400 • Fax: 440-248-6168 • 1-888-KEITHLEY • www.keithley.com



A Greater Measure of Confidence