

Keysight N2820/1A High-Sensitivity Current Probes

User's Guide

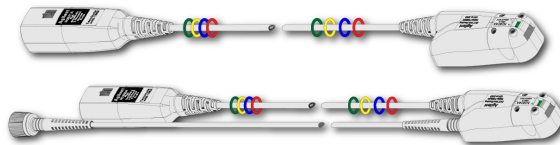

Notices

© Keysight Technologies 2014, 2016-2019

No part of this manual may be reproduced in any form or by any means (including electronic storage and retrieval or translation into a foreign language) without prior agreement and written consent from Keysight Technologies, Inc. as governed by United States and international copyright laws.

Manual Part Number

N2820-97007

Edition

November 2019

Available in electronic format only

Published by:

Keysight Technologies
1900 Garden of the Gods Road
Colorado Springs, CO 80907 USA

Warranty

The material contained in this document is provided "as is," and is subject to being changed, without notice, in future editions. Further, to the maximum extent permitted by applicable law, Keysight disclaims all warranties, either express or implied, with regard to this manual and any information contained herein, including but not limited to the implied warranties of merchantability and fitness for a particular purpose. Keysight shall not be liable for errors or for incidental or consequential damages in connection with the furnishing, use, or performance of this document or of any information contained herein. Should Keysight and the user have a separate written agreement with warranty terms covering the material in this document that conflict with these terms, the warranty terms in the separate agreement shall control.

Technology Licenses

The hardware and/or software described in this document are furnished under a license and may be used or copied only in accordance with the terms of such license.

U.S. Government Rights

The Software is "commercial computer software," as defined by Federal Acquisition Regulation ("FAR") 2.101. Pursuant to FAR 12.212 and 27.405-3 and Department of Defense FAR Supplement ("DFARS") 227.7202, the U.S. government acquires commercial computer software under the same terms by which the software is customarily provided to the public. Accordingly, Keysight provides the Software to U.S. government customers under its standard commercial license, which is embodied in its End User License Agreement (EULA), a copy of which can be found at <http://www.keysight.com/find/sweula>. The license set forth in the EULA represents the exclusive authority by which the U.S. government may use, modify, distribute, or disclose the Software. The EULA and the license set forth therein, does not require or permit, among other things, that Keysight:

(1) Furnish technical information related to commercial computer software or commercial computer software documentation that is not customarily provided to the public; or (2) Relinquish to, or otherwise provide, the government rights in excess of these rights customarily provided to the public to use, modify, reproduce, release, perform, display, or disclose commercial computer software or commercial computer software documentation. No additional government requirements beyond those set forth in the EULA shall apply, except to the extent that those terms, rights, or licenses are explicitly required from all providers of commercial computer software pursuant to the FAR and the DFARS and are set forth specifically in writing elsewhere in the EULA. Keysight shall be under no obligation to update, revise or otherwise modify the Software. With respect to any technical data as defined by FAR

2.101, pursuant to FAR 12.211 and 27.404.2 and DFARS 227.7102, the U.S. government acquires no greater than Limited Rights as defined in FAR 27.401 or DFAR 227.7103-5 (c), as applicable in any technical data. 52.227-14 (June 1987) or DFAR 252.227-7015 (b)(2) (November 1995), as applicable in any technical data.

Safety Notices

CAUTION

A **CAUTION** notice denotes a hazard. It calls attention to an operating procedure, practice, or the like that, if not correctly performed or adhered to, could result in damage to the product or loss of important data. Do not proceed beyond a **CAUTION** notice until the indicated conditions are fully understood and met.

WARNING

A **WARNING** notice denotes a hazard. It calls attention to an operating procedure, practice, or the like that, if not correctly performed or adhered to, could result in personal injury or death. Do not proceed beyond a **WARNING** notice until the indicated conditions are fully understood and met.

Contents

- 1 General Information**
 - Introduction 6
 - Accessories 10
 - Inspecting the Probe 12
 - Returning the Probe for Service 13
 - Safety Information 15
 - Instrument Markings and Safety Symbols 19

- 2 Making Measurements**
 - Introduction 22
 - Quick Start 25
 - To Measure Battery-Powered Devices 33
 - To Measure Charge on an Infiniium Oscilloscope 34
 - To Measure Charge on an InfiniiVision Oscilloscope 36
 - To Simultaneously View Zoomed-In/Zoomed-Out Waveforms 38
 - To Make Measurements Without Interrupting Your DUT 41
 - Extreme Temperature Probing 46
 - Burden Voltage of N2822/4A Probe Heads 47
 - Dynamic Range 49

- 3 Using N2825A Probe Heads**
 - To Manually Identify the R_{SENSE} Resistance 52
 - To Identify the R_{SENSE} Resistance Using a Unique Name 54
 - To Identify the R_{SENSE} Resistance Using an ID Resistor 55
 - To Add a Custom Internal R_{SENSE} Resistor 61

- 4 Probe Calibration**
 - To Calibrate the Probe on Infiniium Oscilloscopes 66
 - To Calibrate the Probe on InfiniiVision Oscilloscopes 70

- 5 Characteristics and Specifications**
 - Current Range Vs. R_{SENSE} Graphs 78
 - Maximum Current Measurement Ranges for Probe Heads 81
 - Dimensions 89

Contents

- 6 Performance Data Plots**
 - N2820A Frequency Response 92
 - N2820A Common Mode Rejection Ratio 94
 - N2820A Step Response 95
 - N2820A Step Tracking 96
 - N2820A Input Impedance 98
 - Input Load Model 99

- 7 Performance Verification**
 - Average Gain of Zoomed-In Channel 103
 - Average Gain of Zoomed-Out Channel 107
 - Performance Test Record 111

1 General Information

Introduction / 6
Accessories / 10
Inspecting the Probe / 12
Returning the Probe for Service / 13
Safety Information / 15
Instrument Markings and Safety Symbols / 19

The N2820A and N2821A high-sensitivity current probes allow you to measure AC and DC currents from 50 μA to 5A. These high dynamic-range probes are designed to be used on devices that have very tight geometry constraints. Since these probes do not need to be degaussed and do not require frequent calibration, you can focus on making your measurements. The probes accurately construct the current waveform by measuring the voltage across either an internal or external DUT-mounted R_{SENSE} resistor, which results in highly repeatable measurements.

CAUTION

Before using the probe, refer to “**Safety Information**” on page 15.

Introduction

The N2820A and N2821A probes are shipped in a case. When you receive the probe, inspect it as described in “Inspecting the Probe” on page 12.

Figure 1 shows the different components of the N2820A and N2821A probes. The N2820A two-channel probe, with its two internal, parallel differential amplifiers, provides simultaneous low and high gain views. The N2821A also includes two amplifiers and its main output can be switched between these two views. Before using an N2820A probe, connect the secondary cable as described in “Quick Start” on page 25. The N2821A single-channel probe looks identical to the N2820A but *does not* include the secondary cable. The accessories provided with the probes are shown in Figure 2 on page 10.

To Clean the Probe

Disconnect the probe from the oscilloscope and clean the probe with a soft cloth dampened with a mild soap and water solution. Make sure that the probe is completely dry before reconnecting it to an oscilloscope.

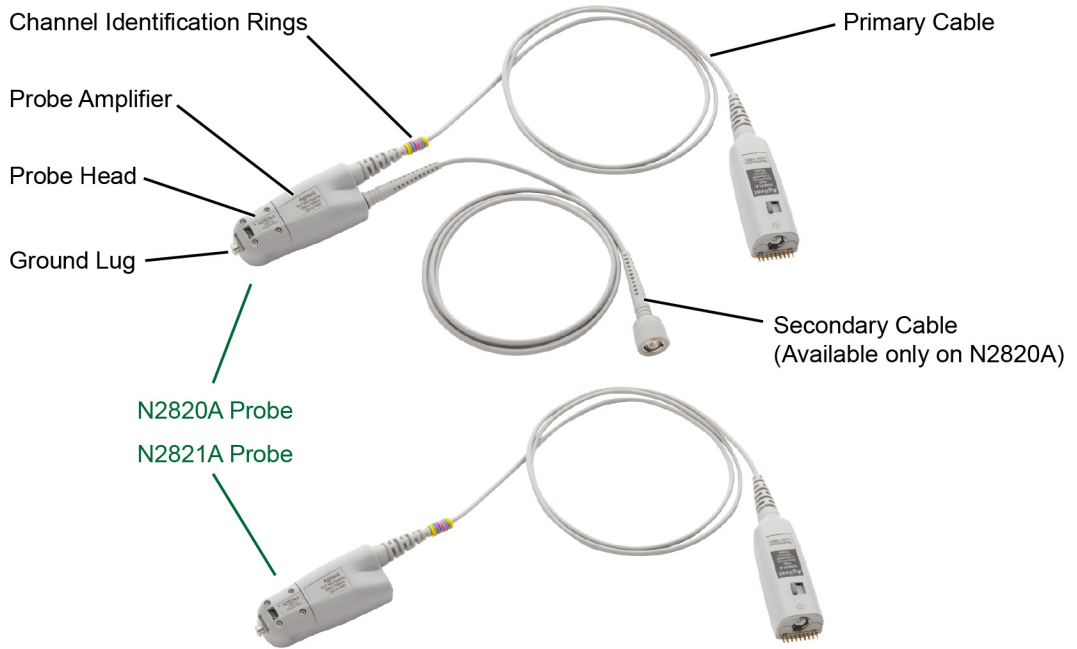

Figure 1 Probe Parts Identification

CAUTION

Probes are ESD sensitive devices, particularly at the probe heads. Follow standard ESD precautions when handling. Remove head accessories when storing the probe.

Oscilloscope Compatibility

The N2820A and N2821A probes are compatible with the Keysight oscilloscopes shown in [Table 1](#). The table also lists the minimum required firmware version for the oscilloscope.

NOTE

The N2820A and N2821A probes are designed for oscilloscopes with 1 M Ω AutoProbe-interface channel inputs.

1 General Information

Introduction

Is Your Oscilloscope Software Up-to-Date?

Keysight periodically releases software updates to support your probe, fix known defects, and incorporate product enhancements. To download the latest firmware:

- either go to www.keysight.com and search for your oscilloscope's topic. Click on the "Drivers, Firmware & Software" tab.
- or use the following links:

<http://www.keysight.com/find/infiniium-sw>

<http://www.keysight.com/find/3000X-Series-sw>

<http://www.keysight.com/find/4000X-Series-sw>

<http://www.keysight.com/find/6000X-Series-sw>

Table 1 Compatible Oscilloscopes with Number of Probes Supported

Oscilloscope	Number of Probes Supported	
	N2820A 2 Channel Probe	N2821A 1 Channel Probe
Infiniium Oscilloscopes (<i>firmware version 4.2 or above</i>)		
S-Series	2 ^a or 4 ^b	4 ^c
9000 H-Series	2 ^a or 4 ^b	4 ^c
9000A-Series	2 ^a or 4 ^b	4 ^c
InfiniiVision Oscilloscopes		
6000 X-Series (firmware version 6.0 or above)	2 or 4 ^b	4 ^c
4000 X-Series (firmware version 3.10 or above)	2 or 4 ^b	4 ^c
3000 X-Series (firmware version 2.30 or above)	2	2 ^d

- a Dual-Grid View available.
- b If secondary cables are *not* connected.
- c On four channel oscilloscope.
- d Maximum of 2 probes on two or four channel oscilloscope.

Infiniium Dual-Grid View

The N2820A probe provides two channel-input cables which allow two simultaneous views of the current waveform: a high-gain zoomed-in and a low-gain zoomed-out view. On Infiniium oscilloscopes, both zoomed-in and zoomed-out waveforms can be simultaneously displayed in *dual-grid view*, where each waveform can be viewed in a different time span. To learn more about dual-grid view, refer to ["To Simultaneously View Zoomed-In/Zoomed-Out Waveforms"](#) on page 38. InfiniiVision oscilloscopes do not support dual-grid views. The zoomed-in channel has 500 kHz bandwidth and the zoomed-out channel has

3 MHz bandwidth. N2821A probes, having only one channel-input cable, do not support the simultaneous display of zoomed-out and zoomed-in views.

NOTE

There is no upgrade available to convert an N2821A (1 channel) probe to an N2820A (2 channel) probe.

Probe Heads

The probe is supplied with the N2822A, N2824A, and N2825A interchangeable R_{SENSE} probe heads. The N2822A and N2824A heads include different R_{SENSE} resistor values. The N2825A user-defined head does *not* include an R_{SENSE} resistor and is selected in situations when you want to use your own R_{SENSE} resistor that you have mounted on your DUT. To learn about configuring and using the heads, refer to [Chapter 2](#), “Making Measurements”.

Make-Before-Break (MBB)
Connectors

Five Make-Before-Break (MBB) connectors are provided with the probes. The MBB connectors allow you to quickly probe multiple locations on your DUT without interrupting the circuit under test. Refer to [“To Make Measurements Without Interrupting Your DUT”](#) on page 41 for more information.

Channel Identification
Rings

When multiple probes are connected to the oscilloscope, use the channel identification rings to associate the channel inputs with each probe. Place one colored ring near the probe’s channel connector and place an identical color ring near the probe head.

1 General Information
Accessories

Accessories

Supplied Accessories The N2820A and N2821A probes come with the accessories shown in Figure 2. To learn how to use these accessories, refer to Chapter 2, “Making Measurements”.

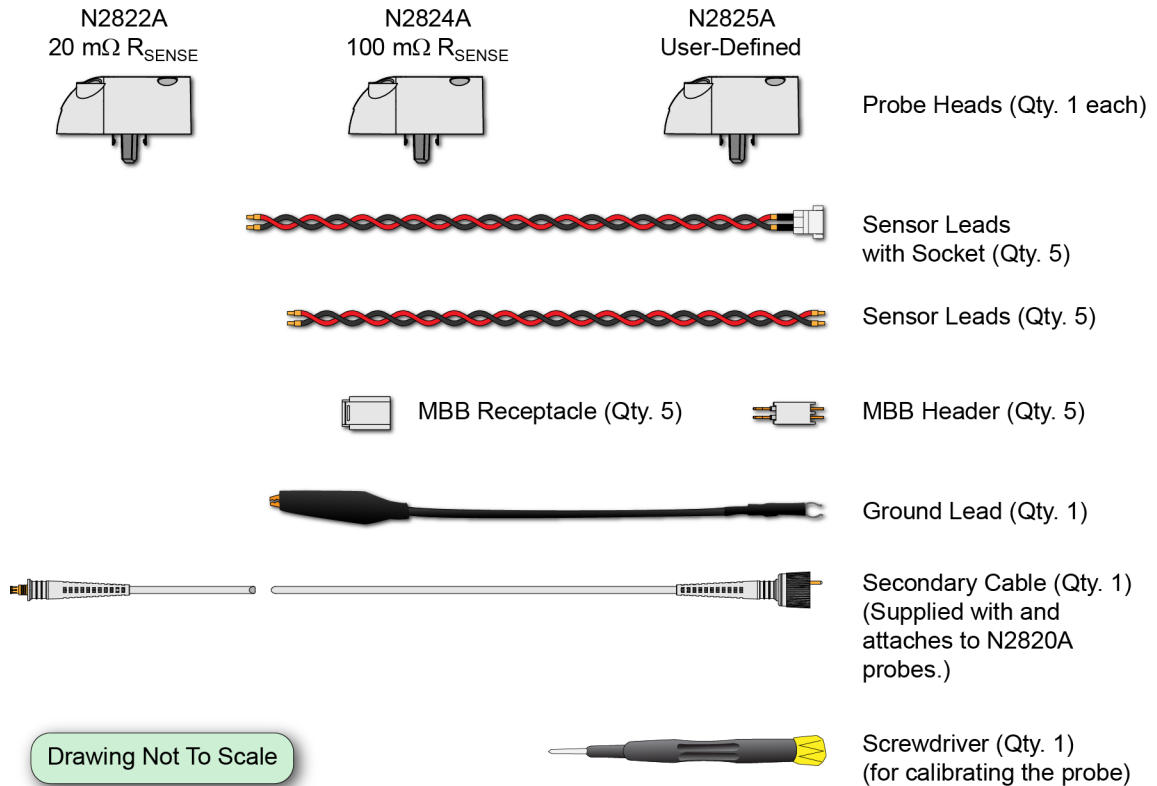

Figure 2 Supplied Accessories

NOTE

To ensure the display of accurate waveforms, *always* connect the supplied ground lead when probing battery-powered devices, such as mobile phones. Refer to **“To Measure Battery-Powered Devices”** on page 33.

Replacement Accessories **Table 2** shows the available replacement accessories and parts.

Table 2 Replacement Accessories

Model Number	Description	Quantity
N2822A	20 mΩ R _{SENSE} Head	1
N2824A	100 mΩ R _{SENSE} Head	1
N2825A	User-defined R _{SENSE} Head	1
N2826A	Replacement unsocketed sensor leads (22 AWG)	5
N2827A	Secondary Cable for use with N2820A probe	1
N2828A	Replacement MBB Headers	5
N2829A	Replacement MBB Receptacles and socketed sensor leads (22 AWG)	5

1 General Information

Inspecting the Probe

Inspecting the Probe

- Inspect the shipping container for damage.
Keep the damaged shipping container or cushioning material until the contents of the shipment have been checked for completeness and the probe has been checked mechanically and electrically.
- Check the accessories.
- If the contents are incomplete or damaged, notify your Keysight Technologies Sales Office.
- Inspect the probe. If there is mechanical damage or defect, or if the probe does not operate properly or pass calibration tests, notify your Keysight Technologies Sales Office.

If the shipping container is damaged, or the cushioning materials show signs of stress, notify the carrier as well as your Keysight Technologies Sales Office. Keep the shipping materials for the carrier's inspection. The Keysight Technologies office will arrange for repair or replacement at Keysight Technologies' option without waiting for claim settlement.

Returning the Probe for Service

If the probe is found to be defective we recommend sending it to an authorized service center for all repair and calibration needs. Perform the following steps before shipping the probe back to Keysight Technologies for service.

- 1 Contact your nearest Keysight sales office for information on obtaining an RMA number and return address.
- 2 Write the following information on a tag and attach it to the malfunctioning equipment.
 - Name and address of owner
 - Product model number (for example, N2820A)
 - Product Serial Number (for example, MYXXXXXXXX)
 - Description of failure or service required

NOTE

Include probing and browsing heads if you feel the probe is not meeting performance specifications or a yearly calibration is requested.

- 3 Protect the probe by wrapping in plastic or heavy paper.
- 4 Pack the probe in the original carrying case or if not available use bubble wrap or packing peanuts.
- 5 Place securely in sealed shipping container and mark container as "FRAGILE".

NOTE

If any correspondence is required, refer to the product by serial number and model number.

Contacting Keysight Technologies

For technical assistance, contact your local Keysight Call Center.

- In the Americas, call 1 (800) 829-4444
- In other regions, visit <http://www.keysight.com/find/assist>

1 General Information

Returning the Probe for Service

Before returning an instrument for service, you must first call the Call Center at 1 (800) 829-4444.

Safety Information



This manual provides information and warnings essential for operating this probe in a safe manner and for maintaining it in safe operating condition. Before using this equipment and to ensure safe operation and to obtain maximum performance from the probe, carefully read and observe the following warnings, cautions, and notes.

This product has been designed and tested in accordance with accepted industry standards, and has been supplied in a safe condition. The documentation contains information and warnings that must be followed by the user to ensure safe operation and to maintain the product in a safe condition.

Note the external markings on the probe that are described in this document.

To avoid personal injury and to prevent fire or damage to this product or products connected to it, review and comply with the following safety precautions. Be aware that if you use this probe assembly in a manner not specified, the protection this product provides may be impaired.

WARNING

Use Only Grounded Instruments.

Do not connect the probe's ground lead to a potential other than earth ground. Always make sure the probe and the oscilloscope are grounded properly.

WARNING

Connect and Disconnect Properly.

Connect the probe to the oscilloscope and connect the ground lead to earth ground before connecting the probe to the circuit under test. Disconnect the probe input and the probe ground lead from the circuit under test before disconnecting the probe from the oscilloscope.

1 General Information Safety Information

WARNING

Observe Probe Ratings.

Do not apply any electrical potential to the probe input which exceeds the maximum rating of the probe. Make sure to comply with the voltage versus frequency derating curve found in this manual.

WARNING

Keep Away From Live Circuits.

Avoid open circuitry. Do not touch connections or components when power is present.

WARNING

Indoor Use Only.

Do not operate in wet/damp environments. Keep product surfaces dry and clean.

WARNING

Do Not Operate With Suspected Failures. Refer to qualified service personnel.

WARNING

Never leave the probe connected to a conductor while it is not connected to an oscilloscope or voltage measuring instrument.

WARNING

Do not use a probe which is cracked, damaged or has defective leads.

WARNING

Do not install substitute parts or perform any unauthorized modification to the probe.

WARNING

Do not operate the probe or oscilloscope in the presence of flammable gasses or fumes. Operation of any electrical instrument in such an environment constitutes a definite safety hazard.

WARNING

Do not use the probe or oscilloscope in a manner not specified by the manufacturer.

WARNING

Service instructions are for trained service personnel. To avoid dangerous electric shock, do not perform any service unless qualified to do so. Do not attempt internal service or adjustment unless another person, capable of rendering first aid and resuscitation, is present.

CAUTION

The probe cable is a sensitive part of the probe and, therefore, you should be careful not to damage it through excessive bending or pulling. Avoid any mechanical shocks to this product in order to guarantee accurate performance and protection.

NOTE

Avoid, if possible, the proximity of other conductors which may create noise.

Concerning the Oscilloscope or Voltage Measuring Instrument to Which the Probe is Connected

WARNING

Whenever it is likely that the ground protection is impaired, you must make the instrument inoperative and secure it against any unintended operation.

WARNING

If you energize the instrument by an auto transformer (for voltage reduction or mains isolation), the ground pin of the input connector terminal must be connected to the earth terminal of the power source.

1 General Information

Safety Information

WARNING

Before turning on the instrument, you must connect the protective earth terminal of the instrument to the protective conductor of the (mains) power cord. The mains plug shall only be inserted in a socket outlet provided with a protective earth contact. You must not negate the protective action by using an extension cord (power cable) without a protective conductor (grounding). Grounding one conductor of a two-conductor outlet is not sufficient protection.







WARNING

Only fuses with the required rated current, voltage, and specified type (normal blow, time delay, etc.) should be used. Do not use repaired fuses or short-circuited fuse holders. To do so could cause a shock or fire hazard.

WARNING

Capacitors inside the instrument may retain a charge even if the instrument is disconnected from its source of supply.

Instrument Markings and Safety Symbols

Symbol	Description
	STANDBY and AC symbols. The STANDBY marks the position of the instrument power line switch. The AC symbol is used to indicate the required nature of the line module input power.
	The CE mark is a registered trademark of the European Community. ISM GRP 1-A denotes the instrument is an Industrial Scientific and Medical Group 1 Class A product. ICES/NMB-001 indicates product compliance with the Canadian Interference-Causing Equipment Standard.
	The CSA mark is a registered trademark of the Canadian Standards Association.
	The C-Tick mark is a registered trademark of the Australian Spectrum Management Agency.
	This product complies with the WEEE Directive (2002/96/EC) marking requirements. The affixed label indicates that you must not discard this electrical/electronic product in domestic household waste. Product Category: With reference to the equipment types in the WEEE Directive Annex I, this product is classed as a “Monitoring and Control instrumentation” product. Do not dispose in domestic household. To return unwanted products, contact your local Keysight office, or refer to www.keysight.com for more information.
	This symbol indicates the Environmental Protection Use Period (EPUP) for the product's toxic substances for the China RoHS requirements.
	Recycle marking.

1 General Information
Instrument Markings and Safety Symbols

2 Making Measurements

Introduction / 22

Quick Start / 25

Step 1. Attach the Sensor Leads / 25

Step 2. Attach the Probe Head / 26

Step 3. Attach the Secondary Cable / 27

Step 4. Connect Probe to Scope / 28

Step 5. Configuring the Probe on Infiniium Oscilloscopes / 29

Step 6. Configuring the Probe on InfiniiVision Oscilloscopes / 31

To Measure Battery-Powered Devices / 33

To Measure Charge on an Infiniium Oscilloscope / 34

To Measure Charge on an InfiniiVision Oscilloscope / 36

To Simultaneously View Zoomed-In/Zoomed-Out Waveforms / 38

To Make Measurements Without Interrupting Your DUT / 41

Extreme Temperature Probing / 46

Burden Voltage of N2822/4A Probe Heads / 47

Dynamic Range / 49

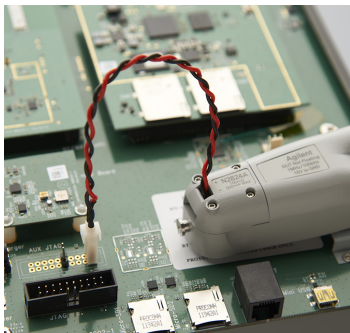

In this chapter, you'll learn how to connect the probe to the oscilloscope and how to perform several measurements. The probe accessories are very flexible and can be configured to match your unique probing requirements regarding convenience versus accuracy.

Refer to [Chapter 3](#), "Using N2825A Probe Heads", for additional information regarding the N2822A, N2824A, and N2825A probe heads.

Introduction

The probes are supplied with three interchangeable R_{SENSE} probe heads: N2822A, N2824A, and N2825A. To begin using the probe, refer to “Quick Start” on page 25. Figure 3 on page 23 illustrates the relative merits of using the three different heads with the different sensor leads.

N2822A and N2824A Probe Heads

The N2822A and N2824A heads include built-in internal R_{SENSE} resistors. Because the oscilloscope recognizes when these probes are connected, the oscilloscope automatically knows the value of the R_{SENSE} resistor when calculating measurements.

Table 3 Description of Heads

Description	N2822A	N2824A
R_{SENSE} Resistor	20 m Ω	100 m Ω
R_{SENSE} Tolerance	$\pm 1\%$	$\pm 1\%$
Maximum Power Dissipation ^a	500 mW	500 mW
Current Range	250 μA to 5A	50 μA to 2.2A
Added Benefit	Smaller voltage drop (lower burden voltage).	For higher sensitivity (ie. lower noise).

a Temperature coefficient is 20 ppm / $^{\circ}\text{C}$

CAUTION

The maximum sensor resistor power rating is 500 mW. The maximum acceptable average current for the N2822A is 5 A_{rms} and N2824A is 2.2 A_{rms} .

N2825A Probe Head

The N2825A user-defined head does *not* include an R_{SENSE} resistor and is selected in situations when you want to use your own external DUT-mounted R_{SENSE} resistor. Chapter 3, “Using N2825A Probe Heads”, provides additional information on using the N2825A head.

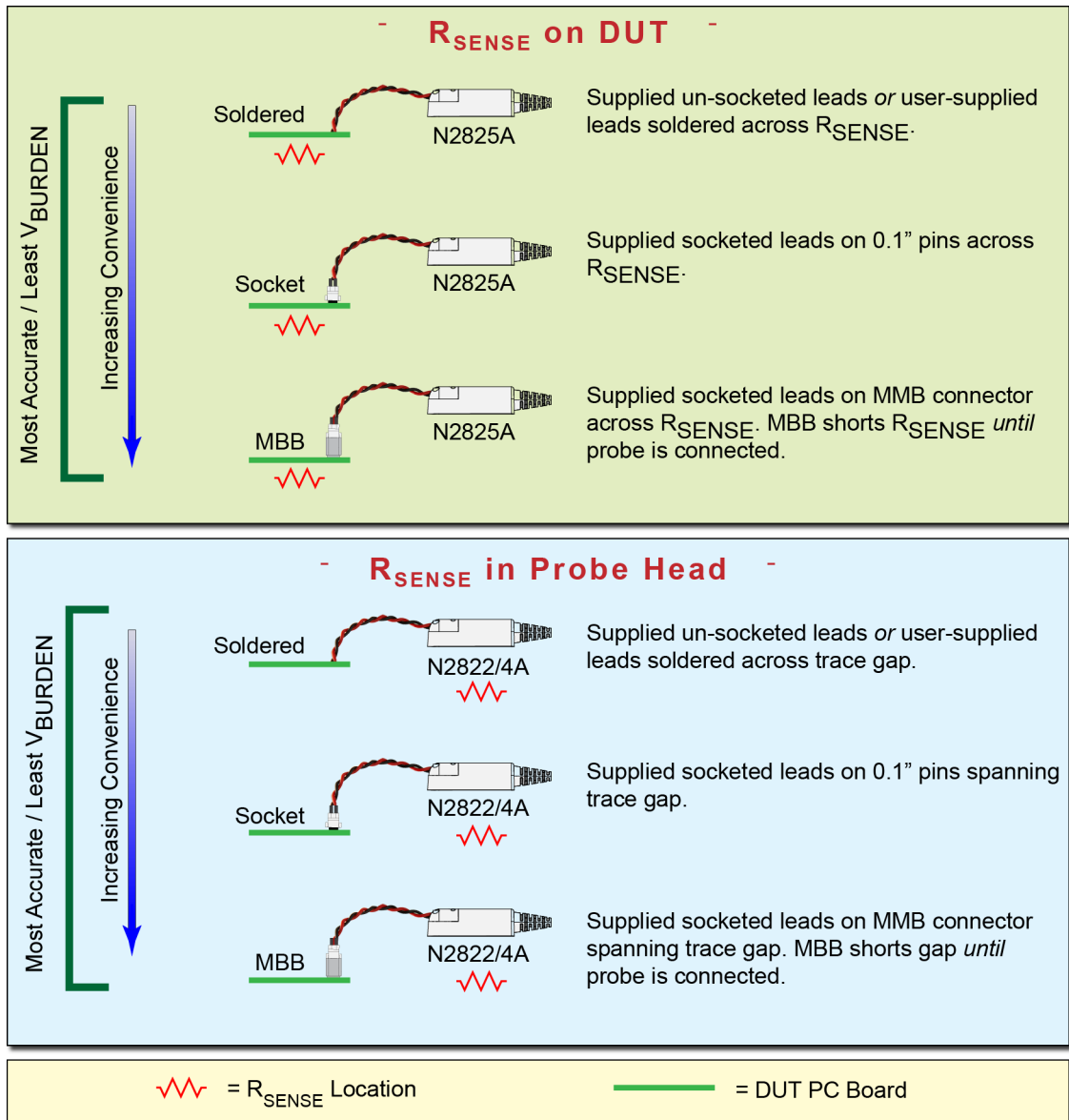

Figure 3 Different Probing Connections With Relative Merit

2 Making Measurements

Introduction

Sensor Leads The probe heads do not come with the sensor leads soldered on them. Instead, you must solder on the appropriate leads as described in “**Quick Start**” on page 25.

CAUTION

Always wear an ESD wrist strap when working with active probes. Not doing so can result in the probe becoming permanently damaged.

Quick Start

Step 1. Attach the Sensor Leads

The probe heads do not come with the leads soldered on them. Instead, you must solder on one of the following types of sensor leads to the probe head.

- Accessory un-socketed leads (22 AWG).
- Accessory socketed leads (22 AWG).
- Your own leads.

The socketed leads are designed to plug directly onto the following items:

- Standard PC board headers with 2.54 mm (0.1") contact-pitch spacing.
- MBB accessory headers mounted on the PC board. You can quickly snap the socketed lead on and off the MBB header. To learn about the MBB accessory, refer to [“To Make Measurements Without Interrupting Your DUT”](#) on page 41.

- 1 Position the sensor leads into the head’s access hole as shown in [Figure 4](#).

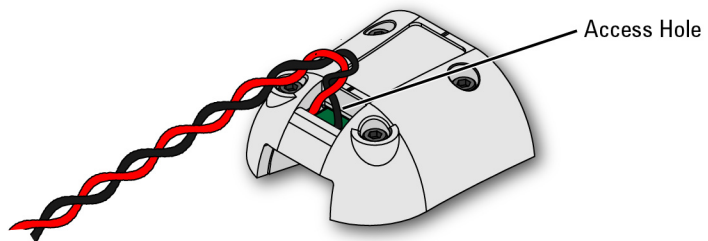

Figure 4 Placing the Leads into the Tip’s Access Hole

- 2 Flip the head as shown in [Figure 5](#) and insert the leads up through the PC board’s solder holes **TP1** and **TP2**. Insert the **RED (+)** lead at TP2 and the **BLACK** lead at TP1. Solder the leads in place.

2 Making Measurements Quick Start

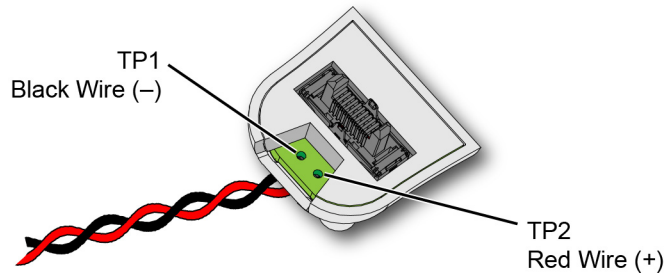

Figure 5 Lead Positions on PC Board

Step 2. Gently press the head into position on the probe amplifier while
Attach the Probe Head carefully mating the connector as shown in [Figure 6](#).

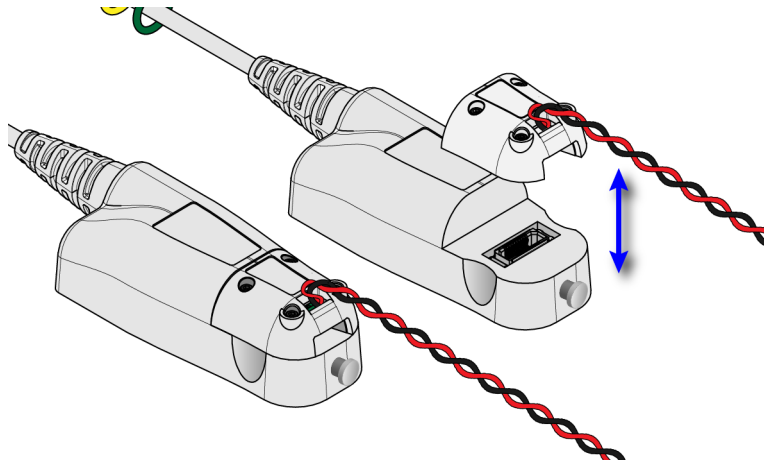

Figure 6 Attaching and Removing a Head from the Probe

NOTE

Never apply excessive force when attaching the head. To remove a head, pull the head straight off the probe in the direction shown.

NOTE

Do not remove the four head screws when removing the head.

NOTE

You can safely change a probe head while the probe is connected to an oscilloscope that is powered on.

CAUTION

If lead wires are attached, do not pull on the wires as this could damage the head.

Step 3.
Attach the Secondary
Cable

This step is for N2820A two-channel probes only. N2821A probes are not designed for use with the secondary cable and cannot be upgraded.

- Gently snap the secondary cable into the probe amplifier as shown in [Figure 7](#).

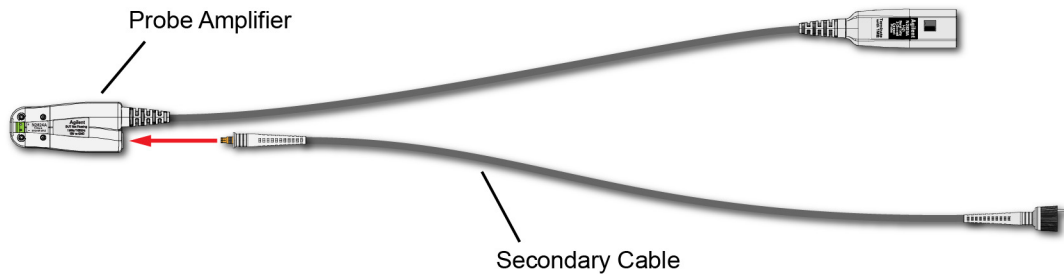

Figure 7 Connecting the N2820A's Secondary Cable

2 Making Measurements Quick Start

Step 4. Connect Probe to Scope

- 1 Connect the probe to any available oscilloscope channel.

NOTE

For N2820A probes *always* connect the primary cable first *promptly* followed by the secondary cable. This enables the oscilloscope to automatically associate the two inputs to the same probe. **Figure 8** is an example of connecting two N2820A probes to non-adjacent channel inputs.

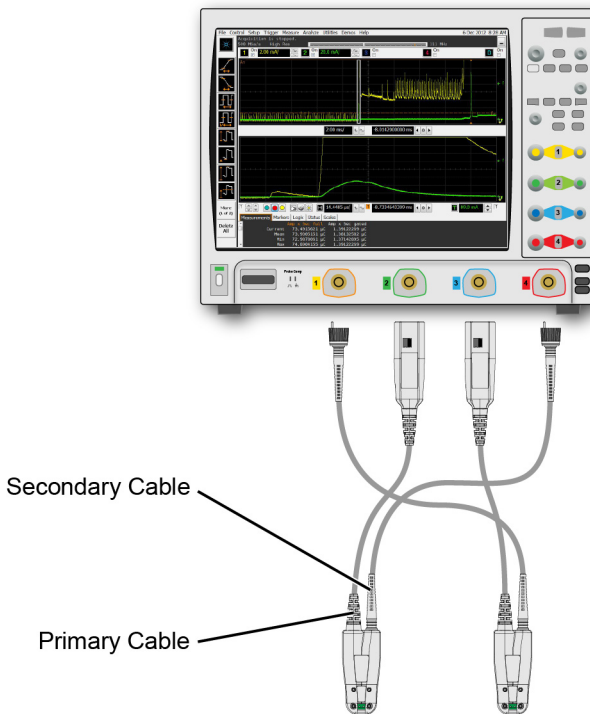

Figure 8 Example of Connecting Two N2820A Probes to the Oscilloscope

NOTE

N2820A Probes. Although connecting the primary and secondary cables to adjacent channels may reduce clutter, this is not a requirement. For example, you could connect an N2820A's primary cable to channel 2 and its secondary cable to channel 4.

NOTE

To ensure the display of accurate waveforms, *always* connect the supplied ground lead when probing battery-powered devices. Refer to [“To Measure Battery-Powered Devices”](#) on page 33.

- 2 If you are using an Infiniium oscilloscope, continue with [“Step 5. Configuring the Probe on Infiniium Oscilloscopes”](#) on page 29.
- 3 If you are using an InfiniiVision oscilloscope, continue with [“Step 6. Configuring the Probe on InfiniiVision Oscilloscopes”](#) on page 31.

Step 5.
Configuring the Probe on
Infiniium Oscilloscopes

- 1 On the oscilloscope, click the **Setup > Probe Configuration** menu command to view the Probe Configuration dialog box.

NOTE

For N2820A probes, the probe's primary channel tab in the Probe Configuration dialog box configures both the primary and secondary channel. The secondary channel is listed on another tab but is not controlled from that tab.

2 Making Measurements Quick Start

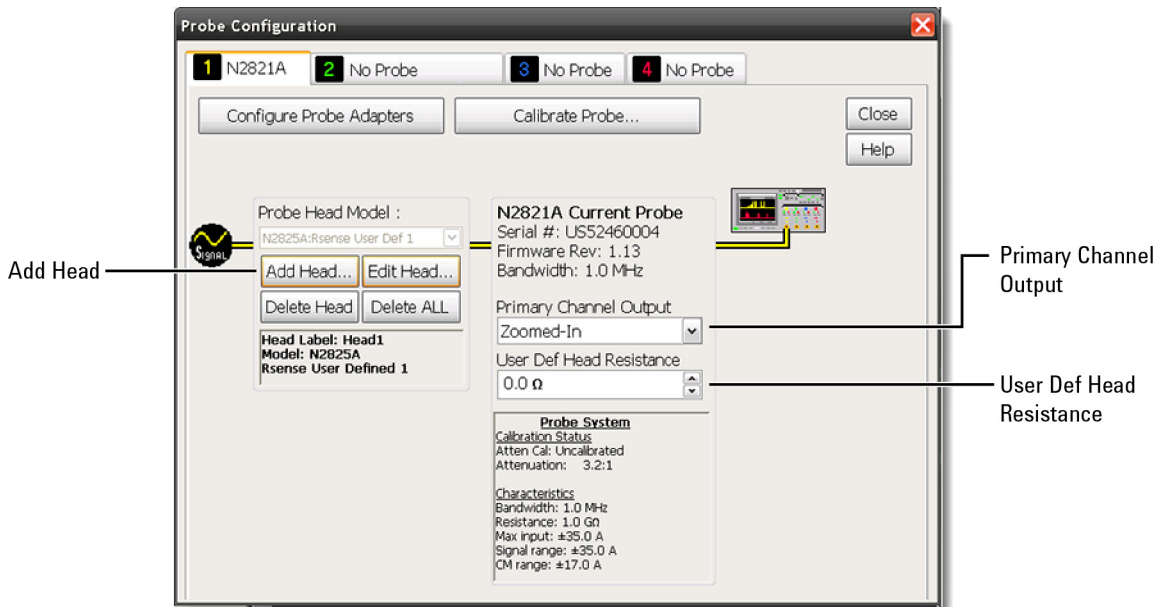

Figure 9 Probe Configuration Dialog Box (N2821A Probe)

- 2 Click the tab that represents the probe. In the case of N2820A probes, the probe's primary channel.
- 3 If you are using an N2821A probe, use the **Primary Channel Output** field to configure the input channel as a zoomed-in or zoomed-out channel.
- 4 If you are using an N2825A user-defined head, which uses a DUT-mounted R_{SENSE} resistor, enter the resistance of the external R_{SENSE} resistor in the **User Def Head Resistance** field.

NOTE

The above step manually enters the N2825A's associated external R_{SENSE} resistance. But, when using multiple R_{SENSE} resistors on your DUTs, you will find more convenient procedures in [Chapter 3](#), "Using N2825A Probe Heads".

Step 6. Configuring the Probe on InfiniiVision Oscilloscopes

- 1 Press the front-panel channel key that is associated with the probe. In the case of N2820A probes, the probe's primary channel.
- 2 Press the **Probe** softkey.
- 3 If you are using an N2821A probe, press the **Zoom-In** softkey to toggle between zoomed-in (blue selection box on softkey) or zoomed-out (clear selection box) for the channel. This softkey is shown at the bottom of [Figure 10](#) on page 32.
- 4 If you are using an N2825A user-defined head, which uses a DUT-mounted R_{SENSE} resistor, press the **R-Sense** softkey, shown in [Figure 10](#) on page 32. Then, enter the resistance of the R_{SENSE} resistor that you are using.

NOTE

The above step manually enters the N2825A's associated external R_{SENSE} resistance. But, when using multiple R_{SENSE} resistors on your DUTs, you will find more convenient procedures in [Chapter 3](#), "Using N2825A Probe Heads".

NOTE

For N2820A probes, softkeys for the probe's primary channel configure *both* the primary and secondary channel. Unlike Infiniium oscilloscopes, InfiniiVision oscilloscopes do *not* support the assigning of names to identify N2825A/ R_{SENSE} combinations.

2 Making Measurements Quick Start

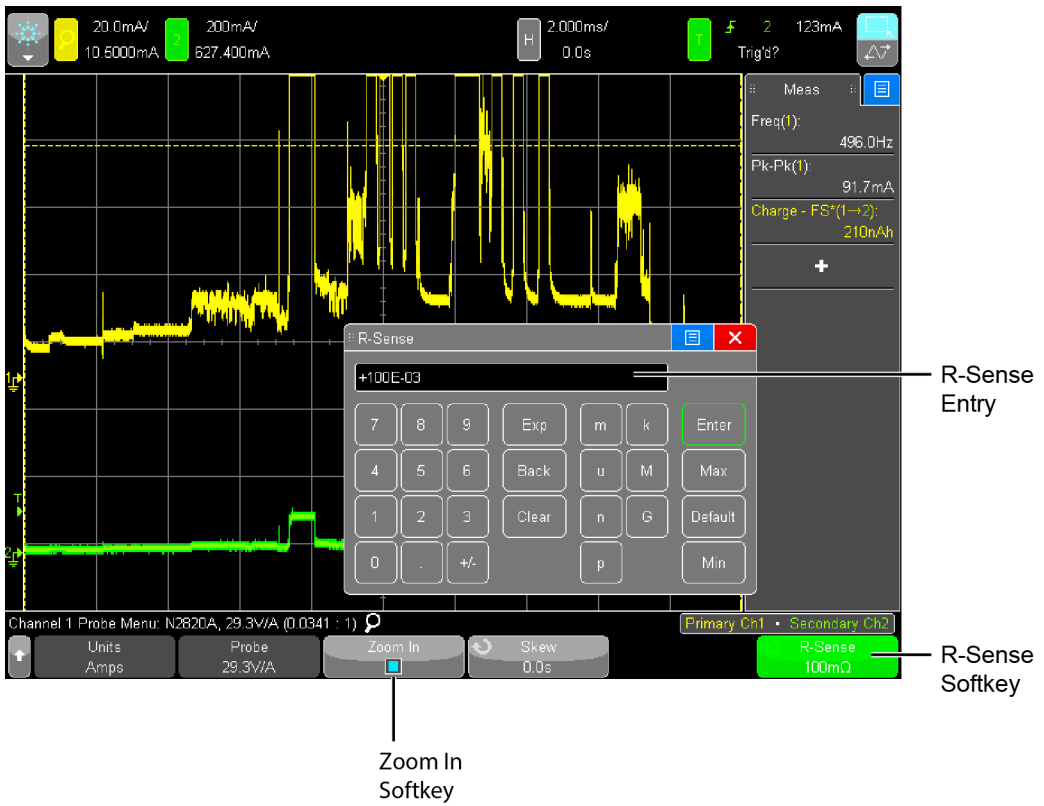

Figure 10 R-Sense Entry Box

To Measure Battery-Powered Devices

When making measurements on a battery-powered (floating) device, such as a mobile phone, *always* connect the supplied ground lead between ground on your device and the probe's ground connector as shown in [Figure 11](#). Simply snap the end of the ground lead onto the probe's connector. Without the ground connection, the common mode voltage is not guaranteed to be within the common mode range of the amplifiers.

NOTE

Failure to connect the ground lead may result in inaccurate waveforms.

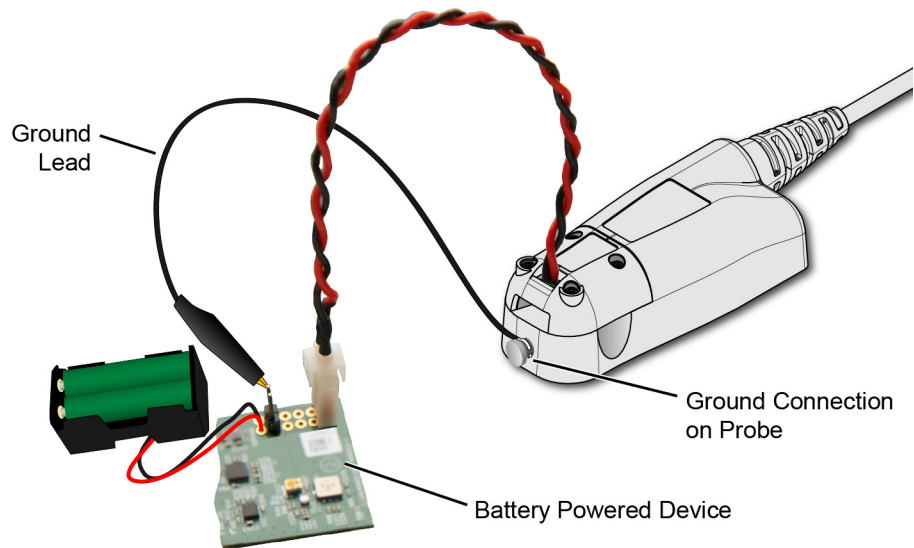



Figure 11 Supplied Ground Lead on Device

To make a Charge measurement

- 1 Connect the probe. If an N2825A user-defined head is used, enter the R_{SENSE} resistance as explained in “Step 5. Configuring the Probe on Infiniium Oscilloscopes” on page 29.
- 2 If desired, click the oscilloscope’s **Zoom** button to turn on zoom mode. 

NOTE

With Zoom Mode turned on, you can use gating to show a reduced zoom-window time span compared to the normal window. This is indicated on the non-zoomed waveform by a white boundary-area box.

NOTE

Zoom mode is a software only expansion and results in the same vertical resolution and accuracy between the zoom and non-zoom waveforms.

- 3 Click **Measure > Mixed > Charge (N282XA)** to view the Enter Measurement Info dialog box.

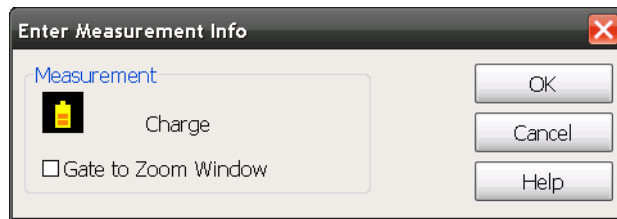

Figure 13 Enter Measurement Info Dialog Box

- 4 If Zoom Mode is turned on, select **Gate to Zoom Window** to enable a reduced zoom-window time span. If Zoom Mode is turned off, this field is not selectable (grayed out).
- 5 If more than one N2820/1A probe is connected in the oscilloscope, the dialog box allows you to select the probe used for the measurement.

2 Making Measurements To Measure Charge on an InfiniiVision Oscilloscope

To Measure Charge on an InfiniiVision Oscilloscope



A new measurement, **Charge**, is available on InfiniiVision oscilloscopes. This measurement determines the total current consumption over time with the results listed in Ampere-hours (**Ah**). For N2820A probes, the measurement includes the area under the curve across both zoomed-in and zoomed-out waveforms.

Figure 14 shows a **Charge** measurement.

NOTE

Always connect the ground lead when probing mobile phones, as explained in **“To Measure Battery-Powered Devices”** on page 33.



Figure 14 Full Screen Charge Measurement with Zoom Mode

To make a Charge measurement

- 1 Connect the probe. If an N2825A user-defined head is used, enter the R_{SENSE} resistance as explained in “Step 6. Configuring the Probe on InfiniiVision Oscilloscopes” on page 31.
- 2 If desired, click the oscilloscope’s **Zoom** button to turn on zoom mode.



NOTE

With Zoom Mode turned on, you can use gating to show a reduced zoom-window time span compared to the normal window. This is indicated on the non-zoomed waveform by a non-shaded boundary-area box.

NOTE

Zoom mode is a software only expansion and results in the same vertical resolution and accuracy between the zoom and non-zoom waveforms.

- 3 Press the front-panel **Meas** key.
- 4 Press the **Type:** softkey.
- 5 Select one of two measurements:



Charge - Full Screen. The Full Screen measurement interval variation measures the value on all displayed data points. For more information, refer to the oscilloscope’s Help system.



Charge - N Cycles. The N Cycles measurement interval variation measures the value on an integral number of periods of the displayed signal. If less than three edges are present, the measurement shows “No edges”. For more information, refer to the oscilloscope’s Help system.

- 6 If more than one N2820/1A probe is connected to the oscilloscope, softkeys appear that allow you to specify the channel on which to perform the measurement.

2 Making Measurements

To Simultaneously View Zoomed-In/Zoomed-Out Waveforms

To Simultaneously View Zoomed-In/Zoomed-Out Waveforms

When using an N2820A probe, zoomed-in and zoomed-out waveforms can be simultaneously viewed on:

- 9000 H-Series Infiniium oscilloscopes, and
- 9000A Series Infiniium oscilloscopes

In dual-grid view (shown in [Figure 15](#)), the zoomed-out waveform originates from the probe's low-gain amplifier, and the zoomed-in waveform originates from the probe's high-gain amplifier. The zoomed-in waveform has less noise and dynamic range than the zoomed-out waveform.

NOTE

Dual-Grid View is not supported in InfiniiVision oscilloscopes.

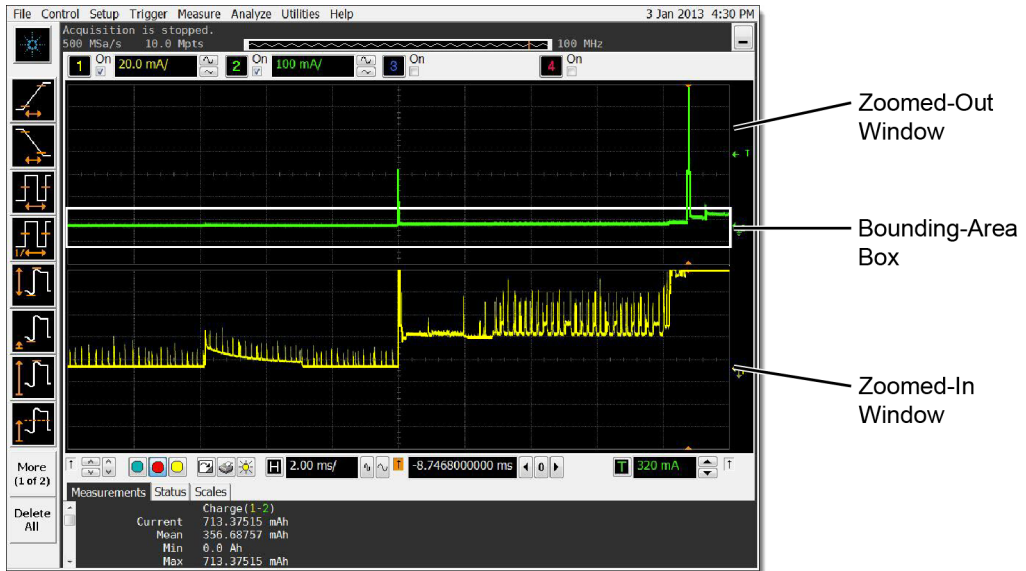

Figure 15 Displayed Zoom Windows

On the display, the bounding-area box identifies the portion of the zoomed-out waveform that is displayed in the zoomed-in window. This is shown in Figure 15. The bounding-area box does not indicate waveform clipping.

If the border of the bounding-area box is red, this indicates that output clamping is active. When the border is white, output clamping is disabled.

Dual-grid view allows simultaneous viewing of high sensitivity and high dynamic-range inputs. One example of using dual-grid view is to quickly identify and view a specific pulse and perform a DC power measurement on that pulse.

Oscilloscope's Zoom Mode

If you're familiar with the oscilloscope's Zoom Mode, you may be interested to know that while Zoom Mode uses software to expand the zoomed-in waveform, dual-grid view uses hardware amplification applied by the probe's high-gain amplifier.

To view only one window

- 1 Click **Setup > Display** to open the Display Setup dialog box.
- 2 In the **Quantity** field, select **1**.

2 Making Measurements To Simultaneously View Zoomed-In/Zoomed-Out Waveforms

NOTE

For best measurement results, click **Setup** > **Acquisition** and select one of the **High Resolution** settings.

To Make Measurements Without Interrupting Your DUT

The supplied Make-Before-Break (MBB) connectors allow you to easily connect and disconnect your probe without interrupting the Device-Under-Test (DUT). With the MBB connector you can quickly probe multiple locations on your DUT without having to solder or unsolder the leads. The MBB can be used with all R_{SENSE} probe heads including the N2825A user-defined probe head.

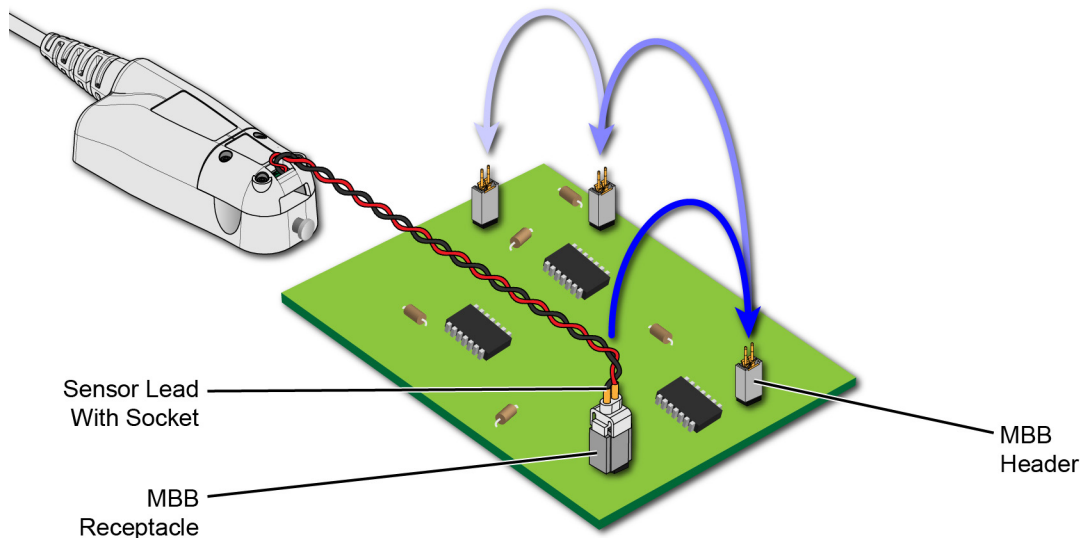

Figure 16 Probing with MBB Connector on DUT

As shown in [Figure 17](#) on page 42, MBB connectors consist of a receptacle and header. A sensor lead with socket snaps onto the receptacle. The header has two 0.025" square pins that are soldered onto pads with 2.54 mm (0.1") contact-pitch spacing.

2 Making Measurements To Make Measurements Without Interrupting Your DUT

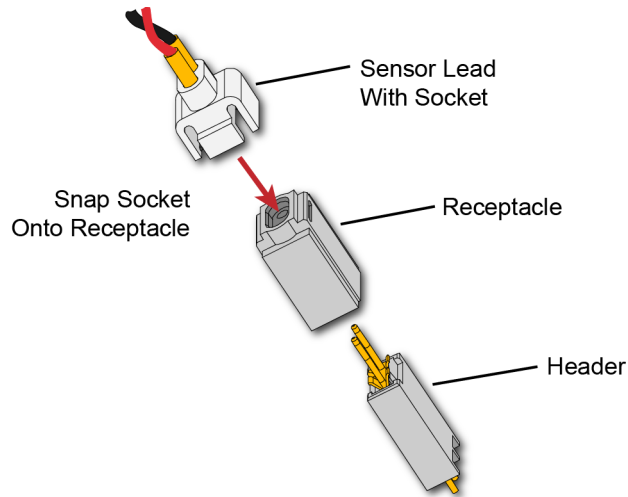

Figure 17 Socketed Lead Snaps Onto the MBB Receptacle

To Use the MBB Connector

- 1 Solder one or more headers onto your DUT.
- 2 Snap the sensor lead's socket onto the receptacle.

NOTE

Once attached to the receptacle, the socket cannot easily be removed without deforming the receptacle. For information on ordering additional socketed sensor leads, receptacles, and headers, refer to [Table 2](#) on page 11.

- 3 Repeatedly plug the lead with MBB receptacle onto different headers as you probe your DUT.

Figure 18 illustrates how the MBB connection changes as you gently push the receptacle onto the header while using an N2822/4A head. Figure 19 on page 45 shows the schematic when using the MBB with an N2825A user-defined head.

2 Making Measurements To Make Measurements Without Interrupting Your DUT

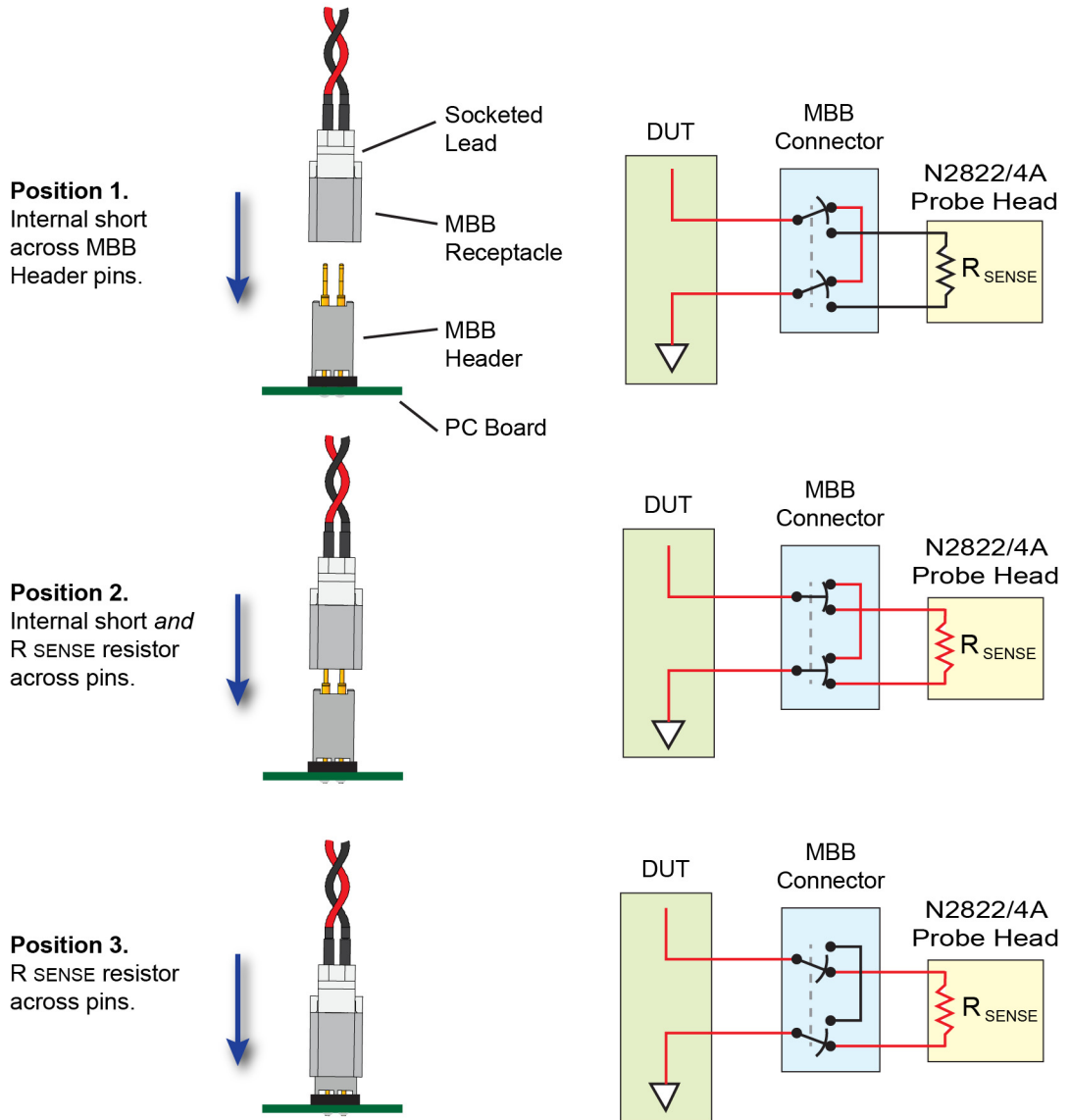

Figure 18 Connecting the MBB Connector with N2822/4A Head

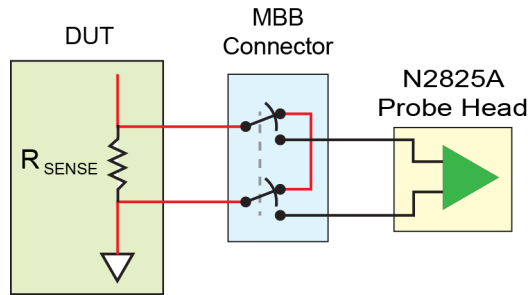

Figure 19 MBB Connector With N2825A User-Defined Head

To Download the Header
Gerber File

You can download a Gerber file from Keysight that defines many of the parameters needed to design the PC board connection for the MBB header. Gerber files can be imported into many PC board layout applications. You can download this file using the following URL: www.keysight.com/find/N2828A

For information on the physical dimensions of the MBB header and MBB socket/receptacle, refer to [Figure 42](#) on page 89.

Extreme Temperature Probing

By constructing your own long sensor leads, you can use the N2820/1A probes for extreme temperature probing, such as monitoring a product in an environmental chamber. The following two sensor lead examples provide accurate measurements:

- 6 feet of twisted-pair wire using two turns-per-inch. The DUT should be grounded to the probe.
- 10 feet of shielded twisted-pair wire using two turns-per-inch. Ground to the probe both the DUT and the shield.

NOTE

Do not directly subject the probe amplifier, head, or cable to extreme temperatures. The probe's operating temperature range is 0°C to 40°C (32°F to 104°F).

Burden Voltage of N2822/4A Probe Heads

When an N2822/4A head is used, the resistance of the head's connectors, sensor leads, and internal R_{SENSE} resistor is connected in series with the DUT's circuit and current is flowing through the probe head, as shown in [Figure 20](#).

$$V_{\text{burden}} = I_{\text{measured}} \times R_{\text{shunt}}$$

Therefore, a burden voltage (IR) is introduced into your circuit. Burden voltages may affect the circuit and will tend to increase the noise. Burden voltages do *not* affect the measurement. [Table 2](#) on page 11 lists the resistances added by various probing components.

NOTE

N2825A heads do not contribute a burden voltage as the current is *not* flowing through the head.

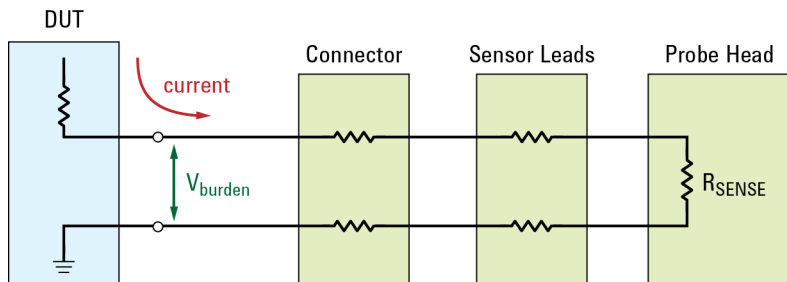

Figure 20 V_{burden} Developed Across Probing Components

2 Making Measurements

Burden Voltage of N2822/4A Probe Heads

Table 4 Resistance Added by Head Components

Component	Resistance Contribution (Round Trip)
Sensor Leads Without Socket	20 m Ω
Sensor Leads With Socket	40 m Ω
MBB Header Only (Not Connected)	20 m Ω
MBB Header/Receptacle/Socket	40 m Ω
R _{SENSE} (N2822A Head)	20 m Ω
R _{SENSE} (N2824A Head)	100 m Ω

Dynamic Range

The N2820A and N2821A probes provide a large dynamic measurement range (>20,000:1 or 86 dB on the zoomed-in channel) that allows you to observe both the entire current waveform and extremely small current fluctuations. As shown in [Figure 21](#), you could simultaneously view a mobile phone's 135 mA receive current pulses and 2 mA idle current in the presence of 2A transmit current pulses, with a single acquisition. When using N2820A probes on Infiniium oscilloscopes, use the powerful new dual-grid view as explained in ["To Simultaneously View Zoomed-In/Zoomed-Out Waveforms"](#) on page 38.

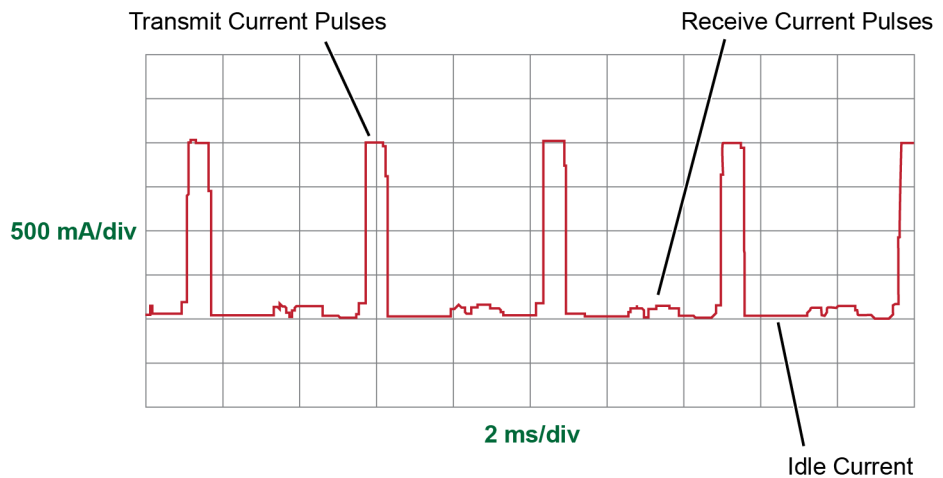

Figure 21 Small Pulses in the Presence of Large Pulses

R_{SENSE} Value and Dynamic Range

Since the N2820A probe has two outputs, each with a different gain, dynamic range encompasses both channels while using a single R_{SENSE} value. For example, with a $100\text{ m}\Omega$ R_{SENSE} resistor, the zoomed-in waveform can display about $50\text{ }\mu\text{A}$ and the zoomed-out channel can display about 2.2 A for a dynamic range of approximately 93 dB:

2 Making Measurements

Dynamic Range

$$93\text{dB} = 20\log\frac{2.2\text{A}}{50\ \mu\text{A}}$$

The value of the R_{SENSE} resistor can range from 1 m Ω to 1 M Ω as shown in [Figure 35](#), “Current Measurement Range of N2822/4A Heads (for Zoomed-out and Zoomed-in channels),” on page 78. Using these two R_{SENSE} values in different measurements, the dynamic range could be increased to 100 dB.

Effects Other Than Dynamic Range

Selecting the proper R_{SENSE} resistance is often a compromise between a value that is large enough to obtain accurate measurements while small enough to avoid negatively affecting the circuit under test. Increasing the resistance

- *decreases* the noise,
 - *increases* sensitivity, and
 - *increases* the burden voltage across the R_{SENSE} resistor (IR).
- Decreasing the resistance will have the opposite effect.

Channel Position on the Screen

This probe does not have voltage offset. Use the oscilloscope’s position controls to adjust the location of the waveform on the screen. Vertical scaling occurs about zero amperes.

3 Using N2825A Probe Heads

- To Manually Identify the R_{SENSE} Resistance / 52
 - On Infiniium Oscilloscopes / 52
 - On InfiniiVision Oscilloscopes / 53
- To Identify the R_{SENSE} Resistance Using a Unique Name / 54
- To Identify the R_{SENSE} Resistance Using an ID Resistor / 55
- To Add a Custom Internal R_{SENSE} Resistor / 61

The N2825A user-defined head is normally selected in situations where a DUT-mounted R_{SENSE} resistor is used. In this chapter, you'll learn how to perform the following tasks, which enables the oscilloscope to make accurate measurements:

- On Infiniium oscilloscopes, assign a custom name to the N2825A. This name identifies the resistance of a specific DUT-mounted R_{SENSE} .
- Change the N2825A's internal ID resistor. This resistor identifies the N2825A with a specific DUT-mounted R_{SENSE} .
- If the R_{SENSE} values of the N2822A and N2824A probe heads do not meet your measurement needs, you can add an internal R_{SENSE} resistor to the N2825A.



3 Using N2825A Probe Heads To Manually Identify the R_{SENSE} Resistance

To Manually Identify the R_{SENSE} Resistance

If you are using multiple, different DUT-mounted R_{SENSE} resistances, the following procedures show you how to enter the resistance each time that you use the N2825A head with a new R_{SENSE} .

On Infiniium Oscilloscopes

This method is used in “[Step 5. Configuring the Probe on Infiniium Oscilloscopes](#)” on page 29 and is repeated here.

- 1 Click the **Setup > Probe Configuration** menu command to view the Probe Configuration dialog box, shown in [Figure 22](#).

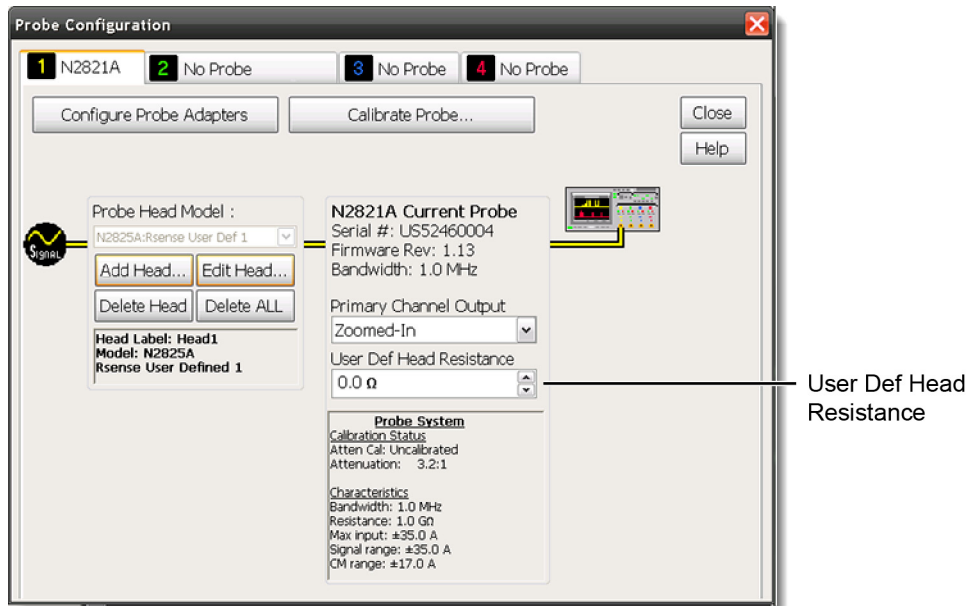

Figure 22 Infiniium Dialog Box With N2825A Heads

- 2 Click the tab that represents the probe. In the case of N2820A probes, the probe's primary channel.

- 3 In the dialog box, enter the R_{SENSE} resistance in the **User Def Head Resistance** field.

On InfiniiVision
Oscilloscopes

This method is used in “[Step 6. Configuring the Probe on InfiniiVision Oscilloscopes](#)” on page 31 and is repeated here.

- 1 Press the front-panel channel key that is associated with the probe. In the case of N2820A probes, the probe’s primary channel.
- 2 Click the **Probe** softkey followed by the **R-Sense** softkey.
- 3 Enter the resistance of the R_{SENSE} resistor that you are using.

3 Using N2825A Probe Heads To Identify the R_{SENSE} Resistance Using a Unique Name

To Identify the R_{SENSE} Resistance Using a Unique Name

NOTE

This procedure is for Infiniium oscilloscopes, only. InfiniiVision oscilloscopes do *not* support the assigning of names to identify N2825A/ R_{SENSE} combinations.

This procedure allows you to identify the external DUT-mounted R_{SENSE} by a unique name. After completing the procedure, simply connect the probe with the N2825A probe head, and select the unique name on the oscilloscope. The proper R_{SENSE} value is used for the measurements. Selecting a unique name is easier than manually entering the R_{SENSE} resistance each time that you use the N2825A head with a new R_{SENSE} .

- 1 Click the **Setup > Probe Configuration** menu command to view the Probe Configuration dialog box.
- 2 Use the **Add Head** field to assign a unique name for each of your N2825A/ R_{SENSE} resistance associations.
- 3 Each time that you connect the probe, select the appropriate name in the dialog box.

To Identify the R_{SENSE} Resistance Using an ID Resistor

By changing the N2825A's internal ID resistor, the probe head can automatically indicate to the oscilloscope the value of the DUT-mounted R_{SENSE} being used. Up to five dedicated N2825A probe heads can be configured in this manner using the ID resistor values shown in [Table 6](#).

Table 5 Valid N2825A ID Resistors

Resistor Value	Description
16.2 k Ω	Default value. Resistor, $\pm 1\%$, 0.063W, TC ± 100 thick film 0402 SMT
19.6 k Ω	Resistor, $\pm 1\%$, 0.063W, TC ± 100 thick film 0402 SMT
26.1 k Ω	Resistor, $\pm 1\%$, 0.063W, TC ± 100 thick film 0402 SMT
42.4 k Ω	Resistor, $\pm 1\%$, 0.063W, TC ± 100 thick film 0402 SMT
61.9 k Ω	Resistor, $\pm 1\%$, 0.063W, TC ± 100 thick film 0402 SMT

For example, you might install a 19.6 k Ω ID resistor in one N2825A to identify measurements using a 50 m Ω R_{SENSE} and a 26.2 k Ω ID resistor in another N2825A to identify measurements using a 300 m Ω R_{SENSE} . The first time that you use the modified N2825A, you must perform a one-time entry of the associated R_{SENSE} resistance on the oscilloscope. For subsequent uses, the oscilloscope automatically uses the specified R_{SENSE} value for each N2825A head. You can order additional N2825A heads from Keysight.

CAUTION

In the following procedure, always wear an ESD wrist strap and work at a static-safe workstation. Not doing so can result in the probe head becoming permanently damaged.

3 Using N2825A Probe Heads To Identify the R_{SENSE} Resistance Using an ID Resistor

- 1 Remove the probe head by gently pulling the head straight off the probe in the direction shown.

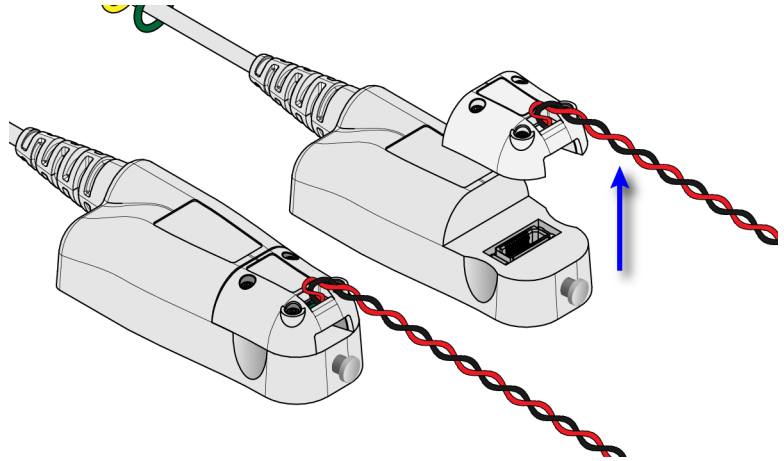

Figure 23 Removing the Probe Head

- 2 Remove the four hex screws that secure the cover of the N2825A R_{SENSE} head and remove the cover.

Screws (Qty. 4)

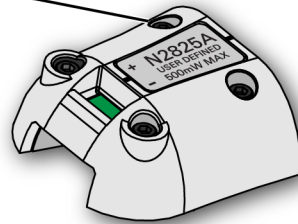

Figure 24 Removing the N2825A Cover

- 3 Remove the PC board from the head.

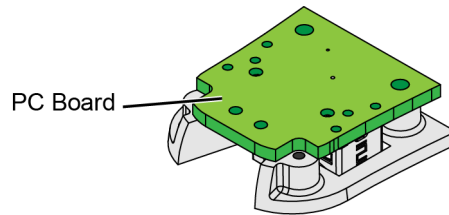

Figure 25 Remove PC Board

- 4 On the reverse side of the PC board, locate ID resistor, **R2**, as shown in [Figure 26](#).

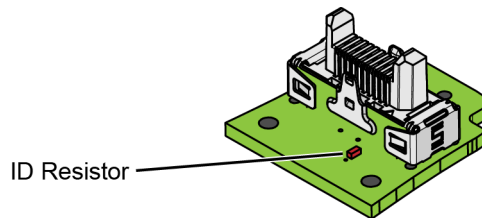

Figure 26 Location of ID Resistor (R2)

- 5 Replace the ID resistor with any of the values listed in [Table 7](#). The default value loaded on the board is 16.2 k Ω . You can purchase a resistor from a supplier such as Digi-Key corporation.

CAUTION

If you are *not* skilled in soldering, ask a trained assembler to change the resistor.

3 Using N2825A Probe Heads To Identify the R_{SENSE} Resistance Using an ID Resistor

Table 6 Valid N2825A ID Resistors

Resistor Value	Description
16.2 k Ω	Default value. Resistor, $\pm 1\%$, 0.063W, TC ± 100 thick film 0402 SMT
19.6 k Ω	Resistor, $\pm 1\%$, 0.063W, TC ± 100 thick film 0402 SMT
26.1 k Ω	Resistor, $\pm 1\%$, 0.063W, TC ± 100 thick film 0402 SMT
42.4 k Ω	Resistor, $\pm 1\%$, 0.063W, TC ± 100 thick film 0402 SMT
61.9 k Ω	Resistor, $\pm 1\%$, 0.063W, TC ± 100 thick film 0402 SMT

- 6 Replace the N2825A's cover using the four screws. (M1.6 x 0.35, 5 mm long, Keysight part number 0515-5210)

CAUTION

To avoid damaging the aluminum casting, do not over tighten the screws.

- 7 Connect the N2825A to an N2820/1A probe and connect the probe to the oscilloscope.
- 8 On Infiniium oscilloscopes,
 - a Click the **Setup > Probe Configuration** menu command.
 - b Select the tab for the probe's primary channel. N2821A probes only have a primary channel.
 - c In the **User Def Head Resistance** field, enter the resistance of the DUT's R_{SENSE} resistor in ohms.
 - d In the dialog box, click **Add Head** to give your head with associated external R_{SENSE} resistor a unique name.

- 9 On InfiniiVision oscilloscopes,
 - a Press the front-panel channel key that is associated with the probe's primary input.
 - b Click the **Probe** softkey.
 - c Press the **R-Sense** softkey and enter the resistance of the R_{SENSE} resistor that you are using.
- 10 For future reference, mark your different N2825A heads using a marker pen or tape and record the information in [Table 7](#) on page 60. In the table's fourth column, record the name that you entered in the Probe Configuration dialog box.

NOTE

Remember to mark your different N2825A heads, using a marker pen or tape, so that you can distinguish between them.

To Add a Custom Internal R_{SENSE} Resistor

If you need to use a different R_{SENSE} resistance than provided by the N2822A and N2824A heads, you can convert an N2825A head to an internal R_{SENSE} head. For example, suppose that you require a 400 m Ω *internal* R_{SENSE} , but the N2822A has a 20 m Ω R_{SENSE} and the N2824A has a 100 m Ω R_{SENSE} . You simply need to install your 400 m Ω R_{SENSE} into an N2825A probe head.

NOTE

Do not change the R_{SENSE} resistor in N2822A or N2824A heads.

CAUTION

Always wear an ESD wrist strap when working with active probes. Not doing so can result in the probe becoming permanently damaged.

- 1 Select a resistor of type $\pm 1\%$, 0.5W, TC ± 600 , thick film 2010 SMT. The value of the precision resistor can range from 1 m Ω to 1 M Ω in 1 m Ω increments.

WARNING

When selecting the resistance value, you must observe the 500 mW maximum power rating of the head.

- 2 Remove the probe head by gently pulling the head straight off the probe in the direction shown.

3 Using N2825A Probe Heads To Add a Custom Internal R_{SENSE} Resistor

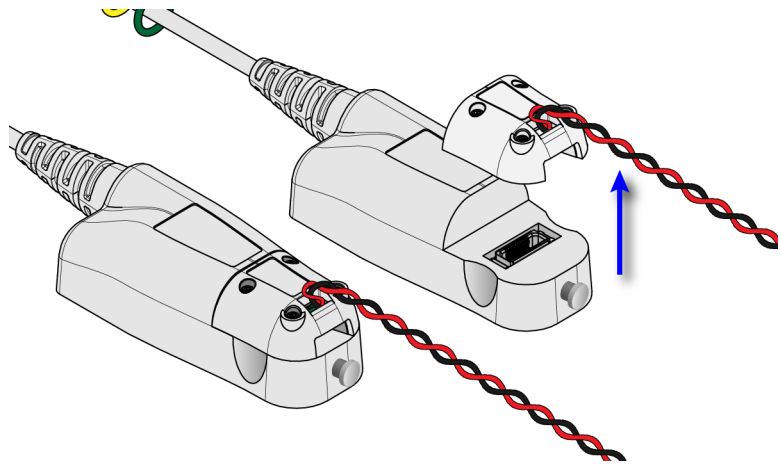

Figure 27 Removing the Probe Head

- 3 Remove the four hex screws that secure the head's cover and remove the cover.

Screws (Qty. 4)

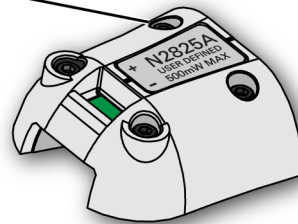

Figure 28 Removing the Cover

- 4 Change or add the R_{SENSE} resistor (**R1**) as shown in [Figure 29](#).

CAUTION

If you are not skilled in soldering, ask a trained assembler to change the resistor.

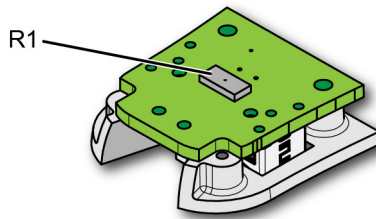

Figure 29 Location of R_{SENSE} Resistor (R1)

- 5 Replace the head's cover using the four screws. (M1.6 x 0.35, 5 mm long, Keysight part number 0515-5210)

CAUTION

To avoid damaging the aluminum casting, do not over tighten the screws.

- 6 Connect the N2825A to an N2820/1A probe and connect the probe to the oscilloscope.
- 7 On Infiniium oscilloscopes,
 - a Click the **Setup > Probe Configuration** menu command.
 - b Select the tab for the probe's primary channel. N2821A probes only have a primary channel.
 - c In the **User Def Head Resistance** field, enter the resistance of the DUT's R_{SENSE} resistor in ohms.
 - d In the dialog box, click **Add Head** to give your head with associated external R_{SENSE} resistor a unique name.

3 Using N2825A Probe Heads To Add a Custom Internal R_{SENSE} Resistor

- 8 On InfiniiVision oscilloscopes,
 - a Press the front-panel channel key that is associated with the probe's primary input.
 - b Click the **Probe** softkey.
 - c Press the **R-Sense** softkey and enter the resistance of the R_{SENSE} resistor that you are using.

You could also change the head's internal ID resistor as explained "[To Identify the \$R_{\text{SENSE}}\$ Resistance Using an ID Resistor](#)" on page 55.

4 Probe Calibration

This chapter provides procedures for calibrating the probe on an Infiniium oscilloscope and on an InfiniiVision Oscilloscope.

“To Calibrate the Probe on Infiniium Oscilloscopes” on page 66

“To Calibrate the Probe on InfiniiVision Oscilloscopes” on page 70

Always calibrate the probe before making any critical measurements. A probe calibration removes attenuation, offset, and gain errors as well as timing delays that are introduced by the probe. The calibration applies to a specific probe (identified by serial number) that is connected to a specific oscilloscope channel. If you connect the probe to a different channel, the calibration will no longer be valid.

CAUTION

Always wear an ESD wrist strap when working with active probes. Not doing so can result in the probe becoming permanently damaged.

4 Probe Calibration

To Calibrate the Probe on Infiniium Oscilloscopes

To Calibrate the Probe on Infiniium Oscilloscopes

During this calibration, you may be prompted to make one or more adjustments. These adjustments, located on the underside of the probe amplifier, are shown in [Figure 32](#) on page 69.

Table 8 Required Calibration Test Equipment

Test Equipment	Description
N2825A User-Defined Probe Head	Provided with probe.
Pomona 3788 BNC Female to Minigrabber Test Clips Breakout	 Refer to http://www.pomonaelectronics.com/ for more information and how to order this product.
Adapters	SMA, BNC, BNC Tee, BNC cables and cable clips as needed.
Screwdriver	For making adjustments during the procedure. This tool is provided with the probe.

NOTE

Redirecting the Probe Comp Signal

On 9000-series and S-series Infiniium oscilloscopes, you can redirect the Probe Comp signal to the Aux Output BNC connector on the rear panel of the oscilloscope. This connector can then be connected to the Pomona 3788 using a BNC cable. Click **Utilities** > **Calibration** and select **Probe Comp** in the **Aux Output** drop-down list.

Procedure

- 1 Turn the oscilloscope on.
- 2 Solder the sensor leads onto the N2825A user-defined head as explained in [“Quick Start”](#) on page 25.
- 3 Attach the N2825A user-defined head to the probe.

To Calibrate the Probe on Infiniium Oscilloscopes

- 4 Connect the equipment as shown in Figure 30 on page 67. Observe the following requirements:
 - Connect the probe to the scope channel that you will use during probing. Use any other available scope channel for the BNC cable that is needed for connection to the Pomona 3788.
 - Connect the Pomona 3788 to two BNC cables using a BNC tee. Then connect one of these BNC cables to a scope channel and the other BNC cable to the Aux Output BNC connector located on the Oscilloscope's rear-panel (as shown in Figure 30).
 - On N2820A probes, do not connect the secondary cable at this time.
 - Connect both the N2825A's sensor leads (red and black wires) to the black test clip of the Pomona 3788 as shown in Figure 30.

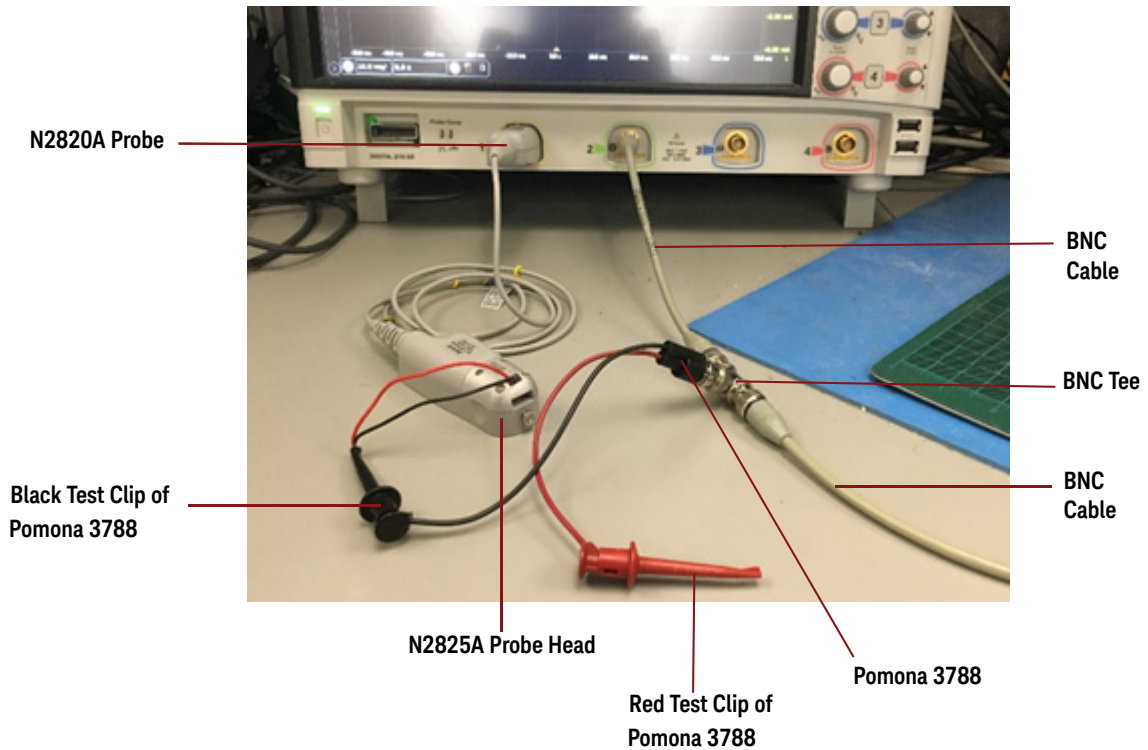

Figure 30 Example of Initial Calibration Setup

4 Probe Calibration To Calibrate the Probe on Infiniium Oscilloscopes

- 5 Let the probe warm up for 15 minutes.
- 6 On the oscilloscope, click **Setup** > **Channel** to open the Channel Setup dialog box and select the channel tab for the connected probe.
- 7 Click **Probes...** to open the Probe Setup dialog box. Then, click the **Calibrate Probe...** button.
- 8 Follow the steps that are displayed on the oscilloscope. For the Gain Calibration step, connect the N2825A's sensor leads (red and black wires) as shown in [Figure 31](#). The black wire should connect to the black test clip of the Pomona 3788 and the red wire should connect to the red test clip of the Pomona 3788.

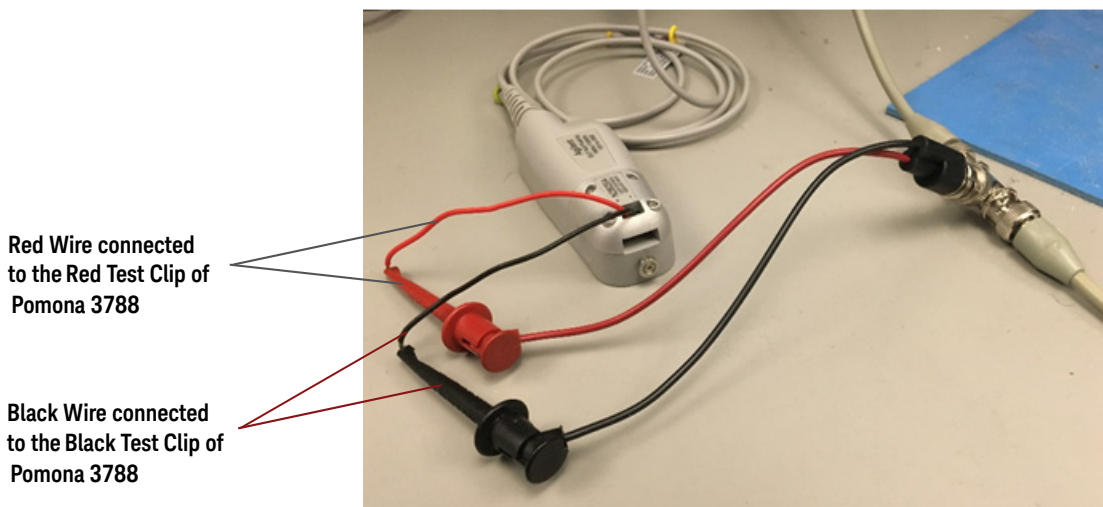

Figure 31 Example of Setup for the Gain Calibration Step

- 9 If you are prompted to make an adjustment, refer to [Figure 32](#). The adjustments are located on the underside of the probe amplifier.

NOTE

The screwdriver provided with the probe is the preferred adjustment tool.

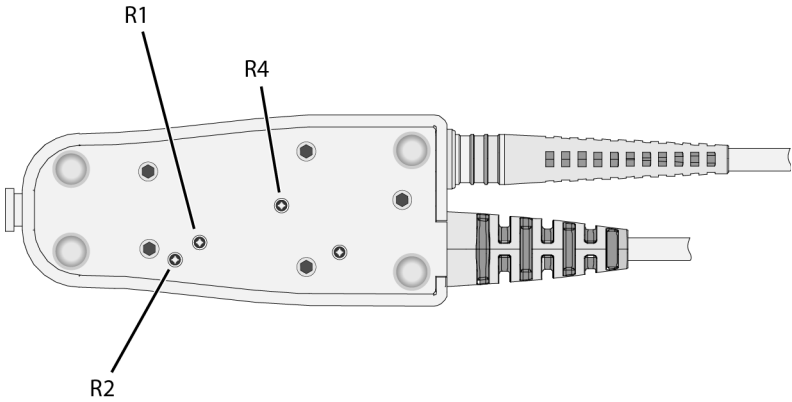

Figure 32 Location of Calibration Adjustments



4 Probe Calibration

To Calibrate the Probe on InfiniiVision Oscilloscopes

To Calibrate the Probe on InfiniiVision Oscilloscopes

The following test equipment are needed for the calibration procedure.

Table 9 Required Calibration Test Equipment

Test Equipment	Description
N2825A User-Defined Probe Head	Provided with probe.
Pomona 3781-12-2 Red Minigrabber Test Clip Patch Cord	 Refer to http://www.pomonaelectronics.com/ for more information and how to order this product.
Pomona 3781-12-0 Black Minigrabber Test Clip Patch Cord	 Refer to http://www.pomonaelectronics.com/ for more information and how to order this product.

Calibration Procedure

1. Connect the probe to the oscilloscope

- a Turn the oscilloscope on.
- b Plug the primary channel of the N2820A probe into the oscilloscope channel you are intending to use.
- c If applicable, plug the secondary channel of the probe into the oscilloscope channel you are intending to use.
- d Configure the zoomed-in path to the primary or secondary channel as necessary.
- e Solder the sensor leads onto the N2825A user-defined head as explained in “Quick Start” on page 25.
- f Attach the N2825A user-defined head to the probe.

NOTE

Allow the oscilloscope and probe to warm up for at least 20 minutes before performing the probe calibration.

2. Manually adjust the probe's initial offset

Calibration fails if the probe has too much initial offset. The probe's offset can be zeroed manually using the following procedure.

- a In the probe configuration menu, select **1Ω** as the R_{SENSE} for the N2825A probe head.
- b Connect both the N2825A's sensor leads (red and black wires) to one end of the Pomona 3781-12-2 patch cord. Connect the other end of this patch cord to the oscilloscope's ground lug on the front panel. A sample setup is displayed below.

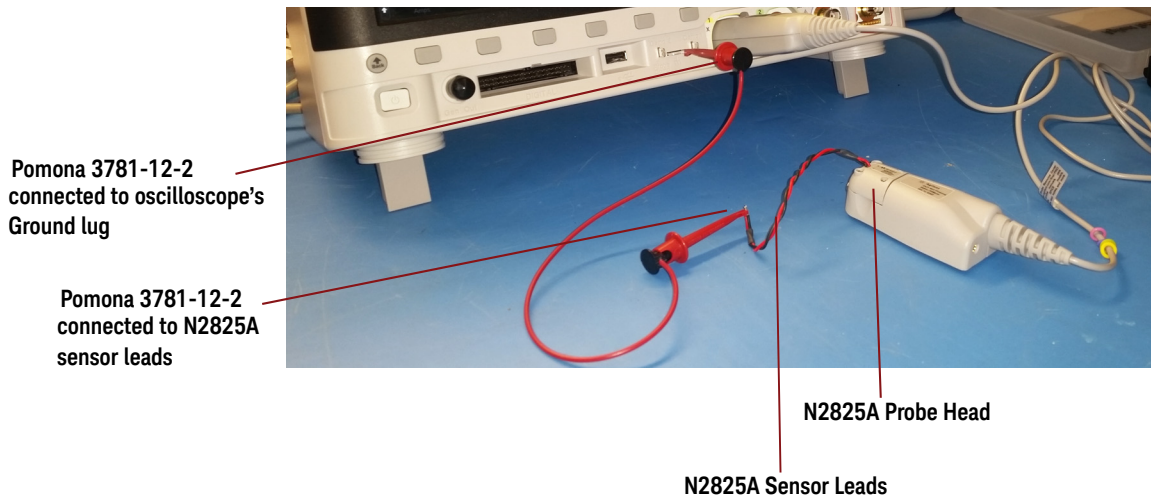

Figure 33 Probe Calibration Terminals Connections on an InfiniiVision-Series Oscilloscope

- c Set up the oscilloscope as follows:
 - i) Set the time/div to **100 us/div**.

4 Probe Calibration

To Calibrate the Probe on InfiniiVision Oscilloscopes

- ii) Turn on Averaging with **16 averages**.
 - iii) For both channels, set the V/div as small as possible to fit the waveform on screen. For the zoomed-in channel, this should be less than **10 μ A**. For the zoomed-out channel, this should be less than **2mA**. If the waveform is not on screen at these settings, increase the V/div and adjust the offset until these settings can be used.
 - iv) Turn on **Vavg** measurements for both channels.
- d** To set the zoomed-out offset, turn **R2** using the supplied screwdriver until the Vavg measurement is **+/- 1mA**.
- e** To set the zoomed-in offset, turn **R4** using the supplied screwdriver until the Vavg measurement is **+/- 1mA**.

NOTE

The R2 and R4 adjustments are located on the underside of the probe amplifier as displayed in **Figure 34**. The screwdriver provided with the probe is the preferred adjustment tool.

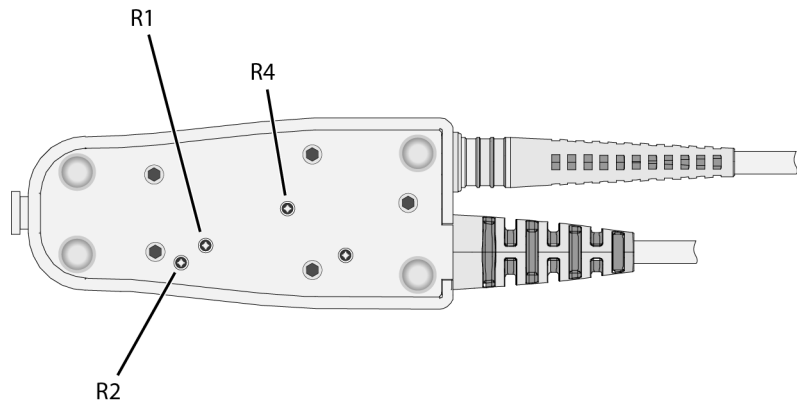

Figure 34 Location of Calibration Adjustments

- f Press the Channel on/off key to turn the channel on (if the channel is off).

3. Initiate Calibration

- a In the Channel menu, press the **Probe** softkey.

NOTE

When you connect the probe, the **Calibrate Probe** softkey in the Channel Probe menu becomes active.

- b Press the **Calibrate Probe** softkey and then press the **OK** softkey to begin calibration.

4 Probe Calibration

To Calibrate the Probe on InfiniiVision Oscilloscopes

5 Characteristics and Specifications

Current Range Vs. R_{SENSE} Graphs / 78

Maximum Current Measurement Ranges for Probe Heads / 81

Dimensions / 89

This chapter provides the characteristics and specifications for the N2820A and N2821A probes. The probe should be warmed up for at least 20 minutes before any testing and the environmental conditions should not exceed the probe's specified limits.

Table 10 Characteristics and Specifications

Item	Characteristic
Bandwidth (-3 dB)	Zoom-Out Channel: DC to 3 MHz Zoom-In Channel: DC to 500 kHz
Risetime ($T_r = 0.35/BW$, 10% - 90%)	Zoom-Out Channel: < 0.116 μ s Zoom-In Channel: < 0.7 μ s
Minimum Measurable Current	250 μ A (with N2822A 20 m Ω , 500mW) 50 μ A (with N2824A 100 m Ω , 500mW) 5 mA (with N2825A user-defined 1 m Ω , 500mW) 100 nA (with N2825A user-defined 1 k Ω , 500mW) ^a
Maximum Measurable Current	5A (with N2822A 20 m Ω , 500 mW) 2.2A (with N2824A 100 m Ω , 500 mW) 5A (with N2825A user-defined 1 m Ω installed, 500 mW) 1.2 mA (with N2825A user-defined 1 k Ω installed, 500 mW) 120 A (with N2825A user-defined 1.5 M Ω installed, 20W)

5 Characteristics and Specifications

Item	Characteristic
Output Voltage Rate	Zoom-In Channel: 6 V/A (with N2822A 20 m Ω) 30 V/A (with N2824A 100 m Ω) Zoom-Out Channel: 0.04 V/A (with N2822A 20 m Ω) 0.2 V/A (with N2824A 100 m Ω)
Maximum Input Voltage (Represents the acceptable voltage range of the power rail to be measured)	$\pm 12V$
Maximum Non-destructive Input Voltage	$\leq 15 V$
Maximum Output Voltage (Linear Operation)	12V ^b
Burden Voltage (voltage drop on R _{SENSE})	Measured current * R _{SENSE}
Dynamic Range	20,000:1, 86 dB (N2820A) 1,000:1, 60 dB (N2821A)
Oscilloscope Input Impedance	1 M Ω
Input Impedance	1.5 G Ω single ended 3.0 G Ω differential
Gain ^c (warranted specification)	Zoom-In: 300 $\pm 3\%$ Zoom-Out: 1.97 $\pm 3\%$
Noise, AC _{rms}	150 μA_{rms} (with N2822A 20 m Ω , (hi res mode on) ^d 240 μA_{rms} (with N2822A 20 m Ω , (hi res mode off) 30 μA_{rms} (with N2824A 100 m Ω , (hi res mode on) ^d 50 μA_{rms} (with N2824A 100 m Ω , (hi res mode off)
Sensor Resistor Accuracy	$\pm 1\%$ (N2822A, N2824A)
Sensor Resistor Power Rating	500 mW (N2822A, N2824A)
Temperature Coefficient of Sensor Resistor	< 20 ppm/ $^{\circ}C$
Cable Lengths	Sensor leads: 16 cm Probe cable: 1.2m

- a Probe loading (1.5G Ω) contributes 3% error at V_{supply} equal to 5V.
- b Clipping occurs for higher voltages, which may appear on the screen.
- c Denotes warranted spec after 20 minute warm up. All others entries in the table are characteristics.
- d With scope with high resolution mode on, sampling rate < 2.5 MSa/s, 20 MHz low-pass filter on.

Table 11 Environmental Characteristics

Item	Characteristic
Temperature (operating)	Operating: 0° C to 40° C Non-Operating: -40° C to 70° C
Humidity (operating)	Operating: tested at 95% RH @ +40° C Non-Operating: tested at 90% RH, +65° C
ESD	8 kV HBM
Indoor Use	This probe is rated for indoor use only

Current Range Vs. R_{SENSE} Graphs

The following graphs show the minimum and maximum current ranges versus R_{SENSE} resistance.

NOTE

These graphs represent a condition where the sensor leads are solder attached to the R_{SENSE} resistor, the maximum probe-head power rating of 500 mW is observed, and the oscilloscope is set to high-resolution.

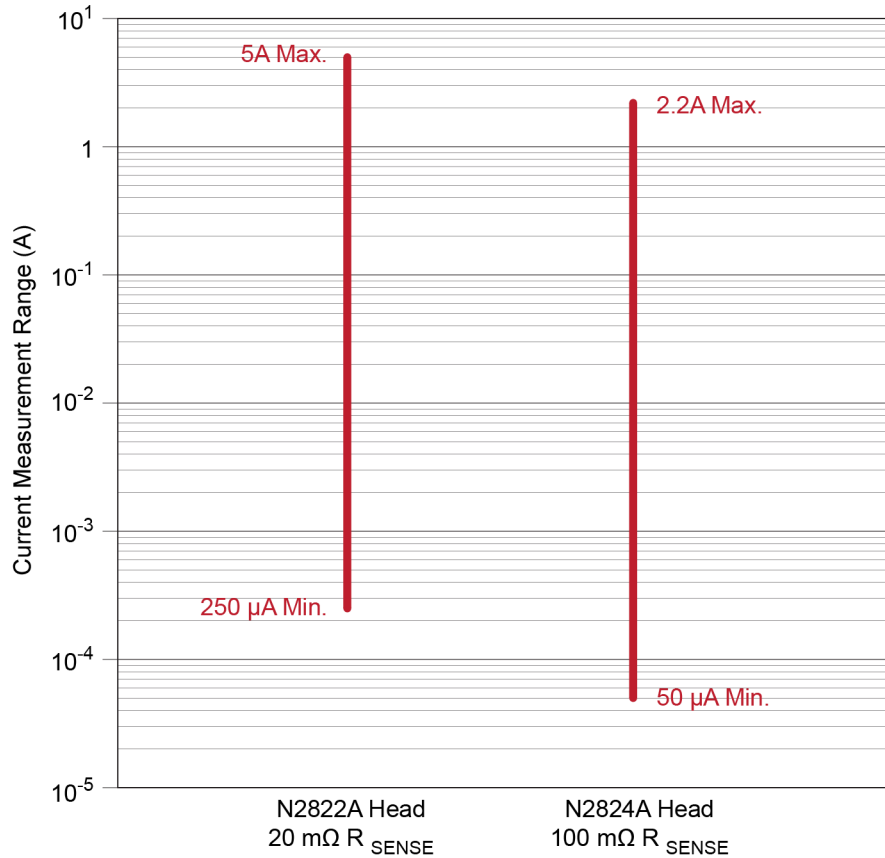

Figure 35 Current Measurement Range of N2822/4A Heads (for Zoomed-out and Zoomed-in channels)

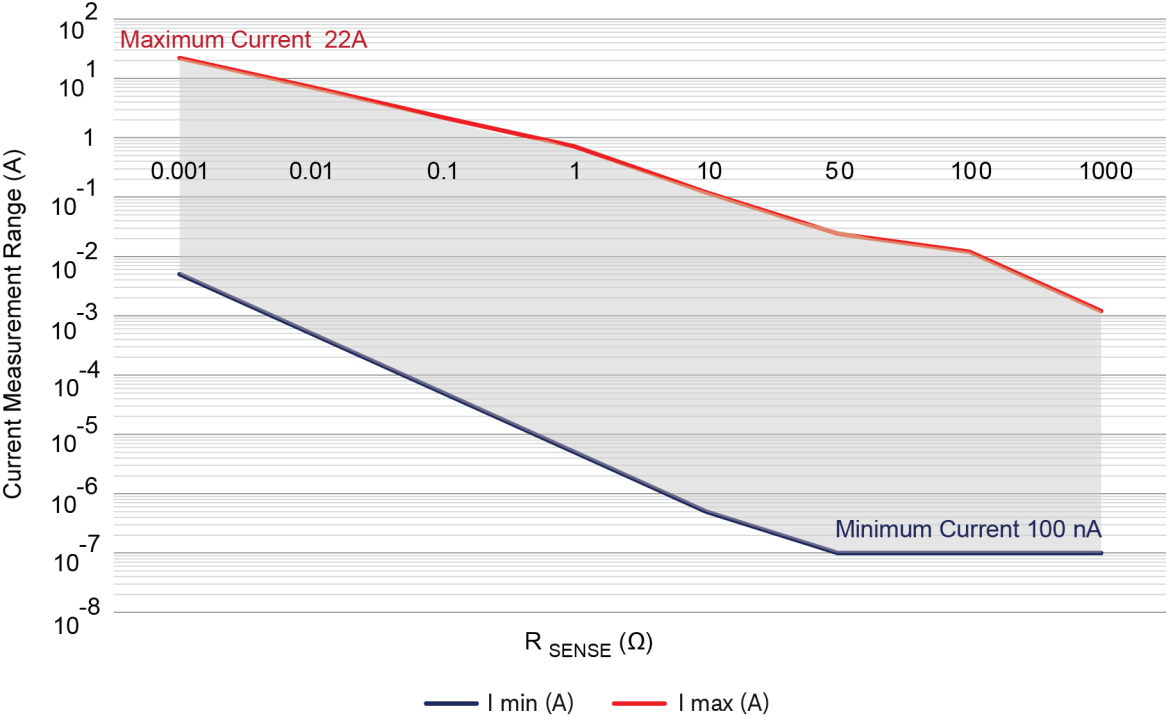

Figure 36 Minimum/maximum current measurement range with N2825A head, 500 mW R_{sense} , solder attached, high resolution mode on

5 Characteristics and Specifications

Current Range Vs. R_{SENSE} Graphs

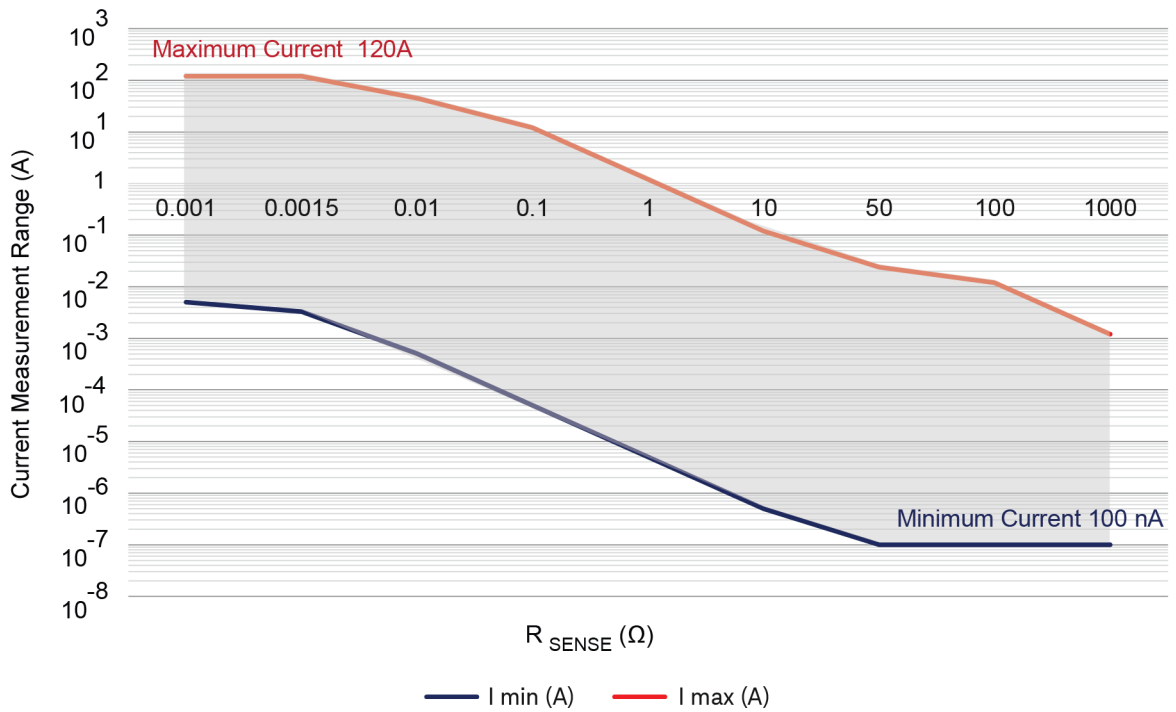

Figure 37 Minimum/maximum current measurement range with N2825A head, 20 W R_{sense} , solder attached, high resolution mode on

Maximum Current Measurement Ranges for Probe Heads

NOTE

Few points to remember while interpreting the graphs and equations included in this topic:

- Supply Voltage (V_{supply}) refers to the voltage of the power rail that you are measuring with the probe. The maximum V_{supply} for these probes can be $\pm 12V$.
- The voltage printed on these probes is the probe's maximum non-destructive input voltage ($\pm 15V$). This means that the probes may be used with input voltages up to $\pm 15V$ but are not designed to measure a power rail with voltages beyond $\pm 12V$.
- The larger the supply voltage, the smaller the available current measurement range for the probe head. This is reflected in the current measurement graphs in this topic.
- Since the probe has two different outputs (zoomed-in and zoomed-out), each with a different gain, the probe heads have different current measurement ranges for zoomed-in and zoomed-out channels. Separate graphs are provided in this topic for these two modes. Exceeding these current measurement ranges results in probe's input saturation and may result in the signal being clipped on the screen.

Zoomed-out Maximum Current Measurement Ranges for the N2822A and N2824A Probe Heads

Probe Head	Maximum Current Measurement Range
N2822A (20m Ω)	$\pm 5A$ peak
N2824A (100m Ω)	$\pm 2.25A$ peak

NOTE

These current measurement ranges are:

- limited by the maximum probe-head power rating of 500 mW.
- NOT limited by the supply voltage. The supply voltage range is $\pm 12V$.

5 Characteristics and Specifications

Maximum Current Measurement Ranges for Probe Heads

Zoomed-in Maximum Current Measurement Range for the N2822A Probe Head

For the zoomed-in probe input, the following graph shows the typical current measurement range allowed based on the supply voltage that you are measuring. For example, when using an N2822A and measuring a 5V input, the current range is 2.25A peak.

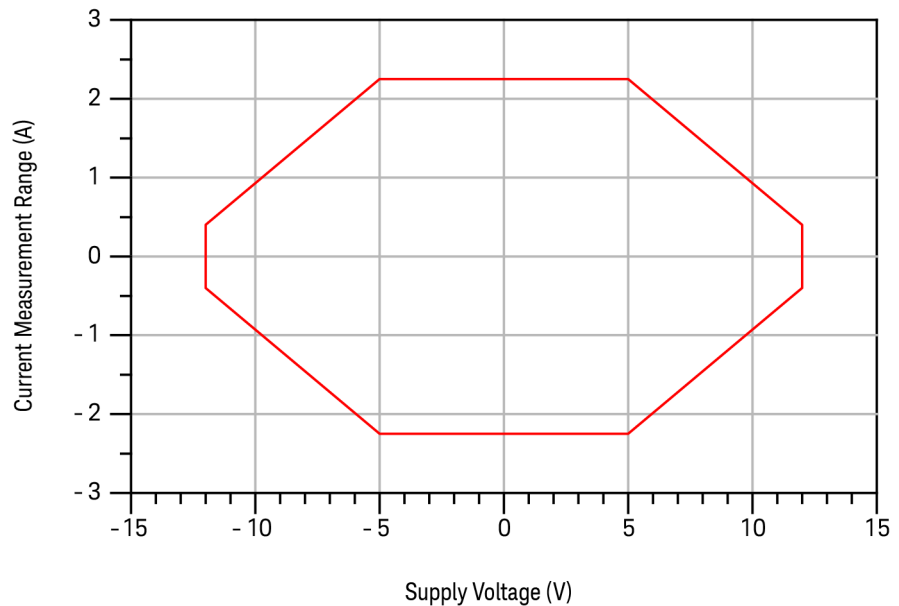

Figure 38 N2822A zoomed-in current measurement range versus supply voltage

NOTE

- This current measurement range is limited by:
- the maximum probe-head power rating of 500 mW.
 - the supply voltage. The supply voltage range is $\pm 12V$.

The following equations describe the current measurement range depicted in the above graph.

Supply Voltage Range	Maximum Current Measurement Range
>=0V to ≤5V	± 2.25A peak
>5V to ≤ 12V	± (.07143 - (.005286 x Vsupply))/0.02A peak <i>Example: When the Vsupply is ±12V, the current measurement range is ± .4A peak.</i>

Zoomed-in Maximum Current Measurement Range for the N2824A Probe Head

For the zoomed-in probe input, the following graph shows the typical current measurement range allowed based on the supply voltage that you are measuring. For example, when using an N2824A head and measuring a 5V input, the current range is 0.45A peak.

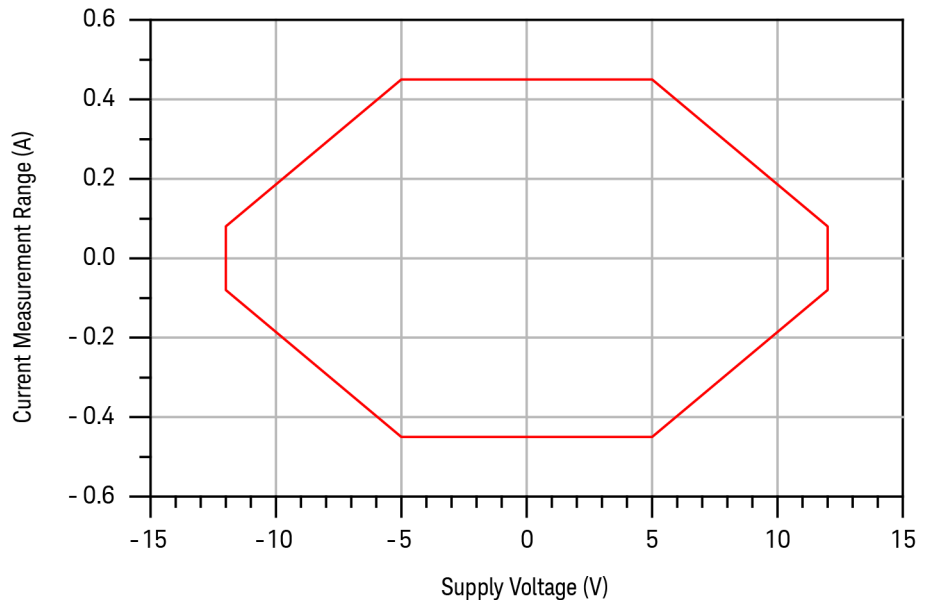

Figure 39 N2824A zoomed-in current measurement range versus supply voltage

5 Characteristics and Specifications

Maximum Current Measurement Ranges for Probe Heads

NOTE

This current measurement range is limited by:

- the maximum probe-head power rating of 500 mW.
- the supply voltage. The supply voltage range is $\pm 12V$.

The following equations describe the current measurement range depicted in the above graph.

Supply Voltage Range	Maximum Current Measurement Range
$>=0V$ to $\leq 5V$	$\pm 0.45A$ peak
$>5V$ to $\leq 12V$	$\pm (.07143 - (.005286 \times V_{supply}))/ .1A$ peak Example: When the V_{supply} is $\pm 12V$, the current measurement range is $\pm .08A$ peak.

Zoomed-in Maximum Current Measurement Range for the N2825A Probe Head

For the zoomed-in probe input, the following graph shows the typical current measurement range allowed with N2825A based on the supply voltage that you are measuring. For example, when using an N2825A head and measuring a 5V input, the current range is $.045/R_{sense}$ A peak.

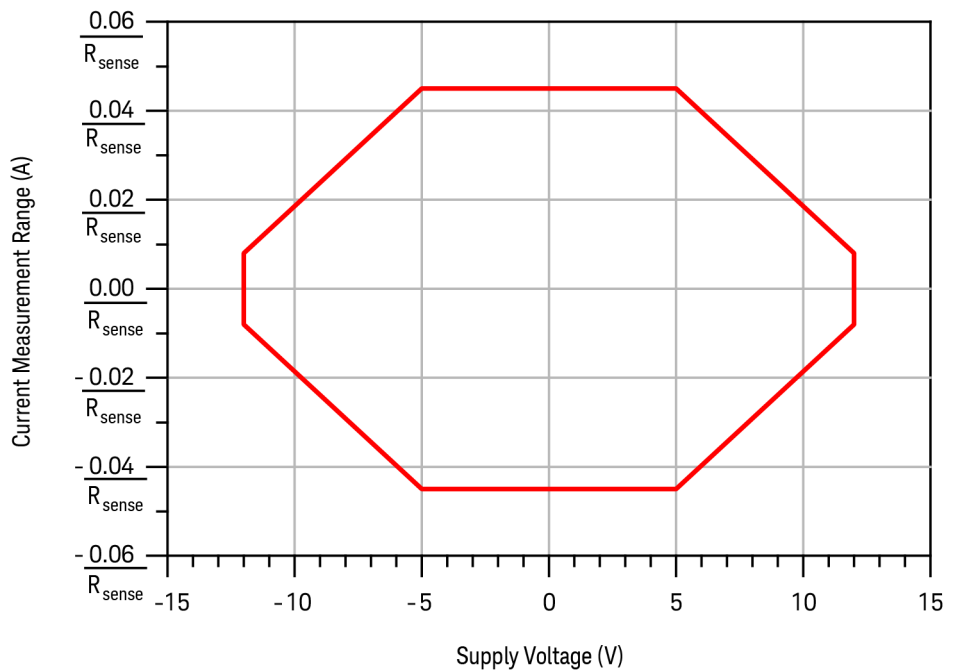

Figure 40 N2825A zoomed-in current measurement range versus supply voltage

NOTE

The current measurement range with N2825A head changes based on whether you are using an external or internal current sense resistors (R_{sense}) with this probe head.

- If an internal R_{sense} is used, the maximum current should not exceed 5A or cause the power dissipation in R_{sense} to exceed 0.5Watts.
- If an external R_{sense} is used, very high currents can be measured, but the current measurement range will still be limited by the maximum currents listed below or by the power rating of R_{sense} .

5 Characteristics and Specifications

Maximum Current Measurement Ranges for Probe Heads

The following equations describe the current measurement range depicted in the above graph.

Supply Voltage Range	Maximum Current Measurement Range (Amps)
>=0V to ≤5V	$\pm 0.45/R_{\text{sense peak}}$
>5V to ≤ 12V	$\pm (.07143 - (.005286 \times V_{\text{supply}}))/R_{\text{sense peak}}$

NOTE

The currents listed above are the absolute maximums for a given R_{sense} but would result in high burden voltages (that is, the DC drop across R_{sense}).

When measuring high currents, the value of R_{sense} should be reduced to limit the burden voltage to an acceptable level.

Zoomed-out Maximum Current Measurement Range for the N2825A Probe Head

For the zoomed-out probe input, the following graph shows the typical current measurement range allowed with N2825A based on the supply voltage that you are measuring. For example, when using an N2825A head and measuring a 5V input, the current range is $6.75/R_{\text{sense}}$ A peak.

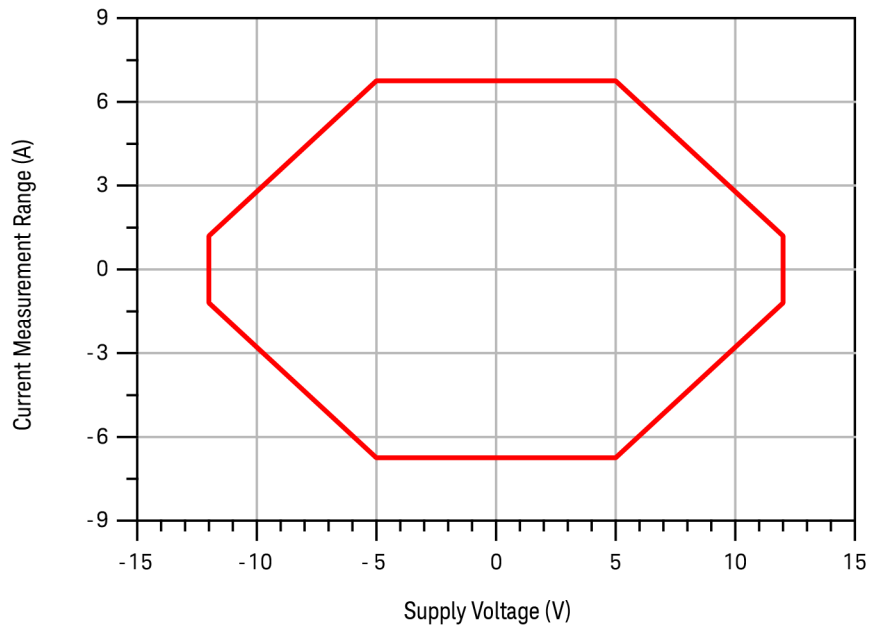

Figure 41 N2825A zoomed-out current measurement range versus supply voltage

NOTE

The current measurement range with N2825A head changes based on whether you are using an external or internal current sense resistors (R_{sense}) with this probe head.

- If an internal R_{sense} is used, the maximum current is when the power in R_{sense} is 0.5W.

- If an external R_{sense} is used, very high currents can be measured, but the current measurement range will still be limited by the maximum currents listed below or by the power rating of R_{sense} .

5 Characteristics and Specifications

Maximum Current Measurement Ranges for Probe Heads

The following equations describe the current measurement range depicted in the above graph.

Supply Voltage Range	Maximum Current Measurement Range (Amps)
>=0V to ≤5V	$\pm 6.75/R_{\text{sense peak}}$
>5V to ≤12V	$\pm (10.72 - (.7929 \times V_{\text{supply}}))/R_{\text{sense peak}}$

NOTE

The currents listed above are the absolute maximums for a given R_{sense} but would result in high burden voltages (that is, the DC drop across R_{sense}).

When measuring high currents, the value of R_{sense} should be reduced to limit the burden voltage to an acceptable level.

Dimensions

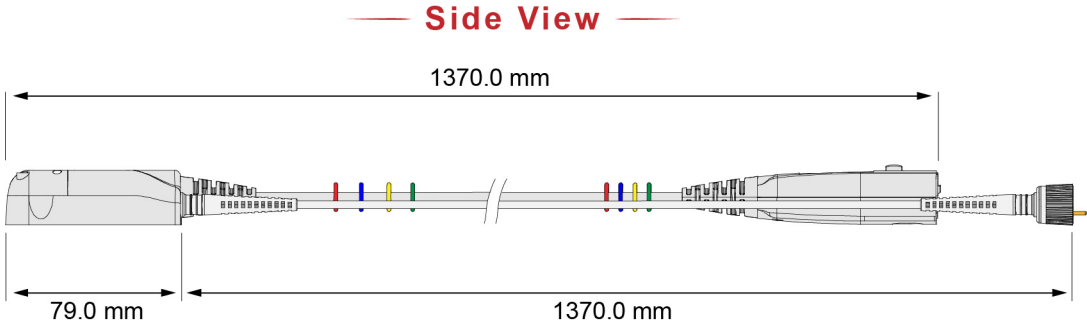

Front View

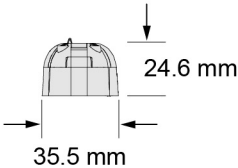

Socket / MBB Receptacle

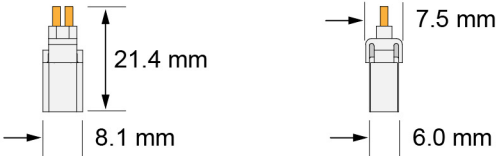

Sensor Leads

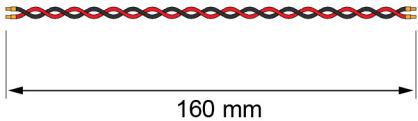

MBB Header

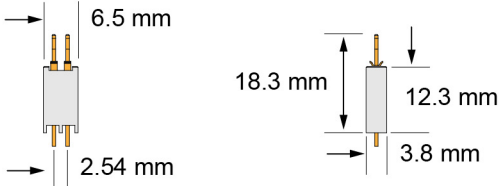

Drawing Not To Scale

Figure 42 Probe and Tip Dimensions

5 Characteristics and Specifications Dimensions

6 Performance Data Plots

N2820A Frequency Response /	92
N2820A Common Mode Rejection Ratio /	94
N2820A Step Response /	95
N2820A Step Tracking /	96
N2820A Input Impedance /	98
Input Load Model /	99

This chapter provides the performance plots for the N2820A.

N2820A Frequency Response

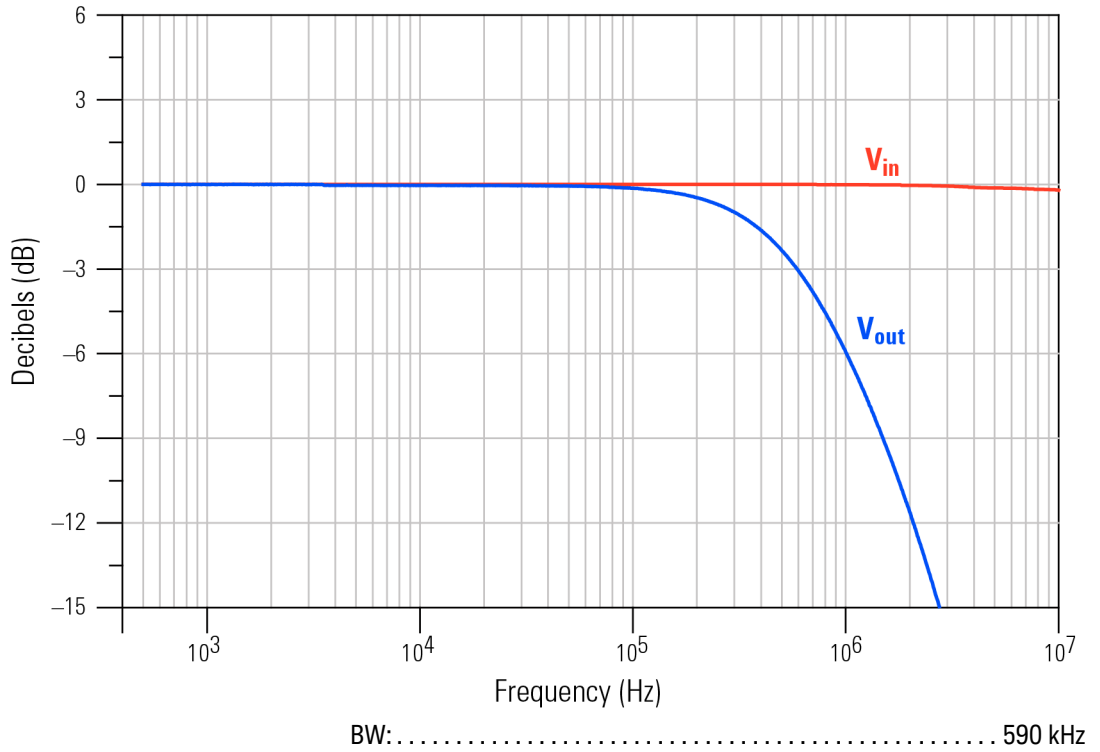
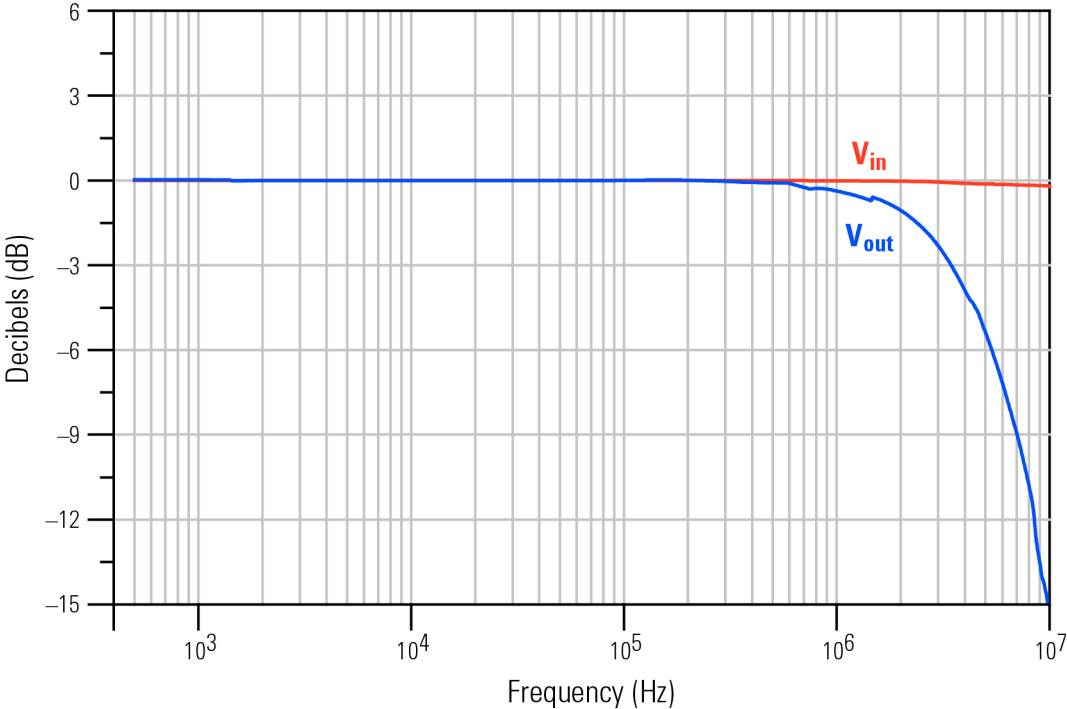

Figure 43 Frequency Response, Zoomed-In Channel



BW: 3.5 MHz

Figure 44 Frequency Response, Zoomed-Out Channel

N2820A Common Mode Rejection Ratio

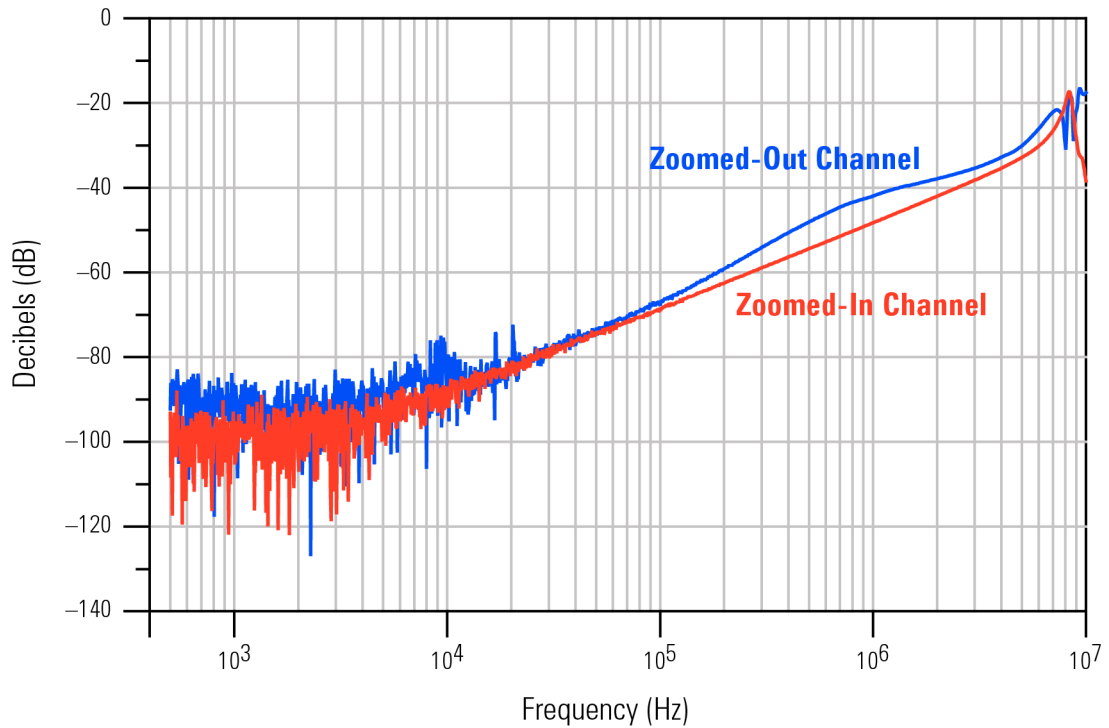
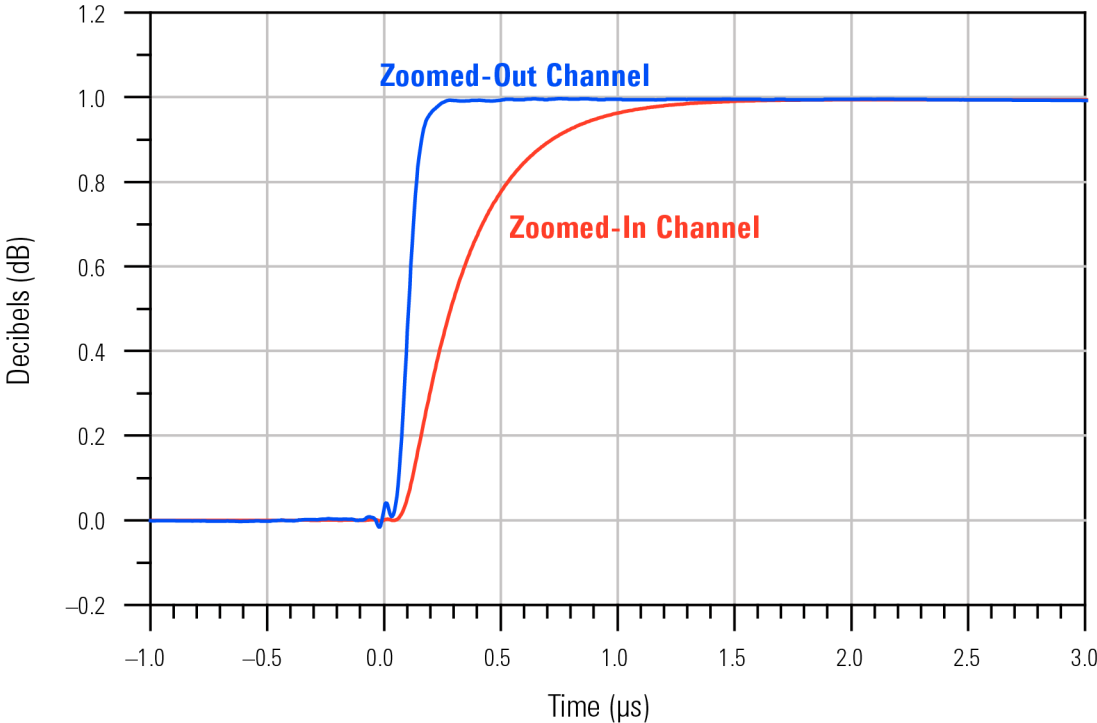

Figure 45 Common Mode Rejection Ratio (CMRR)

N2820A Step Response



Zoomed-In Channel

- 10–90% rising edge step: 584.2 ns
- 20–80% rising edge step: 365.8 ns

Zoomed-Out Channel

- 10–90% rising edge step: 96.76 ns
- 20–80% rising edge step: 63.33 ns

Figure 46 Step Response

N2820A Step Tracking

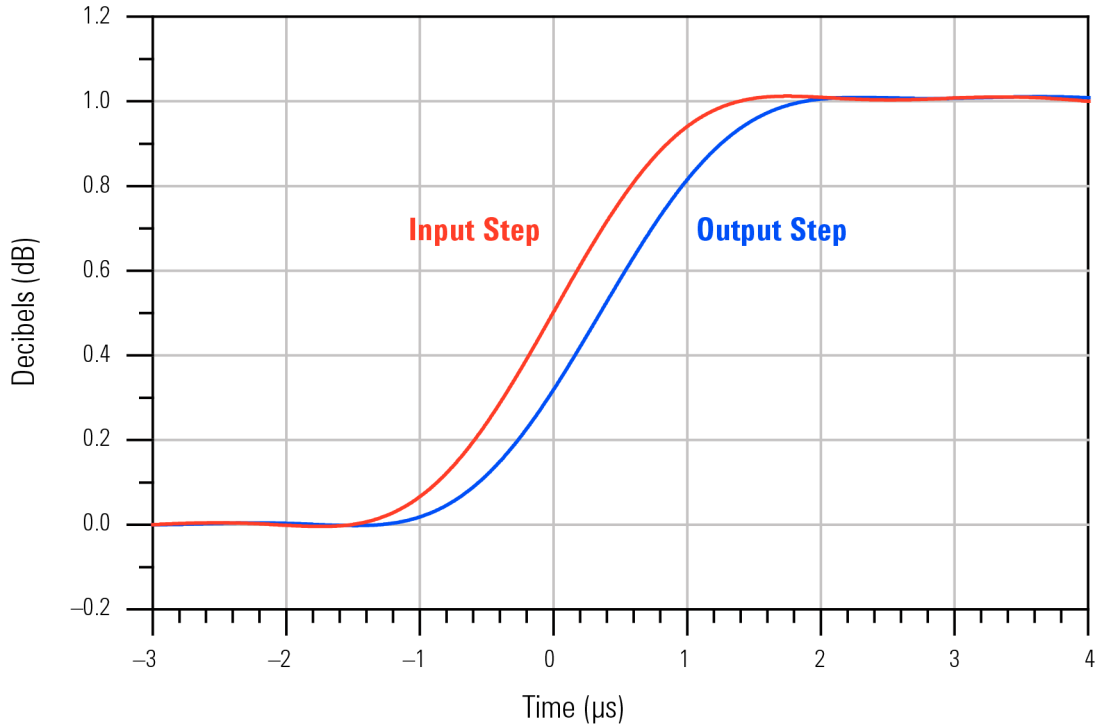

Input Step

10-90% Rise Time: 1.688 μs

20-80% Rise Time: 1.153 μs

Output Step

10-90% Rise Time: 1.769 μs

20-80% Rise Time: 1.204 μs

Figure 47 Zoomed-In Channel Step Tracking

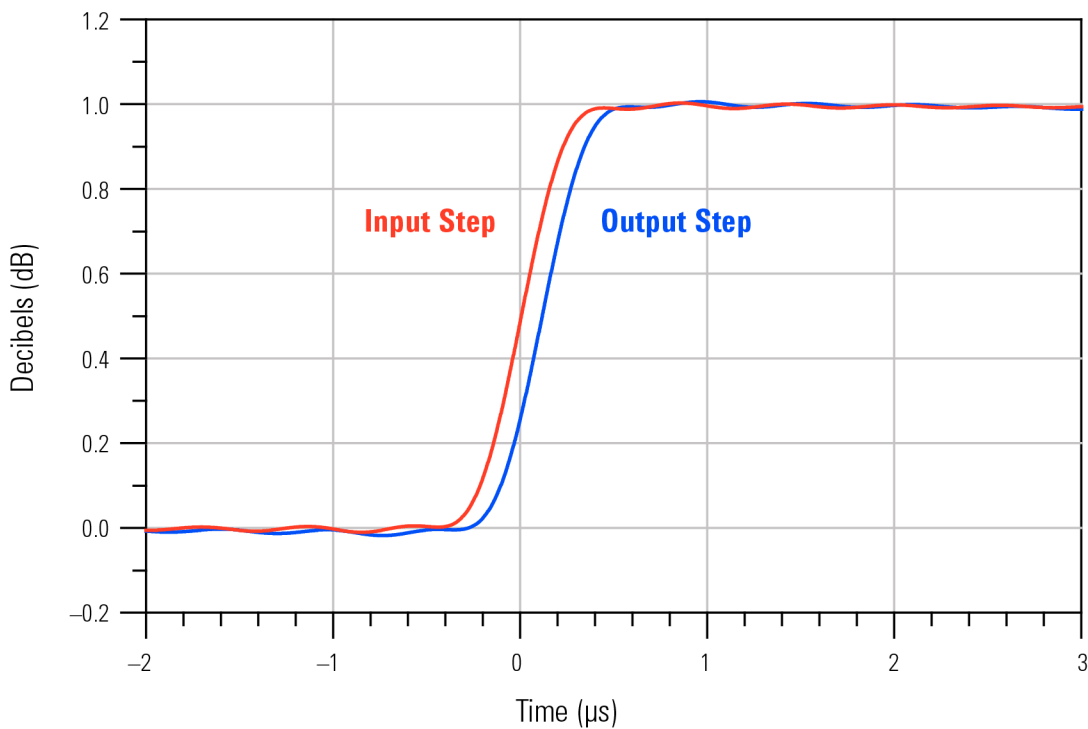

Input Step

10–90% Rise Time: 446.9 ns
 20–80% Rise Time: 299.8 ns

Output Step

10–90% Rise Time: 450.0 ns
 20–80% Rise Time: 302.6 ns

Figure 48 Zoomed-Out Channel Step Tracking

N2820A Input Impedance

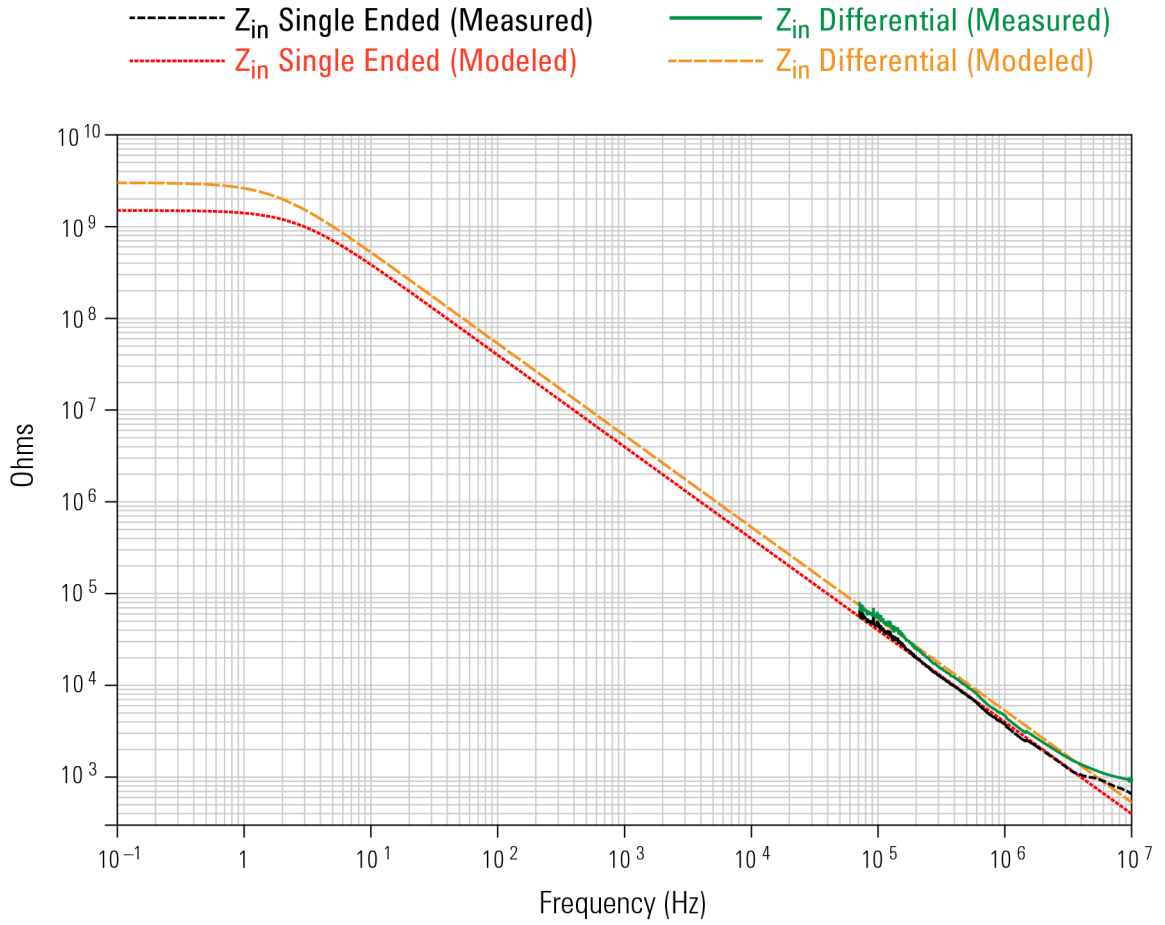

Figure 49 Input Impedance

Input Load Model

Z_{in} Single Ended: 1.5 G Ω
 Z_{in} Differential: 3 G Ω

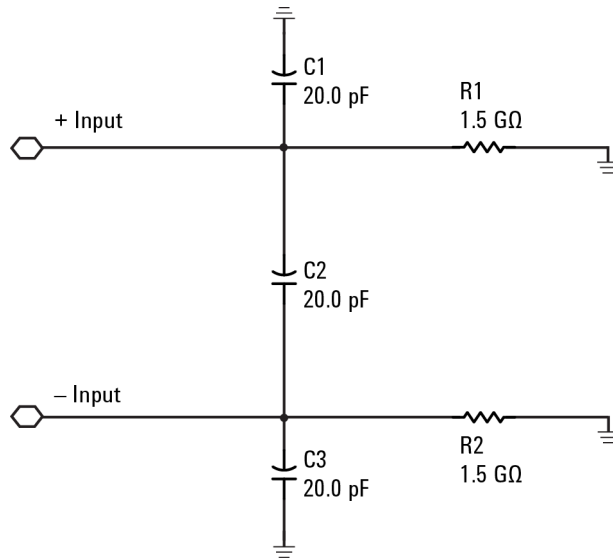

Figure 50 Input Load Model

6 Performance Data Plots
Input Load Model

7 Performance Verification

Average Gain of Zoomed-In Channel / 103
Average Gain of Zoomed-Out Channel / 107
Performance Test Record / 111

This chapter describes how to verify the performance of the N2820A and N2821A probes. The performance verification requires an N2825A probe head and consists of verifying the probe's DC gain.

NOTE

The Average Gain verified in this chapter is listed as Gain in [Table 10](#), “Characteristics and Specifications,” on page 75.

NOTE

The performance measured in this procedure is for the probe by itself. Keysight high performance real-time scopes apply probe correction that will further enhance the performance of the probes.

NOTE



Keysight recommends a test interval of one year or 2000 hours of operation.

CAUTION

Electrostatic discharge (ESD) can quickly and imperceptibly damage or destroy high performance probes, resulting in costly repairs. Always wear a wrist strap when handling probe components and insure that cables are discharged before being connected.

7 Performance Verification

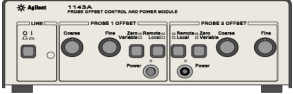
Table 12 Required Test Equipment

Test Equipment	Recommended Model	
Digital Multimeter	General purpose instrument for DC voltage measurement.	
DC Power Supply	Recommended: $\pm 20V$ Maximum: $\leq \pm 35V$	
Probe Power Supply	Keysight 1143A Probe Offset Control and Power Module	
Probe Adapter	Keysight N1022A/B Probe Adapter.	
Adapters	3.5 mm-to-BNC BNC-to-banana	

Average Gain of Zoomed-In Channel

This procedure applies to both N2820A and N2821A probes.

NOTE

Allow the probe to warm up for at least 20 minutes.

- 1 Snap an N2825A head onto the N2820/1A probe and connect the test equipment as shown in Figure 51. Be sure to connect the positive side of the DC supply to the red lead on the N2825A head.

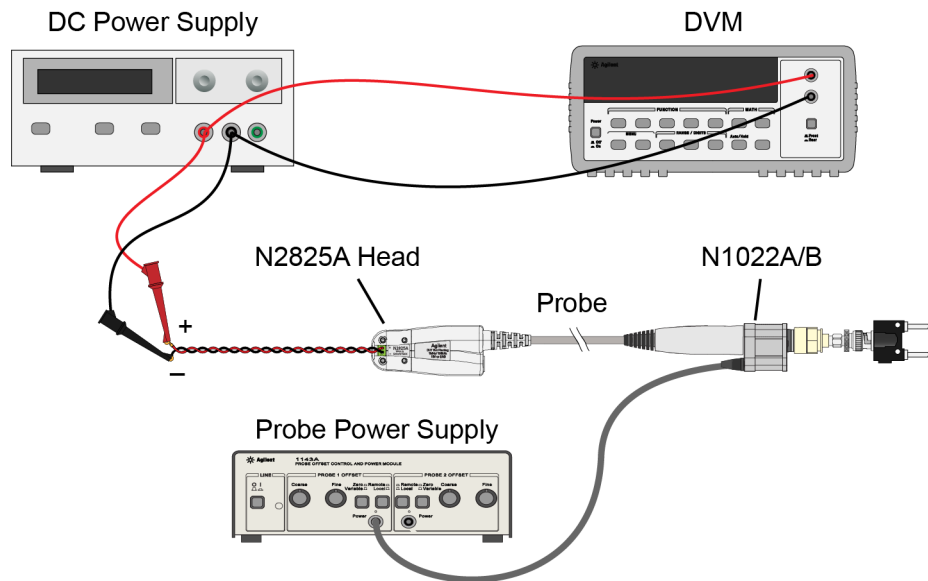

Figure 51 Test Setup for Measuring V_{in}

- 2 Set the DC power supply to +20 mV.

NOTE

Although this is the recommended setting, you can use any voltages up to +35 mV.

7 Performance Verification

Average Gain of Zoomed-In Channel

- 3 Record the value of $+V_{in}$ measured on the multimeter:

$+V_{in}$: _____

- 4 Move the multimeter's leads to the banana plug on the output of the N1022A/B as shown in Figure 52.

- 5 Record the value of $+V_{out}$ measured on the multimeter:

$+V_{out}$: _____

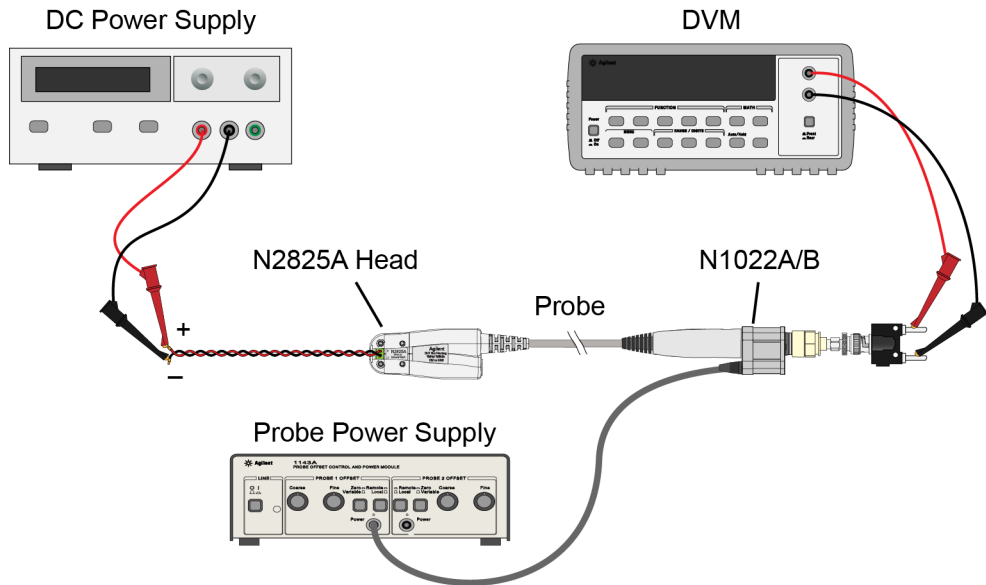

Figure 52 Test Setup for Measuring V_{out}

- 6 Calculate the positive gain of the zoomed-in (primary) channel and record the result in the following line:

$$\text{positive gain} = \frac{+V_{\text{out}}}{+V_{\text{in}}}$$

positive gain: _____

- 7 Set the DC power supply to -20 mV.

NOTE

Although this is the recommended setting, you can use any negative voltage less than -35 mV.

- 8 Connect the multimeter on the DC power supply as shown in [Figure 51](#) on page 103.

- 9 Record the value of $-V_{\text{in}}$ measured on the multimeter:

$-V_{\text{in}}$: _____

- 10 Connect the multimeter's leads to the banana plug on the output of the N1022A/B as shown in [Figure 52](#) on page 104.

- 11 Record the value of $-V_{\text{out}}$ measured on the multimeter:

$-V_{\text{out}}$: _____

- 12 Calculate the negative gain of the zoomed-in (primary) channel and record the result in the following line:

$$\text{negative gain} = \frac{-V_{\text{out}}}{-V_{\text{in}}}$$

negative gain: _____

- 13 Calculate the average of the two gains:

7 Performance Verification
Average Gain of Zoomed-In Channel

$$\text{average gain} = \frac{\text{positive gain} + \text{negative gain}}{2}$$

average gain (zoomed-in): _____

- 14** The average gain (zoomed-in) should be 300 ±3%. Enter the value in [Table 13](#) on page 111.

Average Gain of Zoomed-Out Channel

Perform this procedure *only* for N2820A probes.

NOTE

Allow the probe to warm up for at least 20 minutes.

- 1 Snap an N2825A head onto the N2820/1A probe and connect the test equipment as shown in Figure 53. Be sure to connect the positive side of the DC supply to the red lead on the N2825A head.

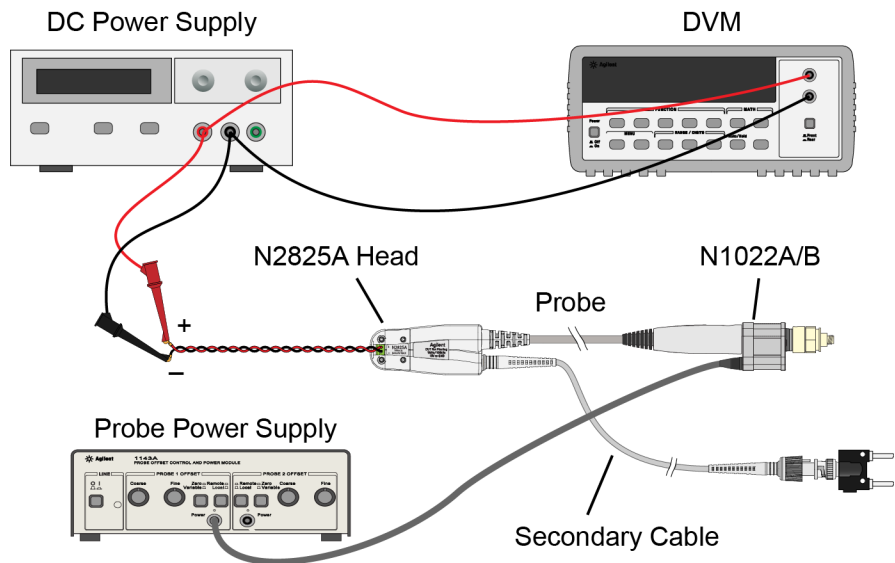

Figure 53 Test Setup for Measuring V_{in}

- 2 Set the DC power supply to +500 mV.

NOTE

Although this is the recommended setting, you can use any voltage up to +700 mV.

$$\text{positive gain} = \frac{+V_{\text{out}}}{+V_{\text{in}}}$$

positive gain: _____

- 7 Set the DC power supply to -500 mV.

NOTE

Although this is the recommended setting, you can use any negative voltage less than -700 mV.

- 8 Connect the multimeter on the DC power supply as shown in [Figure 53](#) on page 107.

- 9 Record the value of $-V_{\text{in}}$ measured on the multimeter:

$-V_{\text{in}}$: _____

- 10 Connect the multimeter's leads to the banana plug on the output of the N1022A/B as shown in [Figure 54](#) on page 108.

- 11 Record the value of $-V_{\text{out}}$ measured on the multimeter:

$-V_{\text{out}}$: _____

- 12 Calculate the negative gain of the zoomed-out (secondary) channel and record the result in the following line:

$$\text{negative gain} = \frac{-V_{\text{out}}}{-V_{\text{in}}}$$

negative gain: _____

- 13 Calculate the average of the two gains:

7 Performance Verification
Average Gain of Zoomed-Out Channel

$$\text{average gain} = \frac{\text{positive gain} + \text{negative gain}}{2}$$

average gain (zoomed-out): _____

- 14** The average gain (zoomed-out) should be $1.97 \pm 3\%$. Enter the value gain in **Table 13** on page 111.

Performance Test Record

The Average Gain recorded in **Table 13** is listed as Amplitude Accuracy in **Table 10**, “Characteristics and Specifications,” on page 75.

Table 13 N2820/1A Performance Test Record

Model #:	Date:	Tested by:	
Recommended next test date:			
Recommended Test Interval: 1 year / 2000 hours			
Probe Amplifier	Test Limits	Result	Pass/Fail
Average Gain of Zoomed-In Channel (N2820/1A)			
Average Gain (zoomed-in)	300±3%		
Average Gain of Zoomed-Out Channel (N2820A only)			
Average Gain (zoomed-out)	1.97±3%		

7 Performance Verification
Performance Test Record

Index

Numerics

1143A Probe Offset Control and Power Module, 102

A

accessories
 replacement, 11
 supplied, 10
Ah, 34, 36

B

battery-powered devices, 33
burden voltage, 47

C

cable
 primary, 6
 secondary, 6
cables, 6
calibration
 probe, 65
CE mark, 19
channel identification rings, 9
Charge Full Screen measurement, 37
Charge measurement, 34, 36
Charge N Cycles measurement, 37
cleaning, 6
compatible oscilloscopes, 7
configuring
 Infiniium, 31
 InfiniiVision, 31
connecting probe, 28
CSA mark, 19
current consumption, 34, 36
current range, 78

D

dimensions, 89
dual-grid view, 8, 38
dynamic range

and R-Sense resistor, 49

F

floating devices, 33

G

gain calibration, 68
Gate to Zoom Window, 35
Gerber file, MBB header, 45
ground lead, 10, 33

H

header, 41
High Resolution settings, 40

I

ID resistor, 55
Infiniium
 configuring, 31
Infiniium oscilloscope, 38
InfiniiVision
 configuring, 31
inspecting, 12
ISM1-A, 19

K

Keysight Technologies, contacting, 13

L

leads, 24, 25

M

make-before-break connector, 9
maximum power dissipation, 22
MBB connector, 41
MBB header, 10
 Gerber file, 45
MBB receptacle, 10

Meas key, 37
measurement, Charge, 34, 36
mobile phone, 33, 34, 36, 49

N

N1022B probe adapter, 102
N2822/4A current range, 78
N2822A probe head, 11, 22
N2824A probe head, 11, 22
N2825A user-defined head, 11, 51
 marking, 60
N2826A, 11
N2827A secondary cable, 11
N2828A replacement MBB Kit, 11
N2829A replacement MBB Kit, 11

O

oscilloscope
 compatibility, 7
 Infiniium, 29, 38
 InfiniiVision, 31
 Probe Configuration dialog box, 29, 52, 54

P

performance test record, 111
performance verification, 101
phone, mobile, 33, 34, 36
Pomona 3781-12-2 patch cord, 70
Pomona 3788 test clips, 66
power dissipation, maximum, 22
primary cable, 28
Primary Channel Output field, 30
probe
 cleaning, 6
 configuration, 29, 52, 54
 connecting, 28
 inspecting, 12
 leads, 24, 25
 N2820A connection order, 28
 service, 13
probe calibration, 65

Index

Probe Configuration dialog box, 29, 52, 54, 59

Probe Configuration menu, 29, 52, 54

probe head

ID resistor, 55

N2822/4A, 22

N2825A, 51

probe power supply, 102

Probe softkey, 31, 53, 64

probing connections, choices, 23

zoom, 38

Z

Zoom Mode, 34

zoom windows, 38

turning off, 39

zoom-in, 8

Zoom-In softkey, 31

zoom-out, 8

R

receptacle, 41

replacement kits, 11

returning for service, 13

RSENSE resistors, 5

R-Sense softkey, 31, 53, 64

S

safety, 15

Safety Considerations, 15

safety warnings, 15

secondary cable, 11, 28

connecting, 27

sensor leads, 11

socket, 10

socketed lead, 41

specifications, 75

T

twisted leads, 10

Type

softkey, 37

U

User Def Head Resistance field, 30

user-defined head, 51

V

voltage, burden, 47

W

windows



This information is subject to
change without notice.
© Keysight Technologies 2019
November 2019



* N 2 8 2 0 - 9 7 0 0 7 *

www.keysight.com