

Keysight 1168/9B-Series Differential and Single-Ended Probes

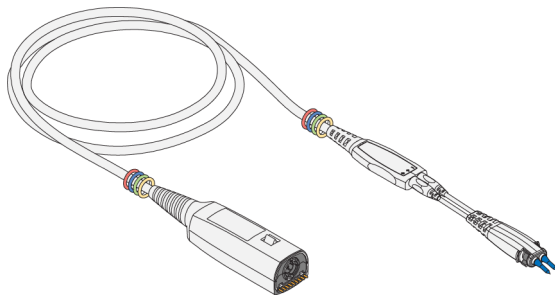

Notices

© Keysight Technologies, 2005 - 2019

No part of this manual may be reproduced in any form or by any means (including electronic storage and retrieval or translation into a foreign language) without prior agreement and written consent from Keysight Technologies, Inc. as governed by United States and international copyright laws.

Manual Part Number

01169-97027

Edition

Twelfth Edition, July 2019

Published by:
Keysight Technologies, Inc.

1900 Garden of the Gods Road
Colorado Springs, CO 80907 USA

Warranty

The material contained in this document is provided “as is,” and is subject to being changed, without notice, in future editions. Further, to the maximum extent permitted by applicable law, Keysight disclaims all warranties, either express or implied, with regard to this manual and any information contained herein, including but not limited to the implied warranties of merchantability and fitness for a particular purpose. Keysight shall not be liable for errors or for incidental or consequential damages in connection with the furnishing, use, or performance of this document or of any information contained herein. Should Keysight and the user have a separate written agreement with warranty terms covering the material in this document that conflict with these terms, the warranty terms in the separate agreement shall control.

Technology Licenses

The hardware and/or software described in this document are furnished under a license and may be used or copied only in accordance with the terms of such license.

U.S. Government Rights

The Software is "commercial computer software," as defined by Federal Acquisition Regulation ("FAR") 2.101. Pursuant to FAR 12.212 and 27.405-3 and Department of Defense FAR Supplement ("DFARS") 227.7202, the U.S. government acquires commercial computer software under the same terms by which the software is customarily provided to the public. Accordingly, Keysight provides the Software to U.S. government customers under its standard commercial license, which is embodied in its End User License Agreement (EULA), a copy of which can be found at <http://www.keysight.com/find/sweula>. The license set forth in the EULA represents the exclusive authority by which the U.S. government may use, modify, distribute, or disclose the Software. The EULA and the license set forth therein, does not require or permit, among other things, that Keysight: (1) Furnish technical information related to commercial computer software or commercial computer software documentation that is not customarily provided to the public; or (2) Relinquish to, or otherwise provide, the government rights in excess of these rights customarily provided to the public to use, modify, reproduce, release, perform, display, or disclose commercial computer software or commercial computer software documentation. No additional government requirements beyond those set forth in the EULA shall apply, except to the extent that those terms, rights, or licenses are explicitly required from all providers of commercial computer software pursuant to the FAR and the DFARS and are set forth specifically in writing elsewhere in the EULA. Keysight shall be under no obligation to update, revise or otherwise modify the Software. With respect to any technical data as defined by FAR 2.101, pursuant to FAR 12.211 and 27.404.2 and DFARS 227.7102, the U.S. government acquires no greater than Limited Rights as defined in FAR 27.401 or DFAR 227.7103-5 (c), as applicable in any technical data. 52.227-14

(June 1987) or DFAR 252.227-7015 (b)(2) (November 1995), as applicable in any technical data.

Safety Notices

CAUTION

A **CAUTION** notice denotes a hazard. It calls attention to an operating procedure, practice, or the like that, if not correctly performed or adhered to, could result in damage to the product or loss of important data. Do not proceed beyond a **CAUTION** notice until the indicated conditions are fully understood and met.

WARNING

A **WARNING** notice denotes a hazard. It calls attention to an operating procedure, practice, or the like that, if not correctly performed or adhered to, could result in personal injury or death. Do not proceed beyond a **WARNING** notice until the indicated conditions are fully understood and met.

Contents

1 Getting Started

- Introduction 8
- Probe Handling 12
- Using Offset With InfiniiMax Active Probes 16
- Slew Rate Requirements for Different Technologies 19
- Available Accessories 20
- Safety Information 31
- Troubleshooting 33

2 Using Probe Heads

- Recommended Configurations 38
 - 1. MX0100A InfiniiMax Micro Probe Head 41
 - 2. N5381B Differential Solder-In 50
 - 3. N2839A Differential Browser 52
 - 4. N5382A Differential Browser 57
 - 5. N5380B SMA 60
 - 6. N5425B with N5426A ZIF Tip 63
 - 7. N5425B with N2884A Fine Wire ZIF Tip 64
 - 8. N2851A QuickTip Probe Head 67
 - 9. N5425B with N5451A Long-Wire ZIF Tip (7 mm) 71
 - 10. N5425B with N5451A Long-Wire ZIF Tip (11 mm) 73
 - 11. E2677B Differential Solder-In Probe Head 75
 - 12. E2678B Differential Socketed Probe Head 77
 - 13. E2675B Differential Browser 79
 - 14. E2679B Single-Ended Solder-in Probe Head 81
 - 15. E2676B Single-Ended Browser 82
 - 16. E2678B Differential Socketed & Damped Wire Accessory 84
- Soldering a ZIF Tip to a DUT 86
- Using N2884A Fine-Wire ZIF tips 90
- N2887A/8A Soft Touch Probe Heads 98

3 Maintaining Probe Heads

- MX0100A Micro Probe Heads 106
- N5381B/N5382A Probe Heads 109

N5451A Long-Wired ZIF Tips	114
E2677B/9A Solder-In Probe Heads	118

4 Calibrating Probes

DC Gain and Offset Calibration	124
Calibration for Solder-In and Socketed Probe Heads	125
Calibration for Hand-Held Browser Probe Heads	131
Calibration for N5380A/B SMA Probe Heads	133
N2887A & N2888A Calibration and Deskew Procedure	134

5 Characteristics and Specifications

General	138
InfiniiMax II Series with N5380B SMA Probe Head	141
Environmental	143
Probe Amplifier Dimensions	144
Probe Heads Dimensions	145

6 Performance Plots

MX0100A Micro Probe Head (Full BW)	152
N2839A Differential Browser Head (Full BW)	157
N5380B SMA Probe Head (Full BW)	162
N5380B SMA Probe Head with the 1134B InfiniiMax Probe	165
N5381B & N5382A Differential Probe Heads (Full BW)	166
N5381B Differential Solder-in Probe Head with 2x Longer Wires	171
N5425B ZIF Probe Head (Full BW)	172
N5425B ZIF Probe Head with N5451A Long-Wired ZIF Tip	176
N5426A ZIF Probe Tip Impedance	188
N2851A QuickTip Head with N2849A QuickTip	189
E2675B Differential Browser	190
E2676B Single-Ended Browser	192
E2677B Differential Solder-in Probe Head (High BW)	195
E2678B Differential Socketed Probe Head (High BW)	197
E2678B Differential Socketed Probe Head w/ Damped Wire	199
E2679B Single-Ended Solder-In Probe Head (High BW)	201
N2887A/N2888A Soft Touch Probe Heads	203

7 Performance Verification

To Test Bandwidth	206
To Test Input Resistance	215
Performance Test Record	219

8 SPICE Models

MX0100A Micro Probe Head	222
N5381B and N5382A Heads	224
N2839A Head	227
N5425B ZIF Head with N5426A ZIF Tip Attached	230
N5426A ZIF Tip	233
N5425B ZIF Head with N5451A Long-Wire ZIF Tip	236
N2851A QuickTip Head with N2849A QuickTip Tip	244
N2887A/N2888A Heads	245
InfiniiMax I Heads	247

9 Replacement Parts

N5381B and N5382A Probe Heads	258
N2839A Browser Head	258
E2679B Single-Ended Solder-in Probe Head	258
E2678B Differential Socketed Probe Head	259
E2677B Differential Solder-In Probe Head	260
E2675B Differential Browser Probe Head	260
Other Accessories	261

Index

1 Getting Started

Introduction	8
Probe Handling	12
Using Offset With InfiniiMax Active Probes	16
Slew Rate Requirements for Different Technologies	19
Available Accessories	20
E2669B Differential Connectivity Kit and Accessories	20
N2833A InfiniiMax II Differential Connectivity Kit and Accessories	21
N5450B Extreme Temp Cable Extension Kit	22
N2880A InfiniiMax In-Line Attenuator Kit	24
N2881A InfiniiMax DC Blocking Capacitors	28
MX0102A Soldering Toolkit	29
Safety Information	31
Troubleshooting	33

With the 1168B (10 GHz) and 1169B (12 GHz) probes, you can probe differential and single-ended signals. The probes provide a large common mode range for measuring differential signals and a large offset range for measuring single-ended signals. These probes are used at extreme frequencies where off-board lead resistors cause undesirable response variation. As a result, the 1168B and 1169B probes were designed using resistor-at-the-tip technology where resistors are located onto the very edge of the probe tip board. The wires or probe tips in front of the resistors are long enough to allow easy connection but are short enough that any resonances caused by them are out of band and don't impact the input impedance.

CAUTION

Before using the probes, refer to **"Probe Handling"** on page 12.

WARNING

Before using the probe, refer to **"Safety Information"** on page 31.

Introduction

Before you can use the probe, you must connect one of the available probe heads to an 1168/9B probe amplifier.

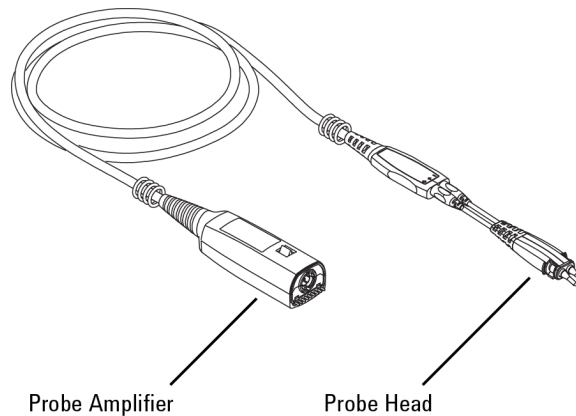

Figure 1 Probe Amplifier with Attached Head

Probe Heads

Figure 2 on page 9 shows the available probe heads and accessories. Six different InfiniiMax II probe heads can be used including a Zero Insertion Force (ZIF) probe head that uses a ZIF tip that can be installed at many locations on your DUT. The ZIF tip's small size is critical in probing tight locations and the ZIF feature allows connection without compressing the delicate wires which cannot support this compression. You can also use the probe amplifiers with the InfiniiMax I probe heads (with some limitations).

The differential probe heads offer easy measurement of differential signals and greatly improve the measurement of single-ended signals.

Each available probe head is documented in **Chapter 2**, "Using Probe Heads".

Compatible Oscilloscopes

Table 1 on page 10 lists the oscilloscopes that are compatible with the 1168/9B probes. Is Your Oscilloscope Software Up-to-Date? Keysight periodically releases Oscilloscope software updates to support your probe, fix known defects, and incorporate product enhancements. To download the latest firmware, go to www.keysight.com and search for your oscilloscope's topic. Click on the "Drivers, Firmware & Software" tab.

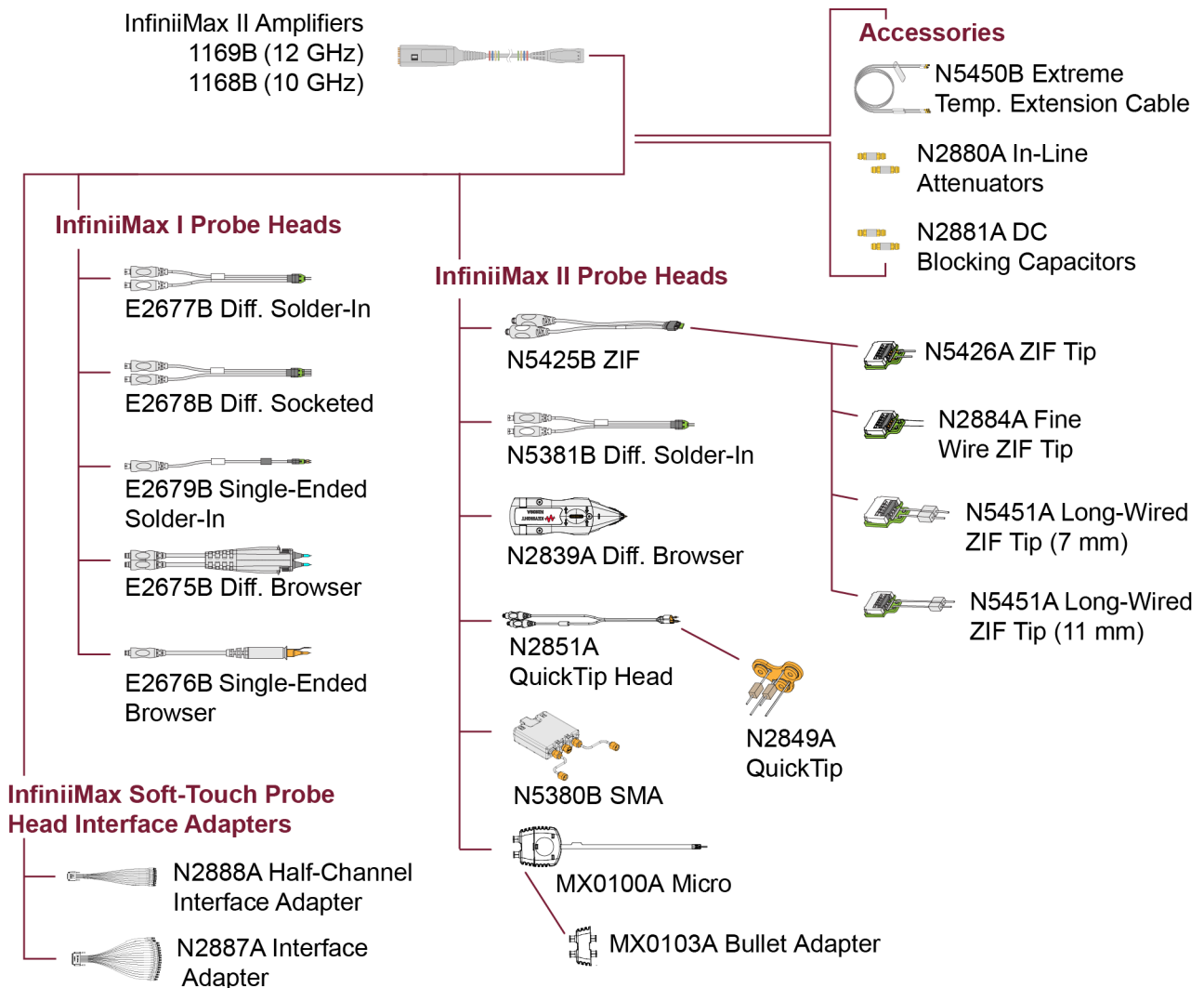

Figure 2 Available Probe Heads and Accessories

NOTE

N2849A QuickTips are also compatible with the N2848A InfiniiMode probe heads which are designed for N2830/1/2A and N7000/1/2/3A InfiniiMax III+ and N2800/1/2/3A InfiniiMax III probes.

These probes can also be used with other test instruments that have 50 ohm input such as a spectrum analyzer or 86100D DCA. For more information, check out the Keysight application note, 5989-1869EN.

Table 1 Compatible Infiniium Oscilloscopes

Oscilloscope	Model
S Series	all
V, 90000 X-, Q-, and Z-Series ^a	all
90000A Series	all
86100C/D Series ^b	all
80000B Series	all

a N5442A adapter required.

b N1022A/B adapter required.

NOTE

The 1168/69A InfiniiMax probes are not compatible with Keysight's InfiniiVision Series oscilloscopes.

Cleaning the probe

If the probe requires cleaning, disconnect it from the oscilloscope and clean it with a soft cloth dampened with a mild soap and water solution. Make sure the probe is completely dry before reconnecting it to the oscilloscope.

Channel Identification Rings

When multiple probes are connected to the oscilloscope, use the channel identification rings to associate the channel inputs with each probe. Place one colored ring near the probe's channel connector and place an identical color ring near the probe head.

Inspecting the Probe

- Inspect the shipping container for damage.
Keep the damaged shipping container or cushioning material until the contents of the shipment have been checked for completeness and the probe has been checked mechanically and electrically.
- Check the accessories.
- If the contents are incomplete or damaged, notify your Keysight Technologies Sales Office.
- Inspect the probe. If there is mechanical damage or defect, or if the probe does not operate properly or pass calibration tests, notify your Keysight Technologies Sales Office.

If the shipping container is damaged, or the cushioning materials show signs of stress, notify the carrier as well as your Keysight Technologies Sales Office. Keep the shipping materials for the carrier's inspection. The Keysight Technologies office will arrange for repair or replacement at Keysight Technologies' option without waiting for claim settlement.

Figure 3 shows the accessories that are shipped with the 1168/9B probe amplifiers. The probe amplifiers do not come with a probe head *unless* selected at the time of order. Any head shown in **Figure 2** on page 9 can be ordered at any time for the probes.

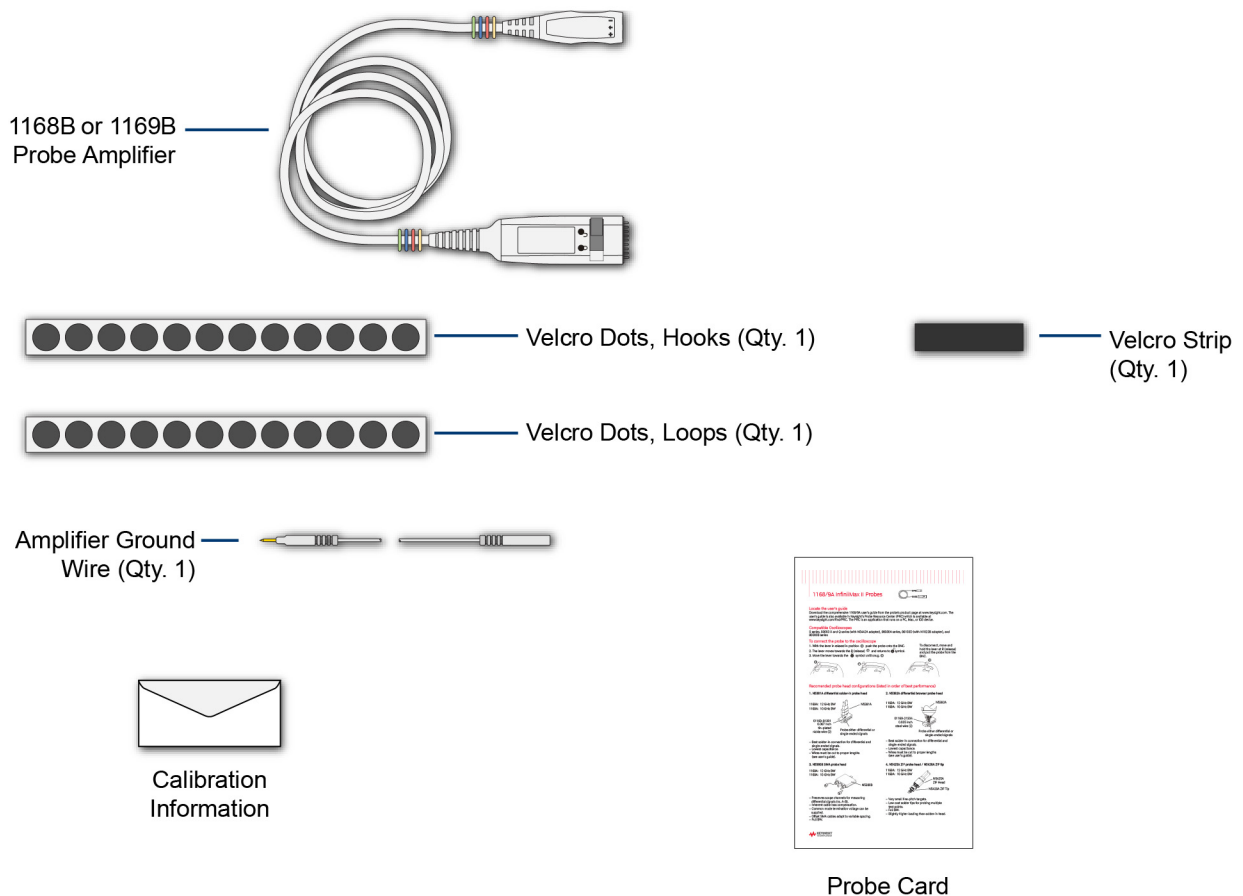

Figure 3 Accessories Supplied With the Probe Amplifier

Probe Handling

This probe has been designed to withstand a moderate amount of physical and electrical stress. However, with an active probe, the technologies necessary to achieve high performance do not allow the probe to be unbreakable. Treat the probe with care. It can be damaged if excessive force is applied to the probe tip. This damage is considered to be abuse and will void the warranty when verified by Keysight Technologies service professionals.

- Exercise care to prevent the probe end from receiving mechanical shock.
- Store the probe in a shock-resistant case such as the foam-lined shipping case which came with the probe.

Connecting and Disconnecting Probe Heads

When disconnecting a probe head from an amplifier, pull the probe head connectors straight out of the sockets as shown in **Figure 4**. When connecting a probe head to an amplifier, push straight in. Always grasp the indentations located on the sides of the amplifier as shown in **Figure 4**. There are also indentations on many of the probe head sockets so you have a convenient place to grasp there as well.

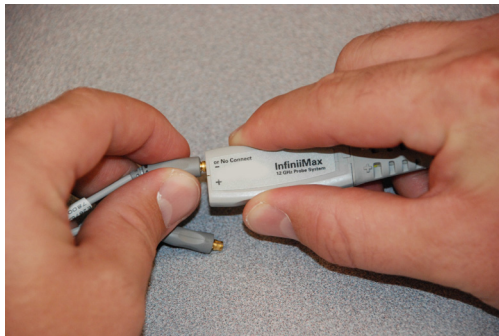

Figure 4 Properly Pulling the Probe Head Straight Out

CAUTION

Avoid damaging the connection pins. Never bend the probe head in order to “pop” it loose from the amplifier. Do not wiggle the probe head up and down or twist it to remove the connectors from the sockets.

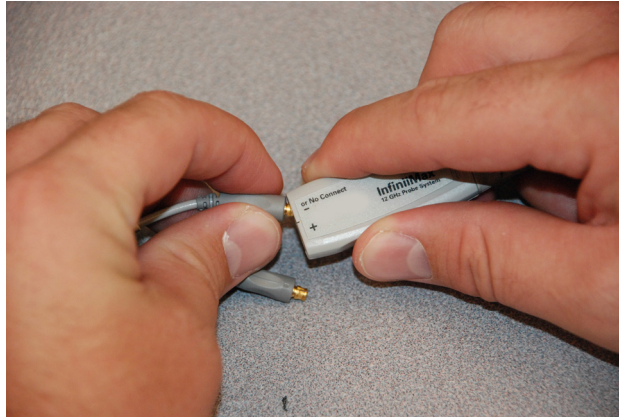

Figure 5 Improperly Disconnecting a Probe Head From an Amplifier

Handling the Probe Cable

CAUTION

Avoid degrading the probe's performance. Do not twist, kink, or tightly bend the probe's cable.

CAUTION

When the probe is attached to an oscilloscope, avoid letting object hit the probe cable where the cable exits the probe amplifier and bend it well beyond its limit.

When storing the probe, coil the cable in a large loops and avoid twisting the cable. Coil the cable in a similar manner to how garden hoses or extension cords are typically coiled. You can start by wrapping the cable around your thumb as shown in **Figure 6**. Then continue to circle your thumb, but provide a slight twist with each rotation. This allows the cable rotations to lie flat against each other and will eliminate the net twisting of the cable in the end.



Figure 6 Recommended Coil for Storage

CAUTION



Make the coil's radius fairly large so it does not induce kinking or bending.

Handling the Probe Amplifier

The probe amplifier contains a delicate circuit board. Treat it carefully and take standard precautions (for example, not dropping it repeatedly or from large heights, not getting it wet, not smashing it with heavy objects, etc.). These probes are sensitive ESD devices so standard precautions need to be used to not ruin the probe from the build-up of static charges.

Connecting the Probe to an Oscilloscope

The probes are only meant to be plugged into gold plated BNCs (like those on Infiniium oscilloscopes). To connect the probe to the oscilloscope, do the following steps:

- 1 As shown in **Figure 7**, with the lever in the relaxed position ① push the probe onto the BNC. The lever moves towards the **R** (release) ② and returns to the  symbol.
- 2 Move the lever towards the  symbol until snug. ③

NOTE

How far the locking mechanism can be pushed to the right varies and will not be the same for every user. Therefore, do not try to force it further to the right because you believe it is unlocked. Instead, gently push it until it is snug.

To disconnect the probe, move and hold the lever at **R** (release) ② and pull the probe from the BNC.

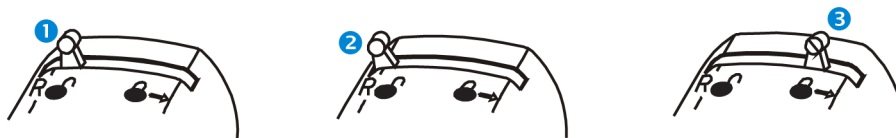

Figure 7 Properly Connecting a Probe to the Oscilloscope

Securing Probe Heads and Amplifiers to Your DUTs

When soldering a probe head to a circuit, first provide strain relief by using low temperature hot glue (use as little as possible) or non-conductive double-sided tape. Do not use super glue and do not get the low temperature hot glue on the actual probe head tip as this can damage the precision components of your probing system (only use the low temperature hot glue on the probe head cables). The provided velcro pads can be used to secure your probe amplifier casing to the board.

Once strain relief has been provided, solder the probe tip to the circuit board and then plug the probe head into the probe amplifier.

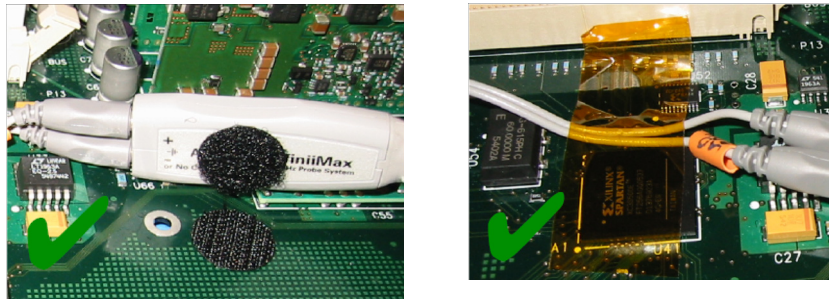

Figure 8 Correct Securing Methods

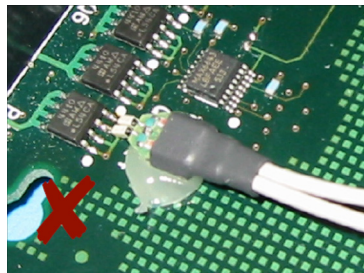

Figure 9 Incorrect Securing Method Because Glue is Placed on the Probe Head Tip

The velcro dots can be used to secure the probe amplifier to a circuit board removing the weight of the probe from the circuit connection. Attach a Velcro dots to both the probe amplifier and the circuit board as shown in **Figure 10**.

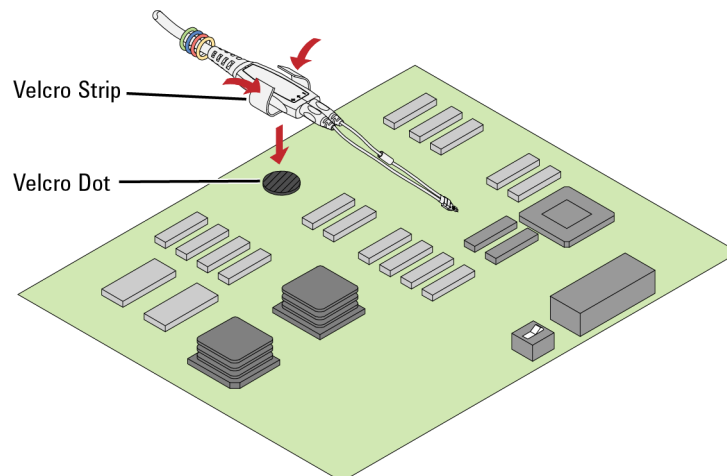

Figure 10 Using the Velcro Dots

Using Offset With InfiniiMax Active Probes

It is important to understand how the 1168/9B InfiniiMax probes behave with respect to offset when different probe head / signal combinations are used.

The purpose of offset in active probes or oscilloscope front ends is to allow the subtraction of most or all of the dc component of the input signal so the signal can better utilize the dynamic range of the input. When using an InfiniiMax probe with an Infiniium oscilloscope, you can select the case (see the three cases described below) that applies for your measurement by selecting the **Probes** button under the channel setup menu. This allows you to select which type of probe head is being used and, if it is a differential probe head, allows you to select whether you are probing a differential or single-ended signal. With these inputs, the oscilloscope will use the proper type of offset for your measurement case. The specifics for each case are discussed below.

When adjusting the offset for a particular probe head, make sure to have a triggered signal.

Case 1. A single-ended probe head probing a single-ended signal

For this case, the offset control on the oscilloscope controls the probe offset and the channel offset is set to zero. This allows the offset voltage to be subtracted from the input signal before the signal gets to the differential amplifier. Since this subtraction is done before any active circuits, the offset range is large ($\pm 16V$). Note that the minus probe tip is not present when using a single-ended probe head which means nothing is plugged into the "-" input of the probe amp. This is normal and causes no problems.

Case 2. A differential probe head probing a single-ended signal

For this case, the offset control on the oscilloscope controls the probe offset and the channel offset is set to zero. This allows the offset voltage to be subtracted from the input signal before the signal gets to the differential amplifier. Since this subtraction is done before any active circuits, the offset range is large ($\pm 16V$). A differential probe can make higher bandwidth and more accurate measurements on single-ended signals than a single-ended probe and this method of applying offset to only the plus side of a differential probe means there is no sacrificing of offset range.

When **Probe** is selected in the **Probe Offset** dialog box as shown in **Figure 11** on page 17, the InfiniiMax probe provides a very large offset range (up to $\pm 16V$) for probing single-ended signals and a large common-mode range for probing differential signals. For information on properly using probe offset to ensure that you can get the maximum performance and dynamic range from the InfiniiMax probe, refer to Keysight application note 5988-9264EN.

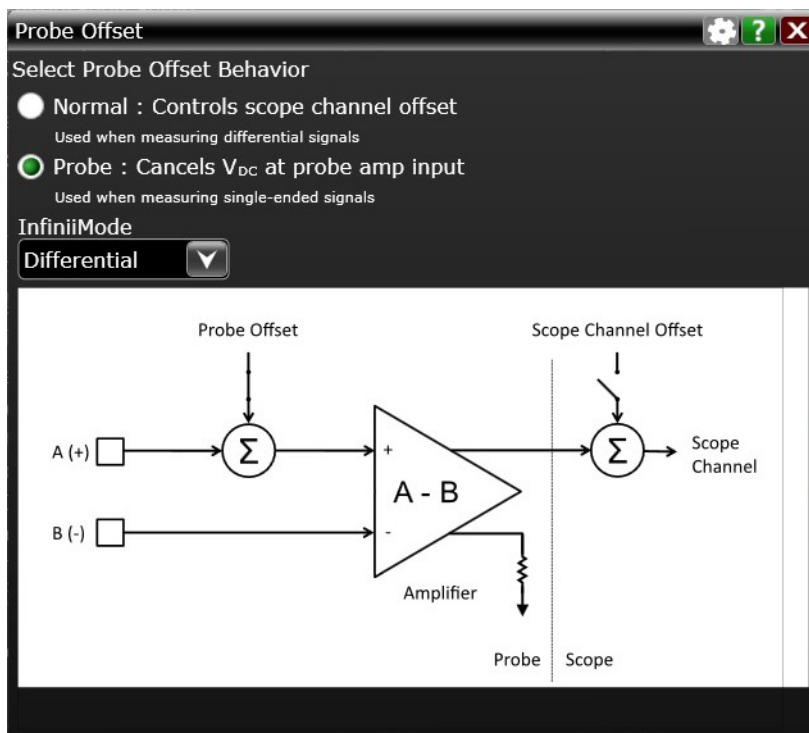

Figure 11 Probe Offset Dialog Box (Probe Setting)

Case 3. A differential probe head probing a differential signal

For this case, the offset control on the oscilloscope controls the oscilloscope channel offset. The probe offset is not used and set to zero. Since the plus and minus sides of differential signals have the same dc component, it will be subtracted out and the output of the probe will by definition be centered around ground.

The channel offset allows the waveform seen on screen to be moved as desired. The allowable dc component in the plus and minus signals is determined by the common mode range of the probe.

Figure 12 shows **Normal** selected in the **Probe Offset** dialog box. When probing differential signals **Normal** allows you to apply probe offset using the oscilloscope's front-panel vertical offset controls.

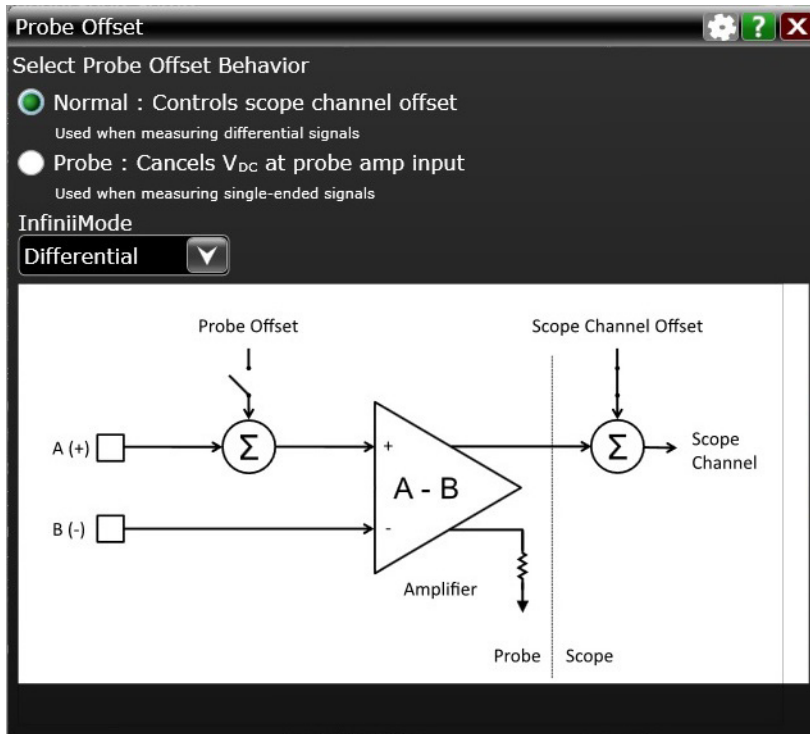

Figure 12 Probe Offset Dialog Box (Normal Setting)

Slew Rate Requirements for Different Technologies

The following table shows the slew rates for several different technologies. The maximum allowed input slew rate is 25 V/ns for single-ended signals and 40 V/ns for differential signals. **Table 2** shows that the maximum required slew rate for the different technologies is much less than that of the probe.

Table 2 Slew Rate Requirements

Name of Technology	Differential Signal	Max Single-Ended Slew Rate ^a (V/ns)	Max Differential Slew Rate ^b (V/ns)	Driver Min Edge Rate (20%-80% ps)	Max Transmitter Level (Diff V)
PCI Express (3GIO)	YES	9.6	19.2	50	1.6
RapidIO Serial 3.125Gb	YES	8.0	16.0	60	1.6
10GbE XAUI (4x3.125Gb)	YES	8.0	16.0	60	1.6
1394b	YES	8.0	16.0	60	1.6
Fibre Channel 2125	YES	8.0	16.0	75	1
Gigabit Ethernet 1000Base-CX	YES	7.8	15.5	85	2.2
RapidIO 8/16 2Gb	YES	7.2	14.4	50	1.2
Infiniband 2.5Gb	YES	4.8	9.6	100	1.6
HyperTransport 1.6Gb	YES	4.0	8.0	113	1.5
SATA (1.5Gb)	YES	1.3	2.7	134	0.6
USB 2.0	YES	0.9	1.8	375	1.1
DDR 200/266/333	NO	7.2	n/a	300	3.6
PCI	NO	4.3	n/a	500	3.6
AGP-8X	NO	3.1	n/a	137	0.7

a The probe specification is 25 V/ns

b The probe specification is 40 V/ns

Available Accessories

This section lists the kits and accessories that are available in addition to the individual probe heads described in [Chapter 2](#), “Using Probe Heads”.

E2669B Differential Connectivity Kit and Accessories

The optional E2669B differential connectivity kit provides multiple quantities of the three InfiniiMax I probe heads as shown in [Figure 13](#). These probe heads allow full bandwidth probing of differential and single-ended signals. The kit can be ordered at the same time as 1168/9B probe amplifiers.

E2678B Differential Socketed
(quantity 2)

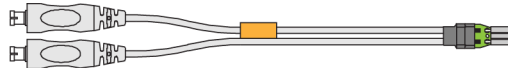

E2677B Differential Solder-In
(quantity 4)

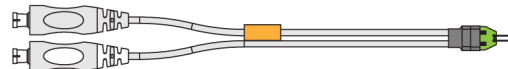

E2675B Differential Browser
(quantity 1)

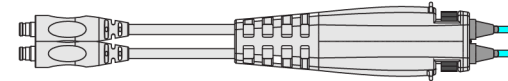

Figure 13 E2669B Differential Connectivity Kit (*not to scale*)

Table 3 Supplied Accessories (Sheet 1 of 2)

Description	Qty Supplied	Used With			Part Number ^a
		E2678B	E2677B	E2675B	
E2678B Differential Socketed Head	2	–	–	–	–
E2677B Differential Solder-In Head	4	–	–	–	–
E2675B Differential Browser	1	–	–	–	–
160Ω damped wire accessory	12	✓			01130-21303
82Ω resistor for full bandwidth	96	✓			01130-81506
Socket for 25 mil (25/1000 inch) square pins, female on both ends	8	✓			01131-85201
25 mil female socket with 20 mil round male pin on other end	8	✓			01131-85202
Heat shrink socket accessory	8	✓			01130-41101
Header adapter, 91Ω	4	✓			01130-63201
82Ω resistor template	1	✓			01131-94309

Table 3 Supplied Accessories (Sheet 2 of 2)

Description	Qty Supplied	Used With			Part Number ^a
		E2678B	E2677B	E2675B	
91Ω resistor for full bandwidth	80		✓		0700-2353
150Ω resistor for medium bandwidth	40		✓		0700-2350
91Ω resistor template	1		✓		01131-94311
150Ω resistor template	1		✓		01131-94308
Resistive tip (blue), 91Ω	20			✓	01131-62107
Ergonomic handle	1			✓	01131-43201

^a *Not orderable.*

N2833A InfiniiMax II Differential Connectivity Kit and Accessories

The optional N2833A differential connectivity kit provides multiple quantities of the four InfiniiMax II probe heads as shown in **Figure 14**. These probe heads allow full bandwidth probing of differential and single-ended signals. You can order this kit either at the same time as 1168/9B probe amplifiers or separately later.

N5381B Differential Solder-In
(quantity 2)

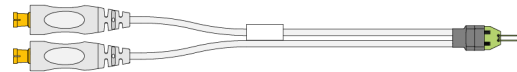

N5425B Differential ZIF Solder-In
(quantity 2)

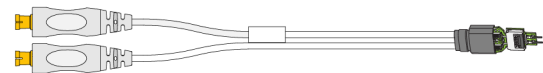

N2851A QuickTip
(quantity 2)



N2839A Differential Browser
(quantity 1)

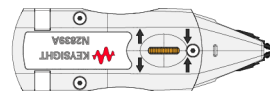

Figure 14 Probe Heads Included in the N2833A Differential Connectivity Kit (*not to scale*)

Table 4 Supplied Accessories

Description	Qty Supplied	Part Number
N5381B InfiniiMax II 12 GHz Differential Solder-In Probe Head	2	N5381B
0.007 inch tin-plated nickel wire	1	01169-81301 *
0.005 inch tin-plated nickel wire	1	01169-21306 *
Trim Gauge	1	-
N5425B InfiniiMax II 12 GHz Differential ZIF Solder-in Probe Head	2	N5425B
N5426A InfiniiMax 12 GHz ZIF Tip Kit	2 kits (10 tips in each kit)	N5426A
N2851A InfiniiMax II QuickTip Probe Head	2	N2851A
N2849A InfiniiMax QuickTip Tips Kit	2 kits (4 tips in each kit)	N2849A
N2839A InfiniiMax II Browser Probe Head	1	N2839A
Spring-loaded tips	20	-
Tweezer for replacing tips	1	-
Protective end cap	1	-

* - Indicates the part number of an accessory not orderable separately as an individual product.

N5450B Extreme Temp Cable Extension Kit

The extreme temperature cable extension kit is an accessory that allows an oscilloscope probe to be used to monitor a device in a temperature chamber. Keysight's Infiniimax probe amplifiers have a specified operating temperature range from 5° C to 40° C, but the probe heads can be operated over a much larger range of temperatures. Use the extension cables to physically separate the amplifier from the probe head which allows you to operate the probe head inside a temperature chamber while the probe amplifier remains outside the chamber. To ensure a high-quality measurement, the N5450B cable set have been phase-matched at the factory. A coupling tag is included with the cables to ensure the cables stay as a matched pair. To install the coupling tag, slip the small end of each cable through the holes in the tag. The tag can be positioned anywhere along the length of the cable and can withstand the temperature ranges specified.



Table 5 Probing Temperature Ranges

Probe Head Configuration ^a	Operating Temperature Range (°C)	Expected Lifetime of the Probe Head (cycles)
N5381B	-40° to +85°	> 250
E2677B	-25° to +80°	> 1000
E2678B	-25° to +80°	> 1000
N5425B + N5426A	-40° to +85°	> 500
N5451A	-25° to +80°	> 1000
MX0100A	-55° C dwell, 1000 hours minimum +150° C dwell, 1000 hours minimum -55° C to 150° C cycles, 1000 cycles minimum (as per JEDEC JESD22-A104 revision E)	> 1000

^a Refers to the probe head or tip that is attached to the cable extension kit.

CAUTION

Avoid rapid changes in temperature that can lead to moisture accumulating in the form of condensation on the probe components, as well as the DUT. If this occurs, wait until the moisture has evaporated before making any measurements.

CAUTION

Additional care must be taken when handling probe heads used during extreme temperature cycling because this process makes the probe heads less robust.

CAUTION

Secure the ends of the extension cable near the probe head in the temperature chamber such that the probe head legs are not tugged or moved around significantly.

CAUTION

Prevent abrasion and tears in the cable's jacket, do not rest the extension cables on any metal objects or objects with sharp edges.

CAUTION

Do not kink the cables. The cables are designed to be flexible, but are not designed to be bent sharply.

NOTE

Keep your extreme temperature testing probes separate from the probes they use under milder conditions. This is because cycling probe heads through extreme temperature ranges has a marked affect on their lifetimes as listed in [Table 5](#). Only the lifetime of the probe head is affected by temperature cycling. The extension cables and probe amplifier should not need to be replaced with extended temperature cycling.

NOTE

Discoloration or texture changes are possible with the extension cables. These changes do not, however, affect the performance or the quality of a measurement.

N2880A InfiniiMax In-Line Attenuator Kit

The in-line attenuators are an accessory for probes. The maximum input range of the 1168B/9B probes are $3.3 V_{p-p}$. If you need to measure larger signals, the probe's design allows you to add the N2880A InfiniiMax in-line attenuators between the probe head and probe amplifier to increase the maximum input range (as listed in **Table 6** on page 25). Additionally, these attenuators enable you to increase the offset range of the probe as specified in **Table 6** on page 25. When using the N2880A In-Line Attenuators, the bandwidth and rise time of your probing system is not affected. There is, however, a trade-off in noise (refer to **Table 6**) and in the accuracy of DC offset relative to the input.

The N2880A provides a pair of 6 dB, 12 dB, and 20 dB attenuators. The attenuators come as matched pairs and should only be used with each other. Each attenuator has a serial number. The pair of matching attenuators in each set will have the same four digit numeric prefix and will differ by the last letter (one attenuator in the matched pair will be labeled A and the other will be labeled B).



Compatibility with probe heads and amplifiers

All InfiniiMax I and II probe heads and amplifiers are compatible with the N2880A In-line attenuators. However, the following two limitations should be considered when planning to use N2880A attenuators.

- The maximum input voltage of the InfiniiMax I probe heads is $\pm 30 V_{dc}$ and so they should not be used to measure signals that exceed this range. This places a practical limit of 20 dB on the attenuators used with the InfiniiMax I probing system. Larger attenuation ratios will only degrade the noise performance and gain of the system.
- Due to the N5380B dual-SMA probe head's maximum input voltage specification of $2.28 V_{RMS}$, the N5380B is not suitable for measuring signals large enough to require an added attenuator.

Table 6 N2880A With 1168B/9B Probe Amplifiers

Added Attenuator	Maximum Input Range (mains isolated circuits only)	Offset Range	Typical Noise Referred to	Maximum Allowed Input Slew Rate ^a (se = single-ended) (diff = differential)	Nominal DC Attenuation of Probe System
None	3.3 Vp-p	±16V	2.2 mV RMS	se: 25 V/ns, diff: 40 V/ns	3.45:1
6 dB (2:1)	6.6 Vp-p	±30 V ^b	6.3 mV RMS	se: 50 V/ns, diff: 80 V/ns	6.9:1
12 dB (4:1)	13.2 Vp-p	±30 V ^b	13.2 mV RMS	se: 100 V/ns, diff: 160 V/ns	13.8:1
20 dB (10:1)	33.3 Vp-p	±30 V ^b	33.4 mV RMS	se: 250 V/ns, diff: 400 V/ns	34.5:1

a These slew rate do not apply when the N5380B SMA probe head is used with the InfiniiMax amplifiers.

b The actual range of DC voltage for N2880A is > ±30 V, but the usable range of DC voltage at the probe input is limited to ±30 Vdc.

NOTE

The values shown above do not apply to the N5380B dual-SMA probe head. Due to the maximum input voltage specification of 2.28 VRMS (mains isolated circuits only) for the N5380B, it is not suitable for measuring signals large enough to require an added attenuator.

Frequency Response Plots

Below are the frequency response plots for four setups: the probe without any attenuators, the probe with the 6 dB attenuators, the probe with the 12 dB attenuators, and the probe with the 20 dB attenuators.

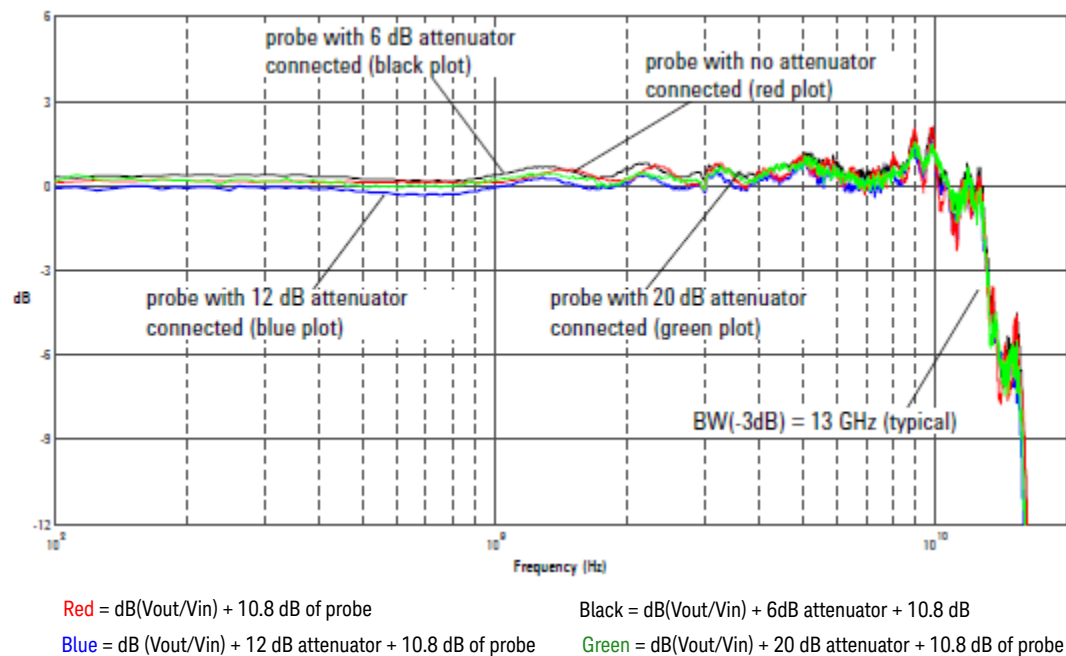
**Figure 15** Frequency Response

Extended Offset Range with N2880A Attenuators

The use of N2880A attenuators allows an increased offset range (± 30 Vdc) of the probe as listed in [Table 6](#) on page 25.

However, if you are using the 12 dB (4:1) or 20 dB (10:1) N2880A attenuators with the N5381A/B probe head and InfiniiMax II probe amplifier, an extended offset range (± 60 Vdc) is allowed to enable you to measure higher input voltages.

When you connect the appropriate attenuators, probe head, and probe amplifier to the oscilloscope, the extended offset range is available using the **Offset** field of the **External Scaling** dialog box in the Infiniium software GUI. You access this dialog box by clicking **Setup > Probe Configuration....** and then enabling **External Scaling**.

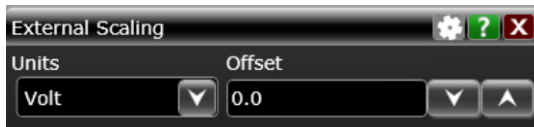

For this extended offset range, the maximum allowed AC voltage is dependent on the DC voltage on the signal. The graph in [Figure 16](#) depicts the DC voltage and the corresponding allowed maximum AC voltage for this extended range. It is recommended that you use the maximum AC voltage values depicted in this graph to set the extended offset value in the Infiniium GUI.

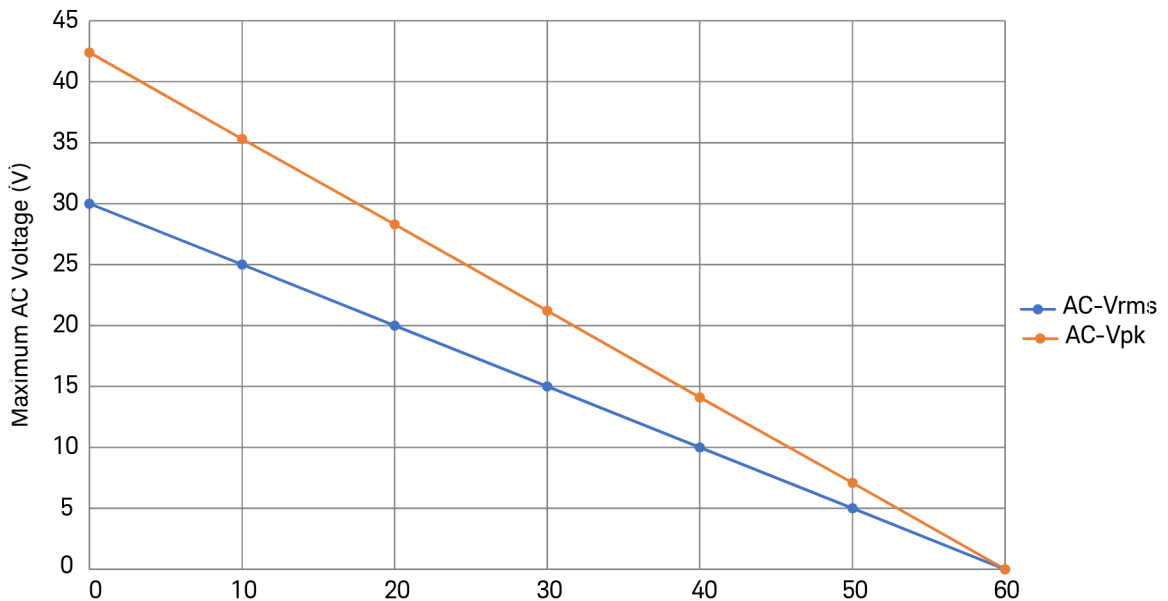

Figure 16 Extended offset range - Maximum AC voltage recommendations corresponding to the DC voltage

You can also calculate the maximum allowed AC voltage using the following equations.

$$\text{Maximum } V_{ACRMS} = 30 * (60 - V_{DC}) / 60$$

$$\text{Maximum } V_{AC_PEAK} = 42.4 * (60 - V_{DC}) / 60$$

Calibrating and Configuring Attenuators on an Infiniium Series Oscilloscope

The software in the Infiniium oscilloscopes will detect a probe when it is connected and by default will assume that no additional attenuators are installed. If you want to scale readings and settings on the oscilloscope so they are correct with the attenuators installed, refer to the procedures below for your specific oscilloscope series.

Calibrating Attenuators on an Infiniium Series Oscilloscope

You cannot calibrate your InfiniiMax probes with the attenuators attached. Calibrate the InfiniiMax probes as you normally would (with no attenuators), configure the attenuators as discussed in the next section, and begin probing.

Configuring Attenuators on an Infiniium Series Oscilloscope

First, plug your InfiniiMax probe amplifier / probe head into one of the oscilloscope channels with the attenuators connected. Then enter the Probe Setup dialog box (can be reached via **Setup > Probes** on the oscilloscope menu). Press the **Configure Probing System** button. A pop-up window will appear where you can select External Scaling. Click the **Decibel** radio button under the External Scaling section and then set the **Gain** field to either -6 dB, -12 dB, or -20 dB depending on the attenuator you are using (be sure to include the negative sign). Finally, you will need to manually set the **Offset** field in this dialog box to zero out the signal.

N2881A InfiniiMax DC Blocking Capacitors

The DC blocking capacitors are an accessory for the probes. The architecture of the InfiniiMax probing system allows you to place the N2881A DC blocking caps in between the probe amplifier and the probe head as shown in **Figure 17**. The capacitors block out the DC component of the input signal (up to 30 Vdc).



Figure 17 Blocking Caps Between Probe Amplifier and Head

You can use the blocking capacitors with the N2880A In-Line Attenuators. The order of the two products in the probing system (that is, which one is closest to the probe amplifier) does not matter.

Figure 18 on page 28 shows the frequency response plot of the blocking capacitors (no probe included).

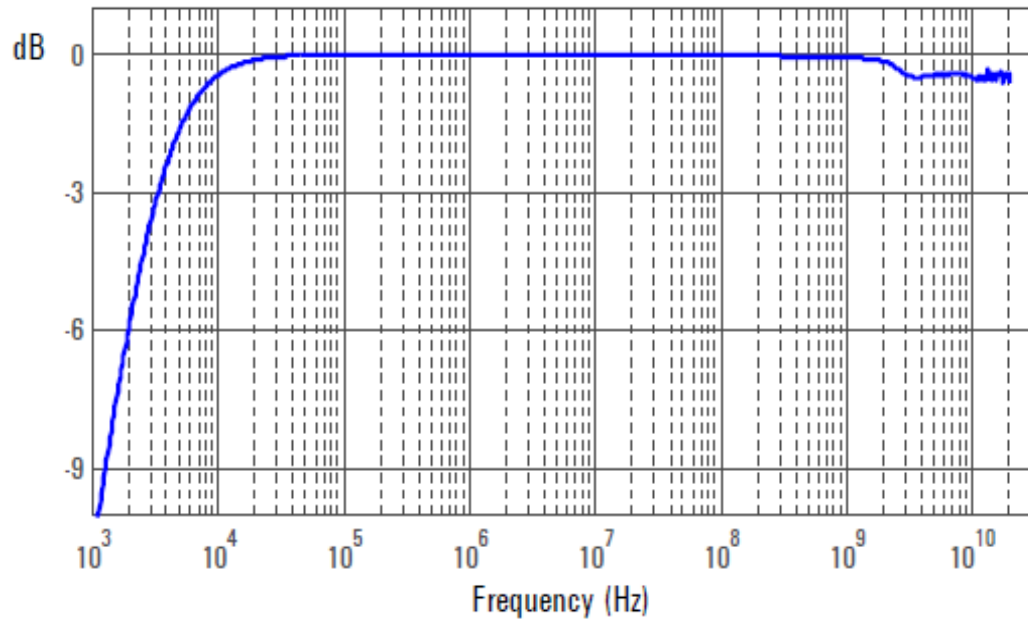

Figure 18 DC Blocking Cap Insertion Loss (S21) versus Frequency (*DC Blocking Cap only*)

MX0102A Soldering Toolkit

The optional MX0102A soldering toolkit provides tools that can make soldering tasks easier. For instance, you can use the tools available in this kit while soldering the lead wires of the MX0100A Micro probe head to a DUT (see [page 44](#)).

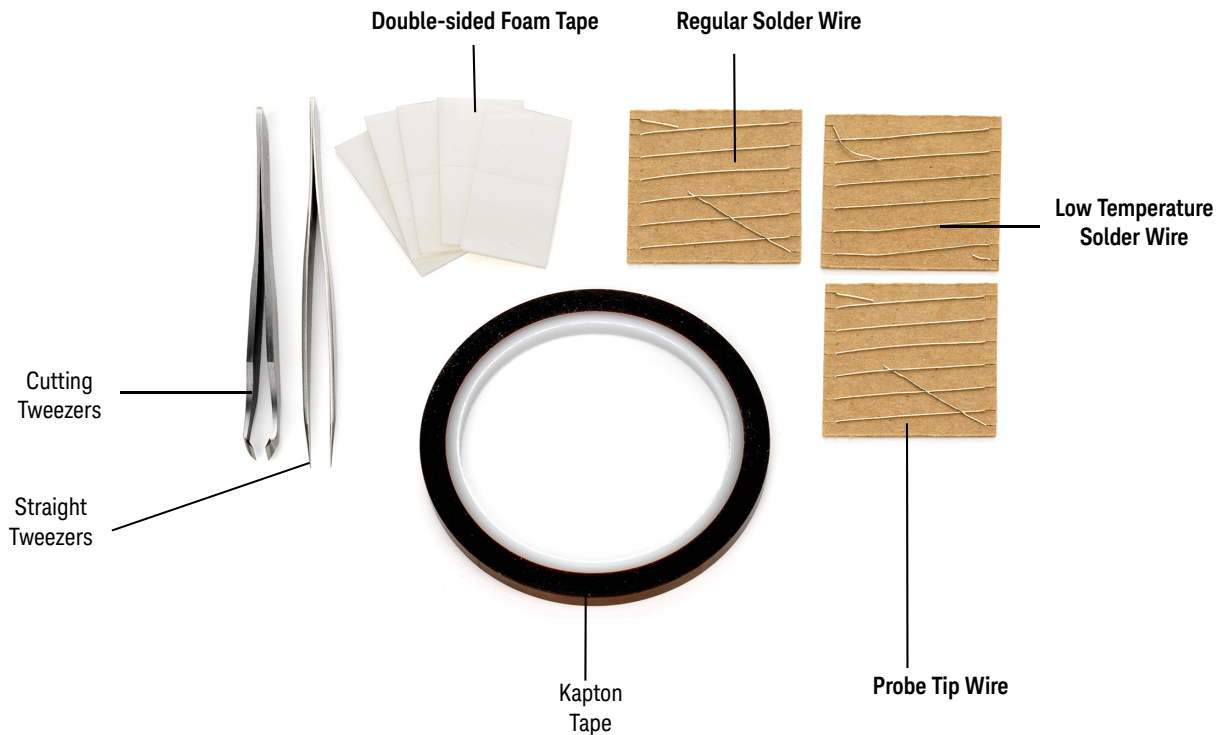

Table 7 Accessories supplied in the soldering toolkit

Description	Qty Supplied	Part Number ^a
Straight Tweezers (Anti-magnetic straight pointed tip 120mm) For general purpose manipulation / movement of components such as probe tip wires and probe head.	1	8710-2837
Cutting Tweezers (Narrow oblique head 115mm) To cut a probe tip wire to a desired length.	1	8710-2838
Kapton Tape (36 yards roll) To provide strain-relief to the neck portion of the probe head by taping it to a flat surface (such as a DUT circuit board).	1	0460-3121

Description	Qty Supplied	Part Number ^a
<p>Double-sided Foam Tape To provide strain-relief to either the neck portion of the probe head or the plastic housings by taping it to a flat surface such as a tabletop or a DUT circuit board.</p>	10	0460-3122
<p>Regular Solder Wire Lead free, .009" diameter, 2 feet long To attach the probe tip wires to a DUT using standard lead-free soldering temperatures (330 °C to 350 °C). (NOTE: This alloy melts at 217 °C.)</p>	1	MX0102-21302
<p>Low Temperature Solder Wire Lead free, .010" diameter, 2 feet long To attach the probe tip wires to a DUT using a low temperature setting on your soldering iron. (NOTE: This alloy melts at 138 °C.)</p>	1	MX0102-21303
<p>Probe Tip Wire .004" diameter, 2 feet long To add ground wires to your probe tip if InfiniiMode measurements (differential, single ended, and common mode signals with a single probe tip) are desired. Clip as short as possible using the cutting tweezers included in the kit.</p>	1	MX0102-21301

^a You can reorder these items using the part numbers included in the table above.

Safety Information



This manual provides information and warnings essential for operating this probe in a safe manner and for maintaining it in safe operating condition. Before using this equipment and to ensure safe operation and to obtain maximum performance from the probe, carefully read and observe the following warnings, cautions, and notes.

This product has been designed and tested in accordance with accepted industry standards, and has been supplied in a safe condition. The documentation contains information and warnings that must be followed by the user to ensure safe operation and to maintain the product in a safe condition.

Note the external markings on the probe that are described in this document.

To avoid personal injury and to prevent fire or damage to this product or products connected to it, review and comply with the following safety precautions.

WARNING

Use Only Grounded Instruments. Do not connect the probe's ground lead to a potential other than earth ground. Always make sure the probe and the oscilloscope are grounded properly.

WARNING

Connect and Disconnect Properly. Connect the probe to the oscilloscope and connect the ground lead to earth ground before connecting the probe to the circuit under test. Disconnect the probe input and the probe ground lead from the circuit under test before disconnecting the probe from the oscilloscope.

WARNING

Observe Probe Ratings. Do not apply any electrical potential to the probe input which exceeds the maximum rating of the probe. Make sure to comply with the voltage versus frequency derating curve found in this manual. These Probe assemblies are not intended for measurements on mains circuits (CAT II, CAT III, and CAT IV).

WARNING

Indoor Use Only. Do not operate in wet/damp environments. Keep product surfaces dry and clean.

WARNING

Never leave the probe connected to a conductor while it is not connected to an oscilloscope or voltage measuring instrument.

WARNING

Periodically inspect the probe and probe wires to check for any damage. Do Not Operate With Visible or Suspected Failures. If you suspect there is damage, have it inspected by a Keysight authorized service personnel.

WARNING

Do not install substitute parts or perform any unauthorized modification to the probe.

WARNING

Do not operate the probe or oscilloscope in the presence of flammable gasses or fumes. Operation of any electrical instrument in such an environment constitutes a definite safety hazard.

WARNING

If the probe is used in a manner not specified by the manufacturer, the protection provided by the probe assembly may be impaired.

WARNING

Do not attempt internal service or adjustment. Service should be carried out by a Keysight Technologies authorized service personnel. For any service needs, contact Keysight Technologies.

CAUTION

The probe cable is a sensitive part of the probe and, therefore, you should be careful not to damage it through excessive bending or pulling. Avoid any mechanical shocks to this product in order to guarantee accurate performance and protection.

Concerning the Oscilloscope or Voltage Measuring Instrument to Which the Probe is Connected

WARNING

Whenever it is likely that the ground protection is impaired, you must make the instrument inoperative and secure it against any unintended operation.

WARNING

If you energize the instrument by an auto transformer (for voltage reduction or mains isolation), the ground pin of the input connector terminal must be connected to the earth terminal of the power source.

WARNING

Before turning on the instrument, you must connect the protective earth terminal of the instrument to the protective conductor of the (mains) power cord. The mains plug shall only be inserted in a socket outlet provided with a protective earth contact. You must not negate the protective action by using an extension cord (power cable) without a protective conductor (grounding). Grounding one conductor of a two-conductor outlet is not sufficient protection.

WARNING

Capacitors inside the instrument may retain a charge even if the instrument is disconnected from its source of supply.

Troubleshooting

The following symptoms may indicate a problem with the probe or the way it is used. The probe is a high frequency device with many critical relationships between parts. For example, the frequency response of the amplifier on the hybrid is trimmed to match the output coaxial cable. As a result, to return the probe to optimum performance requires factory repair. If the probe is under warranty, normal warranty services apply.

Probe Calibration Fails

Probe calibration failure with an oscilloscope is usually caused by improper setup. If the calibration will not pass, check the following:

- Check that the probe passes a waveform with the correct amplitude.
- If the probe is powered by the oscilloscope, check that the offset is approximately correct. The probe calibration cannot correct major failures.
- Be sure the oscilloscope passes calibration without the probe.
- Be sure that the probe head that you are using has been in the oscilloscope's Probe Setup dialog box.

Incorrect Pulse Response (flatness)

If the probe's pulse response shows a top that is not flat, check for the following:

- Output of probe must be terminated into a proper 50Ω termination. If you are using the probe with an Infiniium oscilloscope, this should not be a problem. If you are using the probe with other test gear, ensure the probe is terminated into a low reflectivity 50Ω load ($\sim \pm 2\%$).
- If the coax or coaxes of the probe head in use has excessive damage, then reflections may be seen within approximately 1 ns of the input edge. If you suspect a probe head, swap it with another probe head and see if the non-flatness problem is fixed.
- If the one of the components in the tip have been damaged there may be a frequency gain non-flatness at around 40 MHz. If you suspect a probe head, swap it with another probe head and see if the non-flatness problem is fixed.

Incorrect Input Resistance

The input resistance is determined by the probe head in use. If the probe head is defective, damaged, or has been exposed to excessive voltage, the input resistor may be damaged. If this is the case, the probe head is no longer useful. A new probe head will need to be obtained either through purchase or warranty return.

Incorrect Offset

Assuming the probe head in use is properly functioning, incorrect offset may be caused by defect or damage to the probe amplifier or by lack of probe calibration with the oscilloscope.

Returning the Probe for Service

If the probe is found to be defective we recommend sending it to an authorized service center for all repair and calibration needs. Perform the following steps before shipping the probe back to Keysight Technologies for service.

- 1 Contact your nearest Keysight sales office for information on obtaining an RMA number and return address.
- 2 Write the following information on a tag and attach it to the malfunctioning equipment.
 - Name and address of owner
 - Product model number (for example, 1168B)
 - Product Serial Number (for example, MYXXXXXXXX)
 - Description of failure or service required

NOTE

Include probing and browsing heads if you feel the probe is not meeting performance specifications or a yearly calibration is requested.

- 3 Protect the probe by wrapping in plastic or heavy paper.
- 4 Pack the probe in the original carrying case or if not available use bubble wrap or packing peanuts.
- 5 Place securely in sealed shipping container and mark container as "FRAGILE".

NOTE

If any correspondence is required, refer to the product by serial number and model number.

Contacting Keysight Technologies

For technical assistance, contact your local Keysight Call Center.

- In the Americas, call 1 (800) 829-4444
- In other regions, visit <http://www.keysight.com/find/assist>

Before returning an instrument for service, you must first call the Call Center at 1 (800) 829-4444.

1 Getting Started

2 Using Probe Heads

Recommended Configurations	38
1. MX0100A InfiniiMax Micro Probe Head	41
2. N5381B Differential Solder-In	50
3. N2839A Differential Browser	52
4. N5382A Differential Browser	57
5. N5380B SMA	60
6. N5425B with N5426A ZIF Tip	63
7. N5425B with N2884A Fine Wire ZIF Tip	64
8. N2851A QuickTip Probe Head	67
9. N5425B with N5451A Long-Wire ZIF Tip (7 mm)	71
10. N5425B with N5451A Long-Wire ZIF Tip (11 mm)	73
11. E2677B Differential Solder-In Probe Head	75
12. E2678B Differential Socketed Probe Head	77
13. E2675B Differential Browser	79
14. E2679B Single-Ended Solder-in Probe Head	81
15. E2676B Single-Ended Browser	82
16. E2678B Differential Socketed & Damped Wire Accessory	84
Soldering a ZIF Tip to a DUT	86
Using N2884A Fine-Wire ZIF tips	90
N2887A/8A Soft Touch Probe Heads	98

Performance graphs showing the performance of the heads are shown in **Chapter 6**. This chapter describes the probe head configurations listed in the order of the best performance to the least performance. Always refer to the information in this chapter *before* using any probe head. The recommended configurations are designed to give the best probe performance for different probing situations. This allows you to quickly make the measurements you need with confidence in the performance and signal fidelity.

Recommended Configurations

Table 8 Recommended InfiniiMax II Configurations (Sheet 1 of 2)

Recommended Order of Use	BW (GHz)	Cdiff ^a (pF)	Cse ^b (pF)	Usage
MX0100A InfiniiMax Micro Probe Head (Refer to page 41.)				
1	Full Bandwidth 1168B: 10 1169B: 12	0.17	0.26	Differential and Single-ended signals Lowest input loading Pre-wired micro solder-in probe head kit Light, flexible, small, and reusable Designed to access small geometry target devices
N5381B Differential Solder-In (Refer to page 50.)				
2	Full Bandwidth 1168B: 10 1169B: 12	0.21	0.35	Differential and Single-ended signals Solder-in hands free connection Hard to reach targets Very small fine pitch targets Characterization
N2839A Differential Browser (Refer to page 52.)				
3	Full Bandwidth 1168B: 10 1169B: 12	0.21	0.34	Differential and Single-ended signals Hand-held browsing Adjustable tip spacing General purpose troubleshooting Compatible with N2784/5A or N2787A probe positioners
N5382A Differential Browser (Refer to page 57.)				
4	Full Bandwidth 1168B: 10 1169B: 12	0.21	0.35	Differential and Single-ended signals Hand-held browsing Probe holders General purpose troubleshooting Ergonomic handle available
N5380B SMA (Refer to page 60.)				
5	Full Bandwidth 1168B: 10 1169B: 12	N/A	N/A	Full bandwidth Preserve oscilloscope channels as opposed to using the A minus B mode. Removes inherent cable loss through compensation. Common mode termination voltage can be applied Offset matched sma cables adapt to variable spacing
N5425B ZIF with N5426A ZIF Tip (Refer to page 63.)				
6	Full Bandwidth 1168B: 10 1169B: 12	0.33	0.53	Differential and Single-ended signals Solder-in with ZIF Tip connection Very small fine pitch target Slightly higher loading than solder-in probe head

Table 8 Recommended InfiniiMax II Configurations (Sheet 2 of 2)

Recommended Order of Use	BW (GHz)	C _{diff} ^a (pF)	C _{se} ^b (pF)	Usage
N5425B ZIF with N2884A Fine Wire ZIF Tip (Refer to page 64.)				
7	Full Bandwidth 1168B: 10 1169B: 12	0.35	–	Differential high fidelity Solder-in fine wire with ZIF Tip connection Extremely small fine pitch target, active ICs Fragile lead wires
N2851A QuickTip Probe Head (Refer to page 67.)				
8	Full Bandwidth 1168B: 10 1169B: 12	0.72	0.71	Easy, secure magnetic connection between head and tip. Use N2848A and N2849A with InfiniiMax III+ amplifier for InfiniiMode function.
N5425B ZIF with N5451A Long Wired ZIF Tip (7 mm resistor length) (Refer to page 71.)				
9	~9.9 (0° span) ^c ~4.4 (60° span) ^d	–	0.6 0.58	Differential and Single-ended signals Solder-in with LW ZIF Tip connection Variable pitch targets, including larger pitches Higher loading than solder-in probe head
N5425B ZIF with N5451A Long Wired ZIF Tip (11 mm resistor length) (Refer to page 73.)				
10	~5 (0° span) ^c ~3.3 (60° span) ^d	–	0.68 0.68	Differential and Single-ended signals Solder-in with LW ZIF Tip connection Variable pitch targets, including larger pitches Higher loading than solder-in probe head

a Capacitance seen by differential signals

b Capacitance seen by single-ended signals

c 0° span between the two LW ZIF resistor leads

d 60° span between the two LW ZIF resistor leads

Table 9 lists probe head configurations that are available in the E2669B connectivity kit. Not all of these configurations will give the best probe performance of the 1168B and 1169B. The probe configurations are shown in the order of the best performance to the least performance.

Table 9 InfiniiMax I Configurations

Recommended Order of Use	BW (GHz)	Cdiff ^a (pF)	Cse ^b (pF)	Usage
E2677B Differential Solder-In (high bandwidth resistors) (Refer to page 75.)				
11	1168B: 10 1169B: 12	0.27	0.44	Differential and Single-ended signals Solder-in hands free connection Hard to reach targets Very small fine pitch targets Characterization
E2678B Differential Socketed (full bandwidth resistors) (Refer to page 77.)				
12	1168B: 10 1169B: 12	0.34	0.56	Differential and Single-ended signals Removable connection using solder-in resistor pins Hard to reach targets
E2675B Differential Browser (Refer to page 79.)				
13	~5.2	0.32	0.57	Differential and Single-ended signals Hand-held browsing Probe holders General purpose troubleshooting Ergonomic handle available
E2679B Single-Ended Solder-In (high bandwidth resistors) (Refer to page 81.)				
14	~5.2	N/A	0.50	Single-ended signals only Solder-in hands free connection when physical size is critical Hard to reach targets. Very small fine pitch targets
E2676B Single-Ended Browser (Refer to page 82.)				
15	~6	N/A	0.65	Single-ended signals only Hand or probe holder where physical size is critical General purpose troubleshooting Ergonomic handle available
E2678B Differential Socketed with Damped Wire Accessories (Refer to page 84.)				
16	~1.2	0.63	0.95	Differential and Single-ended signals For very wide spaced targets Connection to 25 mil square pins when used with supplied sockets

a Capacitance seen by differential signals

b Capacitance seen by single-ended signals

1. MX0100A InfiniiMax Micro Probe Head

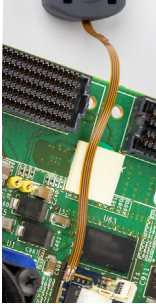

The MX0100A is a small, flexible, and lightweight solder-in probe head that allows you to conveniently probe denser and smaller-sized target devices.

The micro size and flexibility features of this probe head overcome the probing challenges faced with the smaller pads and narrower spacing in such small devices..

This probe head configuration supports the highest bandwidth and provides the full bandwidth signals (1168B: 10 GHz, 1169B: 12 GHz) and the lowest capacitive loading for measuring both single-ended and differential signals.

This probe head connects easily to an InfiniiMax probe amplifier using the bullet adapter shipped with the probe head.

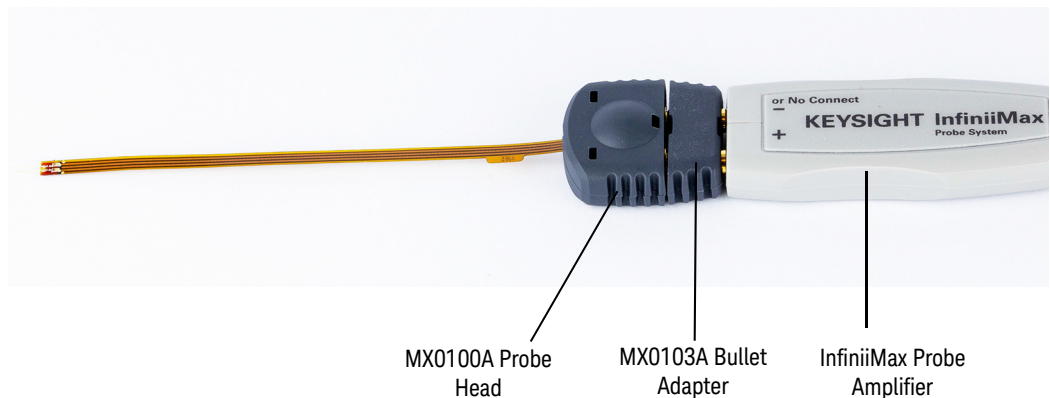

For connection to a DUT, it has pre-wired probe tip leads that allow solder-in connection to very small, fine pitch targets.

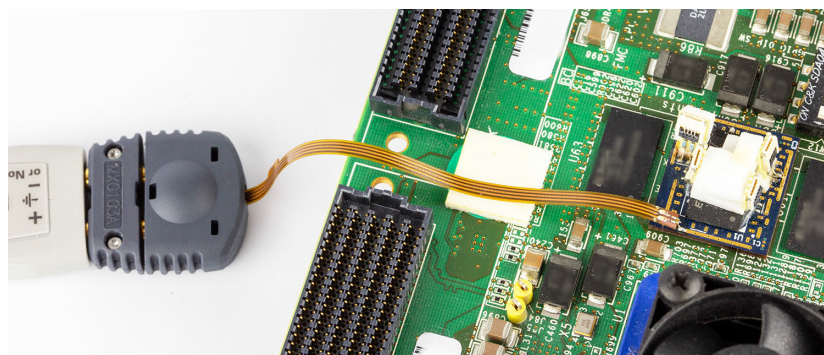

Figure 19 MX0100A probe head connected to DUT and InfiniiMax probe amplifier

NOTE

When probing differential signals, the + and – connection of the MX0100A probe head can be determined when the probe head is plugged into the probe amplifier. The + and - indicators on the probe amplifier represent the + and - inputs on MX0100A probe head. When probing single-ended signals, ensure that the - input of the probe amplifier is connected to the ground of the DUT.

Extreme Temperature Testing with MX0100A Probe Head

The MX0100A probe head can withstand temperatures from -55°C to $+150^{\circ}\text{C}$ thereby making it suitable for extreme temperature environments such as temperature chambers. For extreme temperature testing, use the MX0100A probe head with the N5450B InfiniiMax extreme temperature extension cable.

CAUTION

InfiniiMax probe amplifiers cannot withstand extreme temperatures (-55°C to $+150^{\circ}\text{C}$) that the MX0100A probe head can withstand. Be cautious not to subject these probe amplifiers to extreme temperatures. Using the N5450B extension cable with the MX0100A probe head physically separates the amplifier from the probe head and therefore eliminates the chances of the amplifier's exposure to extreme temperatures.

To know more about the N5450B extension cable and cautions associated with using an InfiniiMax probe head in extreme temperature testing, refer to **"N5450B Extreme Temp Cable Extension Kit"** on page 22.

The MX0100A probe head components may undergo discoloration when used under high temperatures. Such changes do not, however, affect the probe head's performance or measurement quality. The probe head maintains its specified frequency response and bandwidth over the operating temperature range (-55°C to $+150^{\circ}\text{C}$), without any need for compensation or correction.



Before usage under high temperatures



Discoloration after usage under high temperatures

Required Infiniium Software Version

The MX0100A probe head requires the Infiniium software version 6.30 or higher.

MX0100A Probe Head Kit Components

Table 10 MX0100A Probe Head Kit Components

Component	Quantity *			Part Number
	Option 001	Option 002	Option 003	
Micro Probe Heads (with pre-wired probe tips)	5	25	50	MX0100A
Probe Tip Wire (.004" diameter) (To make ground connections)	1 wire spool	5 wire spools	10 wire spools	MX0102-21301
Bullet Adapter	1	5	10	MX0103A
Trim Gauge Template (see Figure 20)	1	5	10	MX0100-94302

* Quantity varies based on the purchased option.

NOTE

For Performance plots, refer to ["MX0100A Micro Probe Head \(Full BW\)"](#) on page 152.

NOTE

For Spice model, refer to ["MX0100A Micro Probe Head"](#) on page 222.

NOTE

If the probe tip lead wire is damaged or worn out, replace the lead wire using the procedure ["To Replace an MX0100A Probe Tip Lead Wire"](#) on page 106. To know how to avoid damage to the MX0100A probe head, refer to the topic ["MX0100A Probe Head Handling Precautions"](#) on page 47.

Trimming the Lead Wires of MX0100A Probe Head

Before soldering, trim the probe head's lead wires matching your DUT's geometry. You can choose from the following lead wire lengths:

- **135 mil (3.4 mm)** - The probe head is shipped with this factory-trimmed standard length. Use this lead wire length to accommodate variable-pitch targets. With this length, you get the maximum convenience in terms of longer reach and the available bandwidth is the full bandwidth of the probe amplifier being used (1168B: 10 GHz and 1169B: 12 GHz).

- **60 mil (1.5 mm)** - If your DUT's geometry allows you to use shorter lead wire length, trim the wires to this length to get the maximum performance. Use this lead wire length to accommodate small fine-pitch targets. The available bandwidth is the full bandwidth of the probe amplifier being used (1168B: 10 GHz and 1169B: 12 GHz).

NOTE

You need to specify your choice of lead wire length (3.4 mm or 1.5 mm) in the Probe Configuration dialog box of the Infiniium software GUI. This allows the software to load the appropriate s parameter file applicable to that wire length. The s parameter file adjusts the frequency response to enhance the measurements accuracy.

To properly trim the probe head's lead wires

- 1 Use the Keysight supplied trim gauge template that is included as part of the MX0100A probe head kit.

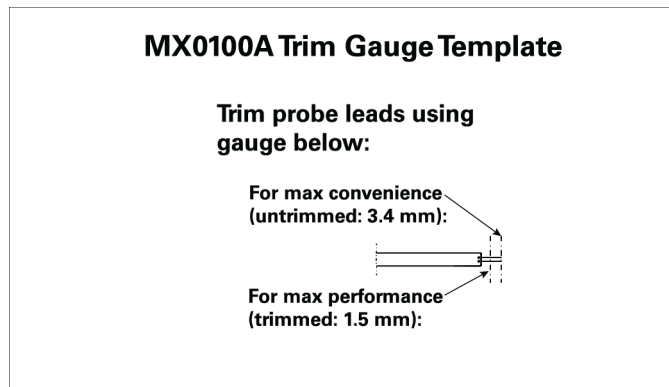

Figure 20 MX0100A Trim Gauge Template (MX0100-94302)

- 2 Using tweezers, place the lead wire over the outline of the lead wires as shown on the trim gauge template. The trim gauge template displays two lengths: 3.4 mm and 1.5 mm. Choose the correct length as per your DUT.
- 3 Using the cutting tweezers, trim the lead wires even with the trim lines.

NOTE

You can spread the probe head's lead wires within the range of 0mm to 7mm span without causing any significant variation in its available bandwidth.

Soldering an MX0100A Probe Head to DUT

NOTE

The tools included in the MX0102A soldering toolkit can be of great use while soldering the MX0100A probe head to DUT (see [page 29](#)). You may purchase this toolkit separately.

To solder the probe tip lead wires to DUT

- 1 Trim the length of the MX0100A probe head lead wires to match your DUT's geometry (see [page 43](#)). You may use the cutting tweezers (Keysight part number 8710-2838) included in the Soldering toolkit.

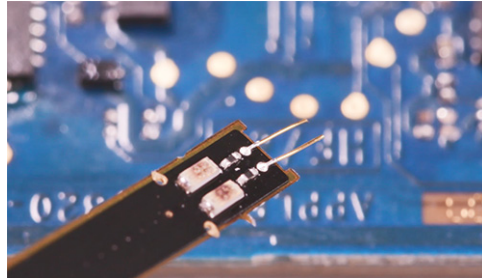

- 2 Apply flux to both DUT and MX0100A probe tip lead wires. Always use plenty of flux, even if your solder already contains flux. This cleans the solder joint and allows for easier flowing solder and quicker dwell times.

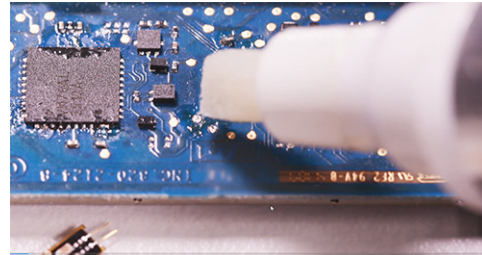

- 3 Add solder to existing test points on DUT, if necessary. Heat momentarily and do not dwell any longer than necessary!

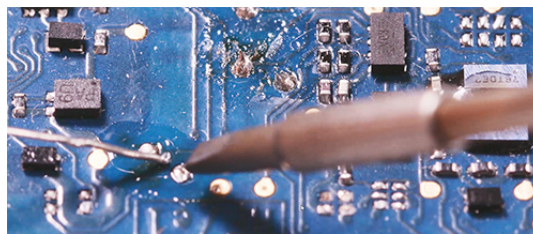

- 4 Connect the MX0100A probe head's lead wires to DUT by positioning these wires on DUT and then reflowing joint while heating momentarily. .

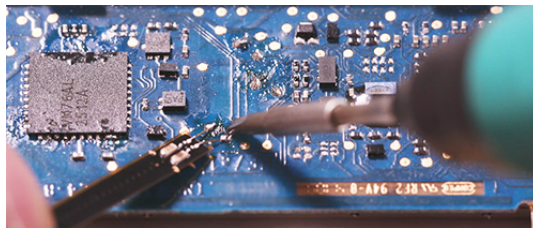

NOTE

Keep the temperature as low as possible while still reflowing the solder at the joint of concern. The following are some of the useful tips to maintain low temperature during soldering.

- A temperature-controlled soldering iron is the best way to do this. Set it for no more than 350°C if using standard lead-free solders and 150°C for tin-bismuth solder.

- Do not rest a soldering iron on a probe joint for more than a few seconds.

- 5 Provide strain-relief to the probe head by taping its mid portion to a flat surface such as a tabletop using the double-sided foam tape (such as Keysight part number 0460-3122 included in the MX0102A Soldering Toolkit). You can also use putty, Velcro or low temperature hot glue instead.

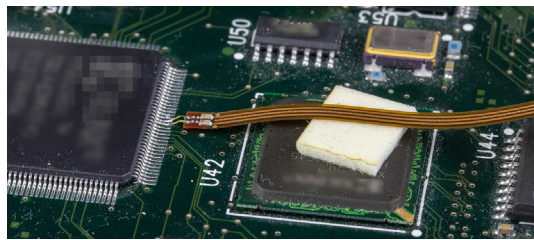

- 6 Connect the soldered MX0100A probe head to the InfiniMax probe amplifier using the supplied MX0103A bullet adapter.



- 7 Provide strain-relief to the probe head and probe amplifier plastic housings by using a double-sided foam tape (Keysight part number 0460-3122 included in the MX0102A Soldering Toolkit)..



NOTE

To view a demo on how to solder the lead wires to the DUT, visit www.keysight.com/find/MX0100A and click the demo file displayed under Document Library.

MX0100A Probe Head Handling Precautions

One of the advantages of the MX0100A probe head is its reusability feature. This section describes some of the cautions and tips on how to properly handle the MX0100A probe head to prevent damage and maintain high performance and reusability of the probe head.

To prevent damage and ensure reusability of the MX0100A probe head

- After you have connected the MX0100A probe head electrically to a DUT via solder, it is best to secure it mechanically as well. Always provide strain relief to the probe head setup using putty, velcro, low temperature hot glue, or double-sided foam tape to prevent any unnecessary strain to the probe head and to protect delicate connections.
- Strain relief is recommended at the probe head and amplifier housings as well as at the probe head cable.

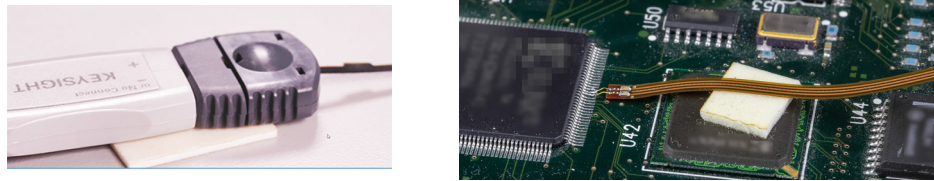

Figure 21 Example of a properly strain-relieved MX0100A probe head setup

- While moving a soldered MX0100A probe head, always ensure that you do not twist, pull, tightly bend, or apply force near the probe head's cable housing.

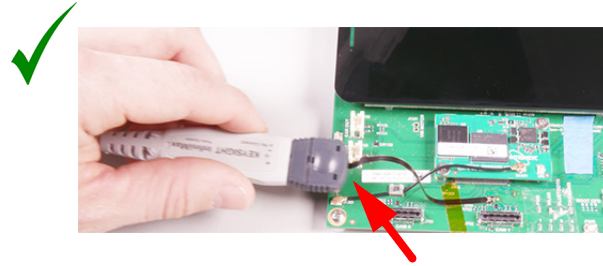

Figure 22 Example of correct movement of MX0100A probe head

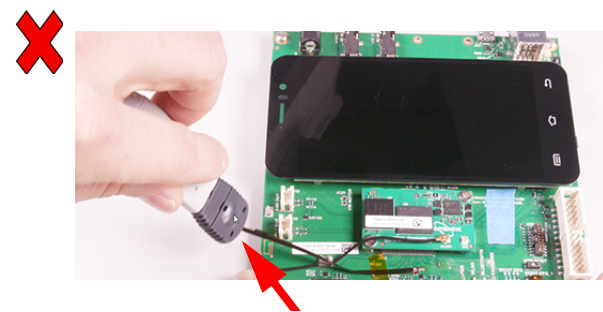

Figure 23 Example of incorrect movement of MX0100A probe head

- Use a microscope setup while performing soldering/de-soldering tasks. A microscope with the following features is recommended.
 - Binocular eyepieces
 - Adjustable magnification (at least 20x)
 - Good working distance from the sample (at least 4 inches)
 - Adjustable arm
 - Integrated ring light around the objective lens
- Ensure that there is less thermal stress on the probe head as well as DUT by:
 - Using a high quality temperature controlled soldering iron with the tip temperature set as low as possible (just high enough to melt the alloy).
 - Using a low temperature solder alloy such as SAC (Tin / Silver / Copper) with 220 °C melting point), or tin-bismuth solder with 138 °C melting point.
- Do not apply heat on the probe tip leads for a time period longer than two seconds.
- Use a small solder iron tip (<1mm is recommended).
- No clean (non-conductive) and less acidic flux is recommended.
- While disconnecting the probe head from the MX0103A bullet adapter:
 - either gently pull the bullet adapter from the probe head by hand
 - or engage a flat screwdriver on the notch provided on the bullet adapter and gently disconnect the probe head from bullet adapter.



To check the MX0100A probe head for any damage

You can use a Digital Multimeter to check the resistance measurement of your MX0100A probe head. If the resistance measurement between the probe head's tip and tail is 25.2 kohm, then the probe head is usable,



Figure 24 Resistance measurement for an undamaged MX0100A probe head

For a damaged probe head, the resistance measurement between the MX0100A probe head tip wire and the center conductor of the SMP connector of the MX0100A is displayed as Infinite.



Figure 25 Resistance measurement for a damaged MX0100A probe head

2. N5381B Differential Solder-In



The N5381B allows a soldered connection into a system for a reliable hands-free connection. This probe configuration provides the full bandwidth signals (1168B: 10 GHz, 1169B: 12 GHz) and the lowest capacitive loading for measuring both single-ended and differential signals. It utilizes strong 7 mil (or optional 5 mil) diameter nickel wires, which allow connection to very small, fine pitch targets.

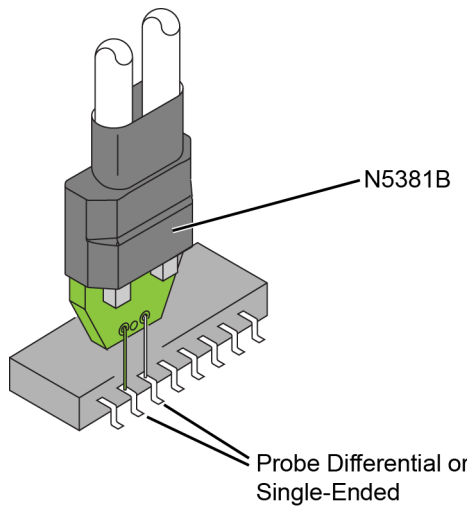
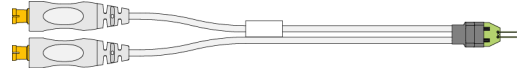

Figure 26 N5381B

Table 11 Supplied Accessories

Accessory	Quantity	Part Number
0.007 inch tin-plated nickel wire	1	01169-81301
0.005 inch tin-plated nickel wire	1	01169-21306
Trim Gauge	1	—

NOTE

To install or repair the leads. Refer to **“N5381B/N5382A Probe Heads”** on page 109.

NOTE

For the differential solder-in probe head, the + and – connection can be determined when the probe head is plugged into the probe amplifier, therefore, it does not matter which way the tip is soldered.

CAUTION

Figure 27 shows how to adjust the spacing of the head's wires without stressing the solder joint. Use tweezers to grab and stabilize the lead near the pc board edge. Then, without moving the tweezers, position the wires as needed. Stabilizing the wire near the solder joint reduces stress at the solder joint. The wires will last much longer with multiple adjustments.

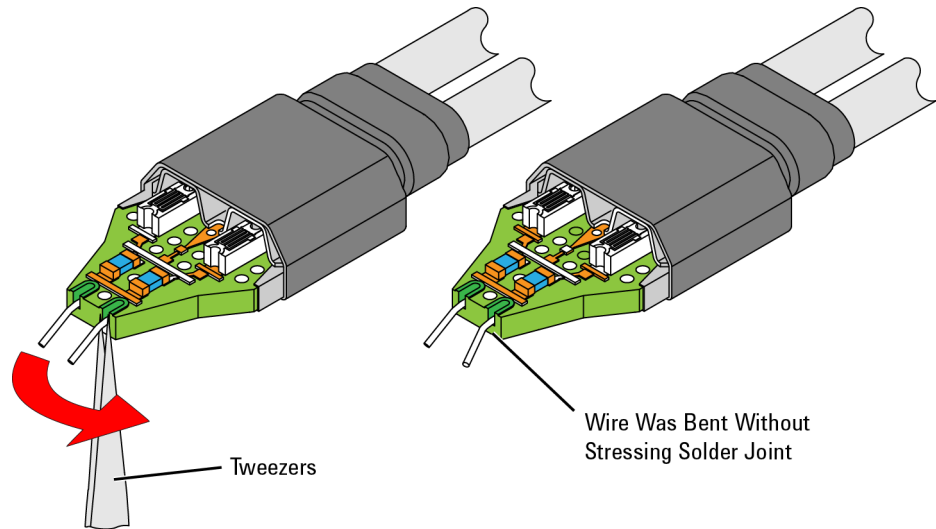

Figure 27 Adjusting Spacing Without Stressing Solder Joint

NOTE

When soldering in leads to the DUT always use plenty of flux. The flux will ensure a good, strong solder joint without having to use an excessive amount of solder.

NOTE

Strain relieve the micro coax leading away from the solder-in tips using hook-and-loop fasteners or adhesive tape to protect delicate connections.

NOTE

Performance plots. Refer to "[N5381B & N5382A Differential Probe Heads \(Full BW\)](#)" on page 166.

NOTE

Spice model. Refer to "[N5381B and N5382A Heads](#)" on page 224.

3. N2839A Differential Browser

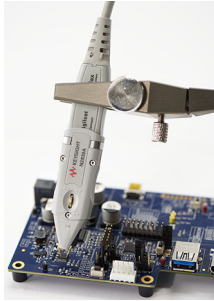

The N2839A differential browser is the best choice for general purpose troubleshooting of a circuit board for full bandwidth signals (1168B: 10 GHz, 1169B: 12 GHz). The probe head's full bandwidth performance, adjustable tips, and ergonomic design makes it ideal for hand held measuring of differential and single-ended signals.

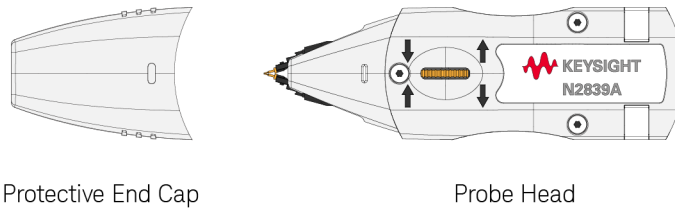

Figure 28 N2839A Probe Head with Protective End Cap

Probing

When probing, observe the following tips:

- Compress the probe tips against the measurement point by applying gentle pressure along the probe's axis.
- When possible, hold the browser vertical and perpendicular to the circuit board.
- If a tip becomes damaged or are worn out, replace the tip using the procedure "[Installing or Replacing the Browser's Tips](#)" on page 54.

CAUTION

When a tip is damaged do not continue probing. Failure to replace the tip can result in permanent damage with the tip lodged into the tip arm's socket.

CAUTION

When not using the N2839A, always snap the protective end cap onto the browser to protect the delicate tips. The physics of designing tips for high frequency, accurate measurements requires that the tip dimensions remain small.

CAUTION

When probing, do not apply a side load to the browser, which might result in damaged tips.

WARNING

As the spring-loaded tips are sharp, handle the N2839A with care to avoid injury.

Adjustable Tip Spacing

The spacing between the N2839A's tips can be adjusted from 0 mm to 3 mm using the adjustment wheel shown in **Figure 29**.

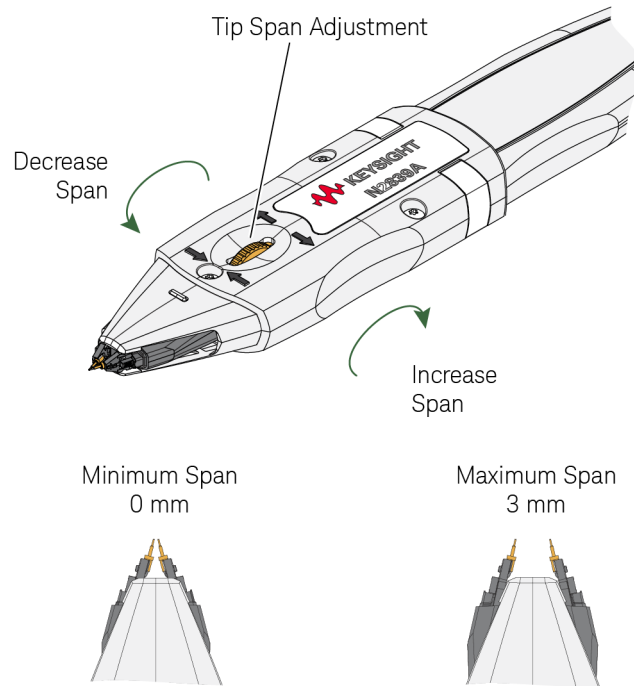

Figure 29 Adjusting the Tip Spacing

Hands-Free Probing

For hands-free stability, the N2839A can be mounted on an N2784/5A or N2787A probe positioner. Or, you can construct a custom holder using the mounting dimensions shown in **Figure 30**. Use a M2 x 4 mm thread screw to attach the probe head. For additional probe head dimensions, refer to **Figure 118** on page 146.

CAUTION

Do not allow the mounting screw to penetrate more than 4 mm into the browser's mounting hole. Torque the mounting screw to 0.09 Nm (0.8 lb-in.).

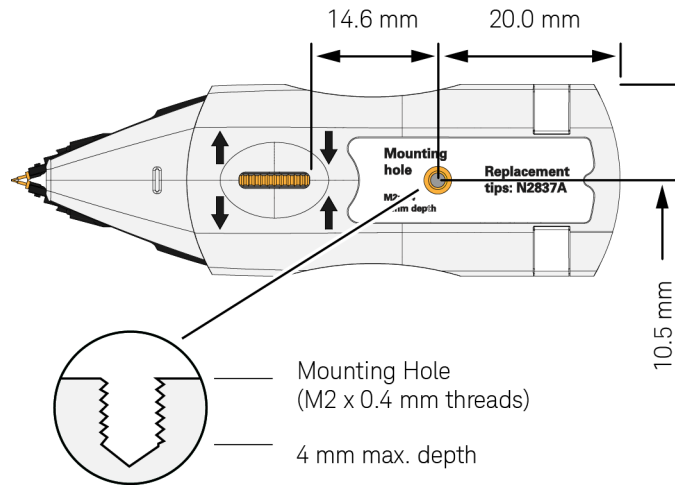

Figure 30 Location and Dimensions of Mounting Hole

Installing or Replacing the Browser's Tips

Use the following procedure to install or replace the tips on the N2839A probe head. For replacement tips, order the N2837A replacement tip kit which contains 20 replacement tips.

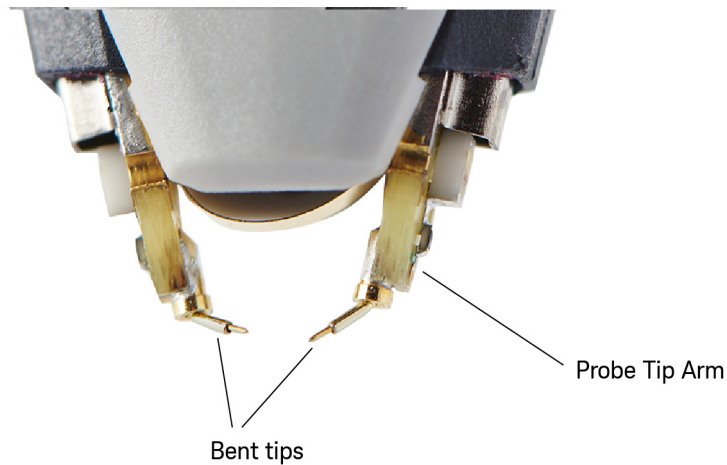

Figure 31 Example of a damaged tips

- 1 Adjust the browser's thumb wheel so that the tip span is set to its maximum range.
- 2 To remove an existing tip, use your fingers or the supplied ESD-safe tweezers. Gently pull the tip straight out of the browser. Do not twist or turn the tip.

- 3 Pick up a new tip using the supplied tweezers. Identify the correct end to insert into the tip arm as shown in **Figure 32**. The end of the tip that has the widest diameter is inserted into the tip arm.
- 4 Using the tweezers, align the new tip with the browser's tip socket and gently insert the tip while avoiding any twisting motion.

CAUTION

The tip arm can be damaged if too much force is applied when inserting the tip. The tip is held in the tip arm by friction and *not* by a snap or detent connection.

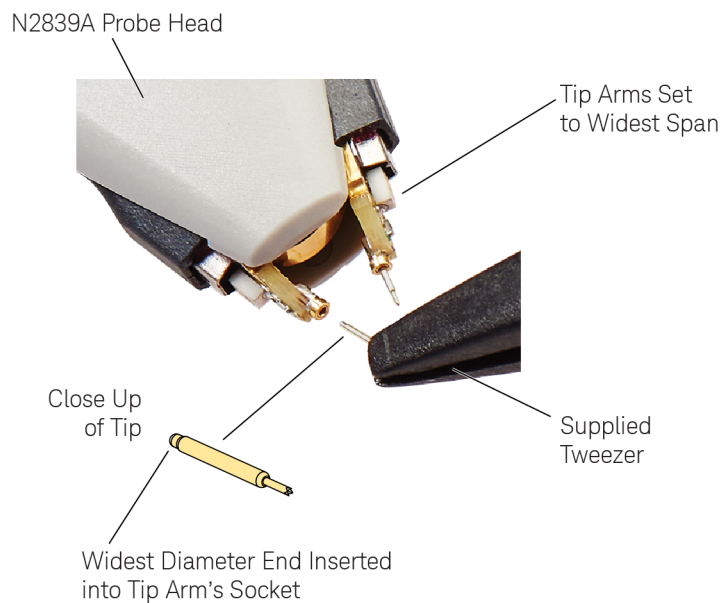

Figure 32 Inserting a Tip

- 5 Hold the probe vertically and gently press the tip on a hard surface, such as the tweezers, to seat the tip.

Location of Serial Number

The N2839A's serial number is located inside the browser's head-to-amplifier connection as shown in **Figure 33**.

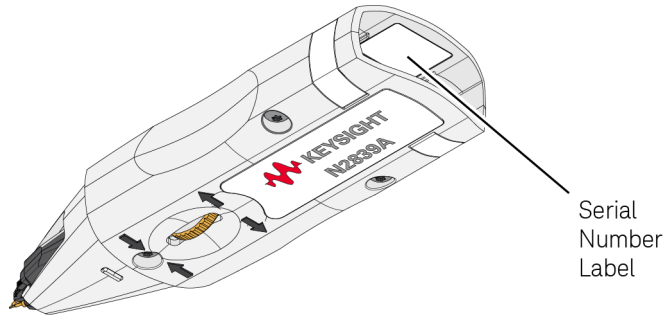

Figure 33 Location of Serial Number Label

Accessories

Table 12 Supplied Accessories

Accessory	Quantity
Spring-loaded tips	20
Straight probe tips	20
Tweezer for replacing tips	1
Protective end cap	1

NOTE

The N2839A browser with a serial number starting with US5900 or higher is shipped with both straight and spring-loaded tips. Browsers with a serial number less than US5900 are shipped with only spring-loaded tips.

Table 13 Available Accessories

Accessory	Quantity
N2837A Replacement Tip Kit. Includes:	
▪ Spring-loaded tips. (0.0115 in. diameter, 0.126 in. long)	20
▪ Straight probe tips (0.003 in. diameter, 0.113 in. long)	20

NOTE

Performance plots. Refer to **“N2839A Differential Browser Head (Full BW)”** on page 157.

4. N5382A Differential Browser

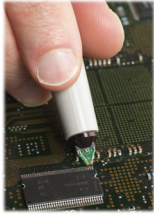

If an N2839A browser is not available, the N5382A differential hand-held browser is the best choice for general purpose troubleshooting of a circuit

board for full bandwidth signals (1168B: 10 GHz, 1169B: 12 GHz). This probe head has the same tip pc board and the same length tip wires so it provides the same full bandwidth performance and fidelity as the solder-in probe head for measuring differential and single-ended signals. The tip wires for this probe head are tin plated spring steel that can be formed to different spacing and provide compliance for a reliable connection. The N5382A comes with an ergonomic handle to aid in positioning the probe head.

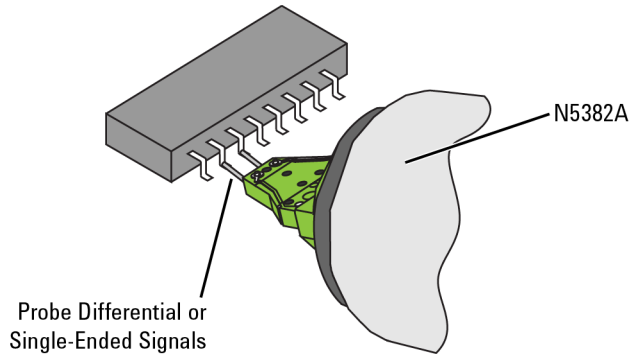
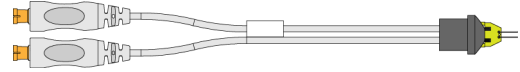

Figure 34 N5382A

Table 14 Supplied Accessories

Accessory	Quantity	Part Number
Ergonomic Handle	1	01130-43202
0.005 inch tin-plated steel wire		01169-21304
Trim Gauge	1	—

NOTE

To install or repair the leads. Refer to “[N5381B/N5382A Probe Heads](#)” on page 109.

CAUTION

Figure 35 shows how to adjust the spacing of the browser’s wires without stressing the solder joint. Use tweezers to grab and stabilize the lead near the pc board edge. Then, without moving the tweezers, position the wires as needed. Stabilizing the wire near the solder joint reduces stress at the solder joint. The wires will last much longer with multiple adjustments. Although **Figure 35** shows the N5381B probe head, the technique used is the same.

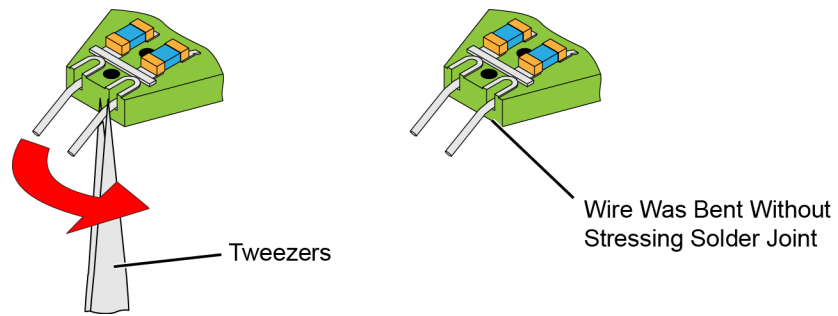

Figure 35 Adjusting Spacing Without Stressing Solder Joint

When holding the N5382A for extended periods of time, use the N5382A's supplied ergonomic handle. [Figure 36](#) on page 59 and [Figure 37](#) show how to mount the browser in the ergonomic handle.

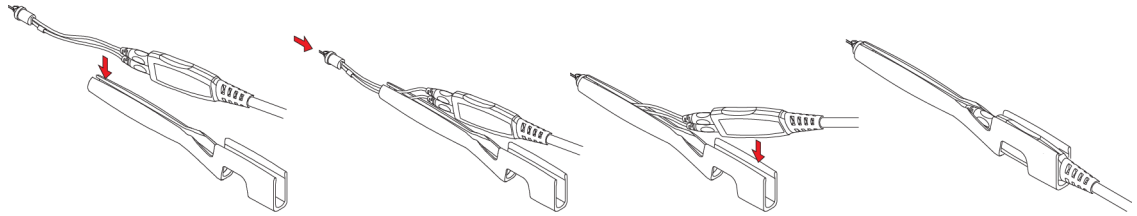

Figure 36 Inserting the Probe into the Handle

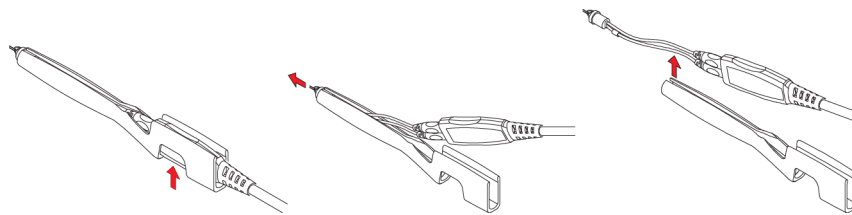

Figure 37 Removing the Probe from the Handle

NOTE

Performance plots. Refer to **“N5381B & N5382A Differential Probe Heads (Full BW)”** on page 166.

5. N5380B SMA

The N5380B SMA probe head provides the highest bandwidth (1168B: 10 GHz, 1169B: 12 GHz) for connecting to SMA connectors. The input resistance is 50Ω on both inputs. A shorting cap connects one side of both resistances to ground. For applications that require the resistances to be referenced to a voltage other than ground, the shorting cap can be removed and a dc voltage can be applied.

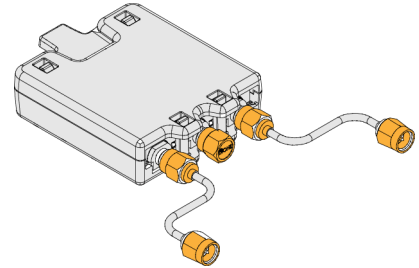

When disconnecting a probe amplifier from the N5380B SMA probe head, grasp the probe amplifier as shown in **Figure 38** and pull it straight away from the SMA probe head without any rocking (either side-to-side or up-and-down).

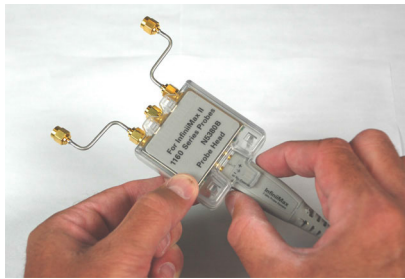

Figure 38 Disconnecting the N5380B

CAUTION

Pulling on the probe amplifier cable or strain relief, or rocking the probe amplifier to remove it, may damage the probe head or probe amplifier.

N5380A/B Head Support

The probe amplifier can become damaged if the N5380A/B does not have an N5380-64701 SMA head support attached. N5380B heads come with the SMA head support already attached. For older N5380A heads, the head support can be ordered. As shown in **Figure 39** on page 61, the current design of the N5380-64701 has been changed from the original design. The original design is no longer offered. Both the original and new design provide the same level of protection for the probe amplifier and can be attached to both N5380B and N5380A heads.

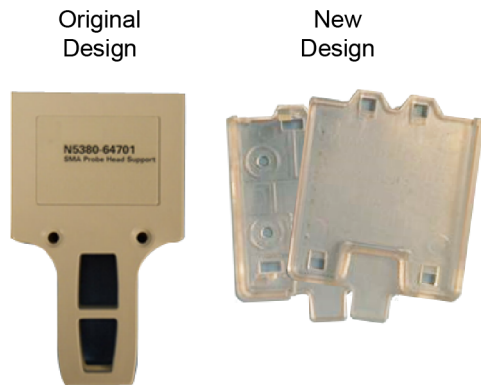

Figure 39 Original and New Head Support Designs

NOTE

Performance plots. Refer to **“N5380B SMA Probe Head (Full BW)”** on page 162.

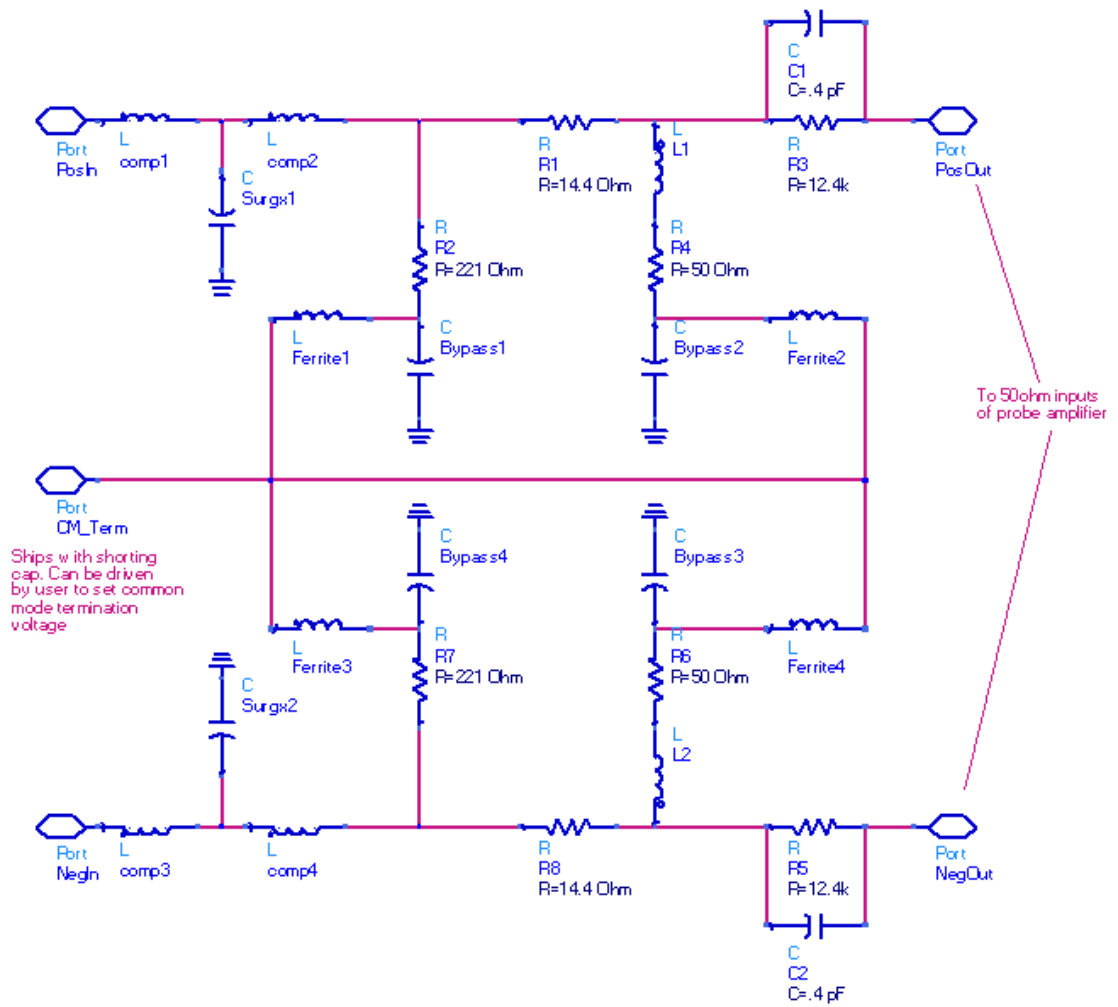
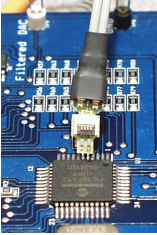

Figure 40 N5380B Schematic

6. N5425B with N5426A ZIF Tip



The N5425B and N5426A combination provides the high bandwidth signals (1168B: 10 GHz, 1169B: 12 GHz) and the lowest capacitive loading for measuring both single-ended and differential signals. The N5426A ZIF tip accommodates very small fine pitch targets. For variable-pitch targets, use the N5451A tip as described in [“9. N5425B with N5451A Long-Wire ZIF Tip \(7 mm\)”](#) on page 71 and [“10. N5425B with N5451A Long-Wire ZIF Tip \(11 mm\)”](#) on page 73. The ZIF tip must be soldered to the circuit that you are measuring.

To attach the ZIF probe head into the ZIF tip, open (lift up) the tip’s black latch, insert the probe head into the tip, and close the latch. To solder a ZIF tip to your DUT, refer to [“Soldering a ZIF Tip to a DUT”](#) on page 86.

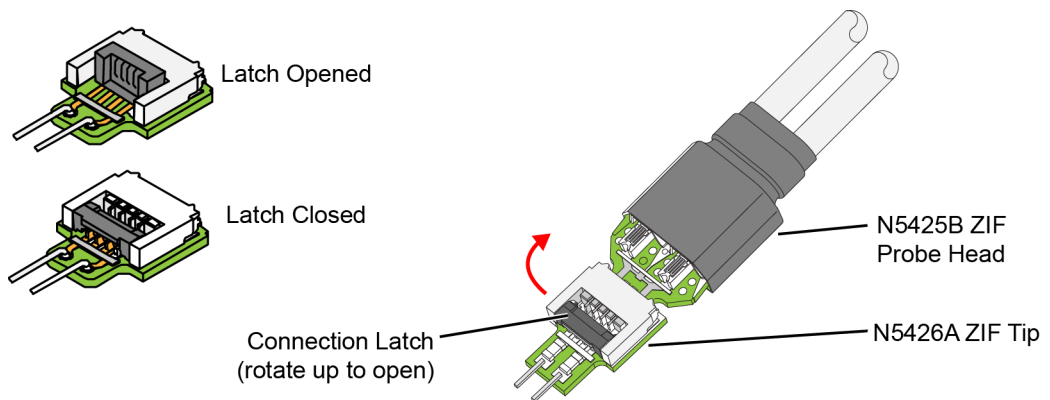

Figure 41 N5426A ZIF Head with N5451A ZIF Tip Attached

NOTE

The N5425B ZIF probe head does not come with any ZIF probe tips. ZIF probe tips N5426A, N5451A, or N2884A must be separately ordered.

NOTE

Performance plots. Refer to [“N5425B ZIF Probe Head \(Full BW\)”](#) on page 172.

NOTE

Spice model. Refer to [“N5425B ZIF Head with N5426A ZIF Tip Attached”](#) on page 230.

7. N5425B with N2884A Fine Wire ZIF Tip

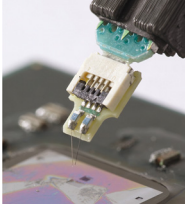

The N2884A fine-wired ZIF tip is similar to the N5426A and N5451A ZIF tips except they are equipped with 22 micron tungsten wires. As wires are extremely small and difficult to see, use a high-powered microscope when working with these tips. Please also note that it is important to handle these fine wire ZIF tips carefully as the thin wires can be easily damaged. The full bandwidth is available (1168B: 10 GHz, 1169B: 12 GHz).

To attach the ZIF probe head into the ZIF tip, open (lift up) the tip's black latch, insert the probe head into the tip, and close the latch.

NOTE

To learn the proper method of using the N2884A tip, refer to ["Using N2884A Fine-Wire ZIF tips"](#) on page 90.

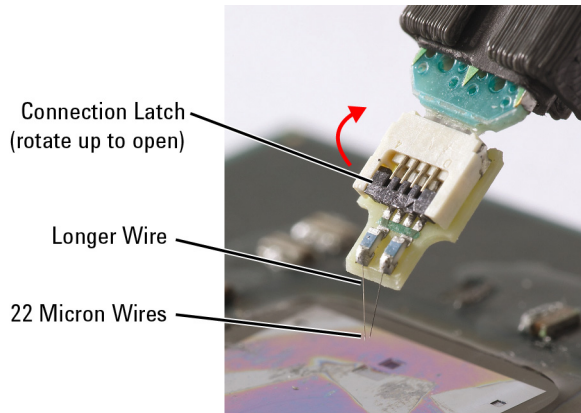

Figure 42 Fine Wires on N2884A Tip

NOTE

The N5425B ZIF probe head does not come with any ZIF probe tips. ZIF probe tips N5426A, N5451A, or N2884A must be separately ordered.

NOTE

Performance plots. The response plots for the N2884A Fine Wire ZIF tips are substantially the same as the plots for the N5425B standard ZIF tip. Refer to ["N5425B ZIF Probe Head \(Full BW\)"](#) on page 172. The only major difference is that the bandwidth for the N2884A (with the 1169B probe amplifier) is slightly less than for the N5425B (12 GHz versus 12.3 GHz). Use the SPICE model for the N5425B to model the input loading for the N2884A.

The N2884A kit comes with five fine wire ZIF tips and one positioner arm with thumb nut (to mount the probe head to a micropositioner).

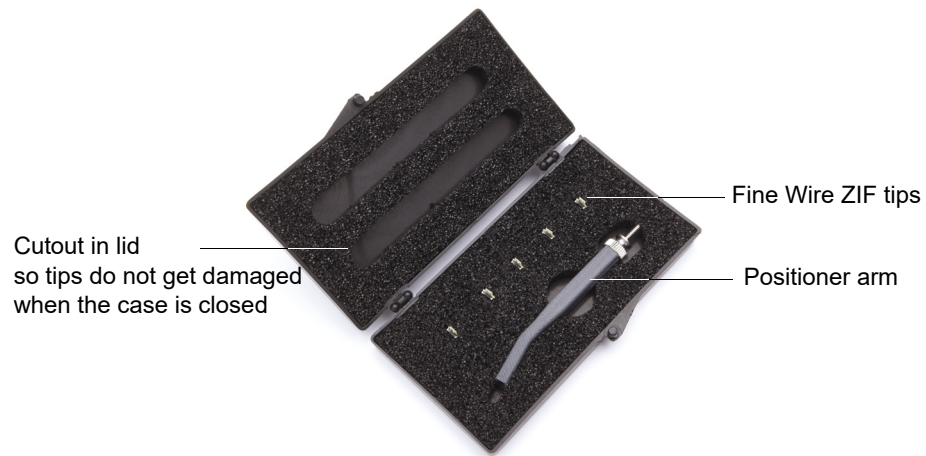

Figure 43 N2884A Kit with Fine Wire ZIF Tips

CAUTION

Be very careful with the 22 micron tungsten wires as they are very easily damaged.

CAUTION

It is very difficult to see the thin wires. Do not assume that they are not attached to the tip simply because you cannot see them at first glance.

CAUTION

When removing the tips from the packaging, use flat nose tweezers and grab the tip by the pc board. Do not ever grab the tip by the wires.

CAUTION

Once the tip is attached to the ZIF probe head, make sure the tip's latch is placed in the closed position to secure the connection.

CAUTION

Make sure the micropositioner is secured to something metallic (its base is magnetic) as it is nose-heavy. If it is left resting on a surface that the metallic base cannot secure to, it will tip over and the Fine Wire ZIF tip may become damaged.

CAUTION

When placing the Fine Wire ZIF tips back into the case, ensure that the tips are pointing directly up. The cutouts in the top of the case provide space for these wires when the case is closed. However, if the tips are not pointing directly up, they may miss these cutouts and become damaged.

CAUTION

When the Fine Wire ZIF tip is positioned under a microscope, be very careful with the lenses of the microscope as you adjust the magnification or focus. If one of the lenses strikes the tip, it could permanently damage it.

CAUTION

The two wires can come into contact during probing if you are not careful in preventing it. There are two ways this can happen. (1) If you set the longer wire and then try to probe a position with the short wire that forces their tips to cross, the two wires can touch. (2) When you set the wires, they will buckle. The wires may not be touching at their tips in this case (so they would look fine under a microscope), but the buckling could cause them to touch each other near their mid-points. Therefore, it is always a good idea to decrease the amount of magnification so you can see the entire wire lengths and make sure they are not in contact. Only turn on the device under test (DUT) when you have verified that the wires are not touching.

8. N2851A QuickTip Probe Head

The N2851A QuickTip probe head is used with an N2849A QuickTip.

Together they provide an easy-to-make secure magnetic mechanical connection between the probe head and QuickTip. Three magnets in the head connect the two sides of a differential signal and a ground. No latch lever is used!

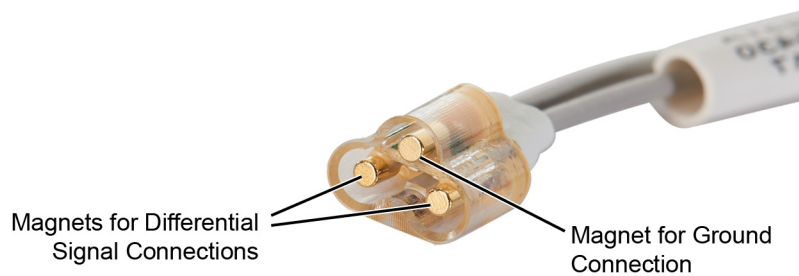

Figure 44 Magnet Connections in Probe Head

Table 15 Bandwidth

Probe Amplifier	BW
1169B	12 GHz
1168B	10 GHz

Permanently solder any number of QuickTips to your DUT as shown in [Figure 45](#) on page 68. Because the probe head is magnetically connected (instead of mechanically connected) to the QuickTip, you can effortlessly connect and disconnect to each QuickTip. For best performance, position the QuickTip vertically on the DUT. The N2849A QuickTip has two signal leads and two ground leads. The ground leads have minimal effect on your differential measurements. However, if you are making only differential measurements you can optionally cut off the ground leads or fold them out of the way. Be aware that without the ground leads, the mechanical stability of the QuickTip will be reduced and you will need to stabilize the probe head.

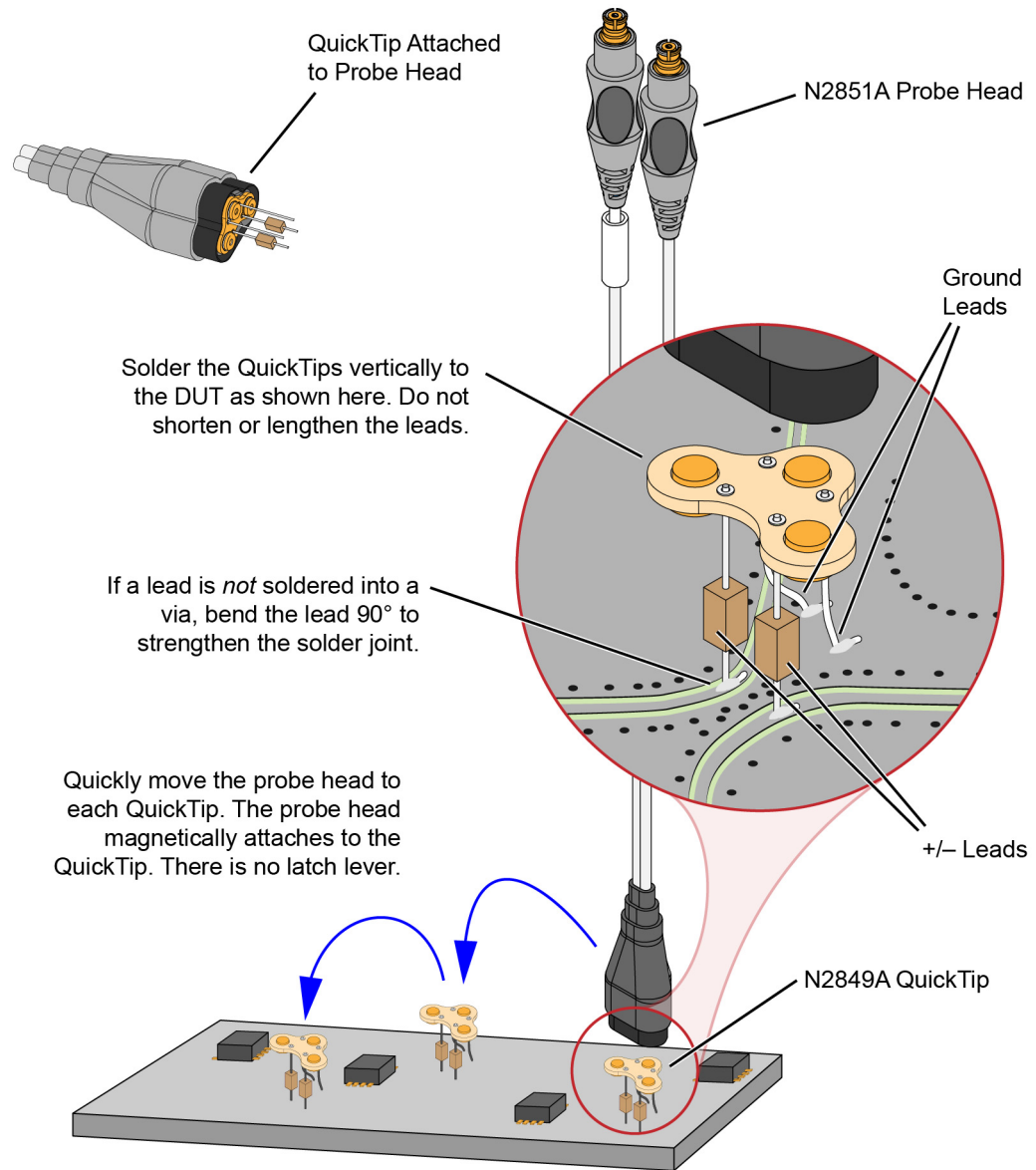

Figure 45 Probing with the N2851A Probe Head and N2849A QuickTip

NOTE

N2849A QuickTips are also compatible with N2848A QuickTip InfiniiMode Probe Heads, which are designed for N2800/1/2/3A, N2830/1/2A, and N7000/1/2/3A probes.

CAUTION

Do not replace or repair the N2849A QuickTip's resistor or ground leads. Attempting to do so will damage the ability of the tip to mate with the N2851A probe head.

NOTE

The N2851A does not include any N2849A QuickTips. The N2849A must be ordered separately.

NOTE

Before connecting the QuickTip head to the tip, use the tack-putty (N5439-65201) included with the N2848A QuickTip probe head or the N2787A 3D probe positioner for securing the probe amplifier to a rigid body near the DUT.

NOTE

For performance plots, refer to [Chapter 6](#), “Performance Plots.”

Connecting a QuickTip to the DUT

Use the following tips when soldering the QuickTips to your DUT:

- Orient the QuickTip vertically as shown in [Figure 45](#) on page 68.
- Solder the four leads to vias or surfaces.

CAUTION

Always mechanically strain-relieve the QuickTip head *before* using to protect both your probe accessories and DUT from damage.

NOTE

Resistor and wire leads on the QuickTip are factory trimmed to the proper length for use. Adding wire length to the tip of the mini-axial lead resistors or to the ground leads will degrade the performance of the probe.

NOTE

Soldering the ground wires is not required when making differential or single-ended (+ or - leads) measurements.

- When soldering to a via, always trim the lead close to the via’s underside.
- If a lead is to be soldered to a surface and *not* a via, make a stronger solder joint by bending the end of the lead 90°. For signal leads, bend the wire approximately half way between the resistor and the end of the wire. Bend the ground leads at about the same distance.

CAUTION

Be careful not to damage the tip wires when handling the QuickTips. Wires can be carefully reshaped with tweezers or fingers if necessary.

CAUTION

The QuickTips are very fragile. They must be manufactured in this way in order to meet the high-performance, high bandwidth applications they are intended for. Be extremely careful when handling.

Cleaning the Magnetic Connections

If the three magnetic connections in the head become dirty, clean the connections using the following steps:

- 1 Use compressed air or a cloth to remove any loose dirt.
- 2 Gently rub a small piece of tack putty (supplied with the probe) against the magnetic connections to clean off any remaining surface grime.

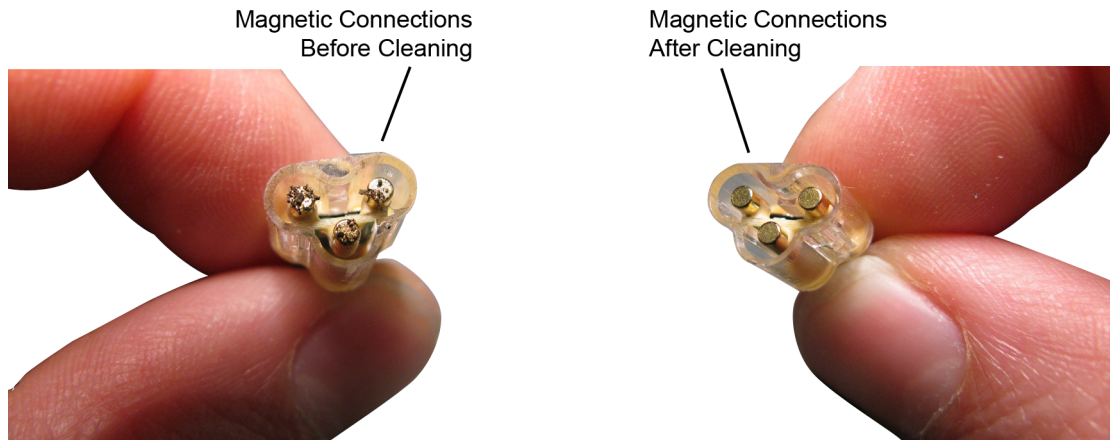

Figure 46 N2851A Head Before and After Cleaning

9. N5425B with N5451A Long-Wire ZIF Tip (7 mm)



The N5451A long-wired ZIF tip with the resistor lengths trimmed to 7 mm accommodates variable-pitch targets. For very small fine pitch targets, use the N5426A tip as described in [“6. N5425B with N5426A ZIF Tip”](#) on page 63. The available bandwidth decreases as the span between the leads increases. With 0° span, the bandwidth is approximately 9.9 GHz. With 60° span, the bandwidth is approximately 4.4 GHz.

The tip must be soldered to the circuit you are measuring. This probe head’s leads use two 91W resistors. To attach the ZIF probe head into the ZIF tip, open (lift up) the tip’s black latch, insert the probe head into the tip, and close the latch.

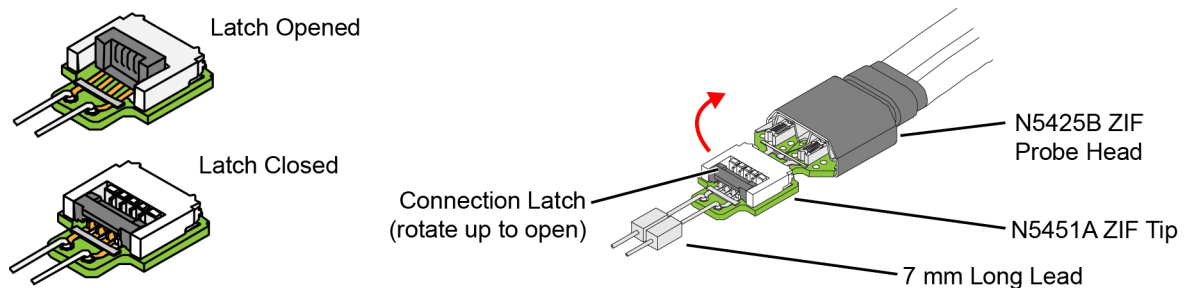

Figure 47 N5451A ZIF Tip Trimmed to 7 mm

NOTE

The N5425B ZIF probe head does not come with any ZIF probe tips. ZIF probe tips N5426A, N5451A, or N2884A must be separately ordered.

NOTE

To solder a ZIF tip to your DUT, refer to [“Soldering a ZIF Tip to a DUT”](#) on page 86.

NOTE

To install or repair resistor leads. Refer to [“N5451A Long-Wired ZIF Tips”](#) on page 114.

NOTE

Performance plots. Refer to [“N5425B ZIF Probe Head with N5451A Long-Wired ZIF Tip”](#) on page 176.

Table 16 Supplied Accessories

Accessory	Quantity	Part Number
ZIF Tips	10	–
Trim Gauge	1	N5451A-94301

To order additional long wire ZIF resistor leads, order 1NC3-1091 (qty 1).

NOTE

Spice model. Refer to **“N5425B ZIF Head with N5451A Long-Wire ZIF Tip”** on page 236.

Removing ZIF Tips from the Packaging Strip

The N5451A long wire ZIF tip kit contains ten ZIF tips connected together in a strip. Before a ZIF tip can be used, it must be separated from its strip. To accomplish this, grab one of the tips with flat nose tweezers and bend it back. Then, bend the tip in the opposite direction and it should break off.

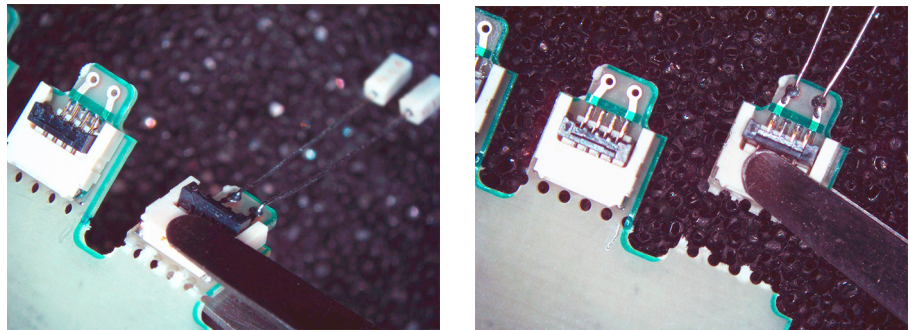
**Figure 48** Breaking Off a Tip

10. N5425B with N5451A Long-Wire ZIF Tip (11 mm)



Use the N5451A long-wired ZIF tip, with the resistor lengths trimmed to 11 mm, to accommodate variable-pitch targets. If a shorter resistor length can be used, you can increase the available bandwidth by using the 7 mm length described in **“9. N5425B with N5451A Long-Wire ZIF Tip (7 mm)”** on page 71. For very small fine pitch targets, use the N5426A tip as described in **“6. N5425B with N5426A ZIF Tip”** on page 63. To attach the ZIF probe head into the ZIF tip, open (lift up) the tip’s black latch, insert the probe head into the tip, and close the latch.

The available bandwidth decreases as the span between the leads increases. With 0° span, the bandwidth is approximately 5 GHz. With 60° span, the bandwidth is approximately 3.3 GHz.

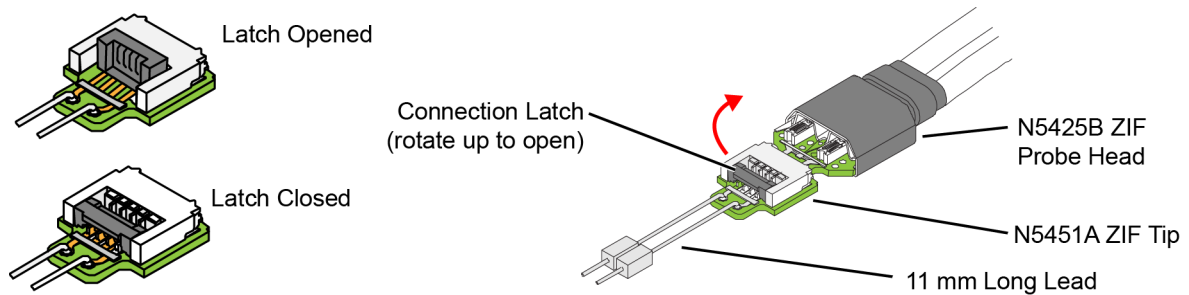

Figure 49 N5451A ZIF Tip Trimmed to 11 mm

NOTE

The N5425B ZIF probe head does not come with any ZIF probe tips. ZIF probe tips N5426A, N5451A, or N2884A must be separately ordered.

NOTE

To solder a ZIF tip to your DUT, refer to **“Soldering a ZIF Tip to a DUT”** on page 86.

NOTE

To install or repair resistor leads. Refer to **“N5451A Long-Wired ZIF Tips”** on page 114.

NOTE

Performance plots. Refer to **“N5425B ZIF Probe Head with N5451A Long-Wired ZIF Tip”** on page 176.

NOTE

Spice model. Refer to **“N5425B ZIF Head with N5451A Long-Wire ZIF Tip”** on page 236.

Removing ZIF Tips from the Packaging Strip

The N5451A long wire ZIF tip kit contains ten ZIF tips connected together in a strip. Before a ZIF tip can be used, it must be separated from its strip. To accomplish this, grab one of the tips with flat nose tweezers and bend it back. Then, bend the tip in the opposite direction and it should break off.

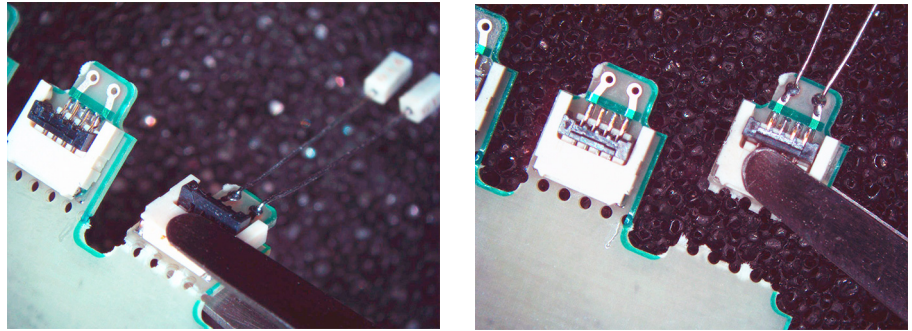

Figure 50 Breaking Off a Tip

11. E2677B Differential Solder-In Probe Head



The E2677B probe configuration provides the full bandwidth signals and the lowest capacitive loading for measuring both single-ended and differential signals. This head allows a soldered connection into a system for a reliable, hands-free connection. At the tip it uses a miniature axial lead resistor with 8 mil diameter leads which allows connection to very small, fine pitch targets. The full bandwidth is available (1168B: 10 GHz, 1169B: 12 GHz).

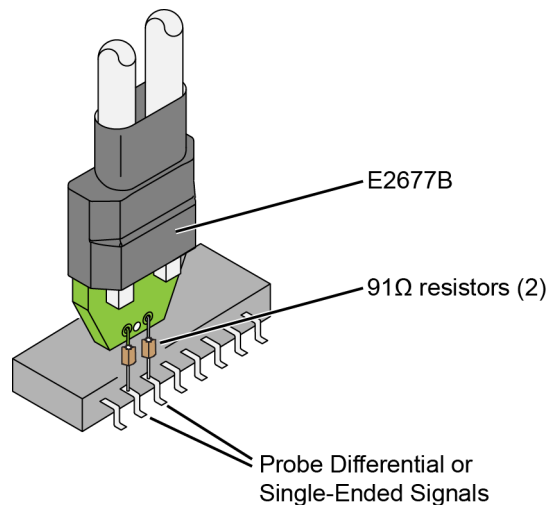

Figure 51 E2677B

The probe head resistors must be soldered to the circuit that you are measuring. Because of the small size of the resistor leads, it is easy to solder them to very small geometry circuits.

NOTE

To install or repair resistor leads. Refer to [“E2677B/9A Solder-In Probe Heads”](#) on page 118.

NOTE

Performance plots. Refer to [“E2677B Differential Solder-in Probe Head \(High BW\)”](#) on page 195.

NOTE

Spice model. Refer to [“E2677B Differential Solder-In Head”](#) on page 253.

CAUTION

Do not solder in resistor leads with a big ball of solder right next to the resistor body. Normally the nickel lead will limit the heat transfer to the resistor body and protect the resistor, but if a ball of solder is right next to the resistor body on the lead, the resistor may come apart internally.

CAUTION

When soldering leads to DUT always use plenty of flux. The flux will ensure a good, strong solder joint without having to use an excessive amount of solder.

CAUTION

Strain relieve the micro coax leading away from the solder-in tips using hook-and-loop fasteners or adhesive tape to protect delicate connections.

NOTE

Cut resistors. Before using the resistors, the resistor wires must be cut to the correct dimensions. For the correct dimensions see "[E2677B/9A Solder-In Probe Heads](#)" on page 118.

12. E2678B Differential Socketed Probe Head

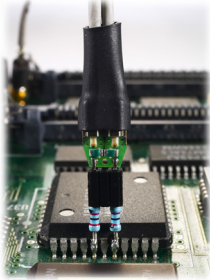

The E2678B probe configuration allows a removable, hands-free connection that provides full bandwidth with a minor increase in capacitance over the probe head for probing differential and single-ended signals. The full bandwidth is available (1168B: 10 GHz, 1169B: 12 GHz).

The 82Ω axial lead resistors are soldered to the circuit that you are measuring. The socketed differential probe head is plugged onto the resistors. This makes it easier to move the probe from one location to another. Because of the larger size of the resistor leads, the target for soldering must be larger than the solder-in probe heads.

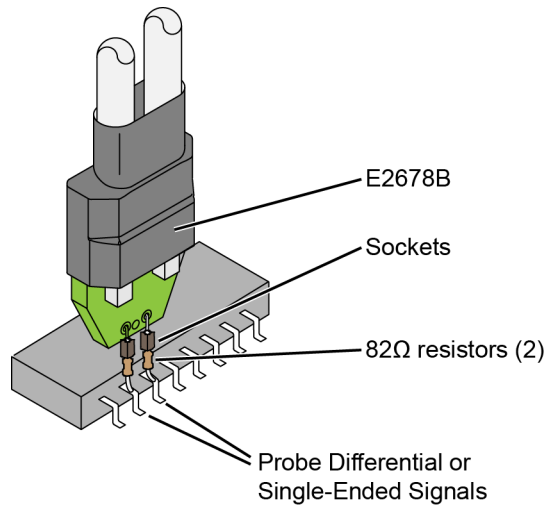

Figure 52 E2678B

NOTE

The E2678B provides a more robust connection between the E2678B head's socket and printed circuit board compared to the previous model. The E2678B's performance and fit are identical to that of the previous model.

NOTE

To install or repair resistor leads. Refer to the information found in this section.

NOTE

Performance plots. Refer to [“E2678B Differential Socketed Probe Head \(High BW\)”](#) on page 197.

NOTE

Spice model. Refer to [“E2678B Differential Socket Tip Head”](#) on page 251.

PC Board Target Dimensions

The spacing for the socketed tip differential probe head is 0.100 inch (2.54 mm). For soldering on a PC board, the targets can be two vias that can accept the 0.020 inch (0.508 mm) diameter resistor leads. A via of 0.025 inch (0.0635 mm) diameter is recommended. If soldering a resistor lead to a surface pad on your PC board, the resistor leads can be bent in an "L" shape and soldered down. A pad size of at least 0.030 x 0.030 inch (0.762 mm x 0.762 mm) is recommended.

Shaping the Resistors

Before installing the 82W resistors (01130-81506) onto your device under test, the resistor wires must be trimmed using diagonal cutters and bent to the correct dimensions as shown in **Figure 53**. Use tweezers, to place the resistor body inside the rectangle of the supplied trim gauge. Use diagonal cutters to trim the leads even with the trim lines.

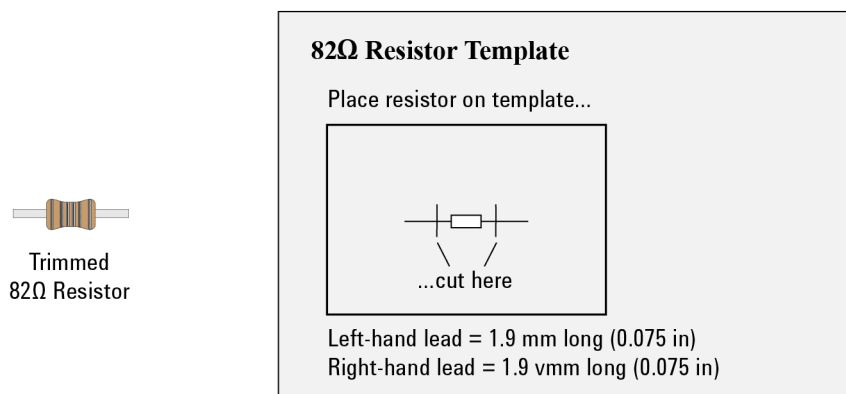

Figure 53 Resistor Trim Dimensions and Trim Gauge

13. E2675B Differential Browser



The E2675B differential browser configuration (bandwidth approximately 5.2 GHz) is the best choice for general purpose troubleshooting of a circuit board. The tab on the side of the probe allows the probe tips to be adjusted for different circuit geometries. The E2675B comes with an optional ergonomic handle to aid in positioning the probe head.

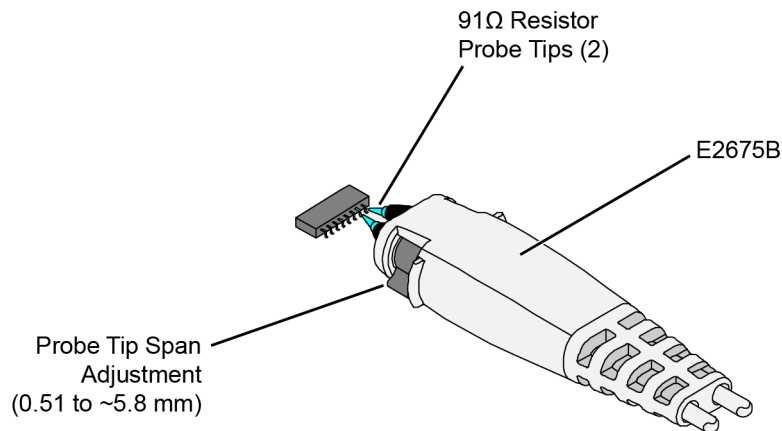

Figure 54 Differential Browser

Do not use the E2675B probe head as a tool to scrape solder mask or other items off of a circuit board. The blue tips can easily be broken off if the browser is not used properly. Always hold the probe head so that the blue tips remain vertical during measurements as shown in [Figure 55](#) on page 80.

NOTE

Performance plots. Refer to [“E2675B Differential Browser”](#) on page 190.

NOTE

Spice model. Refer to [“E2675B Differential Browser Probe Head”](#) on page 249.



Figure 55 Proper Vertical Orientation of the Blue Tips

When holding the E2675B for extended periods of time, use the supplied ergonomic handle. **Figure 56** and **Figure 57** show how to attach and remove the handle from the probe head.

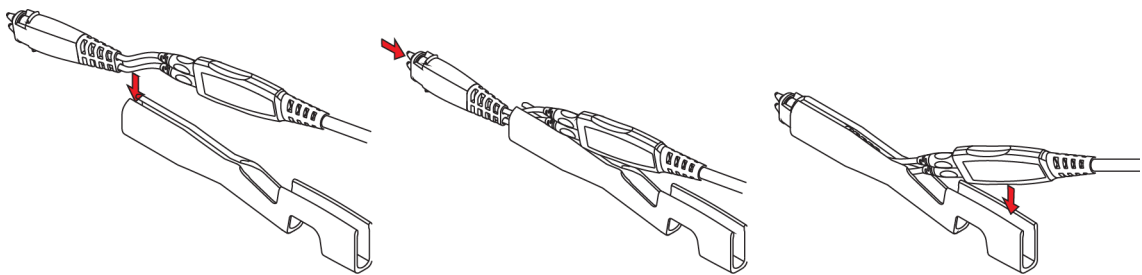

Figure 56 Inserting the Probe

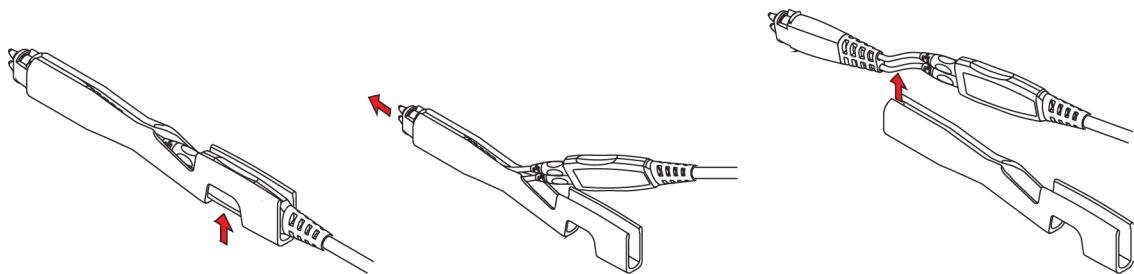
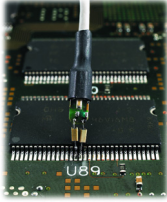

Figure 57 Removing the Probe

14. E2679B Single-Ended Solder-in Probe Head



The E2679B probe configuration provides good bandwidth measurements (approximately 5.2 GHz) of single-ended signals only with a probe head that is physically very small. The probe head resistors must be soldered to the circuit that you are measuring. Because of the small size of the resistor leads, it is easy to solder them to very small geometry circuits.

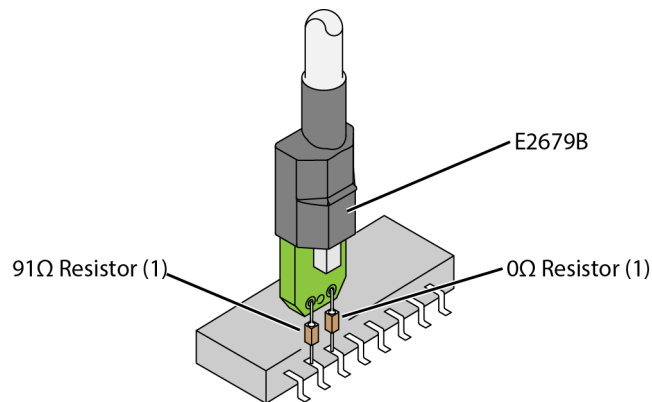

Figure 58 E2679B

This probe head's leads use a 91Ω and 0Ω mini-axial lead resistors.

NOTE

To install or repair resistor leads. Refer to [“E2677B/9A Solder-In Probe Heads”](#) on page 118.

NOTE

Performance plots. Refer to [“E2679B Single-Ended Solder-In Probe Head \(High BW\)”](#) on page 201.

NOTE

Spice model. Refer to [“E2679B Single-Ended Solder-In Head”](#) on page 256.

CAUTION

Do not solder in resistor leads with a big ball of solder right next to the resistor body. Normally the nickel lead will limit the heat transfer to the resistor body and protect the resistor, but if a ball of solder is right next to the resistor body on the lead, the resistor may come apart internally.

CAUTION

When soldering leads to DUT always use plenty of flux. The flux will ensure a good, strong solder joint without having to use an excessive amount of solder.

CAUTION

Strain relieve the micro coax leading away from the solder-in tips using hook-and-loop fasteners or adhesive tape to protect delicate connections.

15. E2676B Single-Ended Browser



The E2676B single-ended browser is a good choice for general purpose probing of single-ended signals when physical size is critical. The bandwidth is approximately 6 GHz. Excessive peaking (+6 dB) can occur at about 9 GHz. Therefore, limit the bandwidth of the input signal.

For wider spans with non-performance critical browsing (rise times greater than approximately 0.5 ns), the E2676-21301 socketed ground lead can be used in place of the 01130-60012 ground collar.

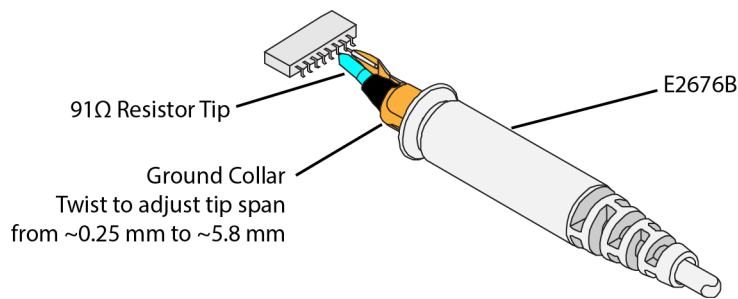

Figure 59 E2676B

NOTE

Performance plots. Refer to **“E2676B Single-Ended Browser”** on page 192.

NOTE

Spice model. Refer to **“E2676B Single-Ended Browser Head”** on page 255.

When holding the E2675B for extended periods of time, use the supplied ergonomic handle. **Figure 60** on page 82 and **Figure 61** show how to attach and remove the handle from the probe head.

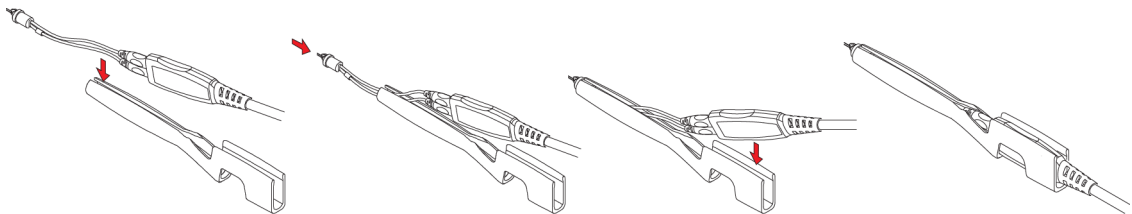

Figure 60 Inserting the Probe into the Handle

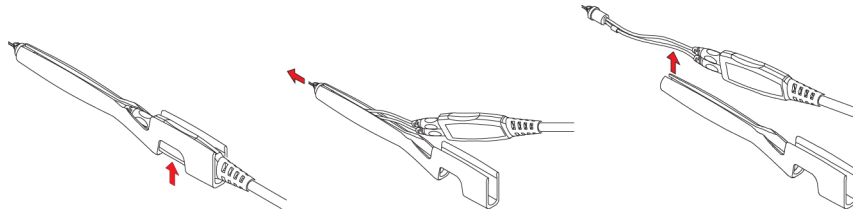
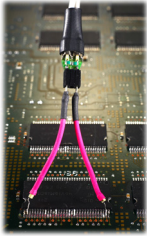

Figure 61 Removing the Probe from the Handle

16. E2678B Differential Socketed & Damped Wire Accessory



This E2678B probe configuration provides maximum connection reach and flexibility with good signal fidelity but lower bandwidth (approximately 1.2 GHz) for measuring differential or single-ended signals. The damped wires must be soldered to the circuit that you are measuring. This configuration can probe circuit points that are farther apart than other configurations. This probe head comes with a damped wire accessory that includes two 160Ω resistors.

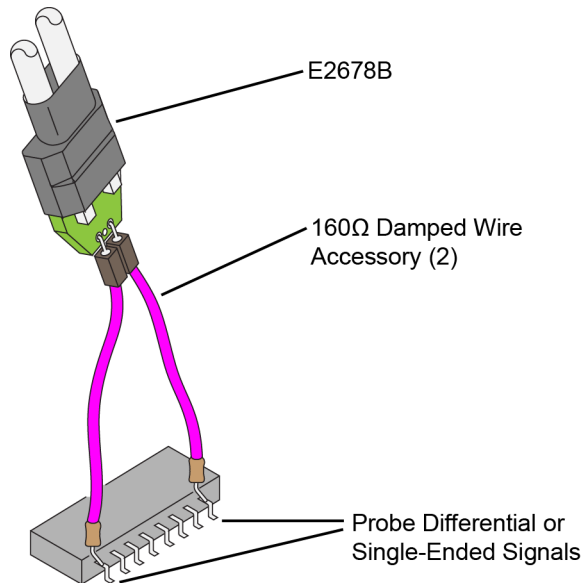

Figure 62 E2678B with Damped Wire Accessory

This probe configuration can be used to connect to 25 mil square pin headers with 100 mil spacing such as those used in USB testing. If the header adapter is used with the 1168B (10 GHz) or the 1169B (12 GHz), the rise time of the input signal should be slower than ~150 ps (10% to 90%) to limit the effects of resonances in the adapter.

All of the specifications and characteristics of the header adapter are the same as those for the socketed differential probe head except for the input capacitance shown in [Table 17](#).

NOTE

The E2678B provides a more robust connection between the E2678B head's socket and printed circuit board compared to the previous model. The E2678B's performance and fit are identical to that of the previous model.

NOTE

Performance plots. Refer to "[E2678B Differential Socketed Probe Head \(High BW\)](#)" on page 197.

Adapting the Damped Wire Accessory from Solder-In to Plug-On

To adapt the damped wire accessory (01130-21303), solder the tip into the 01131-85201 square pin socket and then slip the 01131-41101 heat-shrink sleeve over the solder joint and heat the heat-shrink tubing with a heat gun.

Table 17 Characteristic Capacitance

Identification	Capacitance	Description
C _m	0.43 pF	Model for input C is C _m between the tips and C _g to ground each tip
C _g	0.54 pF	
C _{diff}	0.70 pF	Differential mode capacitance is C _m + C _g /2
C _{se}	0.97 pF	Single-ended mode capacitance is C _m + C _g

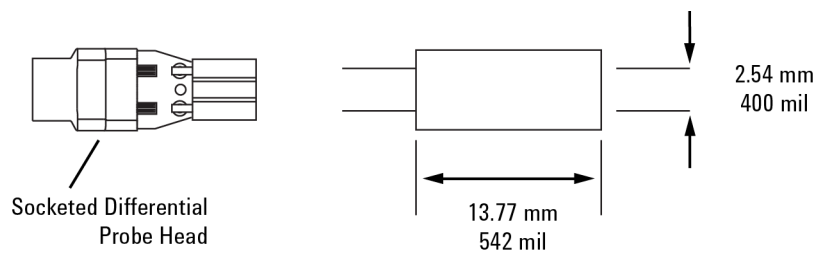

Figure 63 01130-63201 Header Adapter Dimensions

Soldering a ZIF Tip to a DUT

Overview

Soldering a ZIF tip into a DUT is straightforward, but some of the traditional soldering techniques that are typically used on larger components will not work well here. The following is an overview of the recommended soldering techniques

- 1** Add some solder to the DUT connection points. There should be enough solder to provide a good fillet around the ZIF tip's leads, but not so much as to create a big solder ball. A fine MetCal (or equivalent) soldering tip should be used along with some 11 or 15 mil solder.
- 2** Using a rosin flux pen, coat the solder points with flux. The flux core solder does not provide enough flux for this small scale soldering. Also, put flux on the tips of the leads of the ZIF tip.
- 3** Clean the soldering tip well, then add a little bit of solder to the tip. It may take several tries to get just a little bit of solder right at or near the tip of the soldering iron. The solder on the tip keeps the soldering iron tip from pulling solder off the DUT connection points. This step may be optional if there is already enough solder on the DUT connection points.
- 4** Position a lead of the ZIF tip on top of one of the target points, then briefly touch the soldering iron tip to the joint. The thermal mass of this joint is very small, so you don't need to dwell on the joint for very long. The flux that was added to the joint should produce a good, clean solder joint. If you do not get a good, shiny, strong solder joint, then there was either not enough flux or the joint was heated too long and the flux boiled off.
- 5** There is a possibility that if a lead of the ZIF tip is inserted into a large ball of solder that is heated excessively with a soldering iron, the solder joint holding the lead onto the ZIF tip pc board could flow and the lead would come off destroying the ZIF tip. Only the first third of the lead or so needs to be soldered to the target point.

Detailed Procedure

This is an example of installing a ZIF tip to an IC package. The ZIF tip is attached to the first two package leads. The target could also be via pads or signal traces.

- 1 Add some solder to the target points in the DUT. **Figure 64** on page 87 shows extra solder added to the pads for the first two pins on an IC package.

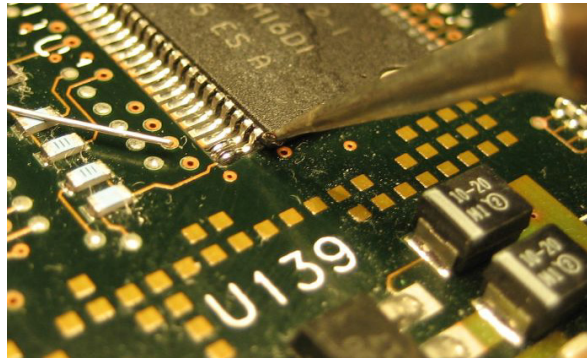

Figure 64 Solder Added to Target Points

- 2 Use flux pen to add flux to the target points. Also, flux the tip of the lead on the ZIF tip at this time.

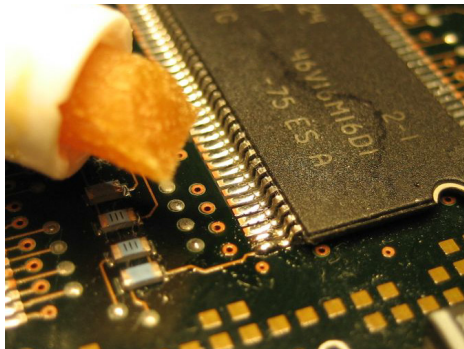

Figure 65 Fluxing of the Target Points

- 3 Clean the soldering iron tip and add a small amount of solder to the very tip. This may take a few tries because the solder may tend to ball up and move away from the tip.



Figure 66 Small Amount of Solder Added to Soldering Iron Tip

- 4 Connect the ZIF tip to the ZIF probe head. This allows the probe head to be used as a handle for the ZIF tip to allow positioning in the DUT. Position the lead wires on the target points and then briefly heat the solder joints. There should be enough solder to form a good fillet and enough flux to make the joint shiny. There shouldn't be so much solder that the big solder ball is formed that could cause a solder bridge or overheat the leads on the ZIF tip.

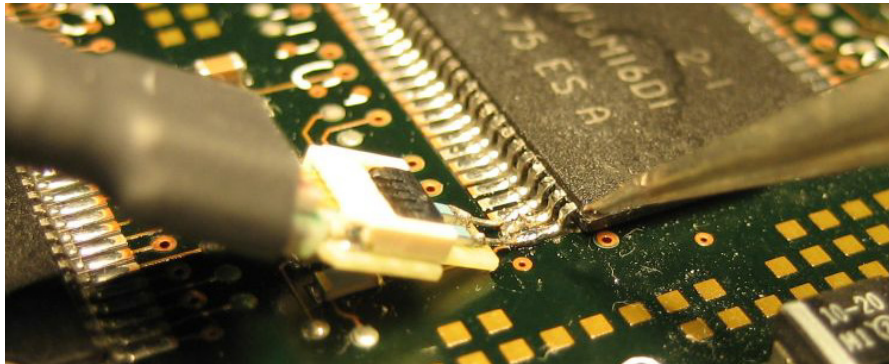

Figure 67 ZIF tip Positioned and Soldered In Place

- 5 Open the ZIF tip latch, and remove ZIF probe head and leave ZIF tip behind for future connection. It is best to use a non-conductive, pointed object such as a toothpick or plastic tool. Hold on the heat-shrink part of the probe head to support the ZIF tip while releasing the latch.

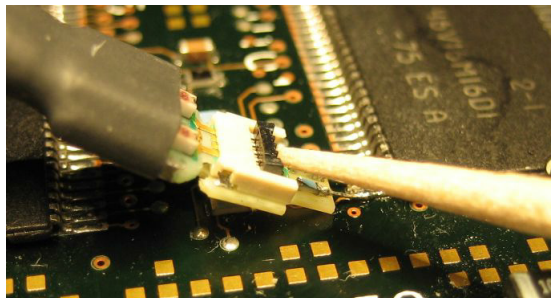

Figure 68 Using a Non-Conductive Tool to Open the ZIF Tip's Latch

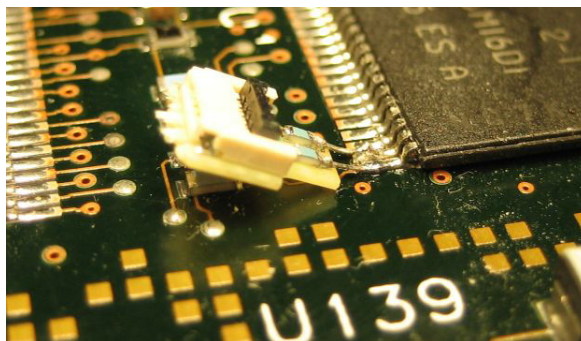

Figure 69 ZIF Tip with ZIF Latch Open

- 6 To make a measurement, connect a ZIF probe head to the ZIF tip. Open the tip's latch, insert the probe head into the ZIF socket, and close the tip's latch with a non-conductive tool. See [Figure 70](#).

NOTE

You may need to support the body of the ZIF tip while closing the latch. Use tweezers or other suitable tool to grab the tip's pc board while the latch is being closed. If the circuit is live, use plastic or non-conductive tweezers.

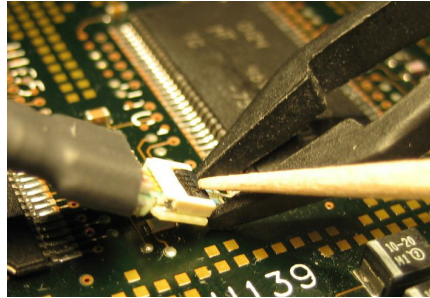

Figure 70 Use a Non-conductive Tool to Close the Latch

Using N2884A Fine-Wire ZIF tips

The procedure required to use these tips is very specific. Please read the instructions carefully as each step alerts you to common problem areas and things you need to be aware of when using this tip.

Step 1. Calibrate the Probe

If you have not recently calibrated the probe or if this is the first time you have ever used this probe amplifier/head/tip combination on the specific oscilloscope channel you plan on using, you should calibrate the probe. The best and easiest way to calibrate this probe setup is to use the standard N5425B ZIF tips rather than the fine wire ZIF tips (since they are very similar in their electrical response characteristics and it is much easier to quickly work with the standard N5425B ZIF tip).

Step 2. Place the ZIF Probe Head (N5425B) into the Positioner Arm

Insert the N5425B ZIF probe head into the positioner arm as shown in [Figure 71](#) on page 91. The fine wire ZIF tip should not be connected to the N5425B ZIF probe head yet.

NOTE

The positioner arm is located inside the case with the five fine wire ZIF tips.

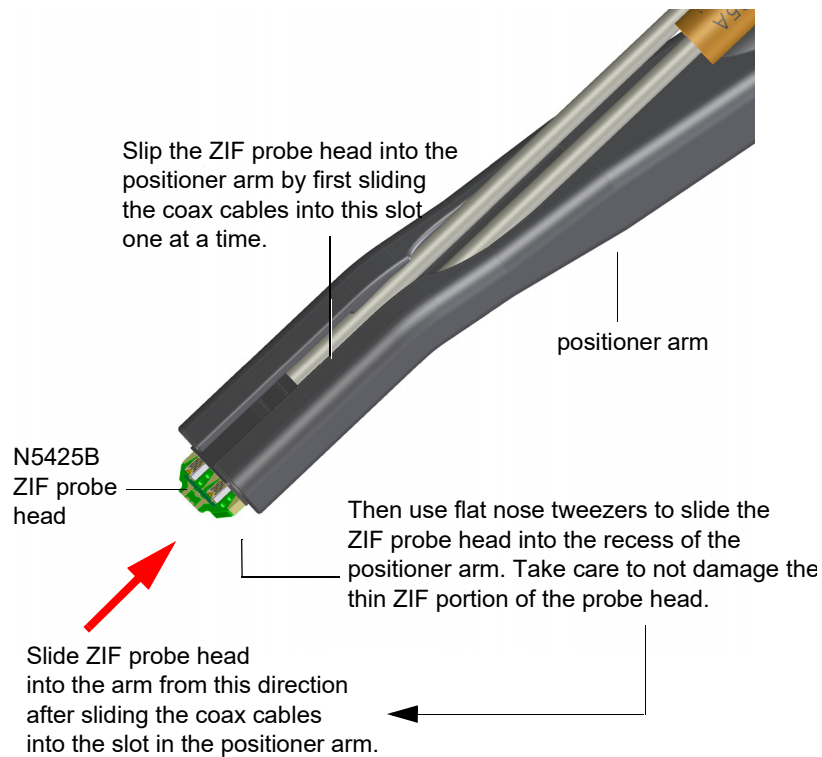

Figure 71 Probe Head and Tip in Positioner

Step 3. Install the Positioner Arm Into the Micropositioner

Secure the positioner arm to a micropositioner using the thumb nut as shown in **Figure 72** on page 92. Keysight recommends using the Wentworth Laboratories micropositioner shown in the picture. You can either order it directly from Wentworth Laboratories (www.wentworthlabs.com) or you can order it from Keysight. If you order it through Keysight, you must order *both* of the following two parts:

- N2884-64702 (Wentworth 2026-90409 PVX 400-M: Manual Linear Manipulator Magnetic Base)
- N2884-64703 (Wentworth 5-00-4711 Short Nose Articulated Short Arm Front)

NOTE

While Keysight recommends using the Wentworth micropositioner, the Fine Wire ZIF positioner arm is compatible with many micropositioners as long as the thumb nut has enough threads to firmly secure the positioner arm.

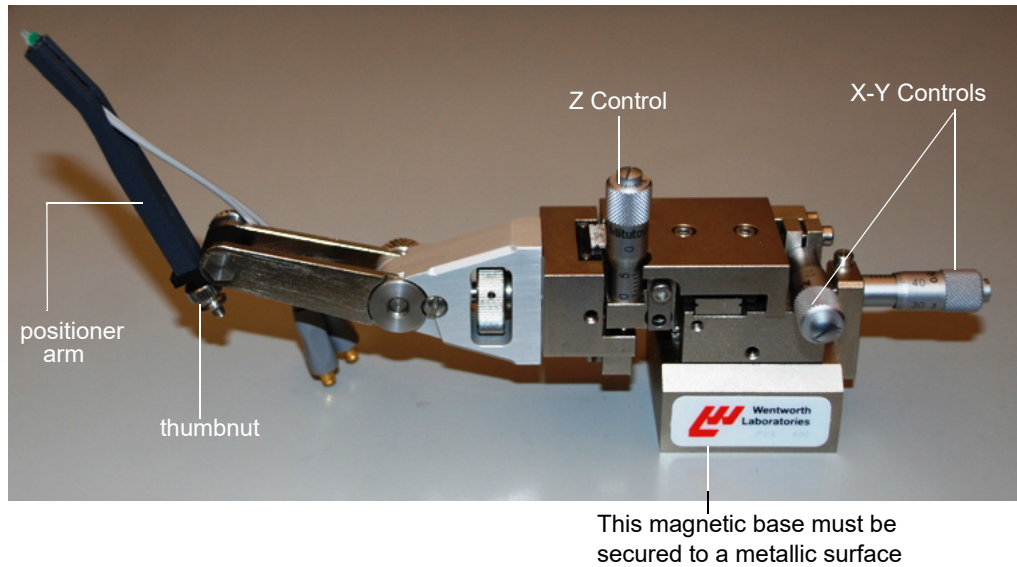

Figure 72 Micropositioner

Step 4. Secure the Micropositioner

When the Fine Wire ZIF tips are attached to the probe head, it is important that the micropositioner is properly secured. It is nose-heavy so if the surface it is on does not allow its magnetic base to secure it, the micropositioner will tip over and damage the ZIF tip. Therefore, you need to place the micropositioner on a metallic surface and ensure that its metallic base is indeed secured so it will not tip over.

Step 5. Attach the Probe Head to Probe Amplifier

Once the Fine Wire ZIF tip is attached to the probe head, it will be extremely important that you are careful with the entire setup (so you do not crush or damage the wires). Therefore, it is usually easiest to connect the probe head to the InfiniiMax probe amplifier before you attach the Fine Wire ZIF tips. You can also connect the probe amplifier to the oscilloscope at this time.

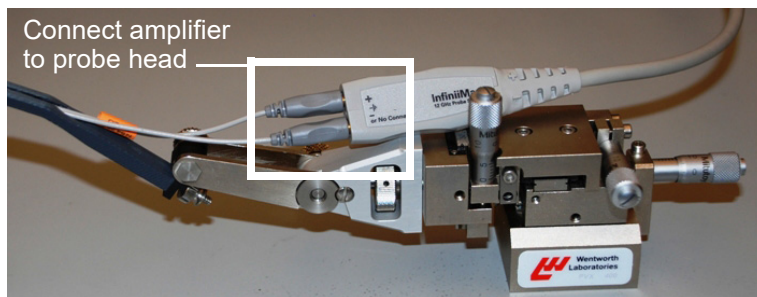

Figure 73 Amplifier Connected to Probe Head

Step 6. Remove a Fine Wire ZIF tip From the Case

To remove a tip from the packaging, grasp the pc board of the tip with flat nose tweezers and lift directly out of the foam. See [Figure 74](#) on page 93.

CAUTION

Do not ever lift the tip out by grasping the wires.

CAUTION

In the case, each of the five Fine Wire ZIF tips has its wires pointing directly up. There is a cutout in the case's lid that allows for these wires to not be bent when the lid is closed. If the wires are not pointed directly upward, they could become damaged when the lid is closed.

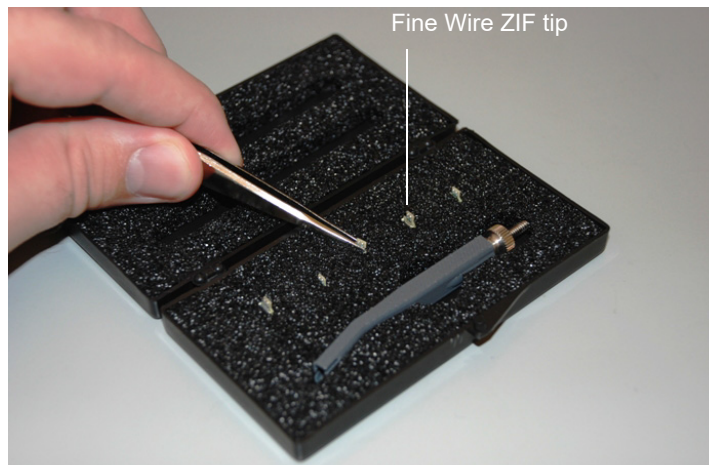

Figure 74 Removing the ZIF Tip

Step 7. Attach the ZIF Probe Head to the Fine Wire ZIF tip

While still grasping the tip with flat nose tweezers, use another set of tweezers to lift the latch to the open position as shown in [Figure 75](#) on page 94). Be careful to not hit the wires. The picture shows the standard ZIF tip and is only meant to highlight the latch's open position (the latch is the same on the standard and Fine Wire ZIF tips).

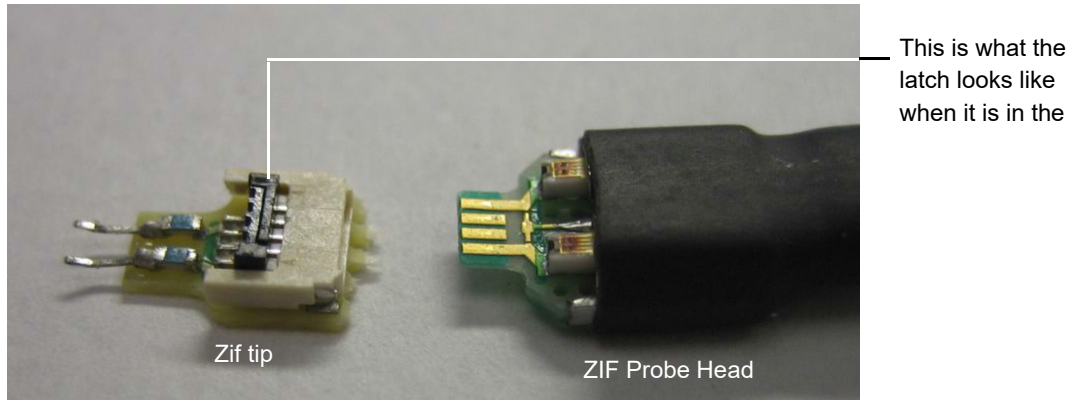

Figure 75 ZIF Tip Latch in Open Position

The probe head should already be attached to the positioner arm (which is secured to the micropositioner). Push the Fine Wire ZIF tip onto the probe head and close the latch to lock them together. The picture below does not show the probe head inside the positioner arm. It is meant to show you what the latch looks like when it is closed.

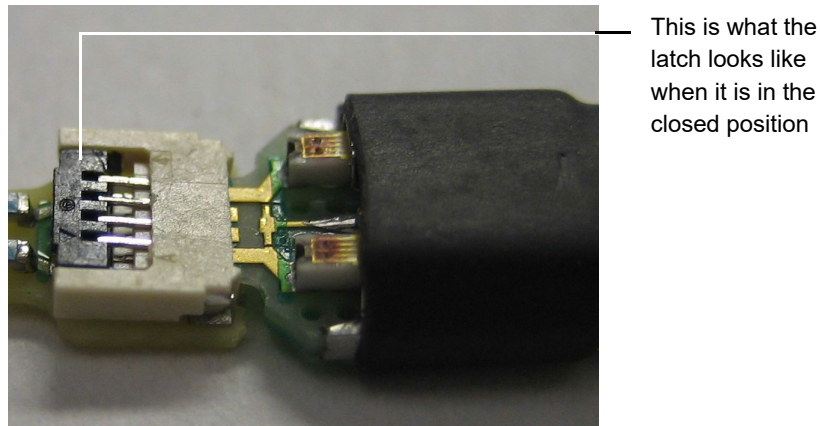

Figure 76 ZIF Tip Latch in Closed Position

Step 8. Attach the Fine Wire ZIF tip Onto the Board

The procedure described below is for probing the underside of ICs and describes a specific use-scenario. There may be other possible ways to use this probe tip. The following steps require a probing station and a high-powered microscope.

NOTE

Do not turn on your DUT until you have landed both wires and confirmed they are not touching, as described below.

In order to prepare the IC for probing, you first need to chemically etch a large trench out of the IC. Within the trench, create at least two wells (target well and ground well) to the targeted metal layers. These wells should be approximately 15 x 15 microns and 10 microns deep. These wells keep the probe tip from slipping

across the surface as they give a place for the wires to anchor. You may need to create many wells depending on the number of targets you want to probe, but you at least need two in order to have a ground well and a target well. A small amount of tungsten should be placed in the bottom of each well. The maximum distance between wells is 600 microns.

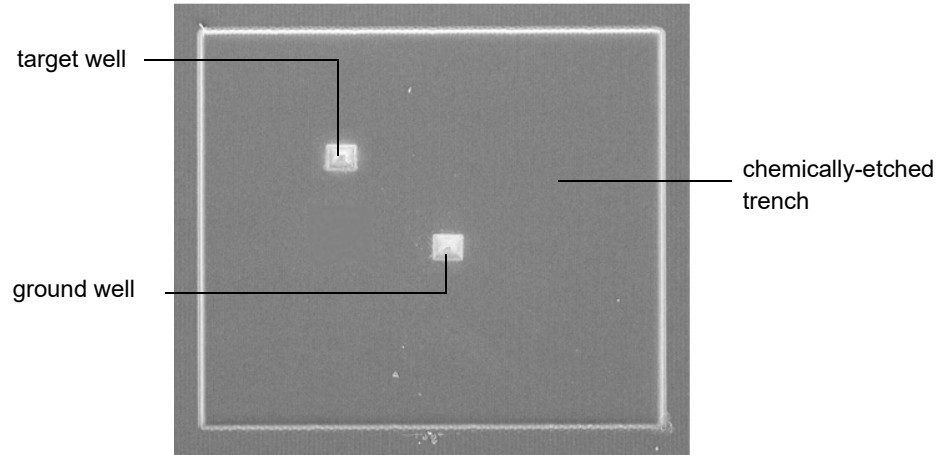

Figure 77 Example of Trench and Two Wells Under Magnification

The two 22 micron wires on the Fine Wire ZIF tip are of different lengths. The longer wire will be driven down first to set the z-axis and then you will land the short wire. It does not matter which wire goes into the ground well and which goes into the target well, but it does matter that the longer wire is set first.

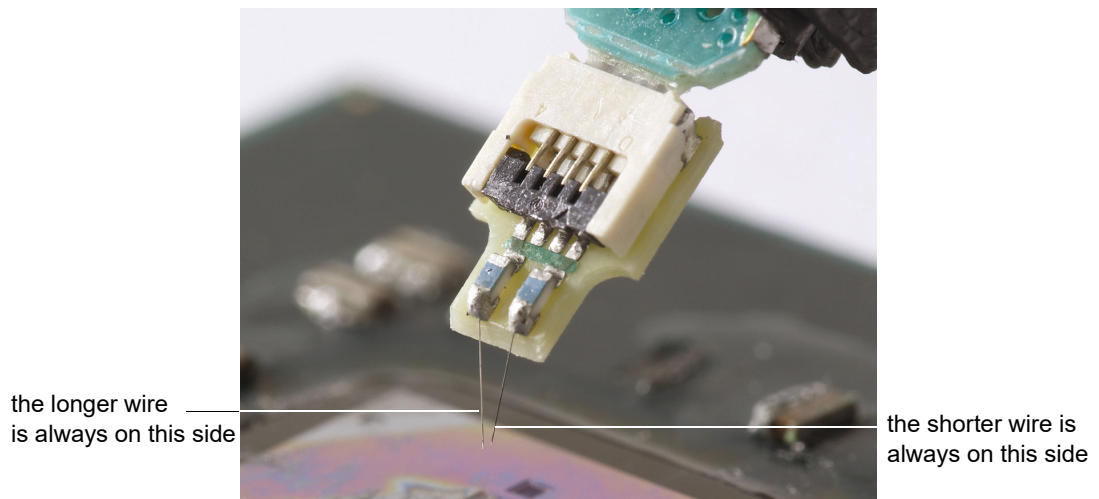
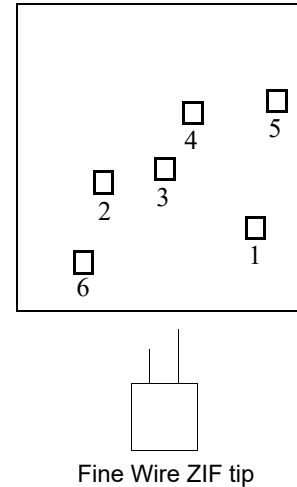
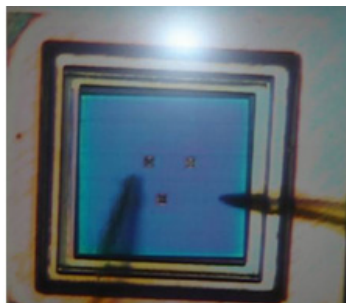

Figure 78 ZIF Tip Wires

It also matters how the two wells are positioned relative to each other. When you land the longer wire first, you will want to land it in a well that is below and to the right (from the perspective of the probing direction) relative to the wells in which you are going to land the short wire. In the diagram above, you could land the longer wire in well 1 and then probe locations 2, 3, and 4 with the short wire. You could not, however, reach well 5 with the short wire (the two wires could cross, shorting them in the process). You also could not reach well 6 with the short wire due to the configurations of the wire (this will cause an upward bend in the wires that could be detrimental to the probing performance). The short wire wells will always need to be up and to the left of the long wire well (from the perspective of the probing direction).



To land both of the wires in the wells, first position the IC under a microscope and move both wires into the region as shown below.



The two pointed shadows shown in the image to the left are the 22 micron wires

Figure 79 Wires in Wells

How easy the rest of these steps are will depend on how powerful of a microscope you have. It may take a while to get adjusted to the process, but with some practice, you should grow in your comfort level.

Move the positioner in the x-y direction until the tip of the long wire is above its well. You may not be able to see the wells and the wires in focus at the same time. If this is the case then first focus on the wells and then slowly move the focus out until you can see just the tips of the wires. You should then be able to move the longer wire tip over the first well.

Next, slowly land the tip in its well (using the z-direction adjustment on the micropositioner). Keep moving down until you see the end of the wire bend slightly. This will ensure that this wire remains stuck while we translate the shorter wire in the next step. Do not land the longer wire too hard or you could damage it. Once you see it flex, stop moving in the z-direction and use the x-y knobs on the micropositioner to wiggle the longer wire slightly. If the wire wiggles, but stays stuck in place on the IC then it was properly placed in the well.

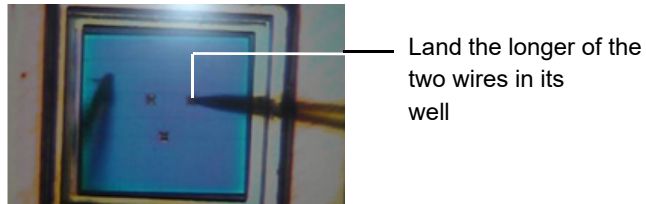

Figure 80 Longer Wire Landed

With the longer wire in place, move the micropositioner in the x-y direction until the shorter wire is over the target well. Then adjust the positioner in the z-direction to land the shorter wire into its well.

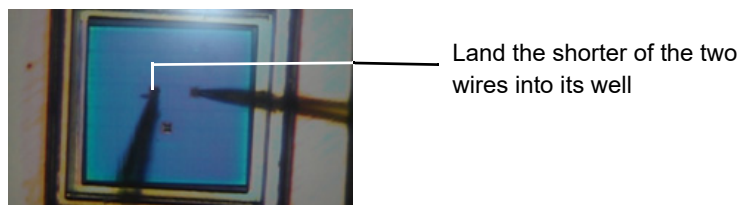

Figure 81 Shorter Wire Landed

The Fine Wire ZIF tip should now be ready to make a differential measurement. Before turning on your DUT, you need to ensure that the two wires are not touching. You should be able to confirm in the microscope that the tips are not overlapping, but these wires do buckle when you land them so they could be touching further up the wires. Decrease the magnification of the microscope until you can see the entire length of both wires and ensure that the wires are not touching.

Step 9. Configuring the Correct Settings on Your Oscilloscope

You should select the N5425B probe head in the probe menu on your oscilloscope when using the Fine Wire ZIF tip. You are now ready to acquire a signal.

N2887A/8A Soft Touch Probe Heads

The N2887A pro series and N2888A half-channel Soft Touch probe heads for logic analyzers eliminate the connector that is traditionally attached to the target board and replaces it with an array of probe pods. The probe heads adapt from the Keysight Pro-Series Soft-touch footprint to the GPO input connectors found on the 1168B/9B and 1130/1/2/4B series probe amplifiers.



Each probe head supports both single-ended and differential footprints and pin-outs. You can connect either a single-ended channel (one connector) into the positive (+) input of the probe amplifier or by plugging the differential complements (2 connectors) into the appropriate positive (+) and negative (-) inputs of the probe amplifier. There exists a 1:1 mapping of Soft touch signal and clock lanes to probe amplifier input GPO connectors. A total of 36 or 18 GPO connectors is necessary to support the possible configurations probe heads.



Figure 82 Soft Touch Head Connected to Probe Amplifier

NOTE

Performance plots. Refer to [“N2887A/N2888A Soft Touch Probe Heads”](#) on page 203.

Retention Modules

You attach the probe heads to the PC board using a retention module, which ensures pin-to-pad alignment and holds the probe in place. A kit of five retention modules is shipped with each probe head. Additional kits can be ordered.

Table 18 Accessories / Replacement Parts

Part Number	Description
E5405-68702	Retention Module Replacement kit for N2887A
E5396-68702	Retention Module Replacement kit for N2888A

Table 18 Accessories / Replacement Parts

Part Number	Description
N2887-60002	De-skew and Performance Verification Fixture

The Keysight specific probe head retention modules do not match any other vendor's connectors. The footprint of the probe heads *do* match other vendors, but the retention modules do not match.

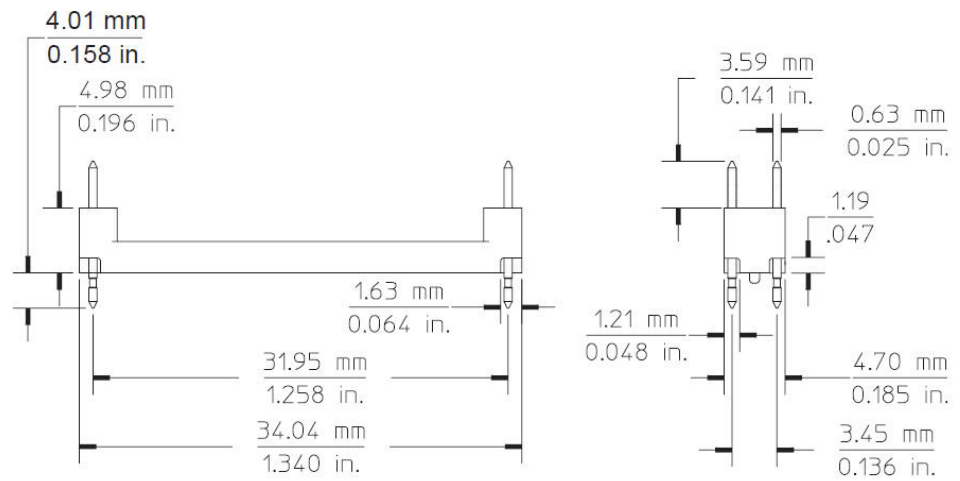

Figure 83 N2887A Retention Module Dimensions

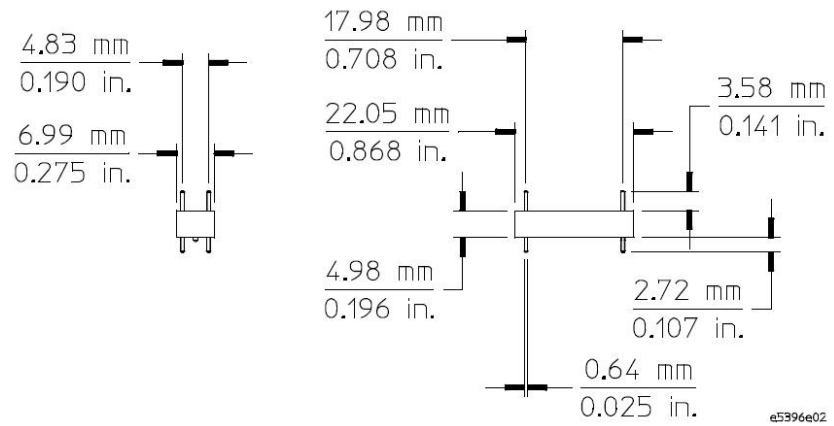

Figure 84 N2888A Retention Module Dimensions

Characteristics

The probe and oscilloscope combination should be warmed up for at least 20 minutes before any testing and the environmental conditions should not exceed the probe's specified limits.

Table 19 N2887A / N2888A Characteristics (Typical)

Item	Characteristic
Bandwidth (-3 dB)	4 GHz
Flatness	± 5%
Single-ended Equivalent Loading Capacitance	< 1 pF
Differential Equivalent Loading Capacitance	< 0.5 pF
Single-ended Input Impedance	25 kΩ
Differential Input Impedance	50 kΩ
Channel to Channel Coupling	< -35 dB to 1.7 GHz, < -20 dB to 4 GHz
Channel to Channel Skew	< 15 ps

N2887A Footprint Dimensions

The view in **Figure 85** on page 101 is looking down onto the footprint on the printed circuit board. The numbers of the following paragraphs are labeled in the diagram:

?Must maintain a solder mask web between pads when traces are routed between the pads on the same layer. Solder mask may not encroach onto the pads within the pad dimension shown.

?Via in pad not allowed on these pads. Via edges may be tangent to pad edges as long as solder mask web between vias and pads is maintained.

?Permissible surface finishes on pad are HASL, immersion silver, or gold over nickel.

?Footprint is compatible with retention model E5405-68702.

?Plated through hole should not be tied to ground plane for thermal relief.

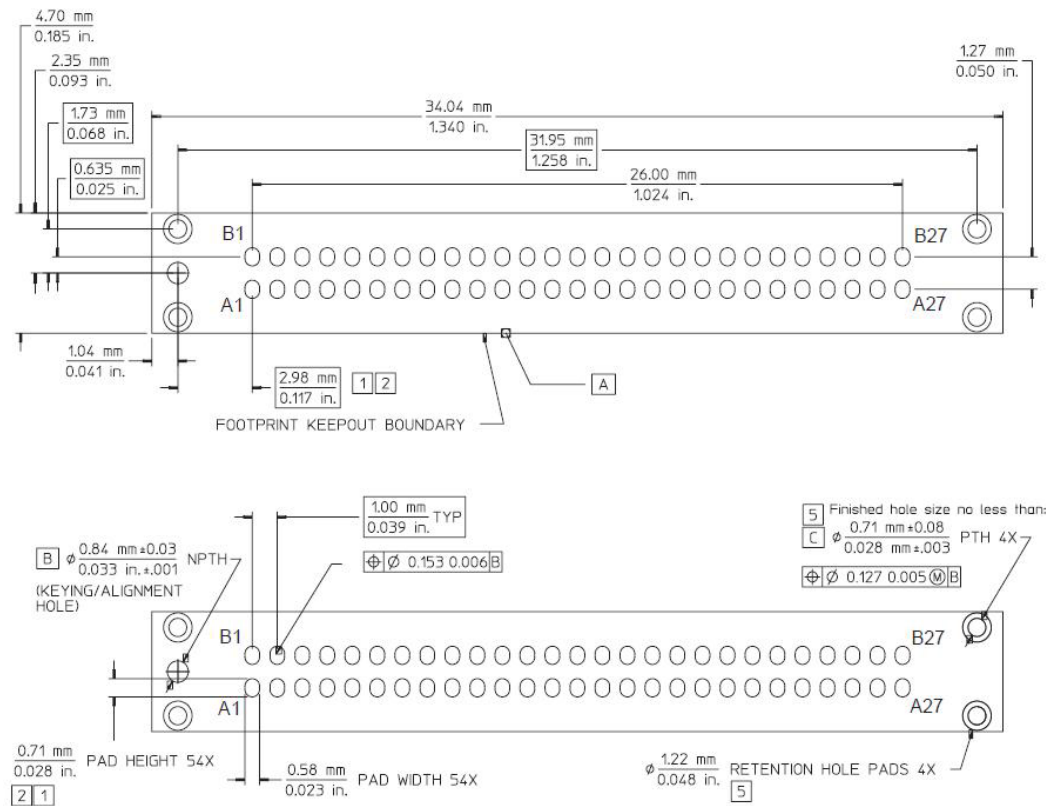

Figure 85 N2887A Footprint Dimensions

N2888A Footprint Dimensions

The view in **Figure 86** on page 102 is looking down onto the footprint on the printed circuit board. The numbers of the following paragraphs are labeled in the diagram:

?Must maintain a solder mask web between pads when traces are routed between the pads on the same layer. Solder mask may not encroach onto the pads within the pad dimension shown.

?Via in pad not allowed on these pads. Via edges may be tangent to pad edges as long as solder mask web between vias and pads is maintained.

?Permissible surface finishes on pad are HASL, immersion silver, or gold over nickel.

?Footprint is compatible with retention model E5396-68702.

?Retention module dimensions are 20.04 mm x 6.99 mm x 4.95 mm tall relative to the top surface of the PCB. Retention pins extend 27.18mm beyond the bottom surface of the RM through the PCB.

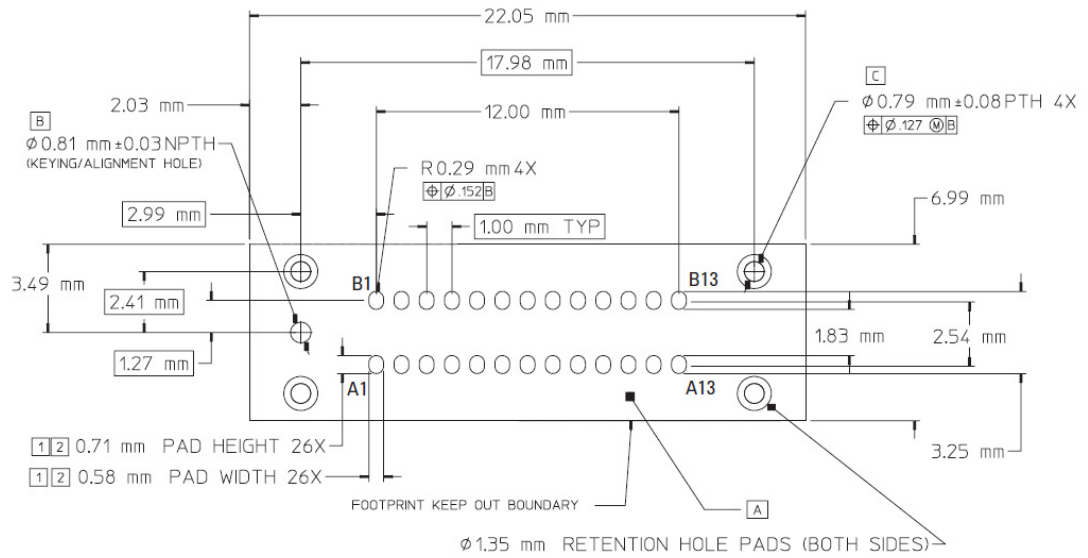

Figure 86 N2888A Footprint Dimensions

Pin-Outs

The N2887A probe head contains 36 single connections and 18 dedicated ground connections as shown in **Figure 87** on page 103. The arrangement of signals (differential, single-ended, clocks) is definable by the user. The signal and ground connections of the N2887A are arranged so they are compatible with the Keysight Pro Series Soft Touch logic probe footprint (E5402A, E5404A, E5405A, and E5406A). When probing an existing Pro Series Soft Touch footprint, refer to the Keysight *E5400-Pro Series Soft Touch Connectorless Probes User's Guide* for specifics about signal and clock locations.

The N2888A half-channel probe head contains 18 single connections and 8 dedicated ground connections. This is shown in **Figure 88** on page 104. You can define the arrangement of signals (differential, single-ended, clocks). The signal and ground connections of the N2887A are arranged so they are compatible with the Keysight Half-Channel Series Soft Touch logic probe footprint (E5396A and E5398A). When probing an existing Half-Channel Series Soft Touch footprint, refer to the Keysight *E5400-Pro Series Soft Touch Connectorless Probes User's Guide* for specifics about signal and clock locations.

N2887A Soft Touch Pro-to-InfiniiMax Adapter Pin-Out

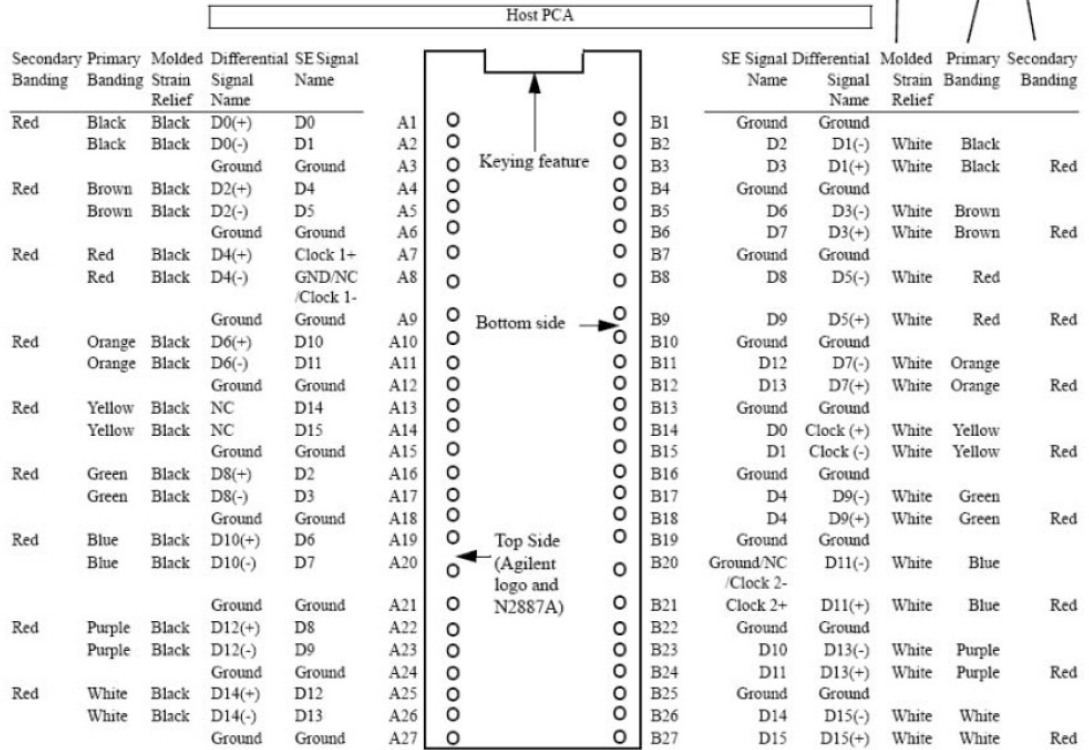

Figure 87 Pin Outs for N2887A Soft Touch Pro

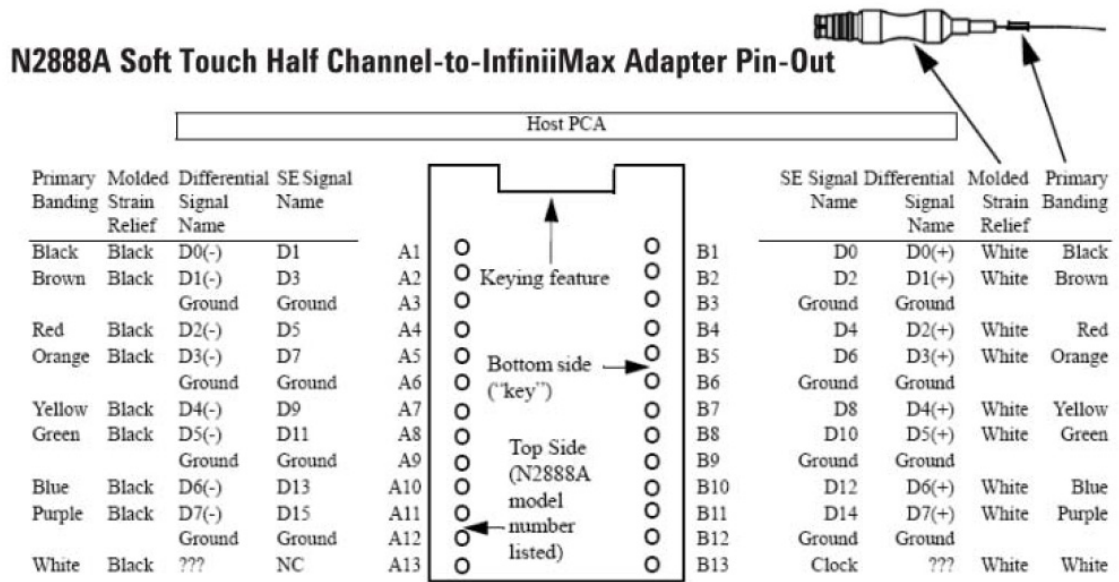

Figure 88 Pin Outs for N2888A Soft Touch Half-Channel

3 Maintaining Probe Heads

MX0100A Micro Probe Heads	106
N5381B/N5382A Probe Heads	109
N5451A Long-Wired ZIF Tips	114
E2677B/9A Solder-In Probe Heads	118

Many probe heads come equipped with replaceable resistor tips. If these resistor tips break, you can replace the tips without having to replace the entire probe head or having to send it back for repair. This chapter shows you how to install or repair the leads on the following probe heads and tips:

- MX0100A micro probe head
- N5381B differential solder-in probe head
- N5382A differential browser probe head
- N5451A long-wired ZIF tips for the N5425B ZIF probe head
- E2677B differential solder-in probe head
- E2679B single-ended solder-in probe head

MX0100A Micro Probe Heads

Use the following procedure to install or replace the lead wires on the MX0100A probe head in the event of damage or break off due to use. Depending on your probing application, you can order either 9 mil or 10 mil wire as listed in the following table. These wires are also included in the Keysight MX0102A Soldering Toolkit (see [page 29](#) for details).

Table 20 Required Wire Types

Wire Type	Wire Diameter	Part Number
Regular Solder Wire (lead free) Requires standard lead-free soldering temperatures (330 °C to 350 °C). (NOTE: This alloy melts at 217 °C.)	.009" diameter	MX0102-21302
Low Temperature Solder Wire (lead free) Requires a low temperature setting on your soldering iron. (NOTE: This alloy melts at 138 °C.)	.010" diameter	MX0102-21303

To Replace an MX0100A Probe Tip Lead Wire

- 1 Secure the tip of the MX0100A probe head on a raised off position from the table. You may use a double-sided foam tape (Keysight part number 0460-3122 included in the MX0102A Soldering Toolkit). Keep the lead wires solder joints off the raised base to facilitate soldering. Cover the entire probe head tip with Kapton tape while ensuring that the lead wires solder joints are fully exposed for soldering.

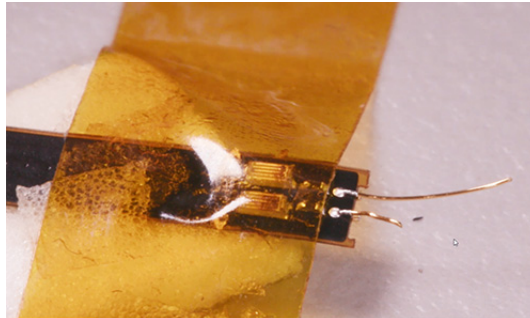

- 2 Remove the damaged lead wire from the via by grabbing it with tweezers and pulling up very gently. Touch the soldering iron to the solder joint just long enough for the lead wire to come free of the probe head tip.

CAUTION

To avoid burning and damage to the probe head, do not keep the soldering iron in contact with the tip any longer than necessary. The solder joint quickly melts and releases the wire.

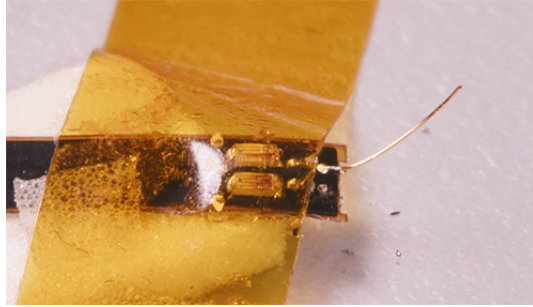

- 3** Position the end of the new lead wire (Keysight part number MX0102-21302 or MX0102-21303 included in the MX0102A Soldering Toolkit) over the via hole. Touch the soldering iron to the side of the hole. When the solder in the hole melts, the lead wire will fall into the hole. Remove soldering iron as soon as the lead wire falls into the hole..

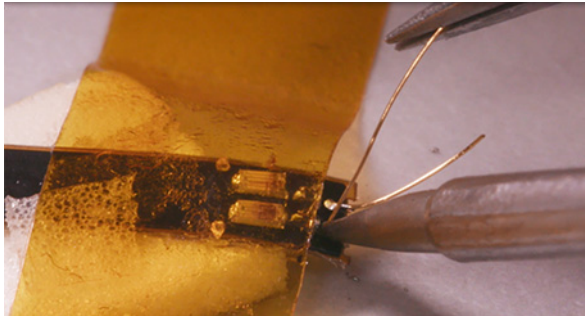

- 4** Apply flux on the solder joint, Then apply a small amount of solder to the tip of the soldering iron. Touch the solder tip (with the solder on it) to the solder joint. Do not dwell on the joint with the solder iron any longer than needed. The solder should flow off the soldering iron tip into the joint. If it does not flow, then sufficient flux may not have been used.

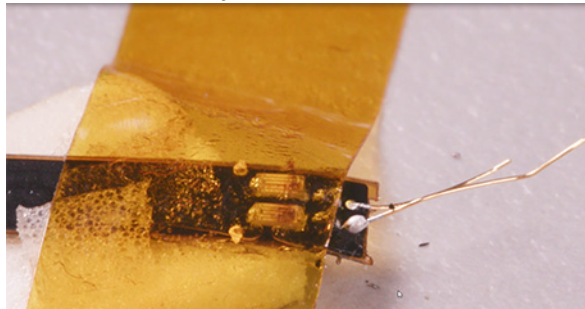

3 Maintaining Probe Heads

- 5 Cut the extra wire off using a cutting tweezer (Keysight part number 8710-2838 included in the MX0102A Soldering Toolkit).

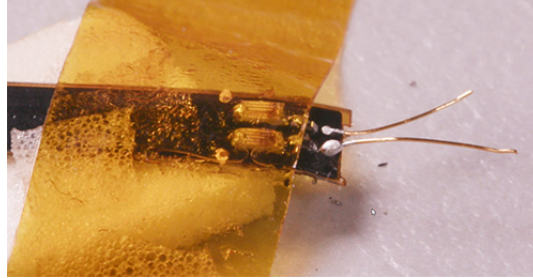

- 6 Remove the Kapton tape.

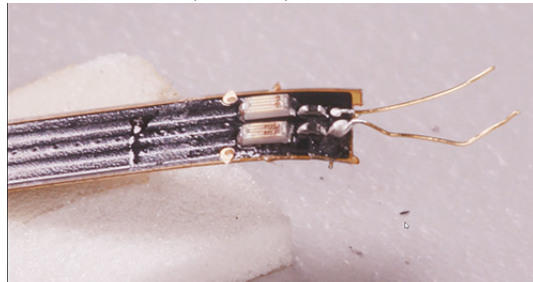

N5381B/N5382A Probe Heads

Use the following procedure to install or replace the wire leads of the N5381B solder-in and N5382A browser probe heads. Use the appropriate wire for each probe head as listed in [Table 21](#).

Table 21 Required Wire Type

Wire Diameter	Part Number	N5381B Probe Head	N5382A Probe Head
0.007 inch (tin-plated nickel wires)	01169-81301	✓	
0.005 inch (tin-plated nickel wires)	01169-21306	✓	
0.005 inch (tin-plated steel wires)	01169-21304		✓

Table 22 Recommended Equipment

Equipment
Vise or clamp for holding tip
Metcal STTC-022 (600 °C) or STTC-122 (700 °C) tip soldering iron or equivalent. The 600 °C tip will help limit burning of the FR4 tip PC board.
0.381 mm (0.015 in) diameter RMA flux standard tin/lead solder wire
Fine stainless steel tweezers
Rosin flux pencil, RMA type (Kester #186 or equivalent)
Flush cutting wire cutters
Magnifier or low power microscope
Keysight supplied trim gauge (01169-23801)

Procedure

- 1 Use the vise or clamp to position the tip an inch or so off the work surface for easy access.

CAUTION

If using a vise, grip the tip on the sides with light force. When tightening the vise, use light force to avoid damaging the solder-in probe head. If using a tweezers clamp, grip the tip either on the sides or at the top and bottom.

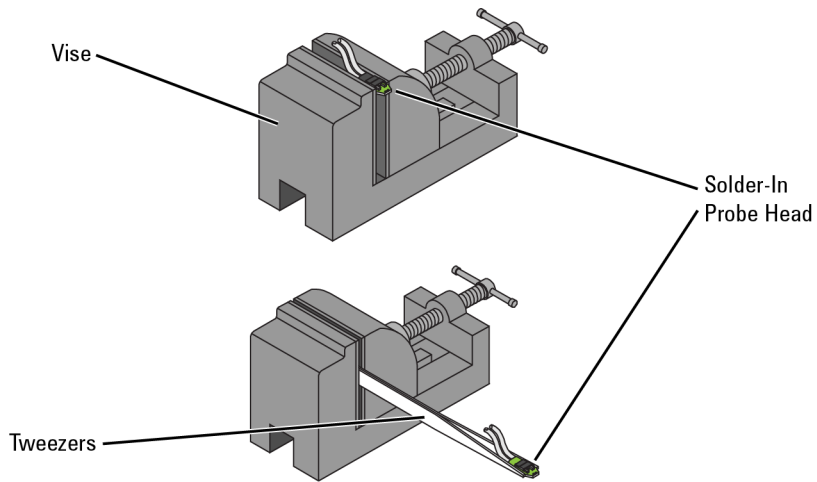

Figure 89 Clamping the Probe Head

- 2 If you need to remove an existing or damaged lead wire, grab the wire lead with tweezers and pull very gently up. Touch the soldering iron to the solder joint just long enough for the wire to come free of the probe head tip.

CAUTION

To avoid burning and damage to the pc board, do not keep the soldering iron in contact with the tip any longer than necessary. The solder joint has very low thermal mass, so the joint quickly melts and releases the wire.

NOTE

Make sure soldering iron tip is free of excess solder.

- 3 In needed, fill the mounting hole with solder in preparation for the new wire.
- 4 Use the flux pencil to coat the solder joint area with flux.
- 5 Cut two wires to a length of about 12.7 mm (0.5 inches).
- 6 Using tweezers, put a 90° bend at the end of the wire. Leave enough wire at the bend such that it will protrude through the board when the wire is installed.

Trim each wire lead 0.89 mm to fit the hole in the pc board as shown in **Figure 90**. Do not trim the lead length until the end of this procedure, where a trim gauge is used.

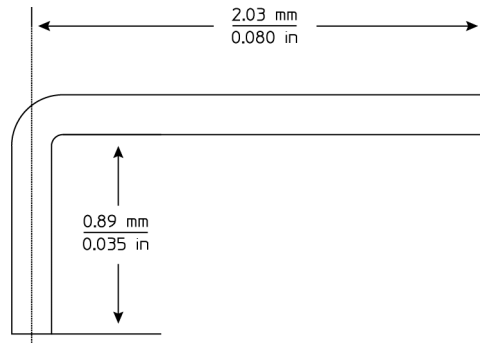

Figure 90 Wire Lead Trim Dimensions

- 7 Holding the wire in one hand and the soldering iron in the other hand, position the end of the wire lead over the solder filled hole. Touch the soldering iron to the side of the hole. When the solder in the hole melts, the wire lead will fall into the hole. Remove soldering iron as soon as lead falls into the hole.

CAUTION

The thermal mass of the joint is very small, so taking extra time with the soldering iron in an attempt to ensure a good joint is not needed.

- 8 Cut the wires that protrude on the bottom side of the probe head board even with the solder pad.

Cut flush with solder pad.

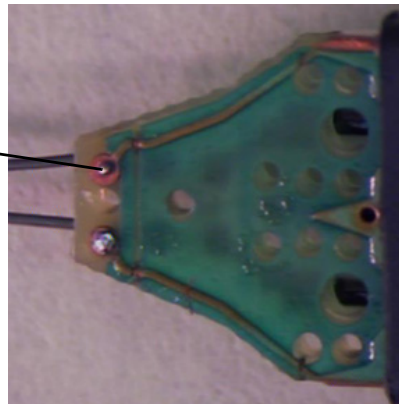

Figure 91 Wire Cut Flush with Solder pad

- 9 Place the wires through the hole in the trim gauge with the probe head perpendicular to the trim gauge.

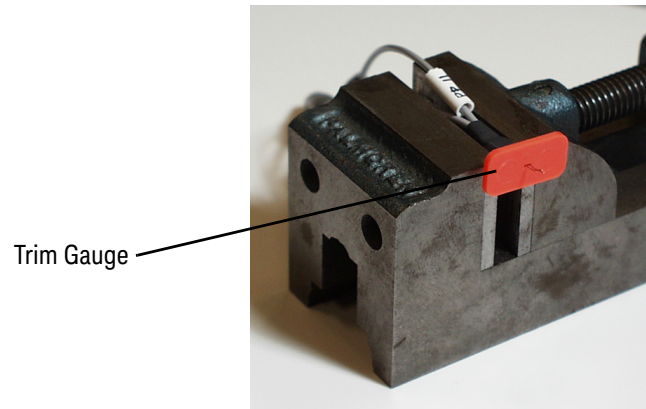

Figure 92 Trim Gauge on Probe Head

10 Cut the wires even with the trim gauge on the side opposite of the probe head.



Figure 93 Cutting Wires Flush with Gauge

11 When replacing wires on the N5382A Browser, bend the wires down at about a 30° angle.

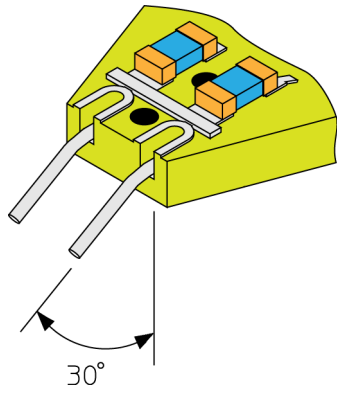

Figure 94 Wires Bent 30°

N5451A Long-Wired ZIF Tips

Use the following procedure to install or replace the long-wired 91 Ω resistor lead. To properly trim and shape the lead, use the Keysight supplied trim template that is included as part of the N5451A packaging.

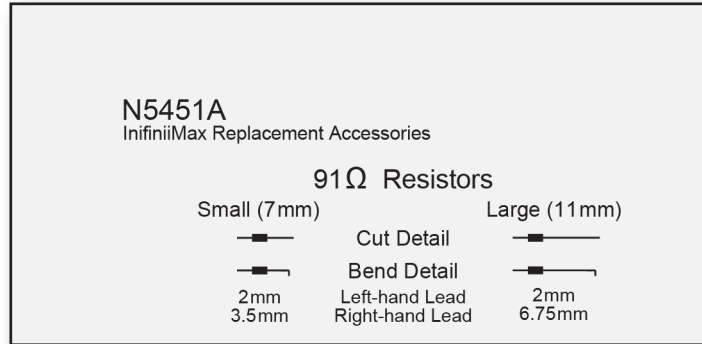

Figure 95 N5451A Trim Template (N5451-94301)

- 1 Using tweezers, place resistor body on the trim template. The trim template contains two lengths: 7 mm and 11 mm. Choose the correct length for your application.

NOTE

Place resistor body over the outline of the resistor on shown the template.

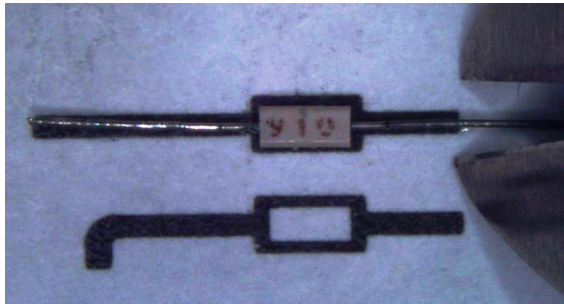

Figure 96 Resistor Placed on the Cut Detail Outline

- 2 Using the X-acto knife, trim the leads even with the trim lines.
- 3 Using another pair of tweezers, bend the right-hand lead 90°.

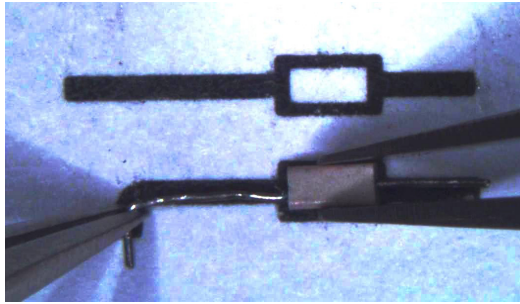

Figure 97 Resistor Placed on the Bend Detail Outline

- 4 If you need to remove an existing or damaged lead wire, grab the wire lead with tweezers and pull very gently up. Touch the soldering iron to the solder joint just long enough for the wire to come free of the probe head tip.

CAUTION

To avoid burning and damage to the PC board, do not keep the soldering iron in contact with the tip any longer than necessary. The solder joint has very low thermal mass, so the joint quickly melts and releases the wire.

NOTE

Make sure soldering iron tip is free of excess solder.

- 5 Use a flux pen to add flux to the circular traces on the board.

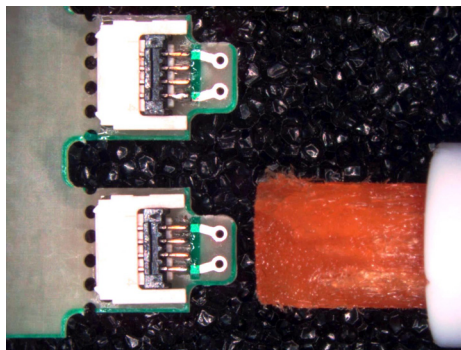

Figure 98 Adding Flux

- 6 Insert one resistor into each through-hole of the circular traces on the board. Align the corresponding resistor faces as shown in [Figure 99](#). Make length adjustments as needed.

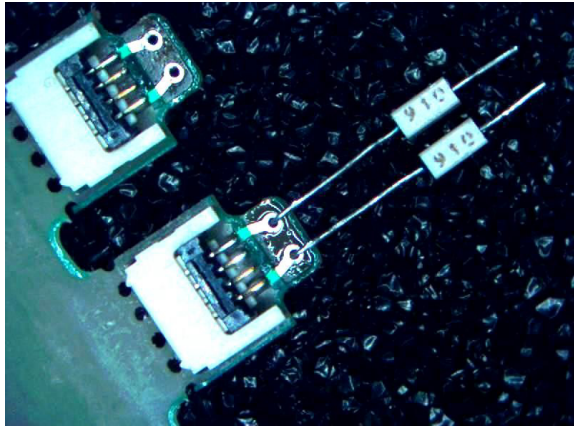

Figure 99 Resistors Inserted into Tip

- 7 Momentarily apply the soldering iron tip to the resistor lead wires as shown in **Figure 100**. Touch the solder to the heated lead wire near the trace hole. A good fillet should form around the lead wire, thus sealing the trace hole. **Figure 101** shows good solder fillets surrounding the resistor lead wires. After soldering, clean board of any excess flux. On the ZIF Tip's opposite side, trim any excess lead wire protruding from the board.

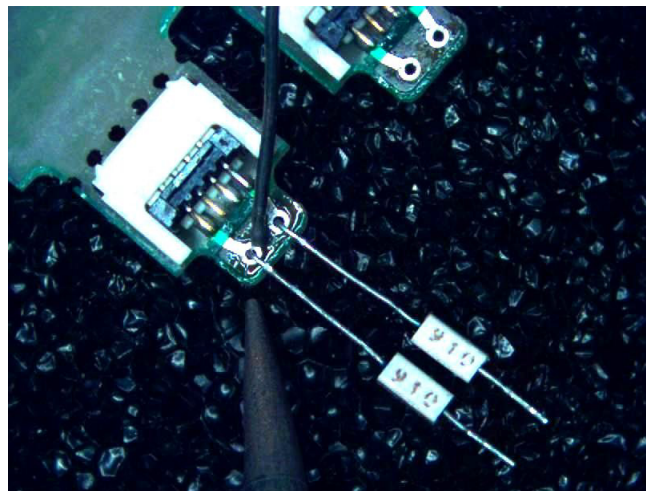

Figure 100 Soldering the Resistors

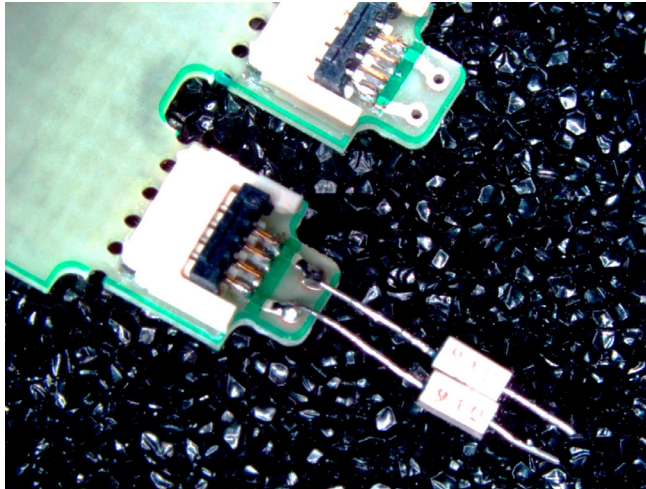

Figure 101 Solder Fillets Surrounding the Resistor Lead Wires

E2677B/9A Solder-In Probe Heads

Use the following procedure to install or replace the wire leads when the mini-axial resistors become damaged or break off due to use.

Table 23 Resistors and Bandwidth

Resistor	For Bandwidth
91Ω	Full
150Ω	Medium
0Ω	Full and Medium

Table 24 Recommended Equipment

Equipment
Vise or clamp for holding tip
Metcal STTC-022 (600 °C) or STTC-122(700 °C) tip soldering iron or equivalent. The 600 °C tip will help limit burning of the FR4 tip PC board.
0.381 mm (0.015 in) diameter RMA flux standard tin/lead solder wire
Fine stainless steel tweezers
Rosin flux pencil, RMA type (Kester #186 or equivalent)
Diagonal cutters
Magnifier or low power microscope
Keysight supplied trim gauge (01131-94311)

Procedure

- 1 Use the vise or clamp to position the tip an inch or so off the work surface for easy access.

CAUTION

If using a vise, grip the tip on the sides with light force. When tightening the vise, use light force to avoid damaging the solder-in probe head. If using a tweezers clamp, grip the tip either on the sides or at the top and bottom.

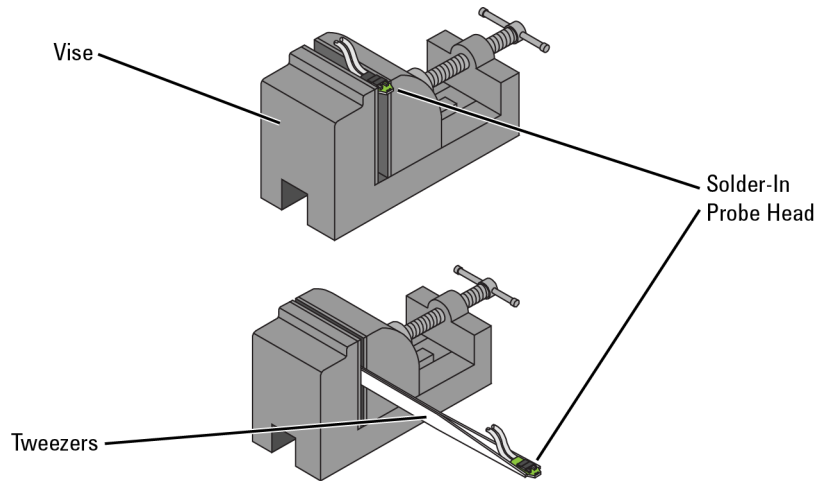

Figure 102 Clamping the Probe Head

- 2 If you need to remove an existing or damaged lead wire, grab each resistor lead or body with tweezers and pull very gently up. Touch the soldering iron to the solder joint just long enough for the resistor to come free of the probe head tip.

CAUTION

To avoid burning and damage to the pc board, do not keep the soldering iron in contact with the tip any longer than necessary. The solder joint has very low thermal mass, so the joint quickly melts and releases the wire.

NOTE

Make sure soldering iron tip is free of excess solder.

- 3 In needed, fill the mounting hole with solder in preparation for the new wire.
- 4 Use the flux pencil to coat the solder joint area with flux.
- 5 Prepare the mini-axial lead resistor for attachment to the head's pc board. The lead to be attached to head's pc board will have a 90° bend to go into through hole in the tip pc board.
- 6 Using tweezers, place the resistor body inside the rectangle of the trim template.

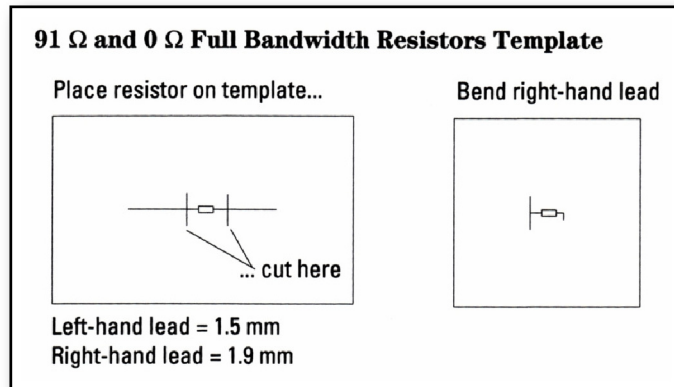

Figure 103 Keysight Supplied Template Included With Resistors

- 7 Using the X-acto knife, trim the leads even with the trim lines.
- 8 Place resistor body inside the rectangle of the bend template.
- 9 Using another pair of tweezers, bend the 1.90 mm or 8.89 mm lead 90° as shown in **Figure 104** and **Figure 105**.

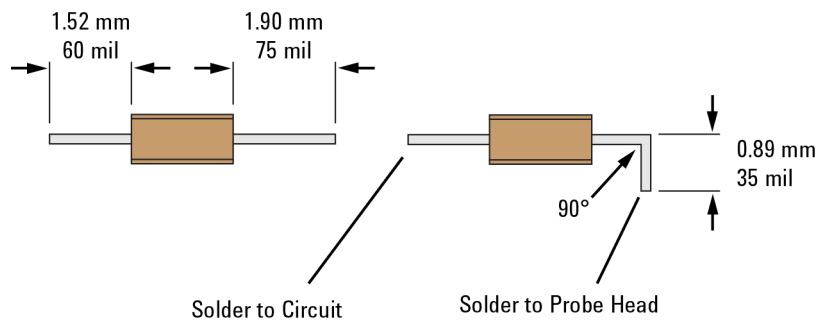

Figure 104 91Ω and 0Ω Combination Resistor Trim Dimensions

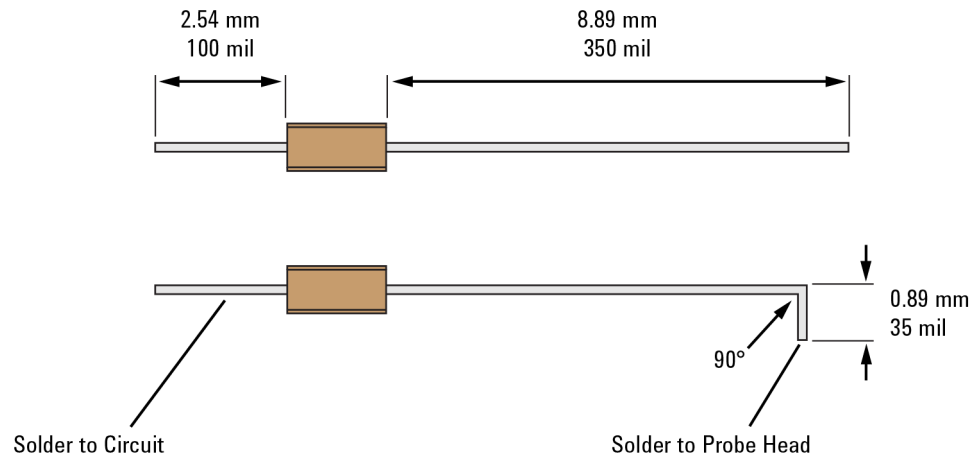

Figure 105 150Ω and 0Ω Combination Resistor Trim Dimensions

NOTE

Do not use the wrong value of resistor at the wrong length.

10 Holding the resistor lead or wire in one hand and soldering iron in the other, position the end of the resistor lead (after the 90° bend) over the solder filled hole. Touch the soldering iron to the side of the hole. When the solder in the hole melts, the resistor lead will fall into the hole. Remove soldering iron as soon as lead falls into the hole.

CAUTION

The thermal mass of the joint is very small, so taking extra time with the soldering iron in an attempt to ensure a good joint is not needed.

NOTE

Make sure the zero ohm resistor is used for ground leads on the E2679B single-ended probe head.

NOTE

For the E2677B differential solder-in probe head, the + and - connection can be determined when the probe head is plugged into the probe amplifier, so which way the tip is soldered in is not important.

3 Maintaining Probe Heads

4 Calibrating Probes

DC Gain and Offset Calibration	124
Calibration for Solder-In and Socketed Probe Heads	125
Calibration for Hand-Held Browser Probe Heads	131
Calibration for N5380A/B SMA Probe Heads	133
N2887A & N2888A Calibration and Deskew Procedure	134

This chapter contains procedures for vertical and skew calibration of the solder-in differential probe head, the differential browser probe head, and the SMA probe head. The procedures can also be applied to all of the different InfiniiMax probe configurations.

DC Gain and Offset Calibration

The Infiniium family of oscilloscopes provides both power and offset control to the 1168B and 1169B active probes through the front-panel connector. Probe offset is changed by adjusting the vertical offset control on the Infiniium oscilloscope. The control should be adjusted to center your signal within the 3.3V peak-to-peak (16V peak-to-peak for slow signals) dynamic range of the probe.

This calibration and deskew should be performed *before* using the probe.

Procedure

- 1 Connect the probe output to the oscilloscope input.
- 2 Calibrate the oscilloscope and probe combination using the Infiniium probe calibration routine.

When the probe has been calibrated, the dc gain, offset zero, and offset gain will be calibrated. The degree of accuracy specified at the probe tip is dependent on the oscilloscope system specifications.

Calibration for Solder-In and Socketed Probe Heads

Calibration of the solder-in and socketed probe heads consists of a vertical calibration and a skew calibration. The vertical calibration should be performed before the skew calibration. Both calibrations should be performed for best probe measurement performance.

NOTE

Before calibrating the probe, verify that the Infiniium oscilloscope has been calibrated recently and that the calibration D temperature is within $\pm 5^{\circ}\text{C}$. If this is not the case, calibrate the oscilloscope before calibrating the probe. This information is found in the Infiniium Calibration dialog box.

Step 1. Connecting the Probe for Calibration

The calibration procedure requires the following parts.

- BNC (male) to SMA (male) adapter
 - Deskew fixture
 - 50Ω SMA terminator
 - It is recommended that an N2787A probe positioner be used to hold the probe in place during the procedure.
- 1 As shown in **Figure 106** on page 126, connect BNC (male) to SMA (male) adapter to the deskew fixture on the connector closest to the yellow pincher.
 - 2 Connect the 50Ω SMA terminator to the connector farthest from the yellow pincher.
 - 3 Connect the BNC side of the deskew fixture to the Aux Out BNC of the Infiniium oscilloscope.
 - 4 Connect the probe to an oscilloscope channel.
 - 5 To minimize the wear and tear on the probe head, the probe head should be placed on a support to relieve the strain on the probe head cables.
 - 6 Push down on the back side of the yellow pincher. Insert the probe head resistor lead underneath the center of the yellow pincher and over the center conductor of the deskew fixture. The negative probe head resistor lead or ground lead must be underneath the yellow pincher and over one of the outside copper conductors (ground) of the deskew fixture. Make sure that the probe head is approximately perpendicular to the deskew fixture.

NOTE

For the socketed probe head, insert two properly trimmed 82Ω resistors into the sockets.

- 7 Release the yellow pincher.

NOTE

To ensure contact, pull up on the back side of the yellow pincher to ensure good contact between resistor leads and the deskew fixture.

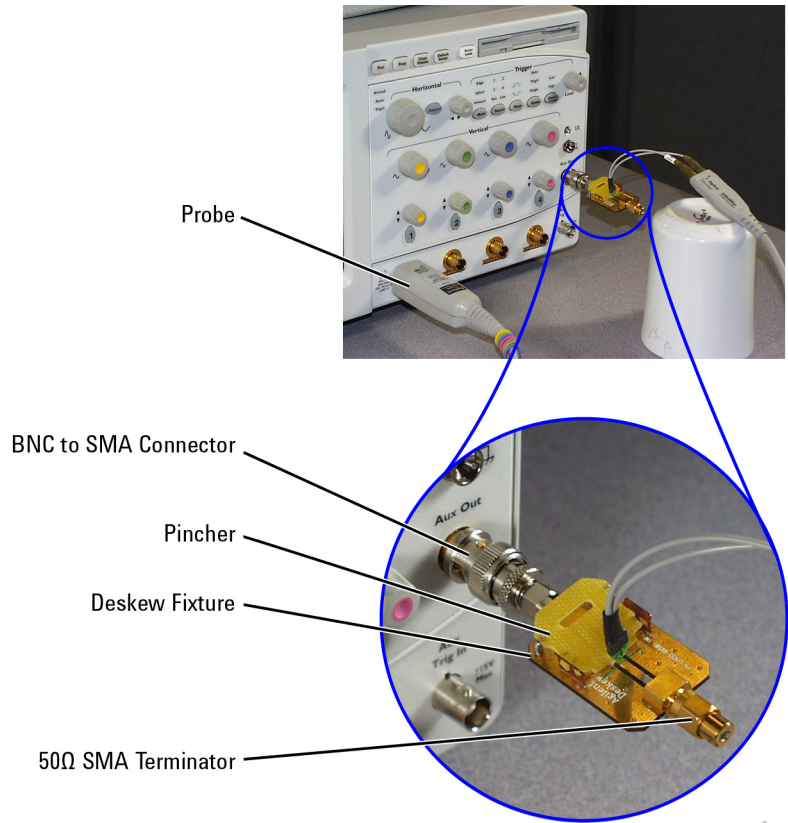

Figure 106 Connecting the Probe and Deskew Fixture

Step 2. Verifying the Connection

- 1 On the oscilloscope, press the autoscale button on the front panel.
- 2 Set the volts per division to 100 mV/div.
- 3 Set the horizontal scale to 1.00 ns/div.
- 4 Set the horizontal position to approximately 3 ns. You should see a waveform similar to that in **Figure 107**.

If you see a waveform similar to that of **Figure 108** on page 127, then you have a bad connection and should check all of your probe connections.

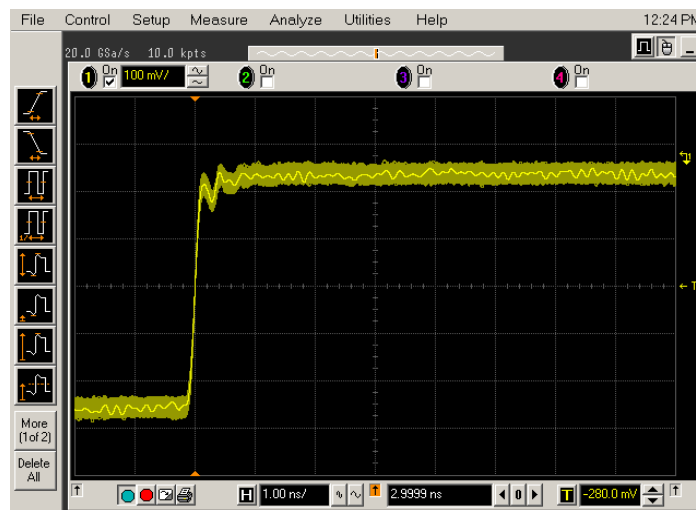

Figure 107 Good Connection

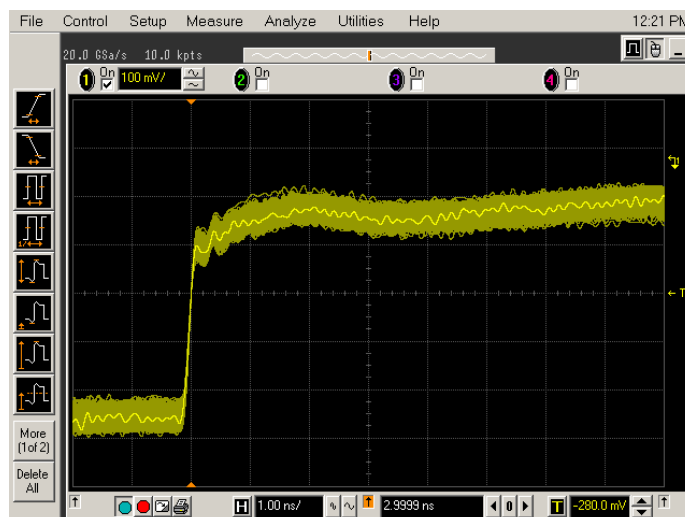

Figure 108 Bad Connection

Step 3. Running the Probe Calibration and Deskew

- 1 On the Infiniium oscilloscope in the Setup menu, select the channel connected to the probe.
- 2 In the Channel Setup dialog box select the Probes... button.
- 3 In the Probe Setup dialog box select the Calibrate Probe... button.
- 4 In the Probe Cal dialog box select the Calibrated Atten/Offset radio button.
- 5 Select the Start Atten/Offset Calibration... button and follow the on-screen instructions for the vertical calibration procedure.
- 6 Once the vertical calibration has successfully completed, select the Calibrated Skew... button.
- 7 Select the Start Skew Calibration... button and follow the on-screen instructions for the skew calibration. At the end of each calibration the oscilloscope will inform you if the calibration was or was not successful.

Verifying the Probe Calibration

If you have just successfully calibrated the probe, it is not necessary to perform this verification. However, if want to verify the probe was properly calibrated, the following procedure will help you verify the calibration.

The calibration procedure requires the following parts.

- BNC (male) to SMA (male) adapter
- SMA (male) to BNC (female) adapter
- BNC (male) to BNC (male) 12 inch cable such as the Keysight 8120-1838 (not included in this kit)
- Keysight 54855-61620 calibration cable (Infiniium oscilloscopes with bandwidths of 6 GHz and greater only)
- Keysight 54855-67604 precision 3.5 mm adapters (Infiniium oscilloscopes with bandwidths of 6 GHz and greater only)
- Deskew fixture

For the following procedure, refer to **Figure 106** on page 126.

- 1 As shown in **Figure 109** on page 129, connect BNC (male) to SMA (male) adapter to the deskew fixture on the connector closest to the yellow pincher.
- 2 Connect the SMA (male) to BNC (female) to the connector farthest from the yellow pincher.
- 3 Connect the BNC (male) to BNC (male) cable to the BNC connector on the deskew fixture to one of the unused oscilloscope channels. For Infiniium oscilloscopes with bandwidths of 6 GHz and greater, use the 54855-61620 calibration cable and the two 54855-67604 precision 3.5 mm adapters.
- 4 Connect the BNC side of the deskew fixture to the Aux Out BNC of the Infiniium oscilloscope.

- 5 Connect the probe to an oscilloscope channel.
- 6 To minimize the wear and tear on the probe head, the probe head should be placed on a support to relieve the strain on the probe head cables.
- 7 Push down on the back side of the yellow pincher. Insert the probe head resistor lead underneath the center of the yellow pincher and over the center conductor of the deskew fixture. The negative probe head resistor lead or ground lead must be underneath the yellow pincher and over one of the outside copper conductors (ground) of the deskew fixture. Make sure that the probe head is approximately perpendicular to the deskew fixture.

NOTE

For the socketed probe head, insert two properly trimmed $82\ \Omega$ resistors into the sockets.

- 8 Release the yellow pincher.

NOTE

To ensure contact, pull up on the back side of the yellow pincher to ensure good contact between resistor leads and the deskew fixture.

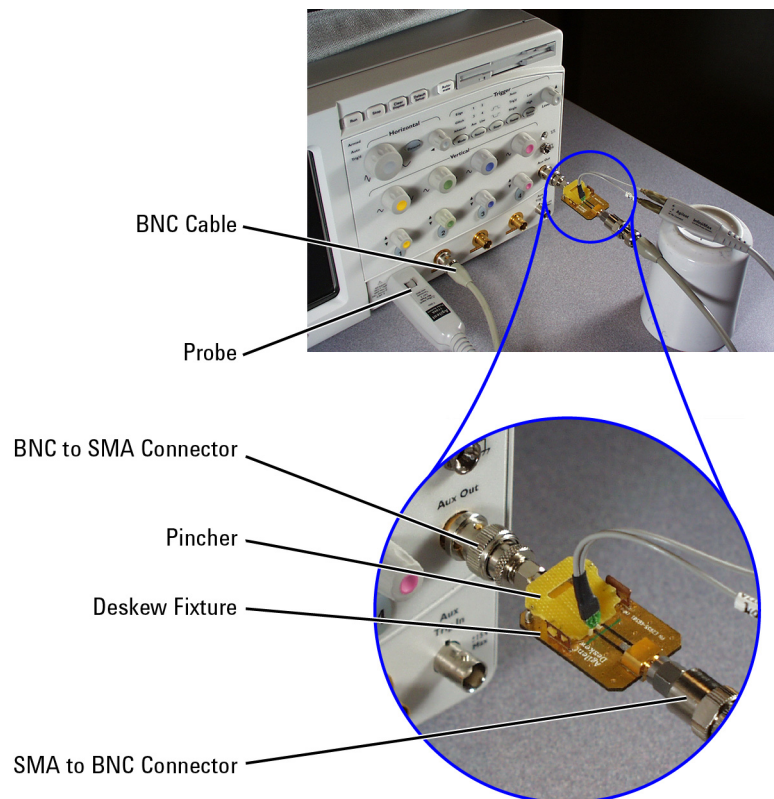

Figure 109 Connecting the Probe

- 9 On the oscilloscope, press the autoscale button on the front panel.
- 10 Select Setup menu and choose the channel connected to the BNC cable from the pull-down menu.

- 11 Select the Probes... button.
- 12 Select the Configure Probe System button.
- 13 Select User Defined Probe from the pull-down menu.
- 14 Select the Calibrate Probe... button.
- 15 Select the Calibrated Skew radio button.
- 16 Once the skew calibration is completed, close all dialog boxes.
- 17 Select the Start Skew Calibration... button and follow the on-screen instructions.
- 18 Set the vertical scale for the displayed channels to 100 mV/div.
- 19 Set the horizontal range to 1.00 ns/div.
- 20 Set the horizontal position to approximately 3 ns.
- 21 Change the vertical position knobs of both channels until the waveforms overlap each other.
- 22 Select the Setup menu choose Acquisition... from the pull-down menu.
- 23 In the Acquisition Setup dialog box enable averaging. When you close the dialog box, you should see waveforms similar to that in **Figure 110**.

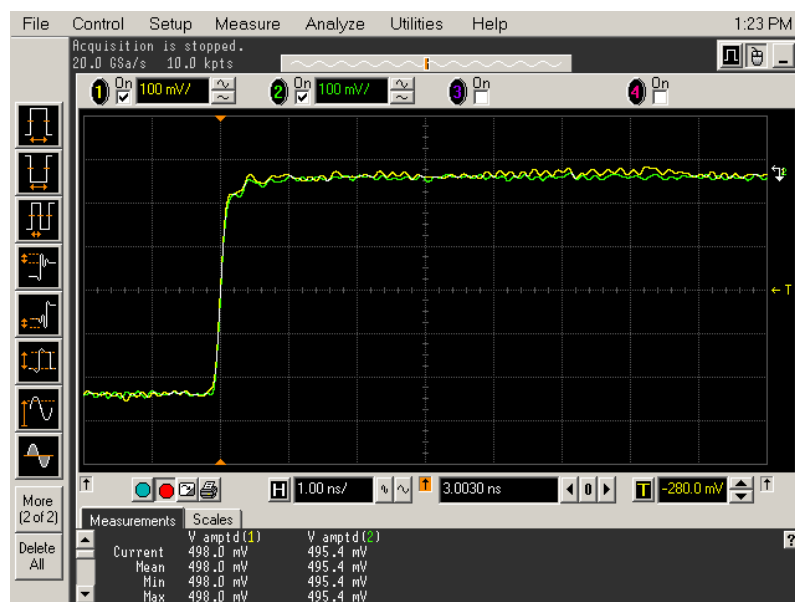

Figure 110 Overlapping Waveforms

Calibration for Hand-Held Browser Probe Heads

Calibration of the hand-held browser probe heads consists of a vertical calibration and a skew calibration. The vertical calibration should be performed before the skew calibration. Both calibrations should be performed for best probe measurement performance.

NOTE

Before calibrating the probe, verify that the Infiniium oscilloscope has been calibrated recently and that the calibration Δ temperature is within ± 5 °C. If this is not the case, calibrate the oscilloscope before calibrating the probe. This information is found in Infiniium Calibration dialog box.

Calibration Setup

The calibration procedure requires the following parts.

- BNC (male) to SMA (male) adapter
 - Deskew fixture
 - 50 Ω SMA terminator
- 1 As shown in **Figure 111** on page 132, connect BNC (male) to SMA (male) adapter to the deskew fixture on the connector closest to the yellow pincher.
 - 2 Connect the 50 Ω SMA terminator to the connector farthest from the yellow pincher.
 - 3 Connect the BNC side of the deskew fixture to the Aux Out of the Infiniium oscilloscope.
 - 4 Connect the probe to an oscilloscope channel.
 - 5 Place the positive resistor tip of the browser on the center conductor of the deskew fixture between the green line and front end of the yellow pincher. The negative resistor tip or ground pin of the browser must be on either of the two outside conductors (ground) of the deskew fixture.
 - 6 On the Infiniium oscilloscope in the Setup menu, select the channel connected to the probe.
 - 7 In the Channel Setup dialog box select the Probes... button.
 - 8 In the Probe Setup dialog box select the Calibrate Probe... button.
 - 9 In the Probe Cal dialog box select the Calibrated Atten/Offset radio button.
 - 10 Select the Start Atten/Offset Calibration... button and follow the on-screen instructions for the vertical calibration procedure.
 - 11 Once the vertical calibration has successfully completed, select the Calibrated Skew... button.
 - 12 Select the Start Skew Calibration... button and follow the on-screen instructions for the skew calibration.

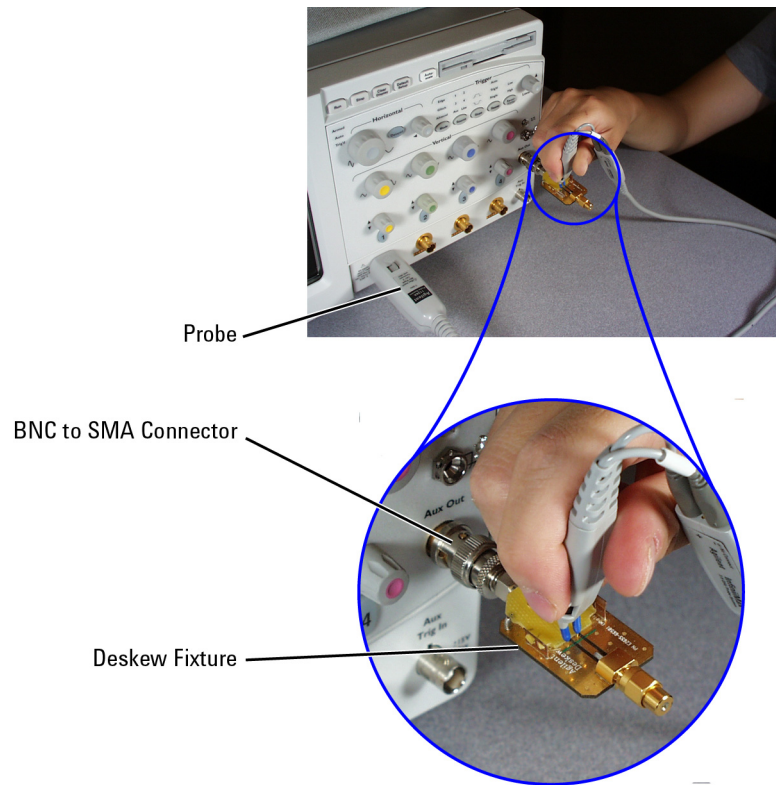

Figure 111 Placing the Probe on the Fixture

Calibration for N5380A/B SMA Probe Heads

Equipment Required

This calibration procedure requires the following equipment.

- SMA to BNC (male) adapter
- E2655C Deskew Fixture, or SMA (female) to SMA (female) adapter
- N5380A/B SMA Probe Head
- Shorting Cap
- InfiniiMax Probe Amplifier

Calibration Setup

- 1 Connect the SMA to BNC adapter to one of the SMA connectors of the deskew fixture (or the SMA (female) to SMA (female) adapter if you are using it instead).
- 2 Connect the shorting cap to the center SMA connector of the SMA probe head.
- 3 Connect the other end of the deskew fixture (or SMA to SMA adapter if you are using it instead) to one of the SMA connectors of the N5380A/B SMA probe head.
- 4 Connect the BNC connector of the SMA to BNC adapter to the Aux Out on the Infiniium oscilloscope.
- 5 Connect the InfiniiMax probe amplifier to the GPO (SMP) connector of the N5380A/B SMA probe head. Be sure to connect the positive (+) side to the side connected to the Aux Out of the oscilloscope.
- 6 Start the calibration by selecting the Atten/Offset **Cal...** button in the Probe Configuration dialog box (**Setup > Probe Configuration...**)



Figure 112 Connecting the SMA Probe Head and Deskew Fixture

N2887A & N2888A Calibration and Deskew Procedure

The N2887-60002 Calibration/Deskew kit contains the following parts. The last three items in the list are required for the calibration procedure.

- BNC (male) to SMA (male) adapter
- SMA (male) to BNC (female) adapter
- SMA (male) to SMA (male) adapter
- 50 Ω SMA terminator
- Deskew Fixture



Figure 113 N2887-60002 Calibration/Deskew kit

Calibration of the N2887A/N2888A probe heads consists of a vertical calibration and a skew calibration. The vertical calibration should be performed before the skew calibration. Both calibrations should be performed for best probe measurement performance.

NOTE

Before calibrating the probe, verify that the Infiniium oscilloscope has been recently calibrated and that the calibration change in temperature is ± 5 °C. If this is not the case, calibrate the oscilloscope before calibrating the probe. This information is found in the Infiniium Calibration dialog box.

Connecting the Probe for Calibration

- 1 Connect the BNC (male) to SMA (male) adapter to the deskew fixture on the connector (it does not matter which connector you use).
- 2 Connect the 50 Ω SMA terminator to the other connector on the deskew fixture.
- 3 Connect the BNC side of the deskew fixture to the Cal Out BNC on the Infiniium oscilloscope.

- 4 Connect either the N2887A or N2888A probe head to the deskew fixture as shown in the **Figure 114** on the following page (note: use the appropriate connector for either the N2887A or N2888A model as shown on the following page).

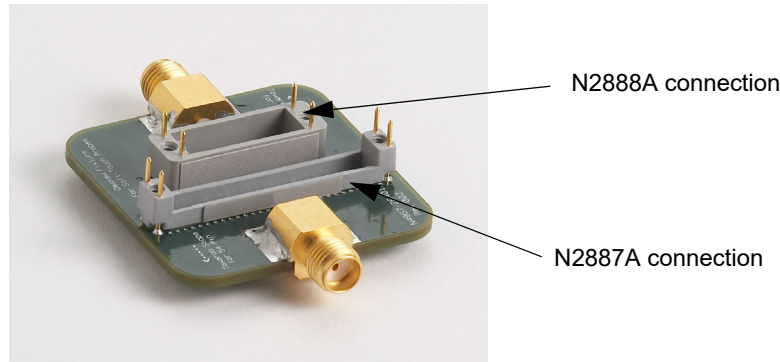

Figure 114 Deskew Fixture with N2887/8A Connections

- 5 Connect the InfiniiMax probe amplifier to an oscilloscope channel.
- 6 Connect one of the leads from the probe head to the positive terminal on the InfiniiMax probe amplifier. The lead you will use depends on whether you are using the N2887A or N2888A probe head:
 - For the N2887A probe head, use the connection with the black molded strain relief and yellow primary banding.
 - For the N2888A probe head, use the connection with the white molded strain relief and the yellow primary banding.



NOTE

To minimize the wear and tear on the probe head, the probe head should be placed on a support to relieve the strain on the probe head cables.

NOTE

Please note that you are only deskewing one channel on the InfiniiMax Soft Touch probe head in this procedure. The other channels are nominally identical (< 15 ps). The major source of skew when using multiple InfiniiMax amplifiers with a single InfiniiMax Soft Touch probe head is the variations from one amplifier to another. This skew can be addressed by repeating the procedure outlined above for each InfiniiMax amplifier that will be used.

NOTE

Once you have the probe head connected correctly, perform a normal probe calibration as described in the InfiniiMax help system available on the oscilloscope.

5 Characteristics and Specifications

General	138
InfiniiMax II Series with N5380B SMA Probe Head	141
Environmental	143
Probe Amplifier Dimensions	144
Probe Heads Dimensions	145

All characteristics are the typical performance values of the InfiniiMax probes using the probe amplifier and N5381B differential solder-in probe head and are not warranted.

General



This symbol indicates the Environmental Protection Use Period (EPUP) for the product's toxic substances for the China RoHS requirements.



The CE mark is a registered trademark of the European Community. ISM GRP 1-A denotes the instrument is an Industrial Scientific and Medical Group 1 Class A product. ICES/NMB-001 indicates product compliance with the Canadian Interference-Causing Equipment Standard.

Measurement Category Definitions

Mains Isolated: Other circuits that are not connected directly to mains.

CAT II: Circuits connected to mains socket outlets and similar points in the mains installation.

CAT III: Mains distribution parts of the building.

CAT IV: Source of the mains installation in the building.

WARNING

Do not use the probe for measurements within measurement categories II, III and IV.

WEEE Compliance

This product complies with the WEEE Directive (2002/96/EC) marking requirements. The affixed label indicates that you must not discard this electrical/electronic product in domestic household waste.

Product Category: With reference to the equipment types in the WEEE Directive Annex I, this product is classed as a "Monitoring and Control Instrumentation" product.



NOTE

Do not dispose in domestic household waste. To return unwanted products, contact your local Keysight office, or see www.keysight.com for more information.

Table 25 Warranted Specifications

Item	Specification
Bandwidth (-3 dB)	
1168B	10 GHz
1169B	12 GHz (13 GHz typical)
Input Resistance	
Differential Mode Resistance	50 k Ω \pm 2%
Single-Ended Mode Resistance Each Side to Ground	25 k Ω \pm 2%

Table 26 Characteristics (Typical Performance) (Sheet 1 of 2)

Item	Characteristic	Description
Bandwidth (-3 dB)		
1168B with DSO/DSA90804A	8 GHz	
1168B with DS081004A	10 GHz	
1168B with DSO/DSA91204A	12 GHz	
1169B with DSO/DSA91304A	13 GHz	
Rise and Fall Time (10% to 90%)		
1168B	48 ps	
1169B	40 ps	
Rise and Fall Time (20% to 80%)		
1168B	34 ps	
1169B	28 ps	
Rise and Fall Time (10% to 90%) (Phase corrected on DS090000A Series Oscilloscope)		
1168B	42 ps	
1169B	36 ps	
Rise and Fall Time (20% to 80%) (Phase corrected on DS090000A Series Oscilloscope)		
1168B	30 ps	
1169B	25 ps	
Input Capacitance		
Cm	0.09 pF	Model for input C is Cm is between tips and Cg is to ground for each tip
Cg	0.26 pF	
Cdiff	0.21 pF	Differential mode capacitance (capacitance when probing a differential signal = Cm + Cg/2)

Table 26 Characteristics (Typical Performance) (Sheet 2 of 2)

Item	Characteristic	Description
Cse	0.35 pF	Single-ended mode capacitance (capacitance when probing a single-ended signal = $C_m + C_g$)
Input Dynamic Range	$\pm 1.65V$	Differential or single-ended
Input Common Mode Range	$\pm 6.75V$ $\pm 1.25V$ peak-to-peak	dc to 100 Hz > 100 Hz to probe bandwidth (<i>should not exceed the maximum slew rate</i>)
Maximum Signal Slew Rate (SR_{max}) [*]	25 V/ns 40 V/ns	When probing a single-ended signal When probing a differential signal
DC Attenuation	@ 3.45:1 [†]	
Zero Offset Error Referred to Input	< 2 mV x DC attenuation ^b	
Offset Range	$\pm 16.0V$	When probing single-ended
Offset Accuracy	< 3% ^b	
Noise referred to Input	2.5 mVrms	
Propagation Delay	@ 6 ns	
Maximum Input Voltage	30V Peak, (mains isolated)	Maximum non-destructive voltage on each input ground
ESD Tolerance	> 8 kV from 150 pF, 330 Ω HBM	

* SR_{max} of a sine wave = $Amp \times 2 \times \pi \times frequency$ or SR_{max} of a step @ $Amp \times 0.6 / trise$ (20 to 80%). For more information, refer to **Table 2** on page 19.

† When calibrated on the oscilloscope, these characteristics are determined by the oscilloscope characteristics.

InfiniiMax II Series with N5380B SMA Probe Head

All characteristics are the typical performance values of the InfiniiMax probes using the probe amplifier and N5380B SMA probe head and are not warranted.

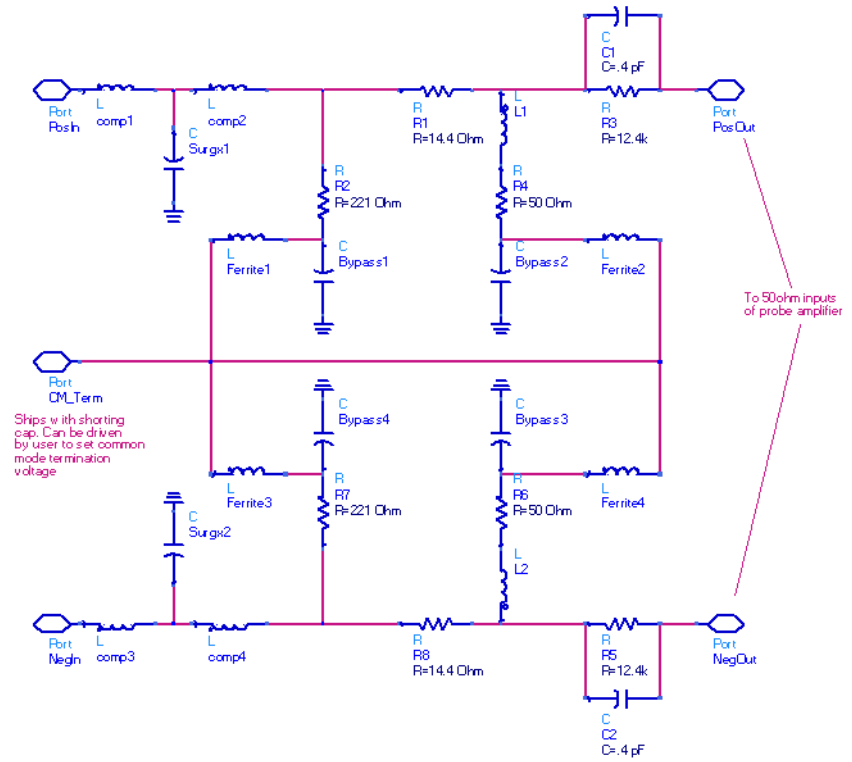

Figure 115 N5380B SMA Probe Head Simplified Schematic

Table 27 Characteristics

Item	1169B	1168B
Bandwidth	12GHz	10GHz
Probe only rise and fall times	27.5 ps (20% to 80%) 40 ps (10% to 90%)	27.5 ps (20% to 80%) 40 ps (10% to 90%)
System rise and fall times*		
	With DSO/DSA91304A: 23 ps (20% to 80%) 33 ps (10% to 90%)	With DS081004A: 30 ps (20% to 80%) 42 ps (10% to 90%)
	With DSO/DSA91204A 25 ps (20% to 80%) 36 ps (10% to 90%)	With DSO/DSA90804A: 38 ps (20% to 80%) 54 ps (10% to 90%)
System bandwidth (-3 dB)		
	With DSO/DSA91304A: 12.5 GHz	With DS081004A: 10 GHz
	With DSO/DSA91204A: 12 GHz	With DSO/DSA90804A: 8 GHz
Input Resistance	50Ω ± 2%	50Ω ± 2%
Input Dynamic Range	± 1.1V Differential or Single-Ended	± 1.1V Differential or Single-Ended
Maximum Input, (Vin - Vcm_term) †	2.28 Vrms	2.28 Vrms
Input Common Mode Range	± (4.3 V - Vcm_term x 0.29) ± 0.8 V	dc to 100 Hz > 100 Hz
Maximum Signal Slew Rate ‡ (SMA attenuator can extend range.)**	25 V/ns	Differential Input
DC Attenuation	~2.2:1 (-6.9 dB)	
Zero Offset Error Referred to Input	< 2 mV	
Noise Referred to Input	1.6 mVrms (~ 14 nV/rtHz using noise BW of 12.5 GHz)	
Propagation Delay	~6.15 ns	

* Decreased rise and fall times mainly due to phase correction performed in the DS080000 series, not due to DSP boosting (except in DS081304A).

† Vcm_term is the voltage supplied to the common mode termination port of the N5380B. If a shorting cap is in place, this voltage is zero.

‡ SR max of sine wave = amplitude x 2 x π x frequency OR SR max of a step approximately equal to the amplitude x 0.6/trise (20-80%).

**Use of X:1 SMA coaxial attenuators in front of SMA probe head will: 1) Increase by X the max input signal slew rate, dynamic range, offset range, common mode range, noise referred to the input, DC attenuation, and maximum input voltage, 2) Most likely improve return loss or input TDR if attenuators are high quality, and 3) Not affect bandwidth and rise time if attenuators are high quality.

Environmental

The following general characteristics apply to the active probe.

Table 28 Environmental Characteristics

Environmental Conditions	Operating	Non-Operating
Temperature	5 °C to +40 °C	-40 °C to +70 °C
Humidity	up to 95% relative humidity (non-condensing) at +40 °C	up to 90% relative humidity at +65 °C
Altitude	Up to 4,600 meters	Up to 15,300 meters
Power Requirements	Voltages supplied by Keysight oscilloscope AutoProbe Interface.	
Weight	approximately 0.69 kg	
Dimensions	Refer to "Probe Amplifier Dimensions" on page 144.	
Pollution degree 2	Normally only non-conductive pollution occurs. Occasionally, however, a temporary conductivity caused by condensation must be expected.	
Use	Indoor Only	

Probe Amplifier Dimensions

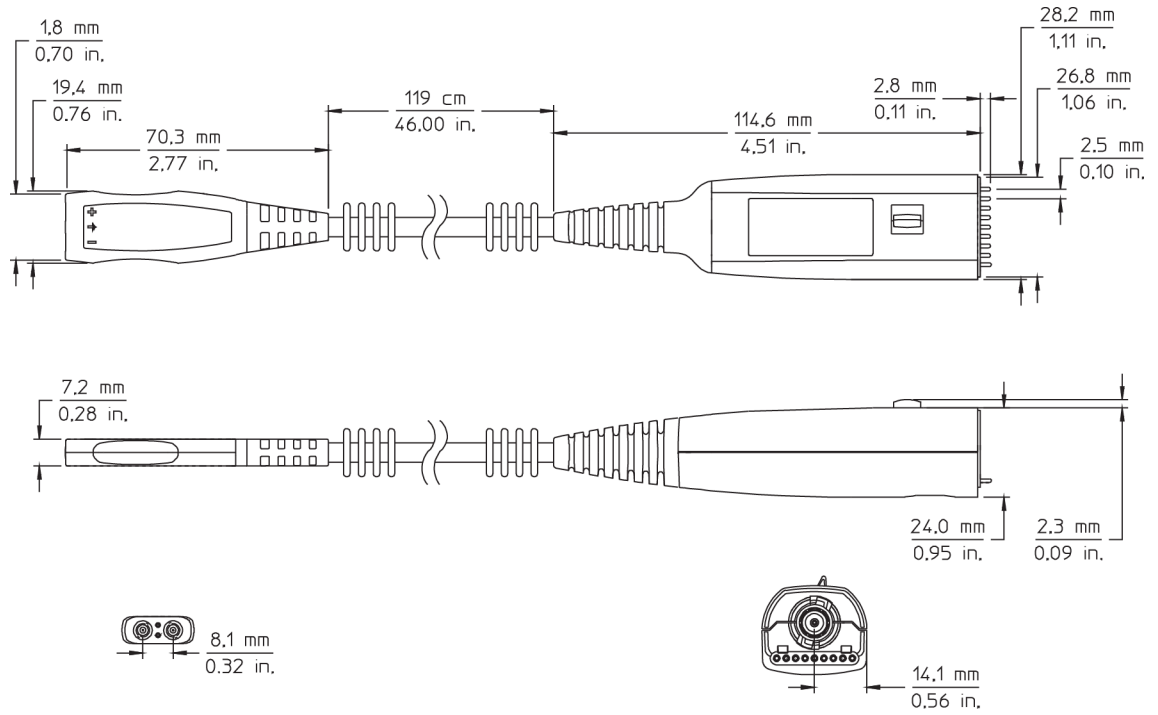

Figure 116 Probe Amplifier Dimensions

Probe Heads Dimensions

All dimensions in the figure below are in mm [inches].

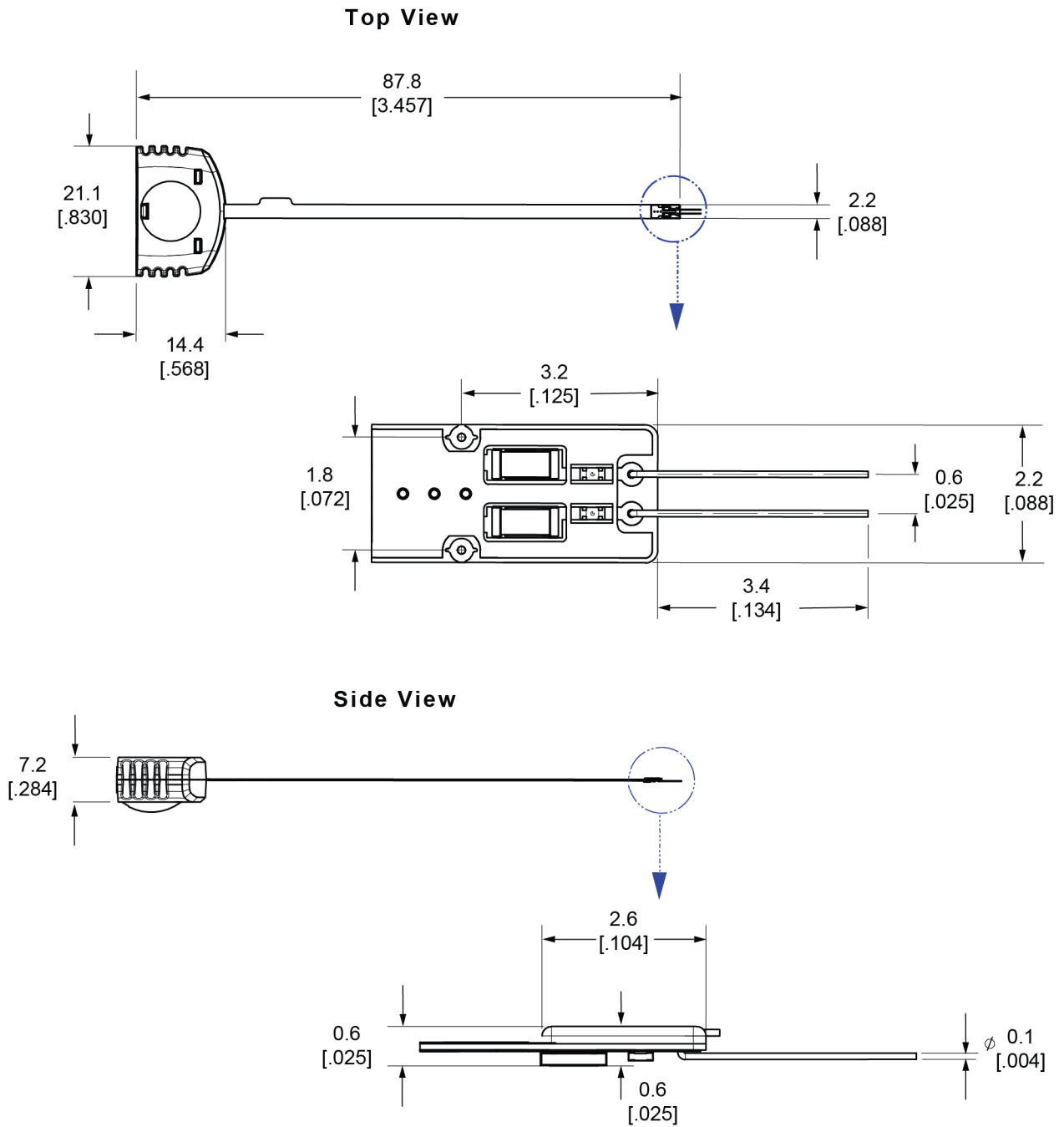
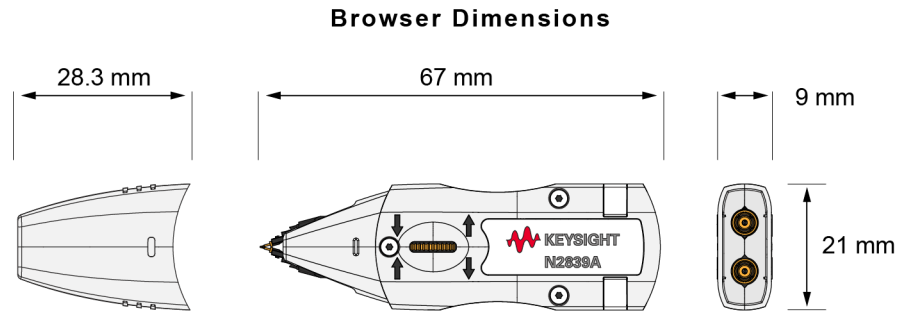

Figure 117 MX0100A Probe Head Dimensions



Probe Positioner Mounting Hole

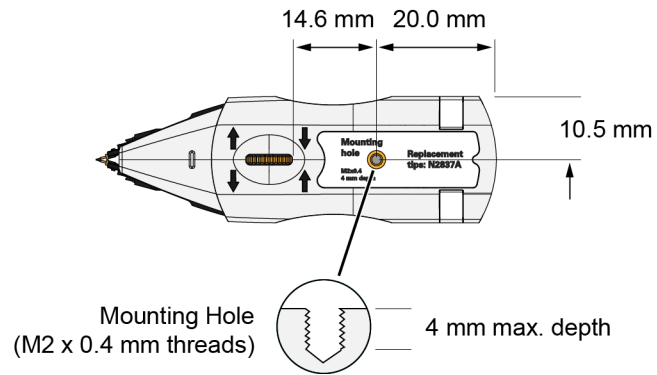

Figure 118 N2839A Probe Head Dimensions

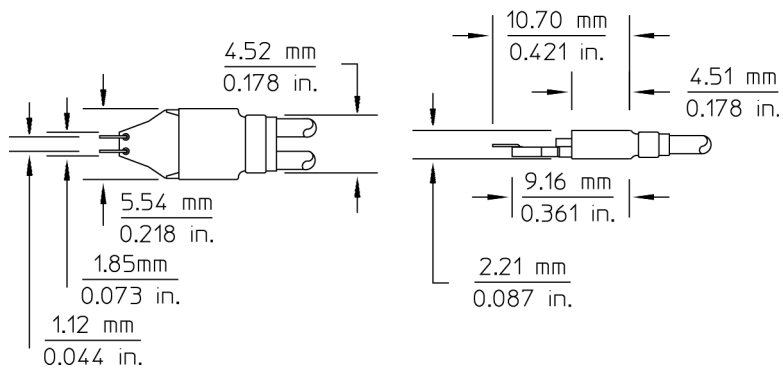

Figure 119 N5381B and N5382A Probe Head Dimensions

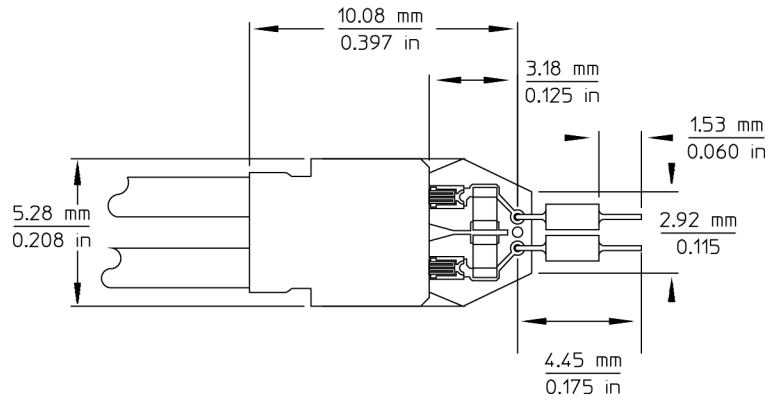

Figure 120 E2677B Solder-in Differential Probe Head Dimensions

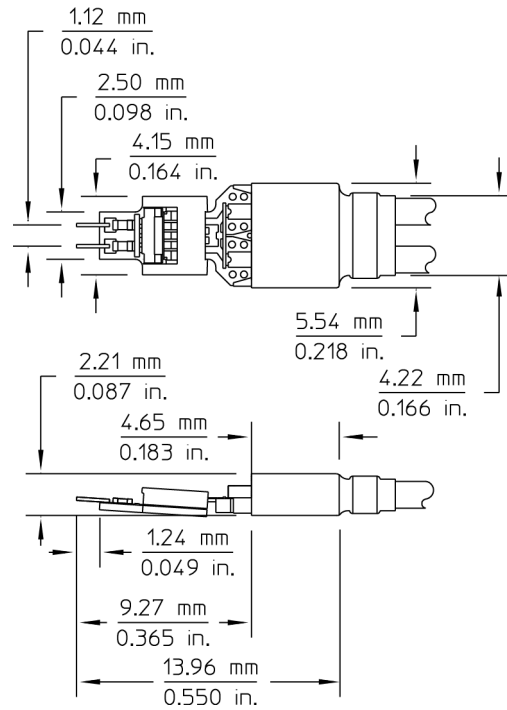

Figure 121 N5425B ZIF Probe Head Dimensions with N5426A ZIF Tip Attached

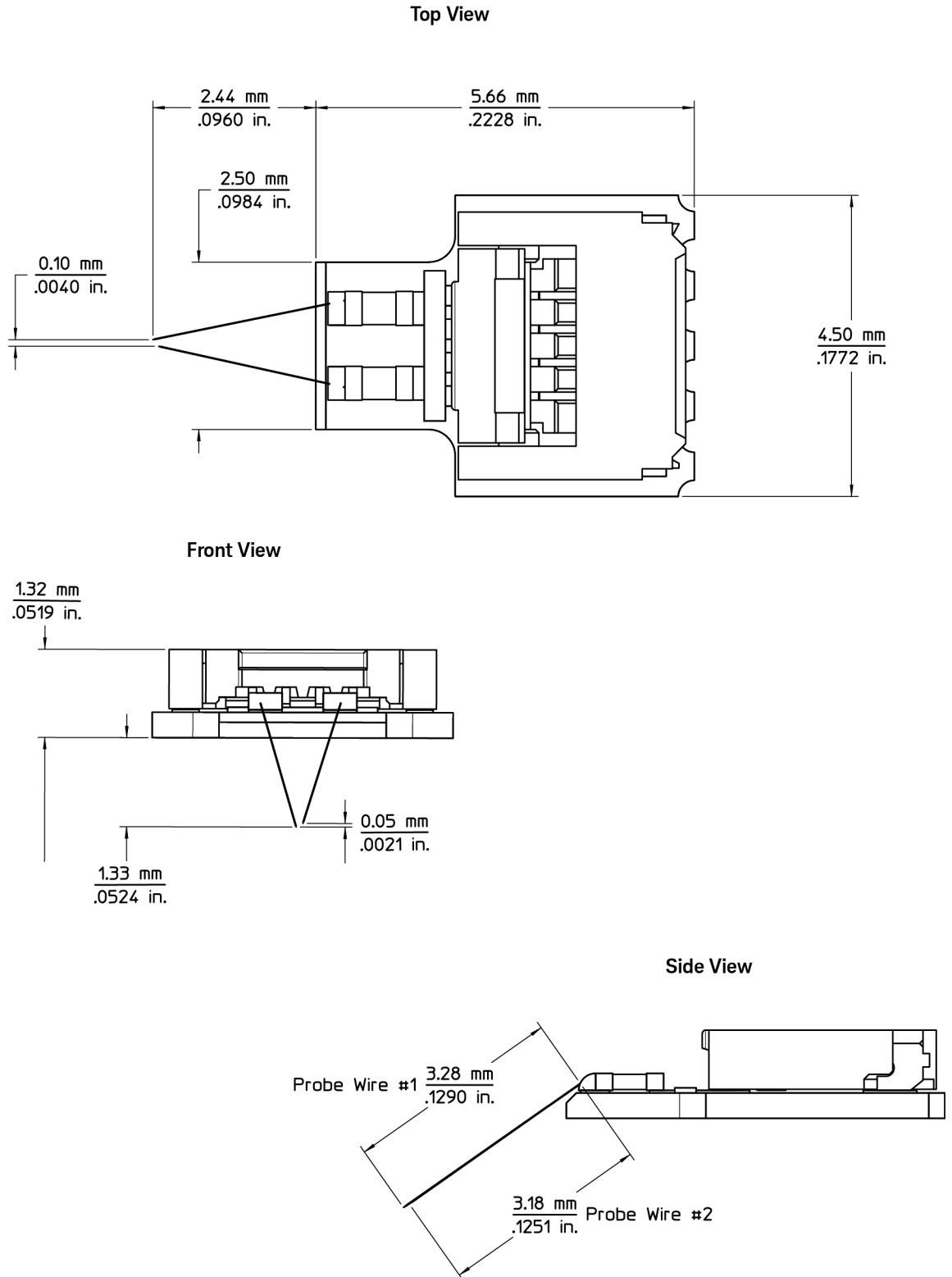
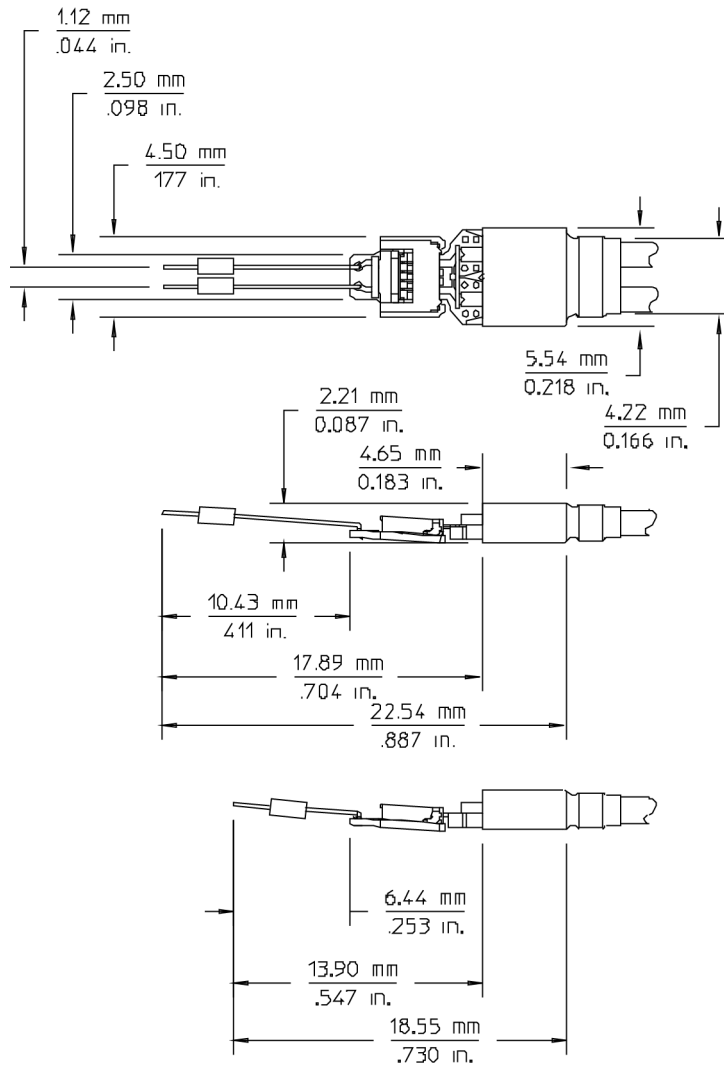

Figure 122 N2884A Fine Wire ZIF Tip Dimensions



Resistor test leads are approx. 11 mm and 7 mm after instal and solder.

Figure 123 N5451A ZIF Probe Head Dimensions with Long Wired ZIF Tip Attached

— N2851A QuickTip Probe Head —

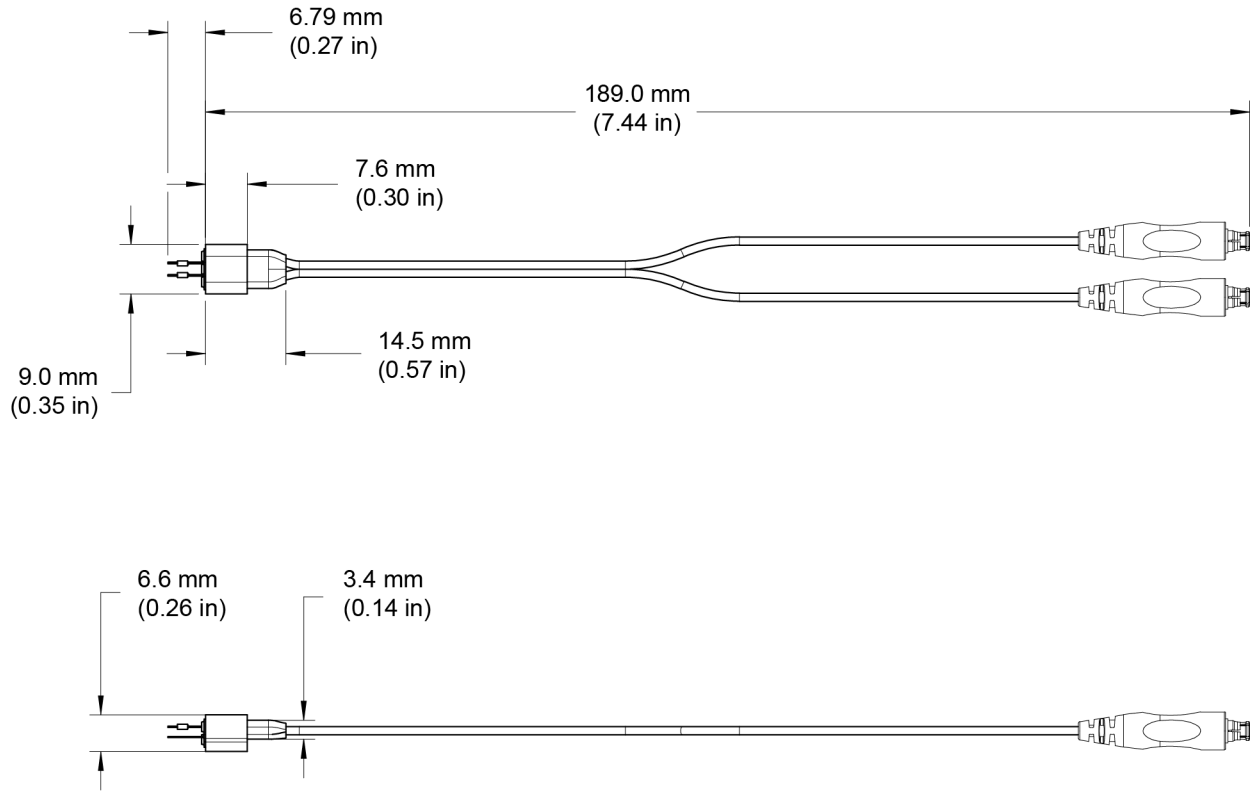

— N2849A QuickTip —

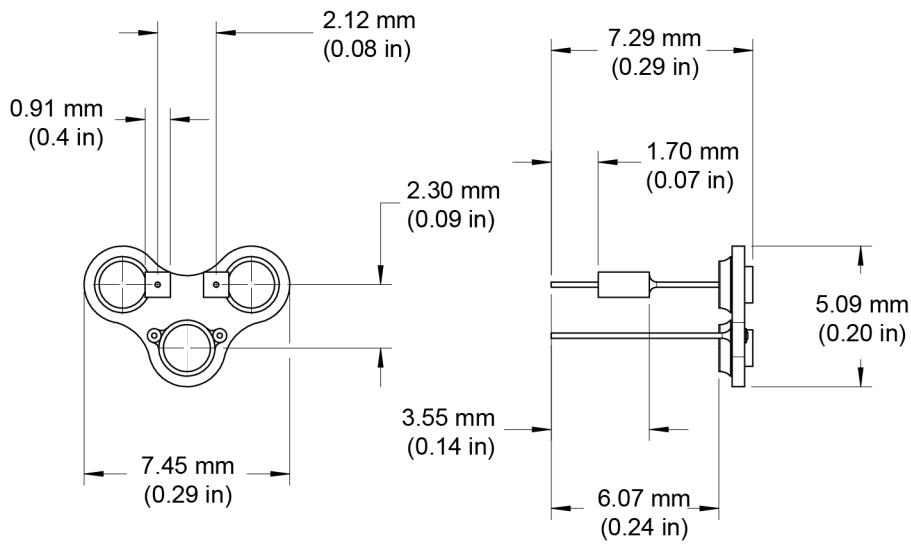

Figure 124 N2851A QuickTip Probe Head and N2849A QuickTip Dimensions

6 Performance Plots

MX0100A Micro Probe Head (Full BW)	152
N2839A Differential Browser Head (Full BW)	157
N5380B SMA Probe Head (Full BW)	162
N5380B SMA Probe Head with the 1134B InfiniiMax Probe	165
N5381B & N5382A Differential Probe Heads (Full BW)	166
N5381B Differential Solder-in Probe Head with 2x Longer Wires	171
N5425B ZIF Probe Head (Full BW)	172
N5425B ZIF Probe Head with N5451A Long-Wired ZIF Tip	176
7 mm Leads with 0° Separation	176
7 mm Leads with 60° Separation	179
11 mm Leads with 0° Separation	182
11 mm Leads with 60° Separation	185
N5426A ZIF Probe Tip Impedance	188
N2851A QuickTip Head with N2849A QuickTip	189
E2675B Differential Browser	190
E2676B Single-Ended Browser	192
E2677B Differential Solder-in Probe Head (High BW)	195
E2678B Differential Socketed Probe Head (High BW)	197
E2678B Differential Socketed Probe Head w/ Damped Wire	199
E2679B Single-Ended Solder-In Probe Head (High BW)	201
N2887A/N2888A Soft Touch Probe Heads	203

MX0100A Micro Probe Head (Full BW)

MX0100A Probe Head with InfiniiMax I and II Probe Amplifiers System Responses

InfiniiMax I and II probe amplifiers and MX0100A probe head (for use with Infiniium real-time oscilloscopes) utilize DSP correction filters to enhance the accuracy of measurements. When a probe is connected to an oscilloscope channel and the proper probe head is selected, the oscilloscope calculates a DSP correction filter that includes the probe head, probe amplifier, and oscilloscope channel. This provides the maximum measurement accuracy for the complete probe and scope channel system.

Since there are different probe amplifiers and MX0100A combinations, it is not reasonable to show the responses of all these combinations and the responses would all be very much the same because they are all corrected to same target system response. The target system response is a flat magnitude, flat phase response high order low-pass filter that maximizes measurement accuracy.

MX0100A Corrected Frequency Response

Figure 125 shows an example of a typical corrected system frequency response of the MX0100A probe head when used with a 12 GHz 1169B probe amplifier. The -3db bandwidth is 12.4GHz. If a lower bandwidth probe amplifier is used, the system will have a bandwidth of that probe amplifier.

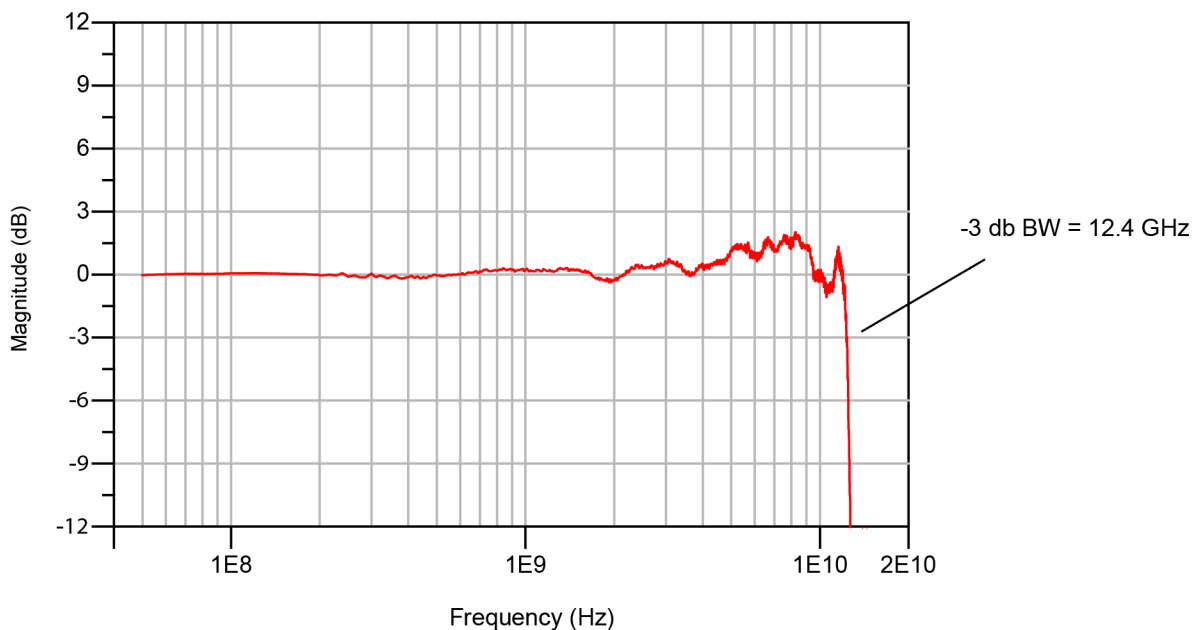
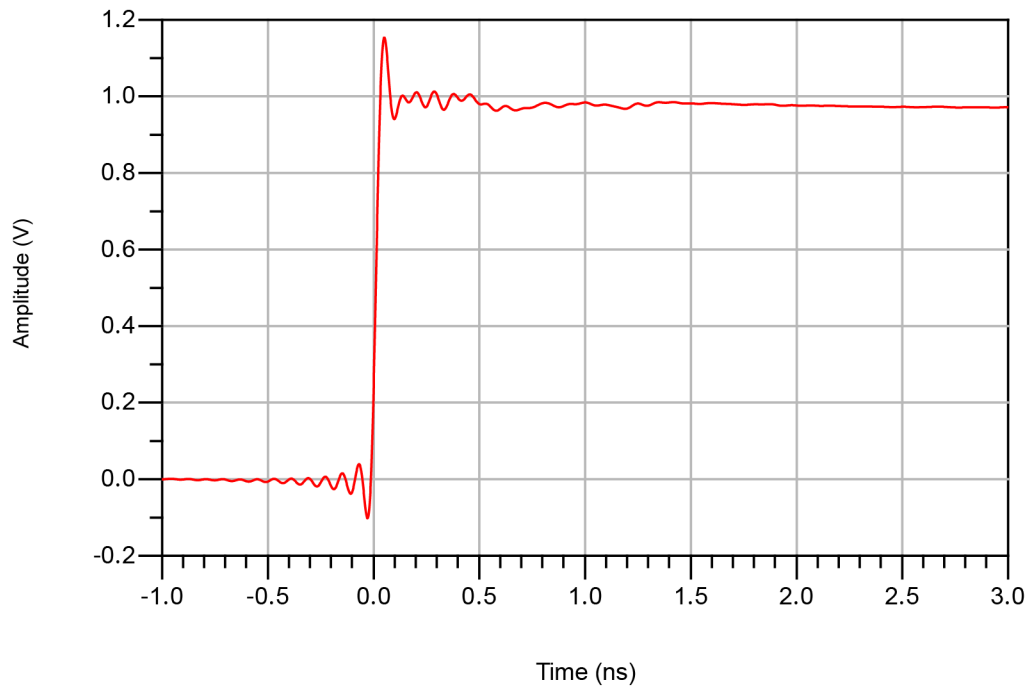

Figure 125 Typical Corrected Frequency Response for the MX0100A Probe Head and 12 GHz 1169B Probe Amplifier Combination

MX0100A Step Response

Figure 126 shows the step response of the MX0100A probe head with a 12 GHz 1169B probe amplifier. The step response of a system is the response to an ideal step. The 10% to 90% transition time of the step response is 32pS and the 20% to 80% transition time is 23pS.

The step response of a system is a good indicator of the quality of the system, but to accurately measure a signal under test (SUT), that signal must have a transition time greater than the system transition time. For most SUT steps without excessive overshoot, its transition time should be about 1.56 times the system 10% to 90% transition time for less than ~3% error. Since the system in the following figure has a transition time of 32pS, the SUT should not be much faster than $1.56 * 32\text{pS} = 50\text{pS}$.



Step Response

$TR_{10/90} = 32\text{pS}$

$TR_{20/80} = 23\text{pS}$

Figure 126 Typical V_{out} / V_{in} Corrected Step Response of the MX0100A probe head with a 12 GHz 1169B probe amplifier.

MX0100A Step Tracking

Figure 127 shows a signal under test (SUT) in red that has a 10% to 90% transition time of 49.7pS. The probe system measuring the SUT is shown in blue and it has a transition time of 48.3pS which at 2.8% error is within 3% error and tracks the SUT step very well.

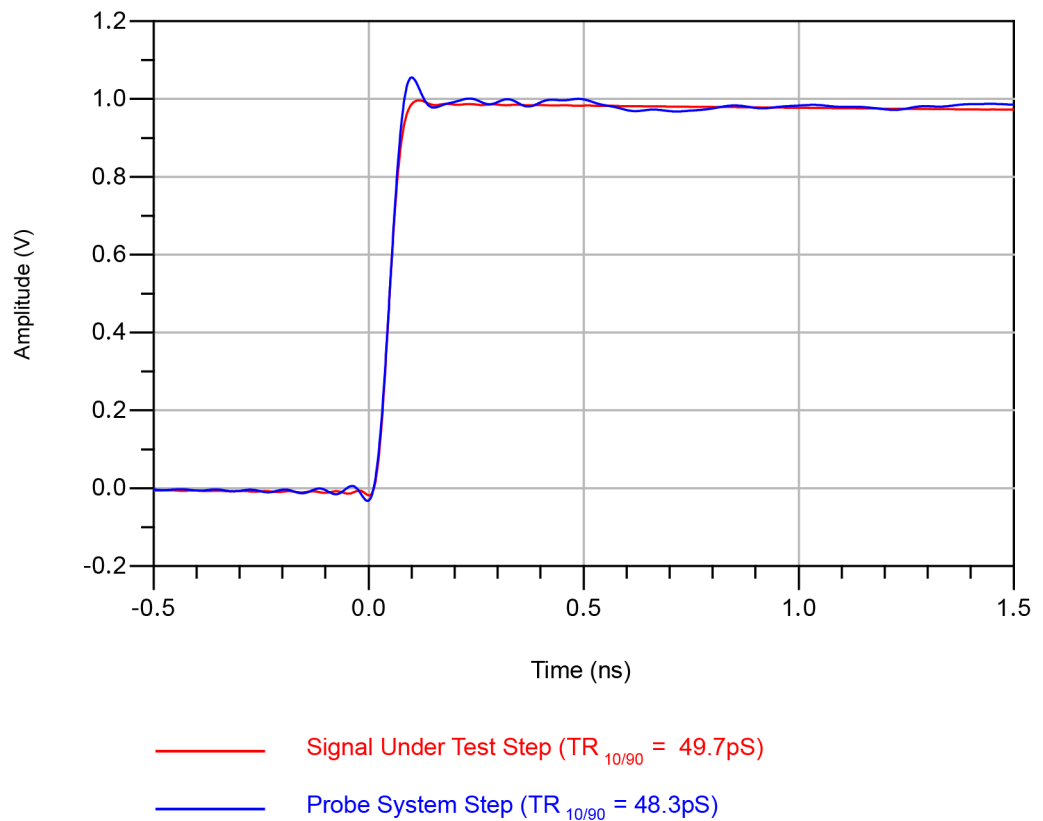

Figure 127 MX0100A Step Tracking

MX0100A CMRR

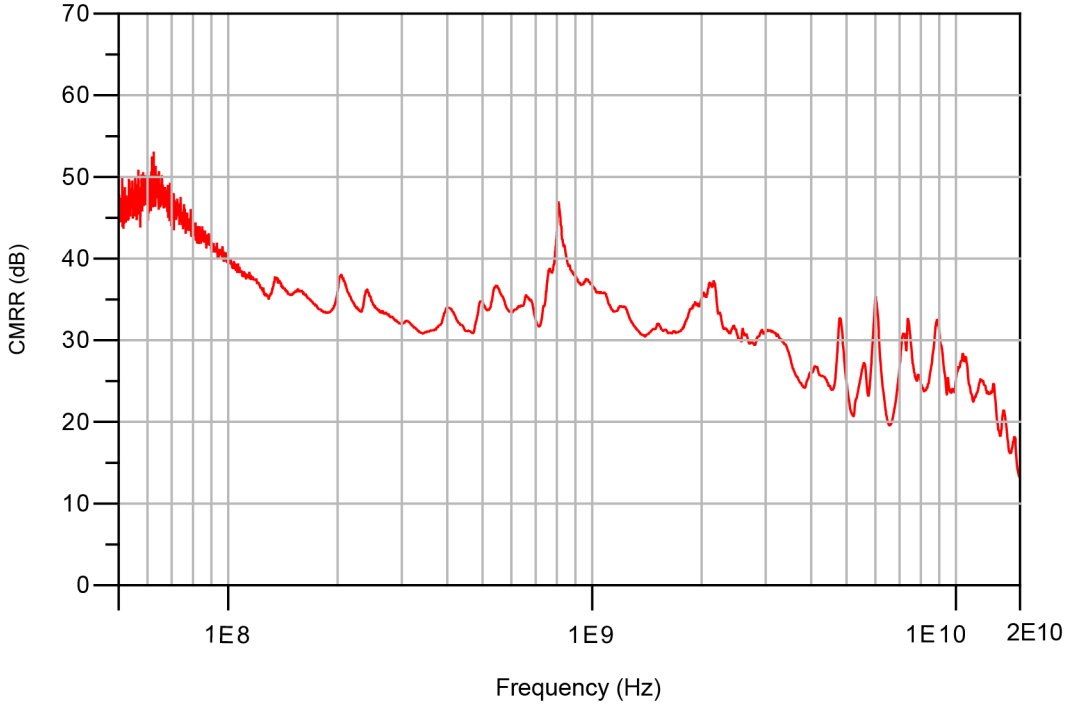

Figure 128 CMRR of MX0100A Probe Head With 1169B 12 GHz Probe Amplifier

MX0100A Input Impedance Plot

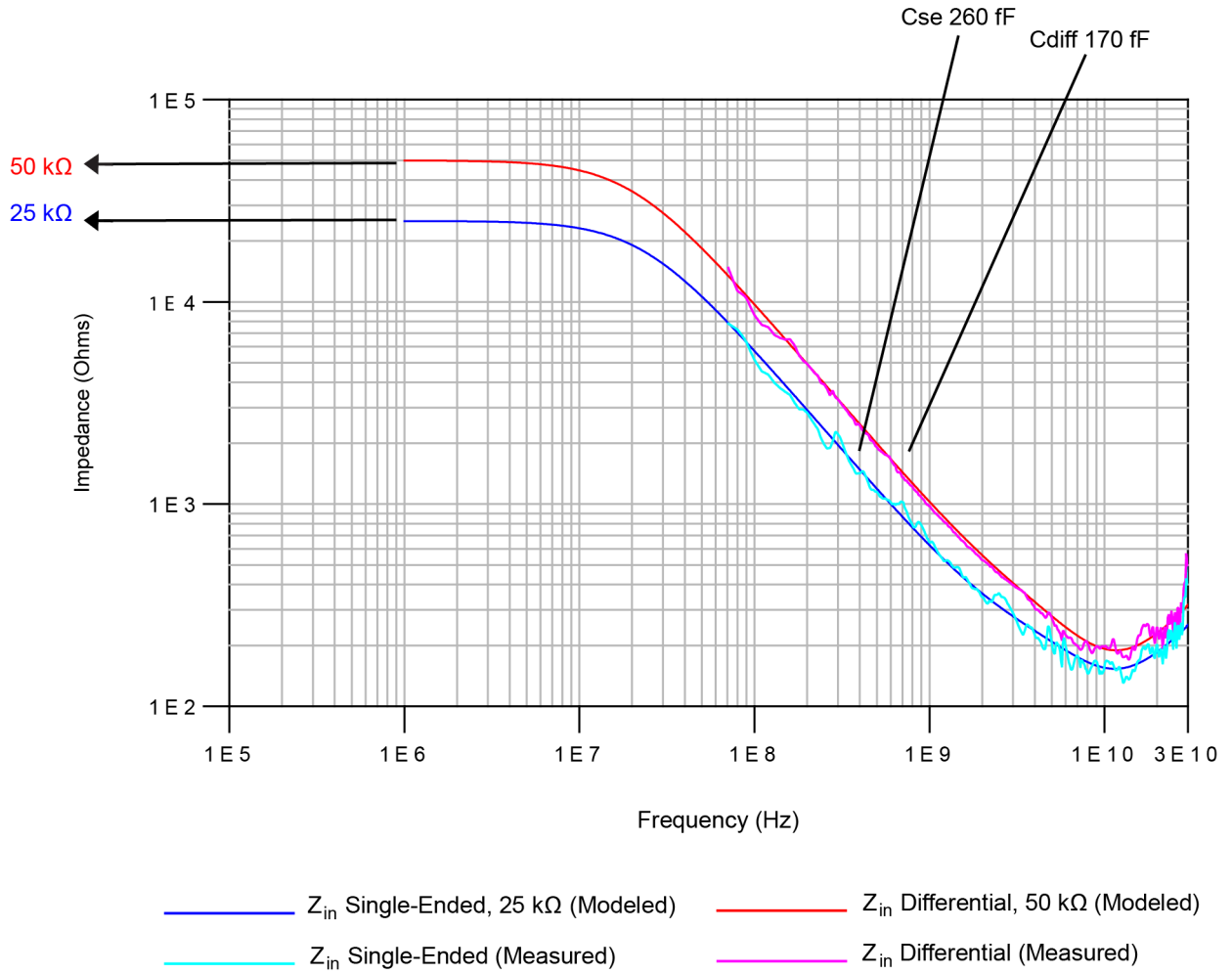

Figure 129 Input Impedances (Z_{in} Modeled and Z_{in} Measured) for the MX0100A Micro Probe Head

N2839A Differential Browser Head (Full BW)

The following performance characteristic plots are for the 1169B probe using N2839A browser head.

NOTE

Time and frequency responses shown are for a typical probe head and typical probe amplifier corrected by the DSP filters in the Keysight Infiniium oscilloscopes. Magnitude and phase correction ensures the best performance and highest accuracy.

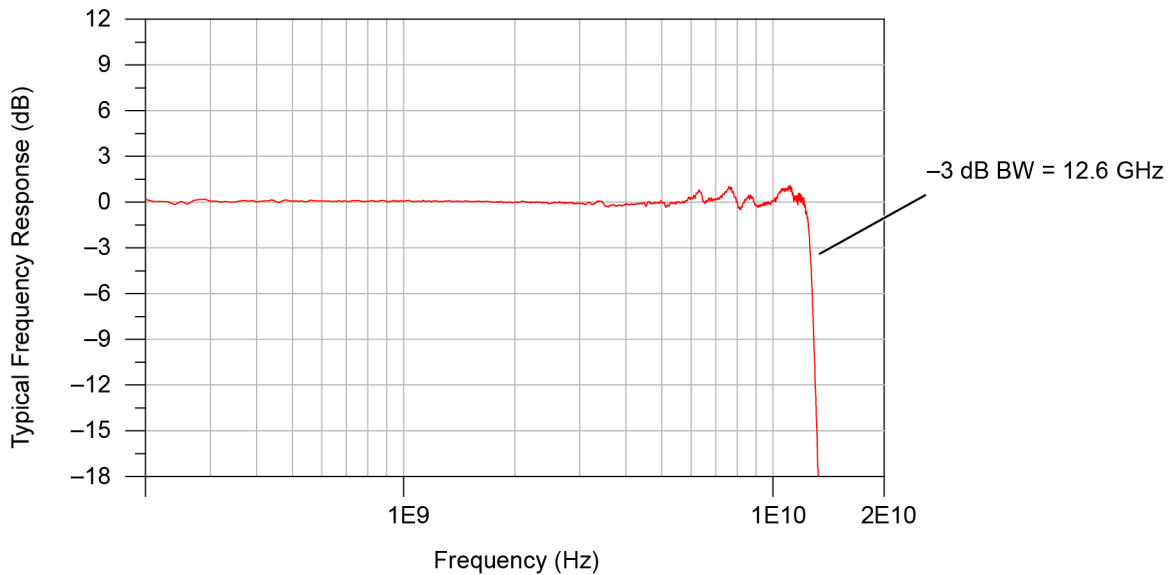
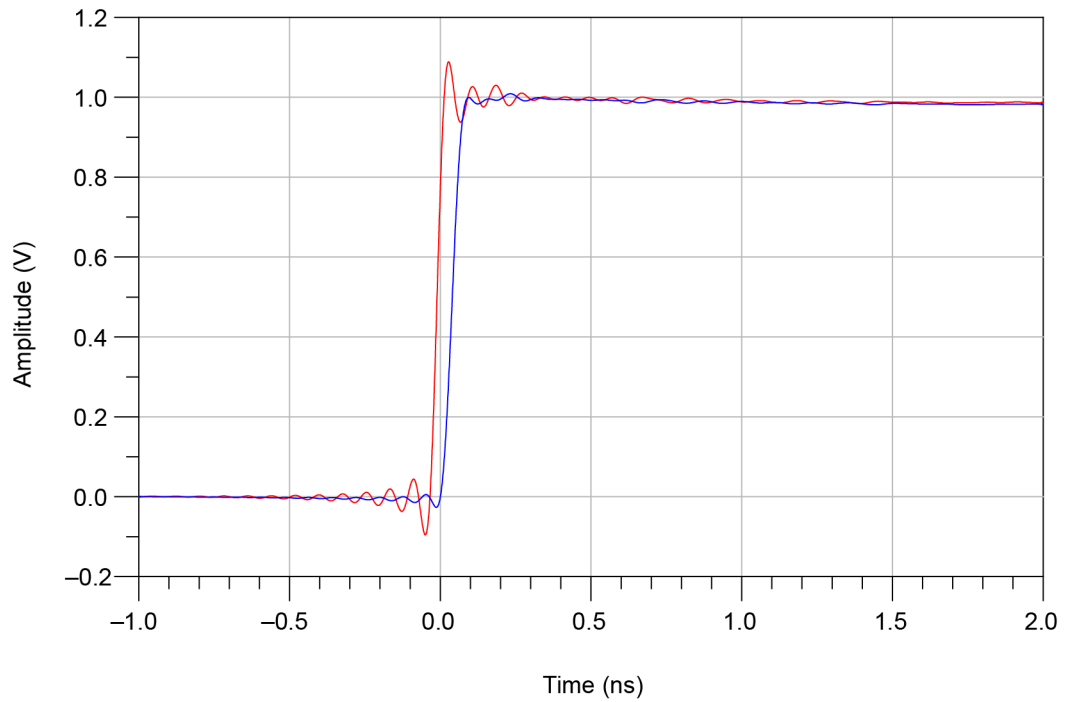

Figure 130 Typical Frequency Response (Corrected V_{out} / V_{in} response of a typical 12 GHz browser head with a typical 1169B 12 GHz probe amplifier.)



- Step Response
TR_{10/90} = 33.6 ps
TR_{20/80} = 24.0 ps

- Step Response to a 6.6 GHz 4th order Bessel filter with
 52.0 ps 10/90% rise time and 34.9 ps 20/80% rise time
TR_{10/90} = 52.7 ps
TR_{20/80} = 36.3 ps

Figure 131 Typical V_{out} / V_{in} Corrected Step Response to an Ideal Step and a 4th Order Bessel 52 ps Step

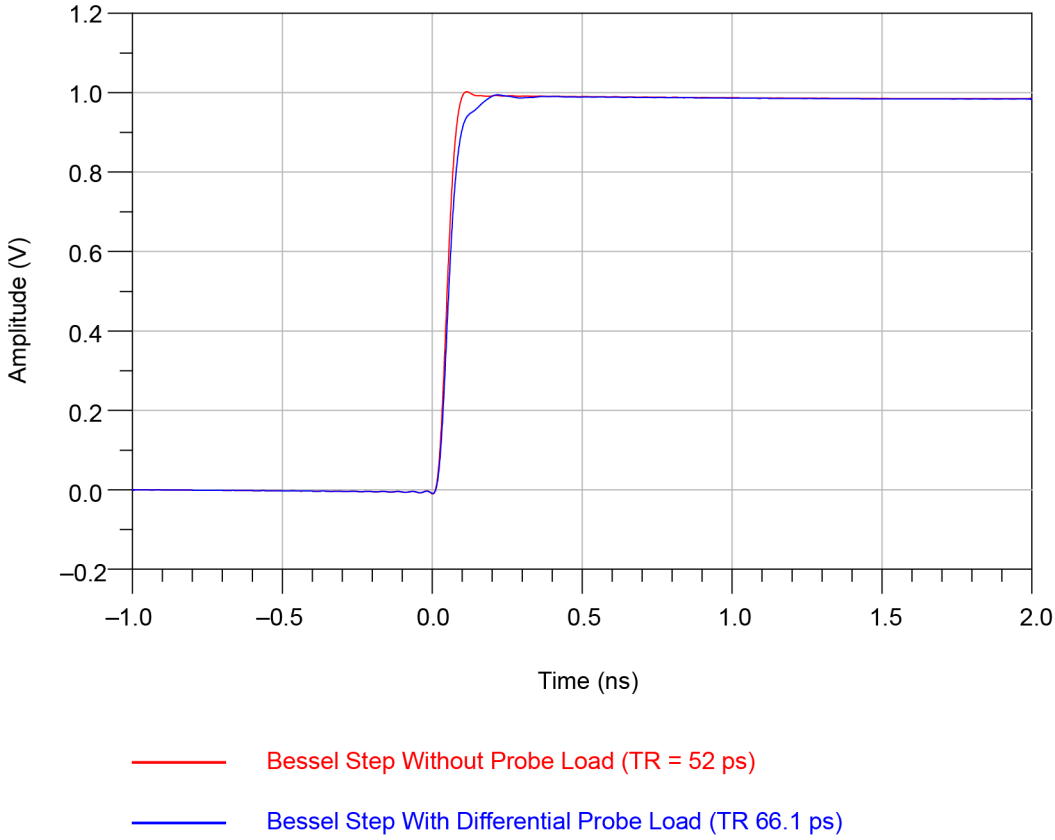

Figure 132 Probe Loading Effect When N2839A is Driven From a 50-Ohm Differential Step

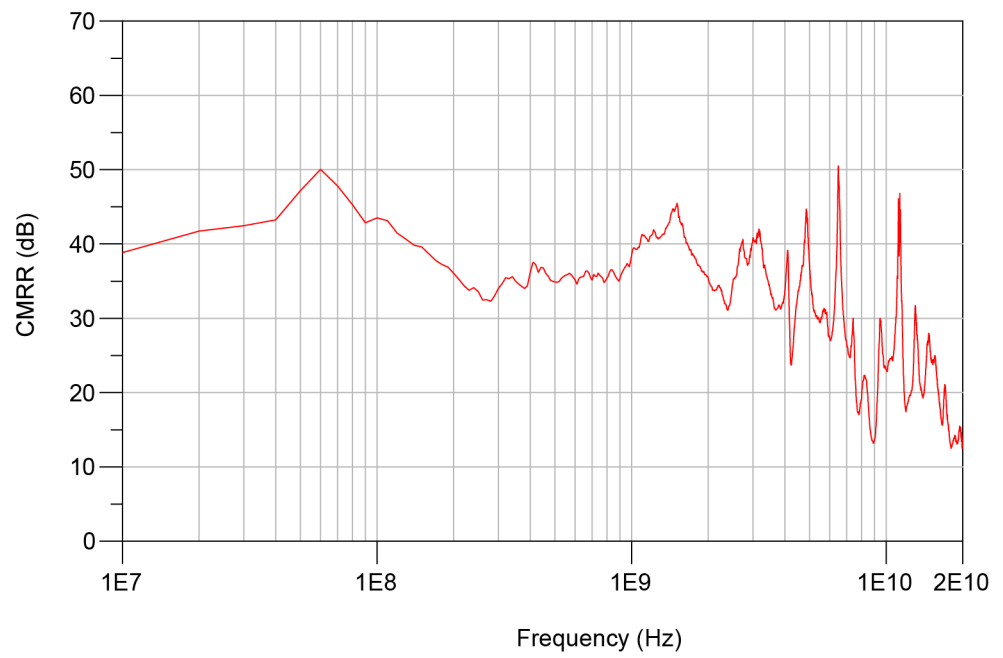

Figure 133 CMRR of N2839A 12 GHz Probe Head With 1169B 12 GHz Probe Amplifier

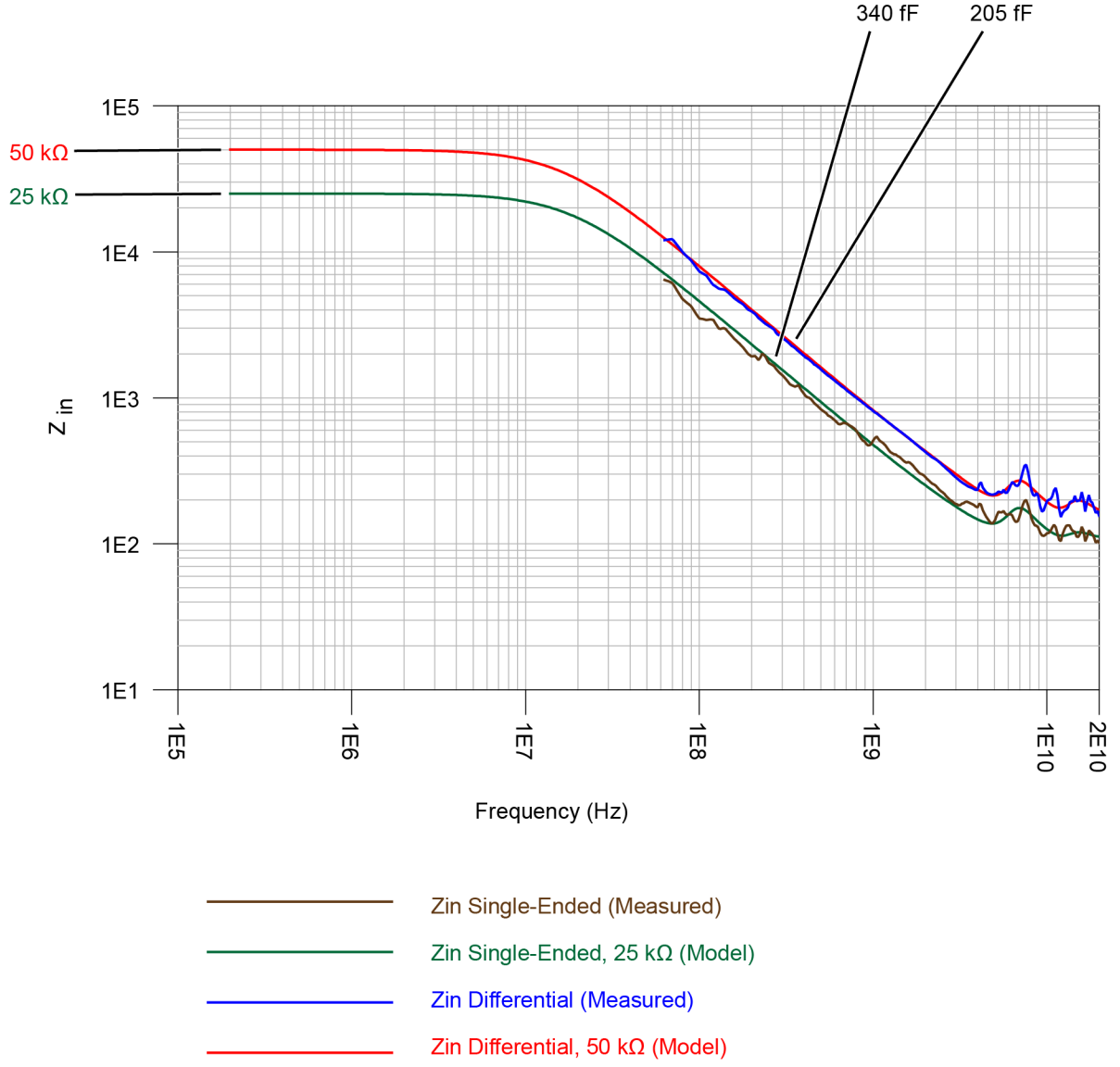

Figure 134 N2839A Input Impedances Measured and Modeled

N5380B SMA Probe Head (Full BW)

The following performance characteristic plots are for the 1168B and 1169B probes using the N5380B probe head.

NOTE

Unless otherwise noted, time and frequency responses shown here are for the probe only. when the probe is used with the 90000 series oscilloscope, magnitude and phase correction is applied to further optimize the overall response.

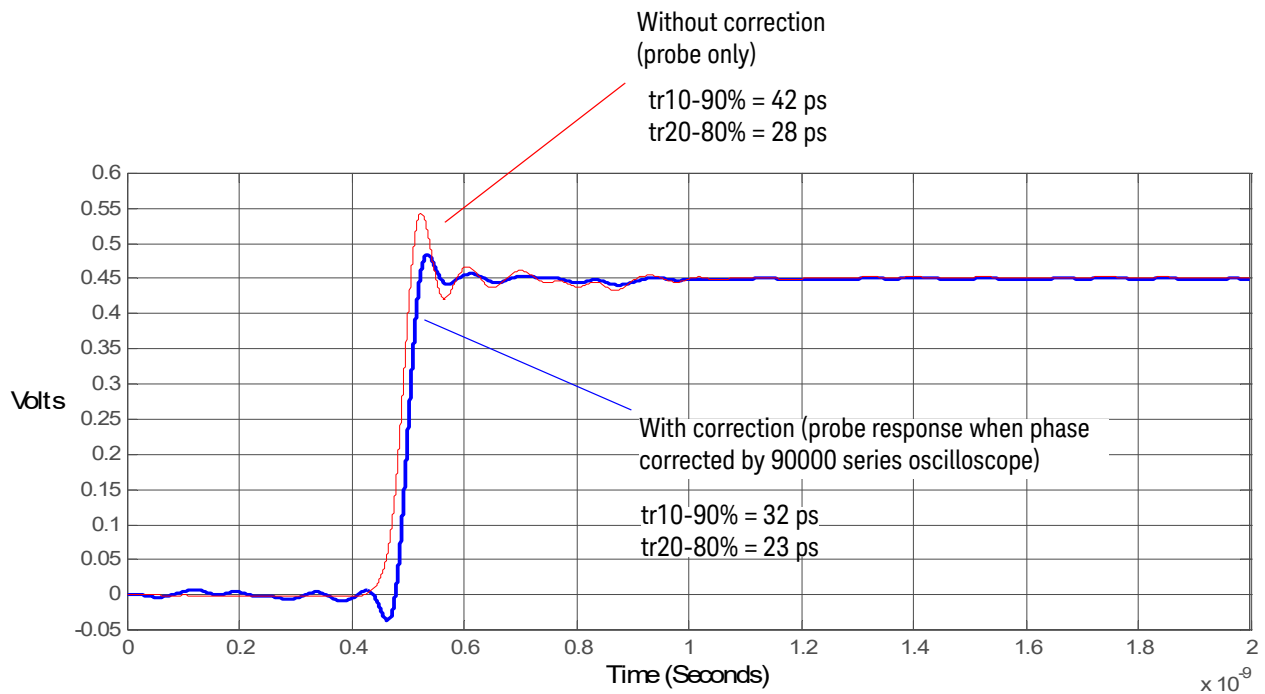

Figure 135 Step response with and without phase correction. Normalized to an ideal input step

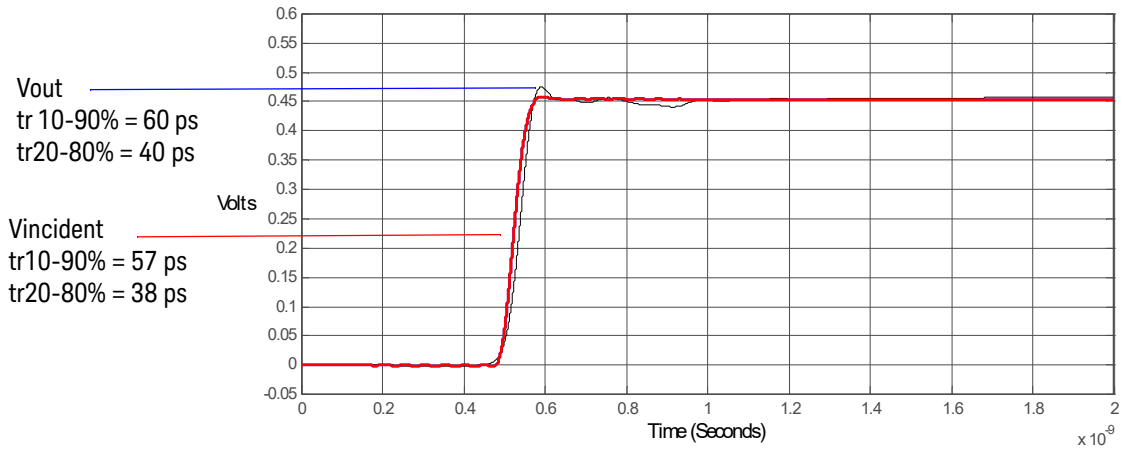

Figure 136 Vincident and Vout of probe with a 57 ps step

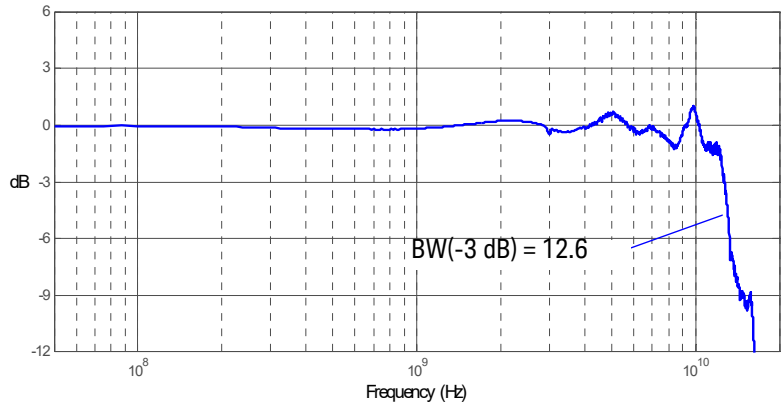

Figure 137 Magnitude plot of differential insertion loss +6.8 dB

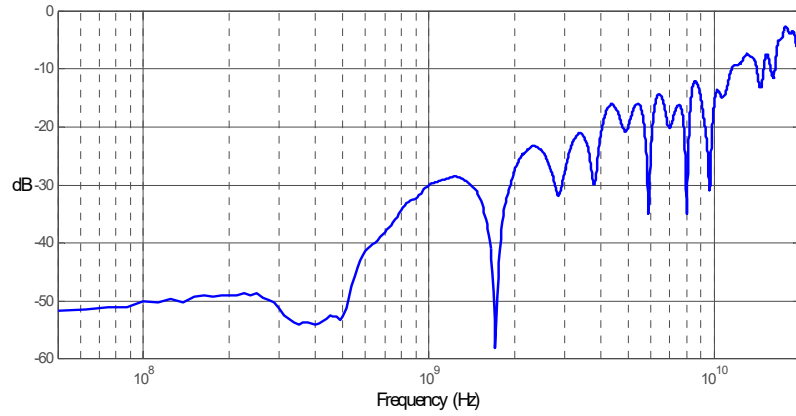

Figure 138 Magnitude plot of differential return loss

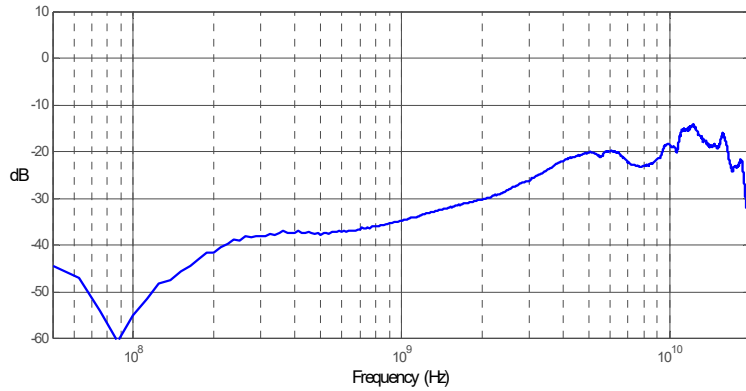

Figure 139 Magnitude plot of common mode response +6.8dB (common mode rejection)

N5380B SMA Probe Head with the 1134B InfiniiMax Probe

The following performance characteristic plots are for the 1134B probe using N5380B probe head.

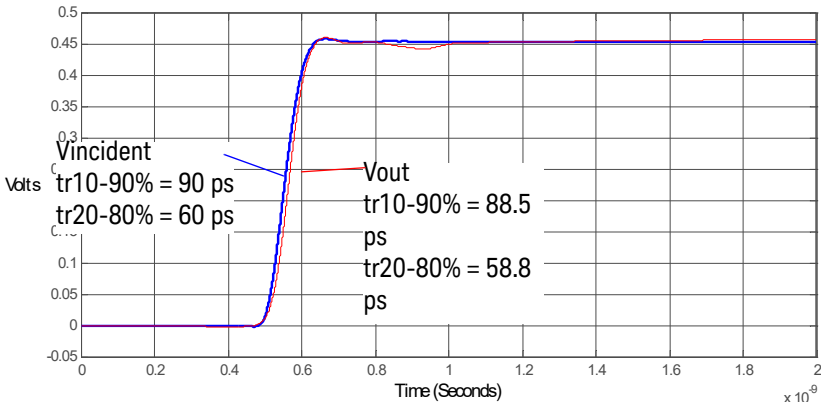

Figure 140 Vincident and Vout of probe with a 90 ps step

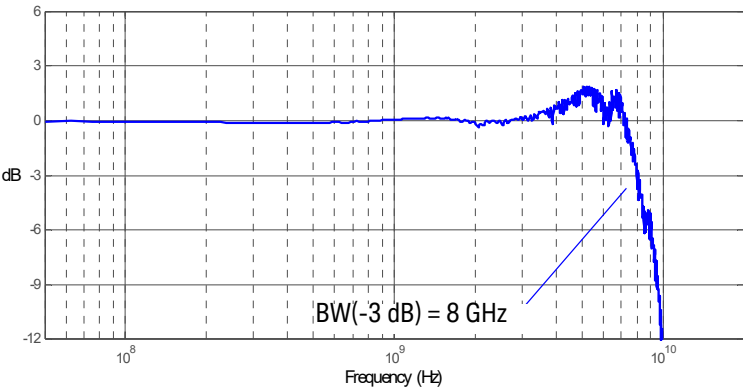

Figure 141 Magnitude response of differential insertion loss +16.03 dB

N5381B & N5382A Differential Probe Heads (Full BW)

The following performance characteristic plots are for the 1168B and 1169B probes using N5381B and N5382A probe heads.

NOTE

Unless otherwise noted, time and frequency responses shown here are for the probe only. when the probe is used with the 90000 series oscilloscope, magnitude and phase correction is applied to further optimize the overall response.

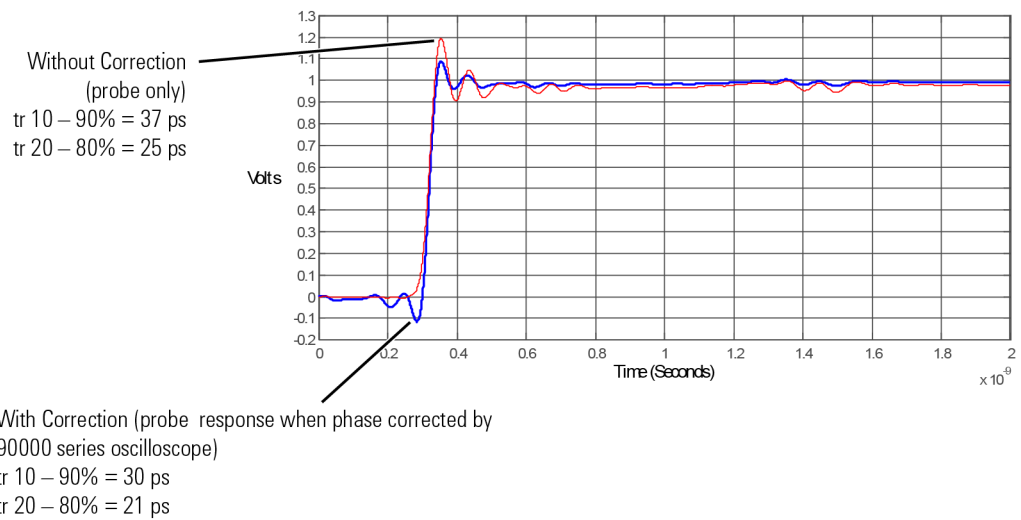

Figure 142 Step Response With and Without Phase Correction. Normalized to an Ideal Input Step

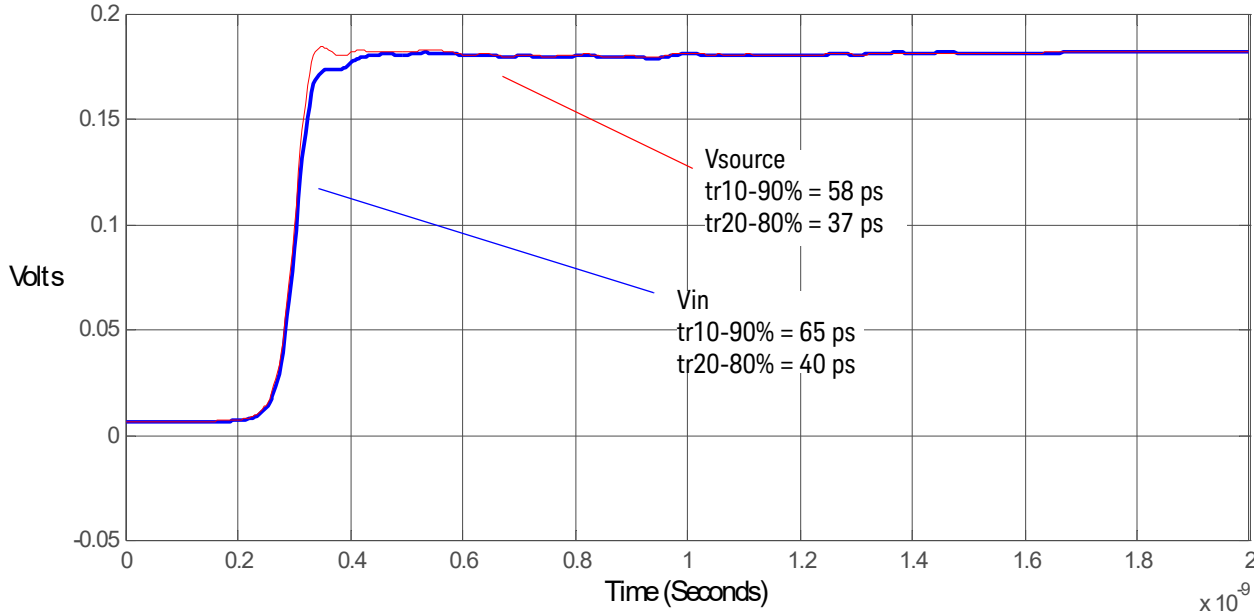

Figure 143 25Ω 58 ps step generator with and without probe connected

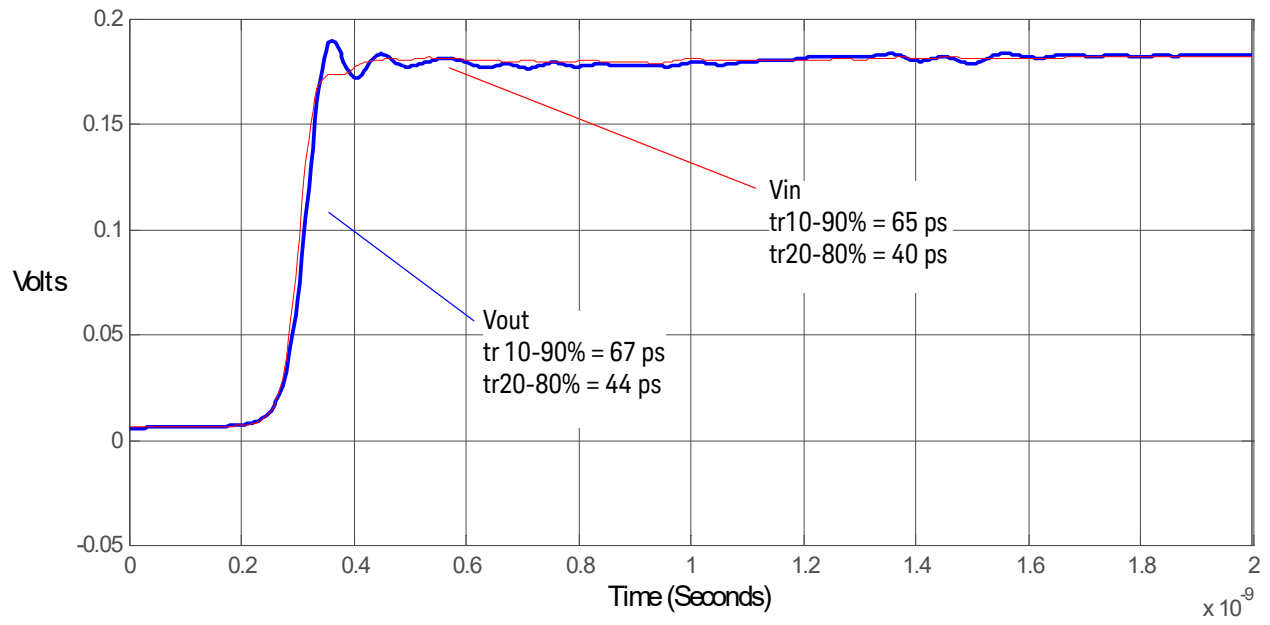

Figure 144 Vin and Vout of probe with a 25Ω 58 ps step generator

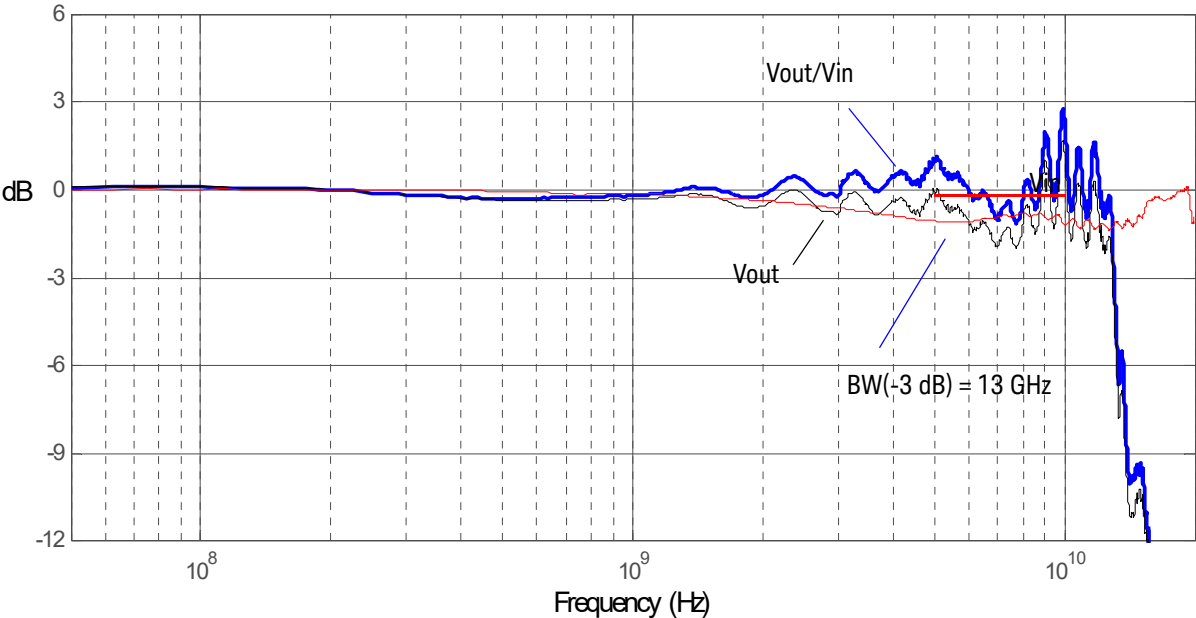

Figure 145 $\text{dB}(V_{in})$ and $\text{dB}(V_{out}) + 10.8 \text{ dB}$ of probe with a 25Ω source and $\text{dB}(V_{out}/V_{in}) + 10.8 \text{ dB}$ frequency response

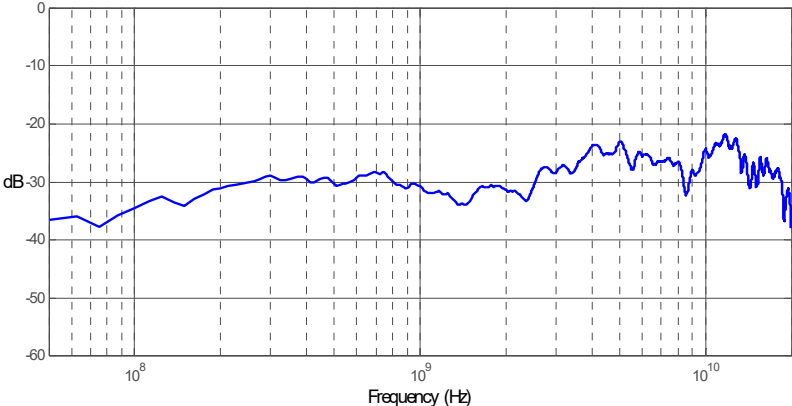

Figure 146 $\text{dB}(V_{out}/V_{in}) + 10.8 \text{ dB}$ frequency response when inputs driven in common (common mode rejection)

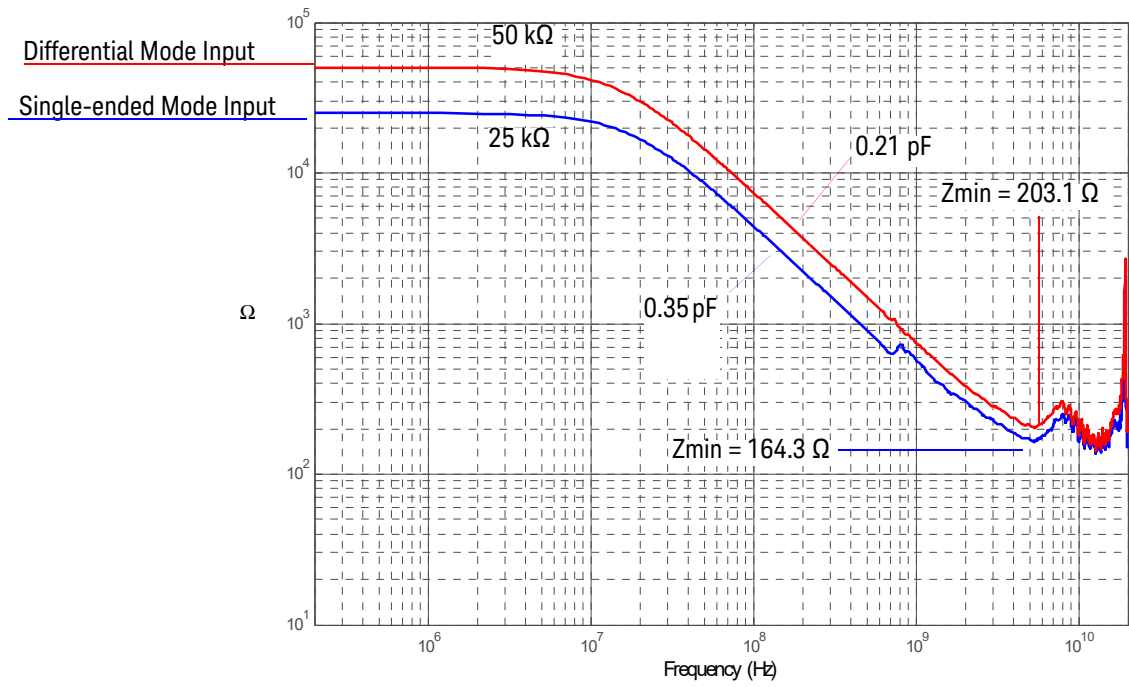

Figure 147 Magnitude plot of probe input impedance versus frequency

N5381B Differential Solder-in Probe Head with 2x Longer Wires

The following performance characteristic plots are for the 1169B probe using N5381B probe head. The plot shows the probe response to a 25Ω, 58 ps step generator with the recommended wire length, twice the recommended wire length with wires parallel to each other, and twice the recommended wire length with wires spread 90 degrees.

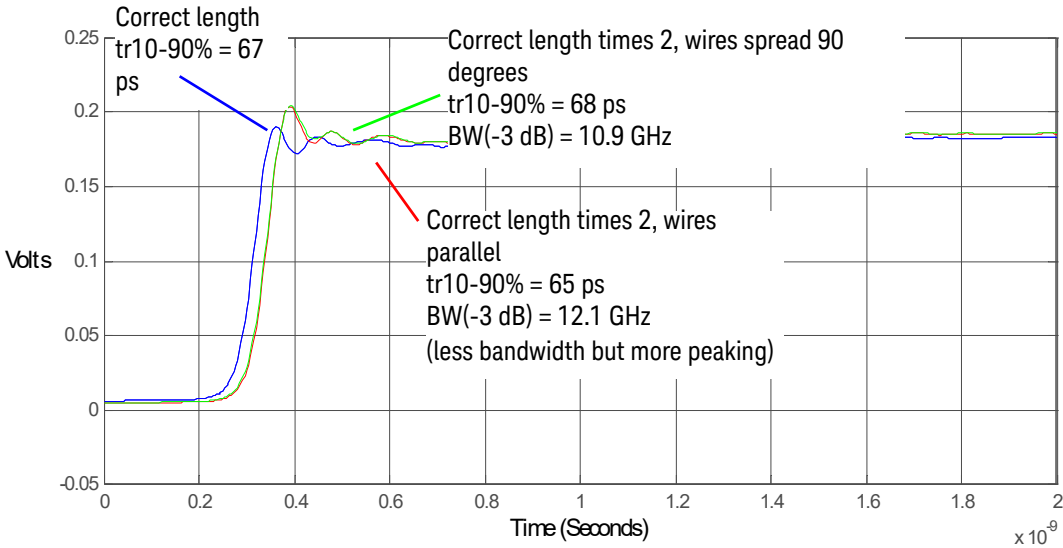

Figure 148 Probe Response

N5425B ZIF Probe Head (Full BW)

The following performance characteristic plots are for the 1168B and 1169B probes using N5425B probe head.

NOTE

Unless otherwise noted, time and frequency responses shown here are for the probe only. when the probe is used with the 90000 series oscilloscope, magnitude and phase correction is applied to further optimize the overall response.

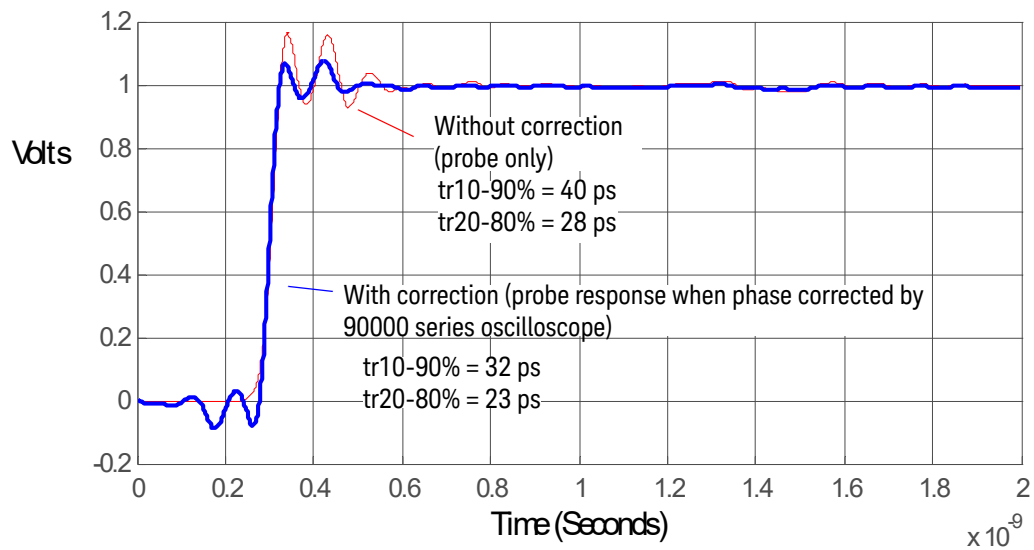

Figure 149 Step response with and without phase correction. Normalized to an ideal input step

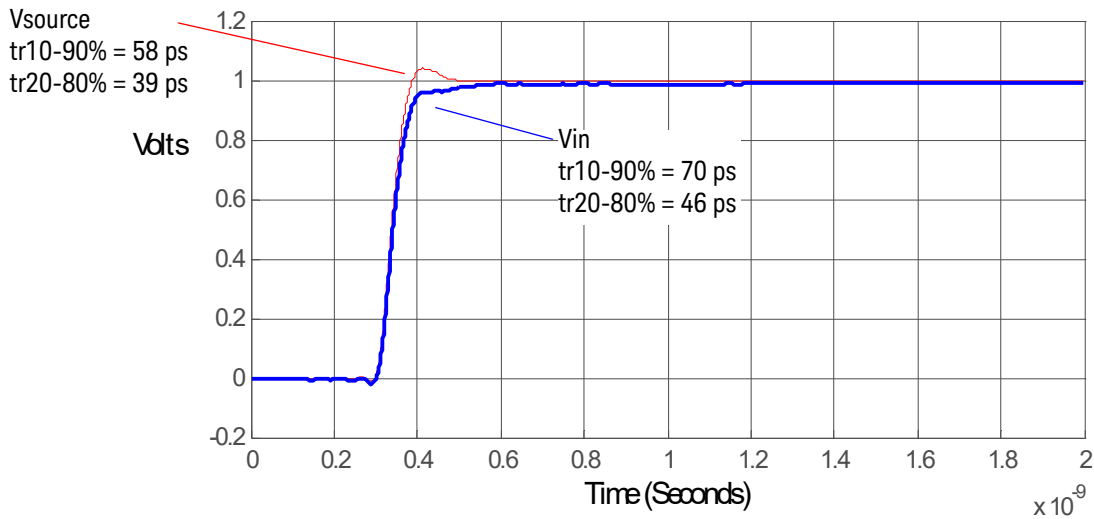

Figure 150 25Ω 58 ps step with and without the probe connected

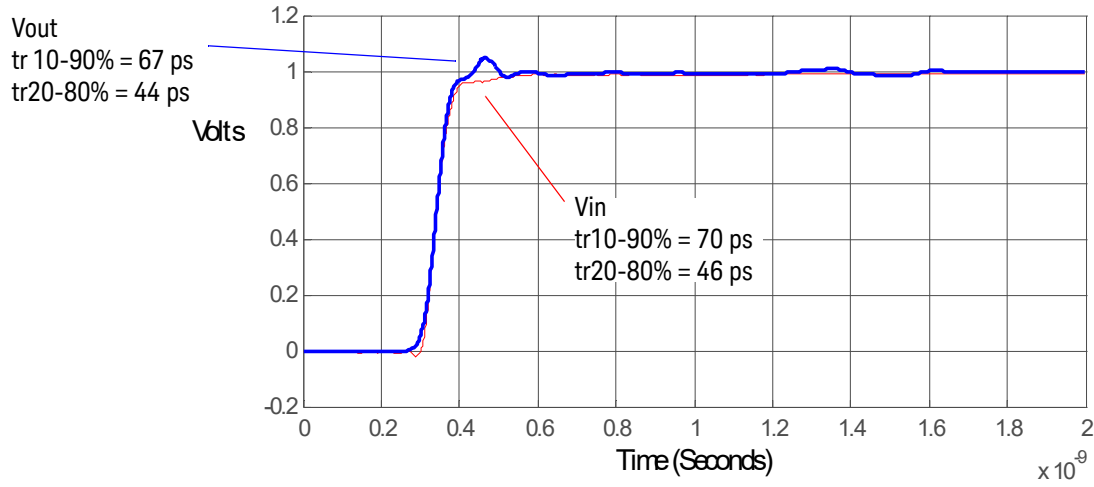

Figure 151 Vin and Vout of probe with a 25Ω 58 ps step

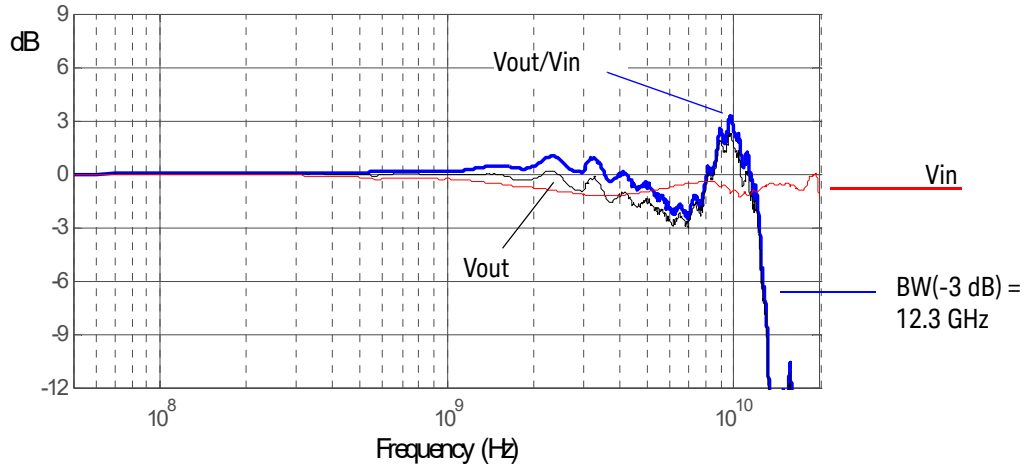

Figure 152 $\text{dB}(V_{in})$ and $\text{dB}(V_{out}) + 10.8 \text{ dB}$ of probe with a 25Ω source and $\text{dB}(V_{out}/V_{in}) + 10.8 \text{ dB}$ frequency response

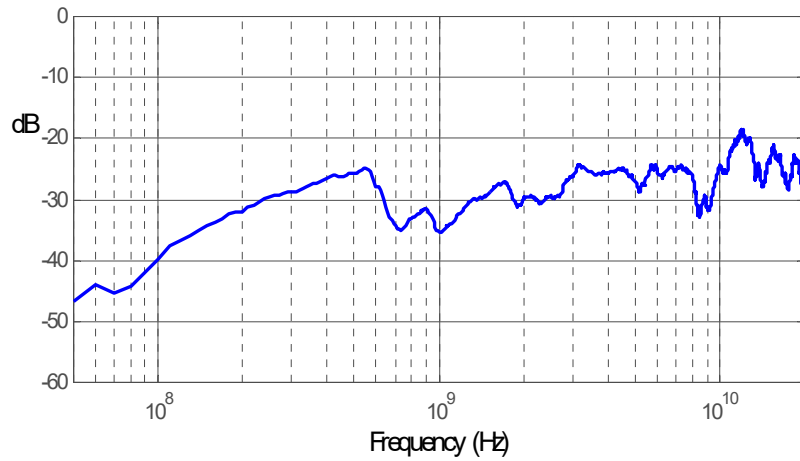

Figure 153 $\text{dB}(V_{out}/V_{in}) + 10.8 \text{ dB}$ frequency response when inputs driven in common (common mode rejection)

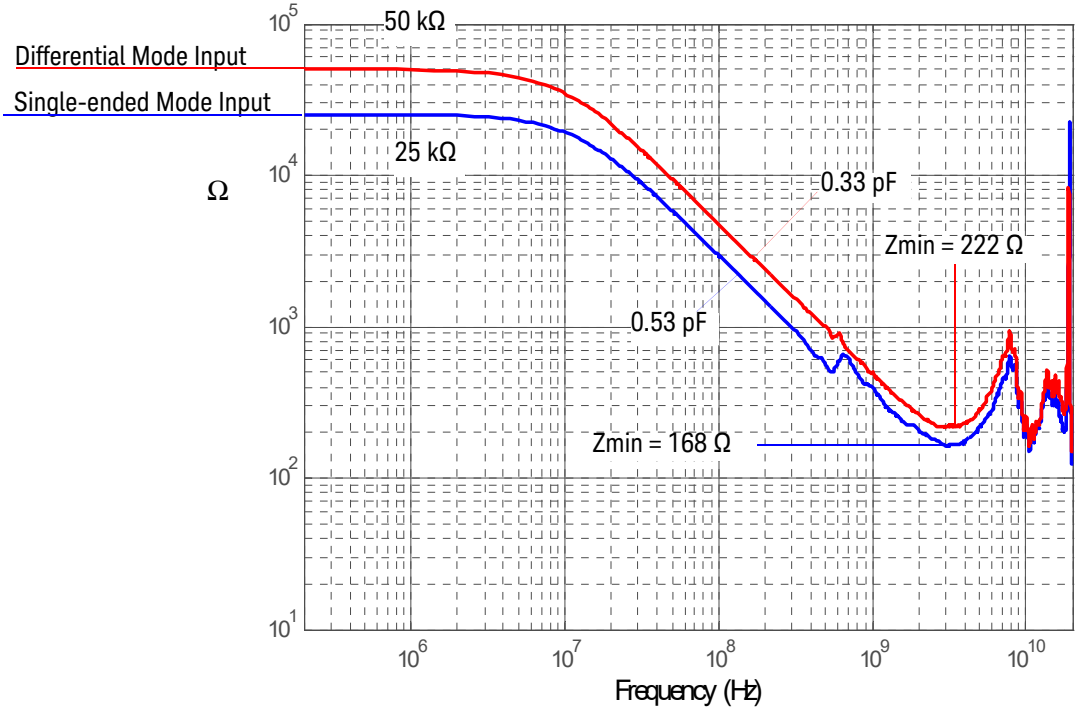

Figure 154 Magnitude plot of probe input impedance versus frequency

N5425B ZIF Probe Head with N5451A Long-Wired ZIF Tip

The following performance characteristic plots are for the 1168B and 1169B probes using the N5451A ZIF tip. The plots are organized according to tip's lead length and separation between leads.

NOTE

Unless otherwise noted, time and frequency responses shown here are for the probe only, when the probe is used with the 90000 series oscilloscope, magnitude and phase correction is applied to further optimize the overall response.

7 mm Leads with 0° Separation

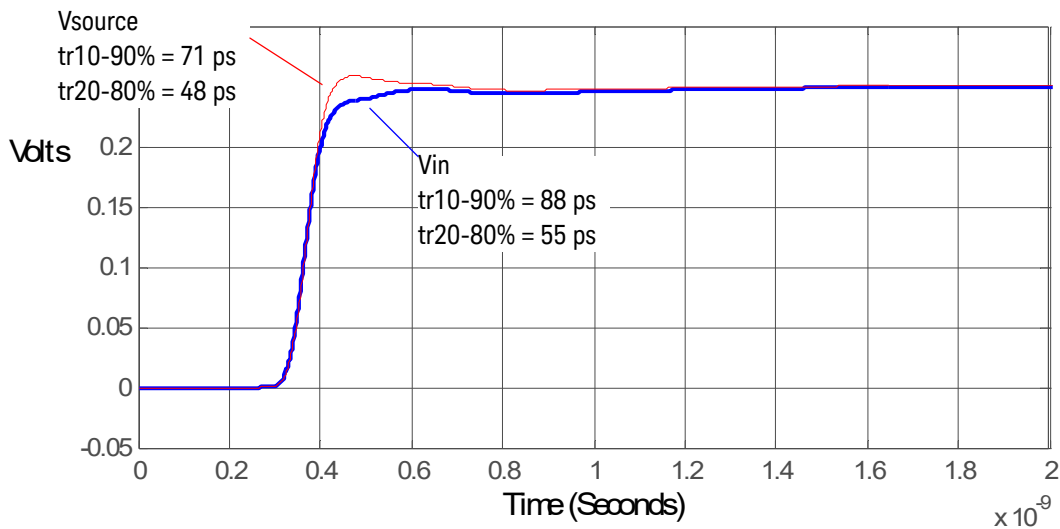

Figure 155 25Ω 71 ps step generator with and without the probe connected

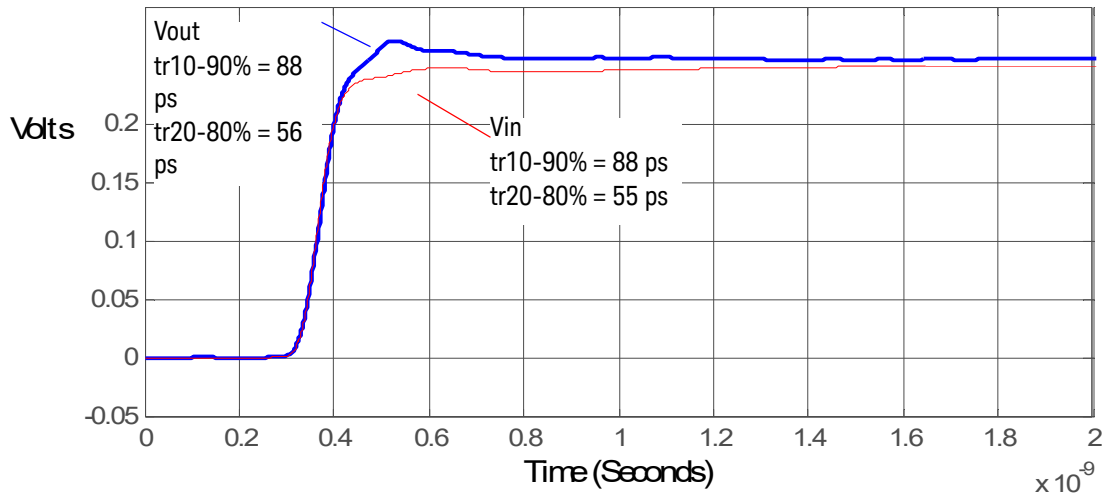

Figure 156 Vin and Vout of probe with a 25Ω 71 ps step generator

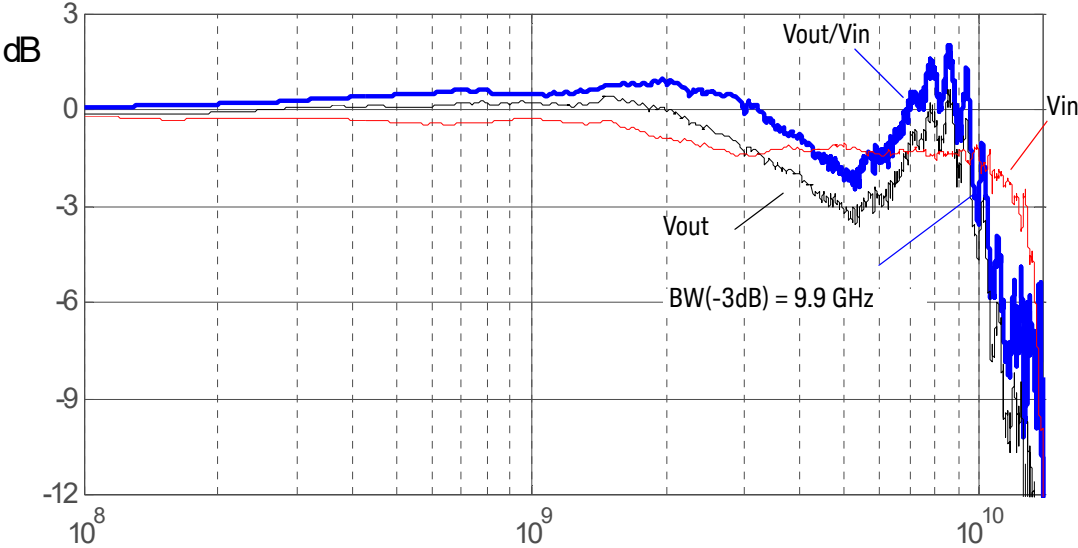

Figure 157 dB(Vin) and dB(Vout) + 10.8 dB of probe with a 25Ω source and dB(Vout/Vin) + 10.8 dB frequency response

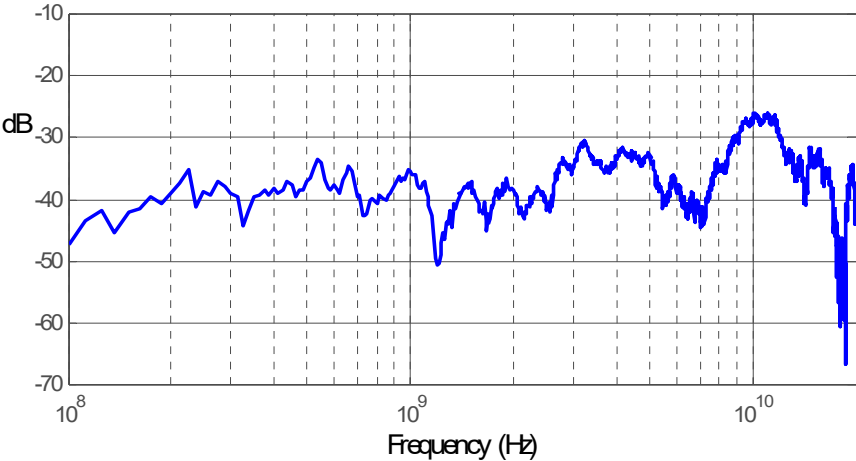

Figure 158 dB(Vout/Vin) + 10.8 dB frequency response when inputs driven in common (common mode rejection)

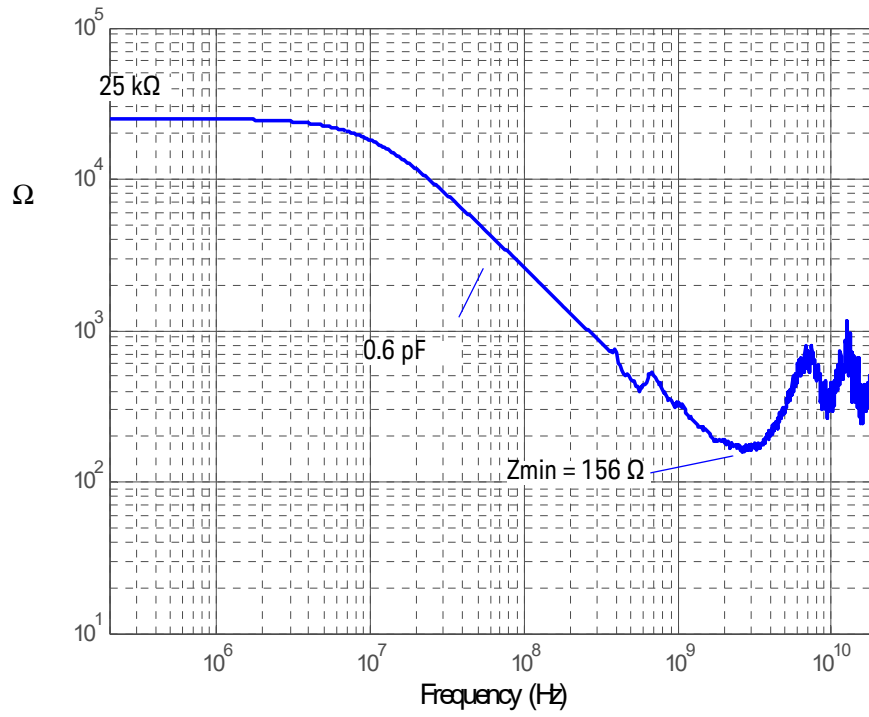

Figure 159 Magnitude plot of probe input impedance versus frequency (single ended mode input)

7 mm Leads with 60° Separation

The following graphs are for 7 mm long leads with 60° separation between the resistor leads.

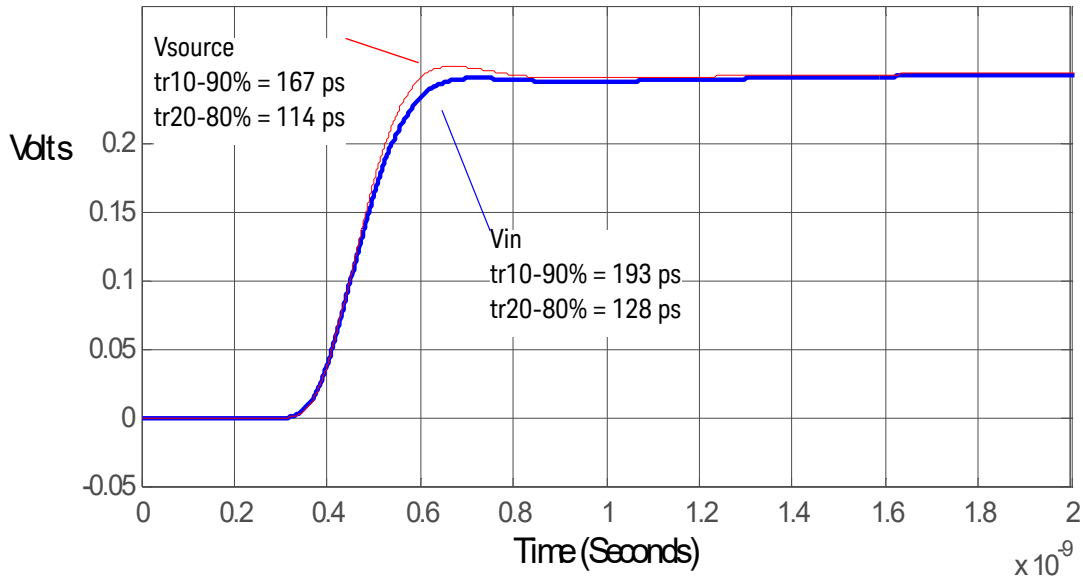

Figure 160 25Ω 167 ps step generator with and without the probe connected

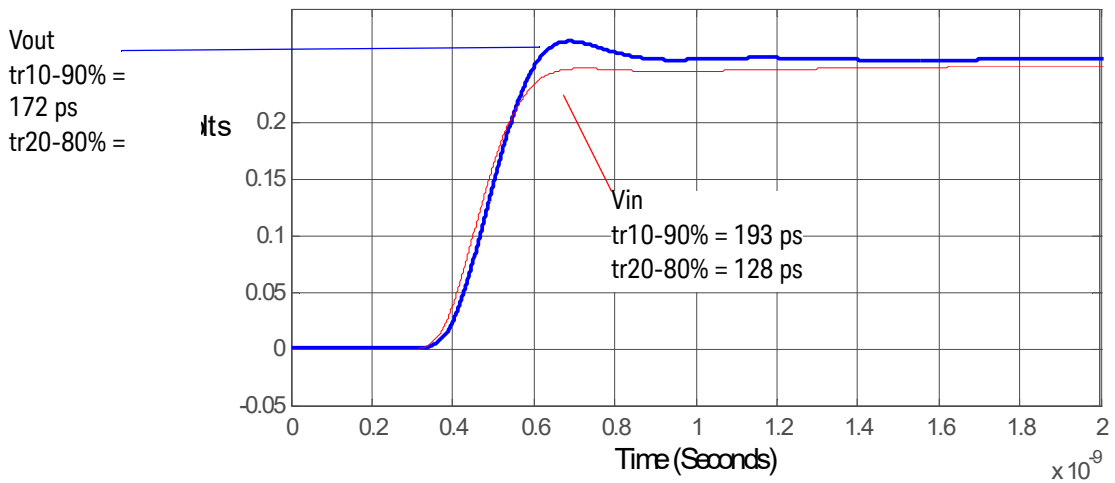

Figure 161 Vout and Vin of probe with a 25Ω 167 ps step generator

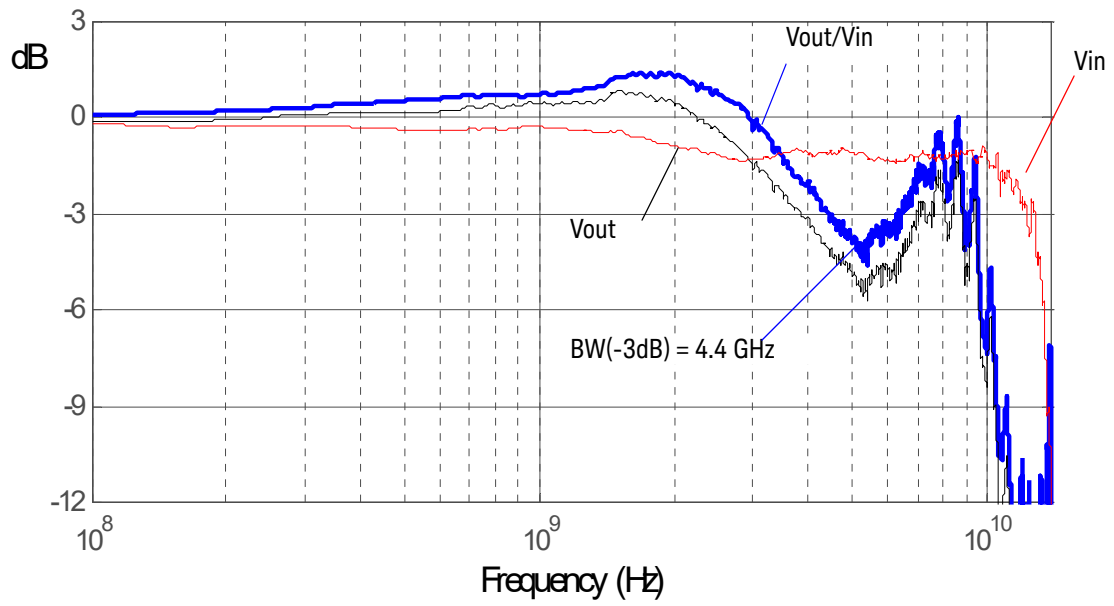

Figure 162 dB(Vin) and dB(Vout) + 10.8 dB of probe with a 25Ω source and dB(Vout/Vin) + 10.8 dB frequency response

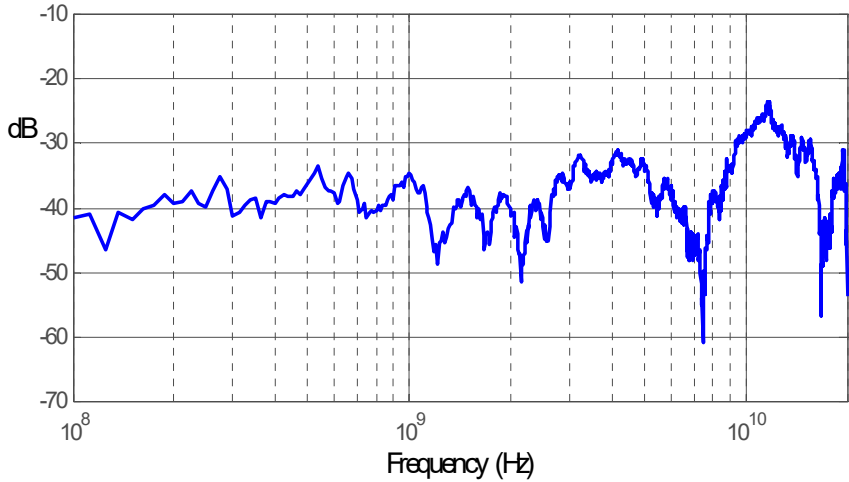

Figure 163 dB(Vout/Vin) + 10.8 dB frequency response when inputs driven in common (common mode rejection).

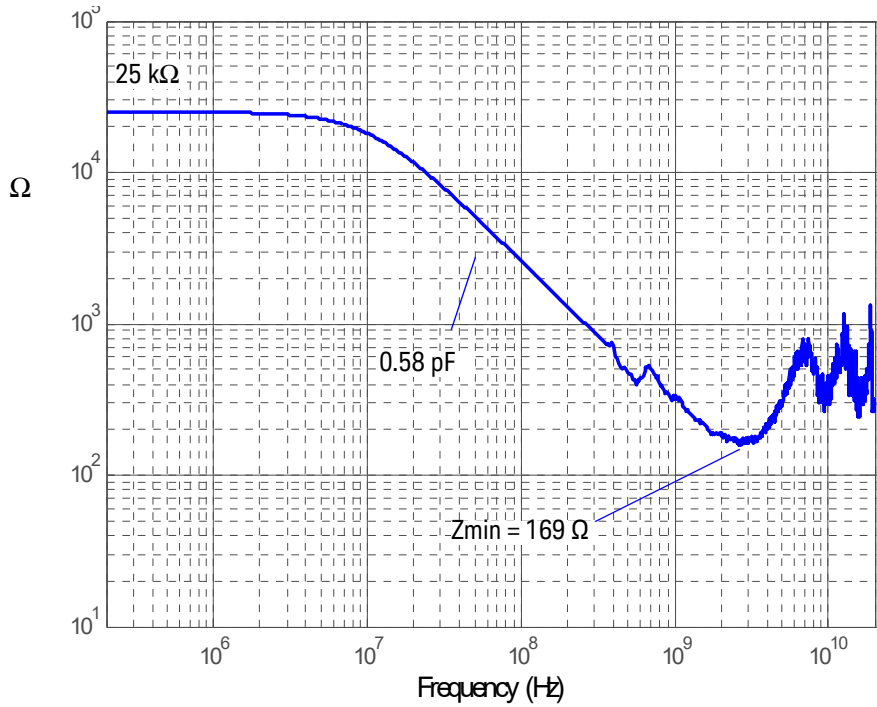

Figure 164 Magnitude plot of probe input impedance versus frequency (single-ended mode input)

11 mm Leads with 0° Separation

The following graphs are for 11 mm long leads with 0° separation between the resistor leads.

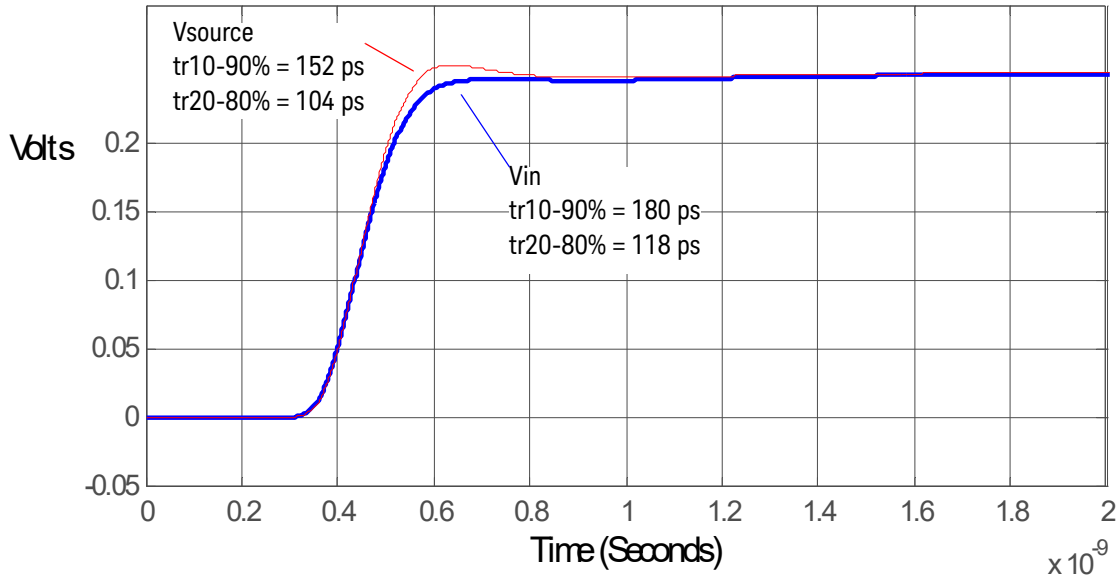

Figure 165 25Ω 152 ps step generator with and without the probe connected

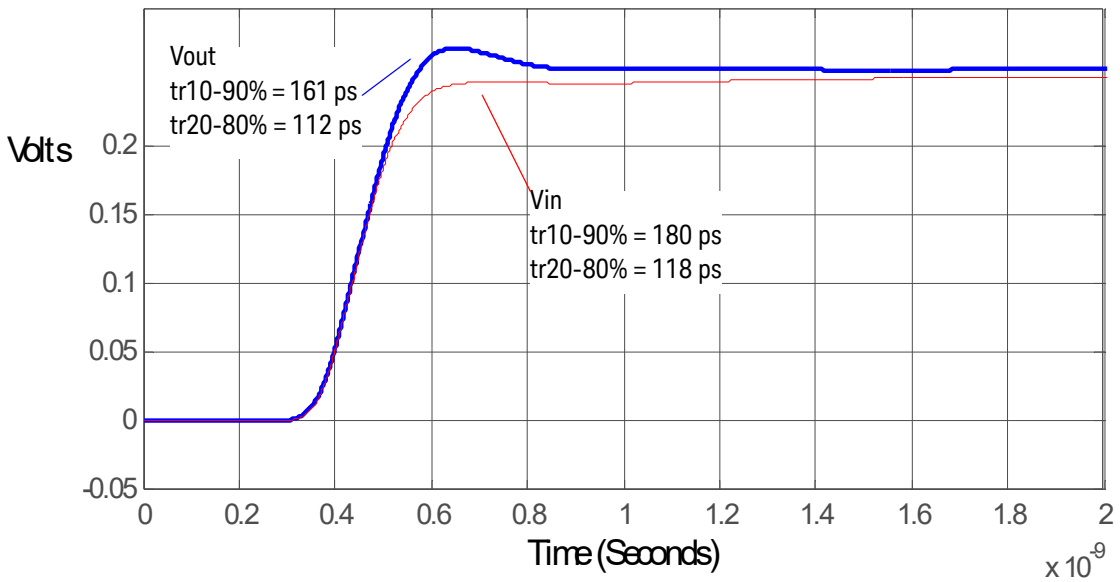

Figure 166 Vin and Vout of probe with a 25Ω 152 ps step generator

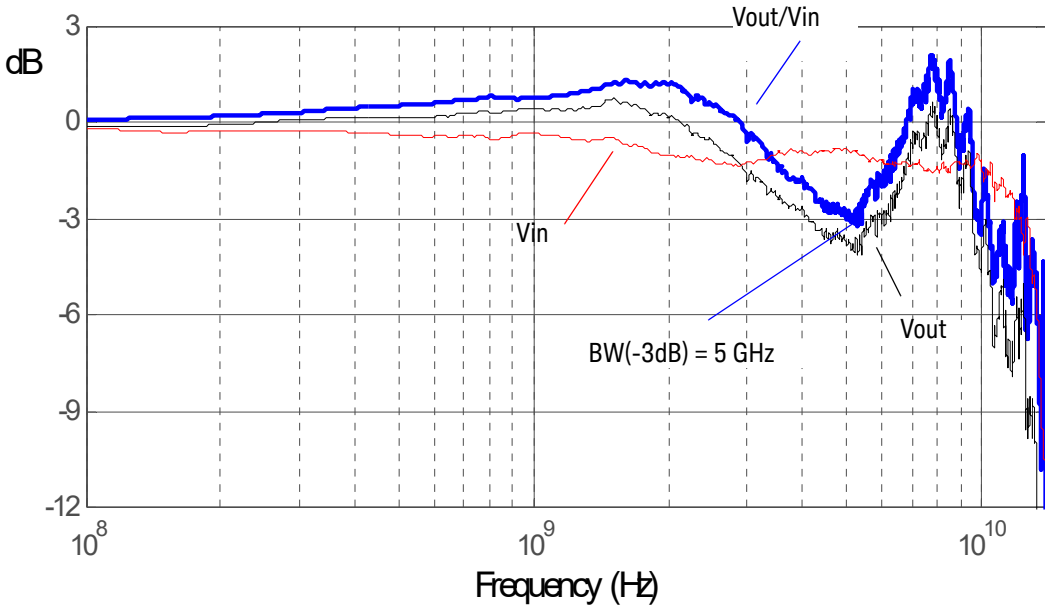

Figure 167 dB(Vin) and dB(Vout) + 10.8 dB of probe with a 25Ω source and dB(Vout/Vin) + 10.8 dB frequency response

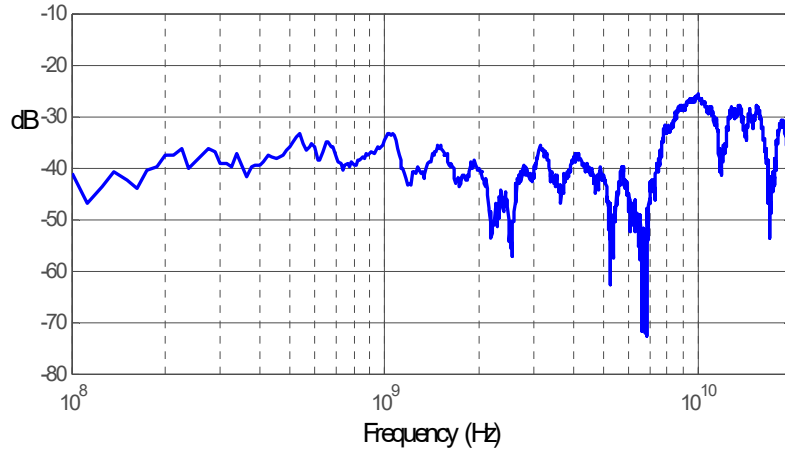

Figure 168 dB(Vout/Vin) + 10.8 dB frequency response when inputs driven in common (common mode rejection)

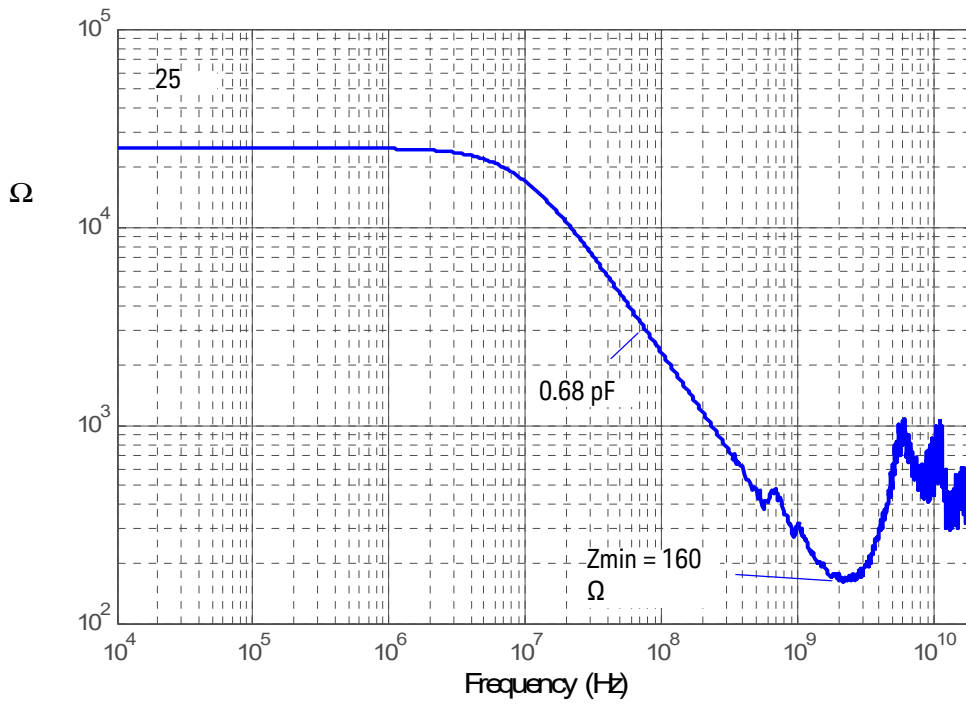

Figure 169 Magnitude plot of probe input impedance versus frequency (single-ended mode input)

11 mm Leads with 60° Separation

The following graphs are for 11 mm long leads with 60° separation between the resistor leads.

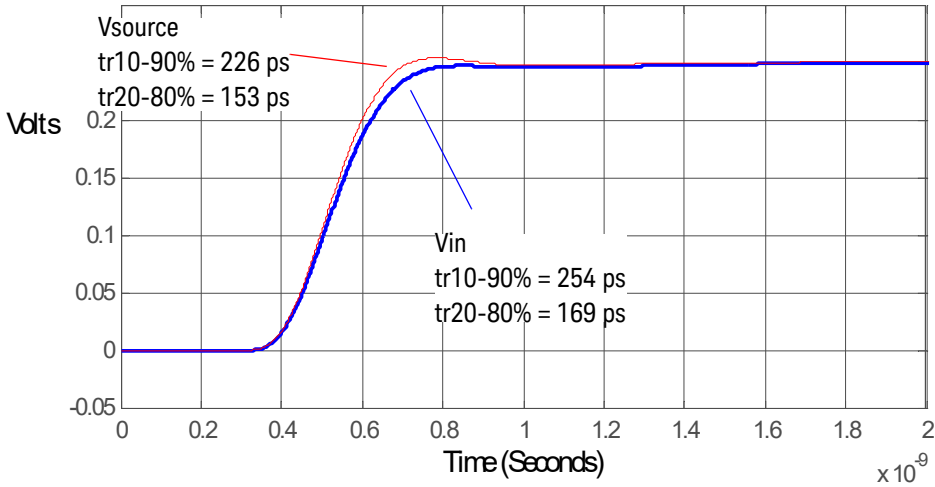

Figure 170 25Ω 226 ps step generator with and without the probe connected

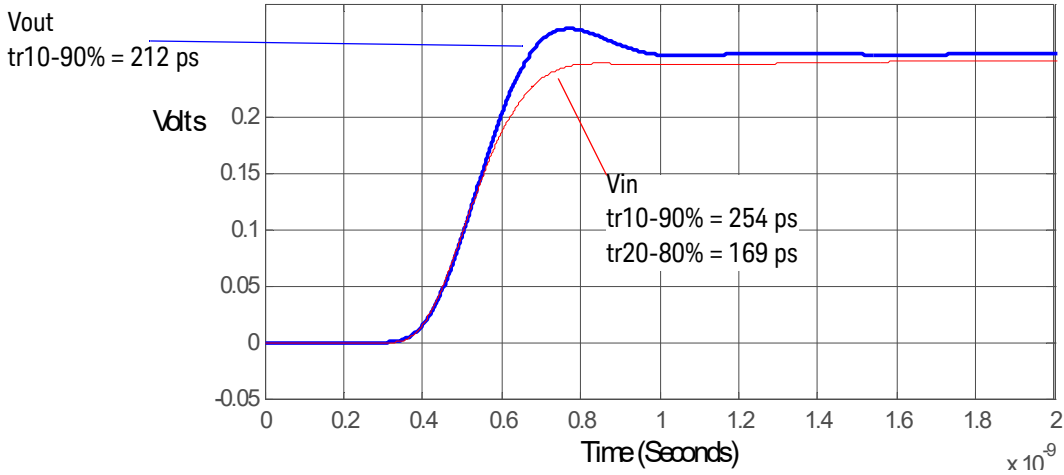

Figure 171 V_{in} and V_{out} of probe with a 25Ω 226 ps step generator

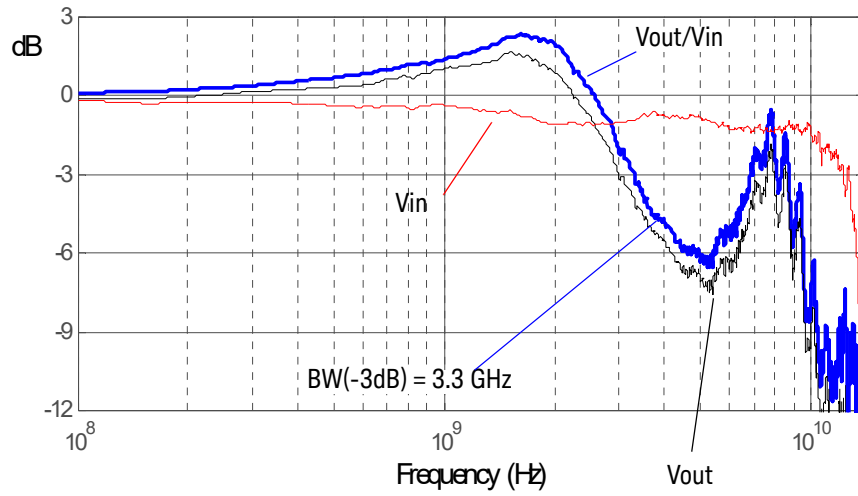

Figure 172 dB(Vin) and dB(Vout) + 10.8 dB of probe with a 25Ω source and dB(Vout/Vin) + 10.8 dB frequency response

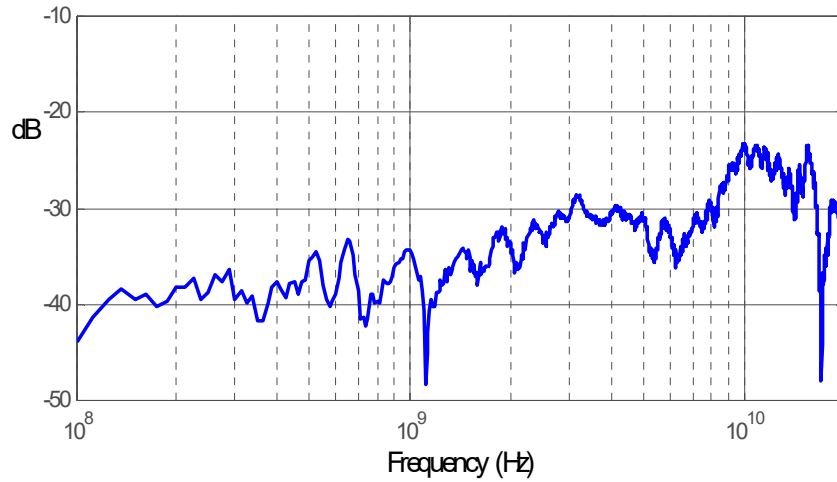

Figure 173 dB(Vout/Vin) + 10.8 dB frequency response when inputs driven in common (common mode rejection)

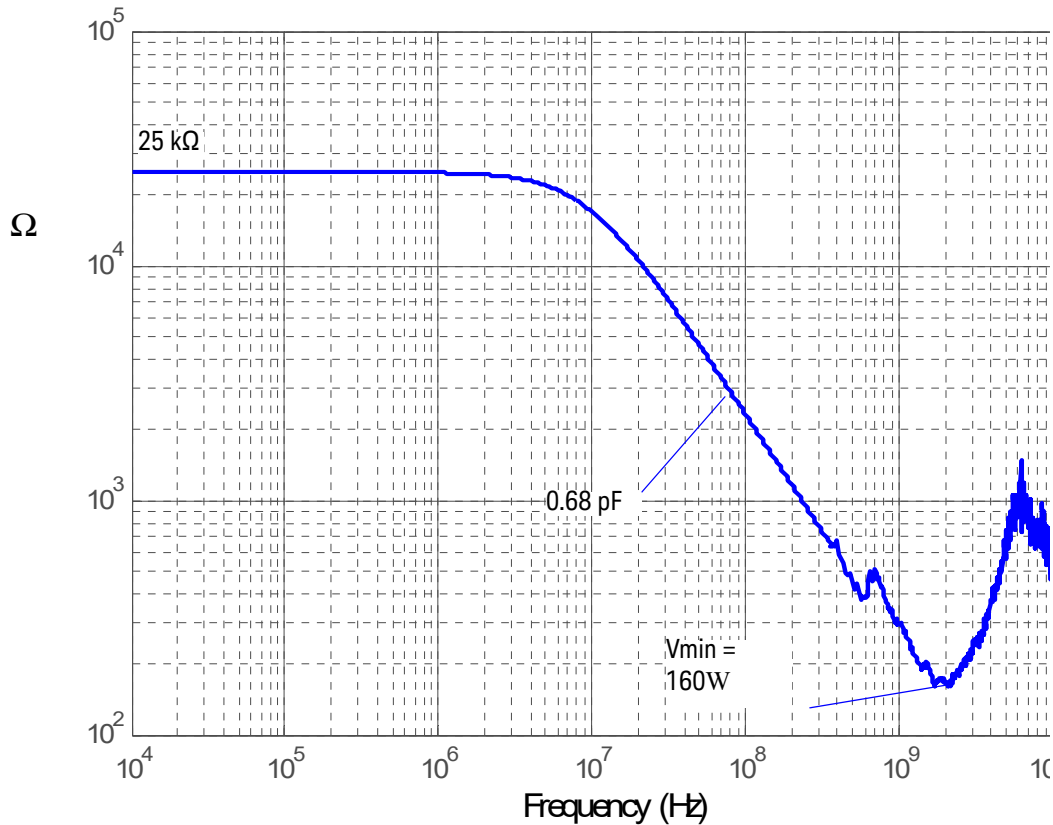

Figure 174 Magnitude plot of probe input impedance versus frequency (single-ended mode input)

N5426A ZIF Probe Tip Impedance

The impedance plot shown in **Figure 175** is of the ZIF probe tip without the probe head connected.

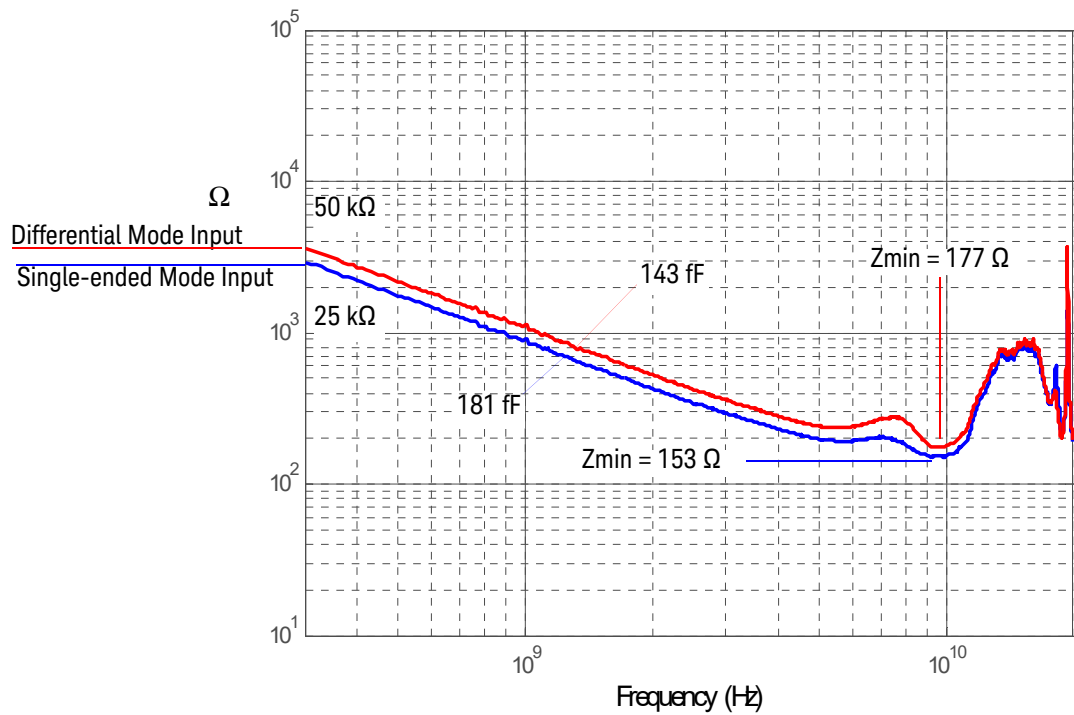

Figure 175 Magnitude plot of accessory input impedance versus frequency.

N2851A QuickTip Head with N2849A QuickTip

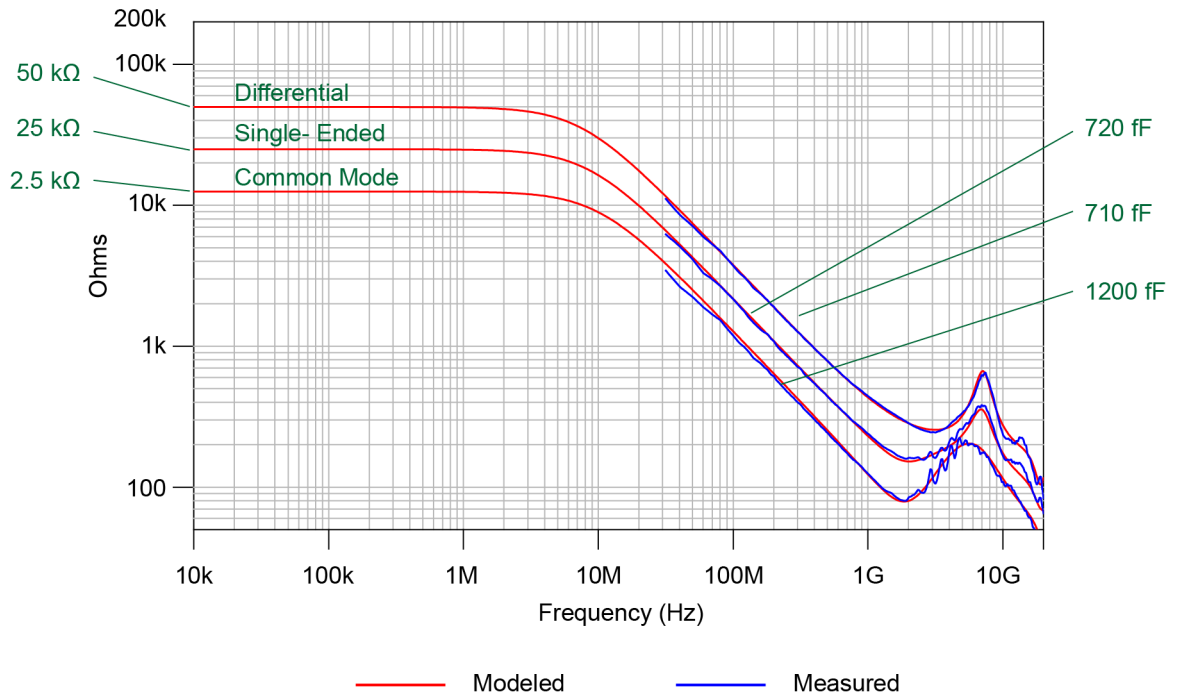

Figure 176 Input Impedances (Modeled and Measured)

E2675B Differential Browser

The following performance characteristic plots are for the 1169B probe using E2675B probe head.

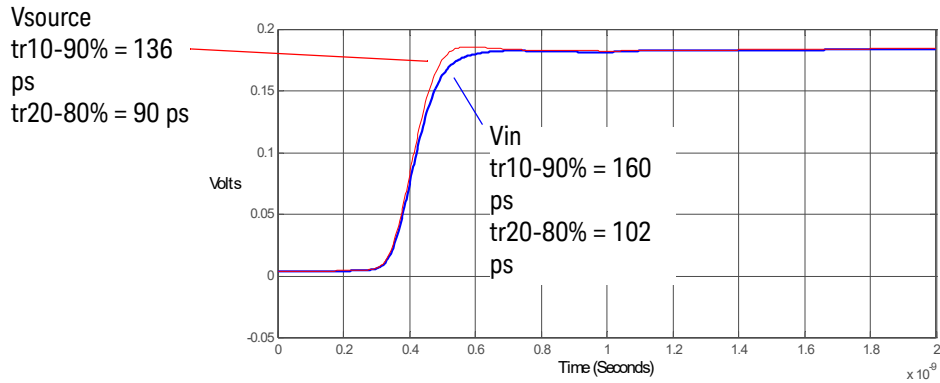

Figure 177 25Ω 136 ps step generator with and without probe connected

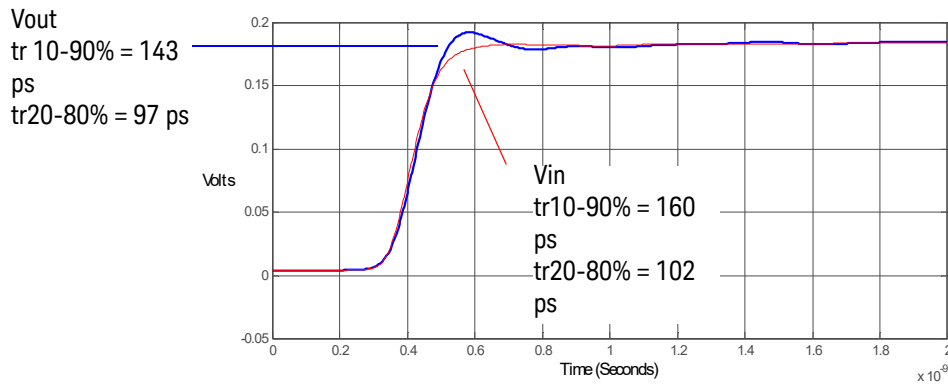

Figure 178 Vin and Vout of probe with a 25Ω 136 ps step generator

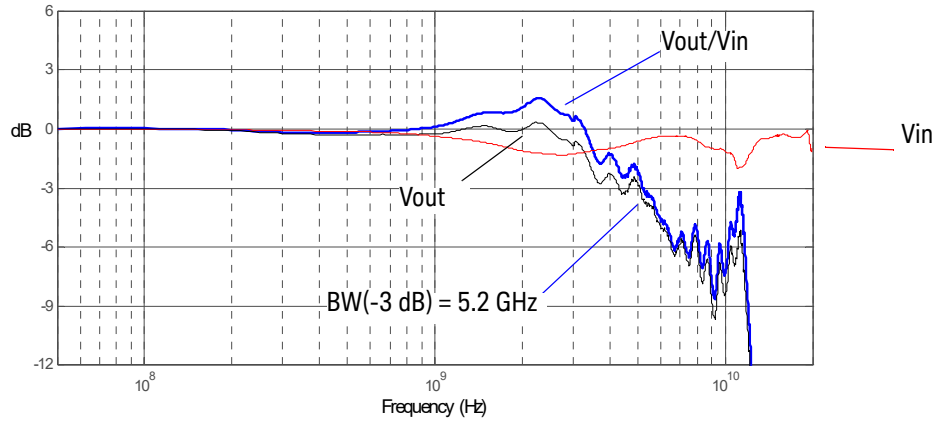

Figure 179 dB(V_{in}) and dB(V_{out}) + 10.8 dB of probe with a 25 Ω source and dB(V_{out}/V_{in}) + 10.8 dB frequency response

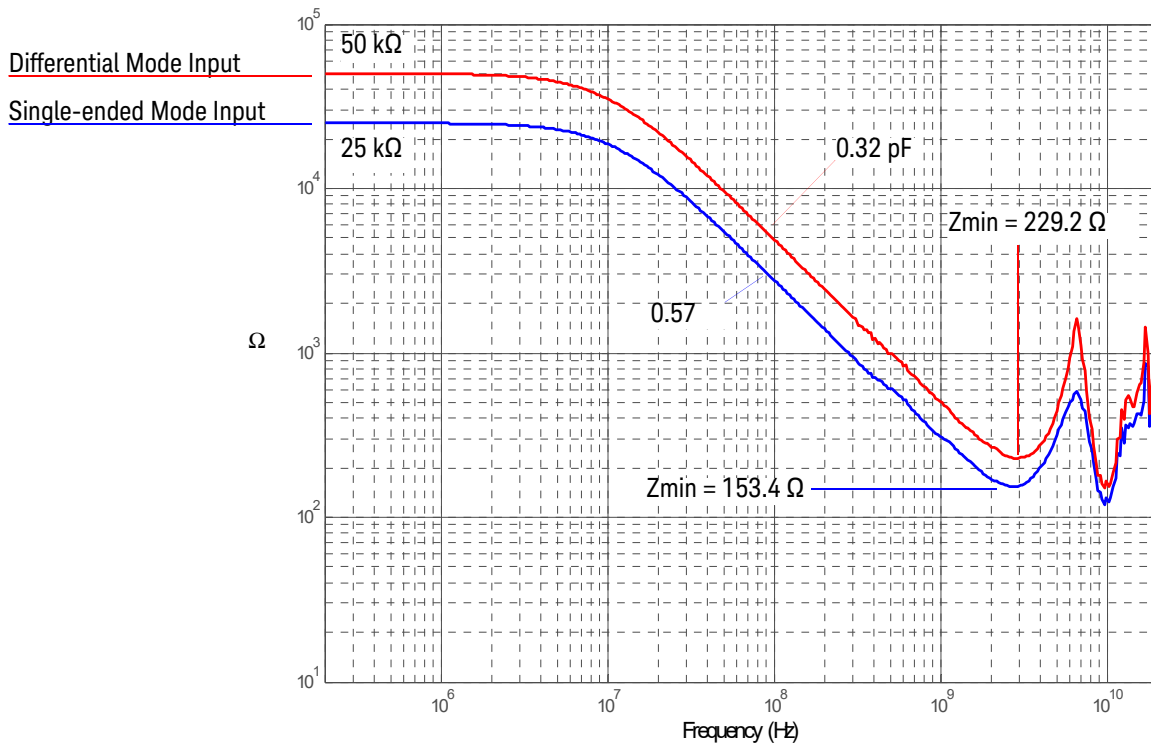

Figure 180 Magnitude plot of probe input impedance versus frequency

E2676B Single-Ended Browser

The following performance characteristic plots are for the 1169B probe using E2676B probe head.

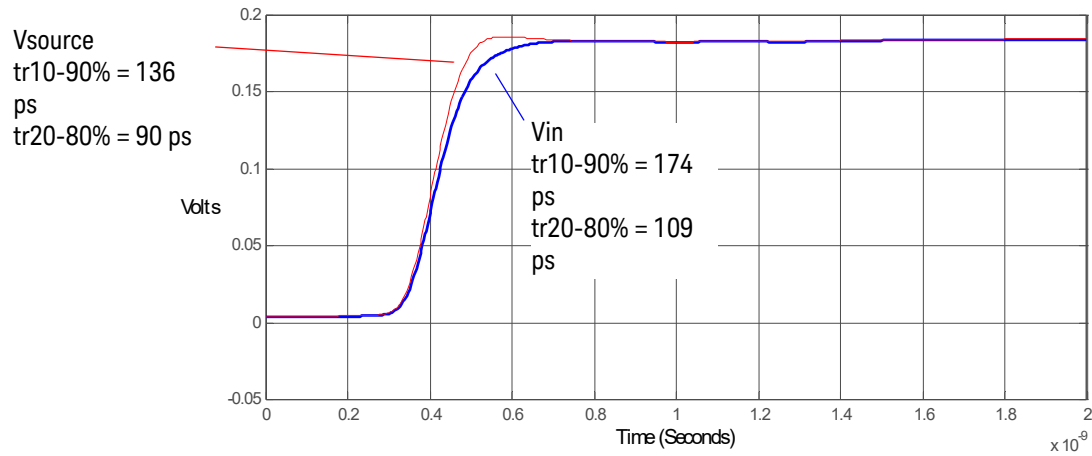

Figure 181 25Ω 100 ps step generator with and without probe connected

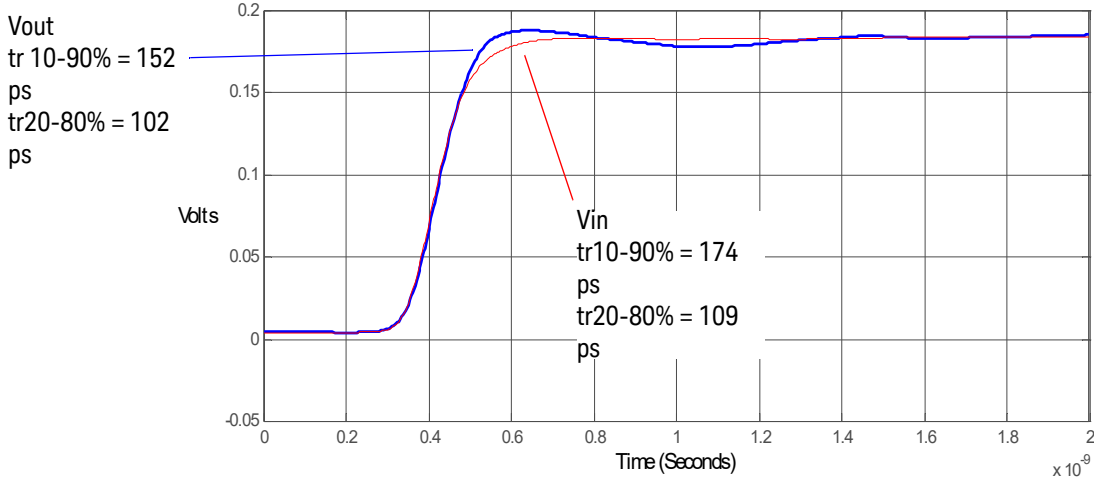

Figure 182 Vin and Vout of probe with a 25Ω 100 ps step generator

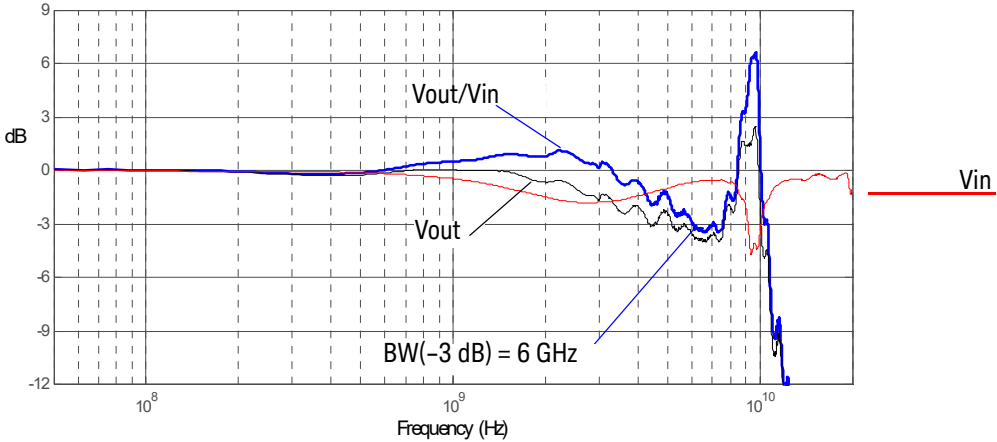

Figure 183 dB(Vin) and dB(Vout) + 10.8 dB of probe with a 25Ω source and dB(Vout/Vin) + 10.8 dB frequency response

NOTE

The ground inductance and structure of the E2676B Single-ended Browser causes a resonant peak at ~10 GHz. This probe head was designed for the 1134B 7 GHz probe system. The input signal should be limited to an equivalent bandwidth of about 4.2 GHz (110 ps, 10 - 90%) to prevent ringing at 10 GHz.

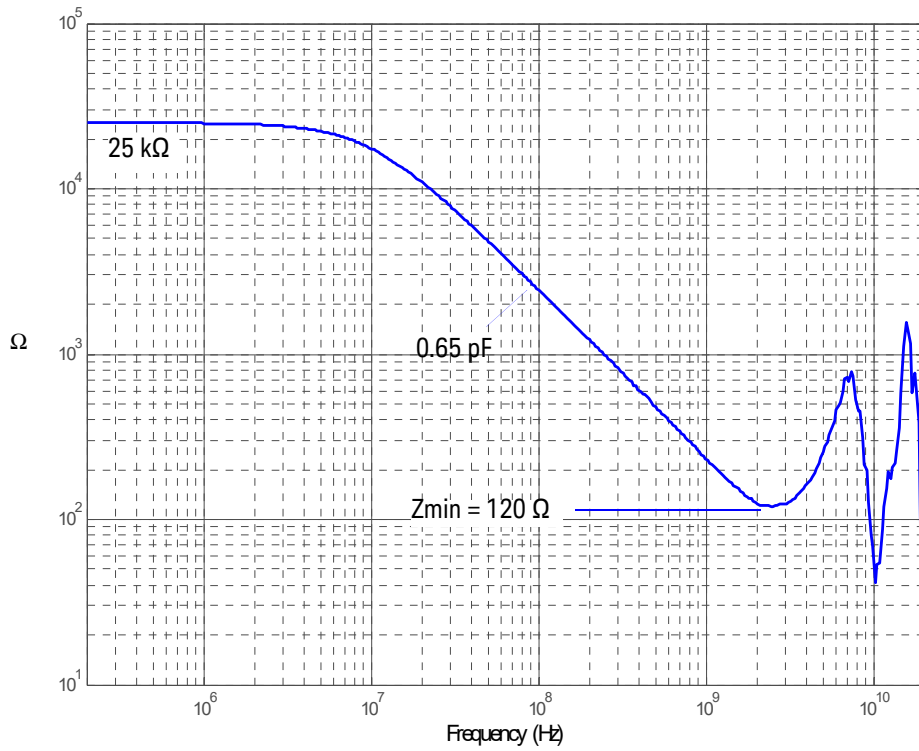

Figure 184 Magnitude plot of probe input impedance versus frequency

E2677B Differential Solder-in Probe Head (High BW)

The following performance characteristic plots are for the 1169B probe using E2677B probe head.

NOTE

For solder-in applications, the N5381B probe head is preferred. Variations in the manufacture and positioning of the mini-axial lead resistors used with the E2677B cause variations in the response. If you must use the E2677B, ensure that the mini-axial lead resistors are positioned directly adjacent to each other and touching.

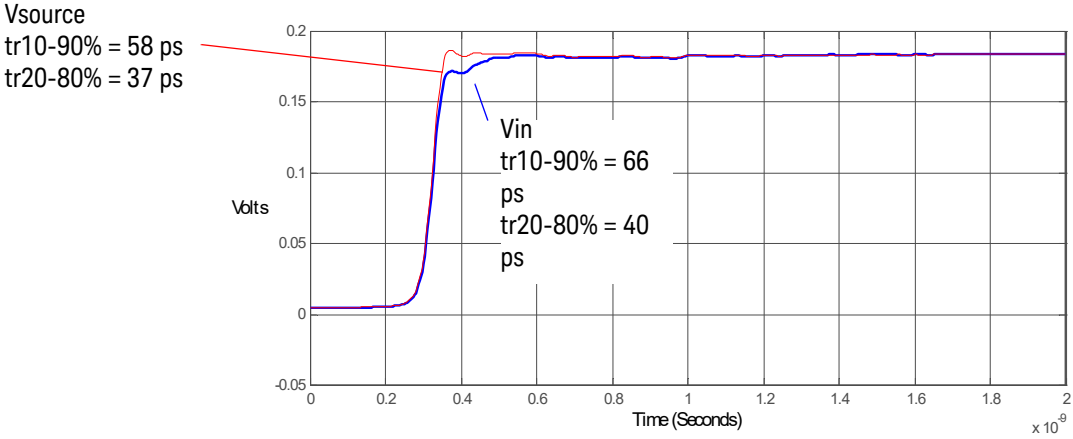

Figure 185 25Ω 58 ps step generator with and without probe connected

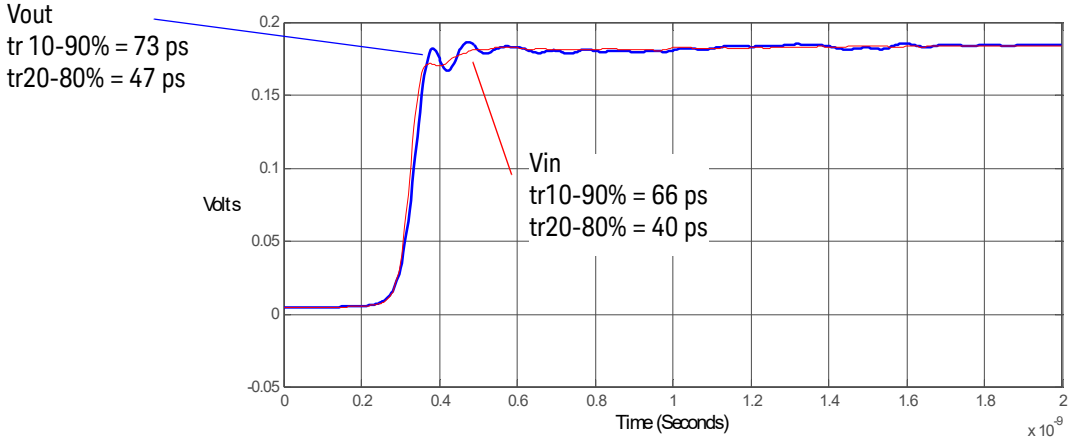

Figure 186 Vin and Vout of probe with a 25Ω 58 ps step generator

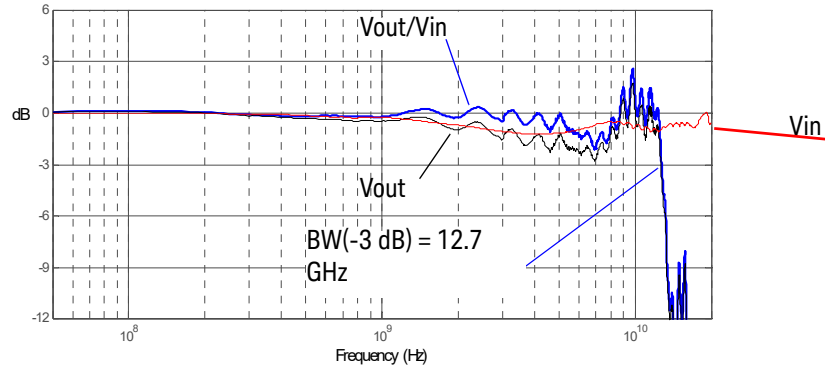

Figure 187 dB(Vin) and dB(Vout) + 10.8 dB of probe with a 25Ω source and dB(Vout/Vin) + 10.8 dB frequency response

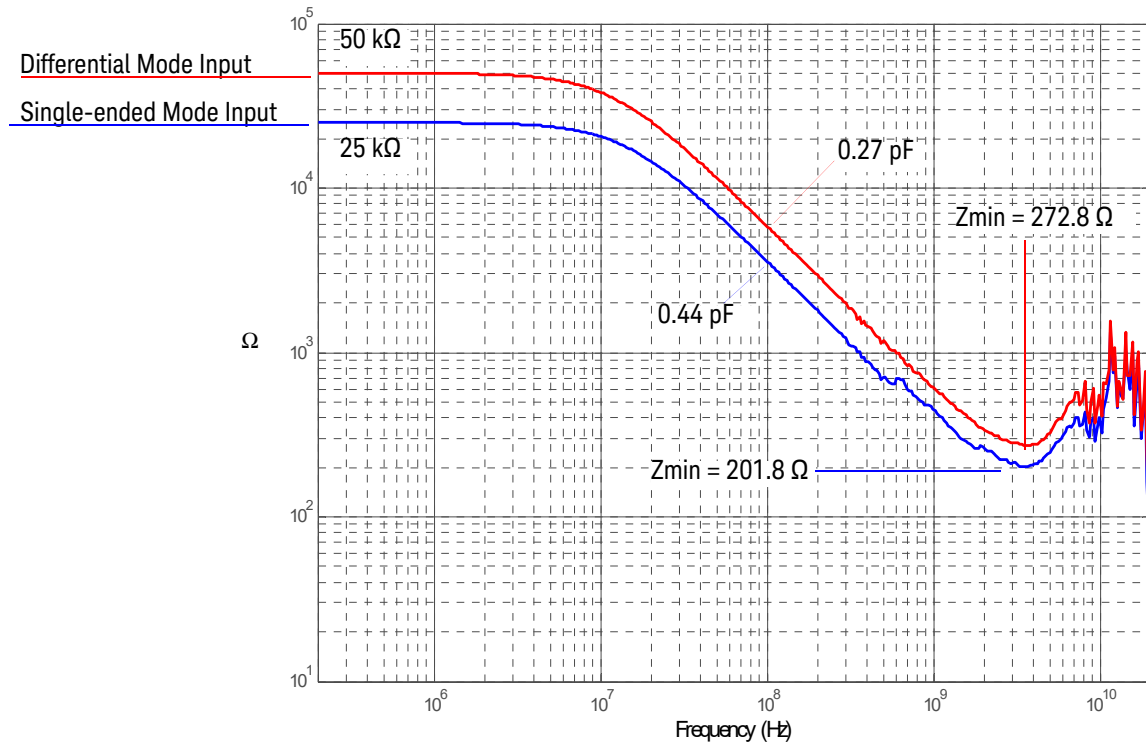

Figure 188 Magnitude plot of probe input impedance versus frequency

E2678B Differential Socketed Probe Head (High BW)

The following performance characteristic plots are for the 1169B probe using E2678B probe head.

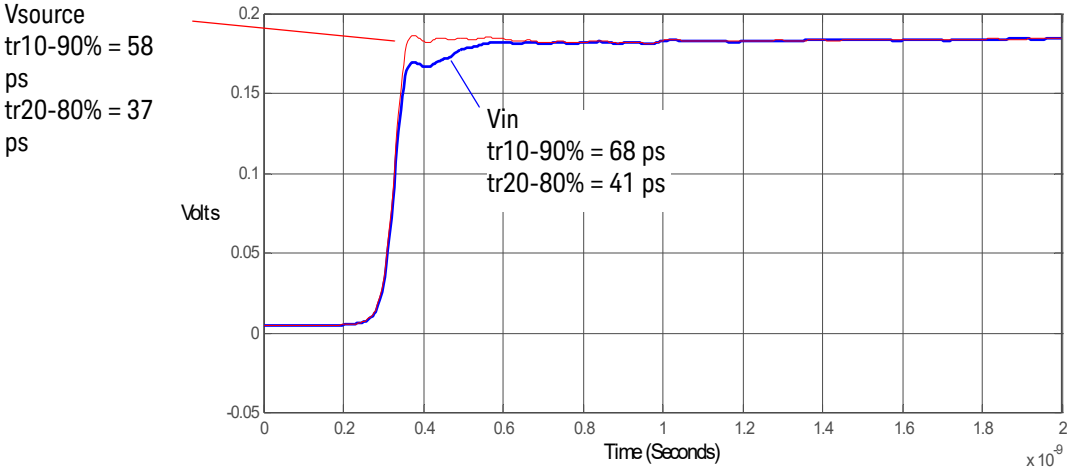

Figure 189 25Ω 58 ps step generator with and without probe connected

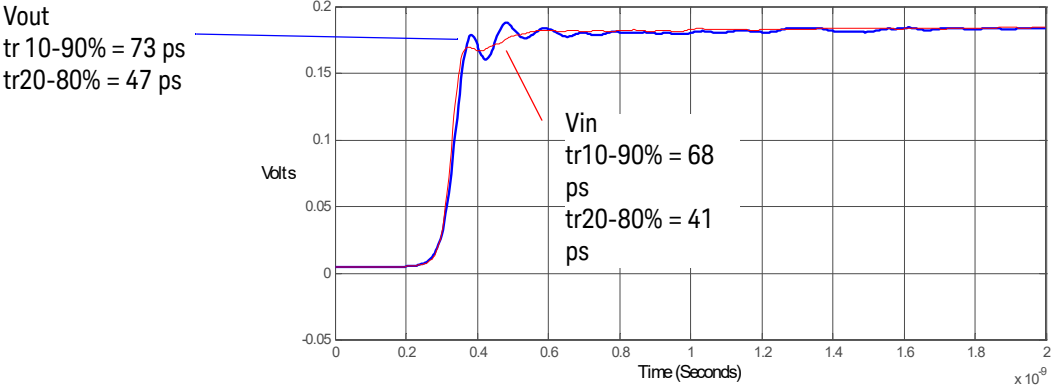

Figure 190 Vin and Vout of probe with a 25Ω 58 ps step generator

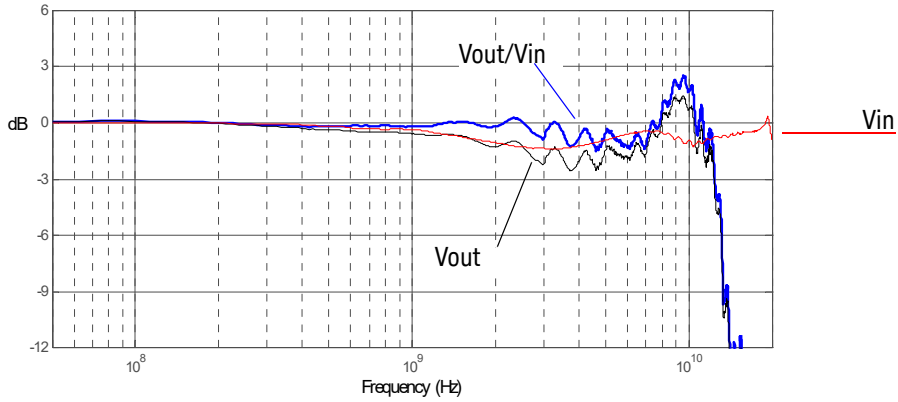

Figure 191 dB(Vin) and dB(Vout) + 10.8 dB of probe with a 25Ω source and dB(Vout/Vin) + 10.8 dB frequency response

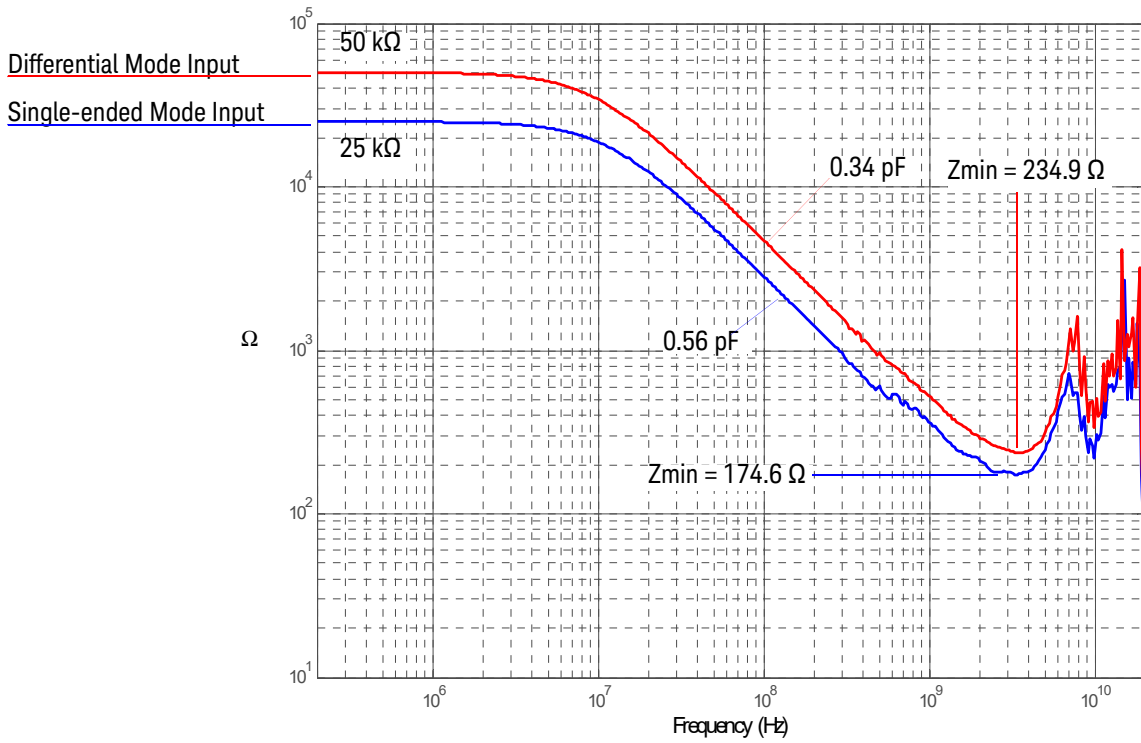

Figure 192 Magnitude plot of probe input impedance versus frequency

E2678B Differential Socketed Probe Head w/ Damped Wire

The following performance characteristic plots are for the 1169B probe using E2678B probe head with the damped wire accessory.

NOTE

Due to reflections on the long wire accessories, signals being probed should be limited to ~ 240 ps rise time measured at the 10% and 90% amplitude levels. This is equivalent to ~ 1.5 GHz bandwidth.

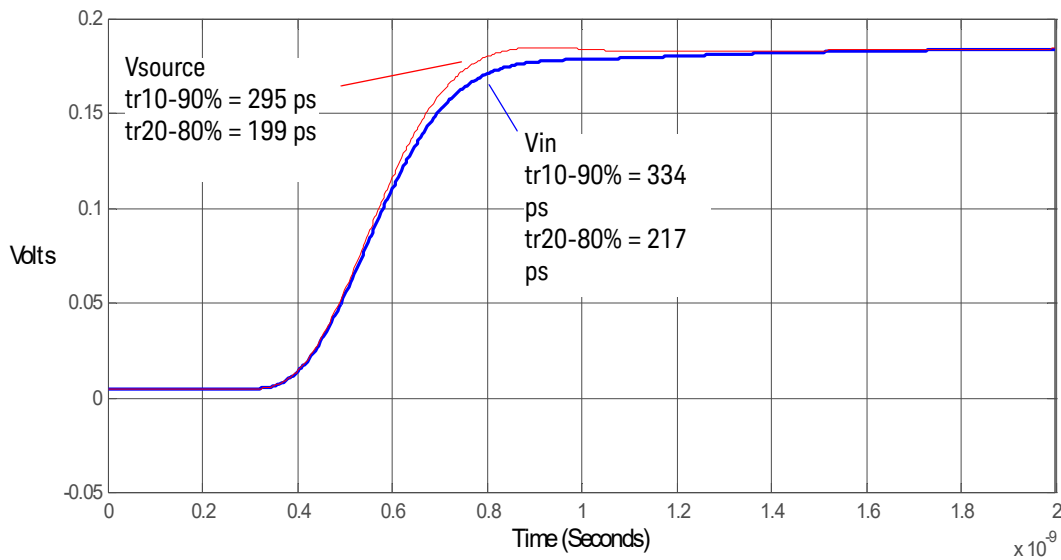

Figure 193 25Ω 295 ps step generator with and without probe connected

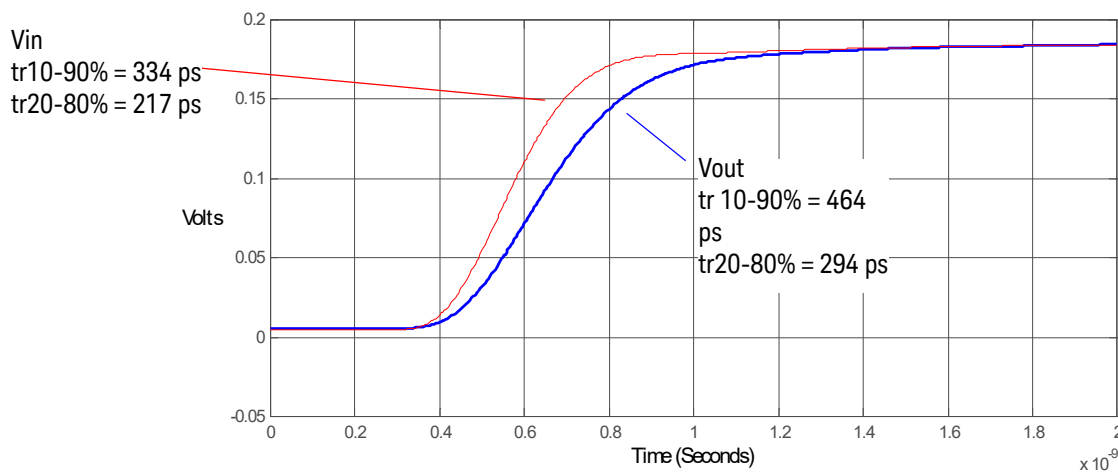

Figure 194 Vin and Vout of probe with a 25Ω 295 ps step generator

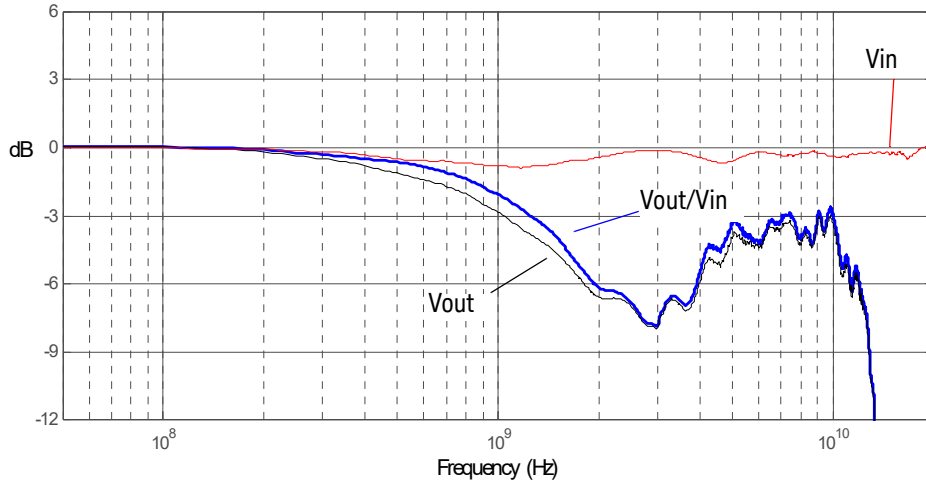

Figure 195 dB(Vin) and dB(Vout) + 10.8 dB of probe with a 25Ω source and dB(Vout/Vin) + 10.8 dB frequency response

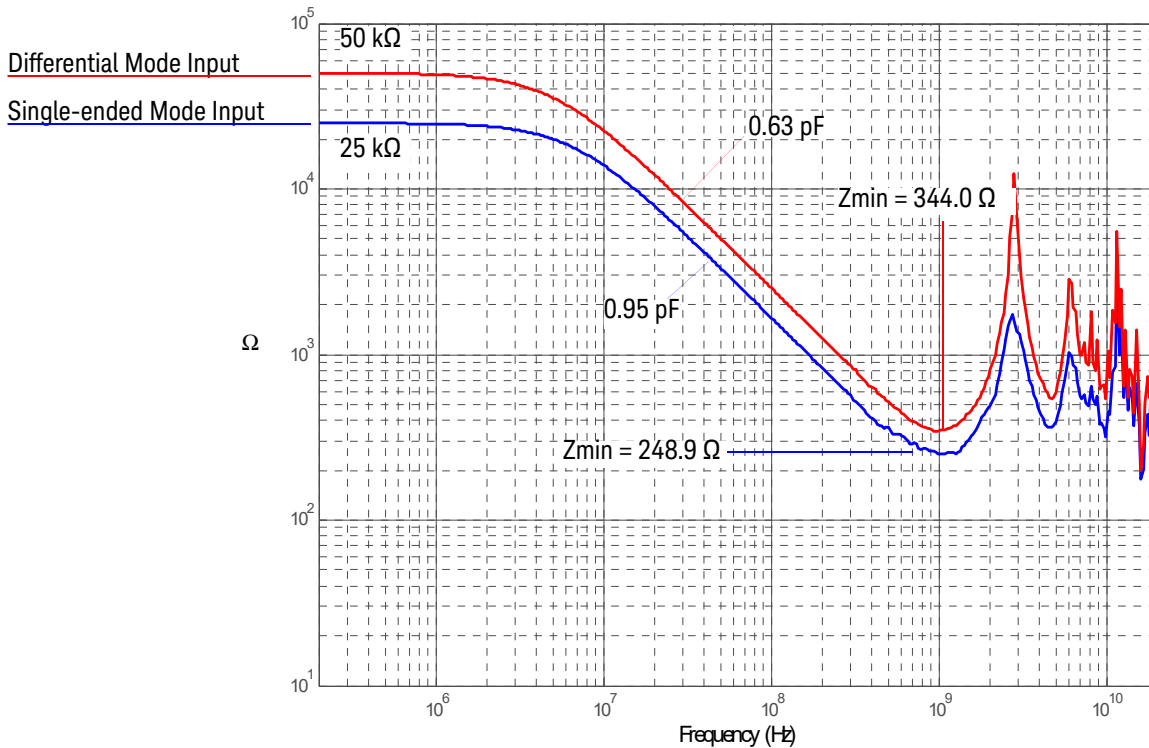

Figure 196 Magnitude plot of probe input impedance versus frequency

E2679B Single-Ended Solder-In Probe Head (High BW)

The following performance characteristic plots are for the 1169B probe using E2679B probe head.

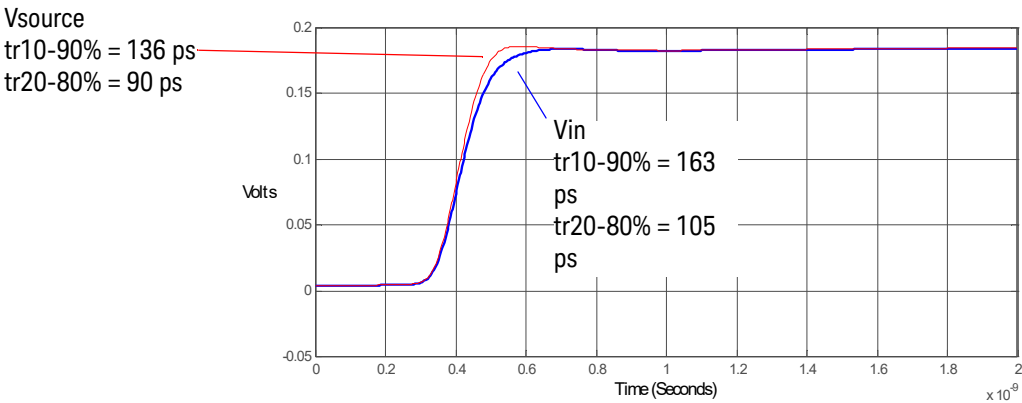

Figure 197 25Ω 136 ps step generator with and without probe connected

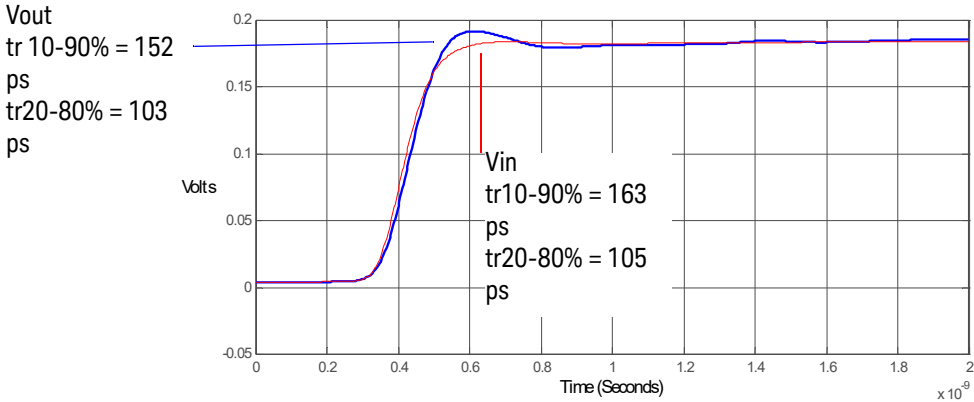

Figure 198 Vin and Vout of probe with a 25Ω 136 ps step generator

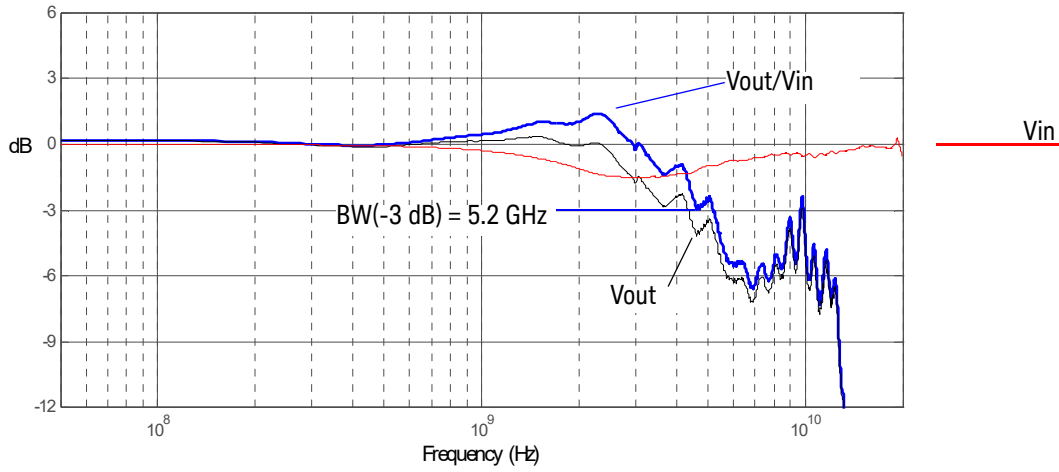

Figure 199 dB(Vin) and dB(Vout) + 10.8 dB of probe with a 25Ω source and dB(Vout/Vin) + 10.8 dB frequency response

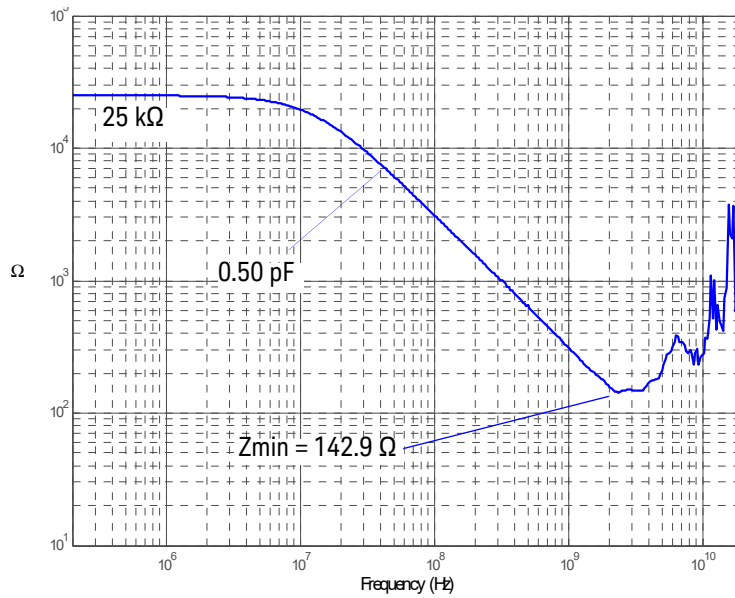

Figure 200 Magnitude plot of probe input impedance versus frequency

N2887A/N2888A Soft Touch Probe Heads

The following performance characteristic plots are for the 1169B probe using N2887/8A probe heads.

To properly interpret these plots, it is important to define what *differential* and *single-ended* means for these probe heads, as shown in **Figure 201**. Note that the single-ended configuration is not a differential probe probing a single-ended signal, but rather is a single-ended probe probing a single-ended signal.

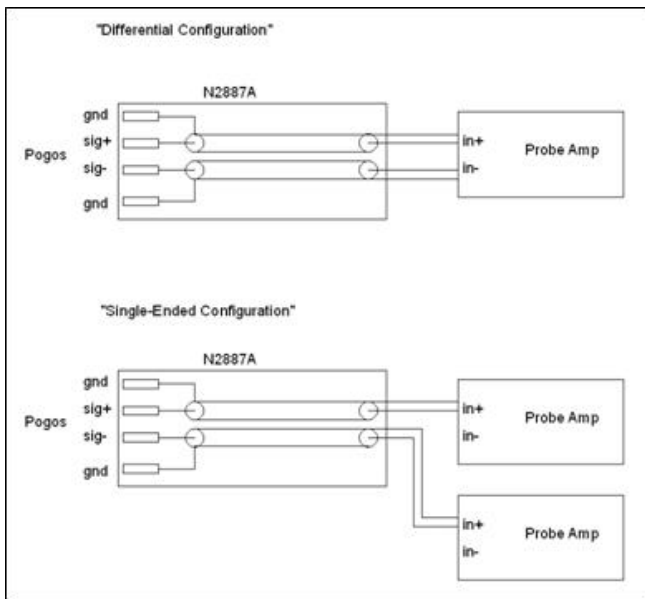

Figure 201 Differential and Single-ended Configurations

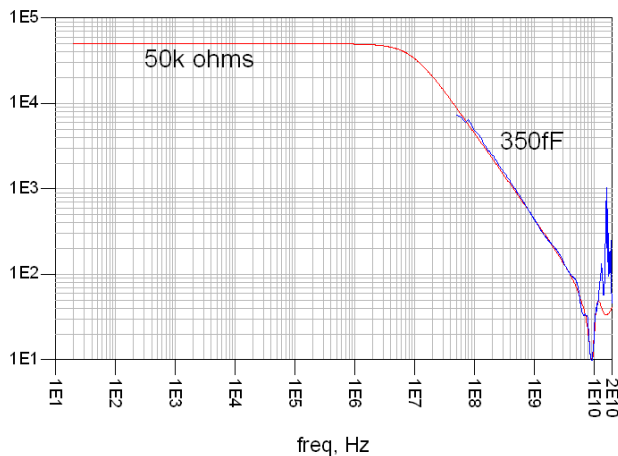

Figure 202 Differential input impedance (red = model, blue = measured)

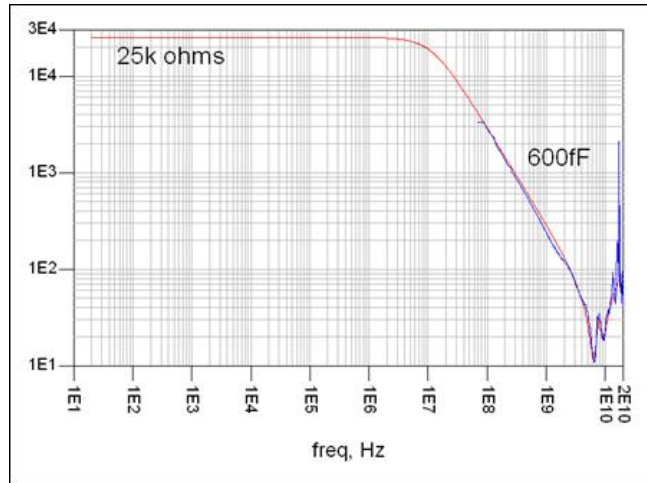

Figure 203 Single-ended input impedance (red = model, blue = measured)

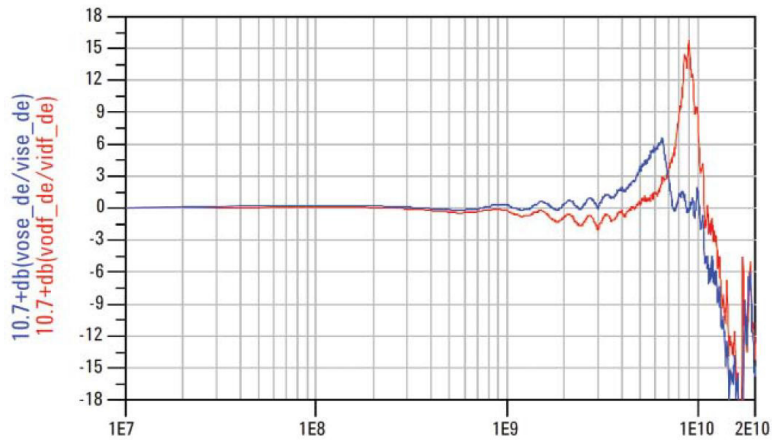

Figure 204 Frequency response, N2887A with an 1169B 12 GHz amplifier (red = differential, blue = single-ended)

7 Performance Verification

To Test Bandwidth	206
To Test Input Resistance	215
Performance Test Record	219

This chapter describes how to verify the bandwidth and input resistance performance of the probe.

CAUTION

Electrostatic discharge (ESD) can quickly and imperceptibly damage or destroy high performance probes, resulting in costly repairs. Always wear a wrist strap when handling probe components and ensure that cables are discharged before being connected.

NOTE

Allow the probe to warm up for at least 20 minutes.





To Test Bandwidth

This test ensures that the probe meets its specified bandwidth.

Table 29 Bandwidth

Probe	Specification
1169B	12 GHz
1168B	10 GHz

Table 30 Required Test Equipment

Test Equipment	Critical Specification	Model Number
Vector Network Analyzer (VNA)	13 GHz sweep range full 2 port cal Option 1D5	Keysight 8720ES 
Calibration Standards	No Substitute	Keysight 85052D
External Power Supply	No Substitute	Keysight 1143A 
AutoProbe Interface Adapter	No Substitute	Keysight N1022A/B 
Outside thread 3.5 mm (male) to 3.5 mm (female) adapter	No Substitute	Keysight 5062-1247
Cable (2)	3.5 mil; SMA; High Quality	Keysight 8120-4948
Cable	1.5 mil Probe Power Extension No Substitute	Keysight 01143-61602
PV/DS Test Board	No Substitute (In E2655C Kit)	Keysight E2655-66503 

Using the 8720ES VNA successfully

To test bandwidth, follow these guidelines when using the Vector Network Analyzer.

- Sometimes it may take a few seconds for the waveforms to settle completely. Allow time for waveforms to settle before continuing.
- Make sure all connections are tight and secure. If needed, use a vise to hold the cables and test board stable while making measurements.

- Be careful not to cross thread or force any connectors. This could be a very costly error to correct.

Procedure

- 1 Turn on the 8720ES VNA and let warm up for 20 minutes.
- 2 Press the green **[Preset]** key on the 8720ES VNA.
- 3 On the VNA, press the **[Power]** key and set the power to 0 dBm.
- 4 On the VNA, press the **[AVG]** key and then select the **Averaging Factor** screen key. Set averaging to 4.
- 5 On the VNA, press the **[Sweep Setup]** key and then press the **sweep type menu** screen key. Select the **log freq** screen key.
- 6 Connect the probe under test to the Auto Probe Adapter and power the probe using the 1143A power supply **Figure 205** on page 207. Install the outside thread adapter to the Auto Probe Adapter.

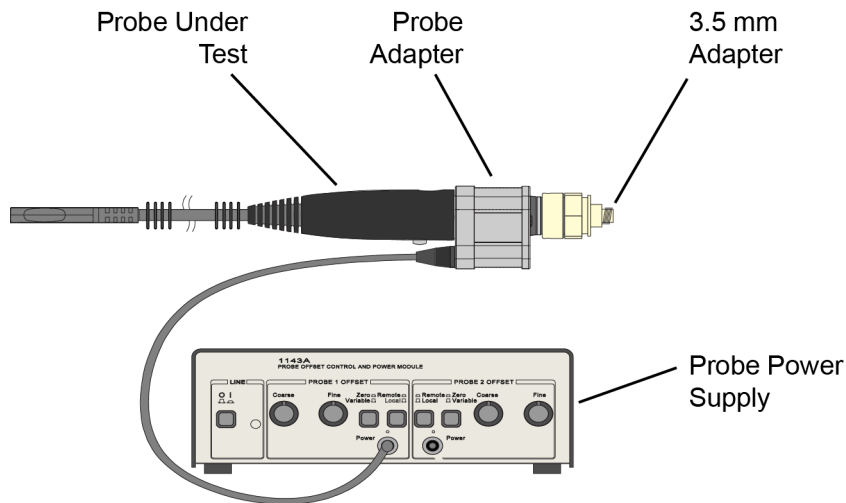

Figure 205 Probe Connected to Power Supply

Calibrating a Reference Plane

To get a reliable measurement from the VNA you must calibrate a reference plane so that the VNA knows where the probe under test is located along the transmission line.

- 7 On the VNA, press the **[Cal]** key.
- 8 Press the **cal menu** screen key.
- 9 Press the **full 2 port** screen key.
- 10 Connect one of the high quality SMA cables to port one and to the pincher side of PV/DS test board as shown in **Figure 206** on page 208.

- 11 The calibration reference plane is at the other end of PV/DS test board.
- 12 Perform a Calibration for the **PORT 1** side of the Reference plane.
 - a Press the **reflection** screen key.
 - b Connect the open end of 85052D Calibration Standard to the non-pincher side of the PV/DS test board.

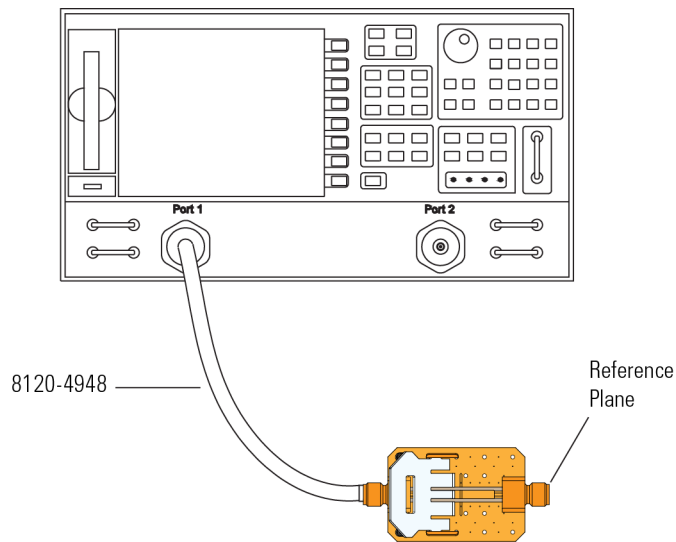

Figure 206 PV/DS Test Board Connected to VNA

- c Select the **open** screen key under the **Forward** group.
 - d Wait until the VNA beeps indicating that it has completed the task.
 - e Connect short end of Calibration Standard to the non-pincher side of the PV/DS test board.
 - f Select **short** screen key under the **Forward** group.
 - g Wait until the VNA beeps indicating that it has completed the task.
 - h Connect load end of Calibration Standard to the non-pincher side of the PV/DS test board.
 - i Select the **loads** screen key under the **Forward** group.
 - j Press **broadband** screen key selection.
 - k Wait until the VNA beeps indicating that it has completed the task.
 - l Press the **done loads** screen key.
 - m You have just calibrated one side of the reference plane.
- 13 Connect the other high quality SMA cable to the VNA's **PORT 2** as shown in **Figure 207**.

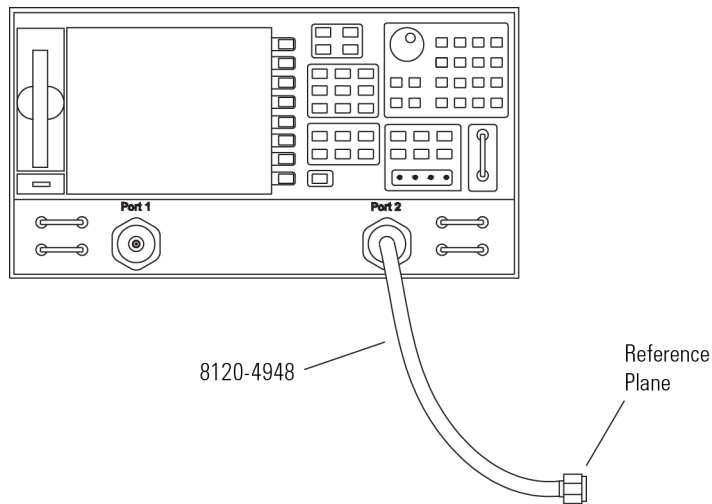

Figure 207 SMA Cable Connected to Port 2

- 14 Get the opposite sex of the Calibration Standards for the next step.
 - a Perform Calibration for the **PORT 2** side of the Reference plane.
 - a Press the **reflection** screen key.
 - b Connect the open end of Calibration Standard to the available end of the **PORT 2** SMA cable.
 - c Select the **open** screen key under the **Reverse** group.
 - d Wait until the VNA beeps indicating that it has completed the task.
 - e Connect short end of Calibration Standard to the available end of the **PORT 2** SMA cable.
 - f Select **short** screen key the **Reverse** group.
 - g Wait until the VNA beeps indicating that it has completed the task.
 - h Connect load end of Calibration Standard to the available end of the **PORT 2** SMA cable.
 - i Select the **loads** screen key the **Reverse** group.
 - j Press **broadband** screen key selection.
 - k Wait until the VNA beeps indicating that it has completed the task.
 - l Press the **done loads** screen key.
 - m You have just calibrated the other side of the reference plane.
- 15 Press **standards done** key.
- 16 Connect port two SMA cable to the non-pincher side of PV/DS test board.

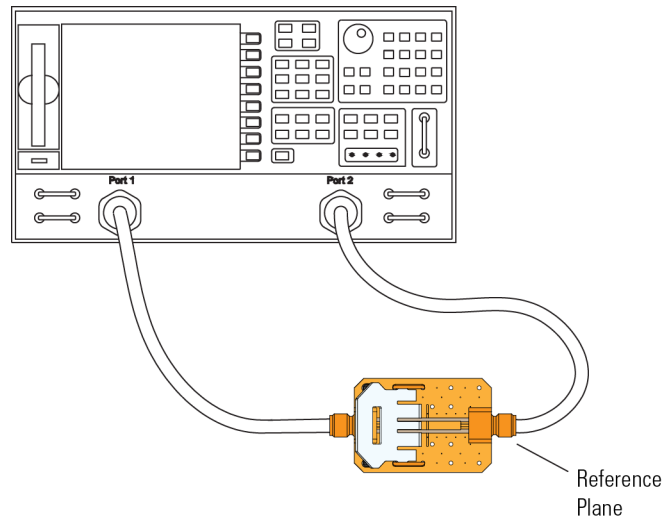

Figure 208 Forward and Reverse Setup

- 17 Press the **transmission** screen key.
- 18 Press the **do both fwd and reverse** screen key.
- 19 Wait until the VNA beeps *four* times indicating that it has completed the task.
- 20 Press the **isolation** screen key.
- 21 Press the **omit isolation** screen key.
- 22 Press **done 2 port cal** screen key.
- 23 Set the VNA's averaging to off.
- 24 Save the reference plane cal by pressing the **[save recall]** key then the **[save state]** key.
- 25 You may change name if you wish.
- 26 Press the **[scale reference]** key. Then set the scale to 1 dB per division and the reference position for 7 divisions.
- 27 Set reference value for 0 dB.
- 28 Press the **[measure]** key.
- 29 Press the **s21** screen key.
- 30 Ensure s21 response on screen is flat (about ± 0.1 dB) out to 13 GHz.

Measuring Vin Response

- 31 Position the probe conveniently to make quality connections on the PV/DS board as shown in **Figure 209**.

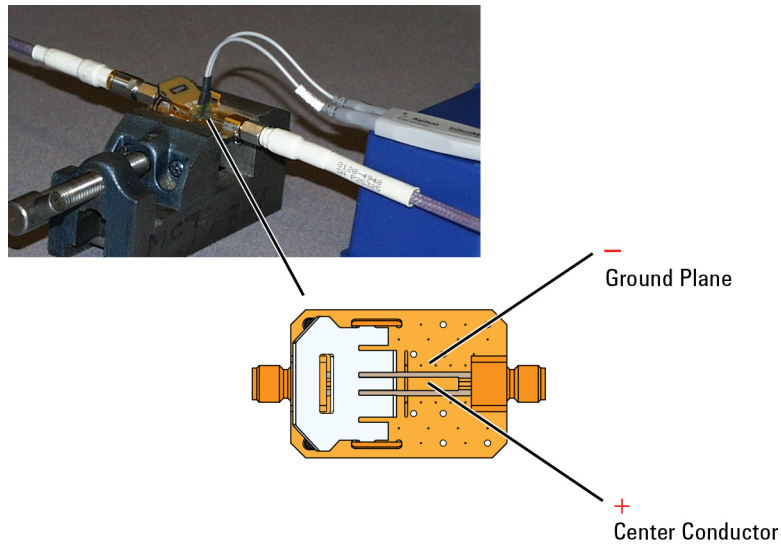

Figure 209 Probing Locations on PV Fixture

- 32** Spread the probe tip wires slightly so that the tips are a little bit wider than the gap between the signal trace and the ground on PV/DS board.

NOTE

To best simulate the conditions that are present when the probe is in actual use, inset only the tips of the wires under the pincher. Do not inset the wires completely under the pincher such that the contact points are right next to the tip of the PC board. The best way to accomplish this is to insert the wires under the pincher with the probe head at a 45° angle with respect to the PV/DS board, then apply upward pressure to the clip to hold the tip wires firmly. Gently pull the probe head up to the 90° position. This will actually form the wires into an "L" shape.

- 33** Place the probe's positive (+) side on center conductor and negative (-) side to ground as shown in the figure.
- 34** Press the **[Sweep Setup]** key on the VNA. Then press the **trigger menu** screen key. Select the **continuous** screen key.
- 35** The V_{in} waveform shown on screen should be similar to that shown in **Figure 210**.

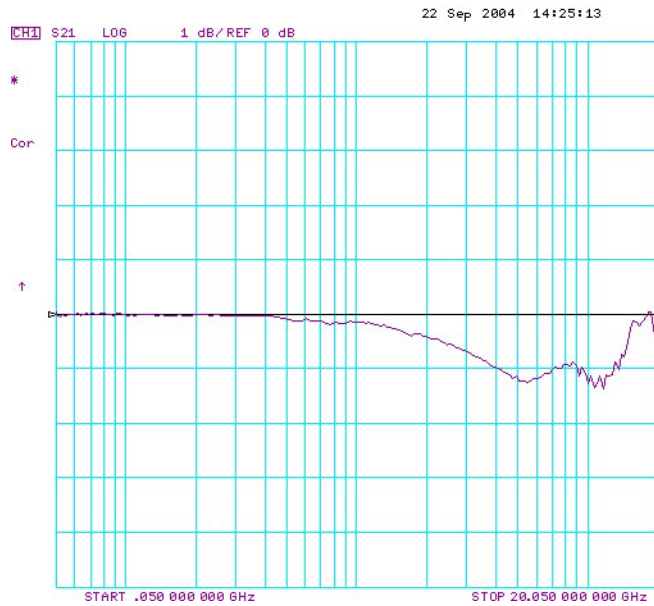

Figure 210 Typical V_{in} Waveform

- 36 Select **[display]** key then **data->memory** screen key.
- 37 You have now saved V_{in} waveform into the VNA's memory for future use.

Measuring V_{out} Response

- 38 Disconnect the **PORT 2** cable from PV/DS test board and attach to probe output on the AutoProbe Adapter.
- 39 Connect the Calibration Standard load to PV/DS test board (non-pincher side) as shown in **Figure 211**.

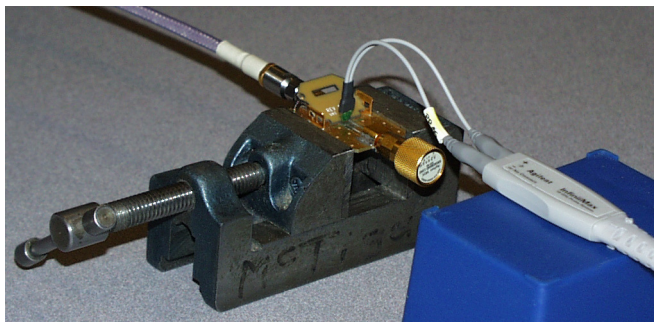

Figure 211 Setup for Measuring V_{out}

- 40 Press **[scale reference]** key on the VNA.
- 41 Set reference value to -10.8 dB.

- 42 The display on screen is V_{out} and it should be similar to that shown in **Figure 212**.

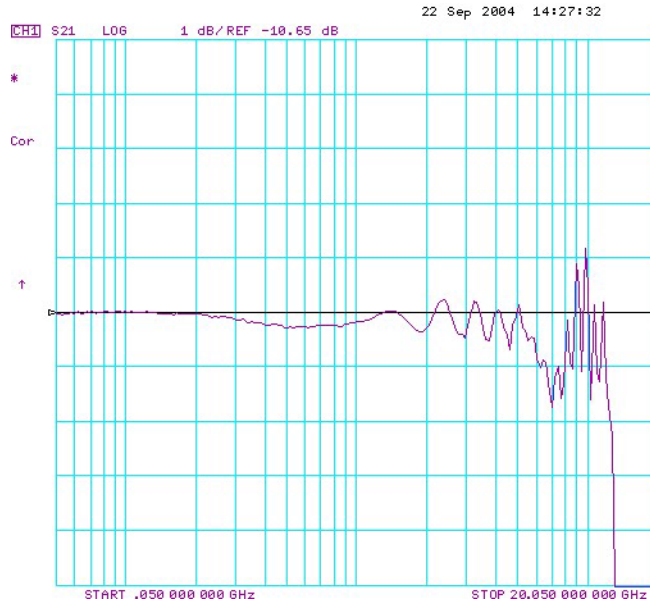

Figure 212 Typical V_{out} Waveform for an 1134B Probe

Displaying V_{out}/V_{in} Response on the VNA

- 43 Press the **[Display]** key.
- 44 Then select the **Data/Memory** screen key. You may need to adjust the **Reference Value**, located under the **Scale Ref** key, slightly to position the waveform at center screen at 100 MHz. The waveform should be similar to that shown in **Figure 213**.

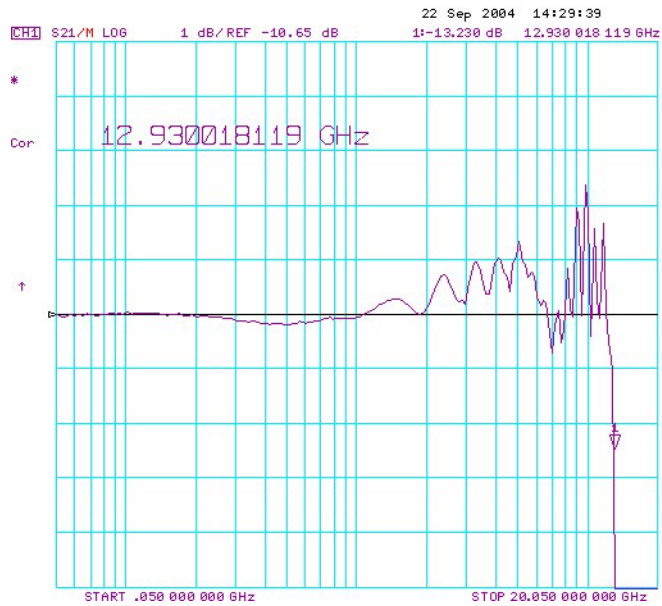

Figure 213 Typical Waveform for an 1134B Probe

- 45 Press marker key and position the marker to the first point that the signal is – 2.6 dB below center screen. Minus 2.6 dB is used rather than –3 dB because the loss caused by the PV/DS board makes a slightly optimistic measurement.
- 46 Read marker frequency measurement and record it in the test record located later in this chapter.
- 47 The bandwidth test passes if the frequency measurement is greater than the probe's bandwidth limit. Record the bandwidth in **Table 33** on page 219.

To Test Input Resistance

This procedure tests that the probe meets its specified input resistance.

Table 31 Input Resistance

Mode	Specification
Differential Mode	50 k Ω \pm 2%
Single-Ended Mode	25 k Ω \pm 2%

Table 32 Required Test Equipment

Test Equipment	Critical Specification	Model Number
Oscilloscope	No substitute. Requires precision BNC connectors	DSO90000 Series Infiniium Oscilloscope
Digital Multimeter	2 wire resistance accuracy > \pm 0.01%	34401A
Adapter	BNC (f) to SMA(m) (In E2655C Kit)	E2655-83201
PV/DS Test Board	No Substitute (In E2655C Kit)	Keysight E2655-66503



Procedure

- 1 Power on the Infiniium oscilloscope and 34401A DMM.
- 2 Connect the probe under test to Channel 1 of the Infiniium oscilloscope.
- 3 Select the 2-wire Ohm display on the 34401A DMM.

Differential Test

- 1 Using the PV/DS test board, connect the positive (+) and negative (-) probe tips to the 34401A DMM.

NOTE

Apply upward pressure to the clip to ensure proper electrical connection.

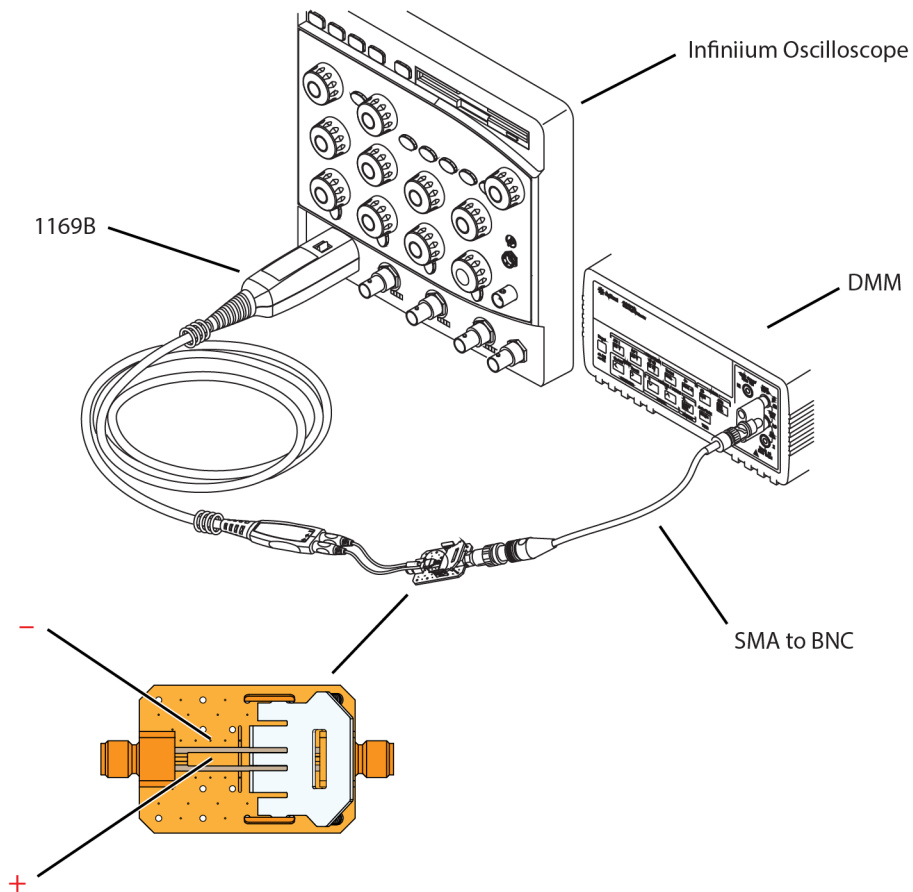

Figure 214 Probing Locations on PV Test Board for Differential Test

- 1 Read the 34401A display for the input resistance.
- 2 Record the result in the performance test record later in this chapter. To pass this test the result should be between 49 k Ω and 51 k Ω .

Single-ended Test

- 1 Using the PV/DS test board, connect the positive (+) probe tip to the 34401A DMM as shown in **Figure 215** on page 217. Connect the probe's amplifier body ground to the PV/DS test board ground.

NOTE

Apply upward pressure to the clip to ensure proper electrical connection.

- 2 Read the 34401A display for the input resistance.
- 3 Record the result in the performance test record later in this chapter. To pass this test the result should be between 24.5 k Ω and 25.5 k Ω .
- 4 Using the PV/DS test board, connect the negative (-) probe trip to the DMM.

NOTE

Apply upward pressure to the clip to ensure proper electrical connection.

- 5 Connect the probe's amplifier body to ground on the PV/DS test board as shown in **Figure 216** on page 218.
- 6 Read the input resistance on the DMM. Record the input resistance in **Table 33** on page 219.

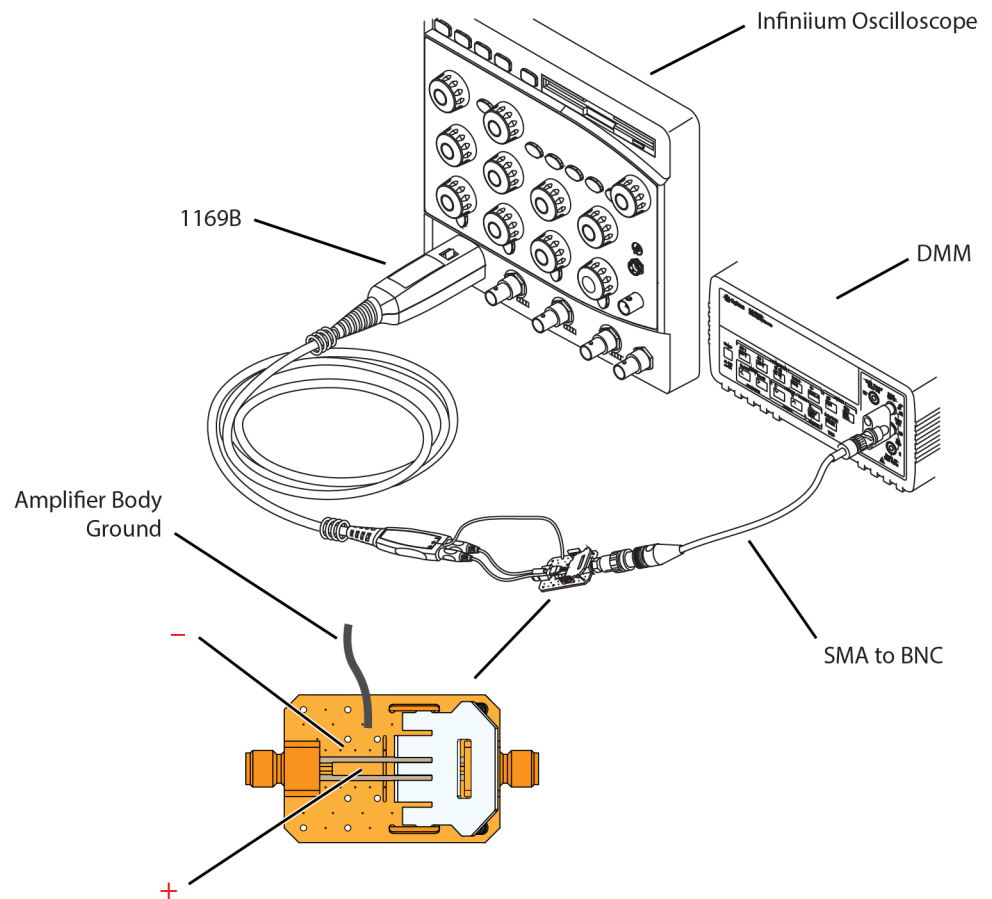

Figure 215 Probing Locations on PV Test Board for Differential Test

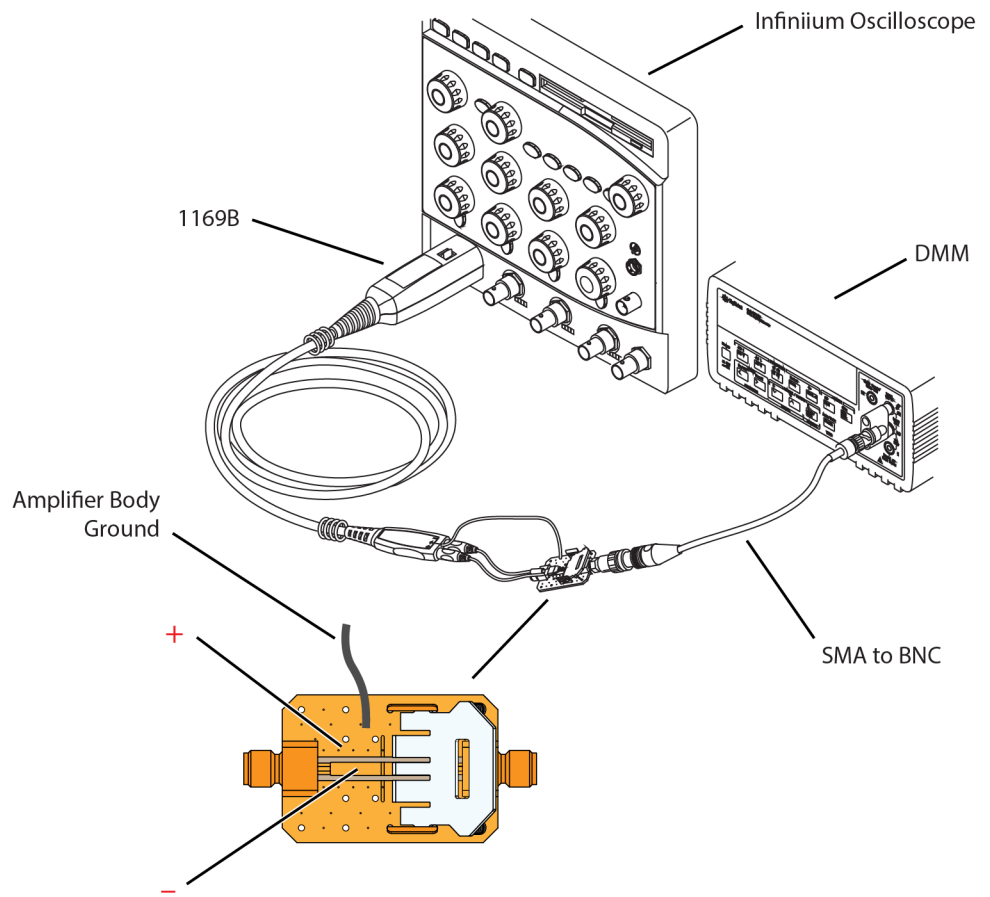

Figure 216 Probing Locations on PV Test Board for Differential Test

Performance Test Record

Table 33 Performance Test Record

Model #:	Date:	Tested by:	
Serial #:	Recommended next test date:		
Test	Test Limits	Result	Pass/Fail
Bandwidth	12 GHz (1169B) 10 GHz (1168B)		
Input Resistance	50 k Ω \pm 2% (Differential Mode) 25 k Ω \pm 2% (Single-ended Mode)		

8 SPICE Models

MX0100A Micro Probe Head	222
N5381B and N5382A Heads	224
N2839A Head	227
N5425B ZIF Head with N5426A ZIF Tip Attached	230
N5426A ZIF Tip	233
N5425B ZIF Head with N5451A Long-Wire ZIF Tip	236
N2851A QuickTip Head with N2849A QuickTip Tip	244
N2887A/N2888A Heads	245
InfiniiMax I Heads	247
SPICE Model for Differential Heads	247
SPICE Model for Single-Ended Heads	248
SPICE Deck and Measured/Modeled Data Matching	249
E2675B Differential Browser Probe Head	249
E2678B Differential Socket Tip Head	251
E2677B Differential Solder-In Head	253
E2676B Single-Ended Browser Head	255
E2679B Single-Ended Solder-In Head	256

This chapter contains SPICE models that can be used to predict the probe loading effects of the InfiniiMax II active probes. Important points about these SPICE models are:

- SPICE models shown here are only for input impedance which allows modeling of the probe loading effects. Probe transfer function is generally flat to the specified bandwidth.
- These input impedance is a function of the probe head type only. The probe amp bandwidth (10 GHz 1168B or 12 GHz 1169B) does not have any effect on the input impedance of the probe heads.

An input impedance plot is given that shows the matching of the measured data to the modeled data. Matching is generally very good up to the specified bandwidth of the probe head.

MX0100A Micro Probe Head

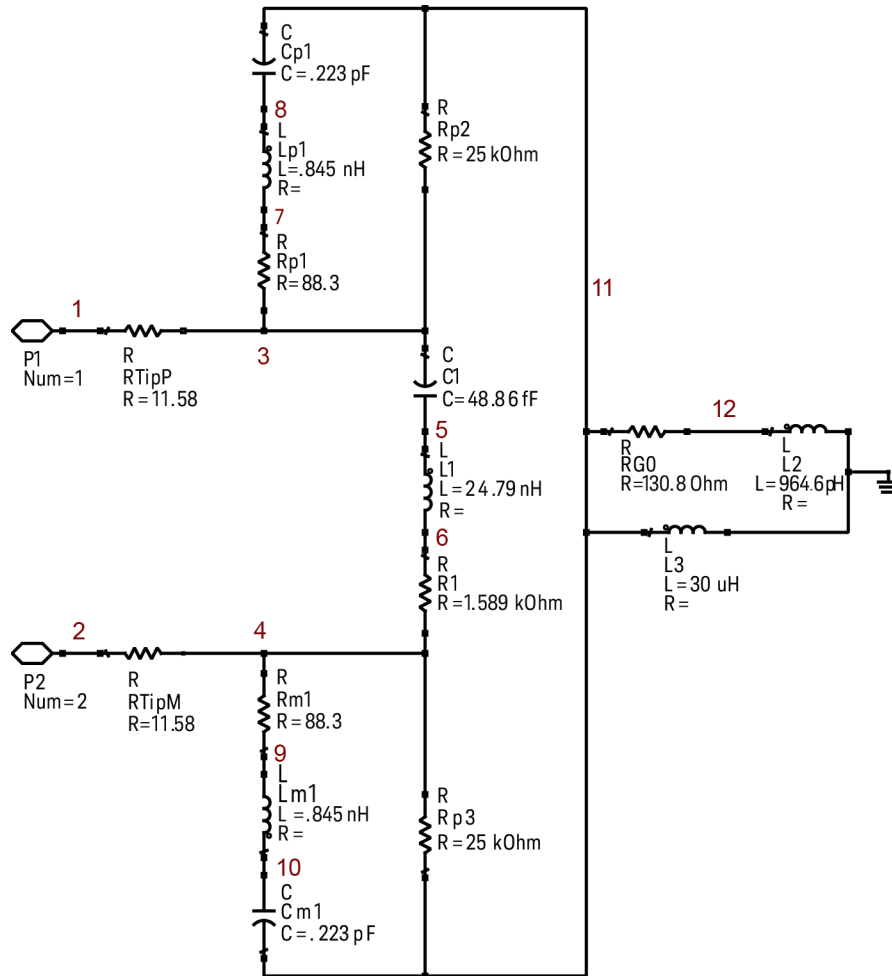

Figure 217 SPICE Model for the input impedance of the InfiniiMax MX0100A Micro Probe Head

SPICE Deck and Measured/Modeled Data Matching

```
.subckt MX0100A 1 2
RTipP 1 3 11.58
RTipM 2 4 11.58
C1 3 5 48.86f
L1 5 6 24.79n
R1 6 4 1.589k
Rp1 7 3 88.3
Lp1 8 7 .845n
Cp1 11 8 .223p
Rm1 4 9 88.3
Lm1 9 10 .845n
```

```

Cm1 10 11 .223p
Rp2 11 3 25k
Rp3 4 11 25k
RG0 11 12 130.8
L2 12 0 964.6p
L3 11 0 30u
.END
    
```

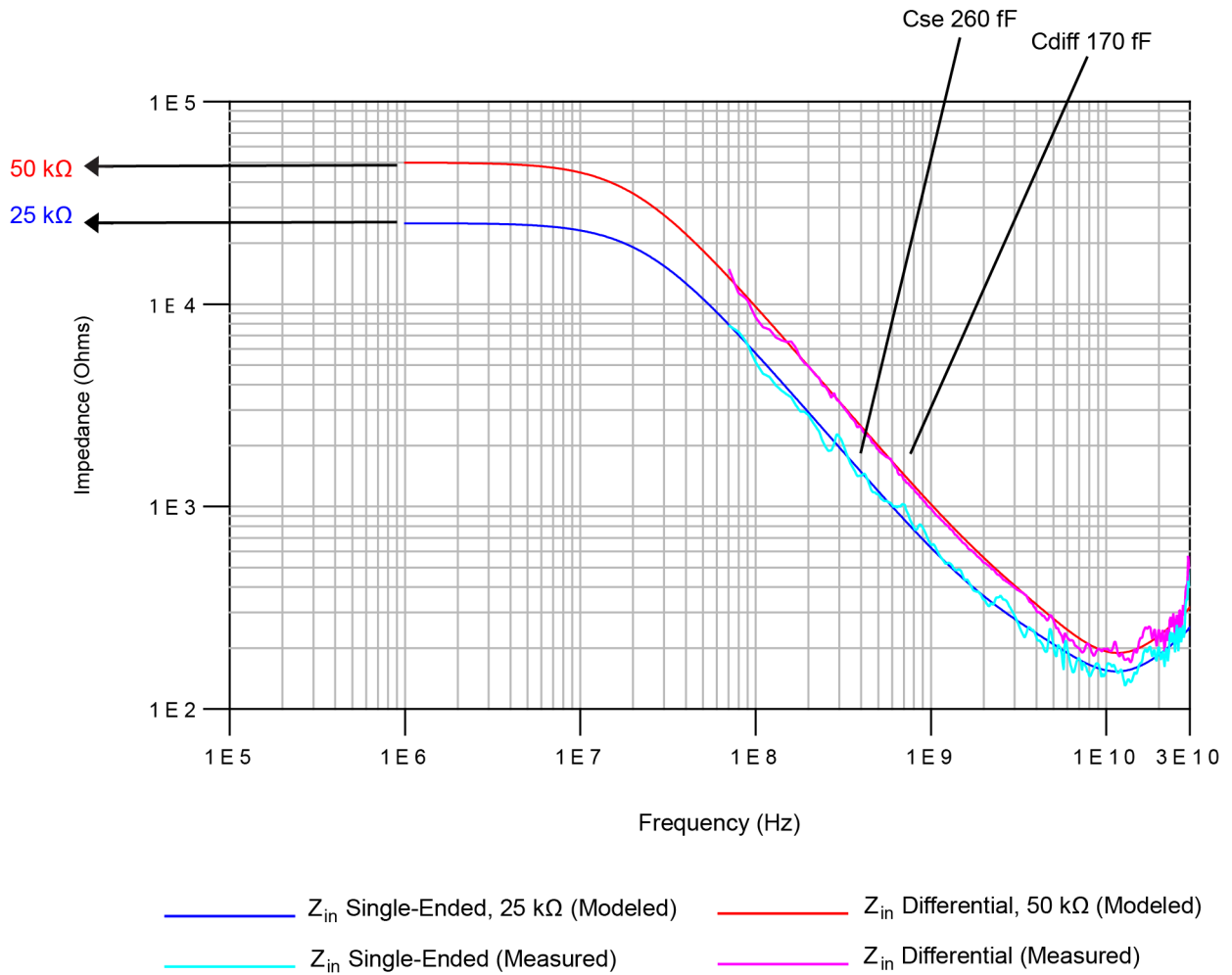

Figure 218 Input Impedances (Z_{in} Modeled and Z_{in} Measured) for the MX0100A Micro Probe Head

N5381B and N5382A Heads

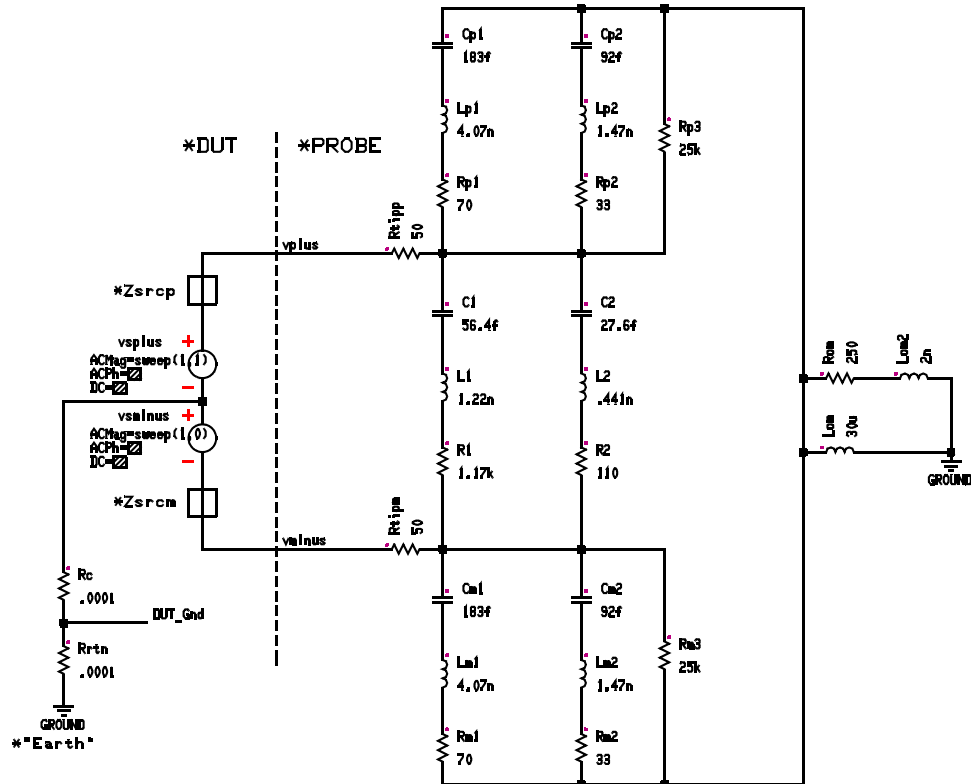

Figure 219 SPICE Model for InfiniiMax 1160 Series N5381/2A Differential Probe Heads

Rrtn (or Zrtn) is dependent on connection from DUT ground to "Earth" ground. Most likely modeled by a parallel RL similar to $R_{om} \parallel L_{om}$. Will have slight effect on single-ended input Z and no effect on differential input Z.

When using differential probe to probe single-ended signals:

- vplus connected to DUT signal
- vminus connected to DUT ground which means that $R_c = 0$, $v_{sminus} = 0$, and $Z_{srcm} = 0$.
- Input impedance is defined to be $v_{plus}/i(v_{splus})$

When using differential probe to probe differential signals:

- R_c (or Z_c) will depend on the DUT circuit.
- vplus connected to DUT plus signal
- vminus connected to DUT minus signal.

- Input impedance is defined to be $(v_{plus} - v_{minus})/i(v_{plus})$

SPICE Deck

```

C2 %44 %40 27.6f
Cm2 %41 %38 92f
Cp2 %43 %36 92f
Cp1 %43 %34 183f
Cm1 %41 %31 183f
C1 %44 %28 56.4f
vminus %16 %vminus ACMag=sweep(1,0)
vplus %vplus %16 ACMag=sweep(1,1)
Lom2 %47 %0 2n
Lom %43 %0 30u
L2 %40 %39 .441n
Lm2 %38 %37 1.47n
Lp2 %36 %35 1.47n
Lp1 %34 %33 4.07n
Lm1 %31 %30 4.07n
L1 %28 %32 1.22n
Rm3 %41 %43 25k
Rp3 %43 %44 25k
Rom %43 %47 250
R2 %39 %41 110
Rm2 %37 %43 33
Rp2 %35 %44 33
Rp1 %33 %44 70
Rm1 %30 %43 70
R1 %32 %41 1.17k
Rtipm %vminus %41 50
Rtipp %vplus %44 50
Rrtn %15 %0 .0001
Rc %16 %15 .0001
.END

```

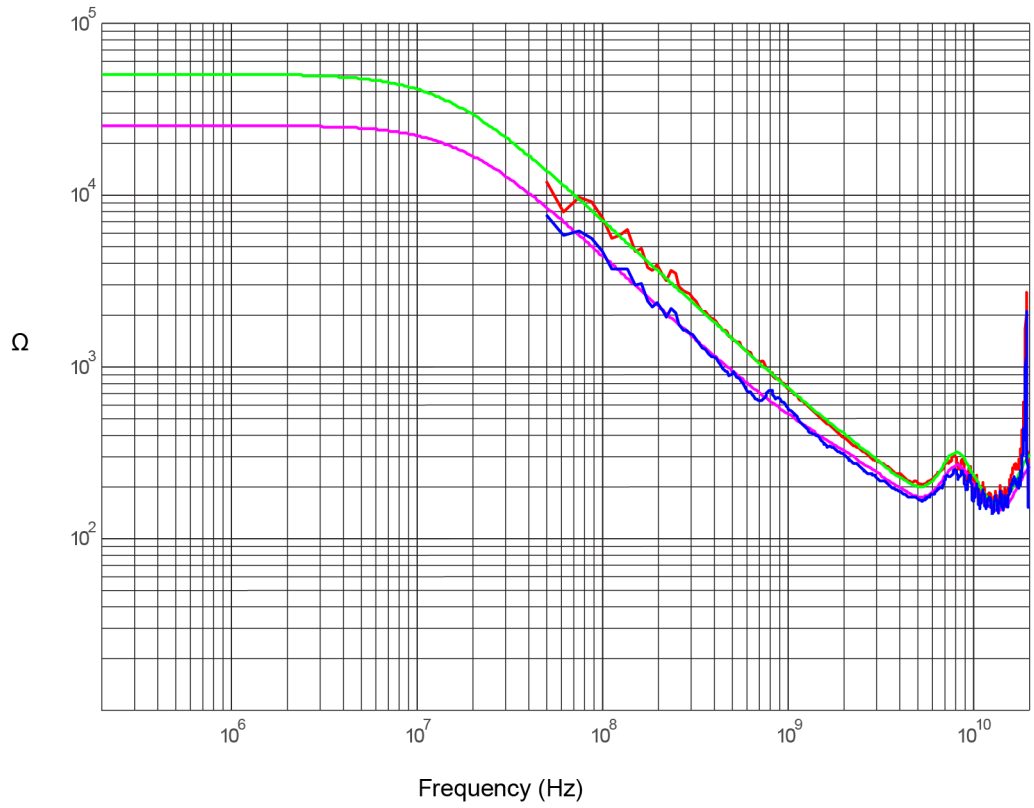

Figure 220 Measured and Modeled Data Matching

N2839A Head

NOTE

The S-parameters and spice models for the N2839A browser remain the same for the spring-loaded tips and straight tips supplied with the browser.

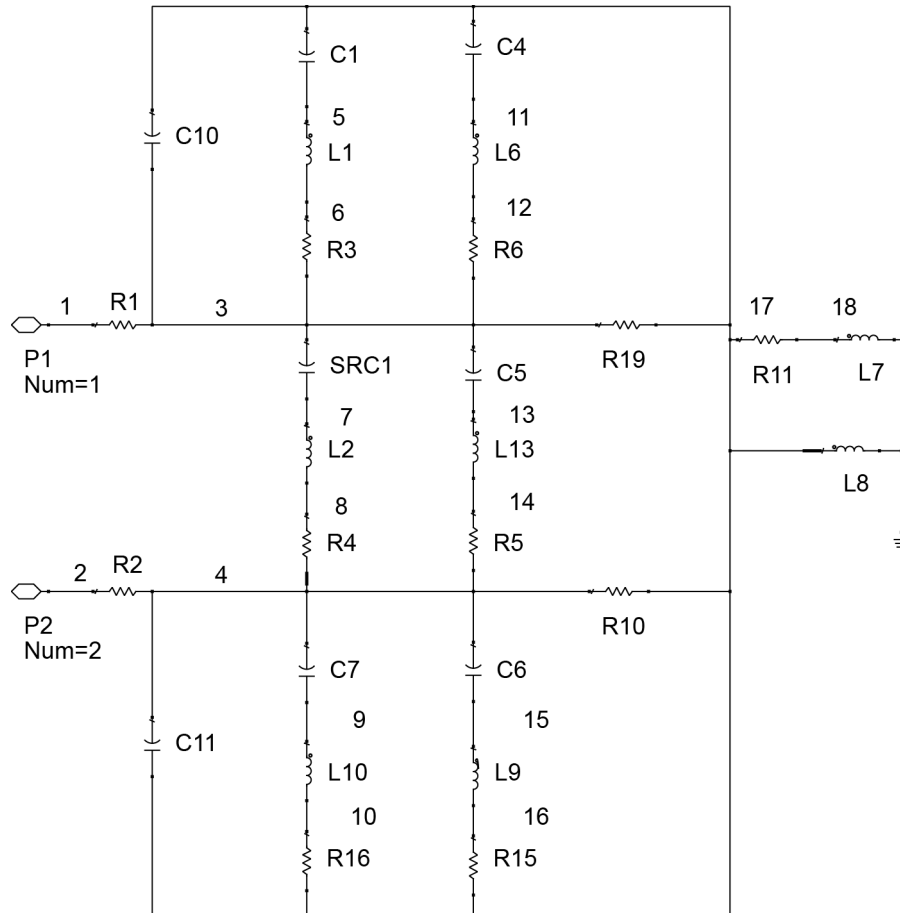

Figure 221 SPICE Models for the input impedance of the InfiniiMax N2839A Differential Browser Head

SPICE Deck

```
* Input impedance SPICE subckt for probe head listed.
.subckt N2839A 1 2
r1 1 3 41.09
r2 2 4 41.09
c10 3 17 95.34f
c11 4 17 95.34f
c1 17 5 100f
c7 4 9 100f
l1 5 6 8.126n
l10 9 10 8.126n
r3 6 3 139.7
r16 10 17 139.7
csrc1 3 7 35.6f
l2 7 8 4.03n
r4 8 4 1553.6
c4 17 11 93.1f
c6 4 15 93.1f
l6 11 12 .164n
l9 15 16 .164n
r6 12 3 71.92
r15 16 17 71.92
c5 3 13 17.68f
l13 13 14 8.6n
r5 14 4 273.2
r19 3 17 25k
r10 4 17 25k
r11 17 18 40.54
l7 18 0 .205n
l8 17 0 47.23u
ends
```

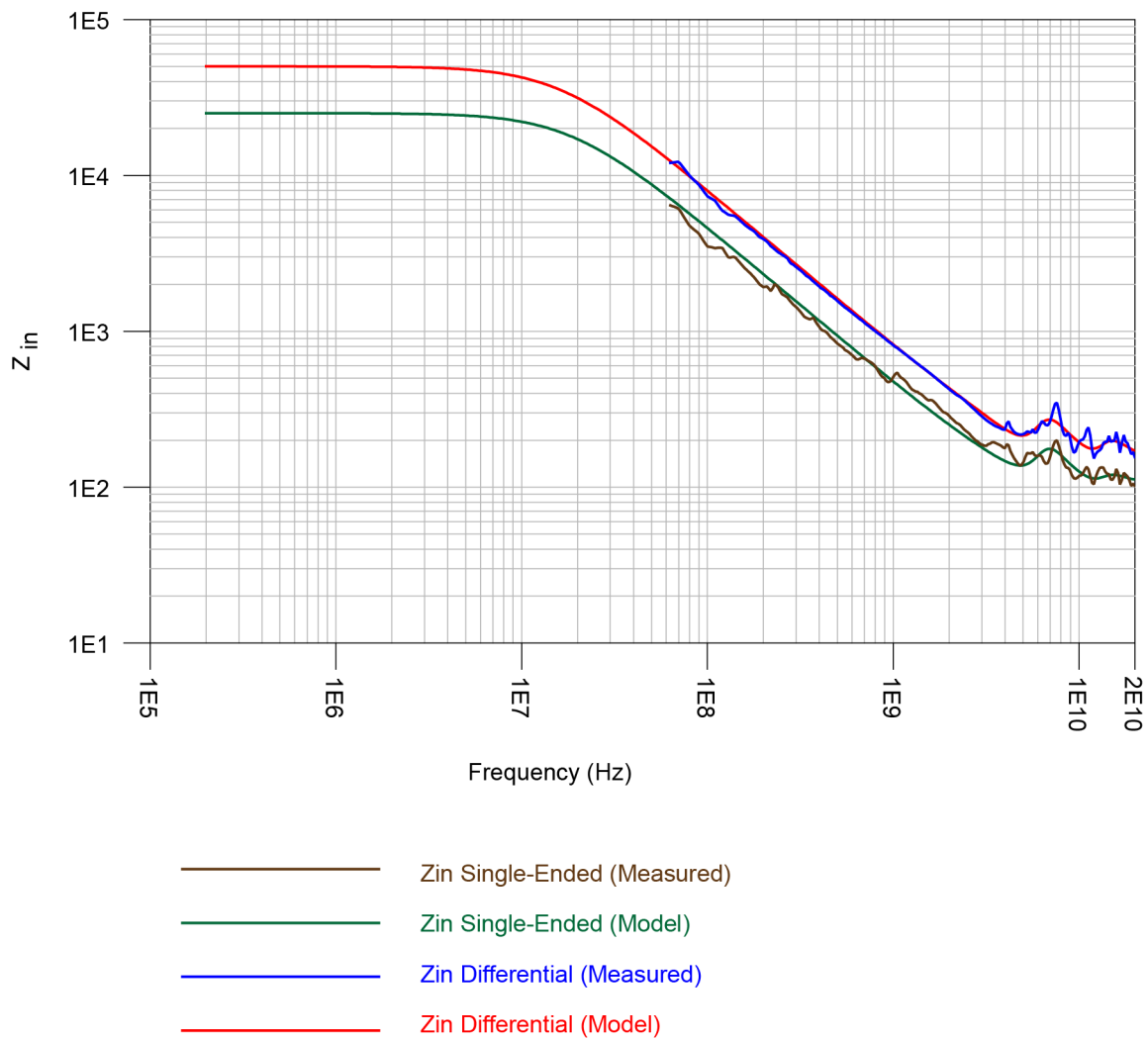

Figure 222 Zin Measured Versus Modeled Data

N5425B ZIF Head with N5426A ZIF Tip Attached

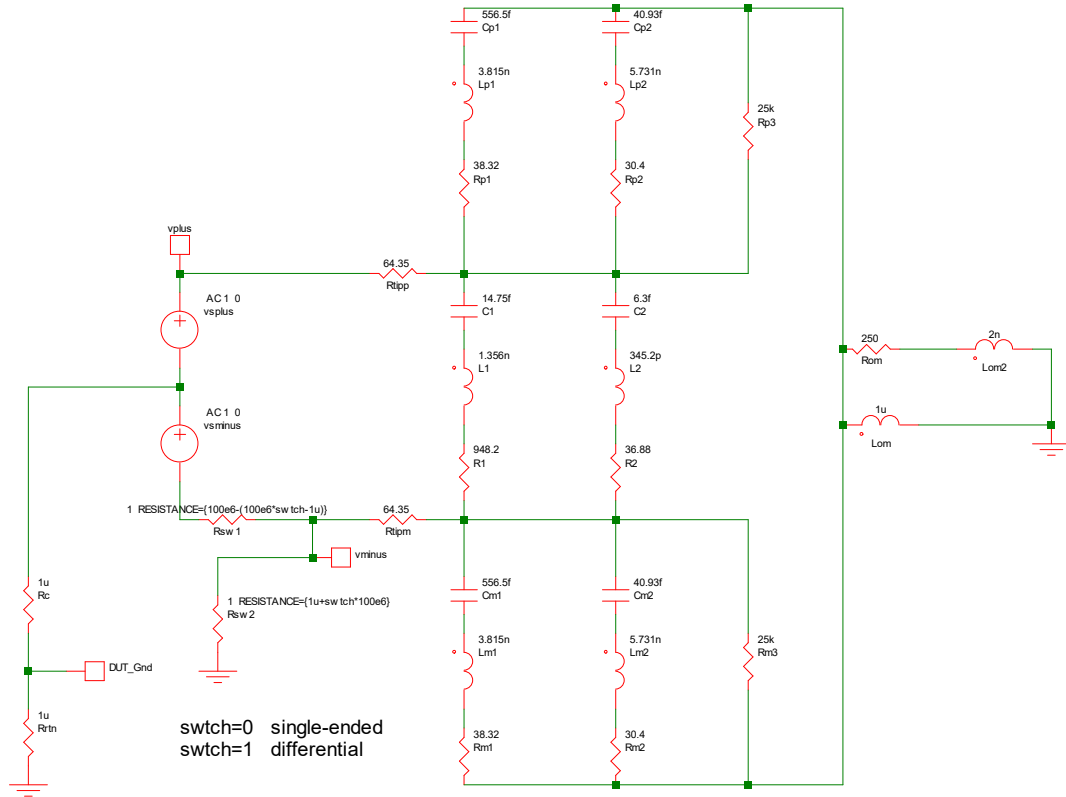

Figure 223 SPICE Model for N5425B with N5426A ZIF Tip

When using differential probe to probe single-ended signals:

- vplus connected to DUT signal
- vminus connected to DUT ground which means that $R_{sw1} = \infty$ and $R_{sw2} = 0$
- Input impedance is defined to be $vplus/i(vsplus)$

When using differential probe to probe differential signals:

- R_c (or Z_c) will depend on the DUT circuit.
- vplus connected to DUT plus signal
- vminus connected to DUT minus signal.
- Input impedance is defined to be $(vplus - vminus)/i(vsplus)$

SPICE Deck of N5425B with N5426A ZIF Tip Attached

Lom2 Rom_P 0 2n

```

Lm2 Cm2_N Lm2_N 5.731n
Rtipp Rp3_N vplus 64.35
Lm1 Cm1_N Lm1_N 3.815n
Rom Rom_P Cp1_P 250
Cp1 Cp1_P Cp1_N 556.5f
Cp2 Cp1_P Cp2_N 40.93f
Lp1 Cp1_N Lp1_N 3.815n
Lp2 Cp2_N Lp2_N 5.731n
Cm2 R1_N Cm2_N 40.93f
vsminus vsplus_N vsminus_N AC 1 0
L1 C1_N L1_N 1.356n
L2 C2_N L2_N 345.2p
Rp1 Lp1_N Rp3_N 38.32
Cm1 R1_N Cm1_N 556.5f
Rp2 Lp2_N Rp3_N 30.4
Rp3 Cp1_P Rp3_N 25k
Rrtn DUT_Gnd 0 1u
Rsw2 vminus 0 1 1u+swtch*100e6
vsplus vplus vsplus_N AC 1 0
Rm2 Lm2_N Cp1_P 30.4
Rm3 R1_N Cp1_P 25k
Rsw1 vminus vsminus_N 100e6-(100e6*swtch-1u)
Lom Cp1_P 0 1u
C2 Rp3_N C2_N 6.3f
Rm1 Lm1_N Cp1_P 38.32
Rc vsplus_N DUT_Gnd 1u
C1 Rp3_N C1_N 14.75f
Rtipm R1_N vminus 64.35
R1 L1_N R1_N 948.2
R2 L2_N R1_N 36.88
.AC DEC 200 200k 20G SWEEP PARAM=swtch LIN 2 0 1
.PARAM swtch=1

```

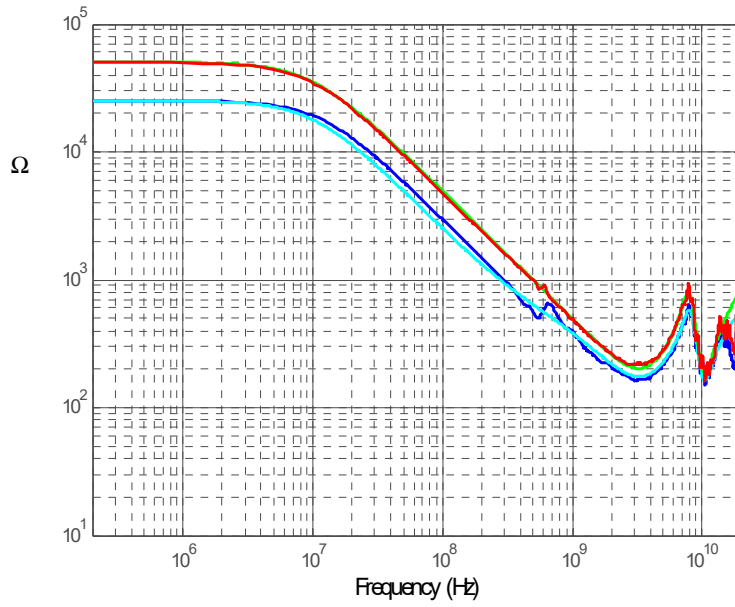

Figure 224 Measured and Modeled Data Matching

N5426A ZIF Tip

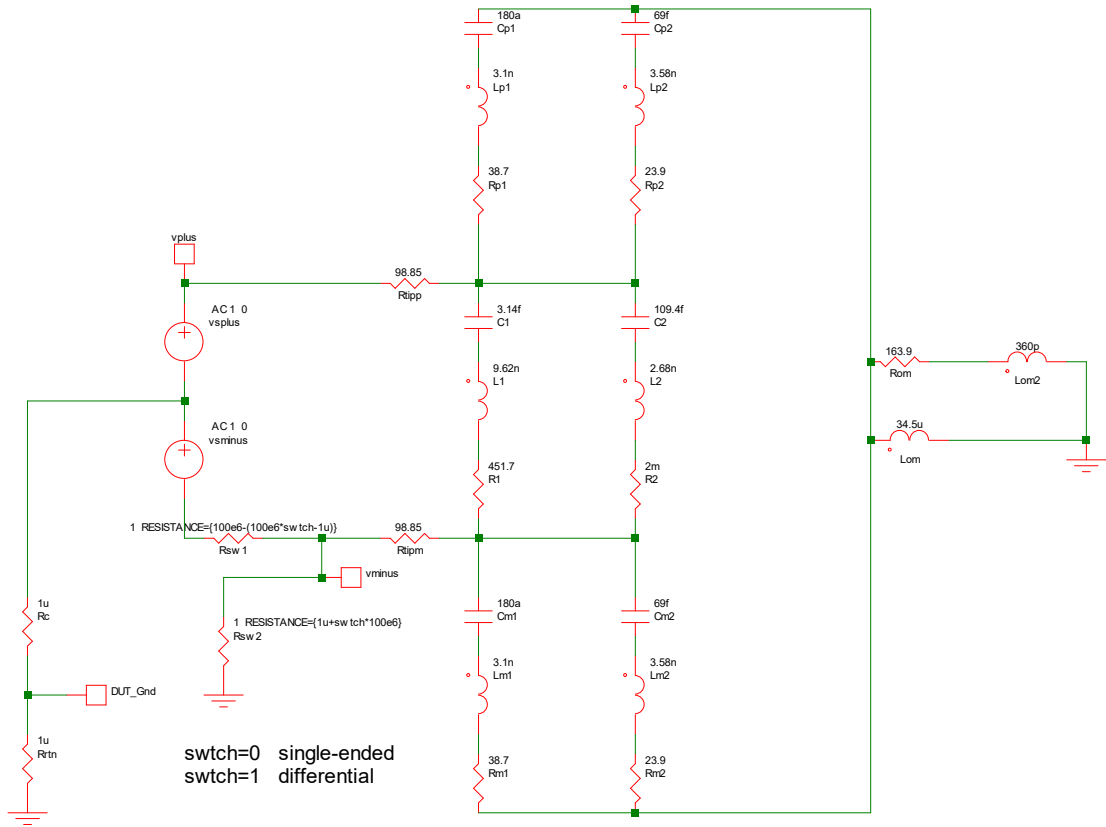

Figure 225 SPICE Model for N5426A ZIF Tip

SPICE Deck of N5426A

```

Lom2 Rom_P 0 360p
Lm2 Cm2_N Lm2_N 3.58n
Rtipp Rp3_N vplus 98.85
Lm1 Cm1_N Lm1_N 3.1n
Rom Rom_P Cp1_P 163.9
Cp1 Cp1_P Cp1_N 180a
Cp2 Cp1_P Cp2_N 69f
Lp1 Cp1_N Lp1_N 3.1n
Lp2 Cp2_N Lp2_N 3.58n
Cm2 R1_N Cm2_N 69f
vsminus vsplus_N vsminus_N AC 1 0
L1 C1_N L1_N 9.62n
L2 C2_N L2_N 2.68n
Rp1 Lp1_N Rp3_N 38.7
Cm1 R1_N Cm1_N 180a
Rp2 Lp2_N Rp3_N 23.9
Rrtn DUT_Gnd 0 1u
Rsw2 vminus 0 1 RESISTANCE={1u+swtch*100e6}
vsplus vplus vsplus_N AC 1 0
Rm2 Lm2_N Cp1_P 23.9
Rsw1 vminus vsminus_N 1 RESISTANCE={100e6-(100e6*swtch-1u)}
Lom Cp1_P 0 34.5u
C2 Rp3_N C2_N 109.4f
Rm1 Lm1_N Cp1_P 38.7
Rc vsplus_N DUT_Gnd 1u
C1 Rp3_N C1_N 3.14f
Rtipm R1_N vminus 98.85
R1 L1_N R1_N 451.7
R2 L2_N R1_N 2m
.AC DEC 200 200k 20G SWEEP PARAM=swtch LIN 2 0 1
.PARAM swtch 1

```

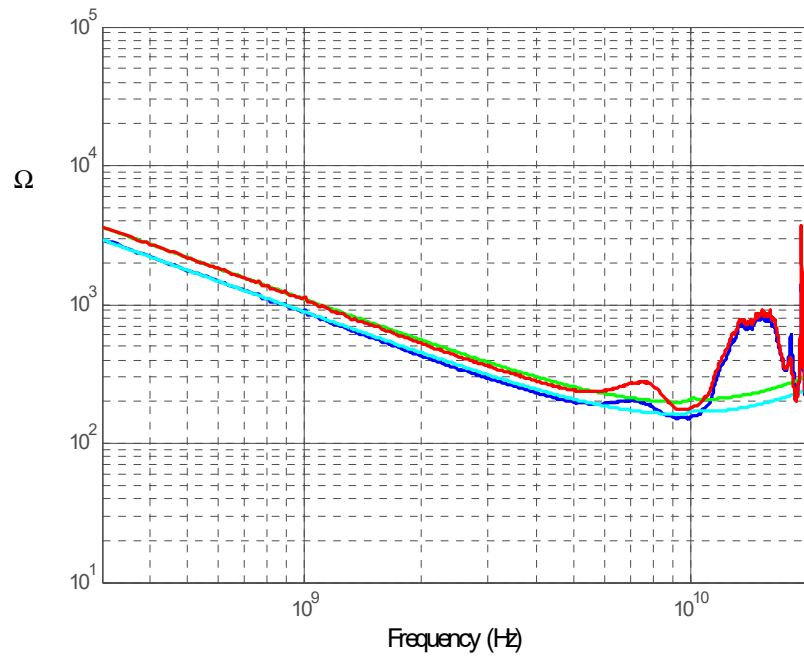

Figure 226 Measured and Modeled Data Matching

N5425B ZIF Head with N5451A Long-Wire ZIF Tip

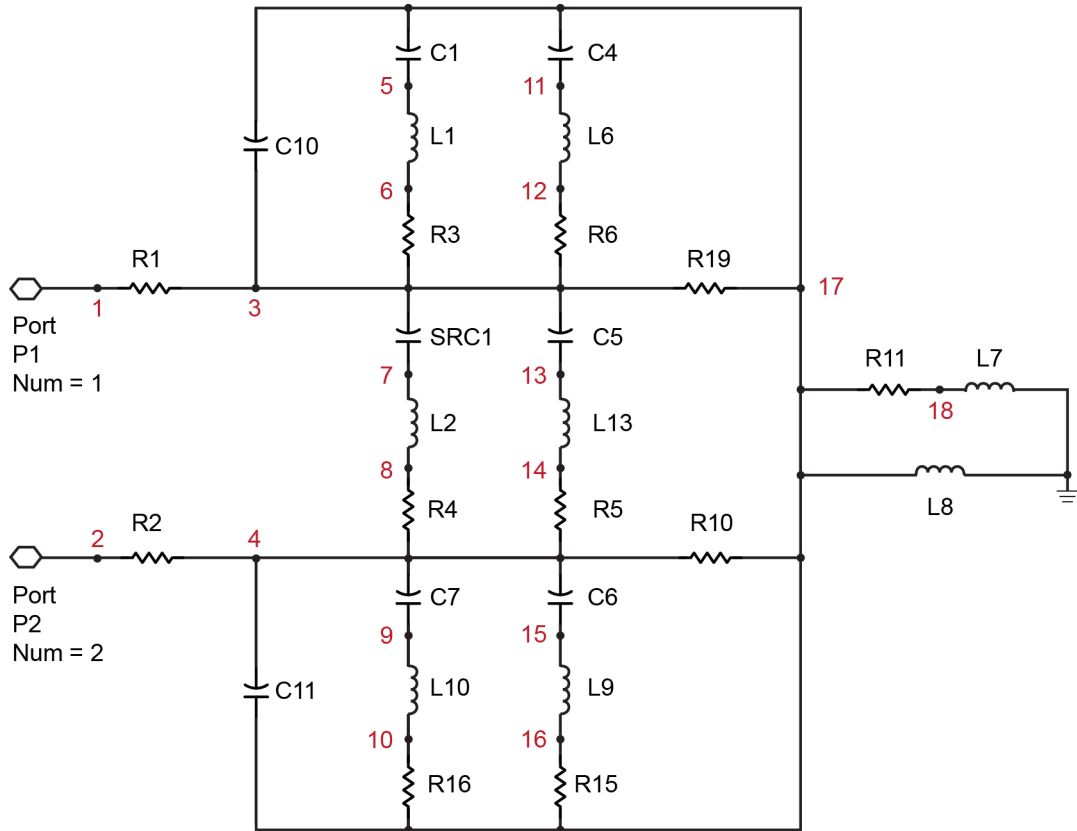

Figure 227 SPICE Model for N5425B ZIF Head with N5451A ZIF Tip

To model single-ended input impedance, ground one input pin and apply the signal to the other input pin. To model differential input impedance, connect both input pins to the differential signal.

SPICE Deck with N5451A ZIF Tip (7 mm Lead and 0° Spread)

```
* Input impedance SPICE subckt for probe head listed.
.subckt N5451A_N5425B_7mm_0deg 1 2
r1 1 3 49.5
r2 2 4 49.5
c10 3 17 10.74f
c11 4 17 10.74f
c1 17 5 330f
c7 4 9 330f
l1 5 6 8.81n
l10 9 10 8.81n
```

```

r3 6 3 83.6
r16 10 17 83.6
csrc1 3 7 164.4f
l2 7 8 22.1n
r4 8 4 195.7
c4 17 11 71.3f
c6 4 15 71.3f
l6 11 12 3.46n
l9 15 16 3.46n
r6 12 3 65.0
r15 16 17 65.0
c5 3 13 26.1f
l13 13 14 4.28n
r5 14 4 42.3
r19 3 17 25k
r10 4 17 25k
r11 17 18 60.6
l7 18 0 .05n
l8 17 0 45.5u
ends
    
```

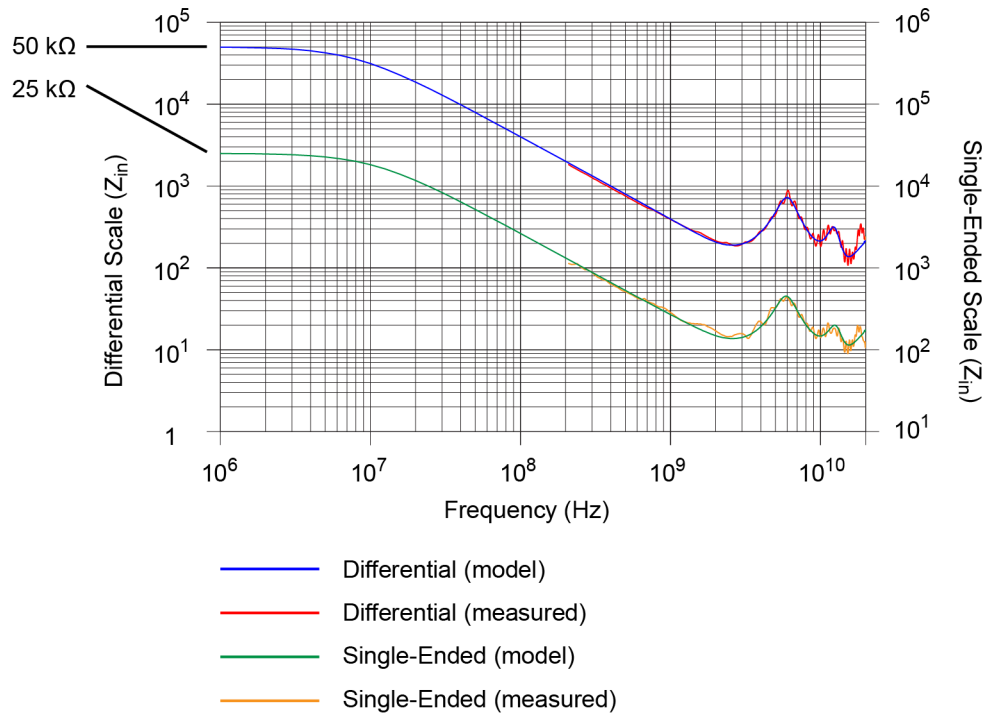

Figure 228 Measured and Modeled Data Matching for 7 mm Leads and 0° Spread

SPICE Deck with N5451A ZIF Tip (7 mm Lead and 60° Spread)

```
* Input impedance SPICE subckt for probe head listed.
.subckt N5451A_N5425B_7mm_60deg 1 2
r1 1 3 61.7
r2 2 4 61.7
c10 3 17 .15f
c11 4 17 .15f
c1 17 5 660.2f
c7 4 9 660.2f
l1 5 6 5.8n
l10 9 10 5.8n
r3 6 3 34.4
r16 10 17 34.4
csrc1 3 7 0f
l2 7 8 276n
r4 8 4 .001
c4 17 11 197.2f
c6 4 15 197.2f
l6 11 12 .34n
l9 15 16 .34n
r6 12 3 .001
r15 16 17 .001
c5 3 13 7.75f
l13 13 14 0n
r5 14 4 46.7
r19 3 17 25k
r10 4 17 25k
r11 17 18 157.6
l7 18 0 .36n
l8 17 0 87.9u
ends
```

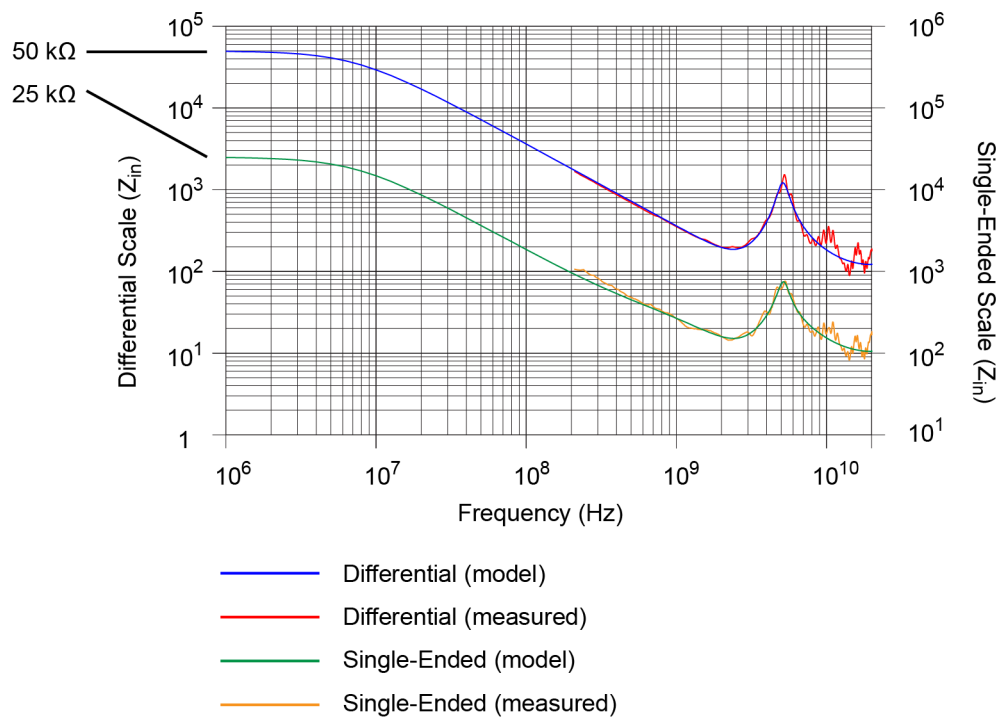

Figure 229 Measured and Modeled Data Matching for 7 mm Leads and 60° Spread

SPICE Deck with N5451A ZIF Tip (11 mm Lead and 0° Spread)

```
* Input impedance SPICE subckt for probe head listed.
.subckt N5451A_N5425B_11mm_0deg 1 2
r1 1 3 54.59
r2 2 4 54.59
c10 3 17 0
c11 4 17 0
c1 17 5 307f
c7 4 9 307f
l1 5 6 11.64n
l10 9 10 11.64n
r3 6 3 57.72
r16 10 17 57.72
csrc1 3 7 199.6f
l2 7 8 28n
r4 8 4 149
c4 17 11 57.53f
c6 4 15 57.53f
l6 11 12 5.03n
l9 15 16 5.03n
r6 12 3 80.8
r15 16 17 80.8
c5 3 13 51f
l13 13 14 2.48n
r5 14 4 .22
r19 3 17 25k
r10 4 17 25k
r11 17 18 112.5
l7 18 0 .08n
l8 17 0 41.4u
ends
```

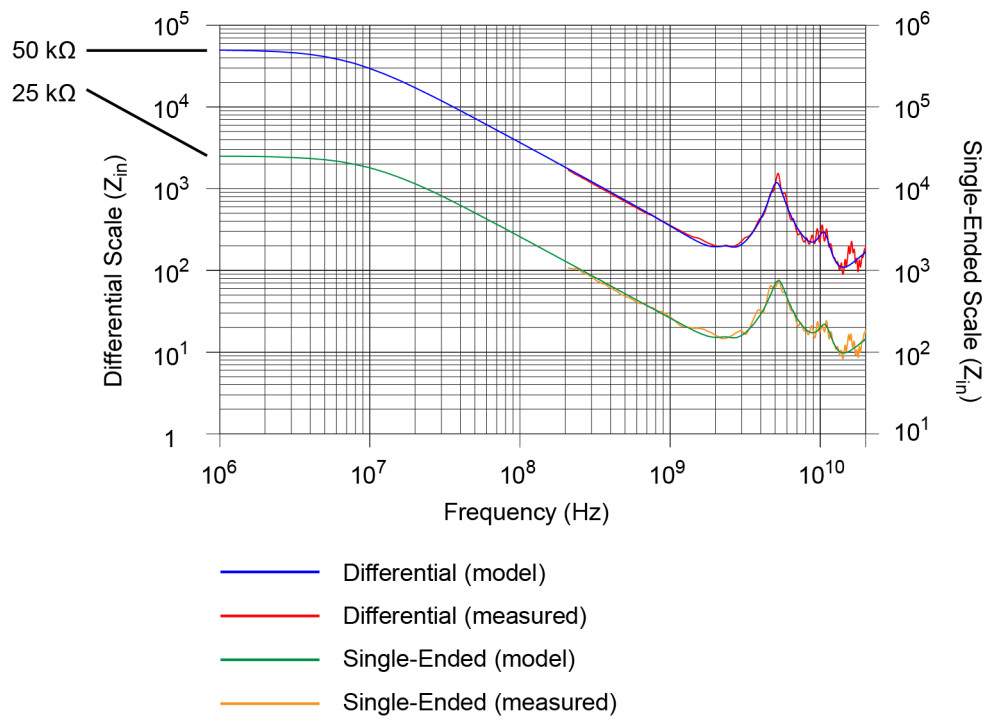



Figure 230 Measured and Modeled Data Matching for 11 mm Leads and 0° Spread

SPICE Deck with N5451A ZIF Tip (11 mm Lead and 60° Spread)

```
* Input impedance SPICE subckt for probe head listed.
.subckt N5451A_N5425B_11mm_60deg 1 2
r1 1 3 74.80
r2 2 4 74.80
c10 3 17 3.02f
c11 4 17 3.02f
c1 17 5 236f
c7 4 9 236f
l1 5 6 17.51n
l10 9 10 17.51n
r3 6 3 195
r16 10 17 195
csrc1 3 7 217.3f
l2 7 8 28n
r4 8 4 42.8
c4 17 11 123.4f
c6 4 15 123.4f
l6 11 12 0n
l9 15 16 0n
r6 12 3 3.97
r15 16 17 3.97
c5 3 13 0f
l13 13 14 0n
r5 14 1.97
r19 3 17 25k
r10 4 17 25k
r11 17 18 32.3
l7 18 0 .59n
l8 17 0 5.69u
ends
```

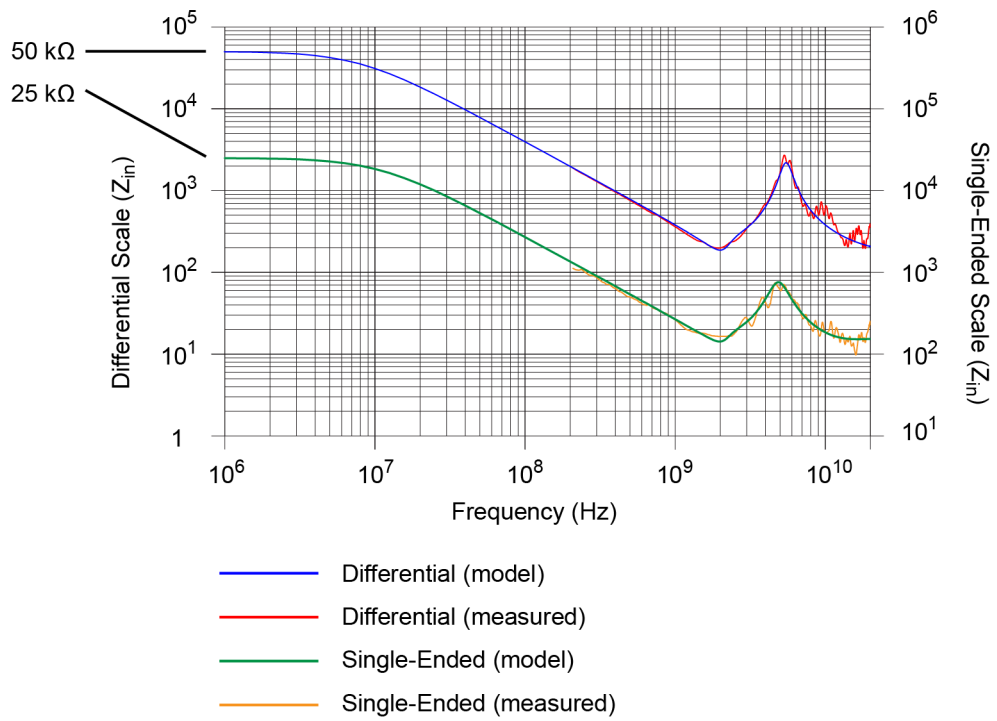

Figure 231 Measured and Modeled Data Matching for 11 mm Leads and 60° Spread

N2851A QuickTip Head with N2849A QuickTip Tip

The following input-impedance SPICE subcircuit data is for the N2851A QuickTip probe head with N2849A QuickTip tip. The data models all modes of input impedance: differential, common, and A or B. The probe is vertical orientated with both ground wires connected to the DUT ground.

SPICE subcircuit data

```
* Input impedance SPICE subckt for N2849A_N2851A QuickTip and QuickTip probe
head.
* Vertical orientation with both ground wires connected to DUT ground
* Models all modes of input impedance: Diff, Common, and A or B
.subckt N2849A_N2851A 1 2
r1 1 3 1e8
r2 2 3 1e8
r9 3 0 .5e8
r_srlc2 5 7 201.895
l_srlc2 7 8 4.24047n
c_srlc2 8 6 101.955f
r_srlc3 4 9 190.712
l_srlc3 9 10 8.8192n
c_srlc3 10 6 7.86088f
r_srlc1 4 11 325.561
l_srlc1 11 12 2.89997n
c_srlc1 12 6 315.986f
r3 4 13 260
c1 13 6 200f
r5 13 6 50k
r8 6 0 1e-6
r4 14 16 130
r_srlc4 14 18 175.375
l_srlc4 18 19 13.431n
c_srlc4 19 17 485.278f
r_srlc5 14 20 13.8395
l_srlc5 20 21 3.28155n
c_srlc5 21 17 15.7972f
r_srlc6 15 22 302.872
l_srlc6 22 23 3.28881n
c_srlc6 23 17 79.906f
r6 16 17 25k
c2 16 17 200f
r7 17 0 1e-6
e1 5 0 4 0 -1
e2 4 0 1 2 1
e3 14 0 3 0 2
e4 15 0 14 0 -1
g1 1 2 6 0 1e6
g2 1 0 17 0 1e6
g3 2 0 17 0 1e6
.ends
```

N2887A/N2888A Heads

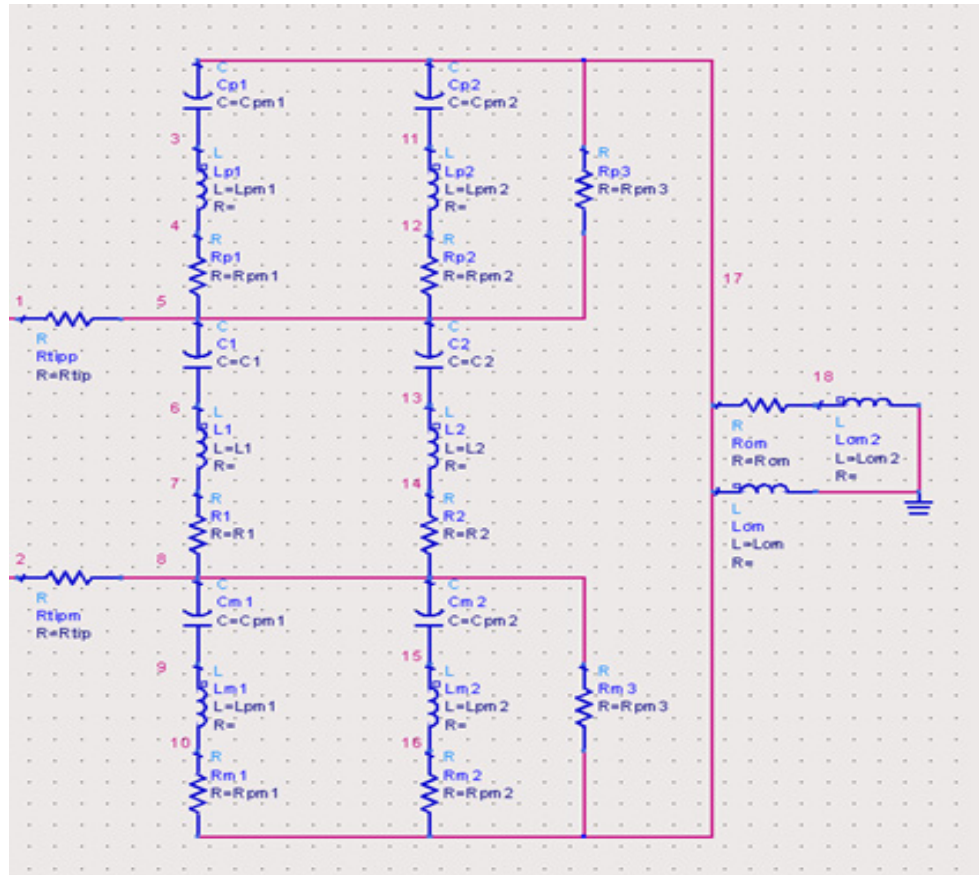

Figure 232 Differential SPICE Input Impedance Model

```
.subckt N2887A_Differential 1 2
rtipp 1 5 1e-12
rtipm 2 8 1e-12
cp1 3 17 .174p
lp1 3 4 1.843n
rp1 4 5 9.309
cm1 8 9 .174p
lm1 9 10 1.843n
rm1 10 17 9.309
c1 5 6 .101p
l1 6 7 2.844n
r1 7 8 14.645
cp2 17 11 .329p
lp2 11 12 .335n
rp2 12 5 18.747
cm2 8 15 .329p
lm2 15 16 .335n
rm2 16 17 18.747
```

```

c2 5 13 .00001p
l2 13 14 .505n
r2 14 8 45.82
rp3 17 5 25k
rm3 8 17 25k
rom 17 18 3.82e-8
lom2 18 0 .501n
lom 17 0 20.5u
.ends

```

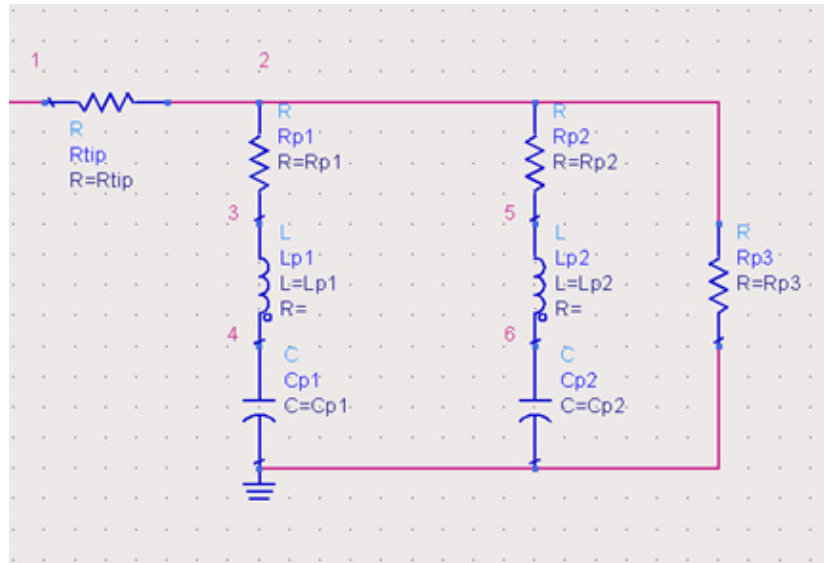

Figure 233 Single-Ended SPICE Input Impedance Model

```

.subckt N2887A_SingleEnded 1
rtip 1 2 1e-12
rp1 2 3 12.480
lp1 3 4 1.525n
cp1 4 0 .407p
rp2 2 5 24.445
lp2 5 6 2.285n
cp2 6 0 .140p
rp3 2 0 25k
.ends

```

InfiniiMax I Heads

If damped wire accessories or longer mid-BW resistors (for solder-in probe heads) are used, they can be modeled by adding an RLC model in front of the appropriate probe head model and zeroing out the damping resistor in the probe head model.

There is one SPICE schematic for the differential probe heads and one SPICE schematic for the single-ended probe heads. The schematics have parameterized R, L, and C values that are given in the SPICE deck for the specific probe head. Additionally, an input impedance plot is given that shows the matching of the measured data to the modeled data. Matching is generally very good up to the specified BW of the probe head with the 7 GHz probe amp.

SPICE Model for Differential Heads

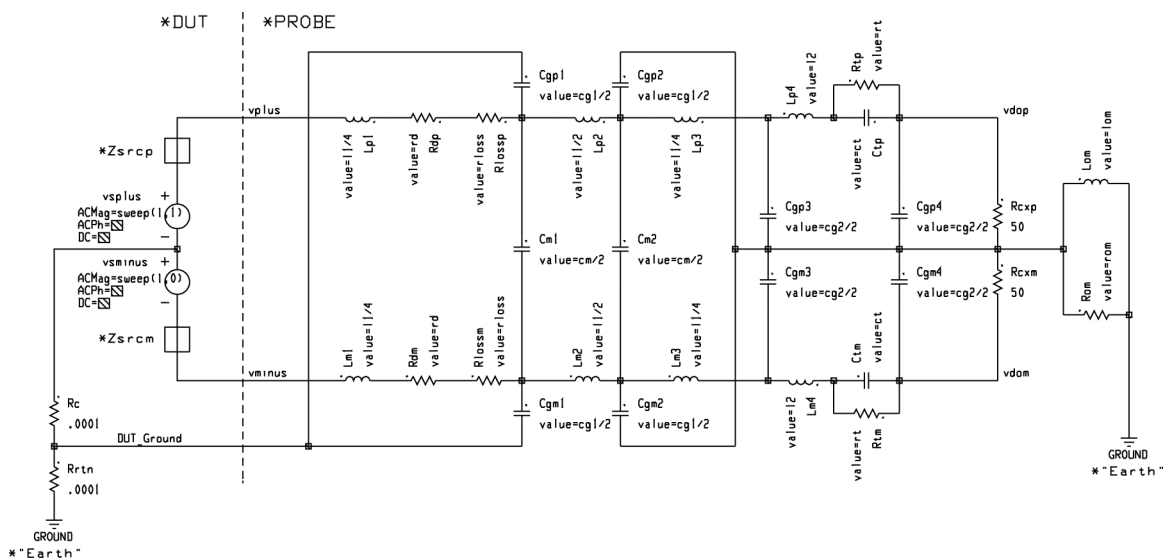

Figure 234 SPICE Model for Differential Probe Heads

Rrtn (Zrtn) is dependent on connection from DUT ground to “Earth” ground. Most likely modeled by a parallel RL similar to Rom || Lom. Will have slight effect on single-ended input Z and no effect on differential input Z.

Cgp1 and Cgm1 represent C from probe tips to DUT ground near probe tips.

If using diff probe to probe single-ended signals:

- vplus connected to DUT signal
- vminus connected to DUT ground with means that Rc = 0 and Zsrcm = 0.

- Input impedance is defined to be v_{plus}/i (v_{splus})
- If using diff probe to probe differential signals:
- R_c (or Z_c) will depend on the DUT circuit
 - v_{plus} connected to DUT plus signal
 - v_{minus} connected to DUT minus signal.
 - Input impedance is defined to be $(v_{plus}/v_{minus}) / i$ (v_{splus})

SPICE Model for Single-Ended Heads

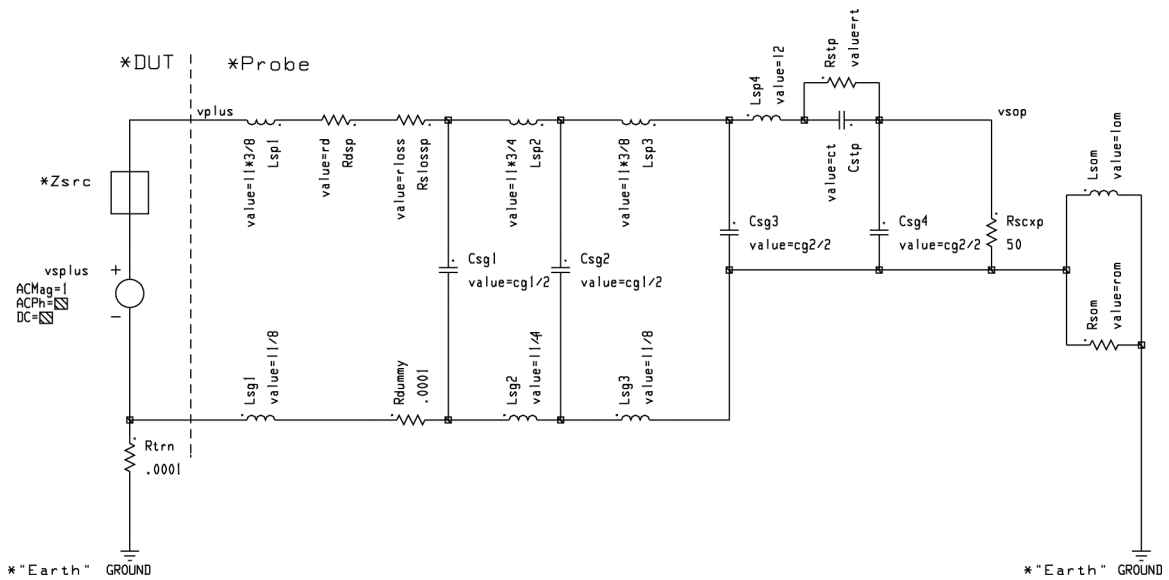

Figure 235 SPICE Model for Single-Ended Probe Heads

R_{trn} (Z_{trn}) is dependent on connection from DUT ground to “Earth” ground. Most likely modeled by a parallel RL similar to $R_{om} || L_{om}$. Will have slight effect on input Z.

Probe tip C to DUT ground lumped into C_{s1} since there is no damping R in ground path.

Input impedance is defined as $v_{plus}/i(v_{splus})$.

SPICE Deck and Measured/Modeled Data Matching

E2675B Differential Browser Probe Head

```
.param rd=91 rt=25k rloss=10 rom=100 l1=6.5n l2=2n lom=2u cm=80f cg1=120f
cg2=320f ct=200f
```

```
vsminus %164 %vminus ACMag=sweep(1,0)
vsplus %vplus %164 ACMag=sweep(1,1)
Cgp1 %DUT_Ground %99 value=cg1/2
Cgp2 %122 %85 value=cg1/2
Cgm2 %84 %122 value=cg1/2
Cgm1 %95 %DUT_Ground value=cg1/2
Cm1 %99 %95 value=cm/2
Cgp3 %86 %122 value=cg2/2
Cm2 %85 %84 value=cm/2
Cgm4 %122 %vdom value=cg2/2
Cgm3 %122 %87 value=cg2/2
Cgp4 %vdop %122 value=cg2/2
Ctp %vdop %88 value=ct
Ctm %89 %vdom value=ct
Lm3 %84 %87 value=l1/4
Lp3 %86 %85 value=l1/4
Lm4 %89 %87 value=l2
Lp4 %86 %88 value=l2
Lp1 %118 %vplus value=l1/4
Lp2 %85 %99 value=l1/2
Lm1 %vminus %117 value=l1/4
Lm2 %95 %84 value=l1/2
Lom %122 %0 value=lom
Rrtn %DUT_Ground %0 .0001
Rc %164 %DUT_Ground .0001
Rlossp %99 %159 value=rloss
Rlossm %160 %95 value=rloss
Rdp %159 %118 value=rd
Rdm %117 %160 value=rd
Rtm %vdom %89 value=rt
Rtp %88 %vdop value=rt
Rcxp %vdop %122 50
Rcxm %122 %vdom 50
Rom %122 %0 value=rom
```

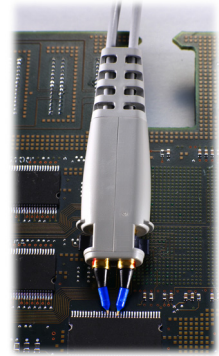

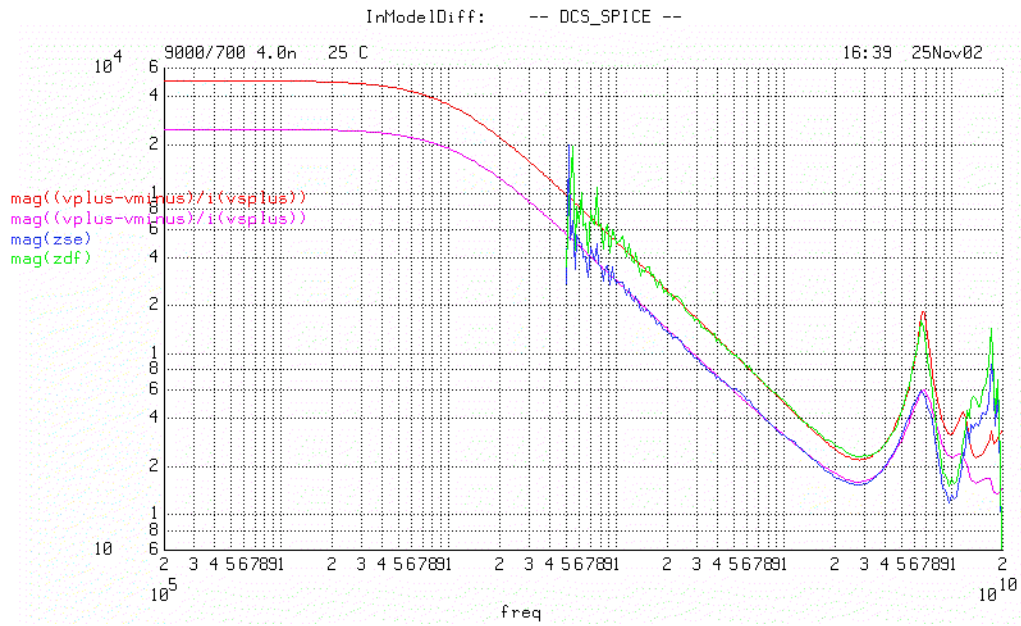

E2678B Differential Socket Tip Head

```
.param rd=82 rt=25k rloss=25 rom=200 l1=4n l2=2n lom=2u
cm=117f cg1=120f cg2=320f ct=200f
```

```
vsminus %164 %vminus ACMag=sweep(1,0)
vsplus %vplus %164 ACMag=sweep(1,1)
Cgp1 %DUT_Ground %99 value=cg1/2
Cgp2 %122 %85 value=cg1/2
Cgm2 %84 %122 value=cg1/2
Cgm1 %95 %DUT_Ground value=cg1/2
Cm1 %99 %95 value=cm/2
Cgp3 %86 %122 value=cg2/2
Cm2 %85 %84 value=cm/2
Cgm4 %122 %vdom value=cg2/2
Cgm3 %122 %87 value=cg2/2
Cgp4 %vdop %122 value=cg2/2
Ctp %vdop %88 value=ct
Ctm %89 %vdom value=ct
Lm3 %84 %87 value=l1/4
Lp3 %86 %85 value=l1/4
Lm4 %89 %87 value=l2
Lp4 %86 %88 value=l2
Lp1 %118 %vplus value=l1/4
Lp2 %85 %99 value=l1/2
Lm1 %vminus %117 value=l1/4
Lm2 %95 %84 value=l1/2
Lom %122 %0 value=lom
Rrtn %DUT_Ground %0 .0001
Rc %164 %DUT_Ground .0001
Rlossp %99 %159 value=rloss
Rlossm %160 %95 value=rloss
Rdp %159 %118 value=rd
Rdm %117 %160 value=rd
Rtm %vdom %89 value=rt
Rtp %88 %vdop value=rt
Rcxp %vdop %122 50
Rcxm %122 %vdom 50
Rom %122 %0 value=rom
```

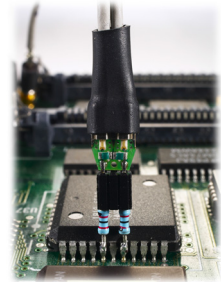

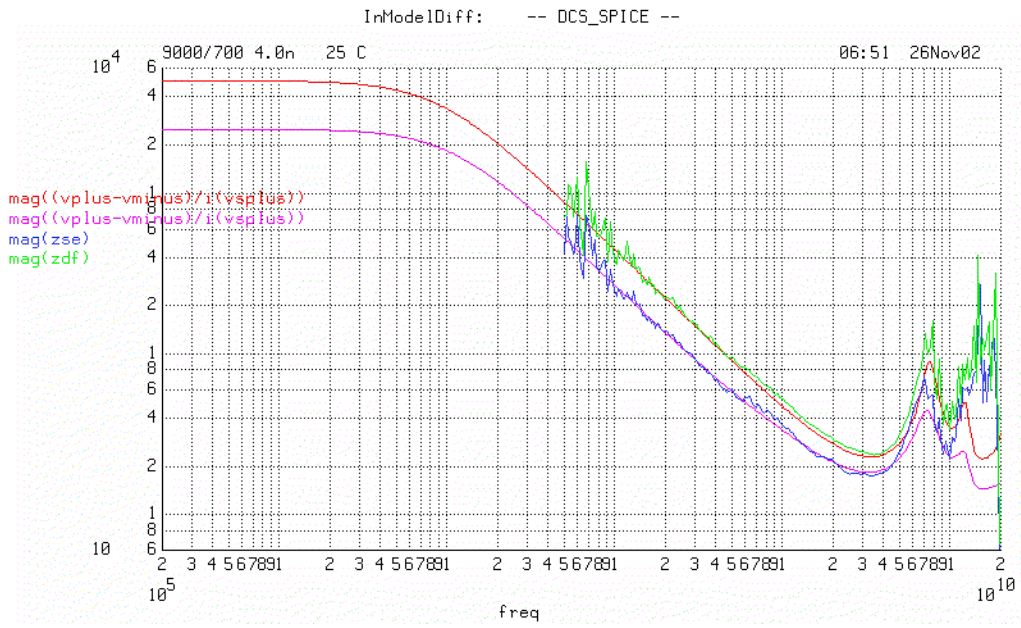

E2677B Differential Solder-In Head

Data for full bandwidth with 91 Ω resistor.

```
.param rd=91 rloss=18 rt=25k rom=250 l1=4n l2=2n lom=2u
cm=100f cg1=80f cg2=180f ct=200f
```

```
vsminus %164 %vminus ACMag=sweep(1,0)
vsplus %vplus %164 ACMag=sweep(1,1)
Cgp1 %DUT_Ground %99 value=cg1/2
Cgp2 %122 %85 value=cg1/2
Cgm2 %84 %122 value=cg1/2
Cgm1 %95 %DUT_Ground value=cg1/2
Cm1 %99 %95 value=cm/2
Cgp3 %86 %122 value=cg2/2
Cm2 %85 %84 value=cm/2
Cgm4 %122 %vdom value=cg2/2
Cgm3 %122 %87 value=cg2/2
Cgp4 %vdop %122 value=cg2/2
Ctp %vdop %88 value=ct
Ctm %89 %vdom value=ct
Lm3 %84 %87 value=l1/4
Lp3 %86 %85 value=l1/4
Lm4 %89 %87 value=l2
Lp4 %86 %88 value=l2
Lp1 %118 %vplus value=l1/4
Lp2 %85 %99 value=l1/2
Lm1 %vminus %117 value=l1/4
Lm2 %95 %84 value=l1/2
Lom %122 %0 value=lom
Rrtn %DUT_Ground %0 .0001
Rc %164 %DUT_Ground .0001
Rlossp %99 %159 value=rloss
Rlossm %160 %95 value=rloss
Rdp %159 %118 value=rd
Rdm %117 %160 value=rd
Rtm %vdom %89 value=rt
Rtp %88 %vdop value=rt
Rcxp %vdop %122 50
Rcxm %122 %vdom 50
Rom %122 %0 value=rom
```

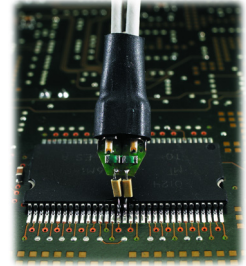

E2676B Single-Ended Browser Head

```
.param rd=82 rt=25k rom=100 rloss=25 l1=3.5n l2=.5n lom=2u
cg1=270f cg2=370f ct=200f
```

```
.ac dec 77 200k 19.7g
.options map
vsplus %130 %165 ACMag=1
Csg4 %vsop %134 value=cg2/2
Cstp %vsop %131 value=ct
Csg2 %138 %139 value=cg1/2
Csg3 %132 %134 value=cg2/2
Csg1 %137 %136 value=cg1/2
Lsp1 %141 %130 value=l1*3/8
Lsp2 %138 %137 value=l1*3/4
Lsg1 %165 %164 value=l1/8
Lsg2 %136 %139 value=l1/4
Lsom %134 %0 value=lom
Lsp4 %132 %131 value=l2
Lsp3 %132 %138 value=l1*3/8
Lsg3 %139 %134 value=l1/8
Rtrn %165 %0 .0001
Rdummy %164 %136 .0001
Rslossp %137 %161 value=rloss
Rdsp %161 %141 value=rd
Rstp %131 %vsop value=rt
Rscxp %vsop %134 50
Rsom %134 %0 value=rom
```

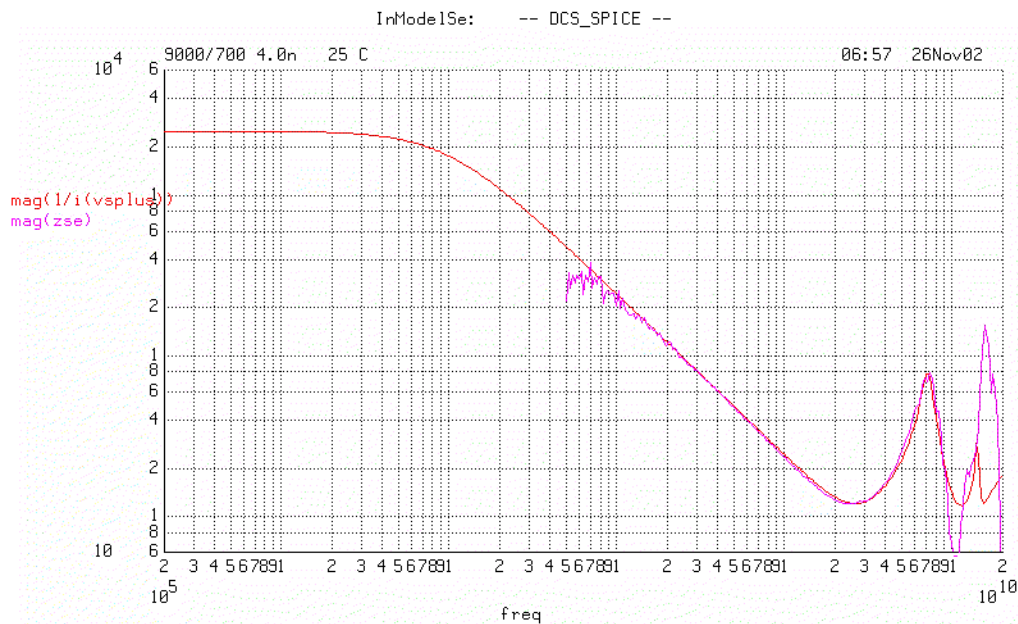
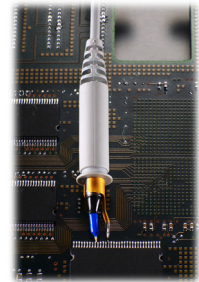

E2679B Single-Ended Solder-In Head

Data for full bandwidth with 91Ω resistor.

```
.param rd=91 rt=25k rom=250 rloss=25 l1=3n l2=.5n lom=2u
cg1=150f cg2=300f ct=200f
```

```
.ac dec 77 200k 19.7g
.options map
vsplus %130 %165 ACMag=1
Csg4 %vsop %134 value=cg2/2
Cstp %vsop %131 value=ct
Csg2 %138 %139 value=cg1/2
Csg3 %132 %134 value=cg2/2
Csg1 %137 %136 value=cg1/2
Lsp1 %141 %130 value=l1*3/8
Lsp2 %138 %137 value=l1*3/4
Lsg1 %165 %164 value=l1/8
Lsg2 %136 %139 value=l1/4
Lsom %134 %0 value=lom
Lsp4 %132 %131 value=l2
Lsp3 %132 %138 value=l1*3/8
Lsg3 %139 %134 value=l1/8
Rtrn %165 %0 .0001
Rdummy %164 %136 .0001
Rslossp %137 %161 value=rloss
Rdsp %161 %141 value=rd
Rstp %131 %vsop value=rt
Rscxp %vsop %134 50
Rsom %134 %0 value=rom
```

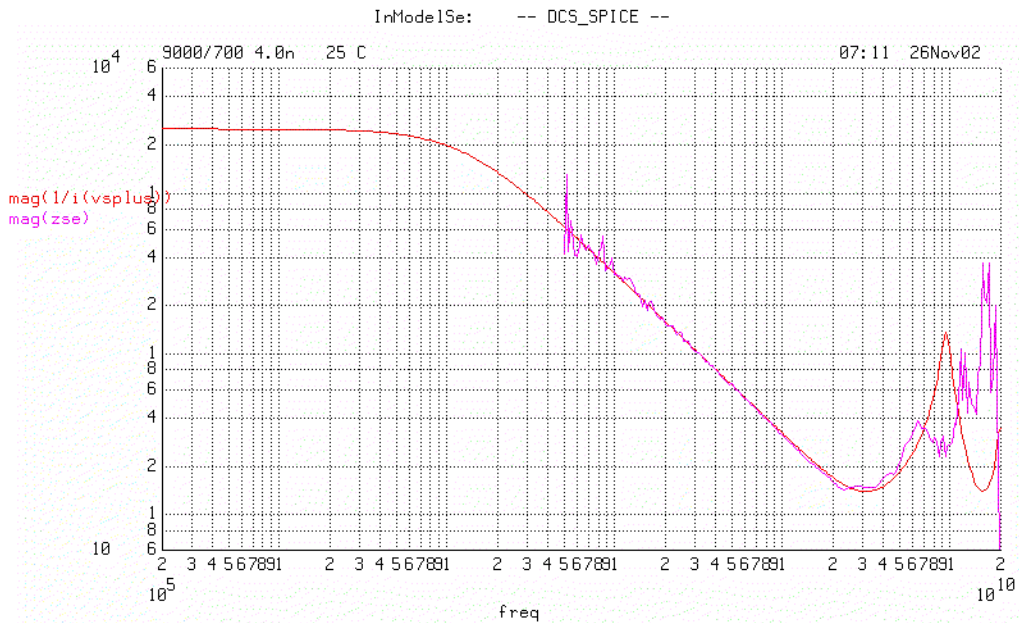
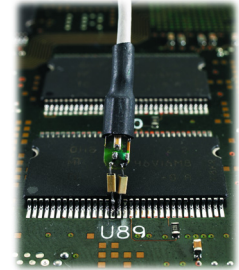

9 Replacement Parts

N5381B and N5382A Probe Heads	258
N2839A Browser Head	258
E2679B Single-Ended Solder-in Probe Head	258
E2678B Differential Socketed Probe Head	259
E2677B Differential Solder-In Probe Head	260
E2675B Differential Browser Probe Head	260
Other Accessories	261

N5381B and N5382A Probe Heads

Table 34 Replacement Wire

Description	Qty	Order Part Number
0.005 steel wire and trim gauge (N5382A)	1	01169-21304
0.007 tin-plated nickel wire and trim gauge (N5381B)	1	01169-81301
0.005 tin-plated nickel wire and trim gauge (N5381B)	1	01169-21306

N2839A Browser Head

Table 35 N2837A Kit

Description	Qty Supplied
Spring-loaded tips. (0.0115 in. diameter, 0.126 in. long)	20

E2679B Single-Ended Solder-in Probe Head

Table 36 Resistors

Description	Qty	Order From Vendor	Orderable Part Number
0 Ω resistor	1	BREL International	RMB16-000-JB
91 Ω resistor	1	BREL International	RMB16-910-JB

E2678B Differential Socketed Probe Head

Table 37 E2671B Kit

Description	Qty Supplied
160Ω damped wire accessory	6
82Ω resistor for full bandwidth	48
Socket for 25 mil (25/1000 inch) square pins, female on both ends	4
25 mil female socket w/20 mil round male pin on other end	4
Heatshrink socket accessory	4
Header adapter, 90Ω	2
82Ω resistor template	1

Table 38 Resistors

Description	Qty	Order From Vendor	Orderable Part Number
82Ω resistor	1	Vishay	MBA0204AC8209GC100

E2677B Differential Solder-In Probe Head

Table 39 E2670B Kit

Description	Qty Supplied
91Ω resistor for full bandwidth	20
150Ω resistor for medium bandwidth	10
91Ω resistor template	1
150Ω resistor template	1

Table 40 Resistors

Description	Qty	Order From Vendor	Orderable Part Number
91Ω resistor	1	BREL International	RMB16-910-JB
150Ω resistor	1	BREL International	RMB16A-151-JB

E2675B Differential Browser Probe Head

Table 41 E2658B Kit

Description	Qty Supplied
Resistive tip (blue), 91Ω	20
Ergonomic handle	1

Other Accessories

Table 42 Accessories

Description	Vendor	Part Number	Qty
Probe Amplifier Ground Wire	–	01131-21301	1
Probe deskew and performance verification kit	Keysight	E2655C	1
160Ω damped wire accessory (01130-21303 34 each)	Keysight	E5381-82103	1
Header adapter kit for socketed differential probe head (01130-63201 10 each)	Keysight	01131-68703	1
Coupling tag for N5450B extreme temperature cable extension	Keysight	N5450-21201	1
SMA coaxial dc block	Inmet	#8037	1
SMA 6 dB coaxial attenuator	Inmet	#18AH-6	1
SMA 12 dB coaxial attenuator	Inmet	#18AH-12	1
SMA adjustable delay	ATM Microwave	#P1907	1
GPO-F to GPO-F adapter for N5380B	Corning Gilbert Rosenberger	#A1A1-0001-03 #19K 109-K00 E4	2

Index

A

accessories, 11
 damped wire, 84
 supplied, 11
 altitude, 143
 attenuator kit, 24
 attenuators, 26

B

browser, differential, 79
 browser, single-ended, 82

C

calibration
 failure, 33
 probe, 123
 probe with oscilloscope, 124
 channel identification rings, 10
 characteristics, 143
 cleaning, 10
 cleaning the probe, 10
 compatible oscilloscopes, 10

D

damped wire accessory, 84
 DC blocking caps, 28
 dialog box
 Probe Offset, 18
 differential browser, 79
 differential probe head, 75, 77,
 84
 dimensions, 143
 probe amp, 146

E

E2676B, 82
 E2677B, 75
 E2678B, 77, 84
 E2679B, 81
 environmental conditions, 143
 ergonomic handle, 58
 ESD tolerance, 140
 extended offset, 26
 extreme temp, 22

F

full bandwidth probe, 75, 77,
 81

G

general characteristics, 143

H

handle, 58
 humidity, 143

I

inspecting, 10

K

Keysight Technologies,
 contacting, 35

M

MX0100A corrected frequency
 response, 152
 MX0100A dimensions, 145
 MX0100A input
 impedance, 156
 MX0100A lead wires, 43
 MX0100A step response, 153
 MX0100A strain relief, 47
 MX0102A, 29

N

N1022A/B adapter, 10
 N2833A, 21
 N2851A QuickTip, 67
 N2880A, 26
 N2880A attenuators, 24
 N2881A CD blocking caps, 28
 N2884A, 64
 using, 90
 N2884A fine wire ZIF tip
 dimensions, 148
 N2887A, 98
 N2888A, 98
 N5380B, 60
 N5381B, 50

N5382A, 52, 57
 N5425B, 63
 N5426A, 63
 N5442A adapter, 10
 N5450B cable, 22
 N5451A, 71, 73

O

offset, 16
 operating environment, 143

P

performance test record, 219
 performance verification, 205
 pollution degree, 143
 power requirements, 143
 probe
 cleaning, 10
 dimensions, 146
 inspecting, 10
 service, 34
 probe amplifier, 14
 probe cable, 13
 probe calibration, 123
 probe handling, 12
 probe heads
 disconnecting, 12
 E2675B, 40
 E2676B, 40
 E2677B, 40
 E2678B, 40
 E2679B, 40
 MX0100A, 38
 N5380B, 38
 N5381B, 38
 N5382A, 38
 N5425B, 38, 39
 Probe Offset dialog box, 18

Q

QuickTip, 67

R

recommended
 configuration, 38
 resistance testing, 215

resistor

- dimensions, 109
- returning for service, 34
- robe's ground lead, 31

S

- s parameter, 44
- safety, 31
- Safety Considerations, 31
- safety information, 31
- safety warnings, 31
- single-ended browser, 82
- single-ended probe head, 81
- slew rate requirements, 19
- slew rates, 19
- socketed differential probe, 77, 84
- solder-in differential, 75
- solder-in single-ended probe, 81
- soldering toolkit, 29
- specifications, 137, 221

T

- temperature, 143
- temperature chamber, 22
- testing
 - input resistance, 215
- trim gauge template, 44

V

- velcro dots, 15

W

- WEEE compliance, 138
- weight, 143

Z

- ZIF Tip
 - soldering, 86
- ZIF tip
 - N2884A, 39
 - N5426A, 38
 - N5451A, 39