

DP0001A High Voltage Differential Probe

User's Guide



Notices

© Keysight Technologies 2020, 2022

No part of this manual may be reproduced in any form or by any means (including electronic storage and retrieval or translation into a foreign language) without prior agreement and written consent from Keysight Technologies as governed by United States and international copyright laws.

Manual Part Number

DP0001-97000, March 2022
Available in electronic format only

Published by

Keysight Technologies, Inc.
1900 Garden of the Gods Road
Colorado Springs, CO 80907 USA

Warranty

THE MATERIAL CONTAINED IN THIS DOCUMENT IS PROVIDED "AS IS," AND IS SUBJECT TO BEING CHANGED, WITHOUT NOTICE, IN FUTURE EDITIONS. FURTHER, TO THE MAXIMUM EXTENT PERMITTED BY APPLICABLE LAW, KEYSIGHT DISCLAIMS ALL WARRANTIES, EITHER EXPRESS OR IMPLIED WITH REGARD TO THIS MANUAL AND ANY INFORMATION CONTAINED HEREIN, INCLUDING BUT NOT LIMITED TO THE IMPLIED WARRANTIES OF MERCHANTABILITY AND FITNESS FOR A PARTICULAR PURPOSE. KEYSIGHT SHALL NOT BE LIABLE FOR ERRORS OR FOR INCIDENTAL OR CONSEQUENTIAL DAMAGES IN CONNECTION WITH THE FURNISHING, USE, OR PERFORMANCE OF THIS DOCUMENT OR ANY INFORMATION CONTAINED HEREIN. SHOULD KEYSIGHT AND THE USER HAVE A SEPARATE WRITTEN AGREEMENT WITH WARRANTY TERMS COVERING THE MATERIAL IN THIS DOCUMENT THAT CONFLICT WITH THESE

TERMS, THE WARRANTY TERMS IN THE SEPARATE AGREEMENT WILL CONTROL.

U.S. Government Rights

The Software is "commercial computer software," as defined by Federal Acquisition Regulation ("FAR") 2.101. Pursuant to FAR 12.212 and 27.405-3 and Department of Defense FAR Supplement ("DFARS") 227.7202, the U.S. government acquires commercial computer software under the same terms by which the software is customarily provided to the public. Accordingly, Keysight provides the Software to U.S. government customers under its standard commercial license, which is embodied in its End User License Agreement (EULA), a copy of which can be found at <http://www.keysight.com/find/sweula>. The license set forth in the EULA represents the exclusive authority by which the U.S. government may use, modify, distribute, or disclose the Software. The EULA and the license set forth therein, does not require or permit, among other things, that Keysight: (1) Furnish technical information related to commercial computer software or commercial computer software documentation that is not customarily provided to the public; or (2) Relinquish to, or otherwise provide, the government rights in excess of these rights customarily provided to the public to use, modify, reproduce, release, perform, display, or disclose commercial computer software or commercial computer software documentation. No additional government requirements beyond those set forth in the EULA shall apply, except to the extent that those terms, rights, or licenses are explicitly required from all providers of commercial computer software pursuant to the FAR and the DFARS and are set forth specifically in writing elsewhere in the EULA. Keysight shall be under no obligation to update, revise or otherwise modify the Software. With respect to any technical data as

defined by FAR 2.101, pursuant to FAR 12.211 and 27.404.2 and DFARS 227.7102, the U.S. government acquires no greater than Limited Rights as defined in FAR 27.401 or DFAR 227.7103-5 (c), as applicable in any technical data. 52.227-14 (June 1987) or DFAR 252.227-7015 (b)(2) (November 1995), as applicable in any technical data.

Safety Notices

CAUTION

A CAUTION notice denotes a hazard. It calls attention to an operating procedure, practice, or the like that, if not correctly performed or adhered to, could result in damage to the product or loss of important data. Do not proceed beyond a CAUTION notice until the indicated conditions are fully understood and met.

WARNING

A WARNING notice denotes a hazard. It calls attention to an operating procedure, practice, or the like that, if not correctly performed or adhered to, could result in personal injury or death. Do not proceed beyond a WARNING notice until the indicated conditions are fully understood and met.

Contents

1 DP0001A Probe - Overview

- Introduction / 6
- Supplied Accessories / 9
- Replacement Accessories / 11
- Optional Accessories / 13
- Oscilloscope Compatibility / 14
- Specifications and Characteristics / 15
 - Probe Dimensions / 19

2 General Information

- Inspecting the Probe / 22
- Cleaning the Probe / 23
- Handling the Probe / 24
- Returning the Probe for Service / 25
- Contacting Keysight Technologies / 26

3 Safety and Regulatory Information

- Instrument Markings and Symbols / 29

4 Setting up and Using the Probe

- Grounding the Probe / 31
- Using the Supplied Accessories / 31
- Configuring the DP0001A Settings in the Oscilloscope Software GUI / 32

On an Infiniium Oscilloscope / 32
On an InfiniiVision Oscilloscope / 34
Extreme Temperature Testing / 37

5 Performance Plots

Typical Voltage Derating (Mains Isolated) / 40
Typical Input Impedance / 41
Frequency Response / 42
 DP0001A Frequency Response Test Setup / 42
Common Mode Rejection Ratio over Frequency / 44

6 Performance Verification

Before you Start / 50
 Recommended Test Interval / 50
DC Differential Gain Accuracy Verification / 51
 Required Test Equipment / 51
 Procedure / 52
Bandwidth Verification / 56
 Required Test Equipment / 56
 Procedure / 57
Performance Verification Test Record / 62

Index

1 DP0001A Probe – Overview

Introduction	6
Supplied Accessories	9
Replacement Accessories	11
Optional Accessories	13
Oscilloscope Compatibility	14
Specifications and Characteristics	15
Probe Dimensions	19

Introduction

The DP0001A probe is a 400 MHz, 2000 V (Mains Isolated) / 1000 V (CAT III) differential high voltage probe that you can use with a Keysight oscilloscope having 50 Ω input impedance.

You can use this probe effectively for the following measurements:

- General purpose power, Wide Bandgap (WBG) devices, and fast transient power measurements with bandwidths of up to 400 MHz.
- Power device evaluation such as measurements in IGBT circuits used in the design of motor drives, switching power supplies and frequency especially for characterizing 1700 V IGBT modules for inverters and converters.
- Non-ground referenced floating signal measurements.

Following are the key features of this probe:

- When used with an Infiniium oscilloscope, the probe supports an auto-switchable attenuation ratio that automatically sets the probe attenuation to the value necessary to make the dynamic range of the probe greater than or equal to the level required to measure the current input signal.

When used with an InfiniiVision oscilloscope, the probe provides four manually switchable modes of attenuation so that you can set the probe attenuation to the value necessary to make the dynamic range of the probe greater than or equal to the level required to measure the current input signal.

- Provides an overload indicator using which you can easily observe that the probe is working within the specified range.

You can configure the attenuation, offset, and other settings for the probe using the Infiniium / InfiniiVision software GUI provided with the Keysight oscilloscopes.

A variety of accessories are shipped with this probe to suit various DUT connection scenarios and to make the connection to compact target devices possible (see [page 9](#)).

CAUTION

Before using the probe, refer to **“Safety and Regulatory Information”** on page 27. Handle the probe with care and avoid any mechanical shocks to this product to ensure accurate performance and protection.

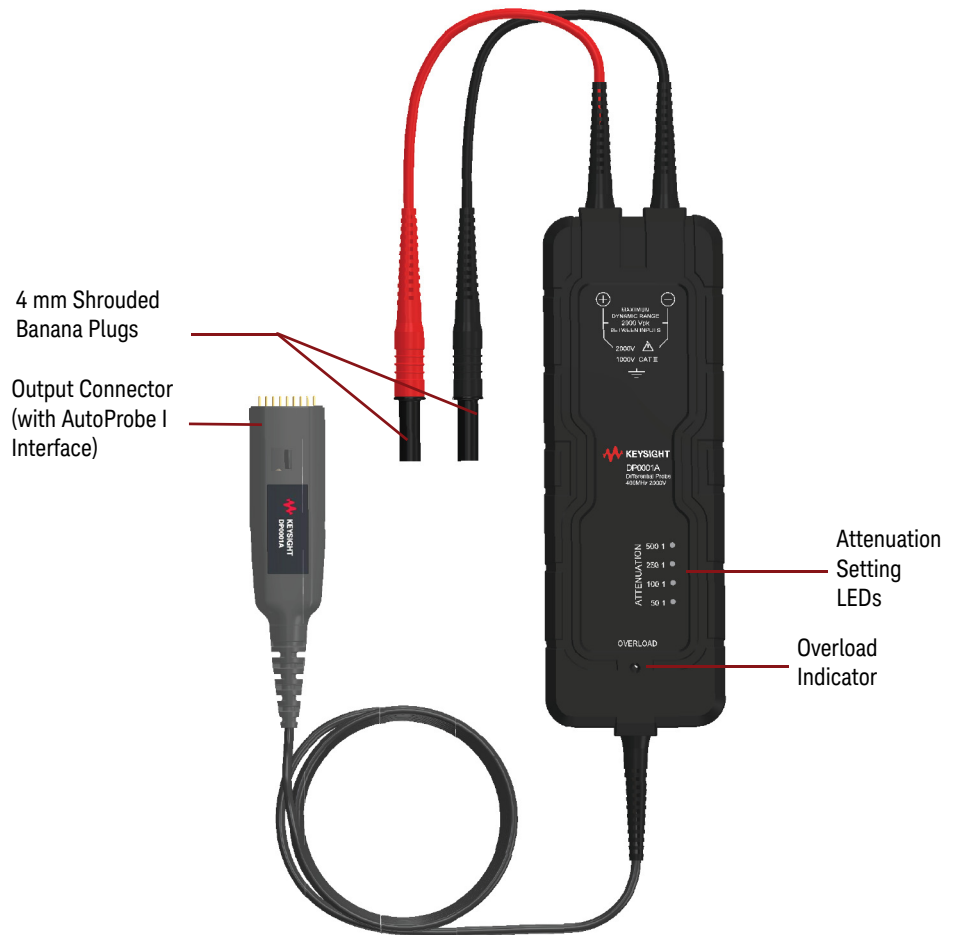

Figure 1 DP0001A probe

Probe Component	Description
Output Connector (with AutoProbe I Interface)	<p>The probe's output connector has the AutoProbe I interface that allows it to connect directly to a channel of a compatible Keysight InfiniiVision or Infiniium oscilloscope.</p> <p>The oscilloscope's AutoProbe interface provides the probe power and auto-configuration of probe type and attenuation setting on connection.</p>
4mm Shrouded Banana Plugs	<p>Connects the probe to the DUT via various accessories provided with the probe.</p>
Attenuation Setting LEDs	<p>LEDs to indicate the currently set attenuation ratio for the probe. There are four LEDs for the four attenuation modes of the probe.</p> <p>On an Infiniium oscilloscope, the attenuation is automatically adjusted. On an InfiniiVision oscilloscope, you need to manually set the appropriate attenuation mode.</p>
Overload Indicator	<p>LED to indicate an overvoltage condition on the probe.</p> <p>Adjusting the attenuation for the probe can prevent/resolve the overvoltage condition. On an Infiniium oscilloscope, the attenuation is automatically adjusted. On an InfiniiVision oscilloscope, you need to manually set the appropriate attenuation mode.</p> <p>Refer to the topics Setting the Attenuation Mode on page 32 and page 34 to know more.</p>

Supplied Accessories

The DP0001A probe is shipped with the standard accessories listed below.

Table 1 Supplied accessories (listed in the order of supported bandwidth at the 500:1 attenuation ratio)









Recommended Order of Use (as per bandwidth)	Accessory	Qty Supplied	Bandwidth ^a (at 500:1 attenuation ratio)	Rated Input Voltage
1	Probe Tip Adapters (4 mm to 0.8 mm) 	2 (black)	400 MHz	1000 V CAT II
	With Fine Spring Tips (0.6 mm) 	4		30 V AC / 60 V DC*
	With Contact Pins (0.64 mm) 	10		30 V AC / 60 V DC*
2	Safety Alligator Clips (small) 	1 (red) 1 (black)	400 MHz	600 V CAT II
3	Spade Terminals (narrow) 	1 (red) 1 (black)	400 MHz	30 V AC / 60 V DC*

Table 1 Supplied accessories (listed in the order of supported bandwidth at the 500:1 attenuation ratio)

Recommended Order of Use (as per bandwidth)	Accessory	Qty Supplied	Bandwidth ^a (at 500:1 attenuation ratio)	Rated Input Voltage
4	Alligator Plunger Clips 	1 (red) 1 (black)	200 MHz	1000 V CAT III
5	Pincer Clips 	1 (red) 1 (black)	200 MHz	1000 V CAT II
6	Hook Tip Adapters 	1 (red) 1 (black)	200 MHz	1000 V CAT II
	Coupler f-f (4 mm) 	1 (red)	Not Applicable	30 V AC/60 V DC*





* Not rated for measurement categories II, III, or IV







^a The DP0001A probe supports four attenuation modes. The accessories shown above have different bandwidth values at different attenuation modes. These bandwidth values are provided in [Table 4](#).

Replacement Accessories

Besides the standard accessories that are shipped with the probe, replacement accessories are also available that you can order separately as the following replacement kit.

Table 2 Replacement accessories

Accessory Kit		Qty Supplied
DP0002A High Voltage Differential Probe Accessory Kit		
Probe Tip Adapters (4 mm to 0.8 mm)		2 (black)
Fine Spring Tips (0.6 mm)		4
Contact Pins (0.64 mm)		10
Safety Alligator Clips (small)		1 (red) 1 (black)
Spade Terminals (narrow)		1 (red) 1 (black)

Accessory Kit		Qty Supplied
Alligator Plunger Clips		1 (red) 1 (black)
Pincer Clips		1 (red) 1 (black)
Hook Tip Adapters		1 (red) 1 (black)
Coupler f-f (4 mm)		1 (red)
Replacement Kit - Spring Tips (part number 0960-3504)		
Fine Spring Tips (0.6 mm)		4
Replacement Kit - Contact Pins (part number 0960-3503)		
Contact Pins (0.64 mm)		10

Optional Accessories

For extreme temperature probing, you can use the N7013/14A extreme temperature probing kit with the DP0001A probe. The N7013A extreme temperature cable set provides $-40\text{ }^{\circ}\text{C}$ to $+85\text{ }^{\circ}\text{C}$ of operating temperature range and extends the input cable length by 70 cm. You can order this kit separately.

CAUTION

Only the parts included in the extreme temperature probing kit are rated to extreme temperatures. The DP0001A probe, its cable, and its standard/replacement accessories should not be exposed to extreme temperatures.

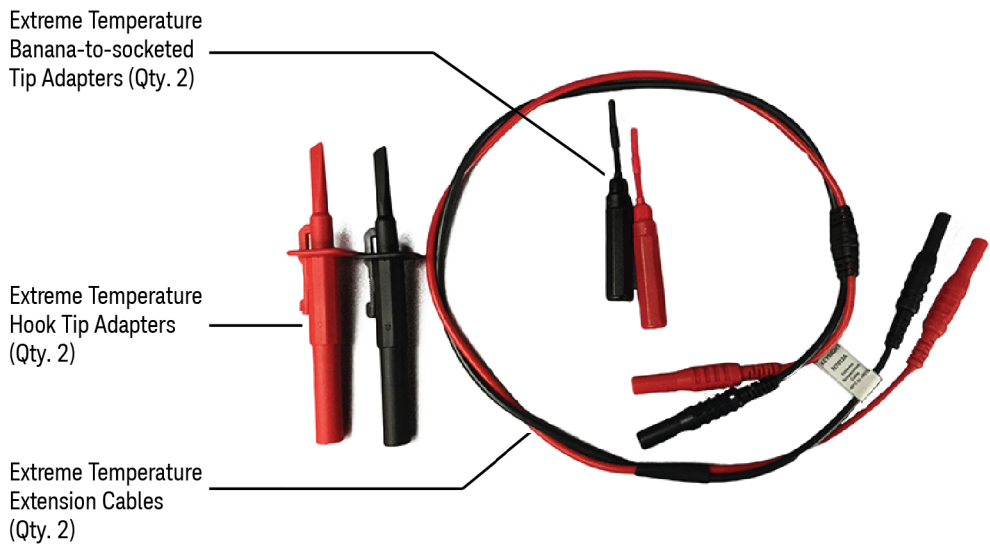

Figure 2 N7013/14A Extreme Temperature Probing Kit

Oscilloscope Compatibility

Compatible Infiniium Oscilloscopes	Required Adapter(s)	Required Software Version
S-Series	-	6.50 or higher
V-Series	N5442A adapter	
Z-Series	N5442A adapter	
9000A-Series	-	
9000X-Series	-	
EXR-Series		11.06.00401 or higher
MXR-Series		11.00 or higher
UXR-Series (13 GHz to 33 GHz)	N5442A adapter	10.20 or higher
Compatible InfiniiVision Oscilloscopes	Required Adapter(s)	Required Software Version
3000T X-Series	-	7.31 or higher
4000 X-Series	-	
6000 X-Series	-	

Is Your Oscilloscope Software Up-to-Date? Keysight periodically releases software updates to support your probe, fix known defects, and incorporate product enhancements. To download the latest firmware, go to www.keysight.com and search for your oscilloscope. Click on the “Drivers, Firmware & Software” tab.

Specifications and Characteristics

The probe and oscilloscope should be warmed up for at least 20 minutes before any testing and the environmental conditions should not exceed the probe's specified limits.

NOTE

All entries included in the following table are characteristics unless otherwise stated.

DC gain and **Bandwidth** are the only warranted specifications for the DP0001A probe.

Table 3 Electrical Characteristics

Characteristic	Value measured at the four supported attenuation modes			
	50:1	100:1	250:1	500:1
Probe Bandwidth (-3dB) *	400 MHz			
Risetime (10% - 90%)				
Input Voltage 50 V	1.2 nsec	1.2 nsec	875 psec	875 psec
Input Voltage 500 V	Not Applicable	Not Applicable	1.2 nsec	1.2 nsec
Input Voltage 1000 V	Not Applicable	Not Applicable	Not Applicable	1.2 nsec
Maximum Rated Input Voltage				
Mains Isolated † 	2000 Vrms 6000 V Overvoltage Transient			
CAT III ‡	1000 V			
Noise (Vrms ** / spectral density) (Referred to the input)	180 mV / 9 uV/rt (Hz)	180 mV / 9 uV/rt (Hz)	280 mV / 14 uV/rt (Hz)	300 mV / 15 uV/rt (Hz)
Typical Propagation Delay	10 ns			
Maximum Differential Input Voltage (DC + AC peak)	± 200 V	± 400 V	± 1000 V	±2000 V

Characteristic	Value measured at the four supported attenuation modes			
	50:1	100:1	250:1	500:1
Common Mode Voltage	± 2000 Vpk (1400 Vrms)			
DC Gain Accuracy *	± 0.7 %	± 0.7 %	± 0.7 %	± 0.35 %
Offset Drift ††	150 µV / °C	150 µV / °C	40 µV / °C	40 µV / °C
Input Impedance				
Each Input to Ground	5 MΩ 4pF			
Differential Input Impedance	10 MΩ 2pF			
Input Coupling of the oscilloscope ††	AutoProbe Interface 50 Ω			
Typical CMRR (dB)				
DC	>80			
100 kHz	75	70	65	60
1 MHz	75	70	65	60
10 MHz	70	58	54	50
100 MHz	45	40	35	32

* Warranted specification

† Mains isolated is for measurements performed on circuits not directly connected to a mains supply.

‡ Measurement category III is for measurements performed in the building installation.

** Broadband Noise, Bandwidth 400 MHz.

†† Referred to the output of the probe.

‡‡ Must be met to achieve the best performance and to avoid damage to the probe.

Table 4 Bandwidth Values for the Probe When Used with Different Supplied Accessories

Accessory	Bandwidth (MHz, -3dB) measured at the four supported attenuation modes			
	50:1	100:1	250:1	500:1
Probe Tip Adapter with Contact Pins	300	400	400	400
Probe Tip Adapter with Fine Spring Tips	250	400	400	400
Spade Terminals	250	260	360	400
Safety Alligator Clips	250	400	400	400
Pincer Clips	200	200	200	200
Alligator Plunger Clips	200	200	200	200
Hook Tip Adapter	200	200	200	200

NOTE

All these bandwidth measurements are input cable shape independent. With two input cables of DP0001A running in parallel, the DP0001A with the probe tip adapter and contact pins / fine spring pins provides 400 MHz at all attenuation ratio settings.

Table 5 Mechanical Characteristics

Characteristic	Value
Cable Length	2 m
Input Lead Length	25 cm
Input Lead Connector	2 X 4 mm (male)
Output Connector	AutoProbe Interface (50 Ω terminated)
Probe Dimensions	Refer to "Probe Dimensions" on page 19

Table 6 Safety Specifications

Specification
IEC/EN61010-031:2015

Table 7 Environmental Characteristics

Characteristic	Value
Use	For indoor use only
Temperature	Probe Operating: 0 °C to +50 °C Non-operating: -40 °C to +55 °C Input Leads -40 °C to +55 °C
Altitude	Operating: 2000 m Non-operating: 15000 m
Maximum relative humidity	80% RH for temperatures up to 31 °C decreasing linearly to 40% at +50 °C
Pollution Degree	2

Probe Dimensions

The DP0001A probe dimensions shown below are in millimeters.

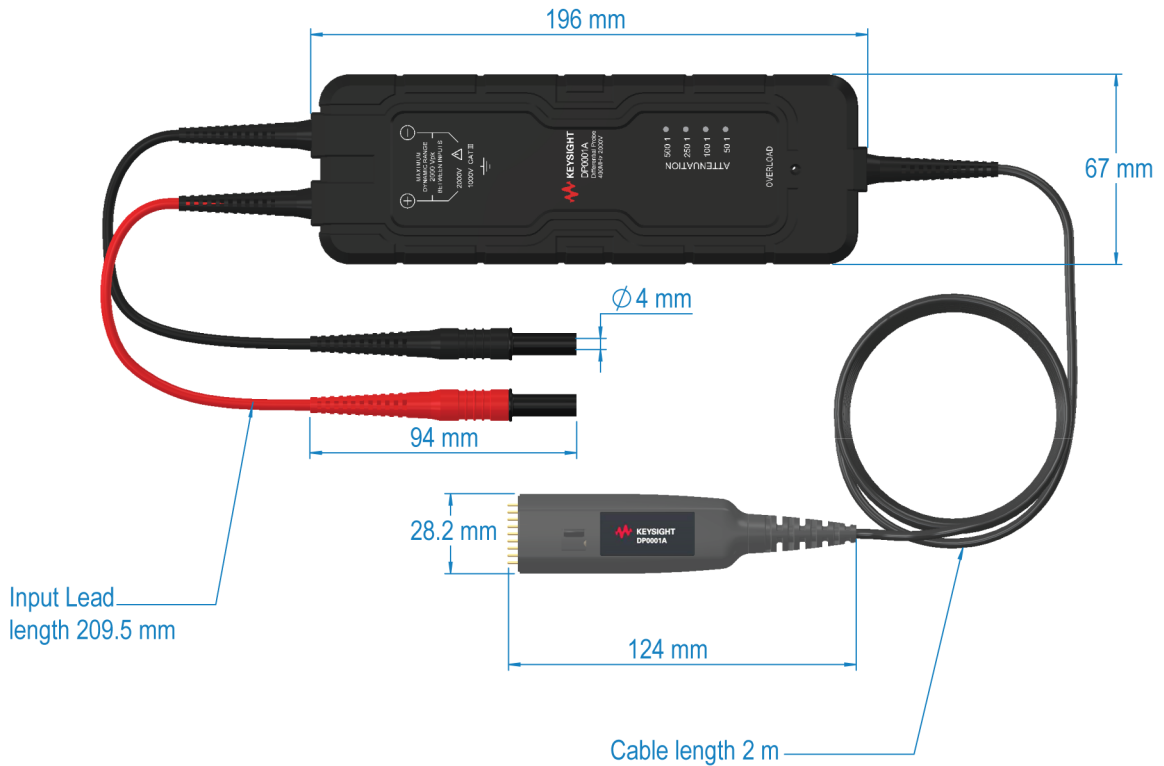

Figure 3 DP0001A dimensions

Probe Tip Adapter Dimensions

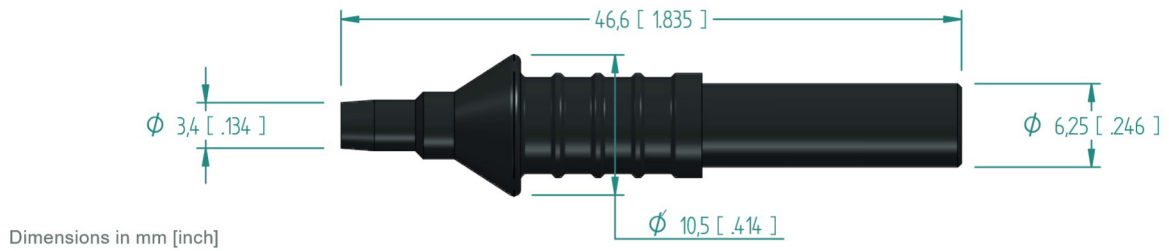

Figure 4 Probe tip adapter dimensions

2 General Information

Inspecting the Probe	22
Cleaning the Probe	23
Handling the Probe	24
Returning the Probe for Service	25
Contacting Keysight Technologies	26

Inspecting the Probe

- Inspect the shipping container for damage.

Keep the damaged shipping container or cushioning material until the contents of the shipment have been checked for completeness and the probe has been checked mechanically and electrically.

- Check the accessories.
- If the contents are incomplete or damaged, notify your Keysight Technologies Sales Office.
- Inspect the probe. If there is mechanical damage or defect, or if the probe does not operate properly or pass calibration tests, notify your Keysight Technologies Sales Office.

If the shipping container is damaged, or the cushioning materials show signs of stress, notify the carrier as well as your Keysight Technologies Sales Office. Keep the shipping materials for the carrier's inspection. The Keysight Technologies office will arrange for repair or replacement at Keysight Technologies' option without waiting for claim settlement.

WARNING

Must be Grounded. Before making connections to the input leads of this probe, ensure that the probe's output connector is attached to the channel input of the oscilloscope and the oscilloscope is properly grounded.

CAUTION

To protect against electrical shock, use only the accessories supplied with this probe or in the accessory kit.

Cleaning the Probe

If the probe requires cleaning:

- 1** Disconnect the probe from the oscilloscope and any circuit under test.
- 2** Gently clean the probe with a soft cloth dampened with a mild soap and water solution.
- 3** Wipe with clean water and then dry thoroughly with a clean cloth.
- 4** Make sure that the probe is completely dry before reconnecting it to an oscilloscope or circuit under test.

Handling the Probe

Handle the probe with care and refer to the safety notices in this manual.

The small electrical components of the probe are sensitive to shock and impact. Avoid any unnecessary kinetic stress to the probe such as throwing, falling, and strong vibrations to ensure accurate performance and protection.

Returning the Probe for Service

If the probe is found to be defective, Keysight recommends sending it to an authorized service center for all repair and calibration needs. Perform the following steps before shipping the probe back to Keysight Technologies for service.

- 1 Contact your nearest Keysight sales office for information on obtaining an RMA number and return address.
- 2 Write the following information on a tag and attach it to the malfunctioning equipment.
 - Name and address of owner
 - Product model number (DP0001A)
 - Product Serial Number
 - Description of failure or service required

NOTE

Include probing accessories if the probe is not meeting performance specifications or a yearly calibration is requested.

- 3 Protect the probe by wrapping in plastic or heavy paper.
- 4 Pack the probe in the original carrying case or if not available use bubble wrap or packing peanuts.
- 5 Place securely in sealed shipping container and mark container as "FRAGILE".

NOTE

If any correspondence is required, refer to the product by serial number and model number.

Contacting Keysight Technologies

For technical assistance, contact your local Keysight Call Center.

- In the Americas, call 1 (800) 829-4444
- In other regions, visit <http://www.keysight.com/find/assist>
- Before returning an instrument for service, you must first call the Call Center at 1 (800) 829-4444.

3 Safety and Regulatory Information



These probes have been designed and tested in accordance with accepted industry standards, and have been supplied in a safe condition.



Throughout this guide and specifically in this chapter, there are warnings, cautions, and notes that you must follow to ensure safe operation and to maintain the product in a safe condition.

WARNING

To avoid personal injury and to prevent fire or damage to this product or products connected to it, review and comply with the following safety precautions. Be aware that if you use this probe assembly in a manner not specified, the protection this product provides may be impaired.

WARNING



Use Only Grounded Instruments.

Always make sure the probe and oscilloscope are grounded properly. Before making connections to the input leads of this probe, ensure that the probe's output connector is attached to the channel input of the oscilloscope and the oscilloscope is properly grounded.

WARNING

Connect and Disconnect Properly.

Connect the probe to the oscilloscope before connecting the probe to the circuit under test. Disconnect the probe input from the circuit under test before disconnecting the probe from the oscilloscope.

CAUTION



The probe inputs are safely rated to a maximum of input voltage of 2000 V Mains Isolated or 1000 V CAT III. These maximum ratings apply regardless of the attenuation setting of the probe. Do not apply voltages greater than 2000 V Mains isolated or 1000 V CAT III between either inputs and ground.

Mains isolated is for measurements performed on circuits not directly connected to a mains supply.

Measurement Category III is for measurements performed in the building installation.

WARNING



Observe probe and probe accessory ratings.

Do not apply any electrical potential to the probe input which exceeds the maximum ratings of the probe or the accessories (see [page 9](#)) connected to it. The applicable Measurement Category of a combination of a probe assembly and an accessory is the lower of the Measurement Categories of the probe assembly and of the accessory.

Make sure to comply with the voltage versus frequency derating curve on [page 40](#).

WARNING

Do Not Operate Without Covers. To avoid electrical shock or fire hazard, do not operate this probe with the covers removed.

WARNING

Avoid Exposed Circuit. To avoid injury, remove jewelry such as rings, watches, and other metallic objects. Do not touch exposed connections and components when power is present.

WARNING

For Indoor Use Only. Do not operate in wet / damp environments to avoid electric shock. Keep product surfaces dry and clean. Do not operate in an explosive environment.

WARNING

Periodically inspect the probe and probe wires to check for any damage. Do Not Operate With Visible or Suspected Failures. If you suspect there is damage, have it inspected by a Keysight authorized service personnel.







WARNING

Whenever it is likely that the ground protection is impaired, you must make the instrument inoperative and secure it against any unintended operation.

CAUTION

The small electrical components of the probe are sensitive to shock and impact. Avoid any unnecessary kinetic stress to the probe such as throwing, falling, and strong vibrations.

Instrument Markings and Symbols

Marking	Description
	The CE mark is a registered trademark of the European Community. ISM GRP 1-A denotes the instrument is an Industrial Scientific and Medical Group 1 Class A product. ICES/NMB-001 indicates product compliance with the Canadian Interference-Causing Equipment Standard.
	KC certification mark to demonstrate compliance with the South Korean EMC requirements. South Korean Class A EMC declaration This equipment is Class A suitable for professional use and is for use in electromagnetic environments outside of the home.
	This symbol indicates the Environmental Protection Use Period (EPUP) for the product's toxic substances for the China RoHS requirements.
	This product complies with the WEEE Directive (2002/96/EC) marking requirements. The affixed label indicates that you must not discard this electrical/electronic product in domestic household waste. Product Category: With reference to the equipment types in the WEEE Directive Annex I, this product is classed as a "Monitoring and Control instrumentation" product. Do not dispose in domestic household. To return unwanted products, contact your local Keysight office, or refer to www.keysight.com for more information.
	A registered trademark of the Spectrum Management Agency of Australia. This signifies compliance with the Australia EMC Framework regulations under the terms of the Radio Communication Act of 1992.
	The product is marked with this symbol when it is necessary for the user to refer to the instructions in the documentation.

Marking	Description
CAT II	IEC Measurement Category II is for measurements performed on circuits directly connected to the low voltage installation. Example: Household appliances, portable tools, and similar equipment.
CAT III	IEC Measurement Category III is for measurements performed in the building installation. Examples: Measurements on distribution boards, circuit breakers, wiring including cables, bus-bars, junction boxes, switches, socket-outlets in the fixed installation and equipment for industrial use like for example stationary motors with permanent connection to the fixed installation.
Mains Isolated	Mains isolated is for measurements performed on circuits not directly connected to a mains supply.
	Earth (ground) TERMINAL. Refer to the instructions accompanying this symbol in this manual.

4 Setting up and Using the Probe

Grounding the Probe	31
Using the Supplied Accessories	31
Configuring the DP0001A Settings in the Oscilloscope Software GUI	32
On an Infiniium Oscilloscope	32
Setting the Attenuation Mode	32
Performing DC Offset and Gain Calibration	33
On an InfiniiVision Oscilloscope	34
Setting the Attenuation Mode	34

Grounding the Probe

Connect the probe to the oscilloscope input before performing any measurements.

NOTE

The DP0001A probe is designed for ground-referenced measurements only.

Using the Supplied Accessories

Gently push the supplied accessories onto the probe leads.

Use the hook clips to clamp onto smaller components and the alligator clips to clamp onto thicker gauge devices.

Configuring the DP0001A Settings in the Oscilloscope Software GUI

After making hardware connections, perform the following steps in the Infiniium / InfiniiVision oscilloscope software GUI to configure probe settings such as attenuation ratio and DC offset and gain calibration. These settings are required to get accurate measurement results.

On an Infiniium Oscilloscope

Setting the Attenuation Mode

The probe supports four attenuation modes. An Infiniium oscilloscope automatically switches the attenuation mode for the probe to the value necessary to make the dynamic range of the probe greater than or equal to the level required to measure the current input signal.

The automatic switching of probe's attenuation also helps in preventing the overvoltage condition on the probe.

The Attenuation Setting LED on the probe indicates the currently set attenuation. You can also view the currently set attenuation in the Infiniium GUI's Probe Configuration dialog box as displayed below.

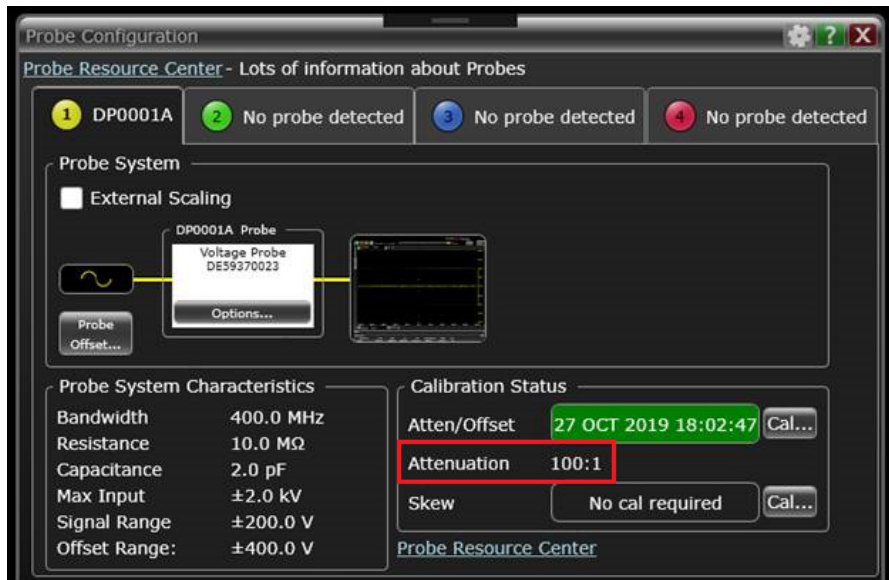

Performing DC Offset and Gain Calibration

Probe gain (or attenuation ratio) correction adjusts the oscilloscope's scaling factors of the signal displayed on screen to properly match the correct DC values. You need to perform the DC offset and gain calibration to remove the DP0001A offset errors. The most common correction method for probes is the DC adjustment, which entails the adjustment of probe gain and probe offset.

- 1 In the **Probe Configuration** dialog box, click the **Cal...** button next to **Atten/Offset**.

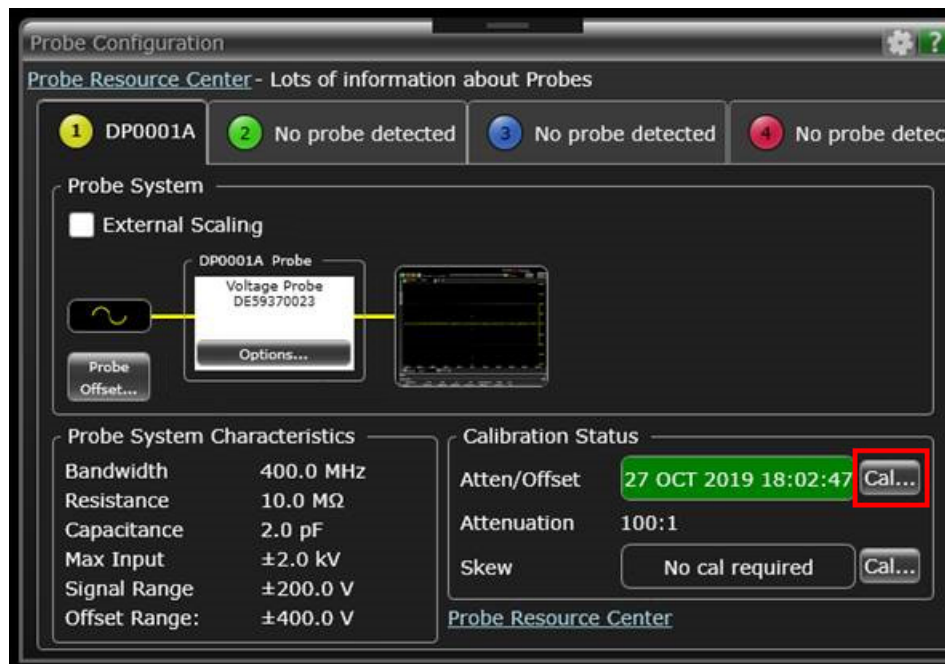

The **Probe Calibration** dialog box is displayed.

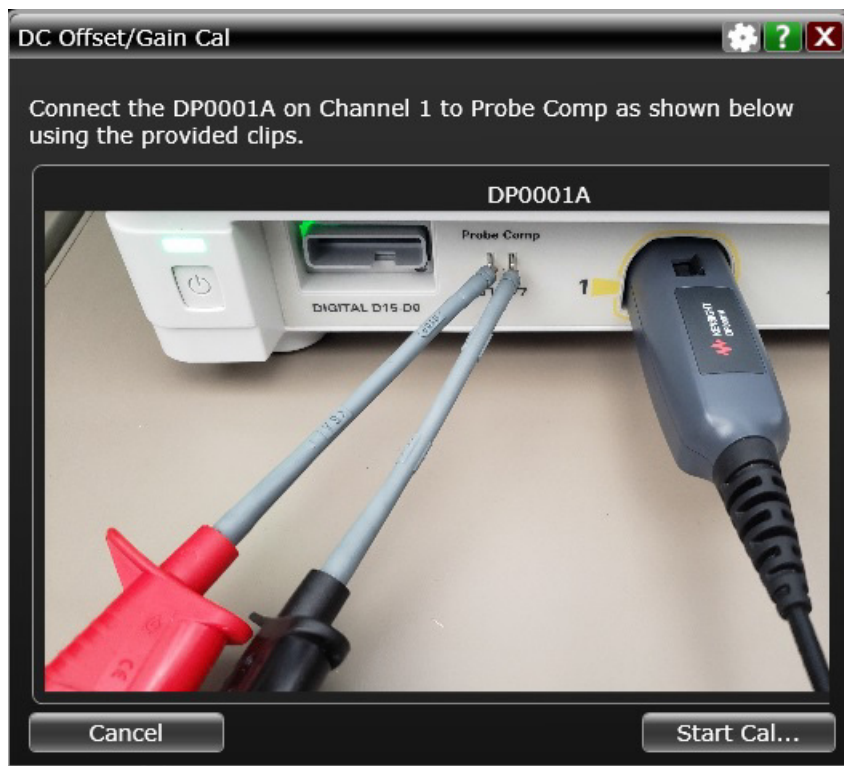

- 2 Ensure that the probe is connected to the oscilloscope as illustrated in the **DC Offset/Gain Cal** dialog box.
- 3 Click the **Start Cal...** button to initiate calibration.
- 4 Follow the instructions displayed on the Infiniium GUI screens.

On an InfiniiVision Oscilloscope

Setting the Attenuation Mode

On an InfiniiVision oscilloscope, you need to manually set the attenuation mode for the probe. The probe supports four modes of attenuation so that you can set the attenuation to the value necessary to make the dynamic range of the probe greater than or equal to the level required to measure the current input signal.

NOTE

If there is an overvoltage condition and the Overload Indicator LED on the probe lights up, you need to adjust the probe's attenuation to resolve this overload condition.

To set the attenuation mode

- 1 Press the channel key to which the probe is attached to display the Channel <N> menu.

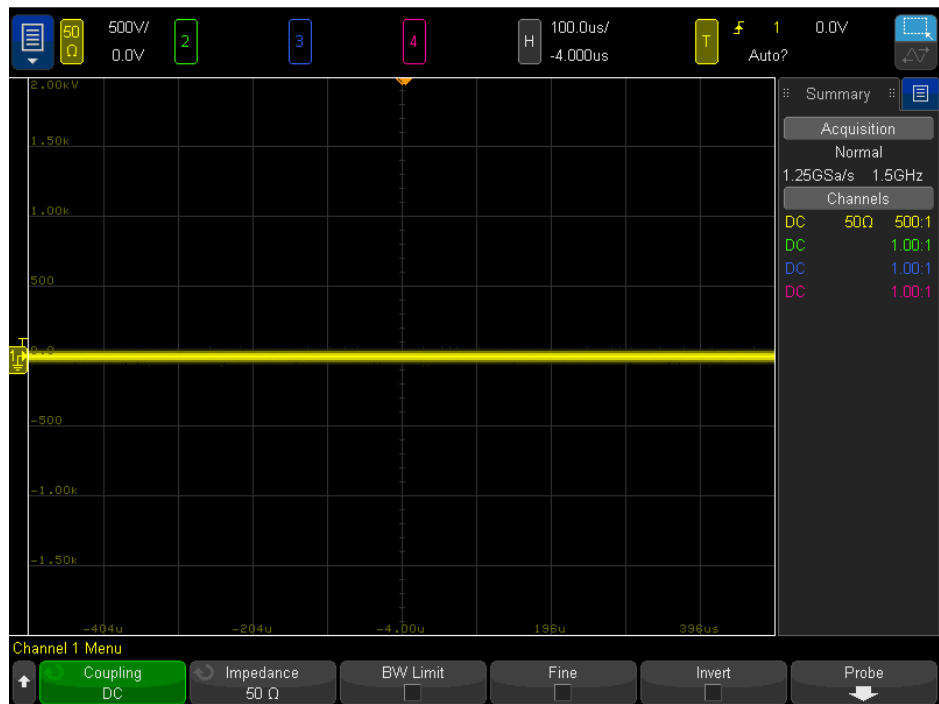

- 2 Press the **Probe** softkey to display the channel's probe menu.

4 Setting up and Using the Probe

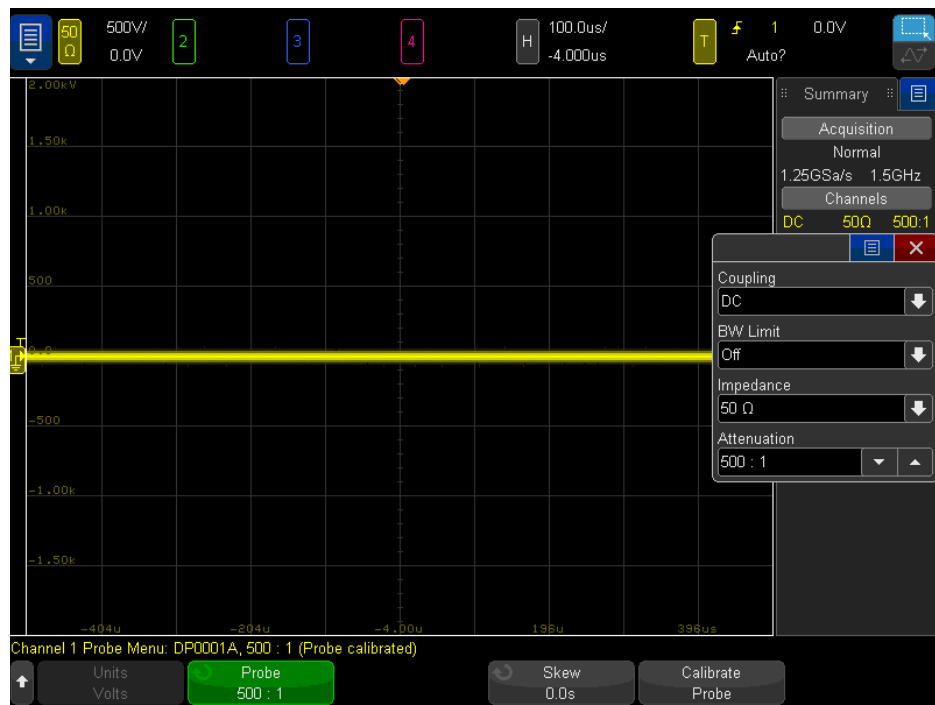

- 3 Set the attenuation for your probe using the Attenuation option in the Probe menu.

Extreme Temperature Testing

CAUTION

Only the extension cables and the tip adapters provided with the N7013/14A cables are rated to extreme temperatures. The DP0001A probe, its cable, and its accessories should not be exposed to extreme temperatures.

Perform the following steps to connect the N7013/14A extreme temperature kit to the DP0001A probe:

- 1 Connect the red and black extreme temperature differential extension cables to the probe leads.
- 2 Connect the red and black extreme temperature hook tip adapters to the extreme temperature differential extension cables.

Or

Connect the red and black extreme temperature banana-to-socketed tip adapters to the extreme temperature differential extension cables.

4 Setting up and Using the Probe

5 Performance Plots

Typical Voltage Derating (Mains Isolated)	40
Typical Input Impedance	41
Frequency Response	42
DP0001A Frequency Response Test Setup	42
Common Mode Rejection Ratio over Frequency	44

This chapter includes plots that show the characteristic performance and an input impedance model of the DP0001A probe.

Typical Voltage Derating (Mains Isolated)

WARNING

The maximum input voltage rating of the probe decreases as the frequency of the applied signal increases.



Typical Voltage Derating (mains isolated)

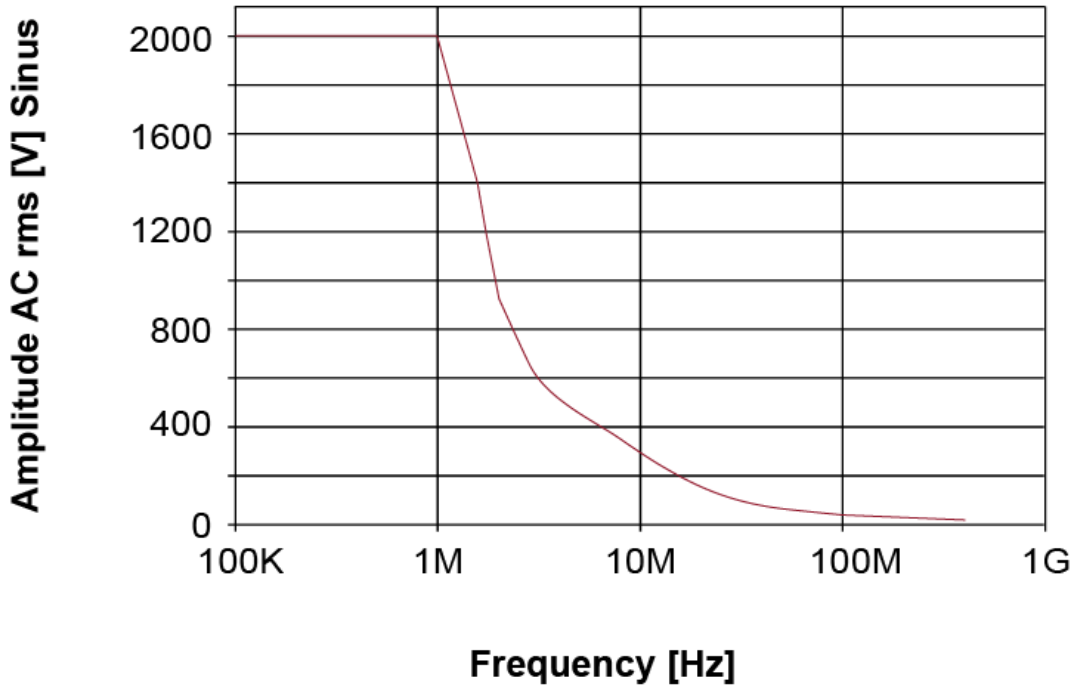

CAUTION

Refer to the oscilloscope documentation for the oscilloscope's acceptable input range and do not exceed this limit when using the probes.

Typical Input Impedance

CAUTION

The input impedance of the probe decreases as the frequency of the applied signal increases.

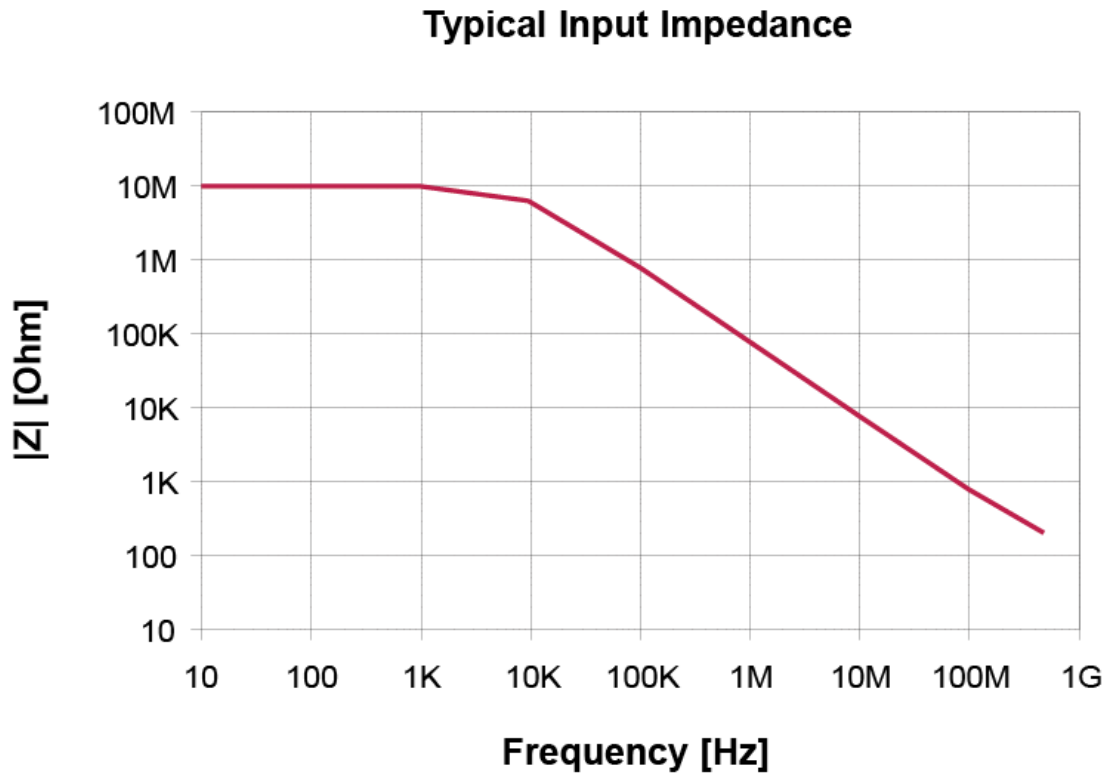

Frequency Response

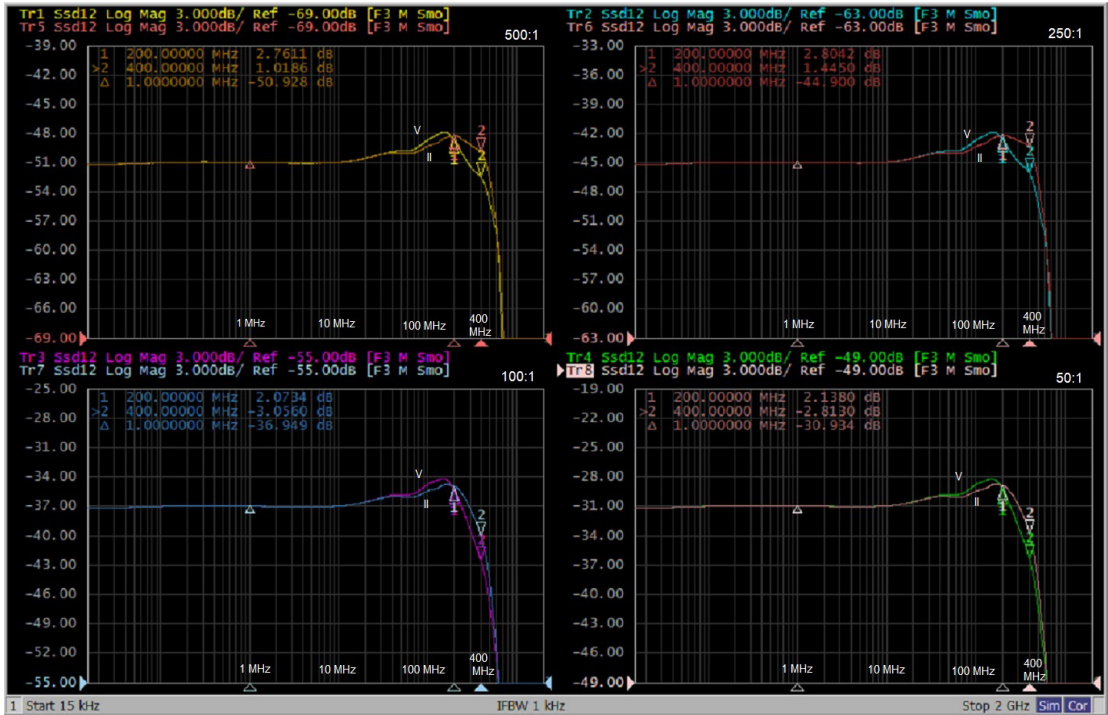

II = probe input cables running in parallel

V = probe input cables running in "V" shape

Figure 5 DP0001A Frequency response plot at four different attenuation ratio settings

DP0001A Frequency Response Test Setup

The best case is when the DP0001A input leads are running in parallel in the test setup and the worst case is when the DP0001A input leads are "V" shaped in the test setup. These two cases are illustrated in the following pictures.



Figure 6 DP0001A Input leads running in parallel (Best case)

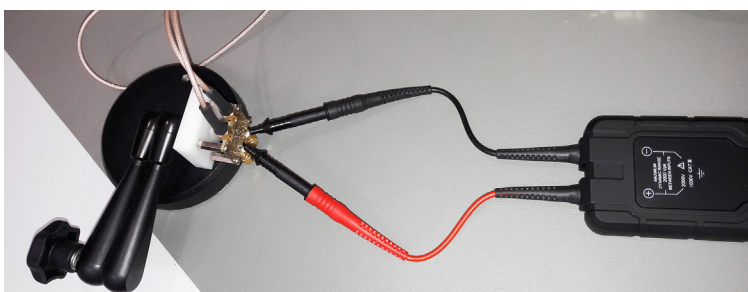

Figure 7 DP0001A Input leads are v-shaped (Worst case)

Common Mode Rejection Ratio over Frequency

This section provides the CMRR plots of DP0001A at the four supported attenuation modes (50:1, 100:1, 250:1, and 500:1).

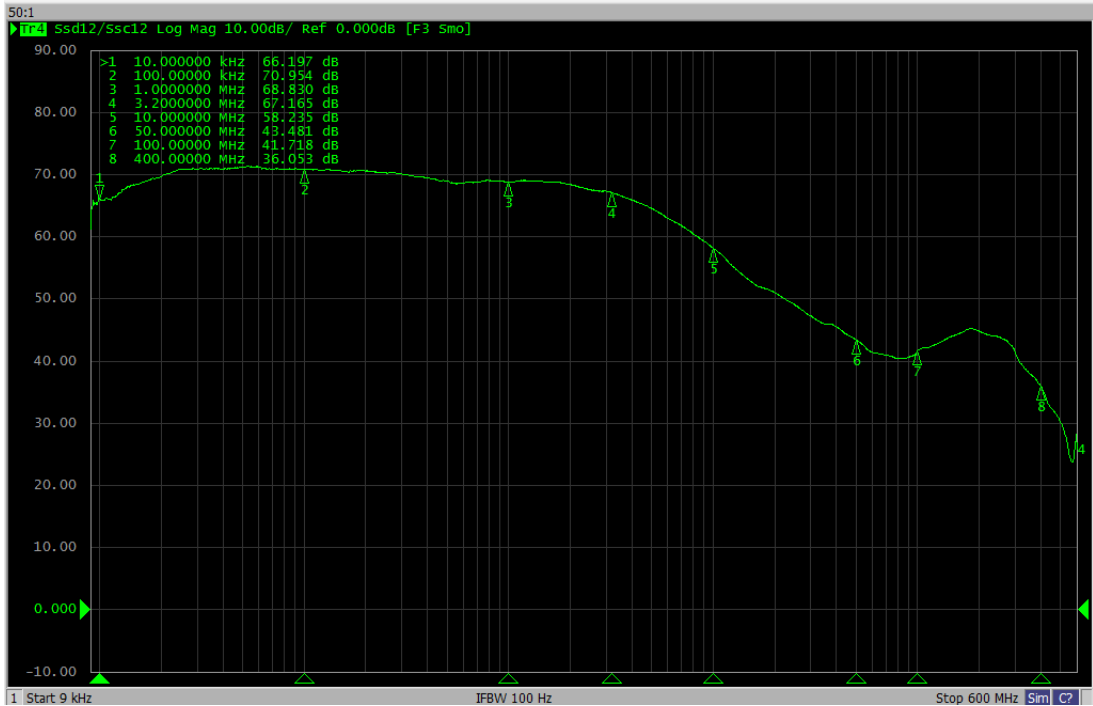

Figure 8 CMRR plot at 50:1

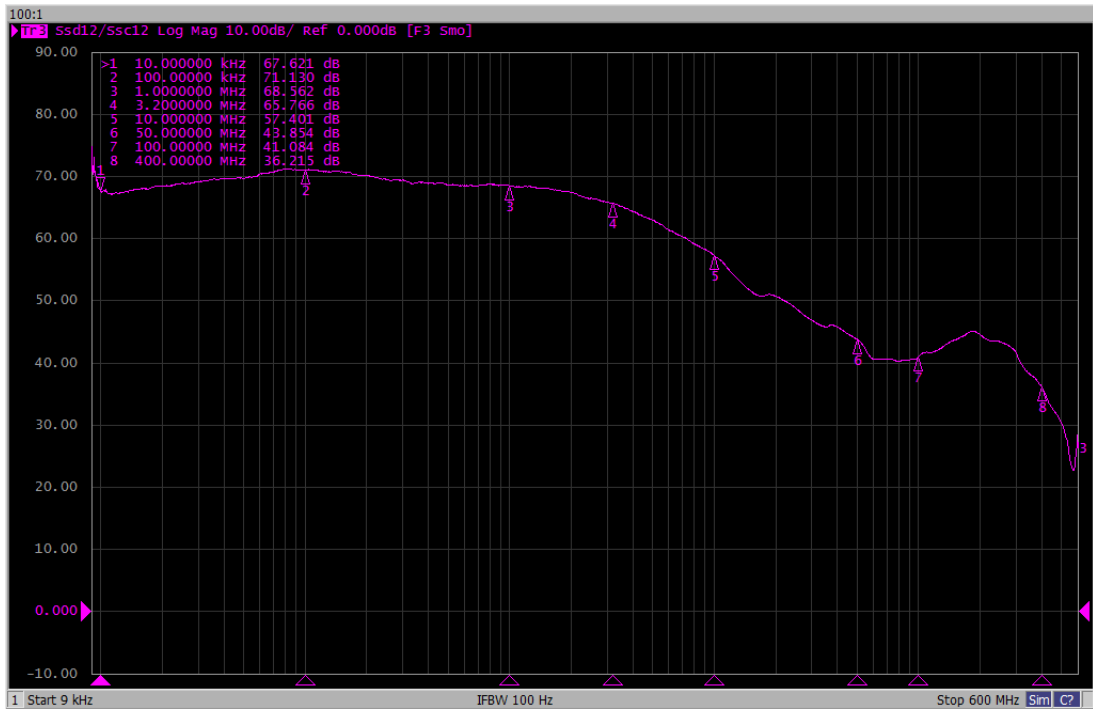

Figure 9 CMRR plot at 100:1

5 Performance Plots

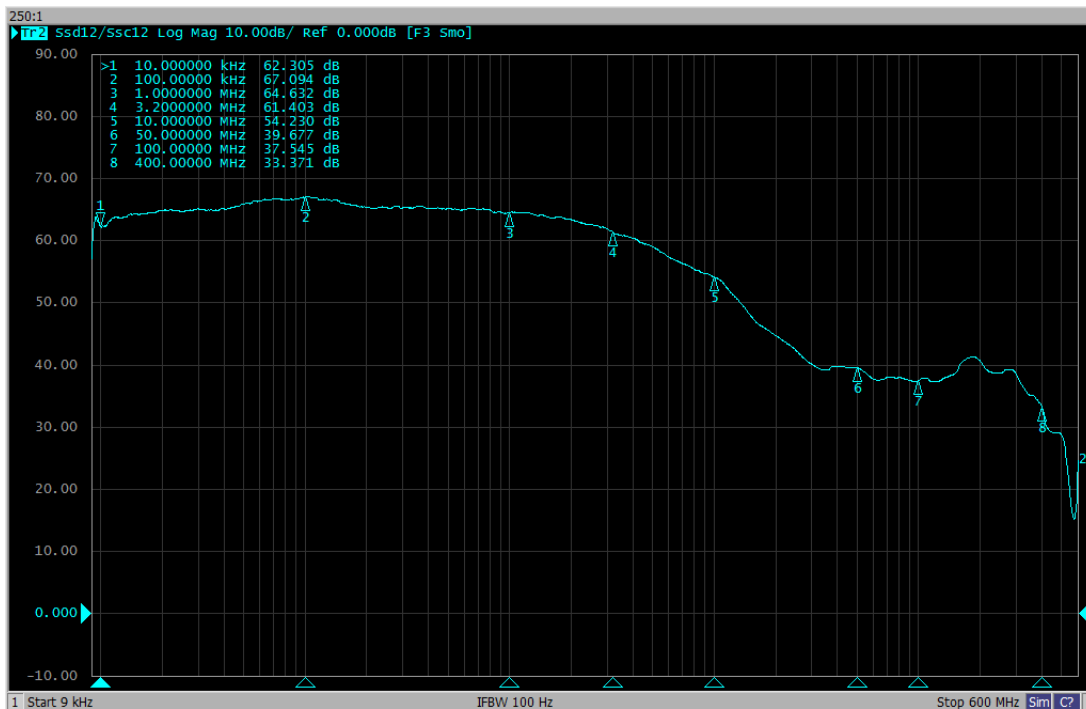

Figure 10 CMRR plot at 250:1

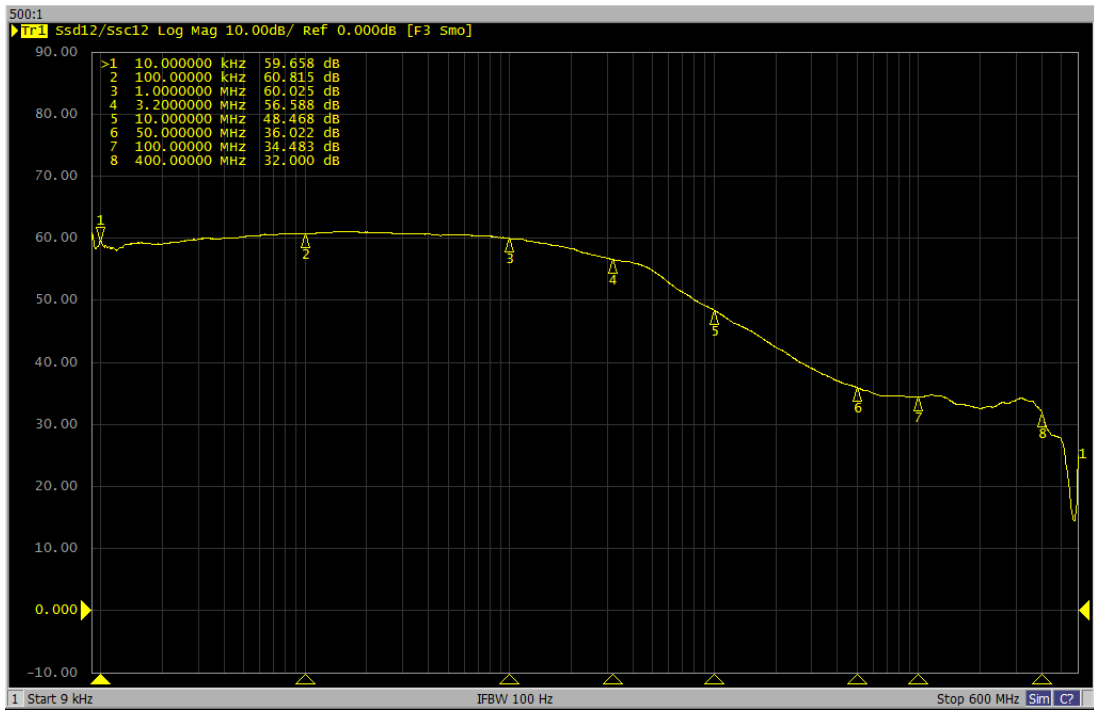

Figure 11 CMRR plot at 500:1

6 Performance Verification

Before you Start	50
DC Differential Gain Accuracy Verification	51
Bandwidth Verification	56
Performance Verification Test Record	62

This chapter describes how to verify the warranted electrical characteristics (DC gain and Bandwidth) of the DP0001A probe.

Before you Start

WARNING

The procedures documented in this chapter require the application of high voltage to the inputs of the DP0001A probe. Ensure that you follow all pertinent safety rules and guidelines for elevated voltage measurements.

Only qualified personnel should perform any testing with voltage levels exceeding 30 V_{rms}.

WARNING

Generators produce hazardous voltages. To avoid risk of shock, do not touch exposed metal parts after the generator output is enabled.

NOTE

Allow the probe to warm up for at least 20 minutes.

Recommended Test Interval

The recommended test interval is 1 year.

DC Differential Gain Accuracy Verification



The procedure described in this section can be used to test and verify the DC differential gain accuracy of the DP0001A probe.

Table 8 Warranted DC Gain Specification for DP0001A

	50:1	100:1	250:1	500:1
DC Gain Accuracy	± 0.7 %	± 0.7 %	± 0.7 %	± 0.35 %

Required Test Equipment

Table 9 Required Test Equipment for DC Gain Accuracy

Description	Critical Specifications	Recommended Model Part Number	Purpose
Oscilloscope	A compatible Infiniium oscilloscope with at least two 4 GHz or higher input channels	90000 X, S-series V, Z-series (with the N5442A adapter) UXR-series 13 GHz to 33 GHz (with the N5442A adapter)	To display probe output
Coaxial Cable or equivalent		N2823A coaxial phase-matched cable 	To connect the PV fixture to the AUX Out on oscilloscope
Probe Positioner		N2787A 3D probe positioner	To hold the probe in place during the procedure
PV Fixture		MX0104A performance verification fixture 	

Description	Critical Specifications	Recommended Model Part Number	Purpose
Probe (to be verified)	DP0001A probe	DP0001A	
Alligator Clip Accessory	Safety alligator clips supplied with the probe		To connect the DP0001A probe leads to the PV fixture

Procedure

- 1 Choose **Control** > **Default Setup** or press the **[Default Setup]** key on the front panel of the oscilloscope to configure the oscilloscope to its default settings.
- 2 Make connections to any two input channels of the oscilloscope as described in the following steps. A typical connection setup is illustrated in [Figure 14](#).
 - a Connect the MX0104A PV fixture to one of the channels of the oscilloscope and then turn on the channel connector to tighten. Use appropriate adapters, if needed.
 - b Connect one end of the coaxial cable to the MX0104A PV fixture and the other end to the **AUX OUT** connector on the front panel of the oscilloscope.
 - c Connect the DP0001A probe to another channel of the oscilloscope. Use appropriate adapter, if needed and as indicated in [Table 9](#).

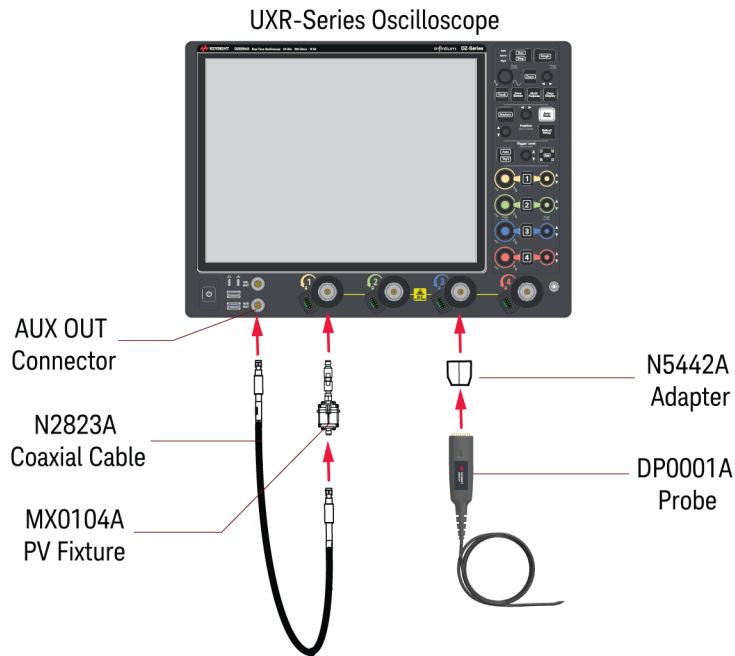

Figure 12 DC Gain Accuracy Verification Sample Setup for DP0001A

- 3 Attach the safety alligator clips to the input leads of the DP0001A probe. If needed, use the probe positioner to hold the probe and safety alligator clips in place steadily over the PV fixture for a secure connection.
- 4 Connect the probe to the PV fixture as described in the following steps. Ensure that the input leads of the probe are kept as straight and parallel as possible for this connection (see [Figure 6](#) for an example). The input leads should not be kinked or v-shaped (see [Figure 7](#) on page 43 for a non-example).
 - a Open the MX0104A PV fixture's spring-loaded clamps
 - b Place the positive (+) tip of the probe (red alligator clip) on the center conductor (signal path) of the PV fixture. The center conductor (signal path) is indicated in [Figure 15](#).
 - c Place the negative (-) tip of the probe (black alligator clip) to the ground plane located on either side of the center conductor of the PV fixture. The

ground plane is indicated in the following figure.

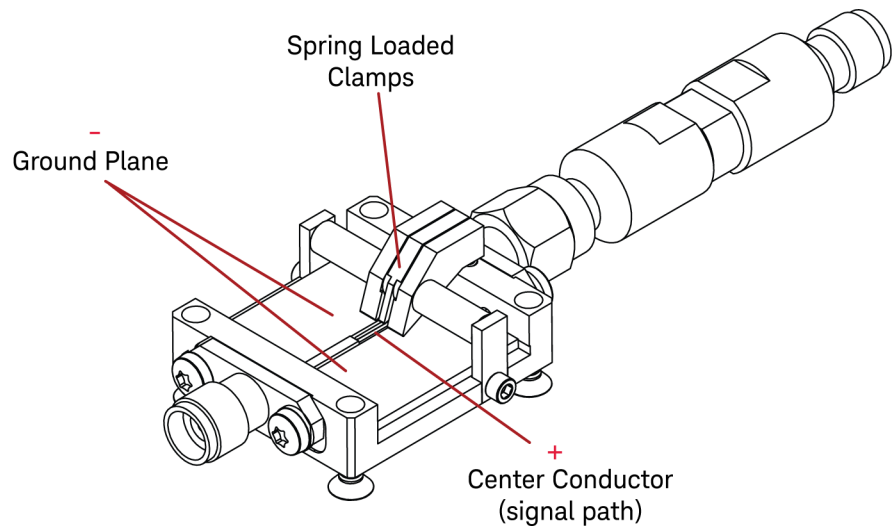

Figure 13 Signal Path and Ground Locations on PV Fixture

- 5 Configure the oscilloscope as per the following settings.
 - a Click **Utilities > Calibration Output** and then select the **Aux Out Enable** checkbox to turn on the Aux output. Ensure that the fastest edge is selected.
 - b Set the vertical scale of the channel to which you connected the PV fixture to **100 mV/div** and center the waveform (offset ~ -280 mV).
 - c Set the trigger to the channel to which you connected the PV fixture and set the trigger level to ~ -280 mV negative slope.
 - d Click **Setup > Acquisition**. In the **Acquisition** dialog box, enable averaging and set **# of Averages** to **1024**.
 - e Set the horizontal scale to **100 nS/div**.
 - f Click **Setup > Probe Configuration** and set the **Probe Offset Behavior** to **Probe**.
 - g Set the vertical scale of the channel to which you connected the DP0001A probe to **100 mV/div** and the offset to ~ -280 mV. Adjust as needed to overlap fixture channel signal.
 - h If needed, adjust the probe channel's skew to just about horizontally center the negative step along with the fixture channel.

- 6 Measure the voltage level of the AUX OUT signal. Record this value as V_{cal} .
- 7 Measure the voltage level of the probe signal. Record this value as $V_{\text{probe out}}$.
- 8 Calculate the probe gain accuracy.

$$\text{Probe Gain Accuracy (\%)} = \frac{V_{\text{cal}} - V_{\text{probe out}}}{V_{\text{cal}}} \times 100$$

- 9 Verify that the probe gain accuracy does not exceed the % probe error given in [Table 8](#) + scope gain accuracy. Record the test results as *DC Differential Gain Accuracy at 50:1* in [Table 11](#).
- 10 At this step, the probe is in the 50:1 attenuation mode as the vertical scale of the channel to which you connected the probe was set to **100 mV/div**. Change the vertical scale of this channel and AUX OUT to **100 V/div** to configure the probe in the 100:1 attenuation mode. You may need to wait a few moments for the signal to settle.
- 11 Repeat [step 6](#), [step 7](#), [step 8](#), and [step 9](#) to verify the DC Differential Gain Accuracy at 100:1.
- 12 At this step, the probe is in the 100:1 attenuation mode as the vertical scale of the channel to which you connected the probe was set to **100 V/div**. Change the vertical scale of this channel and AUX OUT to **200 V/div** to configure the probe in the 250:1 attenuation mode. You may need to wait a few moments for the signal to settle.
- 13 Repeat [step 6](#), [step 7](#), [step 8](#), and [step 9](#) to verify the DC Differential Gain Accuracy at 250:1.
- 14 At this step, the probe is in the 250:1 attenuation mode as the vertical scale of the channel to which you connected the probe was set to **200 V/div**. Change the vertical scale of this channel and AUX OUT to **400 V/div** to configure the probe in the 500:1 attenuation mode. You may need to wait a few moments for the signal to settle.
- 15 Repeat [step 6](#), [step 7](#), [step 8](#), and [step 9](#) to verify the DC Differential Gain Accuracy at 500:1.

If the probe gain accuracy checks performed in [step 9](#), [step 11](#), [step 13](#) and [step 15](#) pass, then the DP0001A probe has passed the DC gain accuracy performance verification test.

Bandwidth Verification



The procedure described in this section can be used to test and verify that the probe meets its warranted bandwidth specification.

Warranted Specification

Bandwidth	400 MHz
-----------	---------

Required Test Equipment

Table 10 Required Test Equipment for Bandwidth Verification

Description	Critical Specifications	Recommended Model Part Number	Purpose
Oscilloscope	A compatible Infiniium oscilloscope with at least two 4 GHz or higher input channels	90000 X, S-series V, Z-series (with the N5442A adapter) UXR-series 13 GHz to 33 GHz (with the N5442A adapter)	To display probe output
Coaxial Cable or equivalent		N2823A coaxial phase-matched cable 	To connect the PV fixture to the AUX Out on oscilloscope
Probe Positioner		N2787A 3D probe positioner	To hold the probe in place during the procedure
PV Fixture		MX0104A performance verification fixture 	
Probe (to be verified)	DP0001A probe	DP0001A	

Description	Critical Specifications	Recommended Model Part Number	Purpose
Alligator Clip Accessory	Safety alligator clips supplied with the probe		To connect the DP0001A probe leads to the PV fixture

Procedure

NOTE

Before initiating this procedure, ensure that the DP0001A probe is calibrated to the oscilloscope to be used for the performance verification.

- 1 Choose **Control > Default Setup** or press the **[Default Setup]** key on the front panel of the oscilloscope to configure the oscilloscope to its default settings.
- 2 Make connections to any two input channels of the oscilloscope as described in the following steps. A typical connection setup is illustrated in [Figure 14](#).
 - a Connect the MX0104A PV fixture to one of the channels of the oscilloscope and then turn on the channel connector to tighten. Use appropriate adapters, if needed.
 - b Connect one end of the coaxial cable to the MX0104A PV fixture and the other end to the **AUX OUT** connector on the front panel of the oscilloscope.
 - c Connect the DP0001A probe to another channel of the oscilloscope. Use appropriate adapter, if needed and as indicated in [Table 10](#).

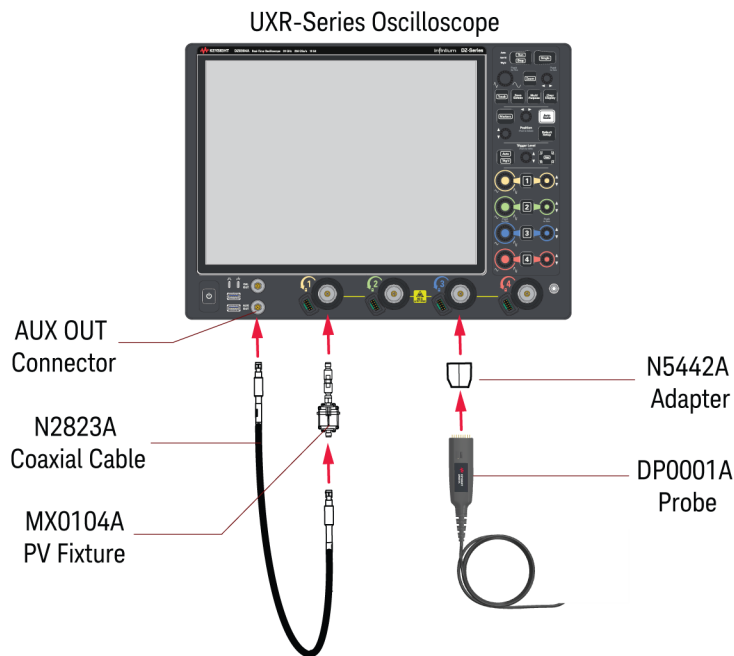

Figure 14 Bandwidth Performance Verification Sample Setup for DP0001A

- 3 Attach the safety alligator clips to the input leads of the DP0001A probe. If needed, use the probe positioner to hold the probe and safety alligator clips in place steadily over the PV fixture for a secure connection.
- 4 Connect the probe to the PV fixture as described in the following steps. Ensure that the input leads of the probe are kept as straight and parallel as possible for this connection (see [Figure 6](#) for an example). The input leads should not be kinked or v-shaped (see [Figure 7](#) on page 43 for a non-example).
 - a Open the MX0104A PV fixture's spring-loaded clamps
 - b Place the positive (+) tip of the probe (red alligator clip) on the center conductor (signal path) of the PV fixture. The center conductor (signal path) is indicated in [Figure 15](#).
 - c Place the negative (-) tip of the probe (black alligator clip) to the ground plane located on either side of the center conductor of the PV fixture. The

ground plane is indicated in the following figure.

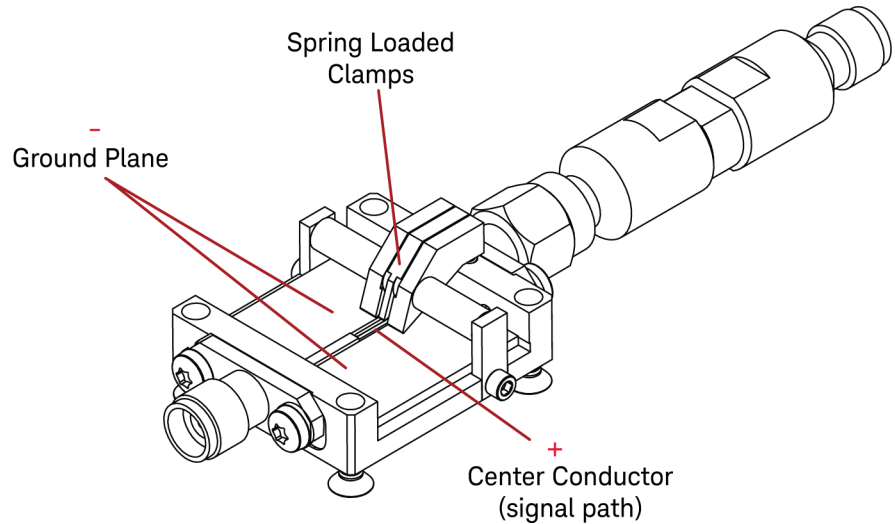

Figure 15 Signal Path and Ground Locations on PV Fixture

- 5 Configure the oscilloscope as per the following settings.
 - a Click **Utilities > Calibration Output** and then select the **Aux Out Enable** checkbox to turn on the Aux output. Ensure that the fastest edge is selected.
 - b Set the vertical scale of the channel to which you connected the PV fixture to **100 mV/div** and center the waveform (offset ~ -280 mV).
 - c Set the trigger to the channel to which you connected the PV fixture and set the trigger level to ~ -280 mV **negative slope**.
 - d Click **Setup > Acquisition**. In the **Acquisition** dialog box, enable averaging and set **# of Averages** to **1024**.
 - e Set the horizontal scale to **100 nS/div**.
 - f Click **Setup > Probe Configuration** and set the **Probe Offset Behavior** to **Probe**.
 - g Set the vertical scale of the channel to which you connected the DP0001A probe to **100 mV/div** and the offset to ~ -280 mV. Adjust as needed to overlap fixture channel signal.
 - h If needed, adjust the probe channel's skew to just about horizontally center the negative step along with the fixture channel.

- 6** Click **Math > Functions....** In the **Function** dialog box, define the functions f1, f2, f3, and f4 as follows:

 - a** Select the tab of the function **f1** to define it.
 - b** From the **Function 1** listbox, select **Math** and then **Differentiate**.
 - c** From the **Source 1** drop-down listbox, select the input channel of the oscilloscope to which you connected the PV fixture.
 - d** Deselect the **Low Pass and Align Phase** checkbox.
 - e** Do not select the **On** checkbox for f1.
 - f** Select the tab of the function **f2** to define it.
 - g** From the **Function 2** listbox, select **FFT** to set f2 to be an FFT of f1.
 - h** Turn the function display on for f2 by selecting the **On** checkbox. Set to logarithmic scale.
 - i** Select the tab of the function **f3** to define it.
 - j** From the **Function 3** listbox, select **Math** and then **Differentiate**.
 - k** From the **Source 1** drop-down listbox, select the input channel of the oscilloscope to which you connected the probe amplifier.
 - l** Deselect the **Low Pass and Align Phase** checkbox.
 - m** Do not select the **On** checkbox for f3.
 - n** Select the tab of the function **f4** to define it.
 - o** From the **Function 4** listbox, select **FFT** to set f4 to be an FFT of f3.
 - p** Turn the function display on for f4 by selecting the **On** checkbox. Set to logarithmic scale.
- 7** Move the f4 trace into the same graticule as the f2 trace using the mouse. Turn off the graticule that is left unused after this movement.
- 8** Set both f2 and f4 FFTs to **3 dbm/div**, start frequencies to **300 MHz**, and stop frequencies to **500 MHz**.
- 9** Move both f2 and f4 traces up to the center screen using the mouse. Overlay the left side of the traces.
- 10** Check the probe response FFT (f4). It should not be more than 3 db below the PV fixture response FFT (f2).
- 11** At this step, the probe is in the 50:1 attenuation mode as the vertical scale of the channel to which you connected the probe was set to **100 mV/div**. Change the vertical scale of this channel to **100 V/div** to configure the probe in the 100:1 attenuation mode. You may need to wait a few moments for the signal to settle.

- 12** Check the probe response FFT (f4). It should not be more than 3 db below the PV fixture response FFT (f2).
- 13** At this step, the probe is in the 100:1 attenuation mode as the vertical scale of the channel to which you connected the probe was set to **100 V/div**. Change the vertical scale of this channel to **200 V/div** to configure the probe in the 250:1 attenuation mode. You may need to wait a few moments for the signal to settle.
- 14** Check the probe response FFT (f4). It should not be more than 3 db below the PV fixture response FFT (f2).
- 15** At this step, the probe is in the 250:1 attenuation mode as the vertical scale of the channel to which you connected the probe was set to **200 V/div**. Change the vertical scale of this channel to **400 V/div** to configure the probe in the 500:1 attenuation mode. You may need to wait a few moments for the signal to settle.
- 16** Check the probe response FFT (f4). It should not be more than 3 db below the PV fixture response FFT (f2).

If the checks performed in [step 10](#), [step 12](#), [step 14](#), and [step 16](#) pass, then the DP0001A probe has passed the bandwidth performance verification test.

Performance Verification Test Record

Table 11 Performance Verification Test Record

Model #:	Date:	Tested by:	
Serial #:	Recommended next test date:		
Test	Test Limits	Result	Pass/Fail
DC Differential Gain Accuracy	$\pm 0.7\%$ + scope gain accuracy (at 50:1, 100:1, and 250:1) $\pm .35\%$ + scope gain accuracy (at 500:1)		
Bandwidth (-3 dB)	400 MHz		

Index

A

accessories, 9
accessories input voltage, 9
attenuation, 8, 32
attenuation LED, 32
attenuation mode, 34
AUX Out, 51, 56
Aux Out, 52, 57

C

care, probe, 6
cleaning, 23
CMRR plots, 44

G

grounding probe, 22

H

handling, 24

I

inspecting, 22

K

Keysight Technologies,
contacting, 26

M

MX0104A, 51, 52, 56, 57

N

N2787A, 51, 56
N2823A, 51, 56
N5442A, 51, 56

O

offset calibration, 33
Optional Accessories, 11, 13
optional accessories, 11

overload, 8
overload indicator, 35
overvoltage, 8, 32, 35

P

performance test record, 62
performance verification fixture, 51,
56
probe
cable care, 6
cleaning, 23
grounding, 22
inspecting, 22
service, 25
probe handling, 24
PV setup, 58

R

repair, 25
replacement accessories, 11
returning for service, 25

S

service, 25
standard accessories, 9

W

WEEE Directive, 29

