

Keysight N2795/6A Single-Ended Probes

User's Guide



Notices

© Keysight Technologies, Inc. 2010 - 2013, 2018

No part of this manual may be reproduced in any form or by any means (including electronic storage and retrieval or translation into a foreign language) without prior agreement and written consent from Keysight Technologies, Inc. as governed by United States and international copyright laws.

Manual Part Number

N2795-97004

Edition

October 2018

Published by:
Keysight Technologies, Inc.
1900 Garden of the Gods Road
Colorado Springs, CO 80907 USA

Warranty

The material contained in this document is provided "as is," and is subject to being changed, without notice, in future editions. Further, to the maximum extent permitted by applicable law, Keysight disclaims all warranties, either express or implied, with regard to this manual and any information contained herein, including but not limited to the implied warranties of merchantability and fitness for a particular purpose. Keysight shall not be liable for errors or for incidental or consequential damages in connection with the furnishing, use, or performance of this document or of any information contained herein. Should Keysight and the user have a separate written agreement with warranty terms covering the material in this document that conflict with these terms, the warranty terms in the separate agreement shall control.

Technology Licenses

The hardware and/or software described in this document are furnished under a license and may be used or copied only in accordance with the terms of such license.

U.S. Government Rights

The Software is "commercial computer software," as defined by Federal Acquisition Regulation ("FAR") 2.101. Pursuant to FAR 12.212 and 27.405-3 and Department of Defense FAR Supplement ("DFARS") 227.7202, the U.S. government acquires commercial computer software under the same terms by which the software is customarily provided to the public. Accordingly, Keysight provides the Software to U.S. government customers under its standard commercial license, which is embodied in its End User License Agreement (EULA), a copy of which can be found at

<http://www.keysight.com/find/sweula>. The license set forth in the EULA represents the exclusive authority by which the U.S. government may use, modify, distribute, or disclose the Software. The EULA and the license set forth therein, does not require or permit, among other things, that Keysight:

(1) Furnish technical information related to commercial computer software or commercial computer software documentation that is not customarily provided to the public; or (2) Relinquish to, or otherwise provide, the government rights in excess of these rights customarily provided to the public to use, modify, reproduce, release, perform, display, or disclose commercial computer software or commercial computer software documentation. No additional government requirements beyond those set forth in the EULA shall apply, except to the extent that those terms, rights, or licenses are explicitly required from all providers of commercial computer software pursuant to the FAR and the DFARS and are set forth specifically in writing elsewhere in the EULA. Keysight shall be under no obligation to update, revise or otherwise modify the Software. With respect to any technical data as defined by FAR

2.101, pursuant to FAR 12.211 and 27.404.2 and DFARS 227.7102, the U.S. government acquires no greater than Limited Rights as defined in FAR 27.401 or DFAR 227.7103-5 (c), as applicable in any technical data. 52.227-14 (June 1987) or DFAR 252.227-7015 (b)(2) (November 1995), as applicable in any technical data.

CAUTION. A **CAUTION** notice denotes a hazard. It calls attention to an operating procedure, practice, or the like that, if not correctly performed or adhered to, could result in damage to the product or loss of important data. Do not proceed beyond a **CAUTION** notice until the indicated conditions are fully understood and met.

WARNING. A **WARNING** notice denotes a hazard. It calls attention to an operating procedure, practice, or the like that, if not correctly performed or adhered to, could result in personal injury or death. Do not proceed beyond a **WARNING** notice until the indicated conditions are fully understood and met.

Contents

1 Using the Probes

- Oscilloscope Compatibility / 7
- Supplied Accessories / 8
- Probe Headlight / 11
- Using the Accessory Tips and Grounds / 12
- Dynamic Range and Offset Voltage Limitations / 19
- Functional Test / 20
- Inspecting the Probe / 21
- Returning the Probe for Service / 22
- Safety Information / 23

2 Characteristics and Specifications

- Dimensions / 27

3 Performance Data Plots

4 Performance Verification

- Test 1. DC Input Resistance / 35
- Test 2. Bandwidth / 36
- Performance Test Record / 45

Contents

1 Using the Probes

Oscilloscope Compatibility	7
Supplied Accessories	8
Probe Headlight	11
Using the Accessory Tips and Grounds	12
Dynamic Range and Offset Voltage Limitations	19
Functional Test	20
Inspecting the Probe	21
Returning the Probe for Service	22
Safety Information	23

The N2795/6A are 1 and 2 GHz single-ended active probes with the AutoProbe interface (compatible with Keysight's InfiniVision and Infiniium family of oscilloscopes). These probes integrate many of the characteristics needed for today's general-purpose, high-speed probing, component design/characterization, and

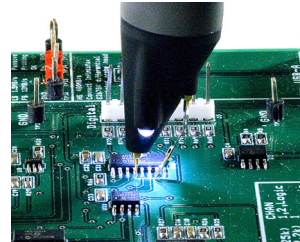

educational research applications. Its 1M Ω input resistance and extremely low input capacitance (1 pF) provide ultra low loading of the DUT. This, accompanied with superior signal fidelity, makes these probes useful for most of today's digital logic voltages. And with their wide dynamic range ($\pm 8V$) and offset range ($\pm 12V$ for N2796A, $\pm 8V$ for N2795A), these probes can be used in a wide variety of applications.

For high signal integrity probing, the N2795A 1 GHz and N2796A 2 GHz active probes are perfect complements to Keysight's 500 MHz – 600 MHz and 1 GHz bandwidth oscilloscopes, respectively. The

N2796A 2 GHz probe can also be used with Keysight's 2.5 GHz or higher bandwidth Infiniium scope as a low cost alternative to the InfiniiMax probes.

The N2795/6A probes are powered directly by the InfiniiVision and Infiniium AutoProbe interface, eliminating the need for an additional power supply. The probes also come with a number of accessories that allow for easy connections to the circuit under test. Refer to **“Supplied Accessories”** on page 8.

WARNING Handle the probe with care to avoid injury, especially when it is fitted with the sharp spring or rigid tip.

CAUTION This probe is an ESD sensitive devices, particularly at the probe tips. Follow standard ESD precautions when handling. Remove tip accessories when storing the probe.

CAUTION Before using the probe, refer to **“Safety Information”** on page 23.

CAUTION Handle the probe cable carefully to avoid damaging it through excessive bending or pulling. Avoid any mechanical shocks to the probe in order to guarantee accurate performance and protection.

Cleaning the Probe

Disconnect the probe from the oscilloscope and clean the probe with a soft cloth dampened with a mild soap and water solution. Make sure the probe is completely dry before reconnecting it to an oscilloscope.

Oscilloscope Compatibility

The N2795/6A probes are compatible with the Keysight oscilloscopes shown in **Table 1** (those with the Keysight AutoProbe Interface). The table also lists the minimum required firmware version for the oscilloscope.

Is Your Oscilloscope Software Up-to-Date?

Keysight periodically releases software updates to support your probe, fix known defects, and incorporate product enhancements. To download the latest firmware, go to www.keysight.com and search for your oscilloscope's topic. Click on the "Drivers, Firmware & Software" tab.

Table 1 Compatible Oscilloscopes and Probe Support

Oscilloscope	Software Version	Maximum Number of Probes Supported
Infiniium Z-Series ^a	>=5.0	Four probes per scope
Infiniium V-Series ^a		
Infiniium S-Series		
Infiniium 90000 X-Series ^a	All	Four probes on 4-channel scope.
Infiniium 90000 Q-Series ^a	All	
Infiniium 90000 Series	>=2.50	
Infiniium 9000 H-Series	All	
Infiniium 90000A-Series	>=2.50	
InfiniiVision 7000 Series	>= 6.10	Two probes on 2 or 4-channel scopes.
InfiniiVision 6000 Series (except 100 MHz model)		
InfiniiVision 5000 Series		
InfiniiVision 4000 X-Series	All	Four probes on 4-channel scope. Two probes on 2-channel scope.
InfiniiVision 3000 X-Series	All	Two probes on 2 or 4-channel scopes.

^a Requires N5442A adapter.

Supplied Accessories

The probes come with the accessories shown in **Figure 2** on page 9 and listed in **Table 2** on page 9. **Table 3** on page 10 shows the replacement accessories available in the replacement accessory kit.

Attaching Probe Accessories

It's easy to change the probe tip and ground accessories. **Figure 1** shows locations for inserting the tip and the ground accessory. To change an accessory, gently pull it straight out of its contact socket along the axis of the probe. Once the accessory is removed, insert the new accessory until it is seated in the contact socket. In order to insert the probe tip completely into the housing, carefully press the probe tip against a hard surface.

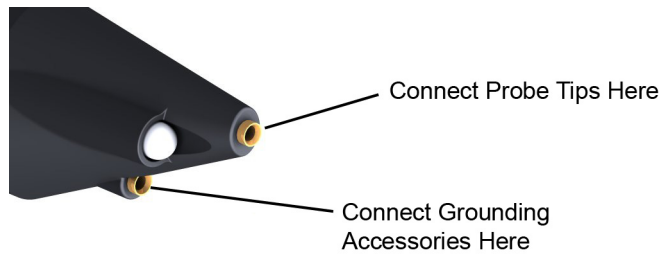

Figure 1 Tip and Grounding Connections

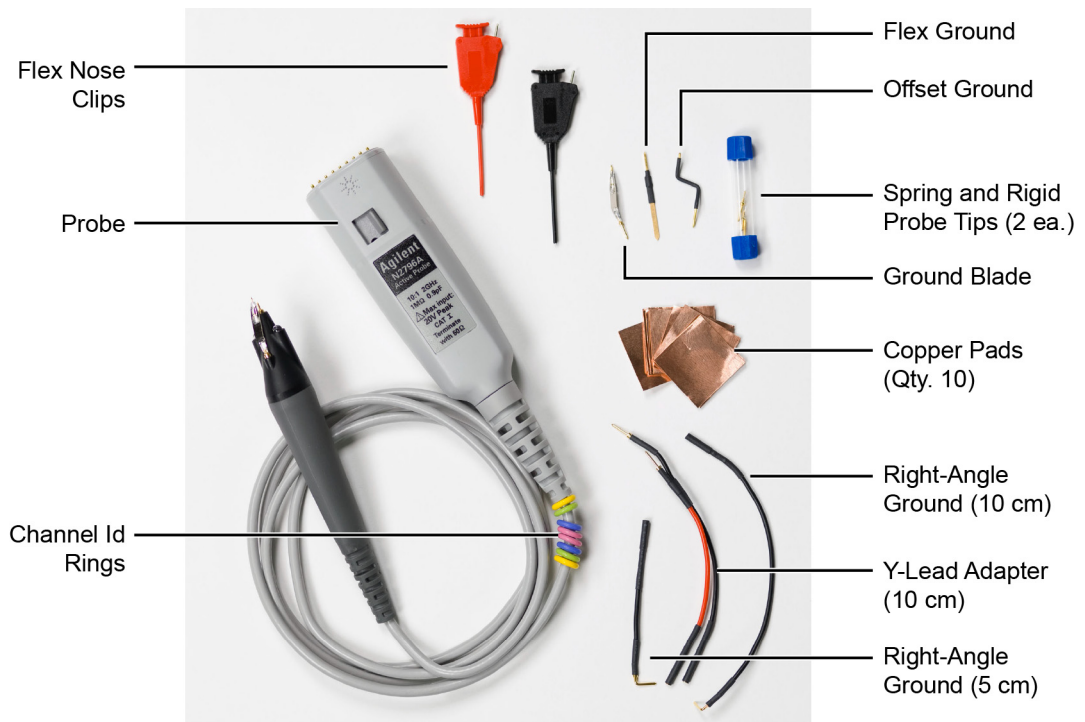

Figure 2 Probe with Supplied Accessories

Table 2 Supplied Accessories

Accessory	Quantity	Accessory	Quantity
Flex Nose Clip (red)	1	Right-Angle Ground (10 cm)	1
Flex Nose Clip (black)	1	Ground Blade	2
Rigid Probe Tip	2	Offset Ground	1
Spring Probe Tip	2	Flex Ground	1
Y-Lead Adapter (10 cm)	1	Copper Pads	10
Right-Angle Ground (5 cm)	1	Channel-Identification Rings	4 of each color

Table 3 Replacement Accessory Kit

Accessory	Qty	Part Number
Flex Nose Clip (red)	1	5061-7390
Flex Nose Clip (black)	1	5061-7391
Rigid Probe Tip	2	5061-7389
Spring Probe Tip	2	5061-7388
Y-Lead Adapter (10 cm)	1	5061-7392
Right-Angle Ground (5 cm)	2	5061-7399
Right-Angle Ground (10 cm)	2	5061-7400
Ground Blade	2	5061-7393
Offset Ground	2	5061-7394
Flex Ground	2	5061-7397
Ground Lead (6 cm)	2	5061-7395
Ground Lead (12 cm)	2	5061-7396
Copper Pads	10	0960-2908

Channel-Identification Rings

When multiple probes are connected to the oscilloscope, the channel identification rings allow you to quickly determine which channel input is associated with each probe. On the probe, place one colored ring near the probe's channel connector and place an identical color ring near the probe head.

Probe Headlight

The probe is equipped with a white LED headlight to illuminate the area around the probe tip. This headlight has a fixed intensity and is turned on and off by pressing the button that is located on the probe's body.







Figure 3 Headlight and Button

Using the Accessory Tips and Grounds

This section presents the various probe accessory configurations listed in order of available bandwidth for your measurements. Select the configuration to match your measurement needs, including ease of use.

Table 4 Probe Configurations in Order of Decreasing Bandwidth

Recommended Order of Use	Probe Configuration Topic	Typical Bandwidth
1	 “Rigid or Spring Tips with Offset Ground or Ground Blade” on page 13	1 GHz (N2795A) 2 GHz (N2796A)
2	 “Copper Pads with Flex Ground” on page 15	900 MHz (N2795A) 1.8 GHz (N2796A)
3	 “Y-Leads Adapter with 0.1” Headers” on page 16	750 MHz (N2795A) 1 GHz (N2796A)
4	 “Flexible Nose Clips” on page 17	500 MHz (N2795A) 500 MHz (N2796A)
5	 “Ground Leads and Right-Angle Ground Leads” on page 18	Unspecified

1 Rigid or Spring Tips with Offset Ground or Ground Blade

These rigid and spring-loaded tips are replaceable. To change the probe tip, pull it straight out of its contact socket along the axis of the probe. Once the probe tip is removed, the new tip can be inserted into the contact socket along the axis of the probe. In order to insert the probe tip completely into the housing, carefully press the probe tip against a hard surface.



It is recommended that the spring tips be used with the ground blade as both the tips and ground blade are spring-loaded and will maintain contact with the device under test even when your hand moves slightly.

The rigid/spring tips and grounds can be mixed with no effect on performance. It is simply a matter of personal preference. Spring loaded probe tips offer a method of probing signals that is less susceptible to vibration or movement than traditional rigid tips. Many users find it easier to use this type of tip. The spring loaded tips work when they are either partially or fully compressed and are protected against over compression damage. The recommended grounding accessory for the rigid probe tip is the offset ground.

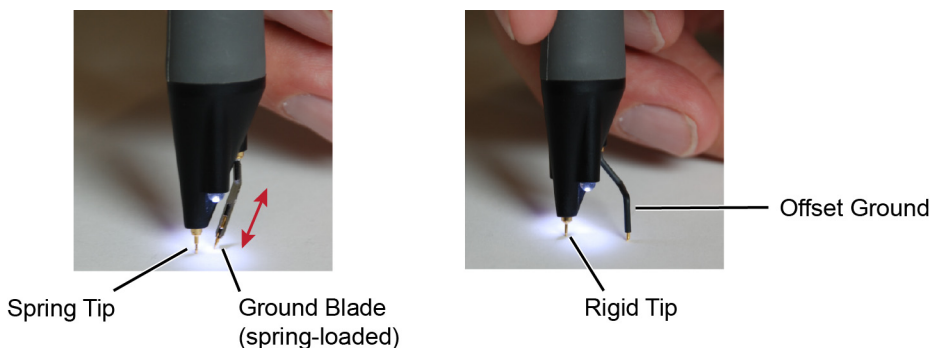

Figure 4 Spring and Rigid Tips with Offset and Blade Ground

WARNING Handle the probe with care to avoid injury, especially when it is fitted with the sharp rigid or spring tip.

When inserting the tip, insert the end with the ridge into the probe head as shown in **Figure 5**.

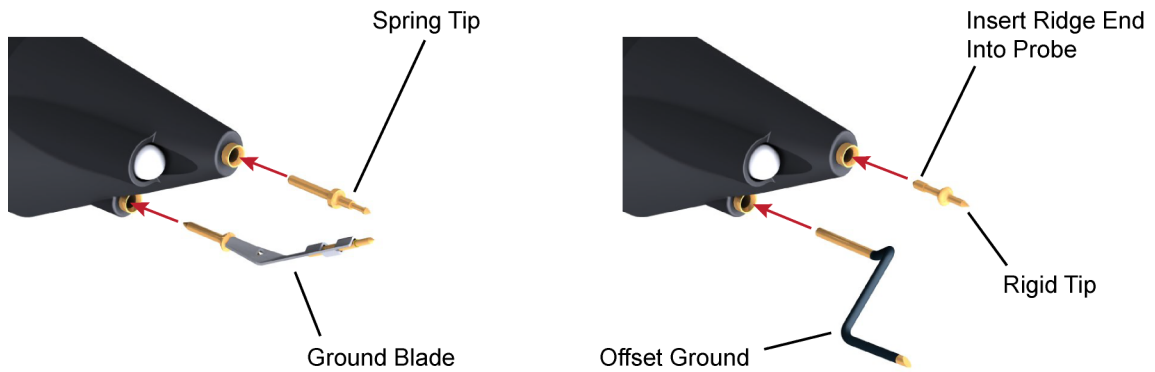

Figure 5 Inserting the Tips and Grounds

2 Copper Pads with Flex Ground



These self adhesive copper pads can be attached on top of an IC and connected to its ground pins to create a convenient ground plane for the probe to connect to.



When used with the flex ground, this method provides an ideal ground connection for probing signals with high frequency content. However, to maximize the performance of this setup, you need to solder as many jumper wires as is practical from the ground pins of the package to the copper pad. The more ground connections, the less inductance in the ground path and the higher the bandwidth capability of the measurement. Insert the Flex Ground and bend it into a shape that makes it easy to contact the copper ground pad on top of the package.

NOTE The bandwidth is highly dependent on the number of ground connections between the copper pad and the device under test.



Figure 6 Copper Pad on IC

3 Y-Leads Adapter with 0.1" Headers



The Y-lead adapter offers a convenient and reliable method to connect both the probe signal and ground to probe points on the board or other probe accessories. For example, this can be used to connect to connector headers or other accessories like the Flex Nose Clip Adapter as seen in the following pictures.

N2795A
750 MHz
BW
N2796A
1 GHz

The sockets accept 0.56-0.86 mm round and 0.64 mm square (0.022 - 0.034 inch round and 0.025 inch square) diameter pins. The maximum insertion depth is 7.5 mm (0.295 inch) and the outer insulation of the socket is less than 2.54 mm. You can use it for 2.54 mm pitch (0.1 inch) terminals.

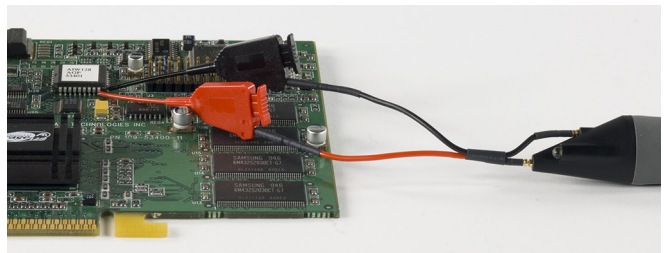
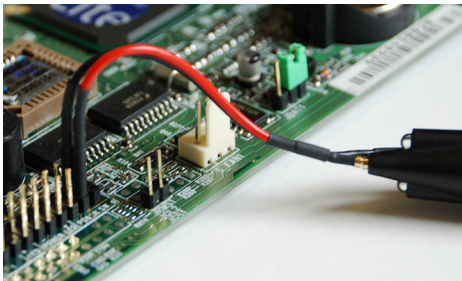

Figure 7 Probe with Y-Leads Attached

4 Flexible Nose Clips



You can use flexible nose clips to make connections to components or wires with leads that are 1.01 mm (0.04 inches) in diameter or smaller. With today's miniature IC- and component-packaging techniques, these clips can make probing challenging devices much easier. Most users prefer to attach the clips to the probe via the Y-lead adapter as shown in the picture below. Press the back of the flex nose clip to extend the grasping hook and then release to tighten the hook around the component you are testing.

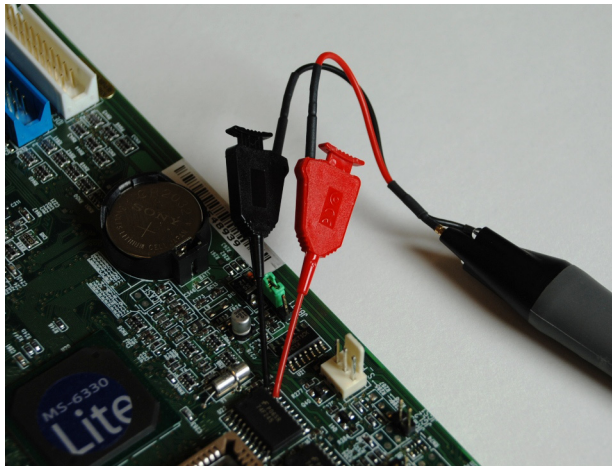

Figure 8 Probe with Flexible Nose Clips Attached

5 Ground Leads and Right-Angle Ground Leads



These ground leads can be used to reach grounding locations that are farther away from the probing location than can be reached by either the ground blade or offset ground. However, the longer leads means they have a larger inductance in the ground return path which corresponds to a lower performance than the ground blade and offset ground.



NOTE The straight leads are not included with the probe. They must be ordered as a replacement kit. For more information about the replacement kits, refer to [Table 3](#) on page 10.



Figure 9 Straight and Right-Angle Ground Leads

Dynamic Range and Offset Voltage Limitations

With $16V_{pp}$ ($\pm 8V$) of dynamic range and $\pm 8V$ (N2795A) or $\pm 12V$ (N2796A) of offset range, the probes have a wide measuring range of $\pm 20V$, which allows them to be used for a wide variety of applications. For example, if you wanted to measure small AC noise riding on top of a $+10V$ DC signal, you could use DC offset to position the signal at the center of the screen to keep the probe within its dynamic range. You could then zoom in to see the detail at a higher resolution. Trying to measure a signal out of the dynamic range may result in a clipped or distorted waveform.

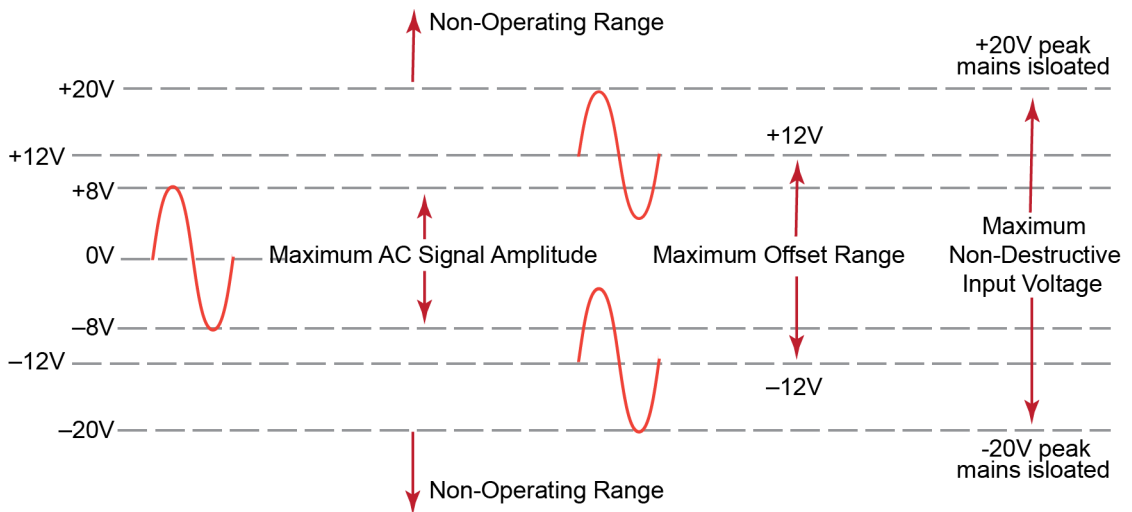

Figure 10 Dynamic Range and Offset Limits

Functional Test

Use the following generic measurement procedure to ensure that your probe is functioning properly.

- 1** Connect the probe to an oscilloscope channel input and ensure the input impedance of the oscilloscope matches the output impedance of the probe (50 Ω).
- 2** Connect a grounding accessory to the probe and connect the ground to the ground terminal on the oscilloscope.
- 3** Connect the probe tip to the oscilloscope's probe compensation output.
- 4** Enable autoscale on the oscilloscope.
- 5** A square wave should now be displayed on the oscilloscope, if the probe is functioning properly.

Inspecting the Probe

- Inspect the shipping container for damage.

Keep the damaged shipping container or cushioning material until the contents of the shipment have been checked for completeness and the probe has been checked mechanically and electrically.

- Check the accessories.
- If the contents are incomplete or damaged, notify your Keysight Technologies Sales Office.
- Inspect the probe.

If there is mechanical damage or defect, or if the probe does not operate properly or pass calibration tests, notify your Keysight Technologies Sales Office.

If the shipping container is damaged, or the cushioning materials show signs of stress, notify the carrier as well as your Keysight Technologies Sales Office. Keep the shipping materials for the carrier's inspection. The Keysight Technologies office will arrange for repair or replacement at Keysight Technologies' option without waiting for claim settlement.

Returning the Probe for Service

If the probe is found to be defective we recommend sending it to an authorized service center for all repair and calibration needs. Perform the following steps before shipping the probe back to Keysight Technologies for service.

- 1** Contact your nearest Keysight sales office for information on obtaining an RMA number and return address.
- 2** Write the following information on a tag and attach it to the malfunctioning equipment.
 - Name and address of owner
 - Product model number (for example, N2795A)
 - Product Serial Number (for example, MYXXXXXXXX)
 - Description of failure or service required

NOTE Include probing and browsing tips if you feel the probe is not meeting performance specifications or a yearly calibration is requested.

- 3** Protect the probe by wrapping in plastic or heavy paper.
- 4** Pack the probe in the original carrying case or if not available use bubble wrap or packing peanuts.
- 5** Place securely in sealed shipping container and mark container as "FRAGILE".

NOTE If any correspondence is required, refer to the product by serial number and model number.

Contacting Keysight Technologies

For technical assistance, contact your local Keysight Call Center.

- In the Americas, call 1 (800) 829-4444
- In other regions, visit <http://www.keysight.com/find/assist>

Before returning an instrument for service, you must first call the Call Center at 1 (800) 829-4444.

Safety Information

This apparatus has been designed and tested in accordance with IEC 61010-031, Safety requirements for hand-held probe assemblies for electrical measurement and test. Before applying power, verify that the correct safety precautions are taken as described in the following warnings.

WARNING To avoid personal injury and to prevent fire or damage to this product or products connected to it, review and comply with the following safety precautions. Be aware that if you use this probe assembly in a manner not specified, the protection this product provides may be impaired.

WARNING Handle the probe with care to avoid injury, especially when it is fitted with the sharp spring or rigid tip.

WARNING Handle Probe Tips and Accessories Carefully. Some of the probe tips and accessories are very sharp (the browser tips, for example). You should handle these with care to avoid personal injury.

WARNING Use Only Grounded Instruments. Do not connect the probe's ground lead to a potential other than earth ground. Always make sure the probe and the oscilloscope are grounded properly.

WARNING Connect and Disconnect Properly. Connect the probe to the oscilloscope and connect the ground lead to earth ground before connecting the probe to the circuit under test. Disconnect the probe input and the probe ground lead from the circuit under test before disconnecting the probe from the oscilloscope.

WARNING Observe Probe Ratings. Do not apply any electrical potential to the probe input which exceeds the maximum rating of the probe. Make sure to comply with the voltage versus frequency derating curve found in this manual.

WARNING These probes are for use only on circuits that are NOT directly connected to mains. These are NOT intended for measurements on CAT II, CAT III, or CAT IV circuits.

WARNING Keep Away From Live Circuits. Avoid open circuitry. Do not touch connections or components when power is present.

WARNING Indoor Use Only. Do not operate in wet/damp environments. Keep product surfaces dry and clean.

WARNING Periodically inspect the probe and probe wires. Do not use a probe which is cracked, damaged, or has defective leads. If a failure is suspected, do not use the probe. Contact Keysight Technologies for technical assistance.

CAUTION The probe cable is a sensitive part of the probe and, therefore, you should be careful not to damage it through excessive bending or pulling. Avoid any mechanical shocks to this product in order to guarantee accurate performance and protection.

WARNING Whenever it is likely that the ground protection is impaired, you must make the instrument inoperative and secure it against any unintended operation.

WARNING To avoid dangerous electric shock, do not attempt to perform any service to the probe. Service should be carried out by a Keysight Technologies authorized service personnel. For any service needs, contact Keysight Technologies. Refer to the topic “**Returning the Probe for Service**” on page 22 to know more.

WARNING Do not install substitute parts or perform any unauthorized modification to the instrument.

WARNING Capacitors inside the instrument may retain a charge even if the instrument is disconnected from its source of supply.

WARNING Do not operate the instrument in the presence of flammable gasses or fumes. Operation of any electrical instrument in such an environment constitutes a definite safety hazard.

WARNING Do not use the instrument in a manner not specified by the manufacturer.

Instrument Markings



The CE mark is a registered trademark of the European Community. ISM GRP 1-A denotes the instrument is an Industrial Scientific and Medical Group 1 Class A product. ICES/NMB-001 indicates product compliance with the Canadian Interference-Causing Equipment Standard.



This product complies with the WEEE Directive (2002/96/EC) marking requirements. The affixed label indicates that you must not discard this electrical/electronic product in domestic household waste. Product Category: With reference to the equipment types in the WEEE Directive Annex I, this product is classed as a “Monitoring and Control instrumentation” product. Do not dispose in domestic household. To return unwanted products, contact your local Keysight office, or refer to www.keysight.com for more information.



This symbol indicates the Environmental Protection Use Period (EPUP) for the product’s toxic substances for the China RoHS requirements.

Safety Notices



Instruction manual symbol: The product is marked with this symbol when it is necessary for you to refer to the instruction manual in order to protect against damage to the product or personal injury.



Earth terminal symbol: Used to indicate a circuit common connected to grounded chassis.



Hazardous voltage symbol.

2 Characteristics and Specifications

This chapter provides the characteristics and specifications for the N2795/6A probes. The probe and oscilloscope should be warmed up for at least 20 minutes before any testing and the environmental conditions should not exceed the probe's specified limits.

Table 5 Environmental Specifications

Parameter	Characteristic
Operating Temperature	0°C to +50°C
Non-Operating Temperature	-40°C to +70°C (-40°F to +158°F)
Altitude	Operating; 4,000m (13,000 ft)
Operating Humidity	95% room humidity at +40°C
Non-Operating Humidity	90% room humidity at +65°C
ESD	8 kV HBM
Use	indoor

Table 6 Electrical Characteristics and Specifications (Sheet 1 of 2)

Item	N2795A	N2796A
Attenuation Ratio (at DC)	10:1 ± 0.5%	10:1 ± 0.5%
Bandwidth (-3 dB) ^a	1 GHz	2 GHz
Probe Risetime (calculated, 10% - 90%)	350 ps	175 ps
Input Dynamic Range	-8V to +8V (DC or Peak AC)	-8V to +8V (DC or Peak AC)

Table 6 Electrical Characteristics and Specifications (Sheet 2 of 2)

Item	N2795A	N2796A
Input Resistance ^a	1 M Ω +0%, -2.5%	1 M Ω +0%, -2.5%
Non-Destructive Maximum Input Voltage	-20V to +20V peak input, mains isolated	-20V to +20V peak input, mains isolated
Offset Range	\pm 8V	\pm 12V
DC Offset Error (Output Zero)	< \pm 1 mV	< \pm 1 mV
Flatness (both models)	Typical 0.4 dB (100 kHz - 100 MHz) Typical 0.6 dB (100 MHz - 500 MHz) Typical 0.8 dB (500 MHz - 1 GHz) Typical 1.3 dB (1 GHz - 2 GHz) ^b	
Input Capacitance	1 pF	1 pF
Probe Noise (Referred to Input)	< 2.5 mV _{rms}	< 2.5 mV _{rms}
Output Impedance	50 Ω	50 Ω
Internal Power	Keysight AutoProbe Interface from scope (InfiniiVision and Infiniium models)	

a Denotes warranted electrical specification after 20 minute warm-up. All others are typical.

b N2796A only

Table 7 Mechanical Characteristics

Parameter	Characteristic
Approximate Weight (probe only)	100g
Cable Length	1.3m

Dimensions

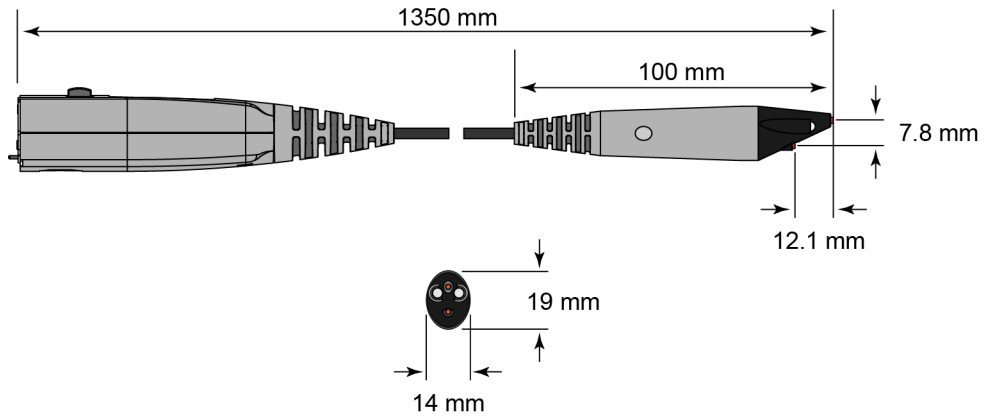

2 Characteristics and Specifications

3 Performance Data Plots

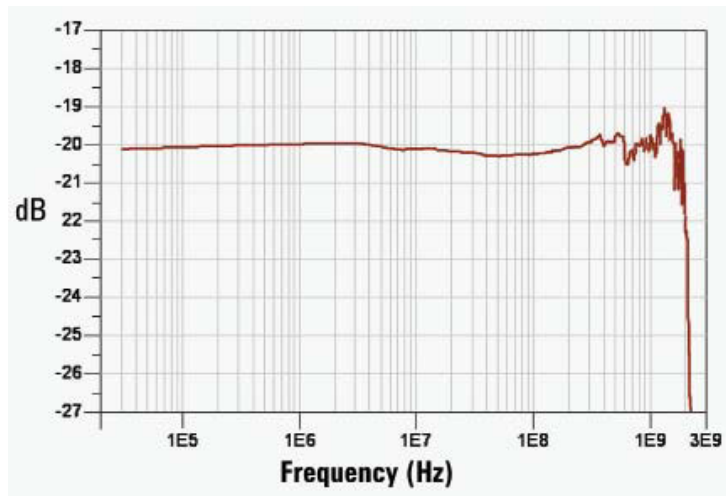

Figure 11 Frequency Response of N2796A (V_{out}/V_{in})

NOTE **Figure 11** is for the spring/rigid probe tip and an offset ground or ground blade.

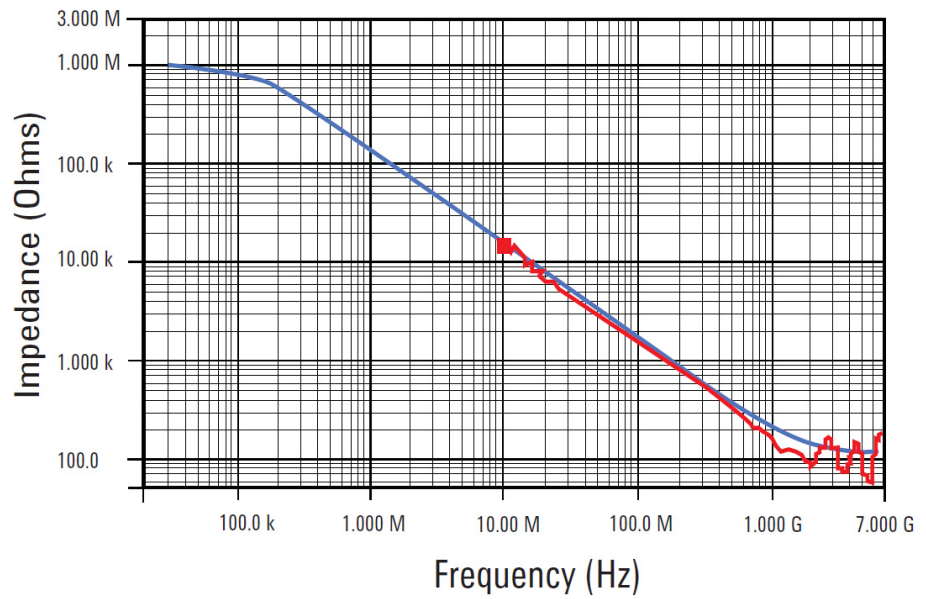

Figure 12 Input Impedance Over Frequency
(Red = measured, Blue = model)

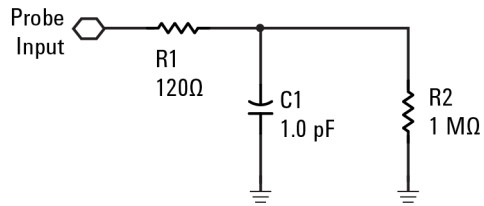

Figure 13 Input Impedance Equivalent Model

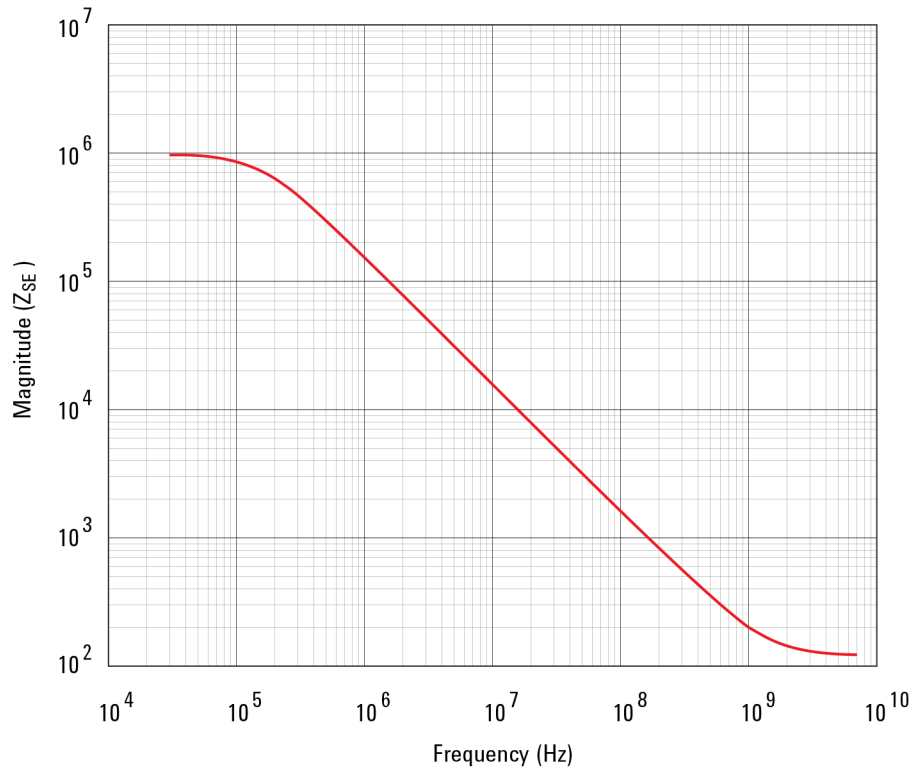

Figure 14 Typical Input Impedance Plot

4 Performance Verification

Test 1. DC Input Resistance **37**

Test 2. Bandwidth **38**





Performance Test Record **47**

These procedures are used to test the warranted specifications for the N2795/6A single-ended active probes. The recommended calibration test interval is once a year or as required. Use the equipment listed in.

CAUTION

Electrostatic discharge (ESD) can quickly and imperceptibly damage or destroy high performance probes, resulting in costly repairs. Always wear a wrist strap when handling probe components and insure that cables are discharged before being connected.

Table 8 Required Test Equipment

Test Equipment	Critical Specification	Model Number
Digital Multimeter (DMM)	Resistance $\pm 1\%$	Keysight 34401A
Vector Network Analyzer (VNA)	13 GHz sweep range full 2 port cal Option 1D5	Keysight 8720ES 
Calibration Standards	No Substitute	Keysight 85052D
External Power Supply	No Substitute	Keysight 1143A 
AutoProbe Interface Adapter	No Substitute	Keysight N1022A/B 
Outside thread 3.5 mm (male) to 3.5 mm (female) adapter	No Substitute	Keysight 5062-1247
Cable (2)	3.5 mil; SMA; High Quality	Keysight 8120-4948
Cable	1.5 mil Probe Power Extension No Substitute	Keysight 01143-61602
PV/DS Test Board	No Substitute (In E2655B Kit)	Keysight E2655-66503 

Test 1. DC Input Resistance

Procedure

- 1** Connect the DMM probes between the probe tip and ground at the tip of the probe.
- 2** Set up the DMM to measure resistance. The resistance should read $1\text{ MW} + 0\%$, -2.5% .
- 3** Record the resistance in **Table 9** on page 47.

Test 2. Bandwidth

This test ensures that the Probe meets its specified bandwidth.

N2795A bandwidth: 1 GHz

N2796A bandwidth: 2 GHz

NOTE Allow the probe to warm up for at least 20 minutes.

Using the 8720ES VNA successfully

Remember these simple guidelines when working with the 8720ES VNA during this procedure.

- Sometimes it may take a few seconds for the waveforms to settle completely. Allow time for waveforms to settle before continuing.
- Make sure all connections are tight and secure. If needed, use a vise to hold the cables and test board stable while making measurements.
- Be careful not to cross thread or force any connectors. This could be a very costly error to correct.

Procedure

Initial Setup

- 1 Turn on the 8720ES VNA and let warm up for 20 minutes.
- 2 Press the green **[Preset]** key on the 8720ES VNA.
- 3 On the VNA, press the **[Power]** key and set the power to 0 dBm.
- 4 On the VNA, press the **[AVG]** key and then select the **Averaging Factor** screen key. Set averaging to 4.
- 5 On the VNA, press the **[Sweep Setup]** key and then press the **sweep type menu** screen key. Select the **log freq** screen key.
- 6 Connect the probe under test to the Auto Probe Adapter and power the probe using the 1143A power supply. Install the outside thread adapter to the Auto Probe Adapter.

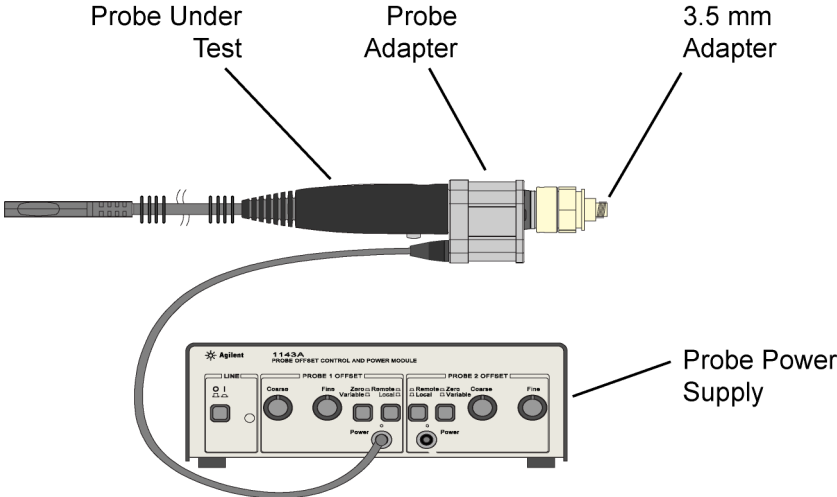

Figure 15 Probe Connected to Probe Adapter (*not to scale*)

Calibrating a Reference Plane

To get a reliable measurement from the VNA you must calibrate a reference plane so that the VNA knows where the probe under test is located along the transmission line.

- 7 On the VNA, press the **[Cal]** key.

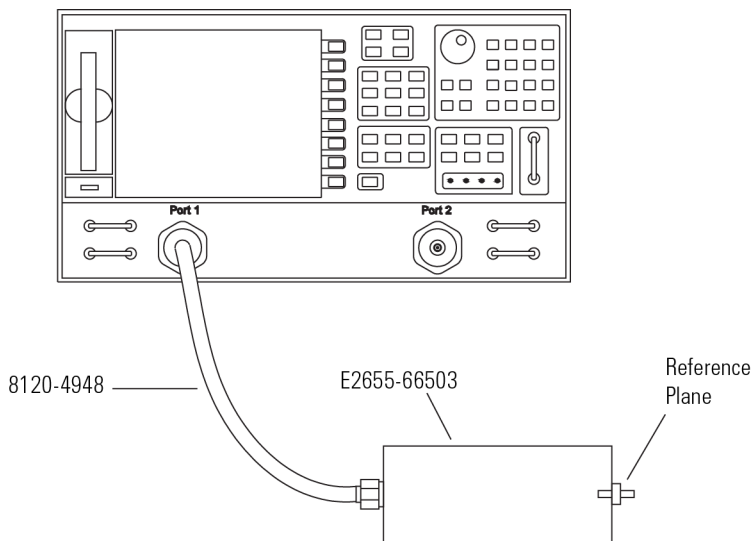

Figure 16 PV/DS Test Board Connected to VNA

- 8** Press the **cal menu** screen key.
- 9** Press the **full 2 port** screen key.
- 10** Connect one of the high quality SMA cables to port one and to the pincher side of PV/DS test board.
- 11** The calibration reference plane is at the other end of PV/DS test board.

- 12** Perform a Calibration for the **PORT 1** side of the Reference plane.
 - a** Press the **reflection** screen key.
 - b** Connect the open end of 85052D Calibration Standard to the non-pincher side of the PV/DS test board.
 - c** Select the **open** screen key under the **Forward** group.
 - d** Wait until the VNA beeps indicating that it has completed the task.
 - e** Connect short end of Calibration Standard to the non-pincher side of the PV/DS test board.
 - f** Select **short** screen key under the **Forward** group.
 - g** Wait until the VNA beeps indicating that it has completed the task.
 - h** Connect load end of Calibration Standard to the non-pincher side of the PV/DS test board.
 - i** Select the **loads** screen key under the **Forward** group.
 - j** Press **broadband** screen key selection.
 - k** Wait until the VNA beeps indicating that it has completed the task.
 - l** Press the **done loads** screen key.
 - m** You have just calibrated one side of the reference plane.
- 13** Connect the other high quality SMA cable to the VNA's **PORT 2**.

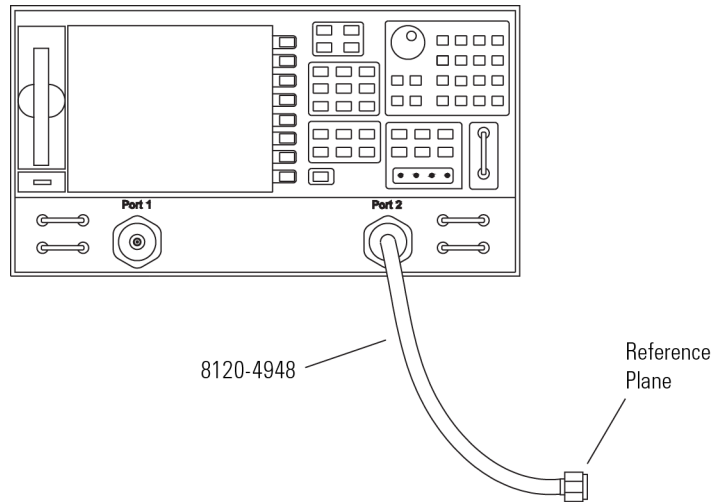

Figure 17 SMA Cable Connected to Port 2

- 14 Get the opposite sex of the Calibration Standards for the next step.

- 15** Perform Calibration for the **PORT 2** side of the Reference plane.
 - a** Press the **reflection** screen key.
 - b** Connect the open end of Calibration Standard to the available end of the **PORT 2** SMA cable.
 - c** Select the **open** screen key under the **Reverse** group.
 - d** Wait until the VNA beeps indicating that it has completed the task.
 - e** Connect short end of Calibration Standard to the available end of the **PORT 2** SMA cable.
 - f** Select **short** screen key the **Reverse** group.
 - g** Wait until the VNA beeps indicating that it has completed the task.
 - h** Connect load end of Calibration Standard to the available end of the **PORT 2** SMA cable.
 - i** Select the **loads** screen key the **Reverse** group.
 - j** Press **broadband** screen key selection.
 - k** Wait until the VNA beeps indicating that it has completed the task.
 - l** Press the **done loads** screen key.
 - m** You have just calibrated the other side of the reference plane.
- 16** Press **standards done** key.
- 17** Connect port two SMA cable to the non-pincher side of PV/DS test board.

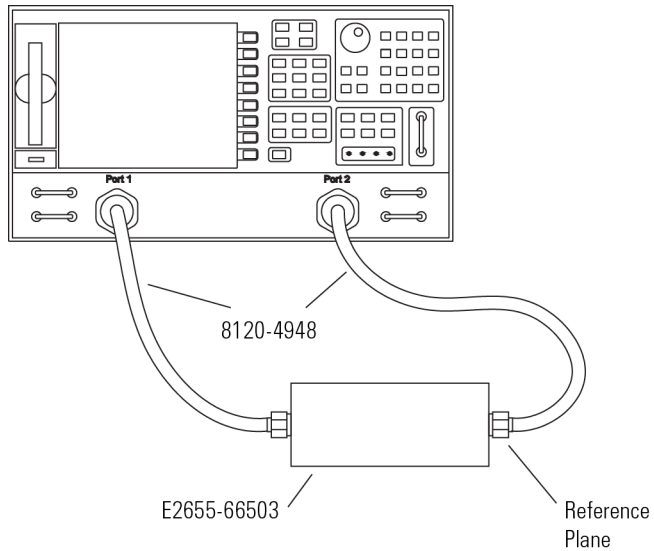

Figure 18 Forward and Reverse Setup

- 18** Press the **transmission** screen key.
- 19** Press the **do both fwd and reverse** screen key.
- 20** Wait until the VNA beeps four times indicating that it has completed the task.
- 21** Press the **isolation** screen key.
- 22** Press the **omit isolation** screen key.
- 23** Press **done 2 port cal** screen key.
- 24** Set the VNA's averaging to off.
- 25** Save the reference plane cal by pressing the **[save recall]** key then the **[save state]** key.
- 26** You may change name if you wish.
- 27** Press the **[scale reference]** key. Then set the scale to 1 dB per division and the reference position for 7 divisions.
- 28** Set reference value for 0 dB.
- 29** Press the **[measure]** key.
- 30** Press the **s21** screen key.

- 31 Ensure s21 response on screen is flat out to 1 GHz (N2795A) or 2 GHz (N2796A).

Measuring Vin Response

- 32 Position the probe conveniently to allow the probe tip to be normal to the PV/DS board.
- 33 Hold the probe in position, or use a positioner, so that the signal and ground are making contact and are perpendicular to the fixture.
- 34 Press the **[Sweep Setup]** key on the VNA. Then press the **trigger menu** screen key. Select the **continuous** screen key.
- 35 You should now have the V_{in} waveform on screen.
- 36 Select **[display]** key then **data->memory** screen key.
- 37 You have now saved Vin waveform into the VNA's memory for future use.

Measuring Vout Response

- 38 Disconnect the **PORT 2** cable from PV/DS test board and attach to probe output on the AutoProbe Adapter.
- 39 Connect the Calibration Standard load to PV/DS test board (non-pincher side).
- 40 Press **[scale reference]** key on the VNA.
- 41 Set reference value to -20 dB.
- 42 Hold probe in place as described previously.
- 43 The display on screen is V_{out} .

Displaying Vout/Vin Response on the VNA

- 44 Press the **[Display]** key.
- 45 Then select the **Data/Memory** screen key. You may need to adjust the **Reference Value**, located under the **Scale Ref** key, slightly to position the waveform at center screen.
- 46 Press marker key and position the marker to the first point that the signal is -3 dB below center screen.

47 Read marker frequency measurement and record it in the test record located later in this chapter.

48 The bandwidth test passes if the frequency measurement is greater than the probe's bandwidth limit.

N2795A bandwidth: 1 GHz

N2796A bandwidth: 2 GHz

Performance Test Record

Table 9 Performance Test Record

Model #:	Date:	Tested by:	
Serial #:	Recommended next test date:		
Recommended Test Interval: 1 year / 2000 hours			
Probe Amplifier	Test Limits	Result	Pass/Fail
Test 1. DC Input Resistance	1 M Ω + 0%, -2.5%		
Test 2. Bandwidth	\geq 1 GHz (N2795A) \geq 2 GHz (N2796A)		

Index

A

accessories
 attaching, 8
 supplied, 8
 accessory kit, 10
 altitude, 27
 attenuation ratio, 27

B

bandwidth, 12, 27

C

cable, 6
 CE mark, 25
 channel identification rings, 10
 cleaning, 6
 compatibility, 7
 compatible oscilloscopes, 7
 copper pads, 9, 15

D

dimensions, 29
 dynamic range, 19, 27

E

environmental specifications, 27
 ESD, 6

F

flex ground, 9
 flex nose clip, 9, 10
 flexible nose clips, 17
 frequency response, 31
 functional test, 20

G

ground blade, 9, 13
 ground leads, 18

H

headlight, 11
 humidity, 27

I

Infiniium, 7
 input capacitance, 28
 input impedance over frequency, 33
 input resistance, 28
 inspecting, 21
 ISM1-A, 25

K

Keysight Technologies, contacting, 22

N

N5442A adapter, 7

O

offset ground, 9, 13
 offset range, 19
 operating temperature
 probe, 27
 oscilloscope
 compatible, 7
 software version, 7
 oscilloscope compatibility, 7
 output impedance, 28

P

performance test record, 47
 performance verification, 35
 probe
 cleaning, 6
 configurations, 12
 dimensions, 29
 handling, 23
 inspecting, 21
 service, 22
 probe accessories, 12

probe, inspecting, 21

R

returning for service, 22
 right angle ground, 9, 10
 right-angle ground, 13, 18
 rigid probe tip, 9, 10
 rigid tips, 13

S

safety information, 23
 service, 22
 solderable tip, 18
 specifications, 27
 spring probe tip, 9, 10
 spring tips, 13
 supplied accessories, 8

T

temperature, 27

W

weight, 28

Y

Y-lead adapter, 9, 10, 16
 Y-lead with clips, 17
 Y-leads, 15, 16

Index