

N2870A-Series and N2894A Passive Probes

User's
Guide



Notices

© Keysight Technologies, 2009 - 2014, 2016, 2018, 2019
Keysight Technologies
1900 Garden of the Gods Road
Colorado Springs, CO 80907 USA

Manual Part Number

N2876-97003

Edition

July 2019
Printed in Germany

U.S. Government Rights

The Software is "commercial computer software," as defined by Federal Acquisition Regulation ("FAR") 2.101. Pursuant to FAR 12.212 and 27.405-3 and Department of Defense FAR Supplement ("DFARS") 227.7202, the U.S. government acquires commercial computer software under the same terms by which the software is customarily provided to the public. Accordingly, Keysight provides the Software to U.S. government customers under its standard commercial license, which is embodied in its End User License Agreement (EULA), a copy of which can be found at <http://www.keysight.com/find/sweula>. The license set forth in the EULA represents the exclusive authority by which the U.S. government may use, modify, distribute, or disclose the Software. The EULA and the license set forth therein, does not require or permit, among other things, that Keysight: (1) Furnish technical information related to commercial computer software or commercial computer software docu-

mentation that is not customarily provided to the public; or (2) Relinquish to, or otherwise provide, the government rights in excess of these rights customarily provided to the public to use, modify, reproduce, release, perform, display, or disclose commercial computer software or commercial computer software documentation. No additional government requirements beyond those set forth in the EULA shall apply, except to the extent that those terms, rights, or licenses are explicitly required from all providers of commercial computer software pursuant to the FAR and the DFARS and are set forth specifically in writing elsewhere in the EULA. Keysight shall be under no obligation to update, revise or otherwise modify the Software. With respect to any technical data as defined by FAR 2.101, pursuant to FAR 12.211 and 27.404.2 and DFARS 227.7102, the U.S. government acquires no greater than Limited Rights as defined in FAR 27.401 or DFAR 227.7103-5 (c), as applicable in any technical data. 52.227-14 (June 1987) or DFAR 252.227-7015 (b)(2) (November 1995), as applicable in any technical data.

Safety Notices

CAUTION

A CAUTION notice denotes a hazard. It calls attention to an operating procedure, practice, or the like that, if not correctly performed or adhered to, could result in damage to the product or loss of important data. Do not proceed beyond a CAUTION notice until the indicated conditions are fully understood and met.

WARNING

A WARNING notice denotes a hazard. It calls attention to an operating procedure, practice, or the like that, if not correctly performed or adhered to, could result in personal injury or death. Do not proceed beyond a WARNING notice until the indicated conditions are fully understood and met.

Contents

Introduction	4
Safety Information	8
Low-Frequency Compensation	11
Accessories	12
Replacing Rigid, Solid Probe Tip, and Spring-Loaded Probe Tips	13
Short Ground Blade and Ground Spring	14
Sprung Hooks	15
15 cm Ground Lead	15
BNC Adapter	15
Copper Pads	16
Insulator Cap	16
Channel Identification Rings	16
IC Caps	17
PCB Adapter Kit	18
Available Accessories	19
Accessories in Kits	19
Other Individually Orderable Accessories	23
Characteristics and Specifications	26
Performance Verification Procedures	32
Performance Verification Test Record	35
IEC Measurement Category Definitions	36
IEC Pollution Degrees Definitions	37

Introduction

When used with a Keysight oscilloscope, the N2870A-Series and N2894A passive probes set a new standard for “high performance” probing of up to 1.5 GHz. These general purpose probes and accessories are a great choice if you are looking for high quality at a very reasonable price.

Table 1 Probe Models

Model	Band width (-3 dB)	Attenuation Ratio	Input C (+scope)	Input R (scope + probe)	Max Input Vol tage (AC RMS)	Scope Input Coupling	Scope Comp Range
N2870A	35 MHz	1:1	39 pF (+scope)	1 M Ω	30 Vrms mains isolated, 60 Vdc	1 M Ω	–
N2871A	200 MHz	10:1	9.5 pF	10 M Ω	400 V mains isolated ^a 300 V CAT II ^b	1 M Ω	10 - 25 pF
N2872A	350 MHz	10:1	9.5 pF	10 M Ω	400 V mains isolated ^a 300 V CAT II ^b	1 M Ω	10 - 25 pF
N2873A	500 MHz	10:1	9.5 pF	10 M Ω	400 V mains isolated ^{a, c} 300 V CAT II ^b	1 M Ω	10 - 25 pF
N2874A	1.5 GHz	10:1	1.8 pF	500 Ω	8.5 V mains isolated ^d	50 Ω	–
N2875A	500 MHz	20:1	5.6 pF	20 M Ω	400 V mains isolated ^a 300 V CAT II ^b	1 M Ω	7-20 pF
N2876A	1.5 GHz	100:1	2.2 pF	5 k Ω	21 V mains isolated ^d	50 Ω	–
N2894A	700 MHz ^e	10:1	9.5 pF	10 M Ω	400 V mains isolated ^{a, f} 300 V CAT II ^b	1 M Ω	10 - 25 pF

^a Maximum pulse rating = 1,650 V (step 0 V to 1,650 V), mains isolated, no overshoot permitted, connected to oscilloscope with an input impedance of 1 M Ω \pm 1%, not applicable with InfiniiVision 6000X, Infiniium S and 9000 Series.

^b Measurement Category II

- c 300 Vrms, 400 V (DC + peak AC) mains isolated; 0 V transient overvoltage with Infiniium S and 9000 Series.
- d Mains isolated, 0 V transient overvoltage
- e 700 MHz bandwidth available with InfiniiVision 4000X/6000X with 1 GHz or higher bandwidth models only
- f 300 Vrms, 400 V (DC + peak AC) mains isolated; 0 V transient overvoltage with InfiniiVision 6000X

Faithful Reproduction of Signals

These probes offer bandwidths of 35 MHz, 200 MHz, 350 MHz, 500 MHz, 700 MHz, and 1.5 GHz along with various attenuation ratios to address a wide range of measurement needs. For general purpose probing, the N2873A's superior 10 M Ω input resistance, 9.5 pF of low input capacitance, and low inductance ground connection keep probe loading low enough to achieve high signal integrity measurements. The 1.5 GHz passive probe offers an even lower input capacitance for measuring faster edges more accurately, making it a good low-cost alternative to an active probe. All of these probes are automatically recognized when connected to Keysight InfiniiVision and Infiniium Series oscilloscopes.

Easy Access to Signals

The compact design along with a 2.5 mm probe tip diameter provide better visibility of the circuit under test when compared to the conventional 5 mm or 3.5 mm probes. This makes it easier to probe today's fine pitched ICs and components. To learn more about probe tips and accessories, refer to "Accessories" on page 12.

Inspecting the Probe

- Inspect the shipping container for damage.
Keep the damaged shipping container or cushioning material until the contents of the shipment have been checked for completeness and the probe has been checked mechanically and electrically.
- Check the accessories.
If the contents are incomplete or damaged, notify your Keysight Technologies Sales Office.
- Inspect the instrument.
If there is mechanical damage or defect, or if the probe does not operate properly or pass performance verification tests, notify your Keysight Technologies Sales Office.

If the shipping container is damaged, or the cushioning materials show signs of stress, notify the carrier as well as your Keysight Technologies Sales Office. Keep the shipping materials for the carrier's inspection. The Keysight Technologies office will arrange for repair or replacement at Keysight Technologies' option without waiting for claim settlement.

Cleaning the Probe

Disconnect the probe and clean it with a soft cloth dampened with a mild soap and water solution. Make sure the probe is completely dry before reconnecting it to an oscilloscope.

Handling the Probe

Handle the probe with care to avoid injury, especially when it is fitted with the extra thin and sharp spring contact tip.

CAUTION

The probe cable is a sensitive part of the probe and, therefore, you should be careful not to damage it through excessive bending or pulling. You should also avoid any mechanical shocks to this product in order to guarantee accurate performance and protection.

Safety Information

WARNING

To avoid personal injury and to prevent fire or damage to this product or products connected to it, review and comply with the following safety precautions. Be aware that if you use this probe assembly in a manner not specified, the protection this product provides may be impaired.

WARNING

Handle Probe Tips / Accessories Carefully. Some of the probe tips / accessories are very sharp (the spring tips and ground spring, for example). You should handle these with care to avoid personal injury.

WARNING

Use Only Grounded Instruments. Do not connect the probe's ground lead to a potential other than earth ground. Always make sure the probe and the oscilloscope are grounded properly.

WARNING

Connect and Disconnect Properly. Connect the probe to the oscilloscope and connect the ground lead to earth ground before connecting the probe to the circuit under test. Disconnect the probe input and the probe ground lead from the circuit under test before disconnecting the probe from the oscilloscope.

WARNING

Observe Probe Ratings. Do not apply any electrical potential to the probe input which exceeds the maximum rating of the probe. Make sure to comply with the voltage versus frequency derating curve in this manual.

WARNING

Keep Away From Live Circuits. Avoid open circuitry. Do not touch connections or components when power is present.

WARNING

Indoor Use Only. Do not operate in wet/damp environments. Keep product surfaces dry and clean.

WARNING

Periodically inspect the probe and probe wires to check for any damage. Do Not Operate With Visible or Suspected Failures. If you suspect there is damage, have it inspected by a Keysight authorized service personnel.

WARNING

Do Not Operate in an Explosive Environment.





CAUTION

The applicable measurement category of a probe assembly and an accessory is the lower of the measurement category of the probe assembly and the accessory.

WARNING

When the insulation of the probe's cable deteriorates, the wear indicator becomes visible. Do not use the probe, when the wear indicator is visible through the cable jacket. Using a product with a worn cable may result in electric shock, fire, or equipment failure.

Instrument Markings and Safety Symbols

	<p>This product complies with the WEEE Directive (2002/96/EC) marking requirements. The affixed label indicates that you must not discard this electrical/electronic product in domestic household waste. Product Category: With reference to the equipment types in the WEEE Directive Annex I, this product is classed as a "Monitoring and Control instrumentation" product. Do not dispose in domestic household. To return unwanted products, contact your local Keysight office, or refer to www.keysight.com for more information.</p>
	<p>This symbol indicates the Environmental Protection Use Period (EPUP) for the product's toxic substances for the China RoHS requirements.</p>
	<p>Recycle marking</p>
	<p>Instruction manual symbol: The product is marked with this symbol when it is necessary for you to refer to the instruction manual in order to protect against damage to the product or personal injury.</p>

Low-Frequency Compensation

The N2871A, N2872A, N2873A, N2875A, and N2894A can be adjusted for low frequency (LF) compensation. The N2870A, N2874A, and N2876A cannot be adjusted.

The probe should be adjusted for LF compensation when it is connected to an oscilloscope input for the first time. LF compensation matches the probe cable capacitance to the oscilloscope input capacitance. This matching assures good amplitude accuracy from DC to the upper bandwidth limit frequencies. A poorly compensated probe clearly influences the overall system performance (probe and oscilloscope) and introduces measurement errors resulting in inaccurate readings and distorted waveforms. To perform the LF compensation:



To perform the LF compensation:

- 1 Connect the probe to the oscilloscope's front-panel calibration output (a square wave label is usually seen near this output).
- 2 Use the supplied trimmer tool to adjust the LF compensation to an optimum square wave response as shown in this picture.

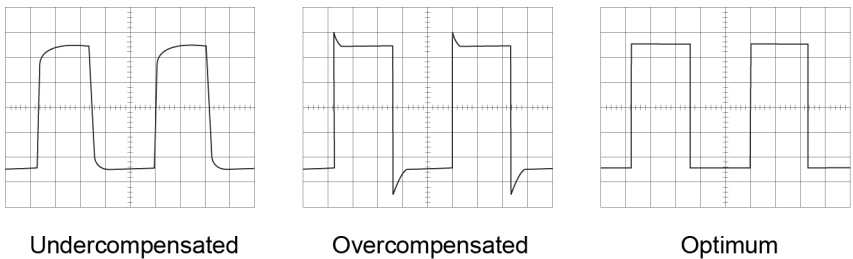

Figure 1 LF Compensation

Accessories

The probe comes with the accessories listed in [Table 2](#). For a broader range of available accessories, order the accessory kits described in "Available Accessories" on page 19.

Table 2 **Supplied Accessories**

Accessory	Quantity	N2871A, N2872A, N2873A, N2875A, N2894A	N2870A	N2874A, N2876A
Spring-loaded probe tips	2	✓	✓	✓
Rigid probe tips	2	✓	✓	✓
Ground blade 2.5 mm	1	✓	✓	✓
Ground spring 2.5 mm	1	✓	✓	✓
Sprung hook 2.5 mm	1	✓	✓	
Short sprung hook 2.5 mm	1			✓
Ground lead 15 cm	1	✓	✓	✓
Copper pads	2	✓	✓	✓
IC cap 2.5 - 0.5 mm green	1	✓	✓	✓
IC cap 2.5 - 0.65 mm blue	1	✓	✓	✓
IC cap 2.5 - 0.8 mm gray	1	✓	✓	✓
IC cap 2.5 - 1.0 mm brown	1	✓	✓	✓
IC cap 2.5 - 1.27 mm black	1	✓	✓	✓
BNC adapter 2.5 mm	1	✓	✓	✓
Insulating cap 2.5 mm	1	✓	✓	✓
Protection cap 2.5 mm	1	✓	✓	✓

Accessory	Quantity	N2871A, N2872A, N2873A, N2875A, N2894A	N2870A	N2874A, N2876A
Trimmer tool	1	✓		
Color coding rings	3x4 colors	✓	✓	✓
User's Guide	1	✓	✓	✓

Replacing Rigid, Solid Probe Tip, and Spring-Loaded Probe Tips

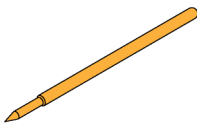

The solid tips and spring-loaded tips are replaceable. Spring loaded probe tips offer a method of probing signals that is less susceptible to vibration or movement than traditional rigid tips. Many users find it easier to use this type of tip. The spring loaded tips work when they are either partially or fully compressed and are protected against over compression

damage.

To change the probe tip, use pliers to grip the tip and pull it straight out of its contact socket along the axis of the probe. Do not grip the plastic insulator or the housing with the pliers because the tip could be crushed (see [Figure 2](#)). This could result in being unable to remove the tip and/or damaging the probe. Once the probe tip is removed, the new tip can be inserted with pliers into the contact socket along the axis of the probe. In order to insert the probe tip completely into the housing, carefully press the probe tip against a hard surface.

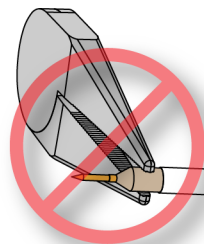
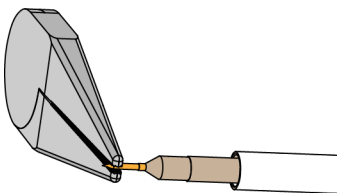

Figure 2 Proper Tip Removal Technique

WARNING

You should exercise caution when using these sharp probe tips to avoid personal injury.

Short Ground Blade and Ground Spring

The short ground blade is the best performing ground connection available due to its low inductance. To attach the ground blade, simply push it over the probe tip and continue pushing until the blade is inserted into the notch located on the probe barrel, as shown in Figure 3. This will keep it from spinning around on the probe while in use. You can also bend and form the blade to reach your grounding location. In the picture, you can see that the ground blade was placed over the tip and then an IC cap accessory was placed over the tip.

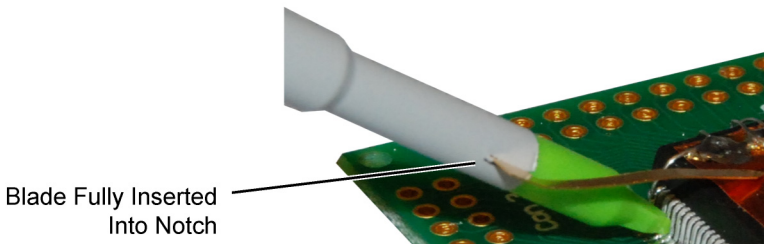

Figure 3 Blade inserted into the Probe Notch

The ground spring offers similar performance as the ground blade and depending on the probing situation, may offer greater flexibility when making a ground connection. The ground spring is also inserted over the probe tip in a similar manner. It is mainly used for browsing as it is flexible and snaps back to original orientation (unlike the ground blade that you can form) which allows you to connect it to your grounding location and then move the probe tip around. It does have a slightly larger inductance than the ground blade which may result in some decrease in performance depending on the application.

Sprung Hooks

You will see a gray line (shown as black in the picture below) with an arrow pointing towards it on the barrel of your N287XA Series probe. This is used as a marker to tell you when you have pushed the sprung hook completely onto the probe. When inserting the sprung hook onto the probe barrel, push until you feel it lock onto the ridge (see [Figure 4](#)). If you do not push the sprung hook to this point so it can engage and “lock on” to the probe, the accessory may fall off or suffer a decrease in performance. If the sprung hook is correctly attached then the gray marking line should be covered when the hook is fully extended

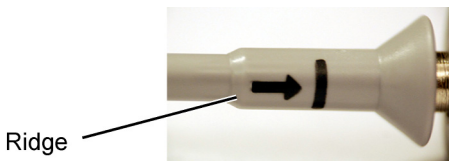
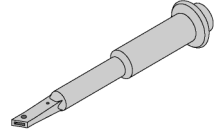
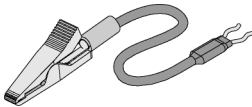

Figure 4 Ridge Location on Probe

15 cm Ground Lead



This ground lead can be used to reach grounding locations that are farther away from the probing location than can be reached by either the ground blade or ground spring. However, the longer lead means it has a larger inductance in the ground return path which corresponds to a lower performance than these other two grounding accessories.

BNC Adapter

Both the rigid and spring-loaded probe tips are compatible with this adapter.

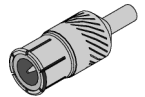

Copper Pads

These self adhesive copper pads can be attached on top of an IC and connected to its ground pins to create a convenient ground plane for the probe to connect to. When used with the ground blade, this method provides an ideal ground connection for probing signals with high frequency content. However, to maximize the performance of this setup, you need to connect the copper pad to as many grounding locations as possible.

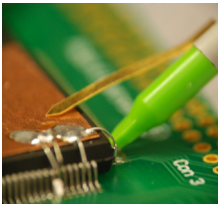
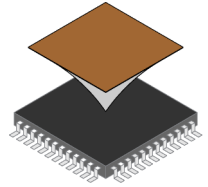
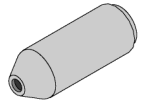

Figure 5 Copper Pad on IC

Insulator Cap

This cap fits over the probe tip and covers the ground barrel of the probe, covering any potential shorting locations near the tip. This enables you to probe in hot environments without having to worry about shorts.



Channel Identification Rings

The channel identification rings can be used to keep track of which probe is connected to which channel input on your oscilloscope. Place one ring on the probe cable near the oscilloscope input and place another ring of the same color near the probe head. This ensures that you can pick up a probe and immediately know which channel it is connected to without having to track the cable back to the oscilloscope channel input.



IC Caps

The IC caps fit over the probe tip and provide a convenient self-aligning connection to an IC's pins. This helps maintain contact on small fine pitch legs and prevents shorting adjacent pins by preventing the probe tip from sliding between the legs of the component.

The different colored IC caps correspond to different pitches as listed in Table 2 on page 12.

Figure 6 shows how pitch is measured and how the caps fit around the IC pins and where the probe tip comes through the cap. IC caps are compatible with both the rigid and spring loaded tips.

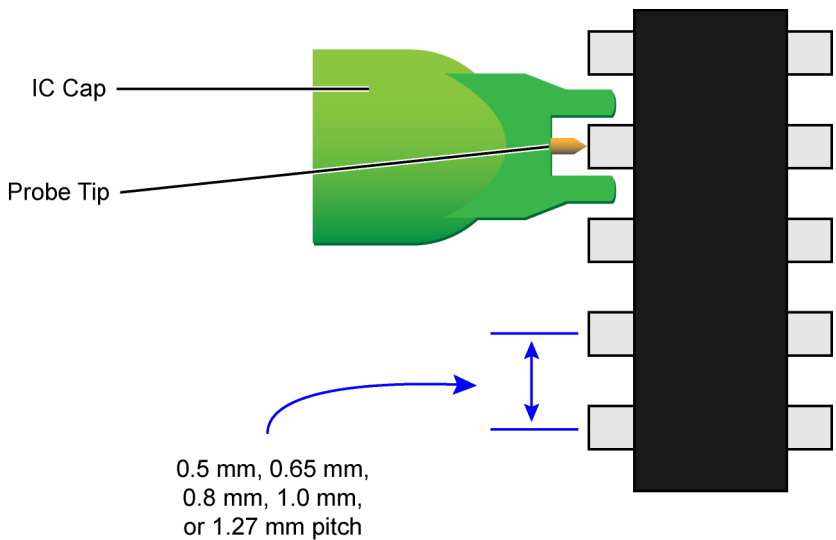
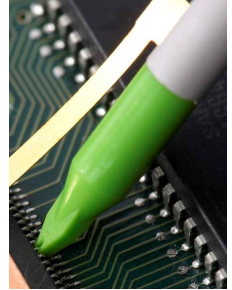
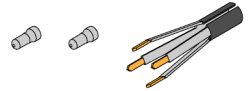

Figure 6 View of Top of IC with IC Cap Positioned Over IC Pin (not drawn to scale)

PCB Adapter Kit

The PCB Adapter Kit is not included in the Standard Accessories. However, the PCB Adapter Kit does not include its own documentation so its features will be documented in this User's Guide. The PCB Adapter sockets are designed to solder into a printed circuit board (PCB) as test points to minimize ground inductance and maximize signal fidelity.



The recommended PCB layout is shown in Figure 7. The PCB socket is compatible with hand soldering and reflow processes. After soldering the socket - both the signal contact and ground contact - to the board, simply insert the probe. The PCB adapter is compatible with either the rigid or spring-loaded probe tip.

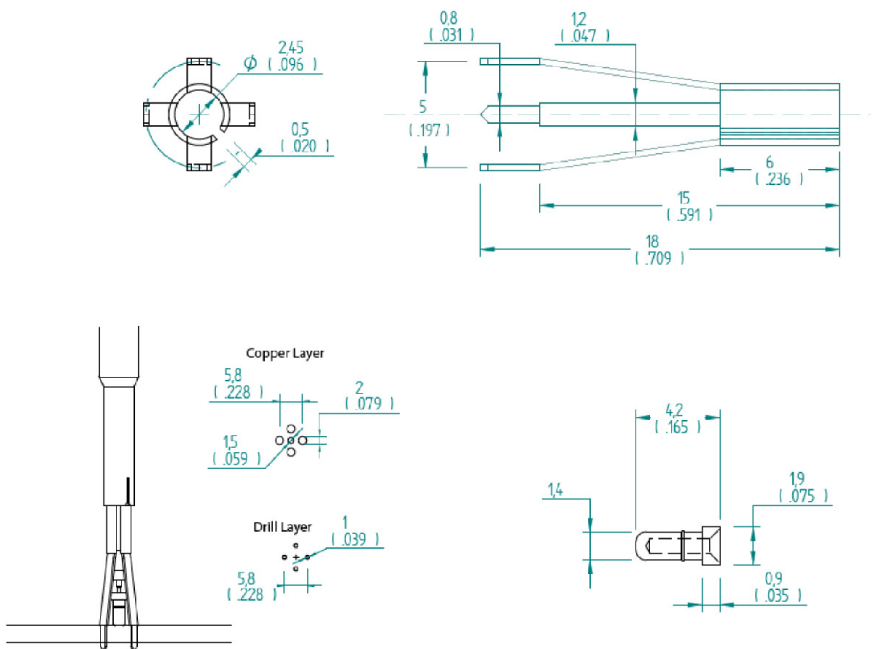
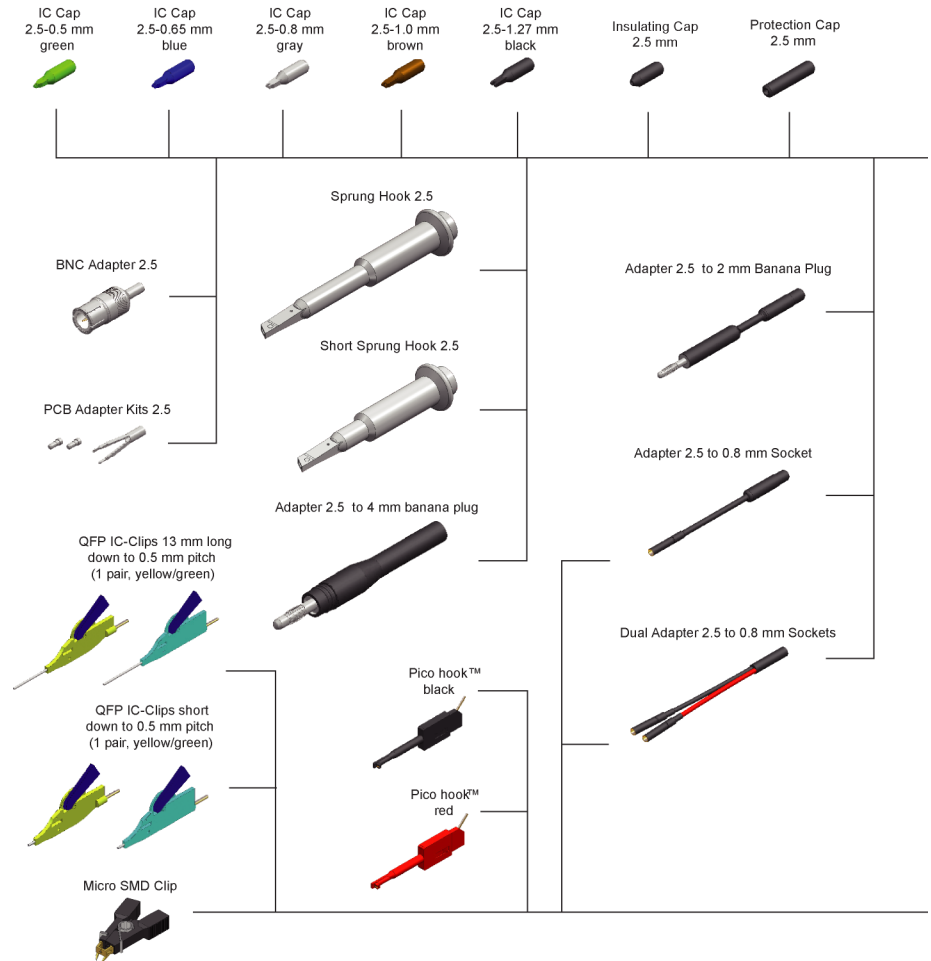

Figure 7 Recommended PCB Layout

Available Accessories

Accessories in Kits

The available accessories shown in this picture are listed in Table 3 on page 21 with their associated accessory kits.



Available Accessories

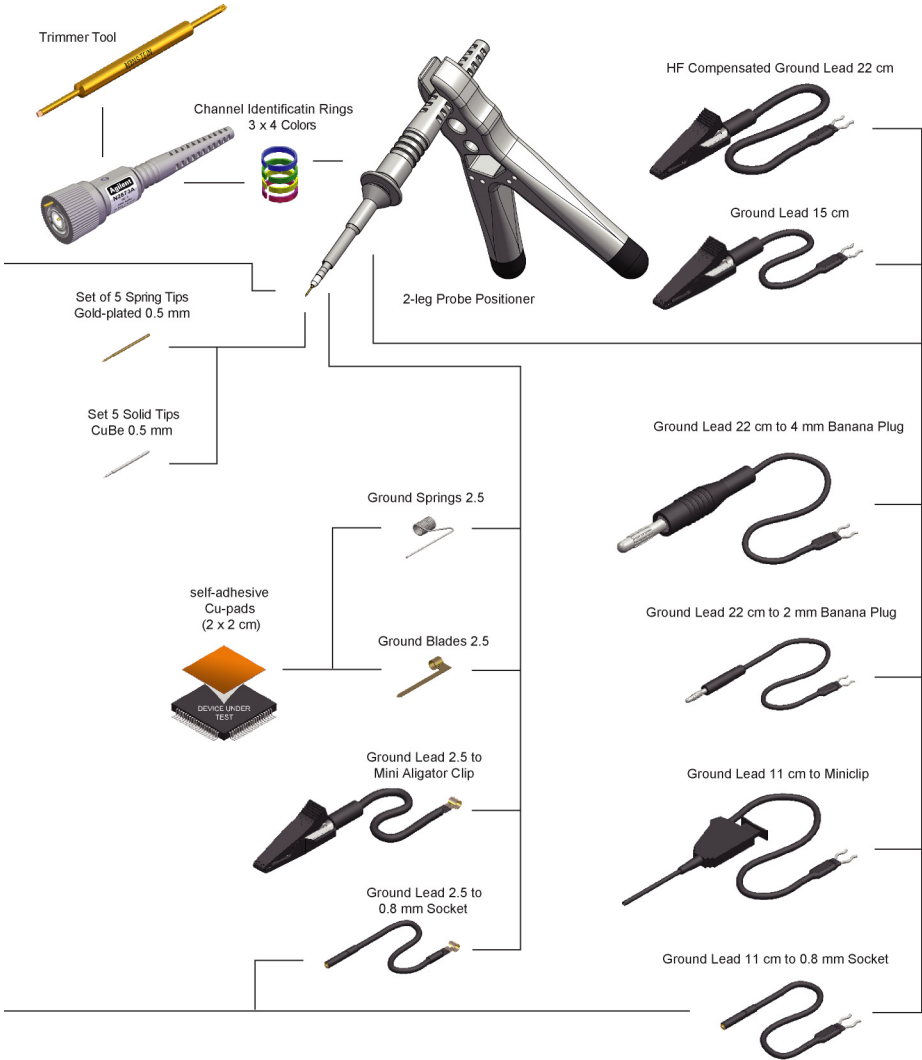

Table 3 **Accessory Quantity in Kits**

Optional Accessory	N2877A Deluxe Kit	N2879A Fine Pitch Kit	N2878A General Purpose Kit	N2885A PCB Socket Adapter Kit	Accessory P/N
IC Cap 2.5 - 0.5 mm green	3	3	1	–	0960-2983
IC Cap 2.5 - 0.65 mm blue	3	3	1	–	0960-2984
IC Cap 2.5 - 0.8 mm gray	3	3	1	–	0960-2988
IC Cap 2.5 - 1.0 mm brown	3	3	1	–	0960-2989
IC Cap 2.5 - 1.27 mm black	3	3	1	–	0960-2986
Insulating Cap 2.5 mm	1	1	1	–	0960-2985
Protection Cap 2.5 mm	1	1	1	–	0960-2996
LF Compensation Trimmer Tool	1	–	–	–	–
HF Compensated Ground Lead 22 cm	1	–	–	–	0960-2993
Ground Lead 22 cm to 4 mm banana plug	1	–	–	–	–
Ground Lead 22 cm to 2 mm banana plug	1	–	–	–	–
Ground Lead 11 cm to miniclip	1	–	–	–	0960-2977
Ground Lead 11 cm to 0.8 mm socket	1	–	–	–	0960-2978
Ground Spring 2.5 mm	3	3	–	–	0960-2980
Self-adhesive Cu-pads (2 x 2 cm)	10	10	10	–	0960-2908
Ground Blade 2.5 mm	3	3	1	–	0960-2982
Ground Lead 2.5 to mini Alligator Clip	1	–	–	–	0960-2991
Ground Lead 2.5 to 0.8 mm socket	1	–	–	–	0960-2994
Set of 5 Spring Tips Gold-plated 0.5 mm	1	1	1	–	0960-2981
Set of 5 Solid Tips CuBe 0.5 mm	1	1	1	–	0960-2979
Adapter 2.5 to 2 mm banana plug	1	–	–	–	–
Adapter 2.5 to 0.8 mm socket	2	–	–	–	0960-2990
Dual Adapter 2.5 to 0.8 mm sockets	2	2	–	–	0960-2898

Available Accessories

Optional Accessory	N2877A Deluxe Kit	N2879A Fine Pitch Kit	N2878A General Purpose Kit	N2885A PCB Socket Adapter Kit	Accessory P/N
Sprung Hook 2.5 mm	1	–	1	–	0960-2905
Short Sprung Hook 2.5 mm	1	–	–	–	0960-2907
Adapter 2.5 to 4 mm banana plug	1	–	–	–	–
Pico Hook black	2	2	–	–	–
Pico Hook red	2	2	–	–	–
BNC Adapter 2.5 mm	1	–	–	–	0960-2987
PCB Adapter Kit 2.5 mm	1	10	–	25	–
QFP IC-Clips 13 mm long down o 0.5 mm pitch (1 pair yellow/green)	2	2	–	–	0960-2992
QFP IC-Clips short down to 0.5 mm pitch (1 pair yellow/green)	2	2	–	–	0960-2995
Ground Lead 15 cm	1	–	1	–	0960-2906
Channel Identification Rings, 4 colors	3	–	3	–	–
2-leg Probe Positioner	1	1	–	–	N2786-6000 1
Micro SMD Clip	1	2	–	–	–

Other Individually Orderable Accessories

This section lists the accessories that are not included with the accessory kits mentioned in the previous section but can be ordered individually.

Table 4 Other Individually Orderable Accessories

Model Number	Description	For use with	Qty per kit
N4829A	Probe tip kit (Rigid and spring loaded)	N2870A-76A, N2894A passive probe	10 each
N4831A	Sprung hook tip	N2870A-76A, N2894A passive probe	2
N4836A	Dual lead adapter 2.5mm, 10cm	N2870A-76A, N2894A passive probe	2
N4837A	Ground lead, 15cm	N2870A-76A, N2894A passive probe	2
N4838A	Ground Spring, 2.5 mm	N2870A-76A, N2894A passive probe	2
N4863A	2.5 mm probe tip-to-PCB adapter, horizontal	N2870A-76A, N2894A passive probe	2
N4864A	2.5 mm probe tip-to-PCB adapter, vertical	N2870A-76A, N2894A passive probe	2

N4863A Horizontal PCB Adapter Dimensions

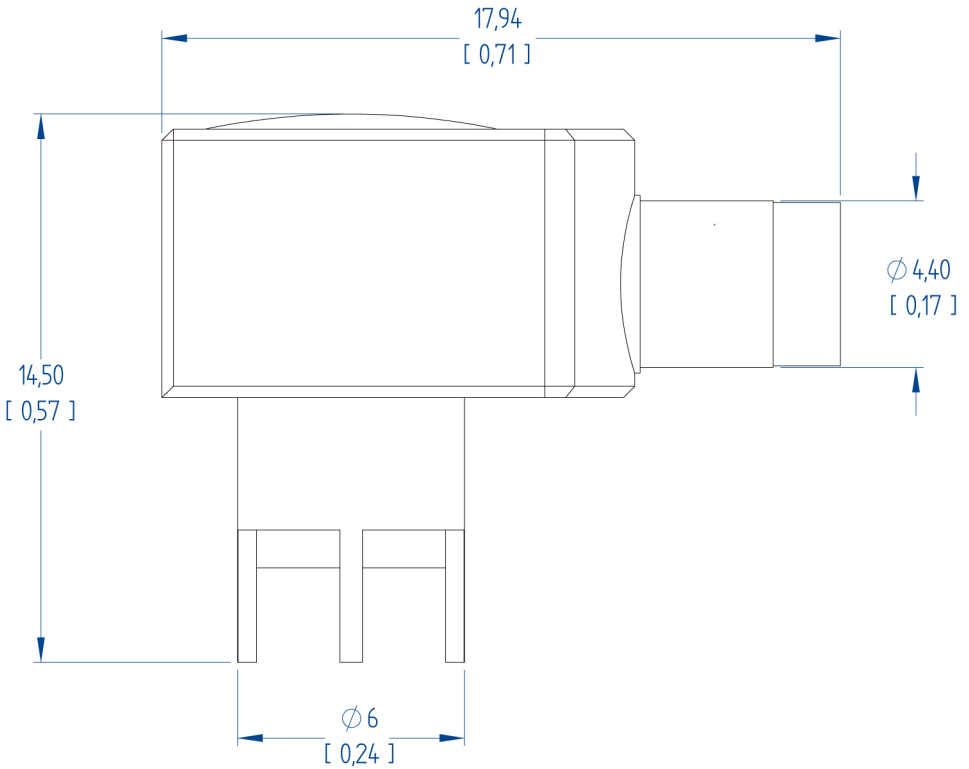

All dimensions shown in the above figure are in millimeters [inches]

N4864A Vertical PCB Adapter Dimensions

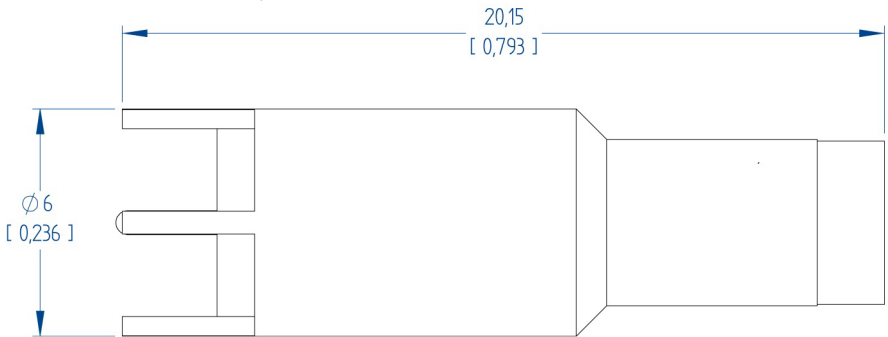

All dimensions shown in the above figure are in millimeters [inches]

Drill and Solder Layout of N4863/4A

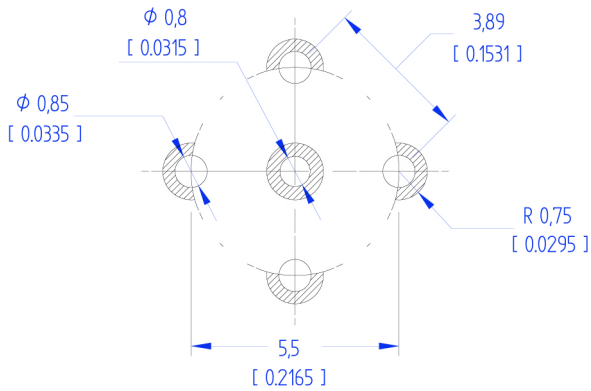

All dimensions shown in the above figure are in millimeters [inches]

Characteristics and Specifications

This section lists the characteristics and specifications for the probes. The probe and oscilloscope should be warmed up for at least 20 minutes before any testing and the environmental conditions should not exceed the probe's specified limits.

Table 5 Electrical Characteristics

Description	Characteristic
Attenuation ratio	N2870A: 1:1 N2871A: 10:1 N2872A: 10:1 N2873A: 10:1 N2874A: 10:1 N2875A: 20:1 N2876A: 100:1 N2894A: 10:1
Bandwidth (-3 dB)	N2870A: 35 MHz N2871A: 200 MHz N2872A: 350 MHz N2873A: 500 MHz N2874A: 1.5 GHz N2875A: 500 MHz N2876A: 1.5 GHz N2894A: 700 MHz ^a
Probe Risetime (10%-90%)	N2870A: 10 ns N2871A: 1.4 ns N2872A: 1.0 ns N2873A: 700 ps N2874A: 240 ps N2875A: 700 ps N2876A: 240 ps N2894A: 500 ps
Maximum Rated Input Voltage	N2870A: 30 Vrms mains isolated, 60 Vdc N2871A: 400 V mains isolated ^b , 300 V CAT II ^c N2872A: 400 V mains isolated ^b , 300 V CAT II ^c N2873A: 400 V mains isolated ^{b, d} , 300 V CAT II ^c N2874A: 8.5 V mains isolated ^e N2875A: 400 V mains isolated ^b , 300 V CAT II ^c N2876A: 21 V mains isolated ^e N2894A: 400 V mains isolated ^{b, f} , 300 V CAT II ^c

Description	Characteristic
Input Resistance (scope + probe)	N2870A: 1 M Ω N2871A: 10 M Ω N2872A: 10 M Ω N2873A: 10 M Ω N2874A: 500 Ω N2875A: 20 M Ω N2876A: 5 K Ω N2894A: 10 M Ω
Input Capacitance (system)	N2870A: 39 pF (+ scope) N2871A: 9.5 pF N2872A: 9.5 pF N2873A: 9.5 pF N2874A: 1.8 pF N2875A: 5.6 pF N2876A: 2.2 pF N2894A: 9.5 pF
Compensation Range	N2870A: – N2871A: 10 - 25 pF N2872A: 10 - 25 pF N2873A: 10 -25 pF N2874A: – N2875A: 7 - 20 pF N2876A: – N2894A: 10 - 25 pF
Input Coupling of the Measuring Instrument	N2870A: 1 M Ω N2871A: 1 M Ω N2872A: 1 M Ω N2873A: 1 M Ω N2874A: 50 Ω N2875A: 1 M Ω N2876A: 50 Ω N2894A: 1 M Ω
	a 700 MHz bandwidth available with InfiniiVision 4000X/6000X with 1 GHz or higher bandwidth models only b Maximum pulse rating = 1,650 V (step 0 V to 1,650 V), mains isolated, no overshoot permitted, connected to oscilloscope with an input impedance of 1 M Ω \pm 1%, not applicable with InfiniiVision 6000X, Infiniium S and 9000 Series c Measurement Category II d 300 V _{rms} , 400 V (DC + peak AC) mains isolated; 0 V transient overvoltage with Infiniium S and 9000 Series e Mains isolated, 0 V transient overvoltage f 300 V _{rms} , 400 V (DC + peak AC) mains isolated; 0 V transient overvoltage with InfiniiVision 6000X

Table 6 Mechanical Characteristics

Description	Characteristic
Weight (probe only)	48 g
Cable Length	1.3 m
Probe Barrel Diameter	2.5 mm

Table 7 Environmental Specifications

Description	Specification
Temperature	Operating: 0 °C to +50 °C Non-operating: -40 °C to +70 °C
Altitude	Operating: 2,000 m (6,561 ft) Non-operating: 15,000 m (49,212 ft)
Humidity	Operating: 80% room humidity for temperatures up to 31 °C, decreasing linearly to 40% at 50 °C Non-operating: 95% room humidity for temperatures up to 40 °C
Pollution Degree	Pollution Degree 2

Table 8 Safety Specifications

Specification
IEC 61010-031:2015

Typical Voltage Derating (Mains isolated circuits)

WARNING

The maximum input voltage rating of the probe decreases as the frequency of the applied signal increases.

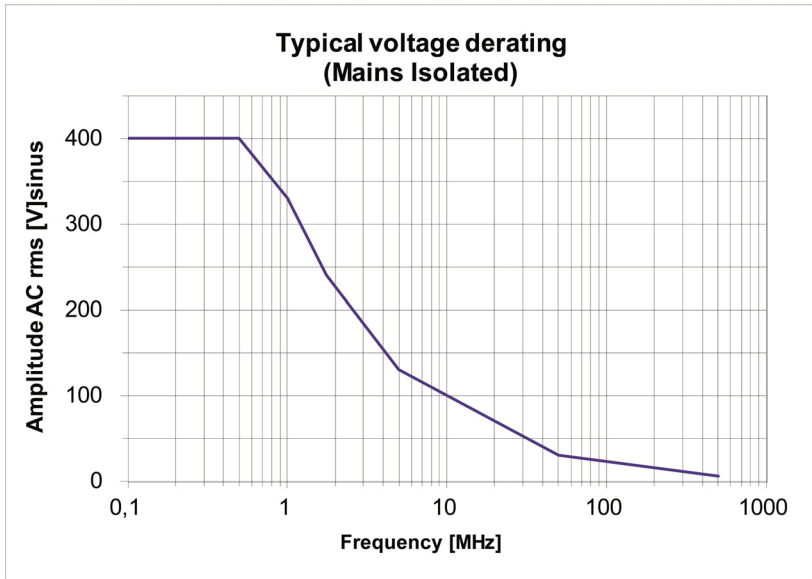

Figure 8 Typical Voltage Derating Plot (mains isolated)

CAUTION

Refer to the oscilloscope documentation for the oscilloscope's acceptable input range and do not exceed this limit when using the probes.

Typical Input Impedance (CAT II)

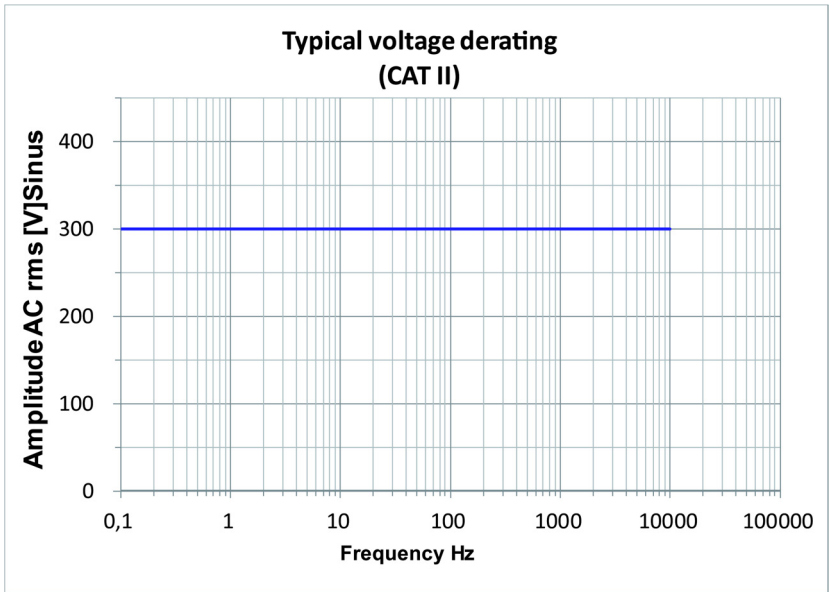

Figure 9 Typical Voltage Derating Plot (CAT II)

Typical Input Impedance

CAUTION

Refer to the oscilloscope documentation for the oscilloscope's acceptable input range and do not exceed this limit when using the probes.

CAUTION

The input impedance of the probe decreases as the frequency of the applied signal increases.

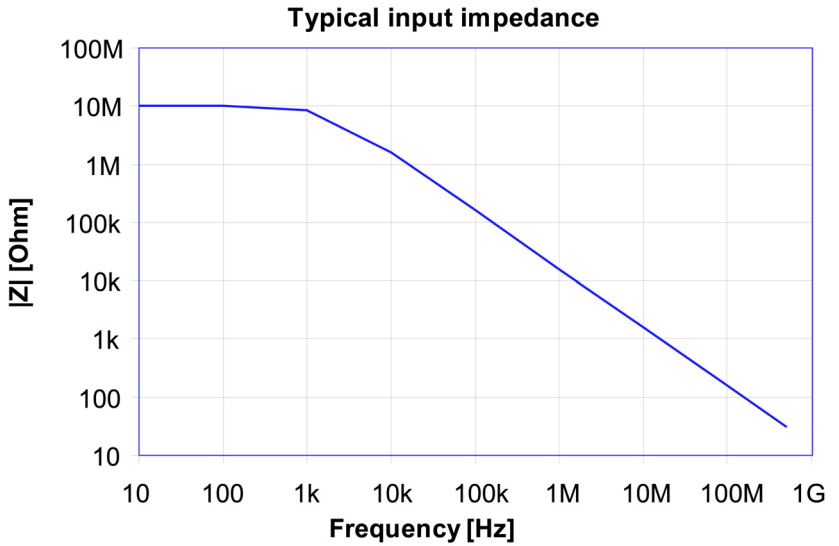

Figure 10 Typical Input Impedance

Performance Verification Procedures

The two procedures in this section are used to test and verify the DC attenuation ratio and the input resistance of the probes. The recommended test interval is once a year or as required. Use the equipment listed in [Table 9](#) to complete the procedures.

Table 9 Required Test Equipment

Description	Minimum Requirements	Part Number
Digital Multimeter (DMM)	6.5 digits of resolution, resistance $\pm 1\%$	Keysight 34401A
Calibrator	DC Voltage 0 to ± 1100 V	Fluke 5700A
BNC(m) to BNC(f) 50Ω feedthrough termination		Keysight 11048C
Modified deskew and performance verification kit, $1\text{ M}\Omega \pm 0.1\%$ precision shunt resistor is soldered between 50Ω trace and ground		Keysight E2655B
Oscilloscope	If testing N2870/1/2/3/4A or N2894A: $1\text{ M}\Omega$ input impedance If testing N2874/6A: 50Ω input impedance	Keysight 4000-X Series

Test DC Attenuation Ratio

- 1 Set the DMM (Keysight 34401A) to DC voltage measurement mode. Configure the input resistance to $> 10\text{ G}\Omega$. Short the tip and perform the “Null” function. Set the calibrator (Fluke 5700A) to 10V.
- 2 Connect the N287XA probe tip to the calibrator HI output.
- 3 Connect the N287XA probe ground lead to the calibrator LO output.
- 4 For models N2874A and N2876A, connect the probe output to the 50Ω feedthrough termination (11048C). Connect the output of the 11048C to the DMM. For all other models, connect the probe output to the modified Keysight PV fixture 50Ω trace input. The trace is terminated with the $1\text{ M}\Omega \pm 0.1\%$ precision resistor. Connect the output of the 50Ω trace to the DMM.

- 5 Verify that the measured value is between the limits listed in the table below for each output signal. If it is then the attenuation ratio has an error within $\pm 2\%$.

Table 10 Measurement Limits

Model	Target Value	Measured Value
N2870A	x1	10V \pm 200 mV
N2871A	x10	1V \pm 20 mV
N2872A	x10	1V \pm 20 mV
N2873A	x10	1V \pm 20 mV
N2874A	x10	1V \pm 20 mV
N2875A	x20	500 mV \pm 10 mV
N2876A	x100	100 mV \pm 2 mV
N2894A	x10	1V \pm 20 mV

Test Input Resistance

- 1 Turn on the DMM. Short the DMM probes and run the “Null” function.
- 2 Connect the DMM probes to the probe tip and the ground at the tip of the probe.
- 3 Connect the probe’s output to one of the oscilloscope’s input channels. Set the oscilloscope’s input impedance value according to the following table.

Table 11 Oscilloscope's Input Impedance

Model	Oscilloscope Input Impedance
N2870A	1 M Ω
N2871A	1 M Ω
N2872A	1 M Ω
N2873A	1 M Ω
N2874A	50 Ω
N2875A	1 M Ω
N2876A	50 Ω
N2894A	1 M Ω

- 4 Set up the DMM to measure resistance. Record the resistance into the Measured Value column in Table 12 on page 34. Calculate the Error%. It should be less than 1%.

$$\text{Error \%} = \frac{\text{Measured Value} - \text{Target Value}}{\text{Target Value}} \times 100$$

Table 12 DMM Measurements

Model	Target Value	Measured Value	Error%
N2870A	1 M Ω		
N2871A	10 M Ω		
N2872A	10 M Ω		
N2873A	10 M Ω		
N2874A	500 Ω		
N2875A	20 M Ω		
N2876A	5 k Ω		
N2894A	10 M Ω		

Performance Verification Test Record

Keysight Technologies

N287XA/N2894A Passive Probe

Serial No.: _____

Test Date: _____

Tested By: _____

Recommended Test Interval: 1 Year

Recommended Date of Next Test: _____

Test Temperature: _____

Test	Probe Model	Limits	Results
Attenuation Ratio	N2870A	10V \pm 200 mV	
	N2871A	1V \pm 20 mV	
	N2872A	1V \pm 20 mV	
	N2873A	1V \pm 20 mV	
	N2874A	1V \pm 20 mV	
	N2875A	500 mV \pm 10 mV	
	N2876A	100 mV \pm 2 mV	
	N2894A	1V \pm 20 mV	
Input Resistance		Error% < \pm 1%	

IEC Measurement Category Definitions

Definitions and Examples (Clause 6.5.2).

Mains Isolated Circuits

Mains isolated is for measurements performed on circuits not directly connected to a mains supply.

Example

Measurements in circuits not derived from a mains supply and specially protected (internal) circuits derived from a mains supply. In the latter case, transient stresses are variable. For that reason, it is required that the transient withstand capability of the equipment is made known to the user.

Measurement Category II (CAT II)

Measurement category II is for measurements performed on circuits directly connected to the low voltage installation.

Example

Household appliances, portable tools, and similar equipment.

Measurement Category III (CAT III)

Measurement category III is for measurements performed in the building installation.

Example

Measurements on distribution boards, circuit breakers, wiring including cables, bus-bars, junction boxes, switches, socket-outlets in the fixed installation and equipment for industrial use like, for example, stationary motors with permanent connections to the fixed installation.

Measurement Category IV (CAT IV)

Measurement category IV is for measurements performed at the source of the low-voltage installation.

Example

Electricity meters and measurements on primary over-current protection devices and ripple control units.

IEC Pollution Degrees Definitions

Definitions (Clause 3.5.6).

Pollution Degree 1

No POLLUTION or only dry, non-conductive POLLUTION. NOTE: The POLLUTION has no influence.

Pollution Degree 2

Only non-conductive POLLUTION. Occasionally, however, a temporary conductivity caused by condensation must be accepted.

Pollution Degree 3

Conductive POLLUTION occurs or dry, non-conductive POLLUTION occurs which becomes conductive due to condensation which is to be expected.

