

User's Guide (Unabridged)

Keysight A-Series FieldFox Analyzers

This manual provides documentation for the following models:

N9913A, N9914A, N9915A, N9916A, N9917A, N9918A N9925A,
N9926A, N9927A, N9928A
N9935A, N9936A, N9937A, N9938A
N9950A, N9951A, N9952A
N9960A, N9961A, N9962A

This is the unabridged version of the abridged N9927-90001 User's Guide that is available as printed format. The abridged User's Guide can be found here:

<https://www.keysight.com/us/en/assets/9018-03771/user-manuals/9018-03771.pdf>

Notices

© Keysight Technologies, Inc.
2014-2022

No part of this manual may be reproduced in any form or by any means (including electronic storage and retrieval or translation into a foreign language) without prior agreement and written consent from Keysight Technologies, Inc. as governed by United States and international copyright laws.

Trademark Acknowledgments

Bluetooth®

Manual Part Number

N9927-90020

Edition

Edition 1, February 2022

Printed in USA/Malaysia

Published by:
Keysight Technologies
1400 Fountaingrove Parkway
Santa Rosa, CA 95403

Warranty

THE MATERIAL CONTAINED IN THIS DOCUMENT IS PROVIDED "AS IS," AND IS SUBJECT TO BEING CHANGED, WITHOUT NOTICE, IN FUTURE EDITIONS. FURTHER, TO THE MAXIMUM EXTENT PERMITTED BY APPLICABLE LAW, KEYSIGHT DISCLAIMS ALL WARRANTIES, EITHER EXPRESS OR IMPLIED WITH REGARD TO THIS MANUAL AND ANY INFORMATION CONTAINED HEREIN, INCLUDING BUT NOT LIMITED TO THE IMPLIED WARRANTIES OF MERCHANTABILITY AND FITNESS FOR A PARTICULAR PURPOSE. KEYSIGHT SHALL NOT BE LIABLE FOR ERRORS OR FOR INCIDENTAL OR CONSEQUENTIAL DAMAGES IN CONNECTION WITH THE FURNISHING, USE, OR PERFORMANCE OF THIS DOCUMENT OR ANY INFORMATION CONTAINED HEREIN. SHOULD KEYSIGHT AND THE USER HAVE A SEPARATE WRITTEN AGREEMENT WITH WARRANTY TERMS COVERING THE MATERIAL IN THIS

DOCUMENT THAT CONFLICT WITH THESE TERMS, THE WARRANTY TERMS IN THE SEPARATE AGREEMENT WILL CONTROL.

Technology Licenses

The hardware and/or software described in this document are furnished under a license and may be used or copied only in accordance with the terms of such license.

U.S. Government Rights

The Software is "commercial computer software," as defined by Federal Acquisition Regulation ("FAR") 2.101. Pursuant to FAR 12.212 and 27.405-3 and Department of Defense FAR Supplement ("DFARS") 227.7202, the U.S. government acquires commercial computer software under the same terms by which the software is customarily provided to the public. Accordingly, Keysight provides the Software to U.S. government customers under its standard commercial license, which is embodied in its End User License Agreement (EULA), a copy of which can be found at

<http://www.keysight.com/find/sweula>. The license set forth in the EULA represents the exclusive authority by which the U.S. government may use, modify, distribute, or disclose the Software. The EULA and the license set forth therein, does not require or permit, among other things, that Keysight: (1) Furnish technical information related to commercial computer software or commercial computer software documentation that is not customarily provided to the public; or (2) Relinquish to, or otherwise provide, the government rights in excess of these rights customarily provided to the public to use, modify, reproduce, release, perform, display, or disclose commercial computer software or commercial computer software documentation. No additional government requirements beyond those set forth in the EULA shall apply, except to the extent that those terms, rights, or licenses are explicitly required from all providers of commercial computer software pursuant to the FAR and the DFARS and are set forth specifically in

writing elsewhere in the EULA. Keysight shall be under no obligation to update, revise or otherwise modify the Software. With respect to any technical data as defined by FAR 2.101, pursuant to FAR 12.211 and 27.404.2 and DFARS 227.7102, the U.S. government acquires no greater than Limited Rights as defined in FAR 27.401 or DFAR 227.7103-5 (c), as applicable in any technical data.

Safety Notices

CAUTION

A **CAUTION** notice denotes a hazard. It calls attention to an operating procedure, practice, or the like that, if not correctly performed or adhered to, could result in damage to the product or loss of important data. Do not proceed beyond a CAUTION notice until the indicated conditions are fully understood and met.

WARNING

A **WARNING** notice denotes a hazard. It calls attention to an operating procedure, practice, or the like that, if not correctly performed or adhered to, could result in personal injury or death. Do not proceed beyond a WARNING notice until the indicated conditions are fully understood and met.

NOTE

A **NOTE** calls the user's attention to an important point or special information in the text.

Where to Find the Latest Information

Documentation is updated periodically. For the latest information about these products, including instrument software upgrades, application information, and product information, browse to one of the following URLs, according to the name of your product:

<https://www.keysight.com/find/fieldfox>

To receive the latest updates by email, subscribe to Keysight Email Updates at the following URL:

<https://www.keysight.com/find/MyKeysight>

Information on preventing instrument damage can be found at:

<https://www.keysight.com/find/PreventingInstrumentRepair>

Is your product software up-to-date?

Periodically, Keysight releases software updates to fix known defects and incorporate product enhancements. To search for software updates for your product, go to the Keysight Technical Support website at:

<https://www.keysight.com/find/fieldfoxsupport>

A.08.19 Firmware Release (CPU1) Updates (N991xA/2xA/3xA with serial number prefixes <5607)

For customers upgrading FieldFox firmware, the following is a list of changes from the previous release:

Other updates:

- Fix to FAB USB access

A.12.3x and A.12.4x Firmware Release (CPU2) Updates (Also, applies to: N991xA/2xA/3xA units with serial number prefixes $\geq 5607^1$)

For customers upgrading FieldFox firmware, the following is a list of changes from the previous release:

- Added: EMI (Electromagnetic Interference) – Option 361 Measurement mode
 - CISPR (International Special Committee on Radio Interference) and Amplitude Probability
 - Improved: EMI log limit lines (display process)
- GPS feature – Improved: GPS with more robust time-proxy syncing
- NA mode – Added: Apply Nearest feature
- SA mode – Added:
 - IQ Streaming (Option 353)
 - EMI Electromagnetic Interference (Option 361)
 - EIRP (Effective Isotropic Radiated Power)
 - Analog Demodulation Metrics
 - Measure Setup menu for General or IQ Streaming analysis
 - Improved: Record/Playback *.CSV file saving process
- Mapping functionality – Added: Directional Bearing

1. Country codes have been omitted from serial number prefixes.

Contacting Keysight

Assistance with test and measurements needs and information on finding a local Keysight office are available on the Web at: <http://www.keysight.com/find/assist>.

If you do not have access to the Internet, please contact your Keysight field engineer.

In any correspondence or telephone conversation, refer to the Keysight product by its model number and full serial number. With this information, the Keysight representative can determine whether your product is still within its warranty period.

To contact Keysight for sales and technical support, refer to support links on the following Keysight websites: <http://www.keysight.com/find/support> (product specific information and support, software and documentation updates) <http://www.keysight.com/find/assist> (worldwide contact information for repair and service).

Contents

1. Overview

Models and Options	33
Accessories	34
Optional Accessories	34
FieldFox Manuals, Software, and Supplemental Help	35
Conventions that are used in the Manual	35
Safety Notes	35

2. Preparing for Initial Use of Your New FieldFox

Check the Shipment	37
Meeting Power Requirements for the AC/DC Adapter	37
Install the Lithium-Ion Battery	38
Battery Usage	38
Battery charge status is viewable:	38
To conserve battery power:	39
To recharge a battery:	39
FieldFox ON/OFF Settings	39
Power Button LED Status	40
FieldFox High Temperature Protection	40
How to monitor the internal FieldFox temperature:	40
Temperature Control Mode	41
Entering Temperature Control Mode	41
Exiting Maximum Auto Protect Threshold Temperature Mode	42
High-Temp Shutdown Warning (RTSA Mode Only)	43
Summary of FieldFox Average Internal Temperature Protection Behavior	44
Avoid Overpowering the FieldFox	44
Take the FieldFox Tour	45
Front Panel	45
Top Panel	48
Right Side Panel	49
Left Side Panel	50
Screen Tour	51
How to Enter Numeric Values	53
Multiplier Abbreviations	53
Connector Care	54

3. CAT (Cable and Antenna Test) Mode

CAT Mode Settings	57
How to select CAT Mode	57

Measurement Selection	57
How to select a CAT Mode Measurement.	57
Quick Settings Table	58
How to view and change Quick Settings	58
Frequency Range.	59
How to set Frequency Range	59
Scale Settings	59
How to set Scale	59
Averaging.	60
How to set Trace Averaging	61
Smoothing	61
Single or Continuous Measure	61
How to set Single or Continuous	61
Resolution (Number of Data Points)	62
How to set Resolution.	62
Sweep Time	62
How to set Sweep Time	62
Output Power.	63
How to set Output Power	63
Interference Rejection	64
How to set Interference Rejection.	64
Coupled Frequency	64
How to set Coupled Frequency.	64
Return Loss Measurements	66
How to Measure Return Loss	66
1-Port Cable Loss Measurements	66
How to make a 1-port Cable Loss Measurement.	67
2-Port Insertion Loss Measurements	68
4. DTF (Distance to Fault) Measurements	
How to make DTF Measurements	72
DTF Measurement Settings	74
DTF Settings Table.	74
How to make settings on the DTF settings table	74
DTF Measurement (Format)	74
DTF Start and Stop Distance.	75
How to set Start and Stop Distance	75
Frequency Mode	75
How to set Frequency Mode	75
Coupled Frequency	76
Cable (Correction) Specifications	77
About Velocity Factor and Cable Loss	77
How to enter Cable Loss and Velocity Factor.	77

How to Edit a Cable File	78
How to Save or Recall a Cable.	79
How the Freq/Loss pairs are applied.	79
Window Settings	80
How to select Window settings.	80
DTF Units	81
How to change DTF units.	81
Calculated DTF values	81
About Alias Faults.	81
5. TDR (Time Domain Reflectometry) - Option 215	
TDR Measurement Settings	86
TDR Measurement (Format).	86
TDR Settings Table	86
How to make settings on the TDR settings table	86
TDR Start and Stop Distance.	87
How to set Start and Stop Distance	87
TDR Sweep.	87
Frequency Mode	88
How to set Frequency Mode	88
Cable (Correction) Specifications.	89
How to Save or Recall a Cable.	91
About Cable files	91
How the Freq/Loss pairs are applied.	91
Window Settings	92
How to select Window settings.	92
Network Analyzer Windows Frequency Span and TDR Window Selection for Step Rise Time (Approximated)	93
TDR Units	93
How to change TDR units	93
Calculated TDR values	93
About Alias Faults.	94
How to Prevent Undersampling.	95
6. NA (Network Analyzer) Mode	
NA Mode Settings.	99
About S-parameters.	99
How to measure S-parameters	100
Mixed-Mode S-Parameters	100
How to make mixed-mode S-parameter measurements	101
Parameter Conversion	101
Receiver Measurements.	102
How to make receiver measurements	102
Multi-Trace Configurations	103

Trace Setting Notes	103
How to select a multi-trace configuration	104
How to activate a trace in order to change a setting	104
How to maximize the viewing of the active trace	104
Quick Settings	104
Calibration Settings	105
Format	106
Frequency Range	107
How to set Frequency Range	107
Scale Settings	107
Magnitude Offset	108
Electrical Delay	109
Phase Offset	109
Averaging	110
IF Bandwidth	111
Smoothing	111
How to set Smoothing	111
Single or Continuous Measure	112
How to set Single or Continuous	112
Resolution (Number of Data Points)	112
Sweep Time	113
Triggering	113
Output Power	115
How to set Output Power	115
System Impedance (Z0)	116
Port Extensions	116
Why use Port Extensions	116
How to apply Port Extensions	117
Velocity Factor	117
Big Marker Display States (A and B)	118
Notes:	119
Increase Dynamic Range	120

7. Time Domain – Option 010

Overview	123
Time Domain (Transform) Settings	124
Transform Settings Table	124
Start/Stop (Frequency Range) and Points	124
Stimulus (Mode)	125
Set Frequency Lowpass	125
Start/Stop Time	125
Distance Units	126
Window Layout	126

Transform Window	126
How to make Window setting	127
Line Loss and Velocity Factor	127
About Velocity Factor and Line Loss	128
Data Chain	128
Trace Settings	129
Transform Enable	129
Gate Enable	129
Gating	130
How to make Time Domain Gating settings	131
Start, Stop, Center, and Span Gate Times	131
Gating Type	131
Gating Shape	132

8. Calibration for NA, CAT, and VVM Modes

.	134
Why and When to Calibrate	134
Definitions	134
CalReady	135
How to Perform a Calibration	135
QuickCal (N991xA/2xA/3xA Only)	137
Mechanical Cal	140
ECal	142
Simple Response Cals	145
View Cal	147
Calibration Type	147
Isolation Step	150
How to perform the Isolation step	150
Waveguide Calibrations	150
Enhanced Response Optimization	152
Interpolation *	153
Cal ON? – Questionable Accuracy	153
Compatible Mode Calibrations	153
Save the Calibration	153
CalReady Properties	154
Apply Nearest (NA Mode Only)	155
Verifying Calibration and Jumper Cable Integrity	155
Verify a Calibration	155
Test the Jumper Cable	156
Calibration Method Summary	157

9. SA (Spectrum Analyzer) Mode (Option 233–Mixed Analyzers)

SA Mode Settings	163
How to select SA Mode	163
Frequency Range	163
How to set Frequency Range	163
Two more ways to change the frequency range	164
How to change frequency step size	164
Radio Standard	165
How to select a Radio Standard	165
Custom Radio Standards	165
How to Import and Delete a Custom Radio Standard	165
Channel Selection	166
How to Enable Channel selection	166
How to change the Channel Number of the Measurement	166
Channel number X-axis annotation	167
Change Channel Step Size (Optional)	167
Reverse Swap	168
Scale and Units	168
How to set Scale	168
Manually set Scale Type, acquisition, and Reference Position	168
How to Set Y-axis Units	169
External Gain	169
How to Set External Gain	169
Attenuation Control	170
How to set Attenuation	170
Preamplifier Control (Opt 235)	171
How to control the Preamp	171
Check for Compressed Measurements	171
How to Check for a Compressed Measurement	171
Field Strength Measurements	172
How to select and edit corrections for Field Strength measurements	172
Selecting and Viewing Corrections	173
How to Use the Antenna Softkeys	173
Using the Antenna/Cable Editor	174
How to use the Antenna/Cable Editor	174
How to create a Cable file from an S21 (NA mode) or an Insertion Loss (CAT mode) measurement	176
Source Tracking Offset and Offset Reversal	176
How to set Tracking Offset and Offset Reversal	177
Tune & Listen (AM/FM)	177
How to select Tune & Listen	178
TnL AM SSB Gain	179
Tune Frequency	179
Listen Time	180
To select Listen Time:	180
Volume Control	180
Audio Demod ON and OFF	181

Setting the Marker Counter Precision Softkey	181
Setting the Mkr->TuneFreq Softkey.....	181
Analog Demod (Requires CPU2)	181
How to select Analog Demod (Metrics).....	183
How to make Analog Demodulation (Metrics) Settings	184
Setting the Alternate Frequency (AF) Freq/Dist Softkeys.....	185
Setting the Alternate Frequency (AF) RBW Softkey	185
Setting the Audio Capture Playback Softkeys.....	186
How to Set the Demod Filters	187
Setting the Marker Counter Gate Softkey	189
Independent Source/Tracking Generator	193
How to make Independent Source Settings	193
Resolution Bandwidth (Res BW)	194
How to set Res BW	194
Video Bandwidth (Video BW).....	195
How to set VBW	195
AF RBW (Audio-Frequency Resolution BW)	196
How to set AF RBW	196
Sweep Type.....	196
How to set Sweep Type	196
Oversweep	197
IF Output.....	197
Sweep Acquisition	199
How to set Sweep Acquisition	199
Very Long Sweep Times	200
Zero Span Measurements	200
How to set Zero Span.....	201
How to change Sweep Time in Zero Span.....	201
Triggering	202
Trigger Type	202
Sync	203
Trigger Slope	203
Trigger Delay	203
Period	204
Offset	204
Trigger Level.....	204
Auto Trigger Time.....	205
Trigger Position	205
Trigger Settings Annotation.....	206
FFT Gating (Opt 238)	206
How to set FFT Gating	207
Single / Continuous / Restart	208
How to set Single or Continuous.....	208
Points	208
How to set number of points	208
Trace Display States (SA Mode).....	208

How to display the Trace States	209
Average Type	209
How to set Average Type.	210
Average Count.	210
How to set Average Count	210
Alignments.	211
Overview	211
All Alignment and Align All Now.	213
Individual Alignments	214
Detection Method	218
How to set Detection Method.	219
Display Line	220
How to create and move a Display Line	220
Noise Marker	221
How to measure Noise with a marker	221
Band/Interval Power Marker	221
How to measure Band/Interval Power with a marker	222
Frequency Counter at Marker	222
How to use Frequency Counter	223
Time Zero Fixed Marker.	223
Audio Beep at Marker Power.	223
How to use Audio Beep.	224
Meas UNCAL Error	224
Old Data Indicator (*).	224
Channel Measurements.	225
Radio Standards and Channel Measurements	225
Measurement Preset	225
How to select Measurement Preset:	225
Averaging.	225
Traces.	226
Channel Power (CHP)	226
How to select Channel Power.	227
Integration Bandwidth.	227
Other Channel Power Settings	228
Occupied Bandwidth.	228
Adjacent Channel Power Ratio (ACPR).	230
RRC Weighting	234
How to Set Up EMF Settings (Requires EMF (Option 358), GPS (Option 307), and SA Mode (Option 233–Mixed Analyzers))	236
EMF Features.	237
EMF has the following features:	237
EMF Setup Procedure	239
Editing Antenna Correction Factors and Adding New Antenna Factors	243
Editing Cable Correction Factors and Adding New Cable Factors	245

Spectrum Emission Mask (SEM) – (Requires CPU2, SA Mode Only)	248
How to select Spectrum Emission Mask (SEM) Measurement	250
IQ Analysis (Requires Option 351 IQ Analyzer and Option 353 IQ Streaming, SA Mode Only)	255
How to Select IQ Analysis	255
How to Setup IQ Analysis General	256
How to Setup IQ Analysis Streaming	256
Effective Isotropic Radiated Power (EIRP) – (Requires CPU2, SA Mode Only)	258
How to Select Effective Isotropic Radiated Power (EIRP)	258
How to Setup EIRP (Effective Isotropic Radiated Power)	258

10. RTSA (Real-Time Spectrum Analyzer) Mode—Option 350 (CPU2 Only)

RTSA Mode Settings.	263
How to select RTSA Mode	263
Frequency Range	263
How to set Frequency Range	264
Scale and Units	264
How to set Scale	265
Manually set Scale, acquisition, and Reference Position	265
External Gain	265
How to Set External Gain	265
Attenuation Control	266
How to set Attenuation	266
Preamplifier Control (Opt 235)	267
How to control the Preamp	267
Check for Compressed Measurements	267
How to Check for a Compressed Measurement	267
Spectrum Selection	268
How to make Spectrum Settings	268
Resolution Bandwidth (Res BW)	271
How to set Res BW	271
Triggering	272
Trigger Type	272
Trigger Slope	273
Trigger Delay	273
Trigger Level	274
Auto Trigger Time	274
Trigger Hold-Off	275
Trigger Settings Annotation	275
Single / Continuous / Restart / Time Per Div	275
How to set Single or Continuous	276
Acq Time	276
How to set Acq Time	276
Points (not user settable)	276

Trace Display States (RTSA)	277
How to display the Trace States	277
Detection Method	278
How to set Detection Method	278
Average Count, Show Density, Blue, and Red Percentage Limits	279
Average Count	280
Alignments	280
Display Line	280
How to create and move a Display Line	281
Spectrogram Display	282
Spectrogram Display (RTSA Option)	282
How to select Spectrogram	282
How to modify the Spectrogram	282
Common Settings for Spectrogram	283
Set Red and Blue Limits	283
How to Restart the Spectrogram	283
Record/Playback (RTSA Option)	284
About Sessions	284
How long can a recording session last?	284
To view and edit the maximum number of records.	285
FieldFox Setting Changes during Record and Playback	285
During Recording	285
During Playback	286
Record/Playback Exceptions.	286
About State and User Tags	286
Screen Annotation	287
How to Record a Session	287
How to Playback a Session	288
Recording Configuration	289
Record Source	290
RTSA Data Recording:	290
Playback Configuration	291
Manage Sessions.	291
Record Playback Example (RTSA Mode Only)	292
11. IQ Analyzer (IQA) – Option 351 (CPU2 Only)	
About I/Q Analyzer (IQA) Measurements	296
I/Q Analyzer (IQA) Mode Settings	297
How to Make Measurements Using the I/Q Analyzer Mode	297
How to Capture I/Q Data to a File	298
How to modify the I/Q data measurement parameters	301
Adjusting the Bandwidth Settings	301
Changing between the Continuous and Single captures and adjusting the Trigger settings	303

Adjusting the Measurement Setup Settings	306
Adjusting the Trace Settings	306
Adjusting the Frequency Settings	308
Adjusting the Scale and Amplitude Settings.	308
Preamplifier Control (Opt 235).	310
Using Markers (IQA)	312
Noise Marker	312
How to measure Noise with a marker	313
Band/Interval Power Marker	313
How to measure Band/Interval Power with a marker	313
Band Span Marker (Spectrum Only)	314
How to measure with the Band Span marker	314
Interval Span Marker (Waveform Only)	314
How to measure with the Interval Span marker	314
Coupled Markers (Waveform Only)	314
How to measure with the Coupled marker	314
Continuous Peak Search Marker	316
How to measure with the Continuous Peak Search marker	316
Alignments	317
Trace Display States (IQA Mode)	317
How to display the Trace States	317
Other Features Available	319

12. Electromagnetic Interference (EMI) Measurements – Option 361

Using EMI Measurements (Option 361)	325
EMI Measurements Mode Settings	326
How to select EMI Measurements Mode	326
Frequency Range	326
How to set Frequency Range and Frequency Context	327
Scale and Units	328
External Gain	328
Attenuation Control	329
CISPR (International Special Committee on Radio Interference) Control.	329
How to Set the EMI Measurement Settings (Fast SA Scan, CISPR Band Scan, CISPR Zoom Scan, and APD Statistics)	329
How to set a CISPR Band	331
Preamplifier Control (Opt 235).	334
Resolution Bandwidth (Res BW)	334
.	335
Single / Continuous / Restart	335
How to set Single or Continuous.	335
Points	336
Trace Display States (EMI Mode)	336

How to display the Trace States	336
How to set the EMI Traces	336
Measure 1 Hardkey – EMI ‘Convenience’ Softkeys.	337
Trace Averaging	337
Alignments	337
Detection Method	338
How to set Detection Method.	338
Input – (Trace Input for APD Measurements).	339
About Electromagnetic Interference (EMI) Measurements.	340
EMI Measurement Features (Option 361).	341
EMI has the following features:.	341
How to Set Up Electromagnetic Interference (EMI) Mode Settings.	343
EMI Measurement Mode Setup Procedure.	343
Glossary (EMI)	344

13. Over-the-Air Measurements (OTA) – LTE FDD Option 370, LTE TDD Option 371, 5GTF Option 377 (CPU2 Only)

Using OTA (Options 370 – LTE FDD, 372 – TDD, and 377 – 5GTF)	347
About Over-the-Air (OTA) Measurements	348
LTE FDD and LTE TDD Features (Option 370 and Option 371)	348
LTE FDD and LTE TDD have the following features:.	348
5G TF Features (Option 377)	352
5G TF has the following features:	352
How to Set Up Over-the-Air (OTA) Mode Settings	354
OTA Setup Procedure	354
Additional LTE FDD Examples (LTE TDD is Similar)	365
Optional: Using RTSA to verify the signal quality (Requires Option 350 and Preamp Option 235)	367
How to Define a Cell or Cell(s) and Use OTA	368
Step 1: LTE FDD (Option 370), LTE TDD (Option 371), and 5GTF (Option 377):	
Component Carrier (CC) and Cell Defined	368
Step 2: Select Trace Type	371
Step 3. Modify Scale and the Display Color Bar Settings	373
Step 4: Enable Data Logging and Playback the Results	374
Save 5: Save the Log Results:.	377
Step 6: Import and Play back KML Files into 3rd Party Software (Example: Google Earth with Animation Tool)	378
How to Set Up EMF Settings (Requires EMF (Option 358))	380
EMF Features.	380
EMF has the following features:	380
EMF Setup Procedure	383
How to Use Data Logging (OTA Options 370, 372, and 377)	387
Screen Annotation	387

How to Record a Data Log Procedure	388
To change Data Logging Configuration settings:	388
How to Play a Data Log	390
Other Features Available	391
Troubleshooting	392
Glossary (OTA).	393
14. 5G Rapid Prototype Phased Array Antenna – Option 360	
Using the Phased Array Antenna (Option 360)	397
About Phased Array Antenna Measurements	398
Phased Array Antenna Features (Option 360)	398
Phased array antenna has the following features:	398
How to Set Up Phased Array Antenna Settings	407
Option 360 Setup Procedure	407
.	418
How to Define a Set Up a Scan and Use Option 360	419
Step 1. Connect Your Equipment.	419
Step 2. Set FieldFox to Use Static IP with Your Ball Antenna.	419
Step 3. Define the measurement.	420
Step 4: Select Polar Settings	422
Step 5. Modify Scale and Attenuator Settings	422
Step 6: Enable Data Logging and Playback the Results.	423
Step 7: Import and Play back KML Files into 3rd Party Software (Example: Google Earth with Animation Tool).	426
How to Use Data Logging/Playback (Option 360)	428
Screen Annotation	428
How to Record a Data Log	430
To change Data Logging Configuration settings:	430
How to Play a Data Log	431
Using Mapping	432
Other Features Available	432
Troubleshooting	433
15. USB Antennas – (Full Capability Requires EMF Option 358, and SA mode (Option 233 Mixed Analyzers))	
Using USB Antennas	438
About USB Antenna Measurements.	439
USB Antenna Features	439
USB antenna feature has the following features:	439
How to Set Up a USB Antenna	441
USB Antenna Setup Procedure	441
Editing Antenna Correction Factors and Adding New Antenna Factors	444

Other Features Available	445
Troubleshooting	446
16. Indoor and Outdoor Mapping – Option 352 (Requires Spectrum Analyzer Mode (Option 233 on N991xA), and GPS Receiver (Option 307))	
How to Install Node.js and Running the FieldFox Mapping Software	452
Downloading and Using the FieldFox Map Support Tool	454
Importing a .zip File to the FieldFox	458
How to Set Up Mapping Settings	460
How to Set Up Mapping When the FieldFox Is On The LAN	461
Display a Map File	461
Option 352 Indoor Maps Setup Procedure	463
Option 352 Outdoor Maps Setup Procedure	467
Import and Play back KML Files into 3rd Party Software (Example: Google Earth with Animation Tool)	473
Setting up Data Logging	475
Enabling Outdoor Map Logging	475
Enabling and Setting Up Indoor Map Logging	478
Outdoor Mapping Only: Export KML File Into 3rd Party Mapping Software	482
How to Use Data Logging (Option 352)	483
Screen Annotation	483
How to Add Directional Finding (DF) Bearing.	485
How to Record a Data Log (Outdoor Logging Only).	488
To change Data Logging Configuration settings:	489
How to Play a Data Log.	489
Update Available Message	491
Troubleshooting	491
General Troubleshooting	493
Port 5000 in Use Error.	493
Miscellaneous Mapping Errors	495
17. Remote Server Mode (Requires CPU2 and SA Hardware/SA Option 233)	
In this Chapter:	499
Connecting Using Remote Server	500
Changing Frequency Converter Head Settings	501
89600 VSA Software Overview (Requires CPU2 and N991xA/3x/A5x/A6xA and SA Option 233)	502
18. Interference Analyzer (SA Mode) – Option 236	
Spectrogram and Waterfall Displays.	506
Spectrogram Display (SA Option)	506
How to select Spectrogram	507

How to modify the Spectrogram	507
How to create Time Markers (SA Only)	507
Common Settings for Waterfall and Spectrogram	508
Set Red and Blue Limits.	508
How to Restart the Spectrogram/Waterfall	508
Averaging	509
Waterfall Display	509
Waterfall Angle.	509
Record/Playback (SA Option).	510
About Sessions.	510
How long can a recording session last?	510
To view and edit the maximum number of records	511
FieldFox Setting Changes during Record and Playback	511
During Recording	511
During Playback	512
Record/Playback Exceptions	512
About State and User Tags	512
Screen Annotation	513
How to Record a Session	513
How to Playback a Session	514
Recording Configuration	515
Frequency Mask Trigger Configuration (SA Mode Only)	516
Record Source	517
SA Data Recording:	518
Playback Configuration	518
Manage Sessions	519
Record Playback Example (SA Only)	520

19. Reflection Mode (SA Models) - Option 320

Reflection Mode Settings	524
How to select Reflection Mode	524
Measurement Selection	524
How to select a Reflection Mode Measurement	524
Normalize	524
How to perform Normalization	524

20. Built-in Power Meter Mode – Option 310

Built-in Power Meter Settings	529
How to select Built-in Power Meter Mode.	529
Frequency/ Span / Step	529
How to enter center frequency, step size, and span	529
Radio Standard.	530
Attenuation.	530
How to set Attenuation	530

21. Power Meter (USB/LAN) Mode - Option 302

.....	533
Supported Power Sensors.....	533
How to Connect a USB Power Sensor.....	533
How to Connect a LAN Power Sensor.....	534
LAN Sensor Settings.....	534
USB and LAN Power Meter Settings.....	536
How to select Power Meter Mode.....	536
How to select a Sensor Type.....	536
Average / Peak.....	536
Zeroing.....	537
How to perform External Zeroing.....	537
Frequency.....	537
How to enter Frequency of the Power Measurement.....	537
Source Control.....	538
How to Set Source Control and Power Level.....	538
Scale.....	539
Source Power Measurements.....	539
How to make a Source Power Measurement.....	539
Relative and Offset Power Measurements.....	540
How to set Relative and Offset Power Measurements.....	540
Display Units.....	540
How to set Power Meter display units.....	540
Resolution.....	541
How to set Resolution.....	541
Averaging.....	541
How to set Power Meter Averaging.....	541
Single or Continuous Measure.....	541
How to set Single or Continuous.....	542
Step Detection Mode.....	542
How to set Step Detection mode.....	542
Limits.....	542
How to set Limits.....	542
Troubleshooting.....	544
LAN Sensors.....	544
If the FieldFox LAN is removed during the use of the LAN sensor, the following steps can be taken to re-establish control of the Sensor:.....	544
If the Sensor LAN is removed during the use of the LAN sensor, the following steps can be taken to re-establish control over the measurement:.....	544

22. Frequency Offset Using Power Sensor (FOPS) – Option 208

Overview.....	549
FOPS Settings.....	551

How to select Power Meter (USB Sensor)	551
Measurement Selection	551
Sweep Type and Frequency	552
How to set Sweep Type and Frequency	552
Power Sensor Settling	554
How to choose Power Sensor settling	554
Sweep Settings	554
How to make additional sweep settings	554
Amplitude Markers	555
How to make Amplitude Marker settings	555
Trace Math	555

23. Pulse Measurements Mode – Option 330

Supported Power Sensors	559
Switching between Pulse Measurement Mode and Power Meter Mode	559
How to Connect the USB Power Sensor	560
How to Connect the LAN Power Sensor	560
LAN Sensor Settings	561
Pulse Measurement Settings	563
How to select Pulse Measurement Mode	563
Measurement Selection	563
How to select the Measurement	563
Frequency / Time	563
How to set Frequency	563
How to set Time	564
Zoom Window	564
How to make Zoom Window settings	564
Scale	565
How to set Scale for Trace Graph measurements	565
Averaging	565
How to set Averaging	566
Video Bandwidth	566
How to set Video Bandwidth	566
Single or Continuous Measure	566
How to set Single or Continuous	567
Resolution	567
How to set Resolution	567
Triggering	567
How to make Trigger settings	567
Marker Settings	570
Amplitude Markers	571
How to make Amplitude Marker settings	571
Marker Search	571
How to Search with Markers	571

Auto Analysis	572
How to enable Auto Analysis	573
Pulse Top	573
How to set Pulse Top	573
Grid	573
How to enable Grid display	573
Trace Memory	574
How to display data and memory traces	574

24. VVM (Vector Voltmeter) Mode - Option 308

Overview	577
VVM Mode Settings	578
How to select VVM Mode	578
Measurement Selection	578
How to select a VVM Measurement	578
Frequency Selection	578
How to set Frequency	578
Display Resolution	578
How to set Resolution	579
IF Bandwidth	579
How to set IF BW	579
Output Power	579
How to set Output Power	580
Averaging	580
How to set Averaging	580
Single or Continuous Measure	581
How to set Single or Continuous	581
VVM Calibration	581
Zeroing	581
How to select Zeroing	582
1-Port Cable Trimming Measurements	583
How to make a 1-Port Cable Trimming Measurement	583
2-Port Transmission Measurements	585
How to make a 2-Port Transmission Measurement	585
A/B and B/A Measurements	587

25. ERTA (Extended Range Transmission Analysis) Mode - Option 209

Overview	590
Requirements and Limitations	591
Requirements	591
Limitations	591
Start Connection Wizard	592
On the Receiver unit	592

STEP 1: Select [Start] when ready	592
STEP 2: Connect Trigger and LAN cables	592
STEP 3: Select LAN address of ERTA Partner	593
STEP 4: Test Partnership	593
STEP 5: Measure Jumper Cables	594
Configure Measurement Settings	596
Select Measurement	596
Normalize	597
How to Normalize the B trace	597
Source Tracking Offset and Offset Reversal	597
How to set Tracking Offset and Offset Reversal	597
Improve Dynamic Range	598
How to set Source Power	598
Source Enable and Source Mode	598
26. AM/FM Metrics (SA Only and Option 355)	
Using AM/FM Metrics	599
Overview of Measurement Types	599
How to Set Up AM/FM Metrics	602
SINAD and THD Calculations	606
Interpreting AM/FM Metrics Error Messages	609
Test Tone Not Found	609
Test Tone Not Found - Example	610
Test Tone Not Found - Corrected Example	611
27. Channel Scanner (Option 312)	
Using Channel Scanner	614
How to Set Up Channel Scanner	615
How to Define a Channel and Use Channel Scanner	618
Step 1A: Scan Mode: Range Channel Defined	619
Step 1B: Scan Mode: Custom List Channel Defined	620
Step 2: Select Display Type	621
Step 3: Modify Scale and the Display Color Bar Settings	625
Step 4: Enable Data Logging and Record Results	626
Step 5: Save the Log Results:	629
Optional Step: Indoor Map Data Logging	630
Step 6: Import and Play back KML Files into 3rd Party Software (Example: Google Earth with Animation Tool)	631
Field Strength Measurements	632
Field Strength Measurements	634
How to select and edit corrections for Field Strength measurements	634
Using the Antenna/Cable Editor	638
How to use the Antenna/Cable Editor	638
How to create a Cable file from an S21 (NA mode) or an Insertion Loss (CAT mode)	

measurement	640
Using Mapping	640
Using Resolution Bandwidth Tradeoff (Res BW Tradeoff)	640
28. Noise Figure Mode (Option 356 – CPU2 Only)	
Using Noise Figure	644
How to Define a Noise Figure Measurement	648
Example: Typical Noise Figure Measurement Procedure	648
Overview of Softkey Menus	649
How to Use DUT Measurement Setups	656
Using Measure Setup to Choose DUT Type	656
DUT Type and Frequency Context	661
Frequency Range and Frequency Context	665
DUT Type Loss Compensation	666
Single / Continuous / Restart	668
How to set Single or Continuous	668
Points	668
Resolution Bandwidth (Res BW)	669
How to set Res BW	669
Alignments	669
Calculating Noise Figure Measurement Uncertainty	670
Reverse noise wave generation by the DUT or preamplifier	670
Electromagnetic interference	671
DUT oscillations, microphonic behavior, etcetera	671
Entering Uncertainty Information	671
Using ENR Tables	675
How to Create an ENR Table	675
About ENR (*.enr), Preamplifier (*.amp), and DUT (*.dut) Files	676
ENR (*.enr) Files	676
Preamplifier (*.amp) Files	677
DUT (*.dut) Files	677
Using Markers (Noise Figure)	678
Calibration Wizard	679
When to Calibrate	679
Understanding Receiver and User Calibrations	679
How to use Auto-Integration	682
About Auto-Integration	682
Auto-Integration Procedure	683
Other Features Available	688
Troubleshooting	689
29. Data Analysis Features	
All about Markers	692

How to create Markers	692
How to move a Marker after it is created.	692
About Delta Markers	693
How to Create a Delta Marker	694
How to move the Reference marker	694
Fix the position of the Reference marker (I/Q Analyzer, RTSA, and SA Modes ONLY)	694
Signal Track Marker (NF and SA Mode ONLY)	694
Marker Table	694
How to display the Marker table	695
Coupled Markers (NA Mode)	695
How to create Uncoupled Markers	696
Marker Colors	696
Marker Trace (CAT, NA, NF Modes)	696
How to move a CAT, NA, and NF mode marker between traces	696
Marker Trace (IQA and SA Mode).	696
How to move an IQ and SA mode marker between traces	697
Marker Format	697
How to choose marker format	697
Searching with Markers	698
How to Search with Markers	698
What Is a 'Peak'	703
How to set Peak Criteria	703
Marker Functions	705
How to use Marker Functions	705
I/Q Analyzer (IQA) Marker Functions	706
SA Marker Functions	706
All about Limit Lines	707
How to Create Fixed Limit Lines	707
Relative Limit Lines	708
How to Create a Relative Limit Line.	708
Build From Trace.	708
How to Build Limit Lines from a Trace.	709
Limit Options	709
How to set Limit Options	709
How to Save and Recall Limits	710
Display Line (I/Q, NF, and SA Modes Only).	711
How to create and move a Display Line	711
All about Trace Math	712
How to display data and memory traces.	712
How to perform Trace Math	712
About Math Operations	713
All about Scale Settings	714
How to Use Scale Settings.	714

How to set Scale	714
Averaging (CAT, NA, Power Meter, Channel Scanner, and Pulse Measurement Modes Only)	715
How to Enable/Disable Averaging	715
How to set Trace Averaging	715

30. System Settings

Run/Hold	718
How to perform a single sweep while in Hold	718
Preset	719
How to Preset the FieldFox	719
User Preset.	719
How to set User Preset	720
How to recall User Preset	720
Audio (Volume) Control	720
How to set the FieldFox Volume Control	721
Display (Settings).	721
Display Brightness.	721
How to set Display Brightness	721
Display Colors	721
How to set Display Colors.	721
Trace Width	722
How to set Trace Width.	722
Title	722
How to add or edit a Title	723
Edit Keywords	723
Full Screen Mode.	723
Utilities.	724
How to view and change Utilities Settings.	724
Utilities Softkey Choices	724
How to view and change the Frequency Extender (Freq Extnd) Settings	725
Preferences	733
Quick Settings Table	733
How to view and change Preference Quick Settings	734
Save and Reset Preferences	735
How to save current settings as Preferences	735
Global Settings (Overview)	735
How to select Global Settings:	735
Language.	736
Battery Saver.	736
Startup Mode.	737
Display	737
Audio	738

Date and Time	739
GPS – Distance Settings	739
How to select CAT distance units:	739
Frequency Reference	741
How to set the frequency reference settings:	741
File folders	741
How to set File Folders	741
Alpha Numeric Editing	742
File Saving Naming Options	742
Quick Save Editing	742
Group Save File Types Editing	743
Group Save File Types Procedure	743
Group Save File Types	743
CAT (Distance Units)	744
CAT/NA	745
SA	746
Discrete Colors Softkey Menu	747
Using the Discrete Colors Softkey Menu	747
System Configuration	747
Options (Licensing)	747
How to view the Installed Options	747
How to Install Options (License File)	748
How to Delete ALL Options	748
GNSS (GPS+) and GPS	749
How to make GPS settings	749
GPS Status	751
More GNSS and GPS settings	751
Saving Data with GPS Enabled	752
More GNSS Settings	753
GNSS and GPS Freq Ref Source Settings	753
Frequency Reference Source	754
How to select Frequency Reference Source	754
Hold-over mode	754
Frequency Reference Status	754
Reference OUT	755
Variable Voltage Source (Opt. 309)	755
How to make Voltage Source settings	756
Security Level	756
How to set Security Level	756
Date and Time, Format, and Time Zone Settings	757
How to Update Date and Time using Internet	757
How to MANUALLY set Date and Time, Format, and Time Zone	758
LAN Settings	758

How to configure LAN settings	759
Power ON	760
How to set Power ON	760
FieldFox Package Installer (N995xA, N996xA, and applies to: N991xA/2xA/3xA units with serial number prefixes ≥ 5607)	761
How to run the Installer	761
How to backup files	761
How to restore files	762
Service Diagnostics	763
System Information	763
Event Log	763
Battery	763
Internal Temperatures	763
Erase User Data	764
How to Erase User Data	764

31. Using the Mini-USB Port to send SCPI Commands and Queries (N995xA/6xA and applies to: N991xA/2xA/3xA units with serial number prefixes ≥ 5607)

Mini-USB Connection to PC with IO Libraries	765
---	-----

32. File Management

Saving and Recalling Files	768
Save Files	768
How to Save a File	768
How to use the FieldFox labeler	770
How to move the cursor	771
When the current filename is complete	771
Recall Files	772
State Files	772
Image Files	772
How to Recall a File	772
Move (Copy) Files	772
How to move a file	773
Set File Type and Select Device	773
Select Device (location of File Save/Recall)	773
How to set File Type	774
About SNP Files	775
Corrections	775
> Display formats	775
> What Data Processing functions are included in saved SNP Data:	775
Manage Files	776
How to Manage files	776
Manage Folders	778
Press Save/Recall 9	778
Edit Keywords	779

How to edit keywords.	779
How to move the cursor:	779
When the selected keyword is complete:	779
Prefixes and Suffixes for Filenames	779
This section contains the following sections:	780
How to edit the Prefix and Suffix (Auto Append)	780
How to move the cursor.	781
When the Prefix is complete	781
How to enable/disable the Prefix (persistent)	781
How to enable/disable Auto Append (Suffix)	781
Press Printing	782
How to print the current screen or a saved file	782
33. Working with the Lithium-Ion Battery	
Viewing the Battery Charge Status	783
Service Diagnostics—Battery Screen	784
Built-In Battery Gauge	784
Charging the Battery	785
Internal Charging with the AC/DC Adapter	785
Using the External Battery Charger (N9910X-872)	787
Reconditioning Battery	788
Battery Care	788
Maximizing Battery Life	788
Lithium-Ion Battery Disposal	789
34. Safety Considerations	
For the FieldFox	792
For the AC/DC Adapter	794
For the External Battery Charger (N9910X-872)	795
For the Battery	795
High Capacity Lithium Battery (N9910X-876)	796
Standard Capacity Battery (N9910X-870)	798
Battery Protective Functions	800
Battery Protective Functions (N9910X-876)	800
Active Protection	800
Passive Protection	801
Battery Protective Functions (N9910X-870)	802
Active Protection	802
Passive Protection	803
Batteries: Safe Handling and Disposal.	803
Battery Transportation	803
Environmental Requirements	804

Electrical Requirements	804
Electrostatic Discharge (ESD) Precautions	804
FieldFox Markings	804
Battery Markings	807
Packaging Markings	810
AC/DC Adapter Markings	810
Certification and Compliance Statements	813
Certification	813
Manufacturer's Declaration	814
Declaration of Conformity	814
EMC	814
Safety	814
South Korean Class B EMC Declaration	814
Acoustic Statement (European Machinery Directive)	815
.	818
.	820
How Often Should Calibrate My Instrument?	821
How do I Get an Instrument Calibration?	821
What Are My Choices of Instrument Calibration?	822
.	823
.	834
.	846

1 Overview

Models and Options

Table 1-1 Models

Model	Max Freq (GHz)	Description
N9913A	4	Vector Network Analyzer AND Spectrum RF Analyzer
N9914A	6.5	Vector Network Analyzer AND Spectrum RF Analyzer
N9915A	9	Vector Network Analyzer AND Spectrum Microwave Analyzer
N9916A	14	Vector Network Analyzer AND Spectrum Microwave Analyzer
N9917A	18	Vector Network Analyzer AND Spectrum Microwave Analyzer
N9918A	26.5	Vector Network Analyzer AND Spectrum Microwave Analyzer
N9925A	9	Vector Network Microwave Analyzer
N9926A	14	Vector Network Microwave Analyzer
N9927A	18	Vector Network Microwave Analyzer
N9928A	26.5	Vector Network Microwave Analyzer
N9935A	9	Spectrum Microwave Analyzer
N9936A	14	Spectrum Microwave Analyzer
N9937A	18	Spectrum Microwave Analyzer
N9938A	26.5	Spectrum Microwave Analyzer
N9950A	32	Vector Network Analyzer AND Spectrum Microwave Analyzer
N9951A	44	Vector Network Analyzer AND Spectrum Microwave Analyzer
N9952A	50	Vector Network Analyzer AND Spectrum Microwave Analyzer
N9960A	32	Spectrum Microwave Analyzer
N9961A	44	Spectrum Microwave Analyzer
N9962A	50	Spectrum Microwave Analyzer

Minimum Frequency: 30 kHz for all models

FieldFox Options: For a comprehensive list, view the FieldFox Configuration Guide at:
<https://www.keysight.com/us/en/assets/7018-03329/configuration-guides/5990-9836.pdf>.

Accessories

The following accessories are included with every FieldFox. Spare accessories can be ordered at any time. Refer to **Table 1-2**. Some of the optional accessories—not included unless requested—are listed in **Table 1-3**. For more, refer to <http://www.keysight.com/find/fieldfox>.

Table 1-2 Accessories

Accessory Part Number	Description
N9910X-873	AC/DC Adapter (except for US/Canada) ^a
N9910X-870	Lithium-Ion Battery
N9910X-877	AC/DC Adapter for US / Canada only ^a
N9910X-880	Soft-case w/ Backpack & Shoulder Strap
N9910X-890	User's Guide (printed copy)
N9910X-891	Quick Reference Guide (printed copy)

a. Depending on your region, the FieldFox comes with either a N9910X-873 AC/DC adapter or a N9910X-877 AC/DC adapter.

Optional Accessories

Table 1-3 Optional Accessories (partial list)

Optional Accessory Part Number	Description
N9910X-872	External battery charger
N9910X-886	17 mm torque wrench
N9910X-876	Lithium-Ion Battery (High Capacity)

NOTE

Although not supplied, a USB keyboard and mouse CAN be used with the FieldFox.

To see a complete list of accessories that are available for the FieldFox, please visit: <http://www.keysight.com/find/fieldfox>.

FieldFox Manuals, Software, and Supplemental Help

The following manuals and software are available for the FieldFox.

To access all of these, visit: www.keysight.com/find/fieldfoxsupport

- **User’s Guide** – This manual, included with shipment.
- **Quick Reference Guide** – Printed copy with laminated pages for outdoor use included with shipment.
- **Supplemental Online Help** – Concepts and Reference information.
Programming Guide – Online, off line and pdf versions.
<http://na.support.keysight.com/fieldfox/help/SupHelp/FieldFox.htm>
- **FieldFox Data Link Software and Help** – Free download. Includes help on editing calibration kits and cable files. Refer to
[FieldFox Data Link Software | Keysight](#).
- **Service Guide** – Free download.
[FieldFox MW VNA/SA Service Guide \(keysight.com\)](#)
- **Firmware Updates** – Check to see if you have the latest FieldFox firmware.
[FieldFox Current Firmware \(New CPU\) | Keysight](#)

Conventions that are used in the Manual

- **Hardkey** indicates a front panel button. The functionality of these buttons does not change.

The five Softkey menus change dynamically and follow these color conventions:

- **Softkey** Blue indicates an available setting.
- **Softkey** Green indicates a change in menu level when selected.
- **Softkey** Black indicates the default or selected setting.
- **Softkey** Yellow indicates an active entry in process.
- **Softkey** Grey indicates a key that is NOT available.

Safety Notes

The following safety notes are used throughout this manual. Familiarize yourself with each of the notes and its meaning before operating this instrument. More pertinent safety notes for using this product are located in [Chapter 34, “Safety Considerations”, on page 791](#).

CAUTION

Denotes a hazard. It calls attention to a procedure that, if not correctly performed or adhered to, would result in damage to or destruction of the product or loss of important data. Do not proceed beyond a caution note until the indicated conditions are fully understood and met.

WARNING

Denotes a hazard. It calls attention to a procedure which, if not correctly performed or adhered to, could result in injury or loss of life. Do not proceed beyond a warning note until the indicated conditions are fully understood and met.

2 Preparing for Initial Use of Your New FieldFox

Check the Shipment

When you receive your FieldFox, check the shipment according to the following procedure:

1. Inspect the shipping container for damage. Signs of damage may include a dented or torn shipping container or cushioning material that indicates signs of unusual stress or compacting. If not damaged, save the packaging material in case the FieldFox needs to be returned
2. Carefully remove the contents from the shipping container, and verify that the standard accessories and your ordered options are included in the shipment according to the Box Contents List
3. For any question or problems, refer to **“Contacting Keysight” on page 5**

Meeting Power Requirements for the AC/DC Adapter

Voltage:	100 VAC to 240 VAC
Frequency:	50 Hz to 60 Hz
Current:	1.5 A (100 VAC) to 0.75 A (240 VAC)

The AC/DC adapter supplied with the analyzer is equipped with a three-wire power cord, in accordance with international safety standards. The power cable appropriate to the original product shipping location is included with the FieldFox.

Various AC power cables are available from Keysight that are unique to specific geographic areas. You can order additional AC power cables that are correct for use in different areas. For the power cord part number information please visit: <http://www.keysight.com/find/fieldfox>

Install the Lithium-Ion Battery



Step	Notes
1. Open the battery door.	Push the button on the battery compartment door while sliding the door outward.
2. Insert the battery.	The terminals end of the battery is inserted into the compartment.
3. Close the battery door.	Slide the battery compartment door upwards until it latches.

Battery Usage

When you receive your FieldFox, the lithium-ion battery is not installed, and it is partially charged to approximately 30% to preserve battery life. A lithium-ion battery has no memory effect, so it can be used partially charged, as shipped.

A fully charged battery will power your FieldFox for about four hours, so if you plan to use it for this long, you should fully charge the battery.

NOTE

The FieldFox will shut down to prevent the battery from discharging to a level that is damaging. If this occurs, charge the battery either internally or externally.

Learn more about the lithium-ion battery in [Chapter 33, “Working with the Lithium-Ion Battery”](#), on page 783.

Battery charge status is viewable:

-  In the upper-right corner of the screen.
- On the Battery screen. To access the screen, select **System**, **Service**, **Diagnostics**, and **Battery**.

- On the battery. Open the FieldFox battery compartment door to view the battery LCD.

To conserve battery power:

- Use **Run/Hold** to single-trigger a measurement when needed. **Hold** is shown on the display.
- Press **System** then **Display** then **Brightness**. Use the **▲▼** arrows, the rotary knob, or numeric keypad to adjust the brightness to dim the FieldFox display as much as possible.
- Briefly press the power button > Standby, to switch to Standby mode when the FieldFox is not being used. Press power button again to restore power. All current settings are preserved.

NOTE

When powered by the battery only, the FieldFox can stay in Standby mode for a maximum of four hours and then it powers off automatically. When the relative battery charge drops by about 20%, the FieldFox will power off to preserve the remaining charge.

To recharge a battery:

Use ONLY a FieldFox charger to recharge a battery.

- The battery can be fully charged while in the FieldFox in about 4 hours with the FieldFox either ON or OFF.
- The battery can be fully charged externally using the external battery charger in about 4 hours.
- When the battery is removed, the FieldFox can still be powered by the AC/DC adapter.

FieldFox ON/OFF Settings

NOTE

The FieldFox power button shut down/standby sequence includes a 10 second counter that allows you to either choose a softkey to immediately initiate the action (**Standby**/**Shut down**/**Restart***), or to let the countdown counter expire after 10 seconds then perform the action. *Restart can only be enabled via the Restart softkey.

- To turn power **ON**, briefly press the power button. Boot-up takes about 1 minute.
- To switch to **Standby** mode (low battery drain), briefly press the power button. See the Note above concerning Stand By.

- To turn Power **OFF** (very low battery drain), press the power button briefly and press the Shutdown softkey. Data and instrument state are NOT automatically saved when the FieldFox is powered OFF. Learn how to save data and instrument state in **Chapter 32, “File Management”, on page 767**. See the Note above concerning Shut down.
- To restart FieldFox, press the power button and press **Restart**. See the **Note** above concerning Restart.
- Press **Cancel** to exit the power down sequence.
- You can also access the power down softkey menu choices (**Standby**, **Shut down**, **Restart**, and **Cancel**) by using the **Mode** hardkey:
- Press **Mode**
 - Then **More**
 - Then **Shut down**
- You can make a setting to automatically **Power ON** the FieldFox when a power source is connected. Learn how on **“Power ON” on page 760**.

Power Button LED Status

Solid green	Power is ON
Blinking green	FieldFox in Stand By mode
Blinking amber ^a	Battery charging when the FieldFox power is off
Blinking amber and green	Stand By mode and battery charging
Not lit	Power is Off and battery is not charging

a. LED showing a repeating ramping-up of the intensity of the LED to indicate the battery is charging.

FieldFox High Temperature Protection

The following features prevent degradation or damage in the event of high internal temperatures in the FieldFox.

NOTE

Do NOT store the FieldFox in the soft-case while powered ON or in Standby mode.

How to monitor the internal FieldFox temperature:

- Press **System**, then **Service Diagnostics**.
- Then **Internal Temperatures**.

- The average temperature that is displayed for the Internal Temperature is the average of the RF1, RF2, SB1, SB2 temperatures. These temperatures come from internal sensors embedded within the FieldFox.

The average temperature does **not** include the CPU or the battery temperatures. The FieldFox does **not** measure the CPU and battery temperatures.

Temperature Control Mode

The FieldFox's internal temperature control preserves measurement accuracy and maintains the long-term reliability of the FieldFox. See also, "**High-Temp Shutdown Warning (RTSA Mode Only)**" on page 43.

NOTE

Measurement speed specifications do NOT apply in Temperature Control Mode.

Entering Temperature Control Mode

At an average internal temperature of above approximately 64°C, the FieldFox enters Temperature Control mode by reducing display intensity. This should decrease the internal temperature which preserves measurement accuracy and maintains the long-term reliability of the FieldFox. Refer to **Figure 2-1**.

In addition, duty cycling is enabled when the internal average temperature of the FieldFox reaches the duty cycling threshold of above ~64°C. All applications (except RTSA): Power for internal circuitry is turned off between sweeps and delaying occurs for the next sweep. In RTSA mode, power is only turned off, if the FieldFox is in Single Sweep or Hold.

All applications (including RTSA): Display dims to 40% at ~64°C.

For all modes, except RTSA mode, you will see the following messages displayed for ~3 seconds:

```
"Automatic Meas Duty Cycling activated for thermal management"
```

Later if the temperatures are reduced:

```
"Temperatures reduced, ending Automatic Meas Duty Cycling"
```

For RTSA mode (where duty cycling is not possible), you will see the following messages displayed for ~3 seconds:

```
"Entering Auto Protect mode for thermal management"
```

Later if the temperatures are reduced:

```
"Temperatures reduced, exiting Automatic Protect Mode"
```

Entering Auto Protect (Maximum) Threshold Temperature Mode

At above approximately 75°C, the FieldFox enters (Maximum) Auto Protect temperature control mode by displaying the “Entering Auto Protect mode...”. See also [Table 2-1 on page 44](#).

When you enter the Auto Protect (Maximum) Threshold, the following message is displayed:

"Entering Maximum Auto Protect mode for thermal management"

When temperature reaches the maximum protection threshold (~75°C), some applications take additional measures.

Figure 2-1

Entering Auto Protect mode message (above ~64°C)—(Displays for 3 sec)



Exiting Maximum Auto Protect Threshold Temperature Mode

When the temperature drops to approximately 73.5°C, a message is displayed indicating that the FieldFox is leaving Temperature Control Mode and normal operating settings are restored (refer to [Figure 2-2](#)). See also, [Table 2-1 on page 44](#).

When you exit the Auto Protect (Maximum) Threshold control mode, the following message is displayed:

"Temperatures reduced, exiting Maximum Auto Protect mode"

Figure 2-2

Exiting Maximum Auto Protect mode message—(~62.5°C)

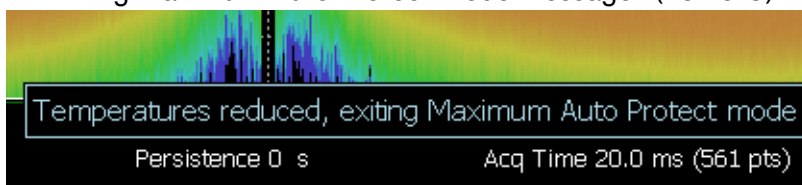

High-Temp Shutdown Warning (RTSA Mode Only)

In extreme situations, Temperature Control mode may not stop an increase in the FieldFox internal temperature. Just prior to shut down, the FieldFox will display a warning of imminent shut down and the instrument turns off. At above approximately 77°C, a Maximum Auto Protect message—(Top “WARNING...” message) displays for 9 sec. Red text at left bottom corner of display remains on until internal temperature returns to ~75.5°C. At above ~78°C, High-Temperature Shut down will engage and turn OFF the FieldFox. Refer to [Figure 2-3](#). See also, [Table 2-1 on page 44](#).

Figure 2-3 Shutdown Warning message—(above ~77°C) - (RTSA Mode Only!)

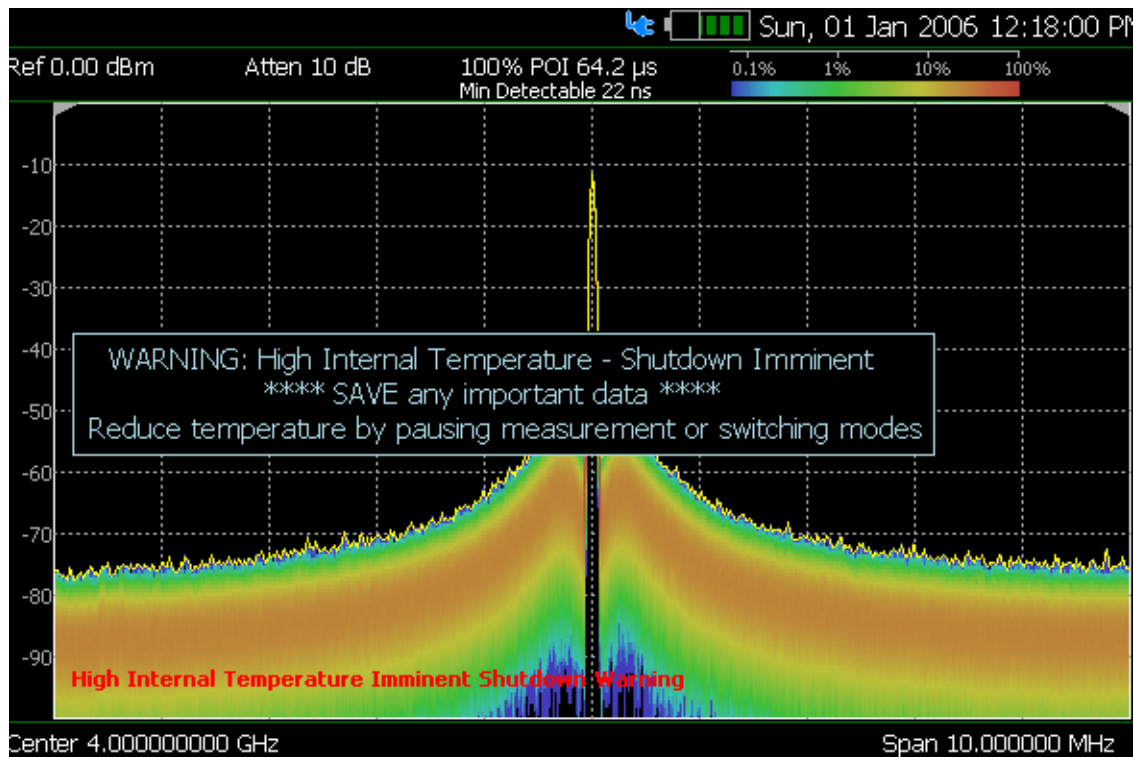

Summary of FieldFox Average Internal Temperature Protection Behavior

Table 2-1 Summary of FieldFox Temperature Protection

Threshold	Average Internal Temperature	Description of Behavior
Duty cycling	~64°C	Duty cycling is enabled when the internal average temperature of the FieldFox reaches the duty cycling threshold of ~64°C. Power is turned off between sweeps and delaying occurs for the next sweep. In RTSA mode power is only turned off in Single Sweep or Hold. This enables you to control your instrument's temperature when you don't need to make a measurement by using the "Run/Hold" hardkey to pause the sweep. All applications (including RTSA): Display dims to 40% at ~64°C.
Maximum Protect (Initial)	~75°C	When temperature reaches the maximum protection threshold (~75°C) some applications take additional measures.
1 degree below shutdown (RTSA Mode Only)	~77°C	RTSA Shutdown Warning (~77°C) – (Top "WARNING..." message displays for 9 sec). Red text at bottom of display remains on until internal temperature returns to ~75.5°C. Refer to Figure 2-3 on page 43 .
Shutdown	~78°C	Instrument shuts down.
Exit Duty Cycle	~62.5°C	The temperature required to come out of the duty cycle threshold.

Avoid Overpowering the FieldFox

The FieldFox can be damaged with too much power or voltage applied. Exceeding the maximum RF power levels shown below will cause an ADC Over Range message to appear on the screen.

CAUTION

Maximum Input Voltages and Power:

- RF IN/OUT Connectors: ±50 VDC, +27 dBm RF
- DC Input: -19 to 19 VDC, 60 Watts maximum when charging battery

Learn more about Maximum power and voltages in the FieldFox Data Sheet.

NOTE

Very often, coaxial cables and antennas build up a static charge, which, if allowed to discharge by connecting to the FieldFox, may damage the instrument input circuitry. To avoid such damage, it is recommended to dissipate any static charges by temporarily attaching a short to the cable or antenna prior to attaching to the FieldFox.

Take the FieldFox Tour

Front Panel



N9912_001_401

Preparing for Initial Use of Your New FieldFox
Take the FieldFox Tour

No.	Caption	Description	Learn More:
1	Power	ON: press momentarily. STAND BY: with FieldFox power ON, press briefly. OFF: press and hold until the FieldFox shuts off (about 4 seconds).	“FieldFox ON/OFF Settings” on page 39
2	LED	Not lit: FieldFox OFF, not charging Green: FieldFox ON. Charging status indicated by battery icon on screen Orange, flashing: FieldFox STAND BY Orange, intensity increasing, flashing slowly: FieldFox OFF, charging	“Power Button LED Status” on page 40
3	System	Displays a sub-menu for system setup	“System Settings” on page 717
4	Function keys	Includes: Freq/Dist , Scale/Amptd , BW , Sweep , Trace , Meas Setup , Measure , and Mode .	Refer to specific Mode.
5	Preset	Returns the analyzer to a known state	“How to Preset the FieldFox” on page 719
6	Enter	Confirms a parameter selection or configuration	--
7	Marker	Activates marker function	“All about Markers” on page 692
8	Mkr-->Tools	Displays a sub-menu for marker functions	“All about Markers” on page 692
9	Esc	Exits and closes the Active Entry dialog box or clears the character input	--
10	Save/Recall	Saves the current trace or recalls saved data from memory	“Saving and Recalling Files” on page 768

Preparing for Initial Use of Your New FieldFox
Take the FieldFox Tour

No.	Caption	Description	Learn More:
11	Limit	Sets limit lines for quick Pass/Fail judgment	“All about Limit Lines” on page 707
12	Run/Hold	Toggles between free Run and Hold/Single operation.	“Run/Hold” on page 718
13	Cal	Displays a sub-menu for calibration functions	“Calibration Method Summary” on page 157
14	Arrow keys	Increases or decreases a value or setting.	--
15	◀Back	Returns to the previous menu selection.	--
16	Rotary knob	Highlights an item for selection, or enables incremental changes to values.	--
17	Softkeys	Allows selection of settings for configuring and performing measurements, and for other FieldFox functions.	--
18	Screen	Transflective screen, viewable under all lighting conditions. If you are using your FieldFox in direct sunlight, you do not need to shield the display from the sunlight. In bright lighting conditions, the display is brighter and easier to read when you allow light to fall directly on the screen. Alternative color modes exist that maximize viewing in direct sunlight conditions, as well as other conditions such as nighttime work.	“Screen Tour” on page 51

NOTE

Clean the Transflective screen with gentle and minimal wiping using Isopropyl alcohol applied to a lint-free cloth.

Top Panel



Caption	Descriptions	Learn More:
Port 1 RF Output	For CAT and NA measurements, use to make reflection measurements. Maximum: ± 50 VDC, +27 dBm RF Also, for SA source output in SA mode.	“CAT Mode Settings” on page 57 “NA Mode Settings” on page 99 Chapter 9, “SA (Spectrum Analyzer) Mode (Option 233–Mixed Analyzers)”, on page 159
Port 2 SA RF Input	For SA, use to make all measurements. For CAT, NA, and VVM mode, use to make Port 2 transmission measurements. Maximum: ± 50 VDC, +27 dBm RF.	“SA Mode Settings” on page 163
GPS Ant	SMA (f) connector for use with built-in GPS. Produces a 3.3 VDC bias voltage for the antenna pre-amplifier. Use with a GPS antenna such as N9910X-825. Other GPS antennas can also be used.	“GNSS (GPS+) and GPS” on page 749
Ref In Trig In	SMA (f) connector for use with Frequency Reference Source and External Trigger Input signal. Maximum: 5.5 VDC.	“Frequency Reference Source” on page 754. “Triggering” on page 202

Right Side Panel





Connector	Description	Learn More:
	<p>Ethernet cable connector to read trace data using the FieldFox Data Link Software and connect to the FieldFox remotely.</p> <p>Download the latest version of the software at: www.keysight.com/find/fieldfoxsupport</p>	<p>“LAN Settings” on page 758</p>
	<p>IF Out used in SA mode for external signal processing.</p>	<p>“IF Output” on page 197</p>
	<p>Frequency Reference Source Output Trigger Output (ERTA mode).</p>	<p>Chapter 25, “ERTA (Extended Range Transmission Analysis) Mode - Option 209”, on page 589</p>
	<p>Secure Digital slot. Use to extend the memory of the FieldFox.</p>	<p>“Saving and Recalling Files” on page 768</p>
	<p>On the N995xA/6xA (Also, applies to: N991xA/2xA/3xA units with serial number prefixes ≥ 5607) models, the mini-USB port can be connected to your PC’s standard USB port to send SCPI commands.</p> <p>NOTE IMPORTANT! It is recommended that only USB certified cables are used with the FieldFox.</p>	<p>Chapter 31, “Using the Mini-USB Port to send SCPI Commands and Queries (N995xA/6xA and applies to: N991xA/2xA/3xA units with serial number prefixes ≥ 5607)”, on page 765</p>
	<p>Two standard USB connectors used to connect a power sensor for Power Meter Mode. Also used to save files to a USB flash drive.</p> <p>NOTE IMPORTANT! It is recommended that only USB certified cables are used with the FieldFox.</p>	<p>“Saving and Recalling Files” on page 768</p>

Preparing for Initial Use of Your New FieldFox
Take the FieldFox Tour

Left Side Panel



Connector	Description	Learn More:
	Audio output jack for use with SA Mode Tune and Listen.	“Tune & Listen (AM/FM)” on page 177
	DC Voltage Source for use with external DC Bias.	“Variable Voltage Source (Opt. 309)” on page 755
	DC power connector used to connect to the AC/DC adapter. Maximum: 19 VDC, 4 ADC.	“Internal Charging with the AC/DC Adapter” on page 785

Screen Tour

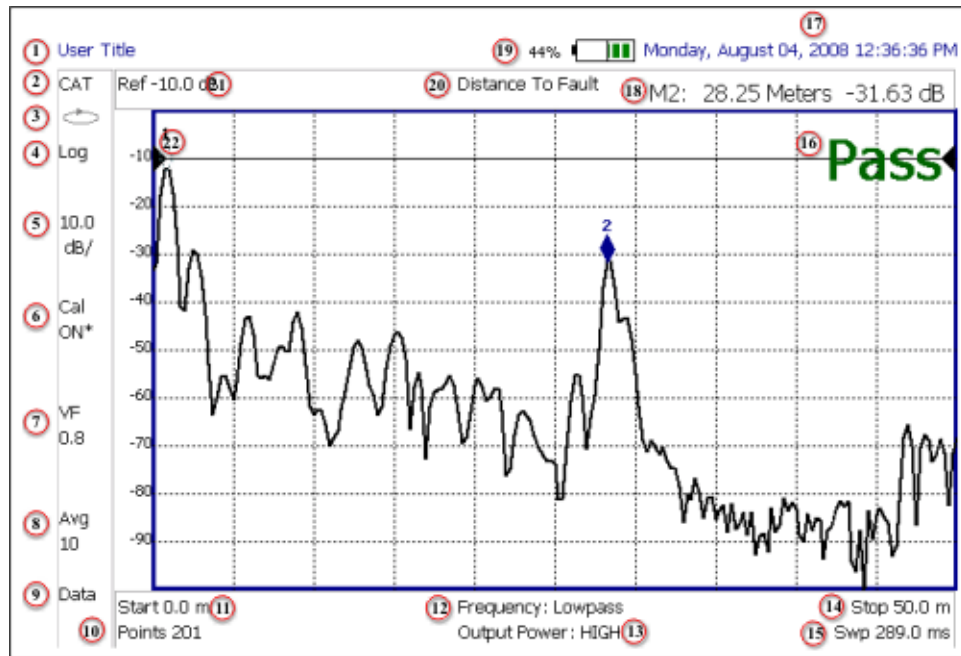

Caption	Description	Learn More:
1	Title – write your own text here	“Title” on page 722
2	Current Mode	--
3	Run / Hold	“Run/Hold” on page 718
4	Display Format	Mode dependent
5	Scale/division	Mode dependent
6	Calibration Status (CAT and NA) Detection Method (SA)	“Cal ON? – Questionable Accuracy” on page 153
7	Velocity Factor (Fault Meas)	“About Velocity Factor and Cable Loss” on page 77
8	Averaging Status and Count	Mode dependent
9	Data / Mem Display (CAT and NA) Step / FFT (SA)	“All about Trace Math” on page 712 “Resolution Bandwidth (Res BW)” on page 194
10	Resolution Setting	Mode dependent
11	Measurement Start Freq or Distance	Mode dependent

Preparing for Initial Use of Your New FieldFox
Take the FieldFox Tour

Caption	Description	Learn More:
12	Bandpass / Lowpass setting (Fault Meas) IF BW in NA Mode	“DTF Measurement Settings” on page 74
13	Output Power Level (CAT and NA)	“Output Power” on page 63
14	Measurement Stop Freq or Distance	Mode dependent
15	Actual Sweep Time	Mode dependent
16	Limit Line Status	“All about Limit Lines” on page 707
17	Time and Date	“Date and Time” on page 739
18	Marker Readout	“All about Markers” on page 692
19	Battery Status	“Viewing the Battery Charge Status” on page 783
20	Measurement Type (CAT and NA)	--
21	acquisition	Mode dependent
22	Reference Position	Mode dependent

How to Enter Numeric Values

Many settings on the FieldFox require the entry of numeric values.

How to enter numeric values

Use any combination of the following keys:

- Numeric 0–9 keys, along with the polarity (+/-) key.
- Up/Down arrow keys to increment or decrement values.
- Rotary knob to scroll through a set of values.
- **Back** erases previously entered values.
- **Esc** exits data entry without accepting the new value.

To complete the setting, press **Enter** or a different **softkey** or **hardkey**.

Multiplier Abbreviations

Many times after entering numeric values, a set of multiplier or suffix softkeys are presented. The following explains the meaning of these abbreviations.

Select Frequency multipliers as follows:

- **GHz** Gigahertz (1e9 Hertz)
- **MHz** Megahertz (1e6 Hertz)
- **KHz** Kilohertz (1e3 Hertz)
- **Hz** Hertz

Select Time multipliers as follows:

- **s** Seconds
- **ms** milliseconds (1e-3)
- **us** microseconds (1e-6)
- **ns** nanoseconds (1e-9)
- **ps** picoseconds (1e-12)

Connector Care

- Never store connectors, airlines, or calibration standards loose in a box. This is a common cause of connector damage.
- Install protective end caps when connectors are not in use.
- Keep connector temperature the same as the test instrument. Holding the connector in your hand or cleaning connector with compressed air can significantly change the temperature. Wait for connector temperature to stabilize before using in calibration or measurements.
- Do not touch the mating plane surfaces. Natural skin oils and microscopic particles of dirt are difficult to remove from these surfaces.
- Do not set connectors contact-end down on a hard surface. The plating and mating plane surfaces can be damaged if the interface comes in contact with any hard surface.
- Wear a grounded wrist strap and work on a grounded, conductive table mat. This helps protect the analyzer and devices from electrostatic discharge (ESD).
- Refer to **“Connector Care Review” on page 817**.

CAUTION

Because of the very small and precise mechanical tolerances of mmWave connectors, minor defects, damage, and dirt can significantly degrade repeatability and accuracy. In addition, a dirty or damaged connector can destroy connectors that are mated to it. For this reason, NEVER use a damaged connector. See also http://na.support.keysight.com/pna/connectorcare/Connector_Care.htm

3 CAT (Cable and Antenna Test) Mode

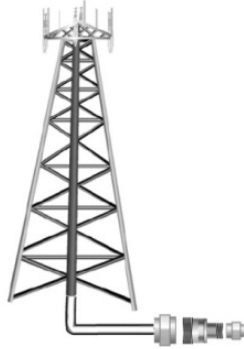

CAT Mode is typically used to test an entire transmission system, from the transmitter to the antenna. This process is sometimes referred to as Line Sweeping.

CAT Mode is similar to NA (Network Analyzer) Mode. Learn more in the Supplemental Online Help: <http://na.support.keysight.com/fieldfox/help/SupHelp/FieldFox.htm>

CAT Mode Distance to Fault measurements are discussed in [Chapter 4, "DTF \(Distance to Fault\) Measurements."](#)

NOTE

IMPORTANT! For CAT and NA modes, limit lines do not apply where $F1 = F2$.

In this Chapter

- "Measurement Selection" on page 57
- "Quick Settings Table" on page 58
- "Frequency Range" on page 59
- "Scale Settings" on page 59
- "Averaging" on page 60
- "Smoothing" on page 61
- "Single or Continuous Measure" on page 61
- "Resolution (Number of Data Points)" on page 62
- "Sweep Time" on page 62
- "Output Power" on page 63
- "Interference Rejection" on page 64
- "Coupled Frequency" on page 64

CAT (Cable and Antenna Test) Mode

Procedures

[“Return Loss Measurements” on page 66](#)

[“1-Port Cable Loss Measurements” on page 66](#)

[“2-Port Insertion Loss Measurements” on page 68](#)

See Also

[Chapter 8, “Calibration for NA, CAT, and VVM Modes”, on page 133](#)

[“All about Markers” on page 692](#)

[“All about Limit Lines” on page 707](#)

[“All about Trace Math” on page 712](#)

Making 75 Ω (ohm) Measurements at the FieldFox Supplemental Online Help:
<http://na.support.keysight.com/fieldfox/help/SupHelp/FieldFox.htm>

CAT Mode Settings

Select CAT Mode before making any setting in this chapter.

How to select CAT Mode

- Press **Mode**.
- Then **CAT/TDR**.

Measurement Selection

How to select a CAT Mode Measurement

Learn more about the following measurements in the Supplemental Online Help: <http://na.support.keysight.com/fieldfox/help/SupHelp/FieldFox.htm>

Press **Measure 1**.

Then choose one of the following: These softkeys also appear after CAT Mode is selected.

- **Distance To Fault** 1-port reflection measurement that uses Inverse Fourier Transform (IFT) calculations to determine and display the distance to, and relative size of, a fault or disruption in the transmission line. Units are in return loss format, expressed as a positive number in dB, unless the measurement selected is DTF (VSWR). Learn more about DTF Measurements refer to **Chapter 4, “DTF (Distance to Fault) Measurements.”**
- **Return Loss & DTF** Displays both a Return Loss measurement and a DTF measurement. Use this format to display the frequency settings that are used to make the DTF measurement. The frequency range settings for these two measurements can be coupled or uncoupled. Learn more on **page 64**.

Calibrations are applied to both traces

When in Hold mode and Single sweep is performed, only the active trace is triggered. Use the **▲▼** arrows to activate a trace

- **Return Loss** 1-port reflection measurement that displays the amount of incident signal energy MINUS the amount of energy that is reflected. The higher the trace is on the screen, the more energy being reflected back to the FieldFox. Learn how to measure Return Loss on **page 66**.
- **VSWR** (Voltage Standing Wave Ratio – also known as SWR) 1-port reflection measurement that displays the ratio of the maximum reflected voltage over the minimum reflected voltage. The higher the trace is on the screen, the more energy being reflected back to the FieldFox.
- **DTF (VSWR)** Distance to Fault in VSWR format.

- **Cable Loss (1-Port)** 1-port reflection measurement that displays the loss of a transmission line. Learn more on [page 66](#)
- **Insertion Loss (2-Port)** 2-port transmission measurement that accurately displays the loss through a cable or other device in dB. Both ends of the cable must be connected to the FieldFox. NO phase information is included in this measurement. Learn more at [“2-Port Insertion Loss Measurements” on page 68](#). This feature is available only with an option on some FieldFox models. For detailed information, please view the FieldFox Configuration Guide at:
<https://www.keysight.com/us/en/assets/7018-03329/configuration-guides/5990-9836.pdf>.
- **DTF (Lin)** Distance to Fault in Linear format.
- **TDR (Lin rho)** The Y-axis of the display is linear, real, unitless values. A trace without reflections shows as 0 (zero). Maximum reflections from an open or short show as 1.
- **TDR (ohm)** The Y-axis of the display is impedance (ohms).
- **TDR & DTF** TDR and DTF are displayed.

Quick Settings Table

Both CAT and NA Modes allow you to view and change most relevant settings from a single location. All of these settings are discussed in this chapter and, unless otherwise noted, ALL of these settings can also be made using the standard softkey menus.

How to view and change Quick Settings

- Press **Meas Setup 4**.
- Then **Settings**.
- Press **Next Page** and **Previous Page** to view all settings. If these softkeys are NOT available, then all available settings fit on one page.
- To change a setting:
 - Use the **▲▼** arrows to highlight a setting.
 - Then press **Edit**. The current setting changes to **yellow**.
 - Some settings require you to press a softkey to change the value. Otherwise, use the numeric keypad, **▲▼** arrows, or rotary knob to change the value.
 - When finished changing a value, press **Done Edit**.
- Press **Dock Window** to relocate the Settings table to a position relative to the trace window. The Dock Window setting persists through a Preset. Choose from the following

- **Full** (Default setting) Only the Settings table is shown on the screen. The trace window is temporarily not shown
- **Left** The Settings table is shown to the left of the trace window
- **Bottom** The Settings table is shown below the trace window
- When finished changing ALL settings, press **Done** to save your settings

Frequency Range

Set the range of frequencies over which you would like to make CAT Mode measurements

When the frequency range is changed after a calibration is performed, the cal becomes interpolated. Learn more in **“Interpolation *” on page 153.**

How to set Frequency Range

- Press **Freq/Dist**.
- Then choose from the following
 - **Start** and **Stop** frequencies - beginning and end of the sweep.
 - **Center** and **Span** frequencies – the center frequency and span of frequencies (half on either side of center).
- Follow each setting by entering a value using the numeric keypad, **▲▼** arrows, or the rotary knob.
 - After using the keypad, select a multiplier key. Learn about multiplier abbreviations in **Chapter 1, “Overview.”**
 - After using the **▲▼** arrows or the rotary knob, press **Enter**. The amount of frequency increment is based on the current span and can NOT be changed in CAT Mode.

Scale Settings

Adjust the Y-axis scale to see the relevant portions of the data trace. The Y-axis is divided into 10 graticules.

This setting can be changed at any time without affecting calibration accuracy.

How to set Scale

- Press **Scale / Amptd**.
- Then choose from the following three methods:
 1. **Autoscale** Automatically adjusts the Y-axis to comfortably fit the Minimum and Maximum amplitude of the trace on the screen.
 2. Set Scale, acquisition, and Reference Position:

- **Scale** Manually enter a **scale per division** to view specific areas of the trace
 - **Ref Level** Manually set the value of the reference line. Enter a negative value by pressing **Run/Hold (+/-)** either before or after typing a value
 - **Ref Pos** Manually set the position of the reference line. Values must be between **0 (TOP line)** and **10 (BOTTOM line)**
3. Set Top and Bottom graticule values. The scale per division is calculated.
- **Top** to set the value of the Top graticule.
 - **Bottom** to set the value of the Bottom graticule.
 - Enter a negative value by pressing **Run/Hold (+/-)** either before or after typing a value.

Scale annotation on the FieldFox screen

Reference Line = red arrow

Ref Level = -40 dB

Ref Position = 1

Scale = 2 dB per division

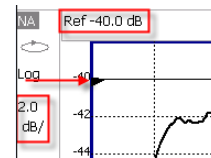

Averaging

Trace Averaging helps to smooth a trace to reduce the effects of random noise on a measurement. The FieldFox computes each data point based on the average of the same data point over several consecutive sweeps.

Average Count determines the number of sweeps to average; the higher the average count, the greater the amount of noise reduction.

An average counter is shown in the left edge of the screen as **Avg N**. This shows the number of previous sweeps that have been averaged together to form the current trace. When the counter reaches the specified count, then a 'running average' of the last **N** sweeps is displayed. Average Count = 1 means there is NO averaging.

This setting can be changed at any time without affecting calibration accuracy.

NOTE

Averaging is often used to increase the dynamic range of a measurement. To achieve the highest dynamic range, select NA mode and reduce the IF Bandwidth setting. Learn more about dynamic range in **"Increase Dynamic Range" on page 120.**

How to set Trace Averaging

- Press **BW 2**.
- Then **Average N** where **N** is the current count setting.
- Enter a value using the numeric keypad. Enter 1 for NO averaging.
- Press **Enter**.
- While Trace Averaging is in process, press **Sweep 3** then **Restart** to restart the averaging at 1.

Smoothing

Trace smoothing averages a number of adjacent data points to smooth the peak-to-peak noise values on a displayed trace. The number of adjacent data points that are averaged is known as the smoothing aperture. Aperture is set by specifying a percentage of the X-axis span.

Trace smoothing does NOT significantly increase measurement time.

Smoothing can be used with any CAT format.

When enabled, **Smo** appears on the FieldFox screen.

How to set Smoothing

- Press **BW 2**.
- Then **Smoothing ON OFF**.
- Then **Sm. Aperture** and enter a value between 0 and 25 (percent) using the numeric keypad.
- Press **Enter**.

Single or Continuous Measure

This setting determines whether the FieldFox sweeps continuously or only once each time the **Single** button is pressed. Use **Single** to conserve battery power or to allow you to save or analyze a specific measurement trace.

This setting can be changed at any time without affecting calibration accuracy.

How to set Single or Continuous

- Press **Sweep 3**.
- Then choose one of the following:
 - **Single** Automatically sets Continuous OFF and causes FieldFox to make ONE sweep, then hold for the next Single key press. Hold is annotated in the upper left corner of the display when NOT sweeping, and changes to an arrow --> while the sweep occurs

- **Continuous** Makes continuous sweeps. This is the typical setting when battery power is not critical.

You can also use **Run / Hold +/-** to toggle between Single and Continuous.

Resolution (Number of Data Points)

Data points are individual measurements that are made and plotted across the X-axis to form a trace. Select more data points to increase measurement resolution. However, more data points require more time to complete an entire measurement sweep

When the Resolution is changed after a calibration is performed, the cal becomes interpolated. Learn more in **“Interpolation *” on page 153**

How to set Resolution

- Press **Sweep 3**.
- Then **Resolution**.
- Then choose one of the following:
101 | 201 | 401 | 601 | 801 | 1001 | 1601 | 4001 | 10001.
- Using SCPI, Resolution can be set to any number of points between 3 and 10001. See the Programming Guide at <https://na.support.keysight.com/fieldfox/help/DataLinkHelp/DataLink.htm>.

Sweep Time

The fastest possible sweep time is always used as the default setting. Use the **Min Swp Time** setting to slow the sweep time when measuring long lengths of cable.

Learn more in the FieldFox Supplemental Help at: <https://www.keysight.com/us/en/lib/resources/service-manuals/keysight-fieldfox-library-help-and-manuals-2153870.html> (Keysight FieldFox Library, Help and Manuals – FieldFox Online Supplemental Help).

The actual sweep time is shown on the FieldFox screen. See **“Take the FieldFox Tour” on page 45**. To increase the sweep time, enter a value that is higher than the actual sweep time. The increase will not be exactly the amount that you enter, as the actual sweep time is the composite of many factors.

NOTE

Measurement speed specifications do NOT apply in Temperature Control Mode. Learn more in **Chapter 1, “Overview.”**

How to set Sweep Time

- Press **Sweep 3**.
- Then **Min Swp Time**.

- Enter a value using the numeric keypad.
- Press a multiplier key. Learn more in [“Multiplier Abbreviations” on page 53](#).

Output Power

Set the power level out of the FieldFox to High, Low, or manually set power level to a value between High and Low.

Generally, the high power setting is used when measuring passive, high-loss devices to place the signal farther from the noise floor. However, for devices that are sensitive to high power levels such as amplifiers, use the Low power setting.

For best measurement accuracy, use the Manual power setting at -15 dBm. After calibration, the power level can be decreased for amplifiers, or increased for higher dynamic range.

CAUTION

Power Level settings in this mode will NOT change Power Level settings in other modes. To help prevent damage to your DUT, use caution when changing modes with your DUT connected to the FieldFox test ports.

How to set Output Power

- Press **Meas Setup 4**.
- Then **Power**
- Then **Output Power**
 - **High** (Default setting) Sets output power to the maximum achievable power at all displayed frequencies. Output power is NOT FLAT across the displayed FieldFox frequency span. Please see [“Specifications/Data Sheet” on page 819](#) for expected power levels.
 - **Low** Sets output power to approximately -45 dBm, FLAT across the displayed FieldFox frequency span.
 - **Man** Set output power to an arbitrary value, FLAT across the displayed FieldFox frequency span. If flattened power can NOT be achieved, a warning message and beep occurs. To achieve a flattened output power, reduce the power level or stop frequency.
 - Then press **Power Level**
 - Then enter a value using the numeric keypad, the **▲|▼** arrows, or the rotary knob.
 - Press **Enter**.

Interference Rejection

Use this setting when you suspect that other signals in the area are interfering with a measurement. Interference may look like a spike or lack of stability in the measurement trace. While monitoring a measurement at a specific frequency, toggle this setting between ON and OFF. If the measurement result decreases while ON, then there is an interfering signal in the area. Continue to make measurements with Interference Rejection ON. However, this will slow the measurement speed.

Once enabled, up to SIX sweeps may be required before the interfering signal is neutralized.

This setting can be changed at any time without affecting calibration accuracy.

How to set Interference Rejection

- Press **Meas Setup 4**.
- Then **Interference Rejection [current setting]**.
- Then choose from the following:
 - **Off** No interference rejection and fastest possible sweep speed
 - **Minimum** The lowest level of Interference rejection.
 - **Medium** The medium level of Interference rejection.
 - **Maximum** The highest level of Interference rejection.

Coupled Frequency

This setting, especially useful for a Return Loss & DTF measurement, allows both measurements to have different frequency ranges.

How to set Coupled Frequency

With a Return Loss & DTF measurement present:

- Press **Meas Setup 4**.
- Select the DTF measurement (Tr2) using the **▲▼** arrows.
- Then choose from the following:
 - **Coupled Freq ON** - Both the Return Loss and DTF traces have the same frequency range settings.
 - **Coupled Freq OFF** (default setting) - Both traces are allowed to have individual frequency range settings. When set to OFF:
 - The Return Loss measurement frequency settings are made in the usual manner. Learn how at **“Frequency Range” on page 59**. When a new Start or Stop frequency is selected, Coupled Frequency is automatically set to OFF.

CAT (Cable and Antenna Test) Mode
CAT Mode Settings

- The DTF measurement is made using the frequencies as determined by the **DTF Frequency Mode** setting. Learn more in **“DTF Measurement Settings”** on page 74.

Return Loss Measurements

Return loss can be thought of as the absolute value of the reflected power compared to the incident power.

When measuring an OPEN or SHORT, all incident power is reflected and approximately 0 dB return loss is displayed.

When measuring a LOAD, very little power is reflected and values of 40 dB to 60 dB are displayed.

The minus sign is usually ignored when conveying return loss. For example, a component is said to have 18 dB return loss, rather than -18 dB.

How to Measure Return Loss

- Connect the jumper cable or any adapter used to connect the device under test (DUT).
- Select **Preset** then **Preset** Returns the FieldFox to known settings
- Select **Mode** then **CAT/TDR** (Cable and Antenna Test)
- Then **Return Loss** (Default measurement).
- Press **Freq/Dist** and enter **Start** and **Stop** frequency values of the measurement.
- Press **Meas Setup 4** then **Settings** to make appropriate settings before calibrating.
- Disconnect the jumper cable or DUT and press **Cal 5** then follow the calibration prompts.
- Reconnect the jumper cable or DUT.
- The return loss trace is displayed on the FieldFox screen.

1-Port Cable Loss Measurements

While all cables have inherent loss, weather and time will deteriorate cables and cause even more energy to be absorbed by the cable. This makes less power available to be transmitted.

A deteriorated cable is not usually apparent in a Distance to Fault measurement, where more obvious and dramatic problems are identified. A Cable Loss measurement is necessary to measure the accumulated losses throughout the length of the cable.

A 2-port Insertion Loss measurement is usually more accurate than a 1-port Cable Loss measurement. However, to perform a 2-port Insertion Loss measurement, both ends of the cable must be connected to the FieldFox.

NOTE

In high-loss conditions, a Cable Loss measurement becomes 'noisy' as the test signal becomes indistinguishable in the FieldFox noise floor. This can occur when measuring a very long cable and using relatively high measurement frequencies. To help with this condition, use High Power (page 63) and Averaging. (page 60).

How to make a 1-port Cable Loss Measurement

1. Press **Preset** then **Preset**.
2. Then **More** then **Cable Loss (1-Port)**
3. Connect the cable to be tested.
4. Press **Freq/Dist** and enter **Start** and **Stop** frequency values of the measurement.
5. Press **Sweep 3** then **Min Swp Time**. Increase the Sweep Time until a stable trace is visible on the screen. The amount of time that is required increases with longer cable lengths. Learn more in the **Supplemental Online Help**: <http://na.support.keysight.com/fieldfox/help/SupHelp/FieldFox.htm>
6. Remove the cable to be tested.
7. Press **Cal 5**, then **QuickCal** or **Mechanical Cal**. Mechanical Cal.

NOTE

QuickCal is only available on N991xA/2xA/3xA models.

8. Follow the prompts to perform calibration at the end of the jumper cable or adapter. Learn more about Calibration in "[How to Perform a Calibration](#)" on page 135
9. Connect the cable to be tested.

NOTE

Low-level standing waves (also known as 'ripple') which may be visible in reflection measurements, can hide the actual loss of the cable. Steps 10 through 13 can minimize the ripple. Perform the measurement with and without steps 10 through 13 and choose the method with the least amount of ripple.

10. Connect a LOAD at the end of the cable to be tested. This limits the reflections to faults that are located in the cable under test.
11. Press **Trace 6** then **Math and Memory** then **Data->Mem** to store the trace into Memory.
12. Remove the LOAD and leave the end of the cable to be tested open.

13. Press **Data Math** then **Data – Mem**. The ripple in the measurement is removed. These minor imperfections in the cable should not be considered in the Cable Loss measurement.

14. Use **Averaging** to remove random noise from high-loss measurements. Press **BW 2** then **Average**.

The displayed trace shows the Cable Loss values in one direction through the cable. A Return Loss measurement would show the loss for both down the cable and back. Therefore, a Cable Loss measurement is the same as a Return Loss measurement divided by 2.

The average Cable Loss across the specified frequency range is shown on the screen below the graticules.

2-Port Insertion Loss Measurements

A 2-port Insertion Loss measurement is used to measure the loss through a DUT (device under test) – or cable – over a specified frequency range. The FieldFox signal source is transmitted out the RF OUT connector, through the DUT, and into the RF IN connector. Both ends of the DUT must be connected to the FieldFox, either directly or indirectly using the cable used in the normalization cal.

‘Insertion’ loss simply means **loss** through a device, usually expressed in dB. It is exactly the same measurement as “S21 Transmission” in NA Mode.

NOTE

Exception: In CAT mode, if the TDR data are saved in S1P format, the values represent the real part of the complex transform; the imaginary part is set to zero. To obtain complex data, either as real/imaginary or magnitude/phase pairs, use NA mode.

2-port Insertion Loss measurements are generally more accurate than 1-port Cable Loss measurements.

How to make a 2-port Insertion Loss Measurement

- Press **Mode** then **CAT**.
- Then **More** then **Insertion Loss (2-Port)**.
- Press **Freq/Dist** and enter **Start** and **Stop** frequency values of the measurement.
- Press **Sweep 3**, then select a **Resolution** setting.
- Press **Cal 5**, then perform a calibration. Learn more on [“How to Perform a Calibration” on page 135](#).
- Connect the DUT and view the insertion loss measurement results.

CAT (Cable and Antenna Test) Mode
2-Port Insertion Loss Measurements

When measuring very long lengths of cable, it may be necessary to increase the sweep time. Learn how on [page 62](#). Learn why in the **Supplemental Online Help**: <http://na.support.keysight.com/fieldfox/help/SupHelp/FieldFox.htm>

CAT (Cable and Antenna Test) Mode
2-Port Insertion Loss Measurements

4 DTF (Distance to Fault) Measurements

CAT Mode **Distance to Fault** (DTF) measurements are generally used to locate problems, or faults, in a length of cable or transmission line. In this chapter, the cable to be tested is referred to as the DUT (Device Under Test).

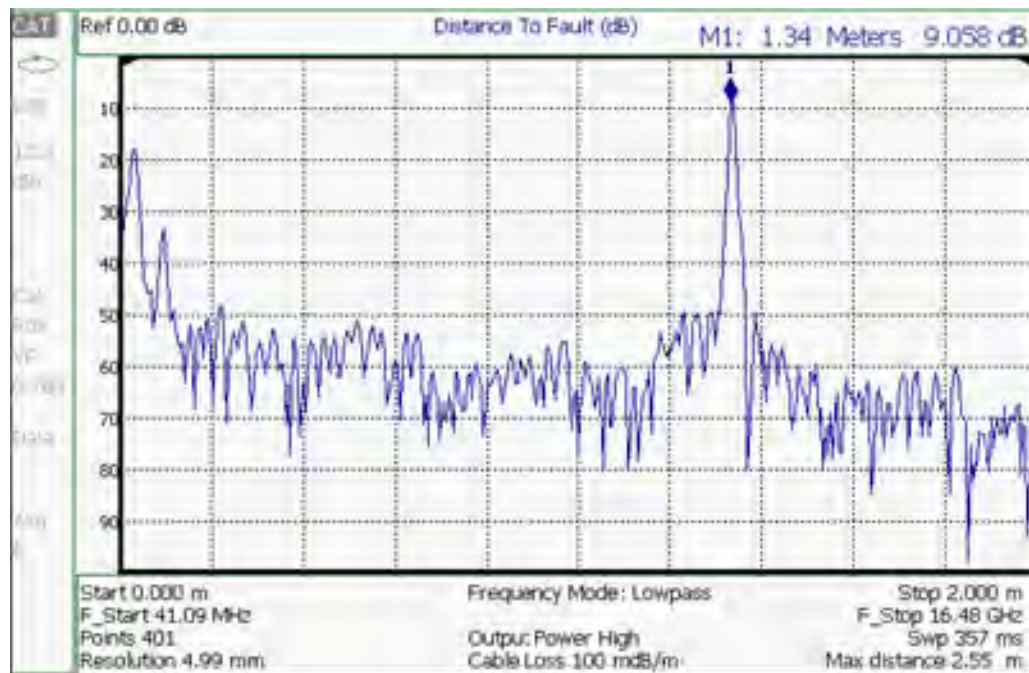

Settings that are NOT unique to DTF measurements are documented in the CAT Mode [Chapter 3, “CAT \(Cable and Antenna Test\) Mode.”](#)

In this Chapter

[“How to make DTF Measurements” on page 72](#)

[“DTF Settings Table” on page 74](#)

[“DTF Measurement \(Format\)” on page 74](#)

[“DTF Start and Stop Distance” on page 75](#)

[“Frequency Mode” on page 75](#)

[“Coupled Frequency” on page 76](#)

[“Cable \(Correction\) Specifications” on page 77](#)

[“Window Settings” on page 80](#)

[“DTF Units” on page 81](#)

[“Calculated DTF values” on page 81](#)

[“About Alias Faults” on page 81](#)

Optional settings

[“All about Markers” on page 692](#)

[“All about Limit Lines” on page 707](#)

[“Saving and Recalling Files” on page 768](#)

Trace Math is NOT available in DTF Measurements.

How to make DTF Measurements

Before starting, you may need the following:

- Jumper cable or adapter to connect the beginning of the DUT to the FieldFox.
- LOAD with correct connector type and gender to terminate the end of the DUT (if possible).
- The known length and cable type of the DUT. If the cable type is not known, then the Cable Loss (dB/Meter) and Velocity Factor of the DUT are required.

1. Connect any necessary jumper cable or adapter to the FieldFox RF OUT port. Do NOT connect the DUT.
2. Press **Preset** then **Preset** to return the FieldFox to the default settings.
3. Then **Mode** then **CAT**.
4. Then **Meas 1** then **DTF**.
5. Press **Freq/Dist**, then **Stop Distance** and enter the length of the DUT. You can optionally set the Start Distance
6. Press **Cal 5** and follow the Cal prompts. Learn all about Calibration in [“How to Perform a Calibration” on page 135](#).
7. Disconnect any components or antenna that should NOT be measured and connect a LOAD at the end of the DUT.
8. Press **Meas Setup 4** then **DTF Cable Specifications**.

DTF (Distance to Fault) Measurements
How to make DTF Measurements

9. Either press **Edit/Save/Recall Cables** then **Recall Cable**, or directly enter the Velocity Factor/Cable Loss of the DUT using the **Velocity Factor** and **Cable Loss** keys.
10. Connect the start end of the DUT to the FieldFox.
11. Press **Meas Setup 4** then **Settings** then **Next Page**. If the **Alias-free Range** setting is False, then you may see Alias faults on the screen. Learn more on [page 81](#).

DTF Measurement Settings

DTF Settings Table

You can set and view all of the DTF settings, including some calculated values, on the DTF Settings table. Learn about the calculated values in **“Calculated DTF values” on page 81**.

How to make settings on the DTF settings table

- Press **Meas Setup 4**.
- Then **Settings**.
- Press **Next Page** and **Previous Page** to view all settings.
- To change a setting:
 - Use the **▲▼** arrows or rotary knob to highlight a setting.
 - Numeric settings can be changed by pressing numbers using the numeric keypad. Then press Enter or select a suffix if available.
 - Other settings require you to press **Edit**, then press a softkey to change the value.
 - When finished changing a value, press **Done Edit**.
- Press **Dock Window** to relocate the Settings table to a position relative to the trace window. The setting persists through a Preset. Choose from the following:
 - **Full (Default setting)** Only the Settings table is shown on the screen. The trace window is temporarily not shown.
 - **Left** The Settings table is shown to the left of the trace window.
 - **Bottom** The Settings table is shown below the trace window.
- When finished changing ALL settings, press **Done** to save your settings.

DTF Measurement (Format)

You can select from 3 different DTF Formats.

- Press **Measure 1**
- Then choose from:
 - **Distance to Fault (dB)** Faults are displayed on the Y-axis in return loss format, expressed as a positive number in dB.
 - **DTF (VSWR)** Faults are displayed on the Y-axis in SWR. Learn more about SWR at the FieldFox Supplemental Online Help: <http://na.support.keysight.com/fieldfox/help/SupHelp/FieldFox.htm>

DTF (Distance to Fault) Measurements DTF Measurement Settings

- **More** then **DTF (Lin)** Faults are displayed on the Y-axis in linear (unitless) format.

DTF Start and Stop Distance

In DTF measurements, you set the physical length of cable or other device to be tested. The FieldFox calculates the frequency range of the measurement from this distance. The longer the cable to be tested, the lower the frequencies that are used. You can also set the frequencies manually using the Frequency Mode [Bandpass] setting.

How to set Start and Stop Distance

- With a DTF measurement present, press **Freq/Dist**.
- Then choose from the following:
 - **Start Distance** Enter a value using the numeric keypad, the **▲▼** arrows, or the rotary knob, then **Enter**. By default, the Start Distance is set to 0 Meters. This means that the measurement will display faults starting at the point at which calibration standards are connected.
 - **Stop Distance** Enter a value between the start distance and 5 km (or 16,404 ft.) using the numeric keypad, the **▲▼** arrows, or the rotary knob, then **Enter**.

Frequency Mode

All DTF measurements are made with frequency settings and, using Inverse Fourier Transform (IFT), the time and distance to faults are calculated.

NOTE

The start and stop frequencies for the measurement are always annotated on the screen below the start and stop distances.

How to set Frequency Mode

With a DTF measurement present,

- Press **Meas Setup 4**
- Then **Frequency Mode**
- Choose one of the following:
 - **Lowpass** The frequency range of a DTF measurement is set automatically based on the Start and Stop Distances. Use Lowpass mode when the DUT is a cable ONLY.

DTF (Distance to Fault) Measurements DTF Measurement Settings

- **Bandpass** (Default setting) The frequency range of a DTF measurement is set manually. Use Bandpass mode when the DUT contains a diplexer or other filtering device which does not pass some frequencies.

Typically, you will set the frequency range of the measurement to the passband of the filter. However, you may also want to test the ability of the filter to reject unwanted frequencies. In this case, set the frequency range to include those frequencies which the filter may not be adequately rejecting.

How to manually set Frequencies in Bandpass Mode

- Press **Freq/Dist**
- Then **Min Start Freq** and type the start frequency to use for the DTF measurement.
- Then **Max Stop Freq** and type the stop frequency to use for the DTF measurement.
- OR
- Press **More**
- Then **Max Freq Span** and type the frequency range to use for the DTF measurement.
- Then **Center Frequency** and type the center frequency of the range to use for the DTF measurement.

When the DTF frequencies are set manually, they may not be the optimum frequencies for measuring the distance to fault. The distance may no longer be alias-free. Learn more about alias-free range on [page 81](#).

These settings specify the minimum and maximum frequencies to be used for the DTF measurement. These exact frequencies may not be used, but a narrower frequency range may be used that will still pass through the bandpass filter.

Coupled Frequency

When a Return Loss & DTF measurement is present, this setting allows you to have different frequency ranges for each measurement. Learn more in [“Coupled Frequency” on page 64](#).

Cable (Correction) Specifications

By default, the FieldFox does NOT correct DTF measurements to account for the inherent loss of a cable. However, to make more accurate DTF measurements, the Cable Loss and Velocity Factor values should be considered.

NOTE

The following describes Coax Media type. However, you can create or edit Waveguide Media Standards. Learn how in [“Waveguide Calibrations” on page 150](#).

About Velocity Factor and Cable Loss

- Velocity Factor is a property of the physical material of a cable. A VF of 1.0 corresponds to the speed of light in a vacuum, or the fastest VF possible. A polyethylene dielectric cable has VF = 0.66 and a cable with PTFE dielectric has VF = 0.7.
- Cable Loss is specified in dB/meter. In addition to the length of the cable, loss is also directly proportional to the frequency of the signal that passes through the cable.

The following is an example showing how DTF cable correction works:

The DUT is a 100 meter transmission cable. The Cable Loss value is 0.1 dB/meter. This means that a signal traveling ONE WAY through the cable will lose 10 dB of power (100 m * 1 dB/m). Because the FieldFox performs this measurement with 1 port, the test signal travels down the cable and then back, for a total loss of 20 dB.

After a calibration has been performed, for the purpose of illustrating this point, connect an OPEN to the end of the cable – a maximum-sized fault – for 100% reflection of the 300 MHz test signal.

Without compensation for the loss of the cable, a –20 dB response would be visible at 100 meters, which is the OPEN at the end of the DUT. This is from 10 dB of loss through the cable in each direction.

With compensation for the loss using the manufacturer’s specification, the FieldFox compensates the trace as though the signal traveling through 100 meters was increased by +20 dB. Therefore the response will show 0 dB for 100% reflection.

How to enter Cable Loss and Velocity Factor

Cable Loss and Velocity factor can be entered using one of the following methods:

- Manually enter cable loss and velocity factor for the measurement.
- Select or create a cable file which contains the cable loss and velocity factor.

With a DTF measurement present:

DTF (Distance to Fault) Measurements
DTF Measurement Settings

- Press **Meas Setup 4**.
- Then **DTF Cable Specifications**
- Select **Cable Corr**
 - **Auto** Use Cable Loss and Velocity Factor values from a Cable file. See “How to Edit, Save, and Recall a Cable File” below. This will overwrite a manually-entered value.
 - **Man** (Default setting) Manually enter a value for Cable Loss and Velocity Factor.
- Then:
 - **Velocity Factor** Using the numeric keypad, enter a value between 0.01 and 1. Then press **Enter**.
 - **Cable Loss** Using the numeric keypad, enter a positive Cable Loss value in dB/m, then press **Enter**.

How to Edit a Cable File

The FieldFox includes many predefined cable files with the manufacturer’s specifications. You can edit these files or create new cable files using the following procedure or using the FieldFox Data Link Software.

The Cable correction data survives a Mode Preset and Preset.

With a DTF measurement present:

- Press **Meas Setup 4**
- Then **DTF Cable Specifications**
- Then **Edit/Save/Recall Cables**
- Press **New Cable** then **Yes** to clear all data from the existing DTF Cable table and reset header information to default settings.
- Then **Edit Cable** to open the Cable Editor.
- Then use the **▲▼** arrows to select a field,
 - When editing Cable Description information, press **Edit** then modify the selected field using the FieldFox labeler.
 - When editing Frequency/Loss pairs, enter numbers using the numeric keypad, then select a frequency suffix. Then **Enter**. Learn more about “How the Freq/Loss pairs are applied” below.
- Optionally choose from the following:
 - **Previous / Next Page** Quickly scrolls through pages of Freq/Loss data.
 - **Add Data** Add a blank Freq/Loss pair to the table,

- **Delete/Clear** then:
- **Delete Row** Remove the selected Freq/Loss pair from the table.
- **Clear All** then **Yes**. Remove all Freq/Loss pairs from the table and resets header information
- Press **Done** to close the Cable Editor.

How to Save or Recall a Cable

- Press **Save Cable** to save your changes to the specified Storage Device. Enter a filename using the FieldFox labeler (learn more on [“How to use the FieldFox labeler ” on page 770](#)). Learn more about Cable files below.
- Press **Recall Cable** to load a Cable file from the specified Storage Device
- **Storage Device** Changes the device used to save or recall Cable files. This is a different setting from the Save/Recall Storage Device setting. Choose from Internal (default setting), **USB** (must be connected) or **SD card**.

About Cable files

- Cable files are saved to, and recalled from, the **Cables** folder. If the folder does not already exist on a USB or SD card, it is created automatically before storing the file.
- Cable files are stored as *.xml files. Existing cable files that are preloaded into the FieldFox firmware can be overwritten. Your edited file will NOT be overwritten when firmware is updated.
- To **DELETE** a Cable file, use the Manage Files feature. Learn more in [“Manage Files” on page 776](#).

How the Freq/Loss pairs are applied

When the cable file contains one Freq/Loss pair, that correction value is applied to the entire displayed frequency span.

When the cable file contains two or more Freq/Loss pairs, the Loss value that is used is interpolated from the Freq/Loss pairs and the DTF center frequency.

For example, using a cable file with the following Freq/Loss pairs:

1 GHz: 0.1 dB/m

2 GHz: 0.2 dB/m

The center frequency for the measurement is determined from the calculated (Stop – Start) frequency values (seen on the second page of DTF Settings):

Calculated Start = 2.0 MHz

Calculated Stop = 3.598 GHz

Center Freq = 1.80 GHz

The Loss value for the measurement is interpolated from the Freq/Loss pairs at the Center Freq:

1 GHz = 0.1 dB/m

1.8 GHz = 0.18 dB/m

2 GHz = 0.2 dB/m

The correction for loss at 5 meters in one direction: $0.18 \text{ dB/m} * 5\text{m} = 0.9 \text{ dB}$.

All DTF measurements correct for loss for travel down the DUT and back, so double the correction: $0.9 \text{ dB} * 2 = 1.8 \text{ dB}$.

Window Settings

Window settings provide the ability to choose between optimizing DTF measurements for resolving closely-spaced faults or for the ability to measure low-level faults.

How to select Window settings

- Press **Meas Setup 4**.
- Then **Settings**.
- Then press **▲▼** arrows to move to the Window row.
- Then press **Edit**.
- Then press **Window** and choose from the following:
 - **Maximum (Maximum – Optimized for dynamic range)** the noise floor is lowered to provide the ability to measure low-level responses. (Default setting)
 - **Medium** – Compromise between Minimum and Maximum window settings.
 - **Minimum** – Best Response Resolution, providing the ability to resolve between two closely-spaced responses.
- Then press **Done Edit**.
- Again press **Done**.

DTF Units

The DTF Units setting is available ONLY on the DTF Settings table.

By default, X-axis units for DTF measurement settings are displayed in Meters.

How to change DTF units

- With a DTF measurement present, press **Freq/Dist**.
- Then **More** then **Distance Unit m feet**.
- The current selection is underlined **m (meters) Feet**.

Calculated DTF values

Press **Next Page** on the DTF Settings Table to view the following **calculated Values** noted on the FieldFox screen with c - <setting>

Start Frequency – Start frequency that is used to calculate DTF.

Stop Frequency – Stop frequency that is used to calculate DTF.

Range Resolution. Indicates the accuracy of the distance to fault measurement. For example, with range resolution of 500 mm, if the distance to fault is 10 meters, this value could be inaccurate by +/- 500 mm or between 9.5 to 10.5 meters. This value is calculated from frequency span / resolution (points).

Response Resolution, not displayed, indicates the distance that could be between two faults and still show as separate faults. Learn more in **“Window Settings” on page 80**.

Maximum Distance. The distance that could be viewed with the current settings. Defined by: $V_f * c * \text{Points} / (2 * \text{Bandwidth})$ where:

- V_f = velocity factor
- c = speed of light
- Points = resolution
- Bandwidth = frequency range

Alias-free Range (On/Off)

- On = No Alias images
- Off = Alias images may appear in the response.

About Alias Faults

An alias fault is not a true device response. An alias fault appears because of the method used to convert frequency to time.

On the DTF Settings page (above) the c - Alias-free Range = Off setting indicates alias images MAY appear on the screen.

Shorter stop distances (less than 10 meters) and a higher resolution (1001 points) will be **more** likely to result in **Alias-free Range = Off**.

When the Alias-free Range = Off, the following procedure will help to determine if a response is true or an alias response:

- 1. Put a marker on the response in question and note the distance to the fault.**
- 2. Change the start or stop distance.**

A true fault response will not move in distance. That is, if a true fault is present at 10.3 meters, changing the stop distance from 15 m to 20 m will not move the fault; the fault will remain at 10.3 meters. However, an alias response will appear to move.

An un-terminated cable (with NO perfect load at the end) will show faults that appear to be beyond the end of the cable. These are NOT alias faults. These faults appear as the signal reflects off the open at the end of the cable and travels back down the cable toward the connection at the FieldFox.

Re-reflections are measured at the FieldFox as mirror images of the original faults. The largest fault is the open end of the cable. To avoid confusion, set the Stop distance shortly after that fault.

5 TDR (Time Domain Reflectometry) - Option 215

CAT Mode **Time Domain Reflectometry (TDR)** measurements are generally used to locate problems, and identify the type of problem, in a length of cable or transmission line.

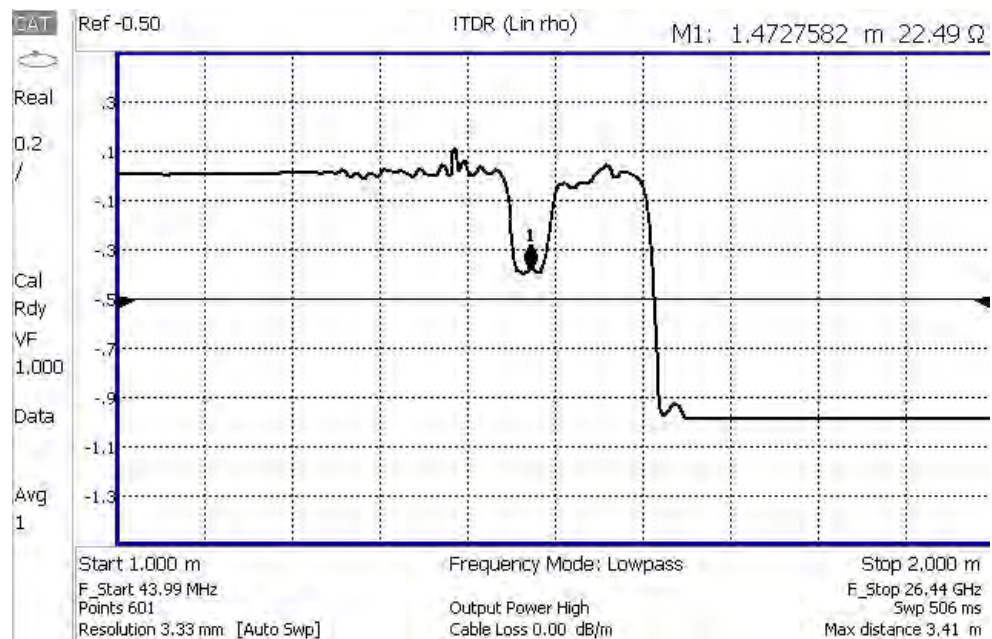

Settings that are NOT unique to TDR measurements are documented in [Chapter 3, "CAT \(Cable and Antenna Test\) Mode", on page 55](#).

In this chapter, the cable to be tested is referred to as the DUT (Device Under Test).

In this Chapter

["TDR Measurement \(Format\)" on page 86](#)

["TDR Settings Table" on page 86](#)

["TDR Start and Stop Distance" on page 87](#)

["TDR Sweep" on page 87](#)

[“Frequency Mode” on page 88](#)

[“Cable \(Correction\) Specifications” on page 89](#)

[“Window Settings” on page 92](#)

[“TDR Units” on page 93](#)

[“Calculated TDR values” on page 93](#)

[“About Alias Faults” on page 94](#)

[“How to Prevent Undersampling” on page 95](#)

Optional Settings

[“All about Markers” on page 692](#)

[“All about Limit Lines” on page 707](#)

[“Saving and Recalling Files” on page 768](#)

Trace Math is NOT available in DTF Measurements.

How to make TDR Measurements

Before starting, you may need the following:

- Jumper cable or adapter to connect the beginning of the DUT to the FieldFox.
- LOAD with correct connector type and gender to terminate the end of the DUT (if possible).
- The known length and cable type of the DUT. If the cable type is not known, then the Cable Loss (dB/Meter) and Velocity Factor of the DUT are required.

1. Connect any necessary jumper cable or adapter to the FieldFox RF OUT port. Do NOT connect the DUT.
2. Press **Preset** then **Preset** to return the FieldFox to the default settings.
3. Then **Mode** then **CAT/TDR**.
4. Then **Meas 1** then **More** then **DTF (Lin)** or **TDR (Lin rho)** or **(ohm)**.
5. Press **Freq/Dist**, then **Stop Distance** and enter the length of the DUT. You can optionally set the **Start Distance**
6. Press **Cal 5** and follow the Cal prompts. Learn all about Calibration in [“How to Perform a Calibration” on page 135](#).
7. Disconnect any components or antenna that should NOT be measured and connect a LOAD at the end of the DUT.
8. Press **Meas Setup 4** then **DTF Cable Specifications**.

9. Either press **Edit/Save/Recall Cables** then **Recall Cable**, or directly enter the Velocity Factor/Cable Loss of the DUT using the **Velocity Factor** and **Cable Loss** keys.
10. Connect the start end of the DUT to the FieldFox.
11. Press **Meas Setup 4** then **Settings** then **Next Page**. If the **Alias-free Range** setting is **Off**, then you may see Alias faults on the screen. Learn more in [“About Alias Faults” on page 94](#)

TDR Measurement Settings

Select CAT Mode, then TDR before making any setting in this chapter.

How to select CAT Mode

- Press **Mode**.
- Then **CAT/TDR**.

TDR Measurement (Format)

You can select from 3 different TDR Formats.

- Press **Measure 1**
- Then **More**.
- Then choose from:
 - **TDR (Lin rho)** The Y-axis of the display is linear, real, unitless values. A trace without reflections shows as 0 (zero). Maximum reflections from an open or short show as 1.
 - **TDR (ohm)** The Y-axis of the display is impedance (ohms).m
 - **DTF (Lin)** The Y-axis of the display is linear, real, unitless values. X-Axis displays distance to fault in meters.
 - TDR & DTF TDR and DTF are displayed.

TDR Settings Table

You can set and view all of the TDR settings, including some calculated values, on the TDR Settings table. Learn more in [“Calculated TDR values” on page 93](#).

How to make settings on the TDR settings table

- Press **Meas Setup 4**.
- Then **Settings**.
- Press **Next Page** and **Previous Page** to view all settings.
- To change a setting:
 - Use the **▲▼** arrows or rotary knob to highlight a setting.
 - Numeric settings can be changed by pressing numbers using the numeric keypad. Then press Enter or select a suffix if available.
 - Other settings require you to press **Edit**, then press a softkey to change the value.
 - When finished changing a value, press **Done Edit**.

- Press **Dock Window** to relocate the Settings table to a position relative to the trace window. The setting persists through a Preset. Choose from the following:
 - **Full (Default setting)** Only the Settings table is shown on the screen. The trace window is temporarily not shown.
 - **Left** The Settings table is shown to the left of the trace window.
 - **Bottom** The Settings table is shown below the trace window.
- When finished changing ALL settings, press **Done** to save your settings.

The following TDR settings are available ONLY on the settings table:

Mkr Format – The format of marker readout. Choose from:

- **Z Magnitude** – Impedance (magnitude only)
- **Default** – The current TDR measurement format.

Auto: Max Freq – When TDR Sweep is set to Auto, this is the maximum stop frequency of the measurement. The minimum value of this setting is 100 MHz.

TDR Start and Stop Distance

In TDR measurements, you set the physical length of the DUT. The FieldFox calculates the frequency range of the measurement from this distance. The longer the DUT, the lower the frequencies that are used.

You can NOT set the frequencies manually in TDR. However, you CAN limit the maximum frequency using the TDR Sweep setting. Learn more in [“TDR Sweep” on page 87](#).

How to set Start and Stop Distance

- With a TDR measurement present, press **Freq/Dist**.
- Then choose from the following:
 - **Start Distance** Enter a value using the numeric keypad, the **▲▼** arrows, or the rotary knob, then **Enter**. By default, the Start Distance is set to **0** Meters. This means that the measurement will display faults starting at the point at which calibration standards are connected.
 - **Stop Distance** Enter a value between the start distance and **5 km** (or 16,404 ft.) using the numeric keypad, the **▲▼** arrows, or the rotary knob, then **Enter**.

TDR Sweep

This setting allows you to choose the method by which the Stop Frequency and Resolution are set.

- Press **Sweep 3**
- Then **TDR Sweep**
- Choose one of the following:
 - **Auto** Low pass frequency settings are calculated based on the current number of points. The Stop Frequency and Resolution settings can be changed to any value.
 - To set Stop Frequency, press **Meas 4**, then **Settings**, then scroll to Auto: Max Freq.
 - To set Resolution, press **Sweep 3**, then **Resolution**.
 - **Cable** Provides a higher resolution measurement. Use when under-sampling is suspected. The Stop Frequency is limited to 500 MHz maximum. The Resolution is fixed to 1601.

NOTE

Because of its greater measurement accuracy, **Cable** is the default setting in CPU1 units with firmware A.08.18 and greater and CPU2 units with firmware A.09.57 and greater. Refer to **“Preferences” on page 733**.

Frequency Mode

All TDR measurements are made with frequency settings and, using Inverse Fourier Transform (IFT), the time and distance to faults are calculated.

NOTE

The start and stop frequencies for the measurement are always annotated on the screen below the start and stop distances.

How to set Frequency Mode

With a TDR measurement present,

- Press **Meas Setup 4**
- Then **Freq Mode**
- Choose one of the following:
 - **Lowpass** The frequency range of a TDR measurement is set automatically based on the Start and Stop Distances. Use Lowpass mode when the DUT is a cable ONLY.
 - **Bandpass** This setting changes the measurement to DTF. Bandpass is NOT ALLOWED with TDR because the DC component is required for TDR measurements.

Cable (Correction) Specifications

By default, the FieldFox does NOT correct TDR measurements to account for the inherent loss of a cable. However, to make more accurate TDR measurements, the Cable Loss and Velocity Factor values should be considered.

NOTE

The following describes Coax Media type. Waveguide Media can NOT be measured with TDR as waveguide is inherently a high pass device.

About Velocity Factor and Cable Loss

- Velocity Factor is a property of the physical material of a cable. A VF of 1.0 corresponds to the speed of light in a vacuum, or the fastest VF possible. A polyethylene dielectric cable has $VF = 0.66$ and a cable with PTFE dielectric has $VF = 0.7$.
- Cable Loss is specified in dB/meter. In addition to the length of the cable, loss is also directly proportional to the frequency of the signal that passes through the cable.

The following is an example showing how DTF cable correction works:

The DUT is a 100 meter transmission cable. The Cable Loss value is 0.1 dB/meter. This means that a signal traveling ONE WAY through the cable will lose 10 dB of power ($100 \text{ m} * 1 \text{ dB/m}$). Because the FieldFox performs this measurement with 1 port, the test signal travels down the cable and then back, for a total loss of 20 dB.

After a calibration has been performed, for the purpose of illustrating this point, connect an OPEN to the end of the cable – a maximum-sized fault – for 100% reflection of the 300 MHz test signal.

Without compensation for the loss of the cable, a -20 dB response would be visible at 100 meters, which is the OPEN at the end of the DUT. This is from 10 dB of loss through the cable in each direction.

With compensation for the loss using the manufacturer's specification, the FieldFox compensates the trace as though the signal traveling through 100 meters was increased by $+20 \text{ dB}$. Therefore the response will show 0 dB for 100% reflection.

How to enter Cable Loss and Velocity Factor

Cable Loss and Velocity factor can be entered using one of the following methods:

- Manually enter cable loss and velocity factor for the measurement.
- Select or create a cable file which contains the cable loss and velocity factor.

With a TDR measurement present:

- Press **Meas Setup 4**.

- Then **DTF Cable Specifications**
- Select **Cable Corr**
 - **Auto** Use Cable Loss and Velocity Factor values from a Cable file. See “How to Edit, Save, and Recall a Cable File” below. This will overwrite a manually-entered value.
 - **Man** (Default setting) Manually enter a value for Cable Loss and Velocity Factor.
- Then:
 - **Velocity Factor** Using the numeric keypad, enter a value between 0.01 and 1. Then press **Enter**.
 - **Cable Loss** Using the numeric keypad, enter a positive Cable Loss value in dB/m, then press **Enter**.

How to Edit a Cable File

The FieldFox includes many predefined cable files with the manufacturer’s specifications. You can edit these files or create new cable files using the following procedure or using the FieldFox Data Link Software.

The Cable correction data survives a Mode Preset and Preset.

With a TDR measurement present:

- Press **Meas Setup 4**
- Then **DTF Cable Specifications**
- Then **Edit/Save/Recall Cables**
- Press **New Cable** then **Yes** to clear all data from the existing DTF Cable table and reset header information to default settings.
- Then **Edit Cable** to open the Cable Editor.
- Then use the **▲▼** arrows to select a field,
 - When editing Cable Description information, press **Edit** then modify the selected field using the FieldFox labeler.
 - When editing Frequency/Loss pairs, enter numbers using the numeric keypad, then select a frequency suffix. Then **Enter**. Learn more about “How the Freq/Loss pairs are applied” below.
- Optionally choose from the following:
 - **Previous / Next Page** Quickly scrolls through pages of Freq/Loss data.
 - **Add Data** Add a blank Freq/Loss pair to the table,
 - **Delete/Clear** then:
 - **Delete Row** Remove the selected Freq/Loss pair from the table.

- **Clear All** then **Yes**. Remove all Freq/Loss pairs from the table and resets header information
- Press Done to close the Cable Editor.

How to Save or Recall a Cable

- Press **Save Cable** to save your changes to the specified Storage Device. Enter a filename using the FieldFox labeler (see **“How to use the FieldFox labeler ” on page 770**). Learn more about Cable files below
- Press **Recall Cable** to load a Cable file from the specified Storage Device
- **Storage Device** Changes the device used to save or recall Cable files. This is a different setting from the Save/Recall Storage Device setting. Choose from Internal (default setting), **USB** (must be connected) or **SD card**.

About Cable files

- Cable files are saved to, and recalled from, the **Cables** folder. If the folder does not already exist on a USB or SD card, it is created automatically before storing the file.
- Cable files are stored as *.xml files. Existing cable files that are preloaded into the FieldFox firmware can be overwritten. Your edited file will NOT be overwritten when firmware is updated.
- To **DELETE** a Cable file, use the Manage Files feature. Learn more in **“Manage Files” on page 776**.

How the Freq/Loss pairs are applied

When the cable file contains one Freq/Loss pair, that correction value is applied to the entire displayed frequency span.

When the cable file contains two or more Freq/Loss pairs, the Loss value that is used is interpolated from the Freq/Loss pairs and the TDR center frequency. For example, using a cable file with the following Freq/Loss pairs:

1 GHz: 0.1 dB/m

2 GHz: 0.2 dB/m

The center frequency for the measurement is determined from the calculated (Stop – Start) frequency values (seen on the second page of TDR Settings):

Calculated Start = 2.0 MHz

Calculated Stop = 3.598 GHz

Center Freq = 1.80 GHz

The Loss value for the measurement is interpolated from the Freq/Loss pairs at the Center Freq:

1 GHz = 0.1 dB/m

1.8 GHz = 0.18 dB/m

2 GHz = 0.2 dB/m

The correction for loss at 5 meters in one direction: $0.18 \text{ dB/m} * 5\text{m} = 0.9 \text{ dB}$.

All TDR measurements correct for loss for travel down the DUT and back, so double the correction: $0.9 \text{ dB} * 2 = 1.8 \text{ dB}$.

Window Settings

Window settings provide the ability to choose between optimizing TDR measurements for resolving closely-spaced faults or for the ability to measure low-level faults.

How to select Window settings

- Press **Meas Setup 4**.
- Then **Settings**.
- Then press **▲▼** arrows to move to the Window row.
- Then press **Edit**.
- Then press **Window** and choose from the following:
 - **Maximum (Maximum – Optimized for dynamic range)** the noise floor is lowered to provide the ability to measure low-level responses. (Default setting)
 - **Medium** – Compromise between Min and Max window settings.
 - **Minimum** – Best Response Resolution, providing the ability to resolve between two closely-spaced responses.
- Then press **Done Edit**.
- Again press **Done**.

Network Analyzer Windows Frequency Span and TDR Window Selection for Step Rise Time (Approximated)

The following table shows the approximated relationship between the frequency span and the window selection for impulse width and step rise time. Refer to [Figure 5-1 on page 93](#).

Window	Low-pass step (10% to 90%)	Low-pass impulse	Bandpass impulse
Minimum	0.45 / f span	0.60 / f span	1.20 / f span
Medium	0.99 / f span	0.98 / f span	1.95 / f span
Maximum	1.48 / f span	1.39 / f span	2.77 / f span

Figure 5-1 Network Analyzer TDR Rise Time

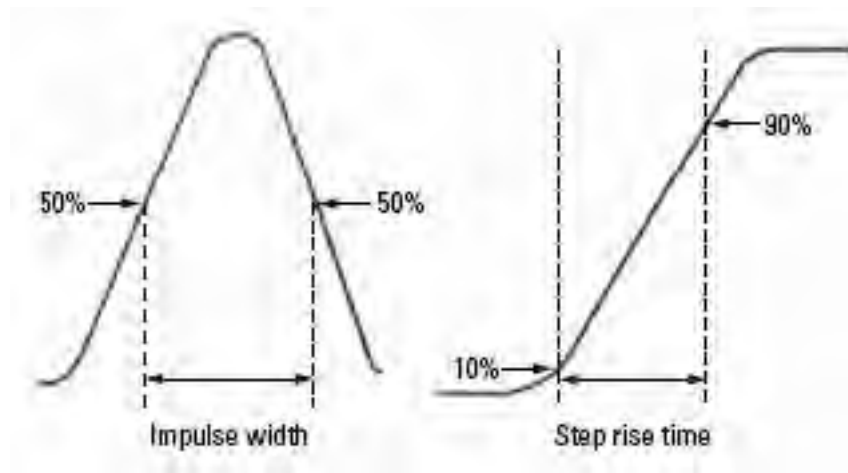

TDR Units

By default, X-axis units for TDR measurement settings are displayed in Meters.

How to change TDR units

- With a TDR measurement present, press **Freq/Dist.**
- Then **More** then **Distance Unit m feet.**
- The current selection is underlined **m (meters) Feet.**

The TDR Units setting is also available on the TDR Settings table.

Calculated TDR values

Press **Next Page** on the TDR Settings Table to view the following **calculated Values** noted on the FieldFox screen with c - <setting>

Start Frequency – Start frequency that is used to calculate TDR.

Stop Frequency – Stop frequency that is used to calculate TDR.

Range Resolution. Indicates the accuracy of the distance to fault measurement. For example, with range resolution of 500 mm, if the distance to fault is 10 meters, this value could be inaccurate by +/- 500 mm or between 9.5 to 10.5 meters. This value is calculated from frequency span / resolution (points).

Response Resolution, not displayed, indicates the distance that could be between two faults and still show as separate faults. Learn more in Window Settings in **“Window Settings” on page 92.**

Maximum Distance. The distance that could be viewed with the current settings. Defined by: $V_f * c * \text{Points} / (2 * \text{Bandwidth})$ where:

- V_f = velocity factor
- c = speed of light
- Points = resolution
- Bandwidth = frequency range

Alias-free Range (On/Off)

- On = No Alias images
- Off = Alias images may appear in the response.

About Alias Faults

An alias fault is not a true device response. An alias fault appears because of the method used to convert frequency to time.

On the TDR Settings page (above) the **c - Alias-free Range = Off** setting indicates alias images MAY appear on the screen.

Shorter stop distances (less than 10 meters) and a higher resolution (1001 points) will be more likely to result in **Alias-free Range = Off.**

When the Alias-free Range = Off, the following procedure will help to determine if a response is true or an alias response:

- 1. Put a marker on the response in question and note the distance to the fault.**
- 2. Change the start or stop distance.**

A true fault response will not move in distance. That is, if a true fault is present at 10.3 meters, changing the stop distance from 15 m to 20 m will not move the fault; the fault will remain at 10.3 meters. However, an alias response will appear to move.

An un-terminated cable (with NO perfect load at the end) will show faults that appear to be beyond the end of the cable. These are NOT alias faults. These faults appear as the signal reflects off the open at the end of the cable and travels back down the cable toward the connection at the FieldFox. Re-reflections are measured at the FieldFox as mirror images of the original faults. The largest fault is the open end of the cable. To avoid confusion, set the Stop distance shortly after that fault.

How to Prevent Undersampling

Undersampling is when the TDR measurement is inaccurate because the frequency step size (resolution) is too large. The predominant symptom of this is when the measured impedance is incorrect. For example, when measuring a 75Ω cable, a marker that is on a part of the trace without reflections shows 56Ω.

To prevent undersampling, set **TDR Sweep** to **Cable**. If undersampling still occurs, set **TDR Sweep** to **Auto**. Then set **Auto Max Frequency** to a lower value. Manually increase the Resolution so that the Start Frequency setting is less than about 500 kHz.

TDR (Time Domain Reflectometry) - Option 215
TDR Measurement Settings

6 NA (Network Analyzer) Mode

Learn more about NA Mode measurements in the FieldFox Supplemental Online Help:

<http://na.support.keysight.com/fieldfox/help/SupHelp/FieldFox.htm>.

In this Chapter

- “About S-parameters” on page 99
- “Mixed-Mode S-Parameters” on page 100
- “Parameter Conversion” on page 101
- “Receiver Measurements” on page 102
- “Multi-Trace Configurations” on page 103
- “Quick Settings” on page 104
- “Calibration Settings” on page 105
- “Format” on page 106
- “Frequency Range” on page 107
- “Scale Settings” on page 107
- “Magnitude Offset” on page 108
- “Electrical Delay” on page 109
- “Phase Offset” on page 109
- “Averaging” on page 110
- “IF Bandwidth” on page 111
- “Smoothing” on page 111
- “Single or Continuous Measure” on page 112
- “Resolution (Number of Data Points)” on page 112
- “Sweep Time” on page 113
- “Output Power” on page 115
- “System Impedance (Z0)” on page 116

“Port Extensions” on page 116

“Velocity Factor” on page 117

“Increase Dynamic Range” on page 120

See Also

“Why and When to Calibrate” on page 134

“All about Markers” on page 692

“All about Limit Lines” on page 707

“All about Trace Math” on page 712

Learn how to make 75Ω (ohm) Measurements in the Supplemental Online Help:

<http://na.support.keysight.com/fieldfox/help/SupHelp/FieldFox.htm>

NA Mode Settings

Select NA Mode before making any setting in this chapter.

How to select NA Mode

- Press **Mode**.
- Then **NA**.

About S-parameters

S-parameters (scattering parameters) are used to describe the way a device modifies a signal. The FieldFox can measure **four S-parameters**. The syntax for each parameter is described by the following:

S (out | in)

out = FieldFox receiver port

in = FieldFox source port

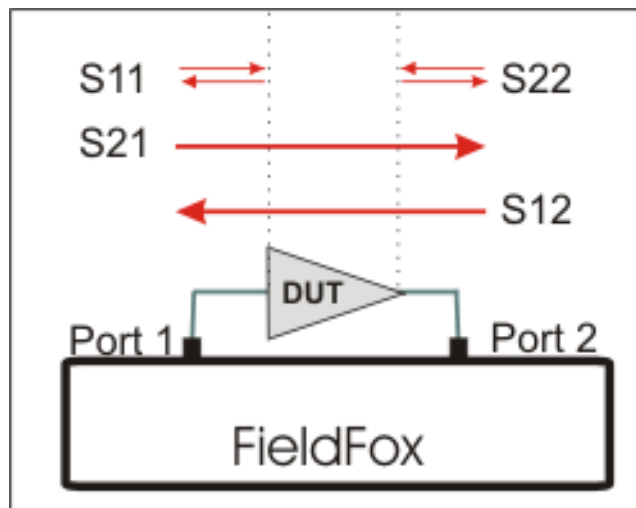

The FieldFox automatically switches the internal source and receivers to make both forward and reverse measurements. Therefore, the FieldFox can measure all four S-parameters with a single connection

When the source comes from port 1, the measurement is said to be in the forward direction

When the source comes from port 2, the measurement is said to be in the reverse direction

S11 and S22 reflection measurements are used to measure the amount of reflections off the corresponding DUT port. Low reflections means there is a good impedance match between the source and DUT.

S21 and S12 transmission measurements are used to measure the loss or gain through a DUT over a specified frequency range. Both ends of the DUT must be connected to the FieldFox. The FieldFox signal source is transmitted out one of the test port connectors, through the DUT, and into the other test port connector

How to measure S-parameters

1. Press **Preset** then **Mode Preset (Factory)**
 2. Press **Measure 1** then choose from the following:
 - **S11** Reflection measurement at port 1.
 - **S21** Forward 2-port transmission measurement.
 - **S12** Reverse 2-port transmission measurement. May require an option.
 - **S22** Reflection measurement at port 2. May require an option.
- OR** select a multi-trace configuration. Learn more on [“Multi-Trace Configurations” on page 103](#)
3. Press **Freq/Dist** then either **Start** and **Stop** or **Center** and **Span** to enter a Frequency Range for the measurement.
 4. Press **BW 2** then **IFBW** to select the IF Bandwidth for the measurement. Narrower bandwidths require more time to sweep, but lowers trace noise.
 5. Press **Sweep 3** then **Resolution** to select the number of data points for the measurement. More data points require more time to sweep.
 6. Press **Cal 5** to calibrate the measurement. Learn more in [“How to Perform a Calibration” on page 135](#).
 7. All other settings can be made AFTER calibration without compromising measurement accuracy.

Mixed-Mode S-Parameters

In NA Mode ONLY, mixed-mode S-parameters (also known as Balanced measurements) are available with Option 212.

Because the FieldFox has only two test ports, only reflection measurements are available. Connect the balanced input or output of your DUT to the FieldFox ports 1 and 2

For highest accuracy, a Full 2-port calibration is required.

All FieldFox settings and features are supported (except Parameter Conversion) with mixed-mode S-parameters.

NOTE

Learn more about Balanced Measurements with the FieldFox in the FieldFox Supplemental Online Help:

<http://na.support.keysight.com/fieldfox/help/SupHelp/FieldFox.htm>

How to make mixed-mode S-parameter measurements

- Press **Measure 1**.
- Then **More**.
- Then choose from the following:
 - **Sc11** Common reflect/common incident for logical port 1.
 - **Sdd11** Differential reflect/differential incident for logical port 1.
 - **Sdc11** Differential reflect/common incident for logical port 1.
 - **Scd11** Common reflect/differential incident for logical port 1.

To make balanced reflection measurements at the DUT output, connect the DUT output to the FieldFox ports.

Parameter Conversion

In NA Mode ONLY, converts the active S-parameter trace to an equivalent impedance (Z), admittance (Y), or reciprocal 1/S-parameter

How to select parameter conversions

- Press **Measure 1**
- Then select an S-parameter
- Then **More**
- Then **Conversion**
- Then choose from the following:
 - **Off** (default) No conversion is performed.
 - **Z Conv (--)** or **Y Conv (--)** Perform conversion for impedance (Z) or admittance (Y). Then choose from the following for either:
 - **Auto** The displayed S-parameter is converted to the appropriate Z or Y parameter: Refl for S11 and S22; Trans for S21 and S12. When the S-parameter is changed, the appropriate conversion changes automatically.
 - **Refl** The displayed S-parameter is converted to Z or Y reflection, regardless of whether the S-parameter is reflection (S11 or S22) or transmission (S21 or S12).

- **Trans** The displayed S-parameter is converted to Z or Y transmission, regardless of whether the S-parameter is reflection (S11 or S22) or transmission (S21 or S12).
- **1/S** The displayed S-parameter is converted to 1/S-parameter.

Receiver Measurements

In NA Mode ONLY, you can make unratioed, uncorrected receiver measurements. These measurements are typically used as diagnostic tools for service personnel.

NOTE

Receiver measurements are NOT corrected for absolute power. They are only useful for making relative measurements. The Y-Axis and markers are labeled in dB - NOT dBm. Specifically, R1 and R2, do NOT indicate the actual power levels out of the source ports.

How to make receiver measurements

- Press **Measure 1**
- Then **More**, then **Advanced**
- Then choose from the following:

A Port-1 test port (*1)

B Port-2 test port (*2)

R1 Port-1 reference receiver (*1)

R2 Port-2 reference receiver (*2)

(*) indicates the Auto-selected source port for the measurement

Source Port The FieldFox port to provide the source signal. Choose from the following:

- **Auto** The FieldFox sets the source port based on the selected receiver.
- **Port 1** Select when measuring transmission at B receiver.
- **Port 2** Select when measuring reverse transmission at A receiver.

Learn more about Raw Receiver Measurements at the FieldFox Supplemental Online Help:

<http://na.support.keysight.com/fieldfox/help/SupHelp/FieldFox.htm>

Multi-Trace Configurations

In NA Mode you can display multiple traces on the FieldFox screen.

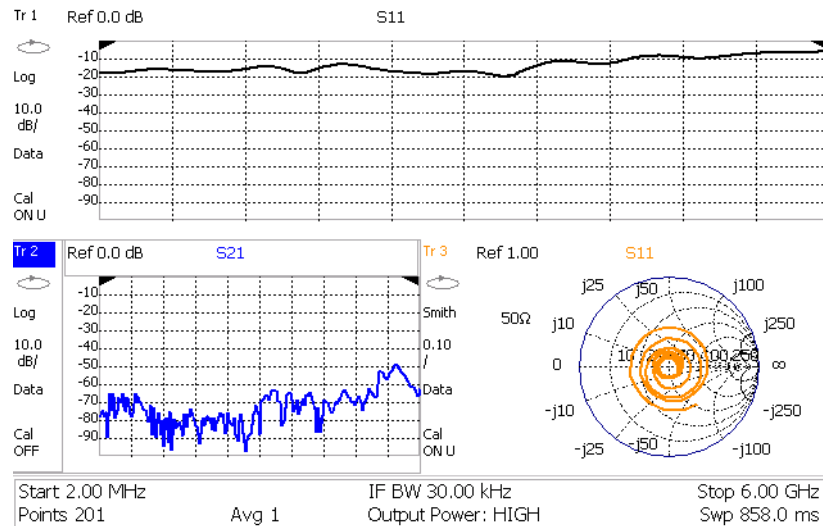

The graphic above shows a x3H configuration. Tr2 is the ACTIVE trace as indicated by the highlighted **Tr2**.

Trace Setting Notes

- The Frequency Range, IF BW, Resolution, Average, and Output Power settings are common for all displayed traces.
- All other trace settings, such as measurement, format, and limit lines, are applied individually to the ACTIVE trace in the same manner as when a single trace is present.

NOTE

IMPORTANT! For CAT and NA modes, limit lines do not apply where $F1 = F2$.

- By default, a marker is created on ALL traces. However, they can be created individually by disabling Coupled Markers. Learn more in [“Coupled Markers \(NA Mode\)” on page 695](#).

How to select a multi-trace configuration

- Press **Trace 6**
- Then **Num of Traces**
- Then choose from the following:
The default measurements depend on the options that are installed

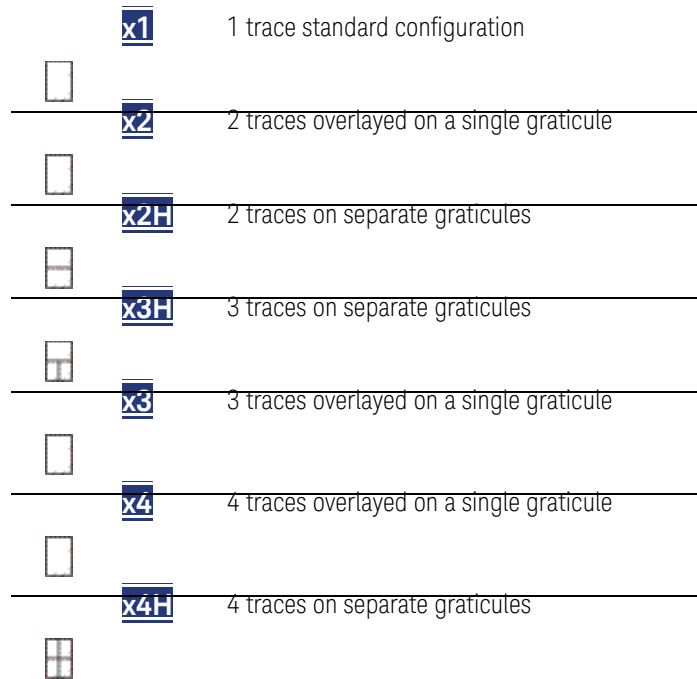

How to activate a trace in order to change a setting

- Use the **▲▼** arrows **OR**
- Press **Trace 6** then select **Trace 1**, **Trace 2**, **Trace 3**, or **Trace 4**. Only traces that are shown can be activated.

How to maximize the viewing of the active trace

- Press **System 7**
- Then **Full Screen**.
- Press any key to return to the standard display.

Quick Settings

Both CAT and NA Modes allow you to view and change most relevant settings from a single location. All of these settings are discussed in this chapter and, unless otherwise noted, ALL of these settings can also be made using the standard softkey menus.

How to view and change Quick Settings

- Press **Meas Setup 4**.
 - Then **Settings**.
 - Press **Next Page** and **Previous Page** to view all settings. If these softkeys are NOT available, then all available settings fit on one page.
 - To change a setting:
 - Use the **▲▼** arrows to highlight a setting.
 - Then press **Edit**. The current setting changes to **yellow**.
 - Some settings require you to press a softkey to change the value. Otherwise, use the numeric keypad, **▲▼** arrows, or rotary knob to change the value.
 - When finished changing a value, press **Done Edit**.
 - Press **Dock Window** to relocate the Settings table to a position relative to the trace window. The Dock Window setting persists through a Preset. Choose from the following:
 - **Full (Default setting)** Only the Settings table is shown on the screen. The trace window is temporarily not shown.
 - **Left** The Settings table is shown to the left of the trace window.
 - **Bottom** The Settings table is shown below the trace window.
- When finished changing ALL settings, press **Done** to save your settings.

Calibration Settings

NA Mode has a page specifically for making settings that pertain to Port Extensions, including Velocity Factor and Media Type.

Learn more in **“Port Extensions” on page 116**.

Learn more about Media Type in **“Waveguide Calibrations” on page 150**.

See also, **Chapter 8** “Calibration for NA, CAT, and VVM Modes” and to **“Apply Nearest (NA Mode Only)” on page 155**.

How to view and change Calibration Settings

- Press **Meas Setup 4**.
- Then **Calibration Settings**.
- Make these settings in the same manner as Quick Settings in the previous section.

Format

Select the display format in which to present measurement results. This setting can be changed at any time without affecting calibration accuracy.

NOTE

Learn more about Display Formats in the FieldFox Supplemental Online Help:

<http://na.support.keysight.com/fieldfox/help/SupHelp/FieldFox.htm>

The marker on screen readout can be changed to formats other than the display format. Learn more in “**Marker Format**” on page 697.

How to select a NA Format

- Press **Measure 1**.
- Then **Format [current setting]**.
- Then choose from the following:
 - **Log Magnitude** Displays magnitude in dB
 - **Linear** Displays positive values only. Y-axis: Unitless (U) for ratioed measurements; Watts (W) for unratioed measurements.
 - **VSWR** Used mainly for S11 and S22. Displays unitless reflection data.
 - **Phase** Displays phase in degrees. The trace ‘wraps’ every 360 degrees, from +180 to –180, for easy scaling.
 - **Smith** Used mainly for S11 and S22, which are plotted on a Smith Chart. Displays series resistance and reactance.
 - **More** then...
 - **Polar** Used mainly for S11 and S22. Displays magnitude and phase of the reflection coefficient.
 - **Group Delay** Used mainly for S21 and S12. Displays signal transmission (propagation) time through a device in seconds. The Group Delay aperture is the current Smoothing aperture. Default is 1.5% of the X-axis.
 - Learn how to set Smoothing aperture on “**Smoothing**” on page 111.
 - Learn more about Group Delay measurements at the FieldFox Supplemental Online Help:
<http://na.support.keysight.com/fieldfox/help/SupHelp/FieldFox.htm>
 - **Real** Displays only the real (resistive) portion of the measured complex data. The Y-axis is Unitless. Often used for Time Domain measurements.

- **Imaginary** Displays only the reactive portion of the measured complex data. The Y-axis is Unitless.
- **Z Magnitude** Displays the effective impedance in ohms.
- **Unwrap Phase** Same as Phase, but without 180 degree wrapping.

NOTE

Phase is unwrapped by comparing the phase from one data point to the next. If the phase difference between two data points is greater than 180 degrees, or if the phase of the first data point is greater than 180 degrees from DC, then the phase measurement is probably NOT accurate. To ensure that the phase measurement is accurate, increase the resolution setting. When making a narrow band measurement, reduce the start frequency for the unwrapped phase measurement to ensure the first data point is less than 180 degrees from DC.

Frequency Range

Set the range of frequencies over which you would like to make measurements.

When the frequency range is changed after a calibration is performed, the cal becomes interpolated. Learn more in [“Interpolation *” on page 153](#).

How to set Frequency Range

This can be done in two ways:

- Press **Freq/Dist**
- Then choose from the following:
 - **Start** and **Stop** frequencies – Specify the beginning and end of the sweep.
 - **Center** and **Span** frequencies – Specify the center frequency and span of frequencies (half on either side of center).
- Follow each by entering a value using the numeric keypad, the **▲▼** arrows, or the rotary knob.
- After using the **▲▼** arrows or the rotary knob, press **Enter**. The increment setting of the arrows is based on the current span and can NOT be changed in NA Mode.
- After using the keypad, select a multiplier key. Learn more in [“Multiplier Abbreviations” on page 53](#).

Scale Settings

Adjust the Y-axis scale to see the relevant portions of the data trace. The Y-axis is divided into 10 graticules.

This setting can be changed at any time without affecting calibration accuracy.

How to set Scale

- Press **Scale / Amptd**.
- Then choose from the following method
 - **Autoscale** Automatically adjusts the Y-axis to comfortably fit the Minimum and Maximum amplitude of the trace on the screen.
 - **Autoscale All** Autoscales all of the traces on the screen, useful only for multi-trace configurations.
 - 3. Set Scale, acquisition, and Reference Position
 - **Scale** Manually enter a scale per division to view specific areas of the trace.
 - **Ref Level** Manually set the value of the reference line. Enter a negative value by pressing **Run/Hold (+/-)** either before or after typing a value.
 - **Ref Pos** Manually set the position of the reference line. Values must be between 0 (TOP line) and 10 (BOTTOM line)

Scale annotation on the FieldFox screen

- Reference Line = red arrow
- Ref Level = -40 dB
- Ref Position = 1
- Scale = 2 dB per division

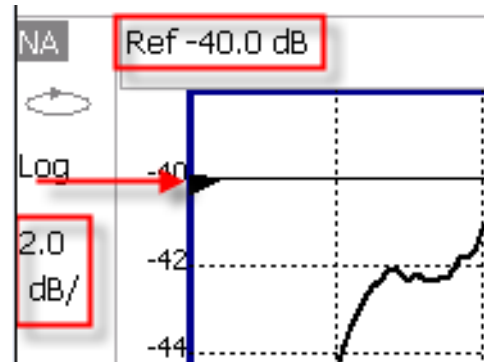

Magnitude Offset

Magnitude Offset allows you to offset the magnitude (not phase) data by a fixed and/ or sloped value in dB. If the display format is Linear Magnitude or Real (unitless), the conversion from dB is performed and the correct amount of offset is implemented.

The Magnitude offset setting affects only the active trace.

How to set Magnitude Offset

- Press **Scale / Amptd**
- Then **More**
- Then **Magnitude Offset** - Offsets the entire data trace by the specified value.

- Then enter a positive or negative offset value in dB using the numeric keypad, the **▲▼** arrows, or the rotary knob. Press a multiplier key. Learn about multiplier abbreviations.
- And/or press **Slope** - Offsets the data trace by a value that changes linearly with frequency. The offset slope begins at 0 Hz. and continues to the stop frequency. The offset value at the start frequency is then calculated from 0 Hz.
- Then enter a positive or negative offset slope value in dB/GHz using the numeric keypad, the **▲▼** arrows, or the rotary knob. Press a multiplier key. Learn about multiplier abbreviations in **“Multiplier Abbreviations” on page 53.**

Electrical Delay

Electrical delay is a mathematical function that simulates a variable length of lossless transmission line. Use the electrical delay feature to compensate for the linear phase shift through a device and view only the deviation from linear phase of the device.

You can set the electrical delay independently for each measurement trace. To apply an electrical delay to all measurement traces, use Port Extensions. Learn how in **“Port Extensions” on page 116.**

Learn how to set Phase formats in **“Phase Offset” on page 109.**

How to set Electrical Delay

- Press **Scale / Amptd**
- Then **More**
- Then **Electrical Delay**
- Enter a time value using the numeric keypad, the **▲▼** arrows, or the rotary knob.
- Press a multiplier key. Learn about multiplier abbreviations in **“Multiplier Abbreviations” on page 53.**

Electrical Delay can also be set using the **Mkr->Delay** feature. Learn how on **“Marker Functions” on page 705.**

Phase Offset

Phase offset mathematically adjusts the phase measurement by a specified amount, up to 360°. Use this feature in the following ways:

Improve the display of a phase measurement. This is similar to the way you would change the acquisition in an amplitude measurement. Change the phase response to center or the response on the screen.

Emulate a projected phase shift in your measurement. For example, if you know that you need to add a cable and that the length of that cable will add a certain phase shift to your measurement, you can use phase offset to add that amount and simulate the complete device measurement.

You can set the phase offset independently for each measurement trace.

How to set Phase Offset

- Press **Scale / Amptd**
- Then **More**
- Then **Phase Offset**
- Enter a value in degrees using the numeric keypad, the **▲▼** arrows, or the rotary knob. Press **Enter**

Averaging

Averaging helps to reduce the effects of random noise on a measurement. You specify the number of measurements to be averaged. The more measurements averaged, the greater the amount of noise reduction. An average counter is shown in the left edge of the screen as Avg <n> where <n> is the number of measurements that are averaged.

Averaging can be set before or after calibration. When set before calibration, each calibration standard is measured <n> times and averaged. More time is needed to perform the calibration, but there will be less noise in the resulting error terms which means that subsequent measurements will also have less noise. In addition, noise is further reduced by continuing to average after calibration.

How to set Averaging

- Press **BW 2**.
- Then **Average <n>** where <n> is the number of measurements to average.
- Enter a value using the numeric keypad. Enter 1 for NO averaging.
- Press **Enter**.
- Then **Average Mode** Choose from the following:
 - **Sweep** - Each data point is based on the average of the same data point being measured over <n> consecutive sweeps. The average counter shows the number of previous sweeps that have been averaged together to form the current trace. When the counter reaches the specified count, then a 'running average' of the last <n> sweeps is displayed.

- **Point** - Each data point is measured <n> times and averaged before going to the next data point. On subsequent sweeps, averaging restarts by measuring each data point again <n> times. The average counter is not updated because data is not displayed until all the averages have been applied.
- **Point averaging is usually faster than sweep averaging.** However, you may need to increase the Point Average count to obtain the same level of noise reduction as with sweep averaging.
- While averaging is in process, press **Sweep 3** then **Restart** to restart the averaging at 1.

IF Bandwidth

The FieldFox converts the received signal from its source to a lower intermediate frequency (IF). The bandwidth of the IF bandpass filter is adjustable. Reducing the IF receiver bandwidth reduces the effect of random noise on a measurement. However, narrower IF bandwidths cause longer sweep times.

How to set IF BW

- **Press BW 2.**
- Then **IF BW**
- Then choose from the following:
- **10 Hz | 100 Hz | 1 kHz | 10 kHz | 100 kHz**
More 30 Hz | 300 Hz | 3 kHz | 30 kHz

Smoothing

Trace smoothing averages a number of **adjacent** data points to smooth the peak-to-peak noise values on a displayed trace. The number of adjacent data points that are averaged is known as the smoothing aperture. Aperture is set by specifying a percentage of the X-axis span.

Trace smoothing does NOT significantly increase measurement time.

Smoothing is used in Group Delay measurements, although it can be used with any NA format EXCEPT Polar or Smith Chart. Learn more about NA Mode formats, including Group Delay, in **“Format” on page 106**.

When enabled, **Smo** appears on the FieldFox screen.

How to set Smoothing

- **Press BW 2**
- Then **Smoothing ON OFF**
- Then **Sm. Aperture** and enter a value between 0 and 25 (percent) using the numeric keypad.

- Press **Enter**

Single or Continuous Measure

This setting determines whether the FieldFox sweeps continuously or only once each time the **Single** button is pressed. Use Single to conserve battery power or to allow you to save or analyze a specific measurement trace.

This setting can be changed at any time without affecting calibration accuracy.

How to set Single or Continuous

- Press **Sweep 3**.
- Then choose one of the following:
 - **Single** Automatically sets Continuous OFF and causes FieldFox to make ONE sweep, then hold for the next Single key press. Hold is annotated in the upper left corner of the display when NOT sweeping, and changes to an arrow --> while the sweep occurs.
 - **Continuous** Makes continuous sweeps. This is the typical setting when battery power is not critical.
- You can also use **Run / Hold +/-** to toggle between Single and Continuous.

Resolution (Number of Data Points)

Data points are individual measurements that are made and plotted across the X-axis to form a trace. Select more data points to increase measurement resolution. However, more data points also takes more time to complete an entire measurement sweep.

When the Resolution is changed after a calibration is performed, the cal becomes interpolated. Learn more in **“Interpolation *” on page 153**.

How to set Resolution

- Press **Sweep 3**.
- Then **Resolution**.
- Then choose from the following:
101 | **201** | **401** | **601** | **801** | **1001** | **1601** | **4001** | **10001**.
- Using SCPI, Resolution can be set to ANY number of points between 3 and 10001. See the Programming Guide at <http://na.support.keysight.com/fieldfox/help/Programming/webhelp/FFPprogrammingHelp.htm>

Sweep Time

The fastest possible sweep time is always used as the default setting. Use the Min Swp Time setting to slow the sweep time when measuring long lengths of cable. Learn more at the FieldFox Supplemental Online Help:

<http://na.support.keysight.com/fieldfox/help/SupHelp/FieldFox.htm>

The actual sweep time is shown on the FieldFox screen. See the Screen Tour on **“Screen Tour” on page 51**. To increase the sweep time, enter a value that is higher than the actual sweep time. The increase will not be exactly the amount that you enter, as the actual sweep time is the composite of many factors.

NOTE

Measurement speed specifications do NOT apply in Temperature Control Mode. Learn more in **“Temperature Control Mode” on page 41**.

How to set Sweep Time

- Press **Sweep 3**.
- Then **Min Swp Time**.
- Enter a value using the numeric keypad.
- Press a multiplier key. Learn about multiplier abbreviations in **“Multiplier Abbreviations” on page 53**.

Triggering

External triggering (NA and SA modes ONLY) allows you to initiate a sweep when an external DC voltage is sensed at the Ref In/Trig In connector on the FieldFox top panel. See External Triggering for SA Mode in **“Triggering” on page 202**.

Trigger Source

- Press **Sweep 3**
- Then **Trigger**
- Then **Trig Source**
- Then choose from the following:
 - **Int** (Internal) Sweeps are initiated by the FieldFox internal circuitry. When Sweep is set to Continuous, a new sweep begins automatically when the previous sweep ends.
 - **Ext** (External) A sweep is initiated on the rising or falling edge of an external TTL signal at the Ref In/Trig In connector on the FieldFox top panel.
 - When the FieldFox is armed for an external trigger signal, **Wait** is annotated on the display.

- A sweep can NOT be initiated by an external signal while a sweep is in progress.
- A sweep can NOT be initiated by an external signal when in HOLD mode. Learn more about HOLD mode in.
- **Pnt** (Point) An external trigger type that acquires exactly one point per trigger input.

CAUTION

IMPORTANT!

If trigger signals come faster than the FieldFox can process them, some triggers may be ignored or lost.

NOTE

To ensure triggers are recognized and processed in order, use the external trigger output function to indicate when the FieldFox is ready for another input trigger. Alternatively, slow the external triggers coming in from external equipment to a rate where FieldFox does not miss a trigger.

The External Trigger output signal is only selectable when Point Mode Trigger is enabled. Not supported in other trigger modes.

External Trigger output signal is sent as soon as FieldFox has processed the last trigger signal that was detected.

As each point is acquired, the data will show up on screen. If a trigger has not been detected, a yellow **Wait** indicator will show on the sweep status icon area.

- When the FieldFox is armed for an external trigger signal, **Wait** is annotated on the display.
- A sweep can NOT be initiated by an external signal when in HOLD mode. Learn more about HOLD mode in.

Error Handling and Recovery

- Point Mode trigger is not compatible with sweep setups that require forward and reverse sweeps such as:
 - Full 2port cal
 - Cal ready (Full 2Port)
 - Multiple displayed parameters that include the requirement for forward and reverse sweeps such as S11 and S22 together on the display
- When point mode trigger is already enabled, if conditions are changed requiring forward and reverse sweeps, an error "Error: Point trigger not compatible with 2-port cal." will be displayed and point mode

trigger will revert to Internal trigger. This includes turning on a CAL that requires forward and reverse sweeps or displaying multiple parameters that would require forward and reverse sweeps.

- If the FieldFox is in a state requiring two sweeps and the user selects point mode triggering, an error "Error: Point trigger not compatible with 2-port cal." will be displayed and point mode trigger will revert to Internal trigger.

Trigger Slope

Determines which edge of an External trigger signal initiates a sweep.

- Press **Sweep 3**
- Then **Trigger**
- Then **Trig Slope**
- Then choose from the following:
 - **Positive** Sweep is initiated by the rising edge of signal at about 1.7 V.
 - **Negative** Sweep is initiated by the falling edge of signal at about 1.0 V.

Output Power

Set the power level out of the FieldFox to High, Low, or manually set power level to a value between High and Low.

Generally, the high power setting is used when measuring passive, high-loss devices to place the signal farther from the noise floor. However, for devices that are sensitive to high power levels such as amplifiers, use the Low power setting.

For best measurement accuracy, use the Manual power setting at -15 dBm. After calibration, the power level can be decreased for amplifiers, or increased for higher dynamic range.

CAUTION

Power Level settings in this mode will NOT change Power Level settings in other modes. To help prevent damage to your DUT, use caution when changing modes with your DUT connected to the FieldFox test ports.

How to set Output Power

- Press **Meas Setup 4**.
- Then **Output Power**
 - **High** Sets output power to the maximum achievable power at all displayed frequencies. Output power is NOT FLAT across the displayed FieldFox frequency span. Please see "**Specifications/Data Sheet**" on page 819 for expected power levels.

- **Low** Sets output power to approximately -50 dBm, FLAT across the displayed FieldFox frequency span.
- **Man** (default setting at -15 dBm) Set output power to an arbitrary value, FLAT across the displayed FieldFox frequency span. If flattened power can NOT be achieved, a warning message and beep occurs. To achieve a flattened output power, reduce the power level or stop frequency.
- Then press **Power Level**.
- Then enter a value using the numeric keypad, the **▲▼** arrows, or the rotary knob.
- Press **Enter**.

System Impedance (Z0)

To accurately view data presented in Smith Chart format, first set the System Impedance.

Learn how to select Smith Chart format in **“Format” on page 106**.

Learn how to make 75Ω measurements at the FieldFox Supplemental Online Help: <http://na.support.keysight.com/fieldfox/help/SupHelp/FieldFox.htm>

How to set System Impedance

- Press **Meas Setup 4**.
- Then **Settings**.
- Then scroll to System **Z0** and press **Edit**.
- Then type either **50** or **75** and press **Enter**.

Port Extensions

Port extensions allow you to electrically move the calibration reference plane on either port 1 or port 2 after you have performed a calibration.

Why use Port Extensions

Use port extensions if you are unable to perform a calibration directly at your device because the location is not accessible. Perform a calibration at a convenient place, then use port extensions to compensate for the time delay (phase shift) to the desired reference plane. On the FieldFox, port extensions does not compensate for the loss of the additional electrical length, nor any mismatch errors beyond the calibration reference plane.

Also use port extensions if you have already performed a calibration, and then decide that you need to add a length of transmission line in the measurement configuration. Use port extensions to “tell” the FieldFox that you have added the length to a specific port.

- With S11 and S22 reflection measurements, the FieldFox doubles the port extension value that you enter to account for the additional delay in the forward and reverse directions.
- With S21 and S12 transmission measurements, the port 1 and port 2 extensions are added together. This accounts for the total transmission delay going through ports 1 and 2.

Port extensions and Electrical Delay differ in the following ways:

- Electrical delay applies to a specific trace
- Port extensions apply to specific hardware ports

Port Extensions and Electrical Delay can be set independently. When both are set, the delay adds together. Learn more about Electrical Delay in **“Electrical Delay” on page 109**.

How to apply Port Extensions

- Press **Meas Setup 4**.
- Then **Port Extensions**
- Then **Port Extensions ON**
- Then **Port1 Extension**
- Then enter time value using the numeric keypad, the **▲▼** arrows, or the rotary knob. Press **Enter** or select a seconds (time) multiplier.

You can also set Port Extensions by pressing **Meas Setup 4** then **Calibration** (settings).

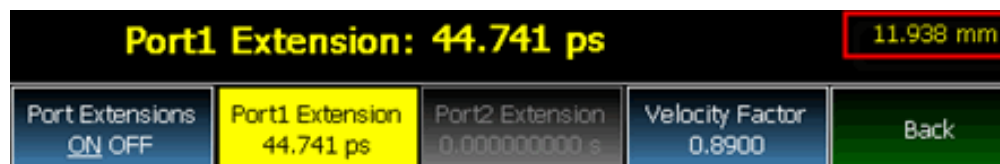

While setting Port Extension, the physical length of the extension, at the current Velocity Factor setting, is visible to the right (red box in above image).

Velocity Factor

The electrical delay or port extension value is entered as delay, or **electrical length**, in units of time.

Entering the velocity factor causes the FieldFox to accurately display the equivalent **physical length** in meters (NOT available in feet) that corresponds to the entered electrical delay.

Velocity factor is the ratio of the velocity of wave propagation in a coaxial cable to the velocity of wave propagation in free space. This velocity depends on the relative permittivity of the cable dielectric (ϵ_r).

$$\text{Velocity factor} = 1/\sqrt{\epsilon_r}$$

VF = 0.66 corresponds to wave propagation through a polyethylene dielectric.

VF = 1.0 (default setting) corresponds to wave propagation through free space (a vacuum).

How to set Velocity Factor

- Press **Meas Setup 4**.
- Then **Port Extensions**
- Then **Velocity Factor**
- Then enter a value between 0.1 and 1 using the numeric keypad, then press **Enter**.

You can also set Velocity Factor by pressing **Meas Setup 4** then **Calibration (settings)**.

Big Marker Display States (A and B)

This feature, available ONLY in NA Mode, allows you to view up to three Big or Super Big marker readouts. This is done by using up to two different display states called A and B. Each display state is comprised of the settings listed below. When the Big Readout setting is toggled through A and B, these display states are recalled.

How to create Big Marker Display States

To have big readouts, markers MUST be created using the following procedure.

If you have already set up your display and do not want to lose it, then save the current state to a state file. Learn how in **“State Files” on page 772**. The following procedure will overwrite your display state.

- Press **Mkr ->/ Tools**
- Then **Big Readout**
 - **A or B** - The A or B display state is recalled. If none have been defined, then the default display state is recalled.
 - **OFF** - The B display state is visible but without the Big Marker Readout.
- With A or B selected, then press **Edit Big Marker (A or B)**
- Then edit the following display state settings:
 - **Num Traces** – Choose the Multi-Trace configuration x1, x2, or x3. Only Overlaid configurations are allowed. Learn more in **“Multi-Trace Configurations” on page 103**.

- **Font Size** – Choose either Big or Super Big. Super Big marker readout #3 will cover some of the measurement grid.
- **Trace Settings** – For each possible trace (1, 2, and 3) select from the following:
 - **Measurement** – S-Parameter or Receiver measurement to display. **S11** is default. Learn more in [“About S-parameters” on page 99](#).
 - **Meas Format** – **Log** is default. Learn more in [“Format” on page 106](#).
 - **Bandwidth (ON)** – Marker readout for marker bandwidth search. OFF is default. Learn how to set BW parameters in [“How to Search with Markers” on page 698](#).
- **Big Readout** – For each marker readout (1, 2, and 3), select from the following:
 - **Marker #** – Enter a number from 1 to 6 to create the marker. 1 is created by default.
 - **Trace #** – The marker# is created on this trace. Tr1 is selected by default. The corresponding Num Traces must first be selected. For example, to create a marker on Trace 3, first select Num Traces = x3.
 - **Format** – Format for the marker readout. Select Default to make the marker readout format the same as the display format. Default is selected by default.
 - **Mkr Tracking** – ON: Select the parameter to track on the standard Marker Search menu. OFF is selected by default. When set to ON, Peak tracking is set by default. Learn about Marker Tracking in [“Marker Functions” on page 705](#).
 - **State** – Choose from Normal, Delta, or OFF. The default marker (1) is created in Normal. Learn more in [“Marker Functions” on page 705](#).
 - **Enabled** – Turns the Big Readout of the corresponding marker ON and OFF. The default marker (1) is set ON by default.

Notes:

- To move a marker, press **Marker**, then **Marker**, then scroll to the marker number to be moved. The new marker position can NOT be saved with the A or B display state.
- Settings that are NOT listed above are NOT affected by the recalled display states.
- Changes to the above settings outside the Big Readout menu will be overwritten when Big Readout (A or B) is selected. For example, suppose the display format for the B state is Log. If you change the display format to Lin using the standard menu (Meas 1, Format), the setting will show on the display. But if you then use the Big Readout (A | B | OFF) setting, when B is recalled, the Lin setting will be overwritten with the original Log setting.

Increase Dynamic Range

Dynamic range is the difference between maximum input power to the FieldFox receiver (without compressing the receiver), and the minimum measurable power (noise floor). Measurement accuracy is increased when the DUT response is at least 10 dB above the noise floor. For a measurement to be valid, input signals must be within these boundaries.

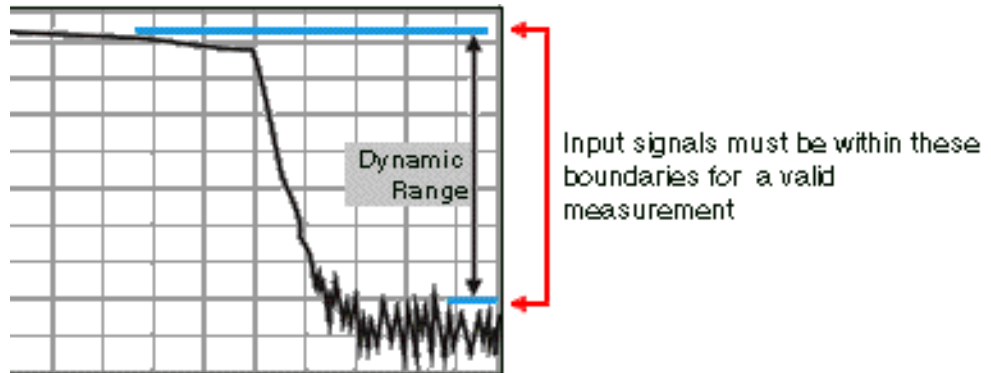

The following settings will increase the dynamic range of your NA mode measurement.

- Increase Power Level: Press **Meas 4** then **Output Power High**
- Lower the IFBW: Press **BW 2** then **IF BW**
- Increase Averaging: Press **BW 2** then **Average**

The following procedure MAY increase the dynamic range of your NA mode measurement. The results you see will depend on the performance of your DUT.

With an S21 trace active:

1. With RF OUT (port-2) open, press **Trace 6** then **Math and Memory** then **Data->Mem**
2. Re-connect the DUT.
3. Press **Data Math** then **Data-Mem**

7 Time Domain – Option 010

With NA Mode, Time Domain (Opt 010), frequency information is used to calculate and display measurements with time as the horizontal display axis. The response values appear separated in time allowing a different perspective of the test device's performance and limitations.

NA Mode settings that are NOT unique to Time Domain are documented in [Chapter 6, "NA \(Network Analyzer\) Mode", on page 97](#).

In This Chapter

["Overview" on page 123](#)

Time Domain (Transform) Settings

["Transform Settings Table" on page 124](#)

["Start/Stop \(Frequency Range\) and Points" on page 124](#)

["Stimulus \(Mode\)" on page 125](#)

["Set Frequency Lowpass" on page 125](#)

["Start/Stop Time" on page 125](#)

["Distance Units" on page 126](#)

["Window Layout" on page 126](#)

["Transform Window" on page 126](#)

["Line Loss and Velocity Factor" on page 127](#)

["Data Chain" on page 128](#)

["Gating Type" on page 131](#)

Trace Settings

["Transform Enable" on page 129](#)

["Gate Enable" on page 129](#)

Gating Settings

“Start, Stop, Center, and Span Gate Times” on
page 131

“Gating Type” on page 131

Overview

In normal NA Mode operation, the FieldFox measures the characteristics of a test device as a function of frequency. With Time Domain (opt 010), frequency information is used to calculate the inverse Fourier transform and display measurements with time on the horizontal display axis. The response values appear separated in time, allowing a different perspective of the test device's performance and limitations.

The graphic below compares the same cable reflection measurement data in both the frequency and time domain. The cable has two bends. Each bend creates a mismatch or change in the line impedance.

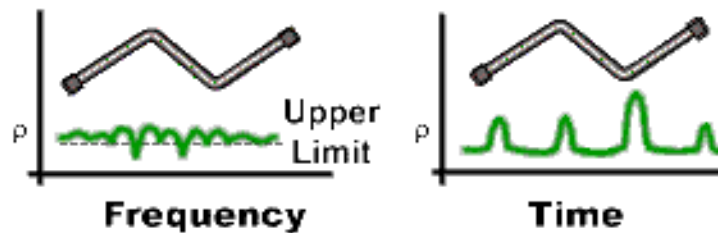

The frequency domain of an S11 measurement shows reflections caused by mismatches in the cable. It is impossible to determine where the mismatches physically occur in the cable.

The Time Domain response shows both the location and the magnitude of each mismatch. The responses indicate that the second cable bend is the location of a significant mismatch. This mismatch can be gated out, allowing you to view the frequency domain response as if the mismatch were not present. Learn more about gating in [“Gating” on page 130](#).

Markers that are created on a Time Domain trace can be used to pinpoint the distance of the mismatch from the reference plane.

For more information on Time Domain theory, see

<https://www.keysight.com/us/en/assets/7018-01451/application-notes/5989-5723.pdf>.

Time Domain (Transform) Settings

You can set and view most of the Time Domain settings on the Transform Settings table.

Transform Settings Table

The following settings (from Transform Stimulus Settings to Data Processing) are listed in the order they appear on the Transform Settings menu selection.

How to make settings on the Transform settings table

- Press **Meas Setup 4**.
- Then **Transform**
- Then **Transform Settings**.
- Press **Next Page** and **Previous Page** to view all settings.
- To change a setting:
 - Use the **▲▼** arrows or rotary knob to highlight a setting.
 - Numeric settings can be changed by pressing numbers using the numeric keypad. Then press Enter or select a suffix if available.
 - Some settings allow you to press **Edit** to toggle the value. Other settings require that you then press a softkey to change the value.
 - When finished changing a value, press **Done Edit**.
- Press **Dock Window** to relocate the Settings table to a position relative to the trace window. The Dock Window setting persists through a Preset. Choose from the following:
 - **Full (Default setting)** Only the Settings table is shown on the screen. The trace window is temporarily not shown.
 - **Left** The Settings table is shown to the left of the trace window.
 - **Bottom** The Settings table is shown below the trace window.
- When finished changing ALL settings, press **Done** to save your settings.

Start/Stop (Frequency Range) and Points

All Time Domain measurements are made in the frequency domain and, using Inverse Fourier Transform (IFT), time is calculated. Select the frequency range from which Time Domain measurements are calculated. Increasing the data points will improve measurement resolution. However, more data points will usually result in slower sweep updates.

Set frequency range and points before selecting Stimulus Mode.

Stimulus (Mode)

- There are three variations on how the Time Domain transform algorithm is applied to the frequency domain measurement. Each method has a unique application.
- **Lowpass Impulse** - Highest resolution. Most useful for seeing small responses in devices that pass low frequencies, such as cables.
- **Lowpass Step** - Easiest to identify inductive and capacitive discontinuities in devices that pass low frequencies such as cables.

In both Lowpass modes, frequencies down to DC and negative frequencies are extrapolated. Therefore, when either Lowpass mode is selected, Set Freq.Low Pass is automatically applied to adjust the start frequency. Learn more about Set Frequency Lowpass below.

When the Start Frequency or resolution is changed AFTER selecting a Lowpass mode, then Stimulus mode is set to Band Pass and Transform is disabled.

- **Bandpass Impulse**- Easiest method - can be used with any frequency sweep. Most useful for measuring band limited devices such as filters and DC blocked cables. This mode does NOT show capacitive and inductive reactance. For the same frequency span and number of points, band pass mode has twice the impulse width, which hides closely spaced responses degrading the response resolution.

Set Frequency Lowpass

NOTE

This setting is made automatically when either Lowpass mode is selected.

USE ONLY IN LOW PASS MODES. The Low Pass Start frequency is adjusted so that the Low Pass Stop frequency is at harmonics of the Low Pass Start frequency. Start frequency is computed by the following formula:

Low Pass Start Frequency = Stop Frequency / Number of points.

Start/Stop Time

The following settings adjust the **display resolution**, allowing you to zoom IN or OUT on a response. When the start or stop time is updated, they may be automatically adjusted to limit the display to one alias-free response on either side of zero time.

How to set Start and Stop time

- Press **Measure Setup 4**
- Then **Transform**
- Then **Transform Start Stop**

- Then choose from:
 - **Start** Sets the transform start time.
 - **Stop** Sets the transform stop time.

NOTE

Zero (0) seconds is always the calibration reference plane. Negative values are useful if moving the reference plane.

Distance Units

When markers are present on a Time Domain trace, marker X-axis values are shown both in units of time (seconds) and distance. Select the units in which the marker distance data is presented.

Distance Units are also used when setting Time Domain Line Loss. Learn more in. [“Distance Units” on page 126.](#)

Choose from: m (meters), or Feet.

Window Layout

This setting is used to create additional traces, or select a new layout for traces that are already created,

Choose from: x1, x2, x2H, x3H, x3, x4H.

Learn more about multi-trace configurations in [“Multi-Trace Configurations” on page 103.](#)

Transform Window

There are abrupt transitions in a frequency domain measurement at the start and stop frequencies, causing overshoot and ringing in a Time Domain response. The Window setting reduces the abruptness of the frequency domain transitions. This causes you to make a trade off in the Time Domain response.

The Window setting applies to ALL traces.

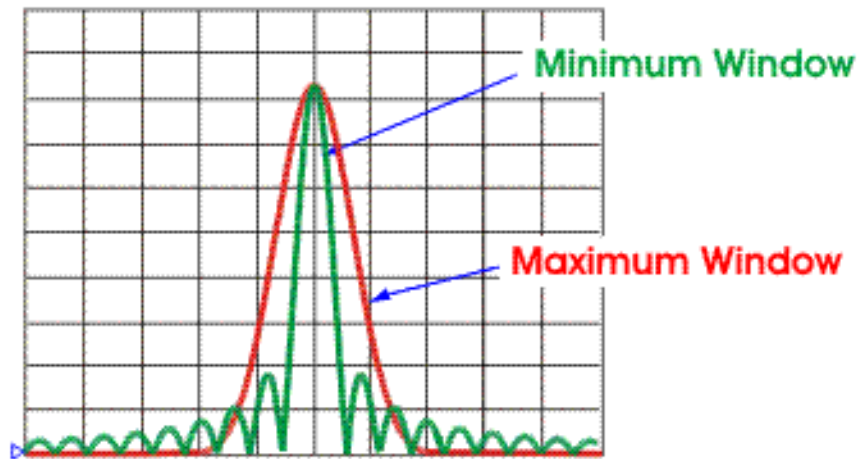

How to make Window setting

- Press **Measure Setup 4**
- Then **Transform**
- Then **More**
- Then **Transform Window**
- A settings table appears that allows you to navigate and select the following settings. These settings are made exactly like those made on the Transform Settings table. Learn how in [“Transform Settings Table” on page 124.](#)

NOTE

Any of the following four methods can be used to make this same Window setting. Impulse Width values are calculated from the frequency span and Kaiser Beta value.

1. Window	Min	Medium	Max
2. Percent	0	50	100
3. Kaiser Beta	0	6.50	13.00
4. Impulse Width	100.455 ps	168.501	231.284

Line Loss and Velocity Factor

By default, the FieldFox does NOT correct Time Domain measurements to account for the inherent loss of a cable. However, to make more accurate measurements, Line Loss and Velocity Factor should be considered.

About Velocity Factor and Line Loss

- Velocity Factor is a property of the physical material of a cable. A VF of 1.0 corresponds to the speed of light in a vacuum, or the fastest VF possible. A polyethylene dielectric cable has VF = 0.66 and a cable with PTFE dielectric has VF = 0.7.
- Line Loss is specified in dB/m (or ft). In addition to the length of the cable, loss is also directly proportional to the frequency of the signal that passes through the cable.

The following is an example showing how Line Loss works:

The DUT is a 100 meter transmission cable. The Line Loss value is 1 dB/meter. This means that a signal traveling ONE WAY through the cable will lose 10 dB of power (100 m * 1dB/m). Because the FieldFox performs this measurement with 1 port, the test signal travels down the cable and then back, for a total loss of 20 dB.

For the purpose of illustrating this point, connect an OPEN to the end of the cable – a maximum-sized fault – for 100% reflection of the 300 MHz test signal.

Without compensation for the loss of the cable, a –20 dB response would be visible at 100 meters, which is the OPEN at the end of the DUT. This is from 10 dB of loss through the cable in each direction.

With compensation for the loss using the manufacturer's specification, the FieldFox compensates the trace as though the signal traveling through 100 meters was increased by +20 dB. Therefore the response will show 0 dB for 100% reflection.

Data Chain

This setting, available only on the Transform Settings Table, reverts to **Standard** when the FieldFox is Preset. Choose from the following:

- **Standard** – The normal FieldFox data processing chain. Transform calculations are performed AFTER error correction and trace math.
- **8510** – The data processing chain used by the Keysight 8510 network analyzer. Transform calculations are performed BEFORE error correction and trace math. Learn more at the FieldFox Supplemental Online Help website:

<http://na.support.keysight.com/fieldfox/help/SupHelp/FieldFox.htm>

Trace Settings

The following two settings apply to specific traces.

Transform Enable

Enable Time Domain transform for the specific trace.

- Select the trace.
- Press **Measure Setup 4**
- Then **Transform**
- Then choose from:
 - **Transform On** Trace displays Time Domain data.
 - **Transform Off** Trace displays frequency domain data.

Gate Enable

Enable Gating for the specific trace.

- Select the trace.
- Press **Measure Setup 4**
- Then **Transform**
- Then choose from:
 - **Gating On** Trace displays Time Domain data.
 - **Gating Off** Trace displays frequency domain data.

Gating

Perhaps the most beneficial feature of Time Domain transform is the Gating function. When viewing the Time Domain response of a device, the gating function can be used to “virtually” remove undesired responses. You can then simultaneously view a frequency domain trace as if the undesired response did not exist. This allows you to characterize devices without the effects of external devices such as connectors or adapters.

Gating is best performed while viewing a Time Domain trace. Then, either disable Transform, or separately view a frequency domain trace to see the trace with the gated effects removed.

NOTE

When a discontinuity in a test device reflects energy, that energy will not reach subsequent discontinuities. This can “MASK”, or hide, the true response which would have occurred if the previous discontinuity were not present. The Gating feature does NOT compensate for this.

The following image shows how gating can affect measurement results.

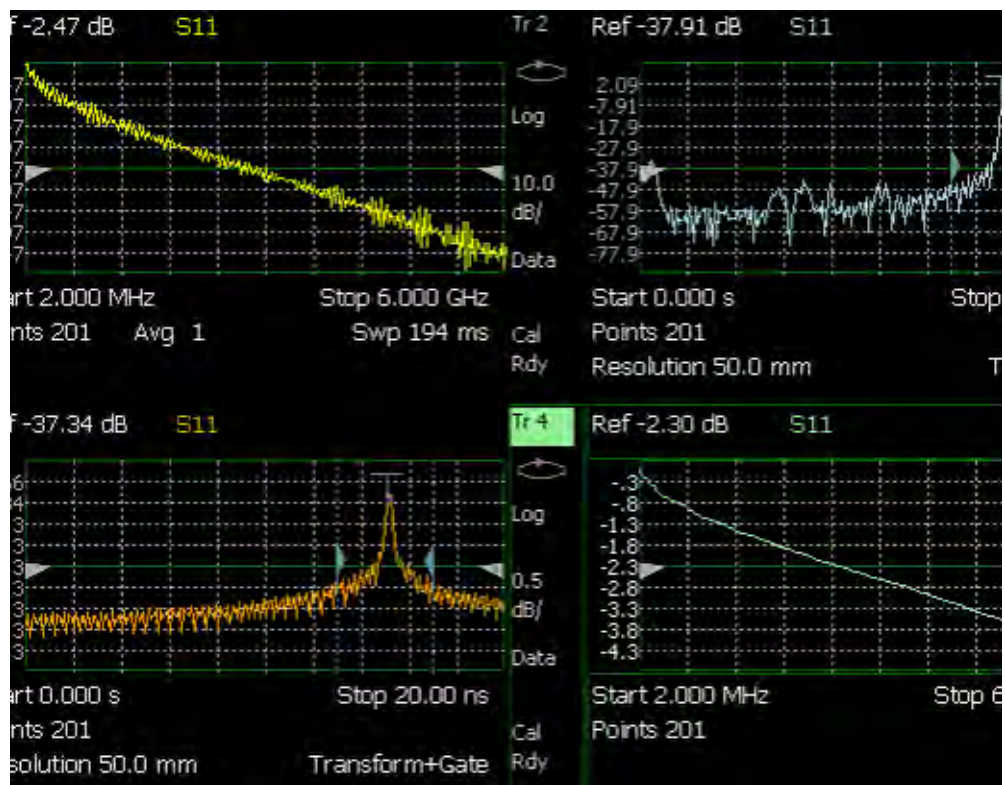

All 4 traces show the same S11 measurement.

Trace 1 shows the **frequency** response **without** gating enabled.

Trace 2 shows the **transform** response **without** gating enabled.

Trace 3 shows the **transform** response **with** gating enabled.

Trace 4 shows the **frequency** response **with** gating enabled.

How to make Time Domain Gating settings

- Press **Measure Setup 4**
- Then **Transform**
- Then **Gating**
- Then choose from:
 - **On** Gating is being performed.
 - **Off** Gating is NOT being performed.

Start, Stop, Center, and Span Gate Times

These settings specify the time in the trace to be gated (in or out). The gate times can be specified using either Start and Stop or Center and Span.

- Press **Gating Start Stop**
- A settings table appears that allows you to navigate and select the following settings. These settings are made exactly like those made on the Transform Settings table. Learn how in **“Transform Settings Table” on page 124**.

Gating Type

This setting defines the type of filtering that will be performed for the gating function. The gate start and stop flags on the display point toward the part of the trace you want to keep.

Choose from the following:

- **Bandpass** KEEPS the responses within the Gating Start and Stop times.
- **Notch** REMOVES the responses within the Gating Start and Stop times.

Gating Shape

This setting defines the filter characteristics of the gate function. Choose from Minimum, Normal, Wide, Maximum.

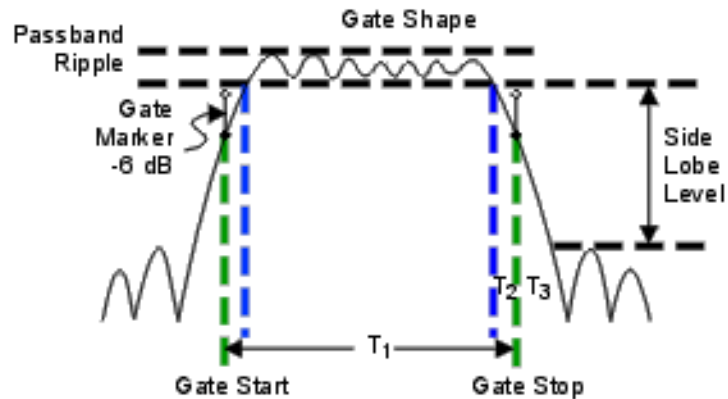

Time domain Gate Shape setting is shown in the graphic above.

Gate Shape	Passband Ripple	Sidelobe Levels	Cutoff Time	Minimum Gate Span
Minimum	±0.1 dB	-48 dB	1.4/Freq Span	2.8/Freq Span
Normal	±0.1 dB	-68 dB	2.8/Freq Span	5.6/Freq Span
Wide	±0.1 dB	-57 dB	4.4/Freq Span	8.8/Freq Span
Maximum	±0.01 dB	-70 dB	12.7/Freq Span	25.4/Freq Span

Cutoff time is the time between the stop time (-6 dB on the filter skirt) and the peak of the first sidelobe.

- T₁ is the gate span, which is equal to the stop time minus the start time.
- T₂ is the time between the edge of the passband and the 6 dB point, representing the cutoff rate of the filter.
- T₃ is the time between the 6 dB point and the edge of the gate stopband.

For all filter shapes T₂ is equal to T₃, and the filter is the same on both sides of the center time.

Minimum gate span is twice the cutoff time. Each gate shape has a minimum recommended gate span for proper operation. This is a consequence of the finite cutoff rate of the gate. If you specify a gate span that is smaller than the minimum span, the response will show the following effects:

- distorted gate shape that has no passband
- distorted shape
- incorrect indications of start and stop times
- may have increased sidelobe levels.

8 Calibration for NA, CAT, and VVM Modes

Calibration removes the systematic errors that are associated with measurements in NA, CAT, and VVM Modes. Key presses are identical in all of these Modes.

In this Chapter

[“Why and When to Calibrate” on page 134](#)

[“Definitions” on page 134](#)

[“CalReady” on page 135](#)

[“How to Perform a Calibration” on page 135](#)

[“QuickCal \(N991xA/2xA/3xA Only\)” on page 137](#)

[“Mechanical Cal” on page 140](#)

[“ECal” on page 142](#)

[“Simple Response Cals ” on page 145](#)

[“View Cal” on page 147](#)

[“Calibration Type” on page 147](#)

[“Enhanced Response Optimization” on page 152](#)

[“Interpolation **” on page 153](#)

[“Cal ON? – Questionable Accuracy” on page 153](#)

[“Compatible Mode Calibrations” on page 153](#)

[“Save the Calibration” on page 153](#)

[“CalReady Properties” on page 154](#)

[“Apply Nearest \(NA Mode Only\)” on page 155](#)

[“Verify a Calibration” on page 155](#)

[“Test the Jumper Cable” on page 156](#)

See Also

Learn **How to Make 75 ohm Measurements** at the FieldFox Supplemental Online Help:

<http://na.support.keysight.com/fieldfox/help/SupHelp/FieldFox.htm>

Why and When to Calibrate

There are well-defined and understood systematic errors that are measured and calculated during the calibration process. These errors are caused by leakage signals inside the FieldFox, by the frequency response of the FieldFox receivers, and by reflections inside the FieldFox that interact with the DUT. After calibration, these errors are removed from subsequent measurements.

To maintain highest measurement accuracy, perform a new calibration when any of the following changes occur:

- When any of the following measurement settings change: Frequency Range, Power Level, IF BW, and Resolution. Therefore, make these measurement settings before calibrating. Increased Averaging, lower IF BW, and higher Resolution all cause slower sweeps and slower calibration times. Learn about Interpolation and Questionable Accuracy in **“Interpolation *” on page 153**.
- When the FieldFox temperature changes more than about 10°F (5°C). Learn more in **“How to monitor the internal FieldFox temperature:” on page 40**.
- When the connection to the DUT changes, requiring a different jumper cable or adapter.

Definitions

DUT (Device Under Test) The cable, antenna, transmission line, amplifier, or anything else that is connected to the FieldFox that is to be measured.

Calibration Standards - OPEN, SHORT, LOAD, and THRU

- **OPEN, SHORT, and LOAD** are ‘reflection’ standards that are used during calibration. When an RF signal ‘hits’ these components, the signals are reflected in a predictable manner. These components can also be used to terminate a DUT port during some measurements.
 - SHORT and OPEN standards both cause 100% of an RF signal to be reflected. The difference between these two standards is what happens to the phase of the reflected signal, which is beyond the

scope of this discussion. Although an OPEN standard is a precision component, simply leaving **nothing** connected at the end of a cable can be a reasonable substitute for an OPEN.

- A LOAD standard absorbs almost ALL of the incident signal and very little signal is reflected back to the source.
- A **THRU** standard is used during some calibration steps to connect PORT 1 to PORT 2 in place of the DUT. A Flush THRU connection can be made when cables that connect with the DUT can mate with each other. Learn more in **“Mechanical Cal” on page 140**. Otherwise, any reasonably short cable can be used as a THRU standard.

Calibration Reference Plane is the point (or points) at which the DUT and cal standards are connected during a calibration. This can be at the FieldFox test port connectors, or at the end of jumper cables or adapters.

CalReady

Every FieldFox contains a factory calibration that was performed at the port 1 and port 2 connectors, with -15 dBm input power, over the entire frequency range of the FieldFox using a number of data points that allows reasonable interpolation over the FieldFox frequency range.

This calibration, known as CalReady, allows you to immediately make measurements of a DUT that is connected directly at the test ports (PORT 1 and/or PORT 2). CalReady corrects measurements when the FieldFox is turned ON and when a measurement is created with no other correction in place.

When measuring a DUT using a jumper cable or adapter - NOT a direct connection to a test port connector - then a Mechanical Cal is recommended. CalReady can also be used to check the integrity of the jumper cable that is attached to the test ports.

CalRdy is shown when a measurement is corrected using CalReady.

You can change the properties of the CalReady calibration. Learn more in **“CalReady” on page 135**.

Learn how to see when your factory CalReady calibration was performed in **“System Information” on page 763**.

How to Perform a Calibration

NOTE

Press **Esc** at any time to end the calibration process.

When performing a calibration that contains a large number of points (5000 to 10,001 points) be aware that the calibration progress bar may not move for 2 or 3 minutes during the calibration process.

In CAT, NA, or VVM Mode, press **Cal 5**.

The following appears:

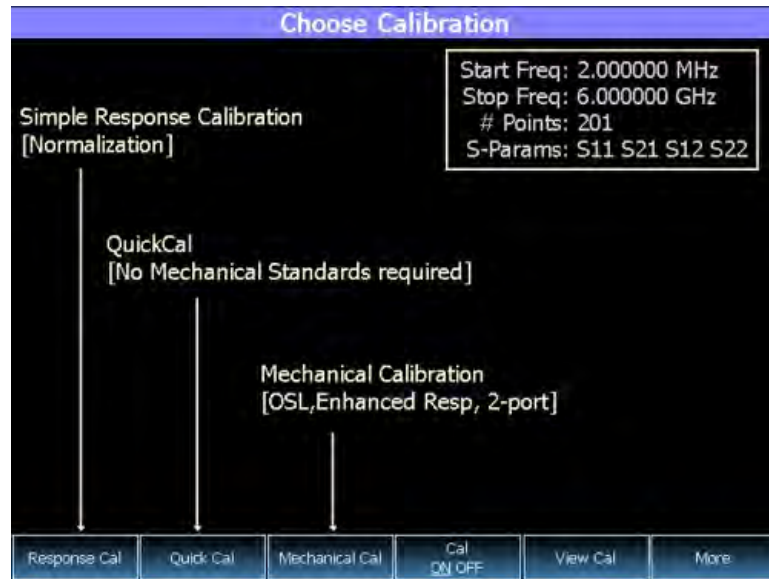

Choose Calibration Method screen

- **Response Cal** – Used to quickly calibrate ONE type of measurement using mechanical standards. Measurement accuracy is generally low. Learn more in [“Simple Response Cals ” on page 145.](#)
- **Quick Cal** – Using built-in cal standards and CalReady, quickly and accurately calibrate measurements when using a jumper cable or adapter to connect the DUT to the FieldFox test ports. Learn more in [“QuickCal \(N991xA/2xA/3xA Only\)” on page 137](#)
- **Mechanical Cal/ECal** – Using mechanical cal standards from a cal kit, perform an accurate calibration at one or both test ports, adapters, or jumper cables. Full 2-port mechanical calibration is the most accurate calibration available with FieldFox. Learn more in [“ECal” on page 142.](#)
- **User Cal OFF ON** – Turns ON and OFF the effects of the user calibration that you performed. The OFF state reverts to CalReady.
- **View Cal** – Shows the properties of the current calibration. Learn more in [“View Cal” on page 147.](#)
- **More** – Learn about Cal Ready Properties in [“CalReady” on page 135.](#)

NOTE

Source Unleveled errors - During calibration, the frequency range of the measurement MAY be extended to provide maximum flexibility. During the calibration, the output power may become unleveled at the added high frequencies. You can ignore the “Source Unleveled” error, or to avoid the error, select either High power or -15 dBm before calibrating. Learn more about setting Output Power in “[Output Power](#)” on page 63.

QuickCal (N991xA/2xA/3xA Only)

CAUTION

QuickCal does not apply to N995x/6xA models.

QuickCal is ideal for a quick and simple calibration of the measurement when using a jumper cable or adapter to connect the DUT to the FieldFox test ports. QuickCal corrects for phase shift, time delay, and loss of adapters or jumper cables.

QuickCal does not require a specific Cal Kit and is a very simple calibration. If the highest accuracy is required, a mechanical calibration with a high quality calibration kit is recommended.

QuickCal is designed and most accurate when calibrating for DUTs fitted with **Type-N and 7/16** connectors.

If the DUT has different connectors, such as 3.5 mm (male) or SMA male connectors, QuickCal can still be used by selecting 'Other' connector. However, the accuracy of QuickCal with 'Other' connectors is not specified.

If the DUT has 3.5 mm-female or SMA-female connectors, QuickCal is NOT recommended. For accurate and repeatable measurements of devices with female 3.5 mm or SMA connectors, use mechanical calibration.

Important QuickCal Notes

- 7/16 connectors can be used with QuickCal ONLY up to 6 GHz.
- Type-N 75 Ohm can be used with QuickCal ONLY up to 3 GHz.
- QuickCal cannot be used with waveguides, or if the test fixture or test setup (before DUT) includes an attenuator.

How to perform a QuickCal

- In CAT, NA, or VVM Mode, press **Cal 5**
- Then **QuickCal**

- Press **Change DUT Connectors** to select the correct connector types that are on your DUT. Although there is no Cal Kit required, selecting the connector type (limited to Type-N and 7/16) and gender from the list provides an accurate OPEN model which means a more accurate calibration. If the DUT connector type is not listed, select Unknown/Other.

- The connector choices that are offered depend on the frequency range. For example, if you have selected a frequency range that exceeds 18 GHz, the only connector options you will be presented with in QuickCal are 'other 50 ohm' or 'other 75 ohm'. This is because 3.5 mm connectors, which go beyond 18 GHz, are not supported with QuickCal.

- For each DUT port:
 - Select the connector type of the DUT using the **▲▼** arrows or rotary knob.
 - Press **Change Gender** to change the gender of the DUT connector.
 - Press **Next...** to make the selection.
 - If present, press **Finish**.

- Select/Change Cal Type. The FieldFox always RECOMMENDS a Cal Type that will quickly and accurately calibrate all of the displayed S-parameters. The other Cal Types that are listed will NOT necessarily calibrate all of the displayed S-parameters. Learn more about Cal Types in **“Calibration Type” on page 147**.
 - Using the **▲▼** arrows or rotary knob, select a Cal Type, then press **Select** and **Finish**.

- Press **Start Calibration**

No Connection

- Disconnect the DUT from the FieldFox.

- If a jumper cable or adapter is required to connect the DUT to the FieldFox, connect those components to the FieldFox test ports connectors. The effects of those components will be measured and removed during the calibration, and only the effects of the DUT will be displayed in the measurement results. These should be high-quality components!

- Do NOT connect anything at the cal reference plane where the DUT connects.

- Press **Measure**

Optionally Connect Load(s)

- Connect a Load standard at the point where the DUT will be connected and press **Measure** under the following conditions:
 - When a jumper cable has too much loss. If a 'Cal Failed' error appears and you skipped the Load measurement, then perform the Cal again but include measuring the Load.
 - When your DUT has high return loss such as the reject band of a filter. Then measuring the load improves accuracy. Even with the optional Load, phase accuracy begins to degrade when the return loss is greater than about 20dB.
- Press **Skip Step** in all other cases and when making DTF measurements. Measuring a load would do little to improve accuracy.

Connect THRU (Not used for 1-port cals)

- Connect port 1 to port 2, either by mating the connectors that attach to the DUT (Flush THRU), or by using a short jumper cable. Learn [more about Flush THRU](#) in **“Calibration Type” on page 147**. Then press **Measure**.
- Press **Finish**.

CAL ON Q is shown on the screen for all displayed measurements that are corrected with QuickCal.

Using QuickCal with a Long Jumper Cable

QuickCal requires a sufficient frequency span to adequately characterize the jumper cable (the cable between the instrument port and the DUT). If a 'Cal Failed' error appears and you connected the optional Load standard, then increase the frequency span of the measurement until the error no longer appears. After the calibration, you can then decrease the frequency span as needed and rely on interpolation. Learn more about Interpolation in **“Interpolation *” on page 153**.

QuickCal is also limited in how much jumper cable loss it can tolerate. If QuickCal without the Load is failing, then measure the Load during the QuickCal to see if that resolves the issue.

Mechanical Cal

Mechanical Calibration is performed using discrete standards from a Cal Kit. Several Cal Kit definitions are built into the FieldFox. To learn about Cal Kit definitions, refer to the Application Note, “Specifying Calibration Standards and Kits for Keysight Vector Network Analyzers,” available online at <https://www.keysight.com/us/en/assets/7018-01375/application-notes/5989-4840.pdf>.

NOTE

Visit www.keysight.com/find/fieldfoxsupport to see a complete list of supported Cal Kits. Also at this website, download Data-Link software that allows you to edit Cal Kit definitions or add a new Cal Kit.

Mechanical Cals are extremely accurate when performed using the correct Cal Kits with standards that are clean and in good repair, and when using correct connection procedures.

How to perform a Mechanical Cal

- Disconnect the DUT from the FieldFox.
- If a jumper cable or adapter is required to connect the DUT to the FieldFox, then connect **those** components to the FieldFox connectors. The effects of those components will be measured and removed during the calibration, and only the effects of the DUT will be displayed in the measurement results. **These should be high-quality components!**
- In NA, CAT, or VVM Mode, press **Cal 5**.
- Then **Mechanical Cal**

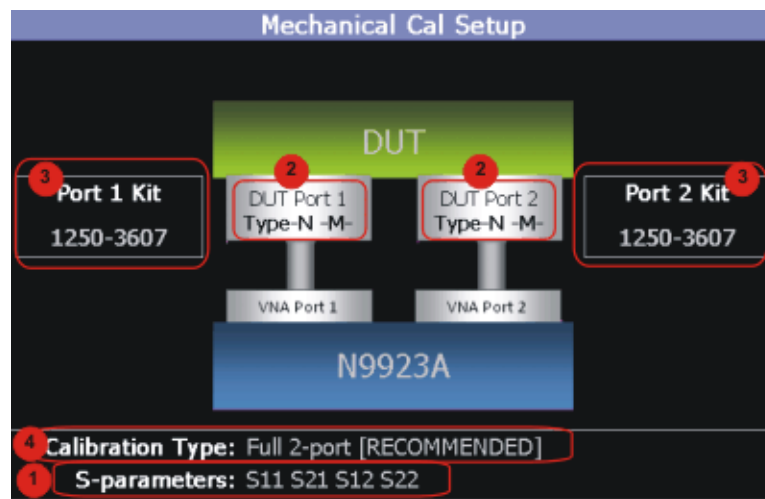

This page summarizes the Mechanical Cal to be performed and allows you to make changes. For best results, review the screen and make changes in the following order:

1. **S-parameters** – Verify that these are all of the S-parameters that you want calibrated. If not, press **Esc** to terminate the calibration process, then return to the Trace menu to display all of the traces to be calibrated. Learn how in **“Multi-Trace Configurations” on page 103**
2. **DUT Connectors** – For each DUT port that is shown, verify the correct type and gender of the DUT connector. If a DUT port is not shown, then that port is not included in the list of S-parameters to be calibrated.
3. **Cal Kit** - Verify the correct Cal Kit for each DUT port to be calibrated. See a list of supported Cal Kits in the FieldFox Data Sheet. Learn more in Appendix B.

If the DUT connector type, gender, or Cal Kit is **NOT** correct for the DUT ports to be calibrated, then:

- Press **Change DUT Connectors** to select the correct connector types that are on your DUT.
 - For each port:
 - Use the **▲▼** arrows or rotary knob to change the DUT connector type.
 - Press **Change Gender** to change the gender of the DUT connector.
 - Then press **Next...** to confirm the selection and continue the process.
 - For each port:
 - Use the **▲▼** arrows or rotary knob to select the Cal Kit that you have, and are going to use, for the specified ports.
 - Press **Next...** to confirm the selection and continue the process.
 - Then press **Finish** to end the selection process.
4. **Calibration Type** - The FieldFox always RECOMMENDS a Cal Type that will quickly and accurately calibrate all of the displayed S-parameters. Change from the RECOMMENDED Cal Type ONLY if you understand the implications. Learn more about Cal Types in **“Calibration Type” on page 147**.

To select a different Cal Type:

- Press **Change Cal Type**.
- Then using the **▲▼** arrows or rotary knob, select a Cal Type,
- Then press **Select and Finish**.

Begin Calibration

- Press **Start Calibration**.

NOTE

If an error appears (“Failure to compute calibration steps...”), check to ensure that the frequency range of the Cal Kit covers the frequency range of the measurement. You can verify the frequency range of your Cal Kit at: www.keysight.com/find/fieldfoxsupport. Click Cal Kits.

- Follow the Cal Wizard prompts. Connect the specified standard at the point where the DUT will be connected, then press **Measure**.
- At any time, press **Back** to re-measure a standard if you feel it was not properly connected.
- Press **Finish** to complete the calibration.

CAL ON U is shown on the screen for all displayed measurements that are corrected with the Mechanical Cal.

ECal

CAUTION

ECals each have a recommended input power level. Depending on the measurement setup, the FieldFox may default to an input power level that exceeds your ECal’s recommended input power level. Refer to the reference guide for your ECal module to determine the correct input power levels. Exceeding an ECal’s recommended input power level results in a compression and an invalid data condition. Refer to www.keysight.com/find/ecal.

ECal is a complete solid-state calibration solution. Every ECal module contains electronic standards that are automatically switched into position during a calibration. These electronic standards have been measured at the factory and the data stored within the memory of the ECal module. The FieldFox uses this stored data, along with the measured data, to calculate the error terms for a measurement calibration.

You can perform the following calibrations with ECal:

- 1-Port Reflection calibration
- Full 2-Port calibration

CAUTION

Simple ECal ON: When choosing **Full 2-port** calibration, if you are able to connect your ECal simultaneously to both device ports, you should use **Simple ECAL** (i.e, this ensures that you are using the correct Thru calibration model).

Simple ECal OFF: Set simple ECal to OFF when you have a test setup where you cannot connect port 1 and port 2 simultaneously to the ECAL module (Then during the calibration when prompted: **“Connect port 1 to port 2”**, use a coaxial cable or an appropriate thru adapter to connect port 1 to port 2).

‘Unknown THRU’: When prompted: **“Connect port 1 to port 2”**, then you can connect them, using a coaxial cable or an appropriate thru adapter. Do NOT use the internal ECal THRU, because the thru calibration will be incorrect.

‘Flush THRU’: When prompted: **“Connect port 1 directly to port 2”**, then you must connect the ports directly together at the calibration reference plane with no adapter or other cabling.

Learn more in **“Calibration Type” on page 147.**

All Keysight USB ECal modules are supported. ECal modules are available in a variety of connector types, covering many frequency ranges. For information about available ECal modules, see <http://www.keysight.com/find/ecal>

Select an ECal module that has connectors of the same type and gender as the DUT. If such an ECal module is not available, a module with connectors different from the DUT can be used by selecting a User Characterization. This selection is located on the Mechanical Cal Setup page of the CalWizard. However, a User Characterization can NOT be PERFORMED using the FieldFox. It must be performed using a bench top Keysight VNA, such as the PNA or ENA. Learn more about User Characterization at the PNA Help website: http://na.support.keysight.com/pna/help/latest/S3_Cals/ECal_User_Characterization.htm.

How to Perform a Calibration Using ECal

- Make measurement settings on the FieldFox (frequency range, number of points, etc.)

NOTE

The frequency range of the measurement **MUST** be within the frequency range of the ECal module or an error will appear when **“Calculating Steps”** during the calibration.

-
- Connect the ECal module USB cable to the FieldFox USB.

- Allow the module to warm up until it indicates READY. This may take several minutes.
- Connect the ECal module ports to the FieldFox at the calibration reference plane (where the DUT will be connected).
- Press **Cal 5** to start the Calibration.
- Press **Mechanical Cal / ECal**
- Press **Change DUT Connectors**. For each test port to be calibrated, select the **Connector Type** and **Gender** of the DUT / ECal module. The connected ECal module and relevant User Characterizations will appear, with the ECal factory default as the default Cal Kit.
- Optionally press **Advanced** then **ECal Auto Orient**.
 - **ON** (default) The FieldFox automatically senses the direction in which the ECal module ports are connected to the FieldFox ports.
 - **OFF** If power to the ECal module is too low, it cannot detect which FieldFox ports it is connected to. If you are having this problem, select OFF. Then during the calibration, the FieldFox will prompt you to connect the ECal module ports to specific FieldFox ports.
- Optionally press **Advanced** then **Extended Cal** (N995xB/6xB Only).
 - **ON** The FieldFox Extended Cal measures additional points outside the current frequency range in order to enable adjusting the frequency range after the calibration procedure. With these extra points, the error correction may be applied when it otherwise might not. Without extended cal, if you adjust your frequency outside the calibrated range after the calibration has been completed, the error correction is turned off.
 - **OFF** (default) The FieldFox does not measure any frequency points outside the current displayed frequency range. If the frequency is adjusted outside of the set of points calibrated the error correction is turned off and the following message is displayed:
"Error correction disabled. Stimulus outside calibrated range."

- Press **Start Calibration**. When prompted, verify the ECal module connection, then press Measure. The standards within the ECal module are automatically connected and measured.

CAUTION

'Unknown THRU': When prompted: **"Connect port 1 to port 2"**, then connect port and port 2, using a coaxial cable or an appropriate thru adapter. Do NOT use the internal ECal THRU, because the ECal thru calibration model is incorrect for this calibration type.

'Flush THRU': When prompted: **"Connect port 1 directly to port 2"**, then you must connect the ports directly together at the calibration reference plane with no adapter or other cabling.

Learn more in ["Calibration Type" on page 147](#).

Simple Response Cals

Simple Response Cals are used to quickly calibrate the magnitude and phase of a measurement using any Open, Short, or Thru component. These may be calibration standards, but because a Cal Kit is not selected, they are not modeled. Measurement accuracy is generally low. Use a Simple Response Cal to make quick measurements when using a jumper cable to connect the DUT to the FieldFox. Otherwise, CalReady is usually more accurate.

CAUTION

IMPORTANT!

The Simple Response calibration assumes an ideal response for the standard. DUT measurements after a Simple Response calibration will have a measurement bias equivalent to the deviation of the response of the device used as the Simple Response standard from the ideal response. Note, that an Open Response is simply a normalization, a Short response is a normalization with 180 degree phase offset. When selecting a standard from the 85058B calibration kit for a Short Response we suggest using short # 1 because it has the smallest delay of the four shorts and would thus be most similar to an ideal short.

For better accuracy, perform a mechanical calibration by referring to ["Mechanical Cal" on page 140](#).

NOTE

You can perform a Simple Response Cal for either: S11, or S22, or S21 AND S12.

When prompted, choose a standard based on the displayed measurements to be calibrated. For example, to calibrate S11, connect either an OPEN or SHORT to the port 1 reference plane.

When Simple Response Cals are performed, the source match and reflection tracking terms from CalReady are updated by the measured Short or Open that is used during the calibration.

1-port response cals are also available from the Mechanical Cal menu. Learn more in [“Calibration Type” on page 147](#).

Normalize uses a THRU standard or cable between port 1 and port 2 to cal an S21 and S12 Transmission measurement (NA Mode) and a 2-port Insertion Loss measurement (CAT Mode). In VVM Mode, this is performed using Zero.

When a Normalization is performed, the forward and reverse transmission tracking terms from CalReady are updated to account for the THRU that is used during the normalization process.

How to perform a Simple Response Cal

- Select the measurements to be calibrated. See the relevant Mode (NA, CAT, or VVM) for measurement selections.
- Press **Cal 5** then **Response Cal**
- For 1-port measurements:
 - Select either **Open Response** or **Short Response** for the port to be calibrated. The availability of this calibration on Port 2 may require an option.
 - **Connect** an OPEN or SHORT standard to the specified port and press **Measure**
- For 2-port measurements:
 - Select **Normalization**
 - Connect a short, high-quality, phase stable cable between the FieldFox port 1 and port 2 connectors, then press **Measure**

NOTE

With a Normalization Cal, all subsequent insertion loss measurements are made relative to the insertion loss of the cable used as the THRU standard. For example, if you use a cable with 1 dB of loss, then after Normalization, the display will show 0 dB of loss with this cable in place. Therefore, for highest accuracy, when measuring the DUT also attach the cable that was used in the normalization cal.

-
- Press **Finish**.
 - Connect the DUT.

CAL ON U is shown on the screen when a User Cal (Ex: Response Cal) is correcting ONLY the appropriate measurement. For example, when an Open Response Cal on Port 2 is performed, **CAL ON U** is shown for an S22 measurement only.

View Cal

From the **Choose Calibration** screen (see [“How to Perform a Calibration” on page 135](#)), press View Cal to see the following screen:

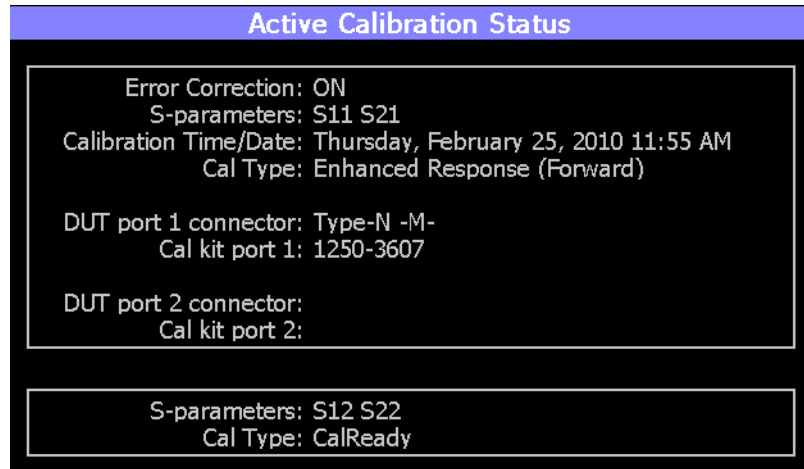

The top box shows the properties of the current calibration that you performed and the displayed S-parameters that it is correcting.

The bottom box shows the S-parameters that are displayed but NOT corrected by the current performed calibration, but rather the CalReady calibration. Learn more about CalReady in [“CalReady” on page 135](#).

Calibration Type

The FieldFox simplifies the calibration process by recommending the most accurate and efficient calibration type based on the displayed S-parameters.

However, there may be times when you may want a little more accuracy or a little faster sweep time. The following information can help you learn about the various calibration choices.

Definitions:

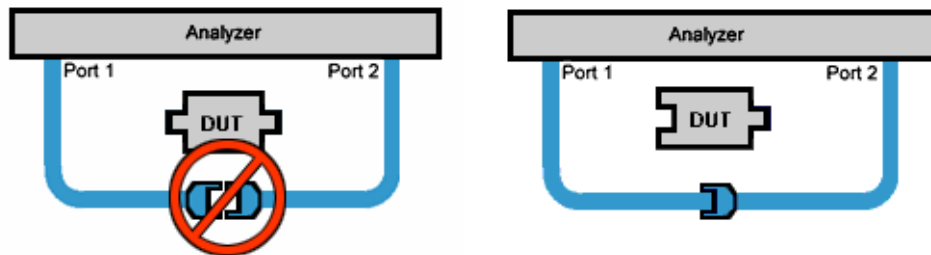

Non-insertable DUT – A device whose connectors could NOT mate together. They either do not have the same type of connector or they have the same gender. This also means that the test port cables could NOT mate together as in the above diagram.

Insertable DUT – A device whose connectors could mate together. They have the same type of connector and opposite or no gender. This also means that the test port cables could mate together, as in the above diagram.

Defined THRU – A THRU standard for which there is a Cal Kit definition such as in the 8551xA Cal Kits.

Flush THRU (also known as Zero length THRU) – When the test port cables mate together when measuring an Insertable DUT. No actual THRU standard is required because the test port cables are directly connected. Flush THRU is also a Defined THRU with a definition of zero loss and zero length.

Unknown THRU – Any THRU connection between the test ports. For more information see the FieldFox Supplemental Online Help:
<http://na.support.keysight.com/fieldfox/help/SupHelp/FieldFox.htm>

Sweep Directions – Both FULL 2-Port Cals listed below result in correction that requires background measurements sweeps in both directions, regardless of the displayed measurements. The displayed traces are updated at a slower rate than Enhanced Response and 1-port calibrations, which require sweeps in one direction only.

1-Port (OSL)

- DUT: No restrictions
- S-parameters Corrected: S11 or S22
- Standards: OPEN, SHORT, LOAD
- Sweeps in ONE direction.

FULL 2-Port (May require an option)

- Most comprehensive calibration. Corrects all S-parameters
- DUT: Non-Insertable or Insertable
- Standards: OPEN, SHORT, LOAD on **BOTH** ports. Any THRU between ports.

Based on the SOLR/Unknown THRU calibration. For more information on the Unknown THRU process, see the FieldFox Supplemental Online Help: <http://na.support.keysight.com/fieldfox/help/SupHelp/FieldFox.htm>

Sweeps in BOTH directions.

FULL 2-Port (QSOLT) – Mechanical Cal ONLY (May require an option)

Quicker to perform QSOLT than Full 2-port. Corrects all S-parameters.

DUT: Insertable only

Standards: OPEN, SHORT, LOAD on port 1. Flush THRU between ports.

Recommended cal type for Insertable DUTs. A Cal Kit is NOT required for port 2.

Sweeps in BOTH directions.

Enhanced Response Cal - Forward OR Reverse (May require an option)

Faster measurements than Full 2-Port.

DUT: Non-Insertable or Insertable. S-parameters PARTIALLY Corrected: S21 and S11 (Forward) **OR** S12 and S22 (Reverse)

Standards: OPEN, SHORT, LOAD on **ONE** port. Defined or Flush THRU between ports.

Sweeps in ONE direction.

NOTE

Also select an Enhanced Response Optimization. Learn more in [“Enhanced Response Optimization” on page 152.](#)

TRL – Mechanical Cal ONLY

A complete 2-Port calibration with potentially better accuracy than Full 2-port. Corrects all S-parameters.

DUT: Non-Insertable or Insertable

Standards: Thru, Reflect, Line or variations of these. A TRL Cal Kit **MUST** be selected to see this Cal Type

Sweeps in BOTH directions.

Learn more about TRL Calibration in the Supplemental Online Help: <http://na.support.keysight.com/fieldfox/help/SupHelp/FieldFox.htm>

1-port Response Cals (Open or Short)

Calibrate the magnitude and phase of a measurement using ‘modeled’ mechanical standards. Measurement accuracy is better than Simple Response Cals (available on the main Cal page - see [“Calibration Type” on page 147](#)) but NOT as good as full 1-port cal. Corrects either S11 or S22. Can be used with Isolation (see following section). Learn more in [“Simple Response Cals ” on page 145](#)

DUT: Non-Insertable or Insertable

S-parameters Corrected: S11 or S22

Standards: OPEN or SHORT on ONE port

Sweeps in BOTH directions.

Isolation Step

The optional isolation step of a calibration corrects for crosstalk which is the internal signal leakage between the test ports. The Isolation step measures Load standards that are connected to one or both FieldFox test ports.

Perform an isolation calibration when you are testing a device with high insertion loss, such as the stop band of a filter or a switch in the open position.

The isolation step can add noise to the error model when the measurement is very close to the noise floor of the analyzer. To improve measurement accuracy, set a narrow IF Bandwidth during the calibration.

The Isolation step is NOT allowed with ECal.

How to perform the Isolation step

- Press **Cal 5** then **Mechanical Cal / ECal**
- Then **Advanced**
- Then **Omit Isolation**
 - **OFF** Perform the Isolation step
 - **ON** (default) Omits the Isolation step
- Then **<Back**
- Configure and perform the calibration as usual. At the first step of the Cal you will be prompted to connect a Load standard to one or both test ports.

NOTE

If the first calibration step does NOT prompt you to connect Load standards, then the Cal Kit probably does not contain an Isolation standard. You can use DataLink software to edit the Cal Kit and add an isolation standard using a Load standard. See Data Link Help for more information:

<https://na.support.keysight.com/fieldfox/help/DataLinkHelp/DataLink.htm>

-
- This setting survives an Instrument Preset.

Waveguide Calibrations

In general, calibrating with Waveguide is very similar to calibrating with coax. However, most coax mechanical Cal Kits have standards that can be used over a very wide frequency range. Waveguide Cal Kits are used over a narrow

frequency range. Therefore, it is VERY IMPORTANT to set the frequency range of the measurement WITHIN the frequency range of the waveguide Cal Kit. Otherwise, an error message will appear during the 'Calculating Steps' portion of the calibration.

Waveguide Cal Kits

Keysight sells two waveguide Cal Kit series: the premium 11644A series and the economy N9911X series. Both are available online at www.Keysight.com

Effective Velocity Factor

Velocity factor is the speed at which an electromagnetic signal passes through the transmission medium relative to the speed of light. This value is important when distance is being calculated in DTF measurements (CAT mode) and Time Domain (NA mode).

When the media is waveguide, the velocity factor changes with frequency. FieldFox calculates this 'effective' velocity factor automatically. However, the settings are different for CAT mode and NA mode.

CAT Mode - How to make Waveguide settings

These settings are necessary ONLY when making DTF measurements.

- Press **Measure 1** then **Distance to Fault (dB)** to select a **DTF** measurement.
- Press **Meas Setup 4**
- Then **Settings** (Learn how to use the Quick Settings table in “How to view and change Quick Settings” on page 58.)
- Set **Media = Waveguide**. Frequency Mode = **BandPass** is automatically selected for you.
- Scroll down to **Waveguide Definitions**. Select the **Waveguide Standard** being used. If your waveguide standard is NOT listed:
 - Select **User Waveguide**. Then press **Done**.
 - Then **DTF Cable Specifications**, then **Edit/Save/Recall Cables**, then **Edit Cable**.
 - Scroll to set **Waveguide Definition**. The default setting is **VF Corr = Auto**.
 - Set the Min, Max, and Cutoff Frequencies.
- Press **Done**, then press **Back**.
- **Cable Correction = Auto** is the default setting. The Effective Velocity Factor is calculated automatically based on the frequencies of the waveguide standard. To override this setting, set Cable Corr = **Man**.

NA Mode - How to make Waveguide settings

These settings are necessary ONLY when your measurement requires electrical delay or port extensions, or if using Time Domain Transform.

- Press **Meas Setup 4**
- Then **Transform**
- Then **Transform Settings**
- Under **Transform Stimulus Settings**, set the **Start** and **Stop** frequencies to those of the Waveguide.
- Set **Stimulus = Bandpass Impulse**
- Press **Done**
- Press **Meas Setup 4** or **Back**
- Then **Calibration Settings**
- Set **Media = Waveguide**
- Set **Cutoff Frequency**. This is the absolute minimum frequency of the waveguide. This value must be less than the Start Frequency of the Waveguide.

Enter the calculated **Effective VF** value into the Velocity Factor setting.

Enhanced Response Optimization

When Enhanced Response Cal Type is selected, either for one calibration or for CalReady, this setting optimizes the calibration based on the type of DUT being measured. See also: CalReady Properties in **“CalReady” on page 135**.

This setting does NOT survive Preset.

- Press **Cal 5** then **More**
- Then **Enh.Response**
- Then choose from:
 - **NonReciprocal** (default) An amplifier is a Non-Reciprocal device because it has gain in the forward direction, and very high loss (isolation) in the reverse direction. This choice provides the best correction for non-reciprocal devices, and reasonable correction for reciprocal devices.
 - **Reciprocal** A reciprocal DUT is a device in which the insertion loss through the device is equal in both the forward (S21) and reverse (S12) directions. A cable is a reciprocal device. This choice provides the best correction for reciprocal devices. However, S11 measurements on non-reciprocal devices will appear to have more return loss than the non-reciprocal choice.

Interpolation *

Highest measurement accuracy is achieved when the frequency range or resolution settings remain the same during the measurement as when the FieldFox was calibrated. If these settings change after performing a calibration, the FieldFox will interpolate the calibration so that VERY accurate measurements continue to be made.

Interpolated Calibrations are only slightly less accurate than a calibration performed at the measurement settings. Learn more about the relative accuracy of FieldFox calibrations in **“Cal ON? – Questionable Accuracy” on page 153.**

When a calibration that you performed is being interpolated, an asterisk is added to the Cal annotation. For example: Cal ON U* is shown on the screen when the current Response or Mechanical cal is being interpolated. An * is never added to a CalRdy.

Cal ON? – Questionable Accuracy

When the Output Power, Interference Rejection, or IF BW (NA Mode ONLY) setting is changed AFTER performing a calibration, a question mark is added to the Cal annotation.

The resulting measurement accuracy depends on how much the setting has changed. For highest accuracy, recalibrate using the new settings.

Compatible Mode Calibrations

The FieldFox can have only ONE calibration present for all modes. Because NA, CAT, and VVM modes are very similar, a calibration that is performed in one mode can also be applied in the other modes with the same type of measurements (1-port or 2-port).

To apply a Cal that was performed in a different mode, press **Cal 5** then select **User Cal ON**.

Save the Calibration

After performing any type of calibration, you can save the FieldFox settings along with the calibration into a STATE (*.sta) file. These settings and calibration can then be recalled as necessary. To learn how, see **“Saving and Recalling Files” on page 768.**

CalReady Properties

There are several factory calibrations (CalReady) on every FieldFox. These can be selected based on the type of DUT that you measure most often, and the compromise that you prefer to make between measurement speed versus measurement accuracy. Remember, CalReady was performed at the test ports. Therefore, a CalReady calibration is most accurate when the DUT is directly connected to the test ports. Learn more in [“CalReady” on page 135](#).

This setting does NOT survive Preset or Power ON/OFF.

- Press **Cal 5** then **More**
- Then press **CalReady** to toggle between the following selections:
 - **2-Port Cal** (default) Corrects all four S-parameters. Requires a forward and reverse sweep, which causes slower trace measurements. Learn why in [“Calibration Type” on page 147](#).
 - **Enh. Response** Corrects forward (S21 and S11) and reverse (S12 and S22) measurements separately. Therefore, when measurements in only one direction are required, this choice provides faster trace measurements than a full 2-port cal. Also choose an Enhanced Response Optimization. Learn more in [“Enhanced Response Optimization” on page 152](#).

To find the best choice for your DUT:

- Press **Preset** then **Preset**.
- Select the appropriate S-Parameter and other settings (frequency range, resolution, and so forth).
- Press **Trace 6** then **Math and Memory** then **Data->Mem**.
- Press **Data & Memory**.
- Press **Cal 5** then **More**
- Select a CalReady Cal to compare with the current setting.
- Press **Esc** to exit the cal menu.
- View the differences in the two traces.

Apply Nearest (NA Mode Only)

When **Apply Nearest** is pressed, interpolation is turned off and the nearest calibration point is applied when the start stop frequencies are changed for the current sweep.

CAUTION

IMPORTANT!

- Apply Nearest needs to re-selected after each pair of start and stop frequency points is entered, because the Apply Nearest feature is disabled when a new start stop frequency pair is selected.
- Apply Nearest calculates the number of points based on the start and stop frequency points entered.
- Apply Nearest will display the following error when there is no valid calibration found:

“Error: 225, The required user calibration is not present.”

To use **Apply Nearest**:

- Press **Cal 5** > **More** > **Apply Nearest**

Verifying Calibration and Jumper Cable Integrity

After calibrating, it is important to verify that the calibration is good. When using a jumper cable, also verify that the cable is of high quality.

Verify a Calibration

- Connect a LOAD standard at the calibration reference plane (where calibration standards were connected). This may be at the end of the jumper cable or at FieldFox **PORT 1** connector.
- In CAT Mode, select **Return Loss**.
- In NA Mode, select **S11** with Log Mag format.
- For frequencies **lower than 9 GHz**, observe the trace on the FieldFox screen:
 - Lower than 35 dB indicates a GOOD calibration.
 - Higher than 30 dB indicates that you should recalibrate.

Verifying Phase Accuracy

- Connect a LOAD standard at the calibration reference plane (where calibration standards were connected).
- In NA Mode, select a S11 Reflection with Polar or Smith Chart format.

- Because all LOAD standards have delay, you should see a small amount of phase rotation as a function of frequency. In general, the measurement result should agree with the characteristics of the calibration standard.

Test the Jumper Cable

With the LOAD standard still connected, move the jumper cable while observing the trace.

- If the measurement trace is relatively stable, the jumper cable is of good quality.
- If you observe significant movement in the peaks of the measurement trace when moving the cable (>5 dB), the jumper cable may need to be replaced.

Calibration Method Summary

- **Mechanical Full 2-port Cal** is ALWAYS the most accurate Cal method. The quality of a Mechanical Cal is completely dependent on the quality of the OPEN, SHORT, LOAD standards and the quality of the standard connections. Use the correct high quality standards to ensure the most accurate calibration.
 - Even with the optional Load, phase accuracy begins to degrade when the return loss is greater than about 20dB.
- **QuickCal** is ideal for DTF measurements. QuickCal should be performed when good accuracy is required and when using a jumper cable or adapter.

NOTE

QuickCal is only available on N991xA/2xA/3xA models.

-
- QuickCal is NOT recommended when the DUT has 3.5 mm-female or SMA-female connectors.
 - Even with the optional Load, phase accuracy begins to degrade when the return loss is greater than about 20dB.
 - **CalReady** is accurate ONLY when the DUT is directly connected at the test ports and most accurate at room temperature.
 - **For highest accuracy**, a new Mechanical Cal should be performed:
 - When the temperature changes more than about 10°F (5°C)
 - When the connection to the DUT requires a different jumper cable or adapters.
 - When any of the following measurement settings change: Frequency Range, Power Level, IF BW, and Resolution.

Calibration for NA, CAT, and VVM Modes
Calibration Method Summary

9 SA (Spectrum Analyzer) Mode (Option 233–Mixed Analyzers)

NOTE

To better reflect the enhancements implemented during the alignment process, for firmware versions >A.10.15 “IF Flatness Alignment” is now referred to as “Channel Equalization” or “Channel Equalization Alignment” ([ChanEQ Alignment](#)).

SA Mode measures signals at the **SA RF IN** connector.

SA Mode measurements require NO calibration.

For a comprehensive SA mode tutorial, see Spectrum Analysis Basics (App Note 150) at

<https://www.keysight.com/us/en/assets/7018-06714/application-notes/5952-0292.pdf>

For information on using the FieldFox Remote Viewer which enables you to view the FieldFox from your iOS device, refer to

<https://www.keysight.com/us/en/assets/7018-04070/application-notes/5991-2938.pdf>

Figure 9-1 SA Display with Markers

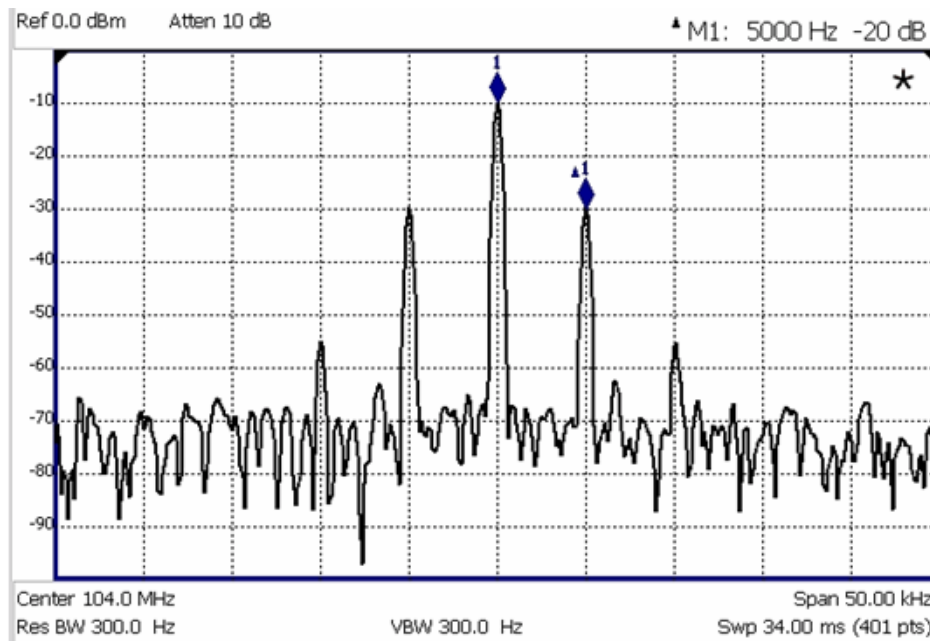

**The graphic above shows an SA display with markers.
Carrier with 5 kHz frequency modulation and deviation of 1 kHz.**

In this Chapter

[“Frequency Range” on page 163](#)

[“Radio Standard” on page 165](#)

[“Channel Selection” on page 166](#)

[“Reverse Swap” on page 168](#)

[“Scale and Units” on page 168](#)

[“External Gain” on page 169](#)

[“Attenuation Control” on page 170](#)

[“Preamplifier Control \(Opt 235\)” on page 171](#)

[“Check for Compressed Measurements” on page 171](#)

[“Field Strength Measurements” on page 172](#)

[“Using the Antenna/Cable Editor” on page 174](#)

[“Source Tracking Offset and Offset Reversal” on page 176](#)

[“Tune & Listen \(AM/FM\)” on page 177](#)

[“Analog Demod \(Requires CPU2\)” on page 181](#)

[“Independent Source/Tracking Generator” on page 193](#)

[“Resolution Bandwidth \(Res BW\)” on page 194](#)

[“Video Bandwidth \(Video BW\)” on page 195](#)

[“AF RBW \(Audio-Frequency Resolution BW\)” on page 196](#)

[“Sweep Type” on page 196](#)

[“IF Output” on page 197](#)

[“Sweep Acquisition” on page 199](#)

[“Very Long Sweep Times” on page 200](#)

[“Zero Span Measurements” on page 200](#)

[“Triggering” on page 202](#)

[“FFT Gating \(Opt 238\)” on page 206](#)

[“Single / Continuous / Restart” on page 208](#)

[“Points” on page 208](#)

[“Trace Display States \(SA Mode\)” on page 208](#)

[“Average Type” on page 209](#)

[“Average Count” on page 210](#)

[“Alignments” on page 211](#)

[“RF Burst Amplitude Alignment” on page 216](#)

[“Detection Method” on page 218](#)

[“Display Line” on page 220](#)

[“Noise Marker” on page 221](#)

[“Band/Interval Power Marker” on page 221](#)

[“Frequency Counter at Marker” on page 222](#)

[“Audio Beep at Marker Power” on page 223](#)

[“Meas UNCAL Error” on page 224](#)

[“Old Data Indicator \(*\)” on page 224](#)

[“Radio Standards and Channel Measurements” on page 225](#)

[“Measurement Preset” on page 225](#)

[“Averaging” on page 225](#)

[“Traces” on page 226](#)

[“Channel Power \(CHP\)” on page 226](#)

[“How to Set Up EMF Settings \(Requires EMF \(Option 358\), GPS \(Option 307\), and SA Mode \(Option 233–Mixed Analyzers\)\)” on page 236](#)

[“Spectrum Emission Mask \(SEM\) – \(Requires CPU2, SA Mode Only\)” on page 248](#)

[“IQ Analysis \(Requires Option 351 IQ Analyzer and Option 353 IQ Streaming, SA Mode Only\)” on page 255](#)

[“Effective Isotropic Radiated Power \(EIRP\) – \(Requires CPU2, SA Mode Only\)” on page 258](#)

See Also

Interference Analyzer:

[“Record/Playback \(SA Option\)” on page 510](#)

[“Waterfall Display” on page 509](#)

[“Record/Playback \(SA Option\)” on page 510](#)

Optional Settings:

[“All about Markers” on page 692](#)

[“All about Limit Lines” on page 707](#)

[“Saving and Recalling Files” on page 768](#)

SA Mode Settings

Select SA Mode before making any setting in this chapter.

Because there is no calibration, these settings can be made in any order.

How to select SA Mode

- Press **Mode**
- Then **SA**.

Frequency Range

The X-axis frequency range determines the frequencies that are measured for each sweep. The default Start frequency is 0 Hz. However, the Start frequency can be set as low as –100 MHz. The internal LO of the FieldFox can be seen at 0 Hz, which will mask signals that may be present.

NOTE

Although the start frequency can be set as low as –100 MHz, amplitude accuracy is specified above 100 kHz. Below 100 kHz, frequency accuracy is maintained, but amplitude accuracy is degraded.

The FieldFox can be used with an OML frequency extender. Refer to [“Utilities” on page 724](#), the [A Series FieldFox Configuration Guide 5990-9836EN](#), and to [“Contacting Keysight” on page 5](#).

Available ONLY with Opt. 209 and while in Step sweep, SA mode allows reverse sweeps. This means the Start frequency can be higher than the Stop frequency. In addition, the **Reverse Swap** feature can be used to quickly reverse the Start and Stop frequencies. Learn how in [“Reverse Swap” on page 168](#).

The frequency range of the measurement can be changed using the following methods:

- Set Center and Span frequencies
- Set Start and Stop frequencies
- Toggle between Zero and Last selected span
- Set Full Span of the FieldFox
- Using Channel selection. Learn how in [“Channel Selection” on page 166](#).
- Using Marker -> Center (frequency). Learn how in [“SA Marker Functions” on page 706](#).

How to set Frequency Range

- Press **Freq/Dist**.
- Then choose from the following:

- **Center** and **Freq Span** frequencies. This is the most common method of entering frequency range. Enter the frequency of interest. The Center frequency is at the exact center of the X-axis. The Frequency Span places half of the frequency range on either side of center. When the Center and Frequency Span values are entered, then the X-axis annotation on the screen shows the Center and Span frequencies.
- **Start** and **Stop** frequencies. Start is the beginning of the X-axis and Stop is the end of the X-axis. When the Start and Stop frequencies are entered, then the X-axis annotation on the screen shows the Start and Stop frequencies.
- Follow each of these by entering a value using the numeric keypad, the **▲▼** arrows, or the rotary knob.
- When using the **▲▼** arrows, press **Enter**. The increment setting of the arrows is based on the current span. This can be changed in SA Mode. See **How to change frequency step size** below.
- After using the keypad, select a multiplier key. Learn more in **“Multiplier Abbreviations” on page 53**.

Two more ways to change the frequency range

- Press **Freq/Dist**
- Then choose from the following:
 - **Zero/Last Span** Each key press toggles the frequency span between 0 Hz and the last specified frequency span. Learn more about Zero Span in **“Zero Span Measurements” on page 200**.
 - **More**
 - Then **Full Span** Selects the entire frequency span of the FieldFox. The Center frequency is set automatically.

How to change frequency step size

When using the **▲▼** arrows to change any of the frequency settings, the size of the frequency step can be changed.

- Press **Freq/Dist**
- Then **More**
- Then **CF Step Auto Manual**
 - **Auto** Each press of the **▲▼** arrows increments or decrements the value by 1/10th (one division) of the current frequency span. **Note:** To change this setting from **Manual** to **Auto**, press **CF Step** twice.

- **Manual** Type a step size value using the numeric keypad, then select a multiplier key. Learn more in “**Multiplier Abbreviations**” on page 53.

Radio Standard

A Radio Standard is a collection of settings that are applied to the FieldFox for specific RF protocols. When a Radio Standard is applied, the FieldFox frequency and channel settings change to that of the standard.

By default, the FieldFox locates the center frequency of the standard in the middle of the screen and sets the frequency span to cover all of the Uplink and Downlink frequencies. The selected Radio Standard name appears in the center of the screen below the X-axis.

After a Radio Standard has been selected, the frequency range can be changed by selecting channel numbers rather than frequency. Learn how in “**How to set Frequency Range**” on page 163.

When a Channel Measurement is selected such as ACPR, other relevant settings will be changed such as Integration BW. Learn more about Radio Standards and Channel Measurements in “**Radio Standards and Channel Measurements**” on page 225.

How to select a Radio Standard

- Press **Measure 1** OR **Freq/Dist** then **More**
- Then **Radio Standard**
- Then **Radio Standard**
- Then select a standard using the **▲▼** arrows or rotary knob and press **Enter**.

Custom Radio Standards

Your own custom Radio Standards can be imported into the FieldFox. Custom standards are created in *.csv (spreadsheet) format.

A template and instructions for creating your custom Radio Standard is at: <http://na.support.keysight.com/fieldfox/help/SupHelp/Reference/CustomRadioStandard.htm>

Once imported, the *.csv file is stored in the FieldFox \User Data\ folder. The custom Radio Standards are read and presented at the top of the list of internal Radio Standards.

How to Import and Delete a Custom Radio Standard

First, press **Save/Recall** and select the **Device** from which the Radio Standard will be read. Most likely this will be **USB** or **SD Card**.

- Press **Measure 1** OR **Freq/Dist** then **More**

- Then **Radio Standard**
- Then **Radio Standard**
- Then **Import Radio Standards**
- Then select the *.csv file using the **▲▼** arrows or rotary knob and press **Enter**.
- Custom Radio Standards can be removed from the FieldFox by selecting **Measure 1** then **Radio Standard** then **Delete Radio Standard**.
- Then select the *.csv file to delete using the **▲▼** arrows or rotary knob and press **Enter**.

NOTE

To overwrite a custom standard that is already uploaded to the FieldFox, you must first delete the *.csv file from the FieldFox, then re-upload the file that contains the standard. A predefined internal standard (such as GSM 450) can NOT be deleted from the FieldFox.

Channel Selection

After a Radio Standard has been selected, the frequency range can be changed by selecting channel numbers rather than frequency. Once enabled, the channel number is appended to the X-axis frequency range.

How to Enable Channel selection

- Press **Freq/Dist**
- Then **More**
- Then **Unit Freq Chan**

With Unit = **Chan**, **Channel Direction** becomes available and **CF Step** alters to **Channel Step**.

How to change the Channel Number of the Measurement

With Unit = **Chan** the FieldFox will NOT allow you to specify channels outside of the selected Radio Standard.

- Press **Freq/Dist**
- Then choose from the following:
 - **Center Channel** Places the center frequency of the specified channel in the middle of the X-axis.
 - **Start Channel** Places the lowest frequency of the specified channel at the beginning of the X-axis.
 - **Stop Channel** Places the highest frequency of the specified channel at the end of the X-axis.

- **Freq Span** Changes the span of frequencies while the center frequency remains unchanged.
- Follow each of the above settings by entering a value using the numeric keypad or the rotary knob.
- Use the **▲▼** arrows to increment the channel number by an amount specified by the Channel Step value (see below).
- Then press **Enter** or **Enter**.

Select either Uplink or Downlink Frequencies

Press **Freq/Dist** then **More**. Press **Chan Direction** to toggle between **Uplink** and **Downlink**. If either of these selections is not available, then the selected Radio Standard does not contain those frequencies. In that case, **Chan Direction** is grayed out.

Channel number X-axis annotation

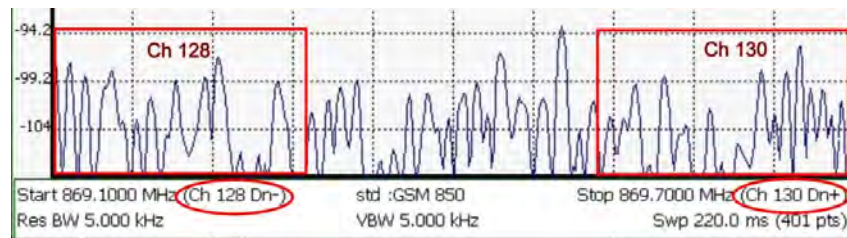

- **Dn** indicates **Downlink** channels.
- **Up** (not shown) indicates **Uplink** channels
- **(-)** indicates that the lowest frequency in the channel (128) is at the left edge of the screen.
- **(+)** indicates that the highest frequency in the channel (130) is at the right edge of the screen.
- When Center Channel or Freq Span is specified, the X-axis shows the Center Freq (Channel) and Frequency Span.
- When Start or Stop Channel is specified, the X-axis shows the Start Freq (Channel) and Stop Freq (Channel).

Change Channel Step Size (Optional)

This setting allows you to use the **▲▼** arrows to increment the channel number by the specified value. The **Channel Step** softkey appears only when it is valid. Learn how to make it valid in the section, “See How to change the Channel Number of the measurement”

- Press **Freq/Dist** then **More**.
- Press **Channel Step**

- Enter a step value using the numeric keypad, the  arrows, or the rotary knob. Then press **Enter**.

Reverse Swap

Available ONLY with Opt. 209 and while in Step sweep mode. Each press of the softkey causes the Start and Stop frequencies to swap. The Start becomes the Stop and vice versa. Learn more about Step versus FFT sweeps in **“FFT Gating (Opt 238)” on page 206**.

- Press **Freq/Dist** then **More**.
- Then **Reverse Swap**

Scale and Units

Adjust the Y-axis scale to see the relevant portions of the data trace.

The Y-axis is divided into 10 graticules. A acquisition is shown on the screen as a solid horizontal bar that can be placed at any graticule.

When RF Attenuation set to **Auto**, the RF Attenuation is coupled to acquisition.

How to set Scale

Press **Scale / Amptd**. Then choose from the following:

- **Autoscale** Automatically adjusts the Y-axis to comfortably fit the Minimum and Maximum amplitude of the trace on the screen.
- **Scale** Manually adjust the scale per division to view specific areas of the current trace. Enter a value using the numeric keypad, the  arrows, or the rotary knob. Then press **Enter**.
- **Ref Level** Manually set the value of the reference line. Enter a negative value by pressing **Run/Hold (+/-)** either before or after typing a value. This can also change the RF Attenuation setting. See **“Attenuation Control” on page 170**.
- **Preamp** Refer to **“Preamplifier Control (Opt 235)” on page 171**.
- **RF Atten** Refer to **“Attenuation Control” on page 170**.
- **More** opens another set of scale softkeys.

Manually set Scale Type, acquisition, and Reference Position.

- **Scale Type [current setting]**

- **Log** Logarithmic scale (default setting). The Y-axis reference line represents the specified absolute acquisition in the current Unit selection. Y-axis graticules show dB below or above the reference line.
- **Lin** Linear scale. The Y-axis reference line represents the specified absolute acquisition in the current Unit selection. Y-axis graticules show percent of acquisition (%) below or above the reference line.
- **Unit** Refer to “[How to Set Y-axis Units](#)” on page 169.
- **Corrections** Refer to “[How to select and edit corrections for Field Strength measurements](#)” on page 172.
- **External Gain** Refer to “[External Gain](#)” on page 169.
- **Ref Pos** Manually set the position of the reference line. Values must be between 0 (TOP line) and 10 (BOTTOM line). Default position is zero (top).

How to Set Y-axis Units

The Unit setting appears for the reference line, marker readouts, and trigger level. All Unit choices are available in both Log and Linear Scale Types.

The UNIT setting survives Mode Preset, but NOT Preset.

- Press **Scale / Amptd**, then **More**, then **Unit**
- Then choose from the following:
 - **dBm** (default setting), **dBmV** (dB milli Volts), **dBuV** (dB microVolts), **W** (watts), **V** (volts), **A** (amps), **dBmA** (dB milliAmps), **dBuA** (dB microAmps).

Antenna correction units are available ONLY by loading or editing an Antenna file that contains the desired units setting. Learn more In.

External Gain

When using an external amplifier or attenuator, the SA mode trace amplitude values can be offset to compensate for the effect of the external device. This effectively moves the reference plane of the SA measurement port out to just beyond the external device. For example, when using an external preamp with gain of +10 dB, enter this value for External Gain, and the data trace across the displayed frequency span will be adjusted down by 10 dB.

When RF Atten is set to Auto, you may see a change in the RF Attenuation value. This is an attempt to measure the signal at top of screen (the acquisition) without overloading the SA first mixer.

How to Set External Gain

- Press **Scale/Amptd**.

- Then **More**
- Then **External Gain**
- Enter a value using the numeric keypad, the **▲▼** arrows, or the rotary knob (positive for gain; negative for loss). Values less than 5 dB must be typed using the numeric keypad. Then press **Enter**

ExtGain xx dB is shown at the top of the screen.

Attenuation Control

Both the RF Attenuation and Preamp functions control the power level into the SA.

When too much power is present at the RF Input port, **ADC Over Range** appears on the FieldFox screen. This does not necessarily mean that damage has occurred, but that the measurement is probably compressed.

When high power levels are present at the RF Input port, internal attenuation can be switched in to keep the FieldFox receiver from compressing. At extremely high power levels, use external attenuation to protect the internal circuitry from being damaged.

CAUTION

The FieldFox can be damaged with too much power. Refer to the FieldFox Data Sheet for your model on <https://www.keysight.com/us/en/assets/7018-06516/data-sheets/5992-3702.pdf>.

Maximum Input Voltages and Power:

RF Output Connector: 50V DC, +23 dBm RF

Ext Trig/Ref Connector: 5.5 V DC

RF Input:

+27 dBm RF, ± 50 VDC Max. (N991xA/B, N9925B, N9926A, N9928A, N993xA/B)

+23 dBm RF, ± 50 VDC Max. (N9923A, N9923AN)

+25 dBm RF, ± 40 VDC Max. (N995xA/B, N996xA/B)

DC Input: 19VDC, 4ADC, 60 Watts maximum when charging battery

The displayed power level is automatically adjusted for RF Attenuation. As the attenuation value changes, the displayed power level should NOT change.

How to set Attenuation

- Press **Scale/Amptd.**
- Then **RF Atten Auto Man.**

- **Auto** RF Attenuation is set by adjusting the acquisition. As the acquisition is lowered, for example from –10 dBm to –30 dBm, the FieldFox assumes that you are looking at low-level signals. The RF Attenuation value is automatically lowered in 5 dB steps to allow low-level signals to be viewed. The RF Attenuation value is never automatically lowered below 5 dB.
- **Man** RF Attenuation is set manually. The default Attenuation setting is 10 dB. Enter a value between 0 to 30 dB in 5 dB steps using the numeric keypad, the **▲▼** arrows, or the rotary knob. Then press **Enter**.
#Atten xx dB is shown at the top of the screen. (#) means manual setting.

Preamplifier Control (Opt 235)

When **very low-level** signals are analyzed, an internal preamplifier can be used to boost the signal level by approximately 22 dB. The gain of the preamp is NOT adjustable. The displayed signal level is automatically adjusted for the increase in system gain.

How to control the Preamp

By default, the preamp is OFF.

- Press **Scale/Amptd**.
- Then **Preamp ON OFF**. The underlined setting is the current setting. When ON, **PA** is shown to the left of the graticules on the display.

Check for Compressed Measurements

Compression occurs when too much power into an amplifier causes it to no longer amplify in a linear manner. When too much power goes into the FieldFox RF Input connector, the amplifiers in the SA receiver compress and signal power will not be displayed accurately. This can occur even if **ADC Over Range** is not displayed because devices other than the ADC, such as the mixer, might be compressed. Increase the RF Attenuation value to prevent the SA receiver from being compressed.

How to Check for a Compressed Measurement

- Using a marker at the signal peak, make note of the signal power level.
- Increase the RF Attenuation level by 5 dB.
 - If the signal level does NOT change, then NO compression exists. This indicates that the signal is in the linear region of the FieldFox receiver.
 - If the signal level DOES increase, then the receiver was compressed. Set the RF Attenuation value at the setting when further increases no longer result in an increase in the displayed power level.

Field Strength Measurements

To measure the strength of any signal transmitted through the air, an antenna must be connected to the FieldFox. The Field Strength feature allows you to enter the frequency response of the receiving antenna (the Antenna Factor) and associated cabling, and then have amplitude corrections automatically compensate the displayed trace for that response.

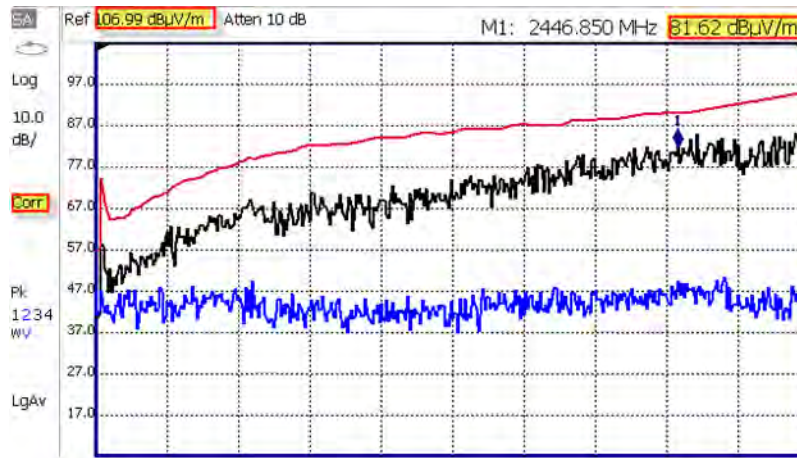

Field Strength Measurements

Trace 1 - Corrected trace with antenna factor. (Antenna = ON, Apply Corr = ON)

Trace 2 - Uncorrected trace (Apply Corr = OFF). The Trace 2 trace state is “View.” For information, refer to [“Trace Display States \(SA Mode\)”](#) on page 208

Pink Trace - Current correction factor. See below.

- Learn how to set Y-Axis **Units** on [“How to Set Y-axis Units”](#) on page 169.
- Use a Band Power marker to measure total power over a range of frequencies. Learn how in [“Band/Interval Power Marker”](#) on page 221

How to select and edit corrections for Field Strength measurements

The Antenna and Cable correction data survives a Mode Preset and Preset.

All Correction ON/OFF states survive a Mode Preset, but NOT a Preset.

- Press **Scale/Amptd** > **More** > **Corrections**.
- Then choose from the following:
 - **Apply Corrections Auto Disabled** Use Auto and Disabled correction for all settings. (Default = Auto).
 - **Antenna Off** – Opens a softkey menu to enable/disable a antenna and edit, save, create a new antenna factors table, recall, and set a storage device location.

- **Cable Off** – Opens a softkey menu to enable/disable a cable and edit, save, create a new cable description table, recall, and set a storage device location.
- **More** – Opens a softkey menu to View Corrections and set the Amplitude Correction type for your antenna.
Learn more, see **“Selecting and Viewing Corrections” on page 173.**
- **SrcSide Antenna Off / On** Edit/Recall an Antenna file to be used to transmit.
- **RcvrSide Antenna Off / On** Edit/Recall an Antenna file to be used to receive.
- **SrcSide Cable Off / On** Edit/Recall a Cable file to be used on the Source side.
- **RcvrSide Cable Off / On** Edit/Recall a Cable file to be used on the Receiver side.

Selecting and Viewing Corrections

- Press **Scale/Amptd** > **More** > **Corrections** > **More**
- **View Corrections ON OFF** Turn ON and OFF Pink Trace - Antenna/Cable corrections. This is a composite of all cable/antenna corrections that are currently applied. Available as a useful visual aid, the zero “dB” level (no net correction) is mapped to appear at the -50 dBm on-screen level.
- **Amp Corr Select [Triaxial XYZ]** - then choose one of the following:
 - **Default** Receiver side only antenna measurements.
 - **Src/Rcvr Split** to work with non-triaxial receiver and source side antenna measurements.
 - **Triaxial XYZ** (default, when Channel Power is on and when a compatible triaxial antenna's factors have been imported) for measuring channel measurements and EMF.

How to Use the Antenna Softkeys

The following menu appears when any of the above Antenna or Cable softkeys are pressed:

- **Antenna/Cable ON OFF** Turn correction ON or OFF for this Antenna/Cable.
- **Edit Antenna/Cable** Edit an Antenna/Cable Correction table. See Using the Antenna/Cable Editor (below) for more information.
- **New** Create a new Antenna/Cable. See Using the Antenna/Cable Editor (below) for more information.

- **Save Antenna/Cable** Save the modified Antenna/Cable to a file on the specified Storage Device.
- **Recall Antenna/Cable** Read an existing Antenna/Cable file from the specified Storage Device.
- **Storage Device** Choose from: Internal, USB, SD. Learn more about these selections in **“Set File Type and Select Device” on page 773.**

When finished, press **Back** to return to the previous menu.

Using the Antenna/Cable Editor

The Antenna Editor and the Cable Editor menus are very similar. Both tables include header information, and a Frequency/Value table.

Figure 9-2 FieldFox Antenna Editor– E-Field and H-Field Units Displayed

Description	Correction Fac		Description	Correction Fac
Freq Interpolation	!LIN		Freq Interpolation	LIN
Antenna Factor Unit	dB /m		Antenna Factor Unit	dB S/m
Frequency	Antenna Factor		Frequency	Antenna Factor
26.00000000 MHz	20.00 dB /m	E-Field Units	26.00000000 MHz	20.000 dB S/m
30.00000000 MHz	17.50 dB /m		30.00000000 MHz	17.500 dB S/m
40.00000000 MHz	13.50 dB /m		40.00000000 MHz	13.500 dB S/m
50.00000000 MHz	10.50 dB /m		50.00000000 MHz	10.500 dB S/m
60.00000000 MHz	8.20 dB /m		60.00000000 MHz	8.200 dB S/m
70.00000000 MHz	7.20 dB /m		70.00000000 MHz	7.200 dB S/m
80.00000000 MHz	7.10 dB /m		80.00000000 MHz	7.100 dB S/m
90.00000000 MHz	7.30 dB /m		90.00000000 MHz	7.300 dB S/m
100.00000000 MHz	7.50 dB /m		100.00000000 MHz	7.500 dB S/m
110.00000000 MHz	7.60 dB /m		110.00000000 MHz	7.600 dB S/m
120.00000000 MHz	7.50 dB /m		120.00000000 MHz	7.500 dB S/m

How to use the Antenna/Cable Editor

- Press **Scale/Amptd** > **More** > **Corrections** then choose:
 - **Antenna Off** to open the antenna editing softkeys
 - **Cable Off** to open the cable editing softkeys

Once you have selected Antenna or Cable to edit:

- Press **New** then **Yes** to clear all data from the existing Antenna or Cable table and reset header information to default settings.
- Then **Edit Antenna** or **Edit Cable** to open the Antenna / Cable Editor.

- Then use the  arrows to select a field.
 - To edit header information, press **Edit** then modify the selected field using the FieldFox labeler.
 - **Description**: Enter a description for the antenna or cable correction table. This is NOT the filename used to save the file.
 - **Antenna Factor Unit** (Rcvr-side Antennas only): Units in which the measurement will be displayed. Select **NONE** (default setting) to select from standard SA Units on the Scale menu. Learn how in **“Scale and Units” on page 168**.
 - Choose from: **dB μ V/m** - (dB micro Volts per meter), **dB μ A/m** - (dB micro Amps per meter), **dBG** (gauss), **dBpT** (tesla).
 - **Freq Interpolation**: Set to LINear and can NOT be edited.
 - To edit **Frequency/Value** pairs, enter numbers using the numeric keypad, and a frequency suffix when necessary.
 - For both **Cable Loss** and **Antenna Factor** values, Positive numbers indicate loss (we need ADD something positive to compensate for it), and Negative is indicative of some existing gain.
 - **Antenna Factor** describes the dB value needed to accurately display a far-field signal in terms that are in the units listed below. When the antenna has low gain, or low efficiency, the dB value to be added is larger.
 - **Antenna Factor Unit** sets the type of antenna factor unit used in your measurement (i.e., dB /m or DB S/m).
 - When one Freq/Value pair is entered, that correction value is applied to the entire displayed frequency span.
 - When two or more Freq/Value pairs are entered, the data points between the lowest and highest frequencies are corrected. Linear interpolation is applied between frequencies when necessary.
- Optionally choose from the following:
 - **Previous / Next Page** Quickly scrolls through pages of Freq/Value data.
 - **Add Row** Add a blank Freq/Value pair to the table,
 - **Delete/Clear** then:
 - **Delete Row** Remove the selected Freq/Value pair from the table.
 - **Clear All** then **Yes** Remove all Freq/Value pairs from the table and resets header information to default settings.

When the table edits are complete

- Press **Done** to close the Antenna/Cable Editor.
- Press **Save Antenna** or **Save Cable** to save your changes to the specified Storage Device. Enter a filename using the FieldFox labeler (learn more in [“How to use the FieldFox labeler ” on page 770](#)). Learn more about Antenna and Cable files below.
- Press **Recall Antenna** or **Recall Cable** to load an Antenna or Cable file from the specified Storage Device.
- **Storage Device** Changes the device used to save or recall files. Choose from Internal (default setting), USB (must be connected) or SD card. This is a different setting from the Save/Recall Storage Device setting.

About Antenna and Cable files

- Cable files are saved and recalled from the **Cables** folder.
- Antenna files are saved and recalled from the **Antenna** folder.
- To **DELETE** Cable or Antenna files, use the Manage Files feature. Learn more in [“Manage Files” on page 776](#).
- If the folder does not already exist on a USB or SD card, it is created automatically before storing the file.
- All SA mode Antenna and Cable files are saved and recalled as *.csv files, which allows them to also be read by spreadsheet programs.
- The FieldFox can also read *.ANT (Antenna) files that were created from older Keysight Spectrum Analyzers.
- SA Mode cable or antenna (*.csv or *.ANT) files can NOT be edited in Data Link software.

How to create a Cable file from an S21 (NA mode) or an Insertion Loss (CAT mode) measurement

1. Measure the S21 or Insertion Loss of a cable. In NA mode, select either LogMag, Linear, or VSWR formats.
2. Use **Manage Folders** to change the active folder to **CABLES**. Learn how in [“Manage Files” on page 776](#).
3. While in NA mode, save the measurement as a *.csv file. Learn how in [“How to Save a File” on page 768](#).
4. In SA mode, select **Corrections**, then recall the *.csv file for correction.

Source Tracking Offset and Offset Reversal

This feature requires:

- N991xA and N995xA FieldFox Combination Analyzers to have Options 209, 210, and 233
- N993xA and N996xA Spectrum Analyzers to have Options 209 and 220

Source offset tracking is used to offset the Source frequency from the Receiver frequency by a fixed offset at every tune frequency. This feature is used when the DUT contains a frequency translation device or mixer.

How to set Tracking Offset and Offset Reversal

- On the Receiver unit, press **Measure 1**
- Then **Source**
- Then **Advanced**
- Then choose one or both of the following:
 - **Tracking Offset** Enter an offset value.
 - **OffsetReversal** Determines whether Receiver Freq is added to or subtracted from the Offset Freq.
 - **OFF** SourceFreq = Offset + RecFreq. Use to measure Upconverters.
 - **ON** SourceFreq = Offset - RecFreq. Use to measure Downconverters. The source sweeps in Reverse direction. Note: The Offset Freq. MUST be larger than the Receiver Stop Freq.

Tune & Listen (AM/FM)

The Tune & Listen feature can be used to identify an interfering AM or FM signal. Also, AM/FM Metrics displays the demodulated signal and the audio frequency spectrum.

The demodulated AM or FM signal can be heard through the internal speaker or through headphones using the 3.5 mm jack located on the FieldFox side panel.

The Tune & Listen tuner is separate from the SA display. This allows you to listen to one frequency while displaying a different range of frequencies. The Tune & Listen measurement alternates between normal SA sweeps for the display and performing audio demodulation at the Tune Frequency. See the Listen Time setting for more information.

Figure 9-3 Tune & Listen ON

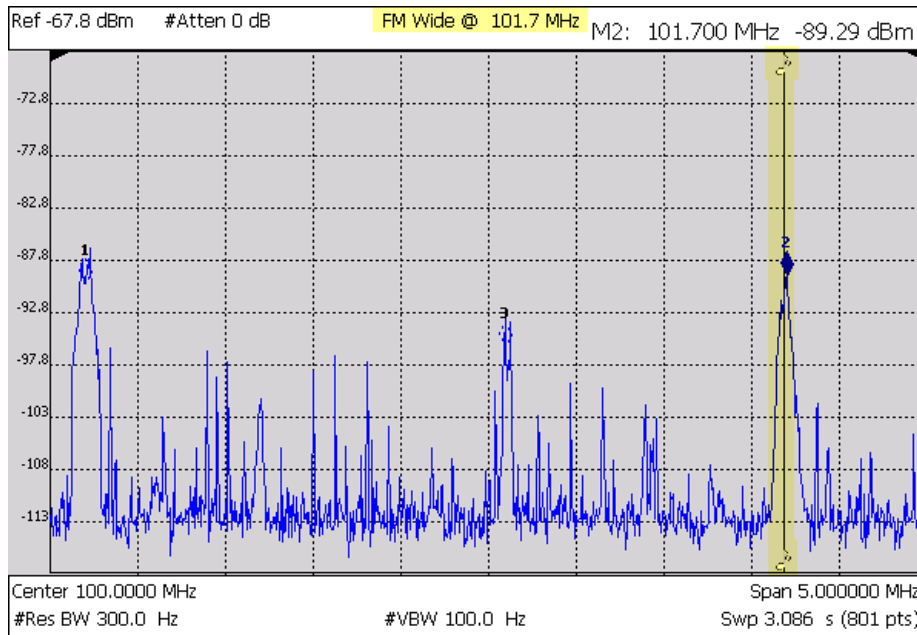

In the graphic above, Tune & Listen ON with Tune Frequency is indicated by a vertical bar (highlighted).

This section contains the following:

“How to select Tune & Listen” on page 178

– “TnL AM SSB Gain” on page 179

“Tune Frequency” on page 179

“Listen Time” on page 180

“To select Listen Time:” on page 180

“Volume Control” on page 180

“Audio Demod ON and OFF” on page 181

“Setting the Marker Counter Gate Softkey” on page 189

“Setting the Mkr->TuneFreq Softkey” on page 181

How to select Tune & Listen

- Press **Measure 1**
- Then **Analog Demod Tune & Listen** > **Tune & Listen**

- Then choose a demodulation type. Select a setting based on the type of interfering signal you suspect is being broadcast.
 - **Press Meas Setup 4** > **TnL Demod Type** then
 - **AM** – Sets AM (Double-sideband with carrier) as the modulation type.
 - **FM Narrow** – Sets Frequency Modulation; Narrow bandwidth. Choose when interfering transmission consist of voice or data.
 - **FM Wide** – Sets Frequency Modulation; Narrow bandwidth. Choose when interfering transmission consist of voice or data.
 - **AM USB** – Sets the modulation type to AM upper side band. Annotation: AM USB @ *Center Frequency* displayed at the top of display. See also, “**TnL AM SSB Gain**”.
 - **AM LSB** – Sets the modulation type to AM lower side band. Annotation: AM LSB @ *Center Frequency* displayed at the top of display. See also, “**TnL AM SSB Gain**”.

See also, “**How to select Analog Demod (Metrics)**” on page 183.

TnL AM SSB Gain

When you select **AM USB** or **AM LSB** softkeys, the **TnL AM SSB Gain** softkey becomes active.

- Press **Meas Setup 4** > **More** then
- **TnL AM SSB Gain** – sets the gain in the IF path for TnL SSB measurements (the optimal IF path gain is automatically determined/set for regular AM and all the other demod types, but it cannot be automatically determined for AM SSB so it has to set it manually).

The goal is to set the gain as high as possible (to take advantage of the range of the IF and audio paths) without distorting the audio signal. It is recommended that you keep increasing the gain until you hear distortion in the audio and then back off until you no longer hear any distortion.

NOTE

The system volume setting should still be used to determine the final desired volume/level of the audio output. Learn more, see also **Chapter 30, “System Settings.”** and **“Audio (Volume) Control”** on page 720.

Tune Frequency

The Tune & Listen tuner is separate from the SA display. This allows you to listen to one frequency while displaying a different range of frequencies.

Set the Tune Frequency using one of three methods:

1. Selecting Preset > Mode Preset, sets Tune Frequency to 3.25 GHz(e.g., for a N9914B FieldFox).
2. Specify Tune Frequency:
 - Press **Meas Setup 4** > **Tune Freq**
 - Enter a value using the numeric keypad, **▲▼** arrows, or the rotary knob. Then select a multiplier key. Learn about multiplier abbreviations “[Multiplier Abbreviations](#)” on page 53.
3. Using Mkr->Tune Freq:
 - Create a normal marker at the frequency of interest. Learn how in “[How to create Markers](#)” on page 692.
 - Press **Mkr->/Tools**
 - Then **Mkr->TuneFreq** to change the Tune Frequency to that of the marker.

NOTE

To improve sound quality, try increasing power by reducing the Attenuation setting and, if available, turn ON the Preamplifier. Learn how in “[Attenuation Control](#)” on page 170

Listen Time

While Tune & Listen is actively demodulating a signal, the SA does not sweep and update the display. Listen Time sets the amount of time that the FieldFox demodulates, then stops to perform a single sweep and update the display, then again demodulates.

To select Listen Time:

- Press **Meas Setup 4** > **Listen Time**
- Enter a value using the numeric keypad, **▲▼** arrows, or the rotary knob. Then select a multiplier key. Learn about multiplier abbreviations.

Volume Control

To increase or decrease the Volume of the demodulated signal:

- Press **Meas Setup 4** > **Volume**
- Enter a value in percent between 0 and 100 (loudest) using the numeric keypad, **▲▼** arrows, or the rotary knob.
- Volume can also be changed and easily muted from the **System** menu. Learn more in “[How to set the FieldFox Volume Control](#)” on page 721.

Audio Demod ON and OFF

To quickly stop the audio demodulation and perform only the normal SA sweeps, select the following:

- Press **Meas Setup 4** > **Audio Demod ON OFF** > **OFF**

Setting the Marker Counter Precision Softkey

When **AM Tune & Listen**, **FM (narrow) Tune & Listen**, or **FM (wide) Tune & Listen** are selected, you can choose from the following:

- Press **Marker** > **Peak**
- Press **Mkr->/Tools** > **More** > **Mkr Properties** > **Counter Precision** – Sets the AM or FM Metric demodulated signal’s marker precision (.1 Hz, 1 Hz, 10 Hz; default = 0.1 Hz).

The Counter Precision softkey is **not** available when AM Metric or FM Metric are enabled. See also, **“Setting the Mkr->TuneFreq Softkey” on page 181**.

Setting the Mkr->TuneFreq Softkey

When **AM Tune & Listen**, **FM (narrow) Tune & Listen**, or **FM (wide) Tune & Listen** are selected, you can choose from the following:

- Press **Marker** > **Normal**
- Press **Mkr->/Tools** > **Mkr->TuneFreq** – The Tune & Listen Frequency becomes the frequency of the active marker (When **AM Metrics** or **FM Metrics** are selected this softkey is inactive).

See also, **Chapter 28 Data Analysis** and **“How to use Marker Functions” on page 705**.

Analog Demod (Requires CPU2)

The Tune & Listen feature can be used to identify an interfering AM or FM signal. Also, AM/FM Metrics displays the demodulated signal and the audio frequency spectrum.

The demodulated AM or FM signal can be heard through the internal speaker or through headphones using the 3.5 mm jack located on the FieldFox side panel.

The Analog Demod spectrum is displayed alongside the SA displayed trace. This enables you to listen and display a carrier frequency and its harmonics. The Analog Demod measurement displays a normal SA sweeps for the display while performing audio demodulation at the carrier Frequency. See the **“How to select Analog Demod (Metrics)” on page 183** setting for more information.

Figure 9-4 AM DSB (Metrics) – Demodulation Spectrum

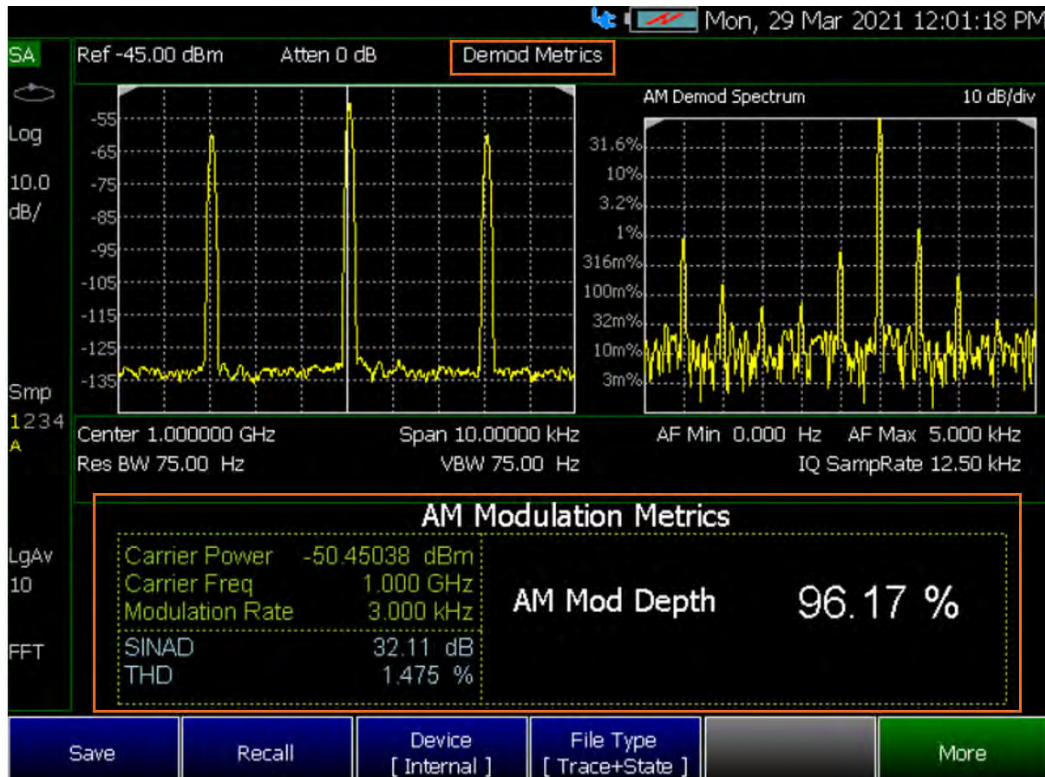

In the graphic above, Analog Demod ON and Demod Metrics is indicated above in the x2 displays of carrier spectrum content. For this example, AM Modulation Metrics are displayed in the lower half of the display. See also, [Figure 9-5 on page 189](#), [Figure 9-6 on page 190](#), [Figure 9-7 on page 190](#), and [Figure 9-8 on page 191](#).

This section contains the following:

[“How to select Analog Demod \(Metrics\)” on page 183](#)

[“How to make Analog Demodulation \(Metrics\) Settings” on page 184](#)

[“Setting the Alternate Frequency \(AF\) Freq/Dist Softkeys” on page 185](#)

[“Setting the Alternate Frequency \(AF\) RBW Softkey” on page 185](#)

[“Setting the Audio Capture Playback Softkeys” on page 186](#)

[“How to Set the Demod Filters” on page 187](#)

[“Setting the Marker Counter Gate Softkey” on page 189](#)

How to select Analog Demod (Metrics)

Analog demodulation can demodulate AM DSB, AM SSB, FM, FM Stereo / RDS, PM signals. Under analog demodulation metrics the following information is reported for each signal type: Carrier power, modulation rate, SINAD, THD, plus deviation, depth, or RMS depending on the signal. Metrics also displays the demodulated signal and the audio frequency spectrum.

Learn more, [Chapter 26, “AM/FM Metrics \(SA Only and Option 355\).”](#)

- Press **Measure 1** > **Analog Demod Tune & Listen** > **Analog Demodulation**
- **Demod Type** – Then choose a demodulation metric type. Select a setting based on the type of interfering signal you suspect is being broadcast.

NOTE

IMPORTANT! The FieldFox contains only one speaker that supports mono audio output (i.e., if you play a stereo WAVE file, the Left and Right channels are output in mono audio). If you want to output a stereo WAVE file in stereo (to hear the left and right channels separately on the FieldFox) you have to use the headphone jack and stereo headphones (i.e., most earbuds, headphones, etcetera support stereo). Learn more, see also [Chapter 30, “System Settings.”](#) and [“Audio \(Volume\) Control” on page 720.](#)

- **AM** – AM (double sideband). Displayed values for AM Modulation (metrics) – (i.e., includes AM Mod Depth, AM Demod Waveform, SINAD, THD, Carrier Power, Carrier Freq, Modulation rate).
- **AM SSB** – AM single sideband. Displayed values for AM SSB (metrics) – (i.e., includes SSB RMS Level, SSD Demod Waveform, SINAD, THD, RF Power, Modulation rate).
- **FM** – Displayed values for FM Modulation (metrics) (i.e., includes Freq Deviation, FM Demod Waveform (Time)/Spectrum (Frequency), Carrier Power, Carrier Freq, Modulation Rate, SINAD, THD).
- **FM Stereo / RDS** – Displayed values for FM Stereo / RDS (Radio Design System); (Metrics) – (i.e., includes Freq Deviation, FM Demod Waveform (Time)/Spectrum (Frequency), Carrier Power, Carrier Freq, Modulation Rate, SINAD, THD).

NOTE

When FM Stereo /RDS is selected as the demodulation type, a Warning message is displayed for a few seconds at the start of the sweep; the sweep is 30 to 50 seconds long.

The message reads:

"Warning: Slow Measurement. RDS Measurement in Progress."

- **PM** Displayed values for PM Modulation Metrics (i.e., includes PM Deviation, PM Demod Waveform, SINAD, THD, Carrier Power, Carrier Freq, Modulation Rate).

- **Tune & Listen OFF** – Opens a menu of Tune & Listen demod softkeys. Tune & Listen can be set when you are in Analog Demodulation mode, so you can enable Tune & Listen sweeps in between your Analog Demod sweeps. To learn more about the Tune & Listen softkey menu choices, refer to **“Tune & Listen (AM/FM)” on page 177**.

See also, **“How to make Analog Demodulation (Metrics) Settings” on page 184**.

How to make Analog Demodulation (Metrics) Settings

The following softkeys are available when one of the Analog Demodulation metrics measurements is pressed. See also, **“How to select Tune & Listen” on page 178**.

If **AM DSB**, choose from:

- **AM Top Y** – Determines the Y axis percentage (0% to $\pm 100\%$) of the AM demodulation waveform is displayed (Default = 100%).

If **AM SSB**, choose from:

- **SSB Top Y** – Determines the Y axis voltage (0 nV to $\pm 100\text{mV}$) of the AM SSB demodulation waveform is displayed (Default = 100 mV).

If **FM**, choose from:

- **FM Top Y** – Determines the Y axis frequency (1 kHz to 1 GHz) of the FM demodulation waveform is displayed (Default = 100 kHz).

If **FM Stereo / RDS**, choose from:

- **FM Top Y** – Determines the Y axis frequency (1 kHz to 1 GHz) of the FM demodulation waveform is displayed (Default = 100 kHz).

If **PM**, choose from:

- **PM Top Y** – Determines the Y axis phase (0 to 100 radians) of the PM demodulation waveform is displayed (Default = 5).

For either **AM DSB**, **AM SSB**, **FM**, **FM Stereo / RDS**, or **PM**, choose from:

Refer to **Figure 9-5 on page 189**, **Figure 9-6 on page 190**, and **Figure 9-7 on page 190**, and **Figure 9-8 on page 191**.

- **Demod SwpT** – Sets the X-axis to display the demodulation sweep time for the demodulated waveform (minimum = 50 μs ; maximum = 50 ms).
- **Peak OFF ON** – This adds peak positive and peak negative metrics to the main metrics measurement. For example, in FM peak ON will include peak positive (Peak +) and negative (Peak -) frequency deviation metrics to appear. Peak ON will also enable peak traces on the demodulation waveform and audio frequency spectrum (Default = OFF).

- **Demod Type** – Sets the demodulation type.
Choose from **AM**, **AM SSB**, **FM**, **FM Stereo / RDS**, and **PM**.
- Then, press **More** – opens a menu of softkeys: **Average Type**, **Average Count**, and **Demod View Time Freq**.
- **Average Type** – Selects the way the demodulated signal values are averaged. Choices are Power (#PAvg annotation is displayed), Log (#LgAv annotation is displayed), Voltage (#VAvg annotation is displayed). Auto is the default and when selected the FieldFox chooses the type of averaging that is used based on the current settings.
- **Average Count** – Determines the amount of averaging used (1 to 10K; Default = 10).
- **Demod Filters** – Refer to “How to Set the Demod Filters” on page 187.
- **Demod View Time Freq** – Toggles how the demodulated signals are displayed (Time (waveform) or Frequency (spectrum)); Default = Time).
- **Audio Capture Playback** – Refer to “Setting the Audio Capture Playback Softkeys” on page 186.

Setting the Alternate Frequency (AF) Freq/Dist Softkeys

When **AM DSB**, **AM SSB**, **FM**, **FM Stereo / RDS**, or **PM** are selected and **Demod View = Freq**, you can choose from the following:

- Press **Freq/Dist** then choose:
- **AF Start Freq** – Sets the AF start frequency for the AM or FM demodulated signal.
- **AF Stop Freq** – Sets the AF stop frequency for the AM or FM demodulated signal.
- **AF Full Span** – Sets the AF full span frequency for the AM or FM demodulated signal.

Also, you can set the standard Center, Freq Span, and other frequency softkeys.

Setting the Alternate Frequency (AF) RBW Softkey

When **AM DSB**, **AM SSB**, **FM**, **FM Stereo / RDS**, or **PM** are selected and **Demod View = Freq**, you can choose from the following:

- Press **BW 2** then choose:
- **AF RBW** – Sets the audio frequency (AF) resolution BW for the AM or FM demodulated signal (Manual or Auto; default = Auto).

Setting the Audio Capture Playback Softkeys

The FieldFox analog demodulation audio capture playback feature allows you to capture/record the demodulated audio associated with an analog demodulation measurement (AM DSB, AM SSB, FM, FM Stereo or PM) and save it as an audio file. It also allows you to recall and playback audio files through FieldFox's built-in speaker or headphones.

NOTE

Currently, the audio capture playback feature supports WAVE files with mono or stereo LPCM data sampled at 48,000 Hz with 16 bits per sample.

If you are unable to hear your audio data files (*.wav), verify that your System > Preferences > Preferences > Audio is set to On.

When **Analog Demod** is selected, you can choose from the following:

- Press **Meas Setup 4** > **More** > **Audio Capture Playback** then
- If you want to initiate an audio capture:
Press **Capture**
- If you want to stop an audio capture:
Press **Stop** to stop the current capture of audio data and depending on the timing of pressing Stop, possibly prevent the audio data from being stored.
- If you have previously stored an audio file:
Press **Playback** then
 - **Play** – to play the last current audio file (*.wave) loaded into memory.
 - **Stop** – to disable playback of the current audio file.
 - **Volume 0** – to enable/disable volume and to adjust the volume from 0 to 100 (default = 50).
 - **Load Audio File** – to load a previously stored audio (.wave) file.
 - **Cap Auto-Load File** – enable/disable automatically loading of a captured audio (.wav) file (default = OFF).
- Press **Capture Settings** then
 - **Capture Count** – sets the number of audio captures for a measurement (Default = 1; Settable: 1 to 10K).
 - **Capture Time** – sets the capture time (Default = 100 ms). Minimum/Maximum capture times vary with other settings.
 - **Stereo Channel** – When **Demod Type = FM Stereo / RDS**, this softkey sets the type of audio to be captured and stored: (Choose single channel: **Mono (L+R)**, **Left (L)**, **Right (R)**, and **Difference (L-R)**). Or choose two channel: **Stereo (L&R)**. Default = Mono (L+R).

Then Choose:

Mono (L+R)	Sets the audio recording to Mono (single channel) and combining left and right speaker sounds. This is the default.
Stereo (L&R)	Sets the audio recorded to be stereo (two channels).
Left (L)	Sets the audio to be recorded to be the left speaker only.
Right (R)	Sets the audio to be recorded to be the right speaker only.
Difference (L-R)	Sets the audio to be recorded to be the value of the left side minus the right side of the audio data (single channel).

- Then **File Settings** then
 - **Filename** – Opens the filename labeler to specify a filename.
 - **Timestamp OFF ON** – Enables/disables a timestamp label on your audio (.wav) filename.
 - **Storage Device** – Sets the storage device location for your audio (.wav) file. Select **Internal** (default), **SD Card**, or **USB**.

For capture annotation examples, refer to **Figure 9-9 on page 192** and for more on file settings refer to **Chapter 32, “File Management.”**

How to Set the Demod Filters

The demodulation (Demod) filters and de-emphasis options help you accurately recover and analyze the modulating signal. The demod filters apply to all demod types (AM DSB, AM SSB, FM, FM Stereo and PM), while the de-emphasis options only apply to the FM and FM stereo demod types.

- Press **Filters** then
 - **Lowpass Filter None** – then choose:

None	No lowpass filter is selected.
300 Hz	5-Pole Butterworth LPF with 3 dB cutoff frequency of 300 Hz.
3 kHz	5-Pole Butterworth LPF with 3 dB cutoff frequency of 3 kHz.
15 kHz	5-Pole Butterworth LPF with 3 dB cutoff frequency of 15 kHz.

30 kHz	3-Pole Butterworth LPF with 3 dB cutoff frequency of 30 kHz.
80 kHz	3-Pole Butterworth LPF with 3 dB cutoff frequency of 80 kHz.
100 kHz	3-Pole Butterworth LPF with 3 dB cutoff frequency of 100 kHz.
20 kHz	9-Pole Bessel LPF with 3 dB cutoff frequency of 20 kHz.
300 kHz	3-Pole Butterworth LPF with 3 dB cutoff frequency of 300 kHz.
Custom	5-Pole Butterworth LPF with a custom 3 dB cutoff frequency (determined by the LPF 3 dB Cutoff setting).

- **LPF 3 dB Cutoff 300.000 Hz** – When the Lowpass filter is set to **Custom**, sets the customized LPF 3 dB cutoff frequency for the lowpass filter (Default = 300 Hz; Minimum = 90 Hz, Maximum = 5 MHz).
- **Highpass Filter None** – then choose:

None	No highpass filter is selected.
20 Hz	2-Pole Butterworth HPF with 3 dB cutoff frequency of 20 Hz.
50 Hz	2-Pole Butterworth HPF with 3 dB cutoff frequency of 50 Hz.
300 Hz	2-Pole Butterworth HPF with 3 dB cutoff frequency of 300 Hz.
400 Hz	10-Pole Butterworth HPF with 3 dB cutoff frequency of 400 Hz.
Custom	5-Pole Butterworth HPF with a custom 3 dB cutoff frequency (determined by the HPF 3 dB Cutoff setting).

- **HPF 3 dB Cutoff 500.000 Hz** – When the Highpass Filter is set to **Custom**, sets the customized HPF 3 dB cutoff frequency for the highpass filter (Default = 500 Hz; Minimum = 20 Hz, Maximum = Varies, depending on the AF Span).
- **Bandpass Filter None** – Sets the Bandpass Filter for the current measurement (Choices: None, CCITT, A-Weighted, C-Weighted, C-Message, CCIR-1k Weighted, CCIR-2k Weighted, or CCIR Unweighted). Default = None.

- **More** – **FM and FM Stereo only**. Opens a softkey menu to enable/disable the De-Emphasis softkeys.
 - **De-Emphasis OFF ON** – Enables/disables the de-emphasis applied to the demodulated signal.
 - **De-Emphasis T** – Sets the amount of de-emphasis applied to the demodulated signal.

Setting the Marker Counter Gate Softkey

When **AM Metric** or **FM Metric** are selected, you can choose from the following:

- Press **Marker** > **Peak**
- Press **Mkr->/Tools** > **More** > **Mkr Properties** > **Counter Gate** – Sets the AM or FM Tune & Listen demodulated signal’s counter window time (Minimum = 1 ms and Maximum = 2s; default = 100 ms).

The Counter Gate softkey is **not** available when AM Tune & Listen, FM (narrow) Tune & Listen, or FM (wide) Tune & Listen are enabled. Refer to **Figure 9-8 on page 191**.

See also, **“How to use Marker Functions” on page 705**.

Figure 9-5 AM DSB (Metrics) – Demodulation Waveform

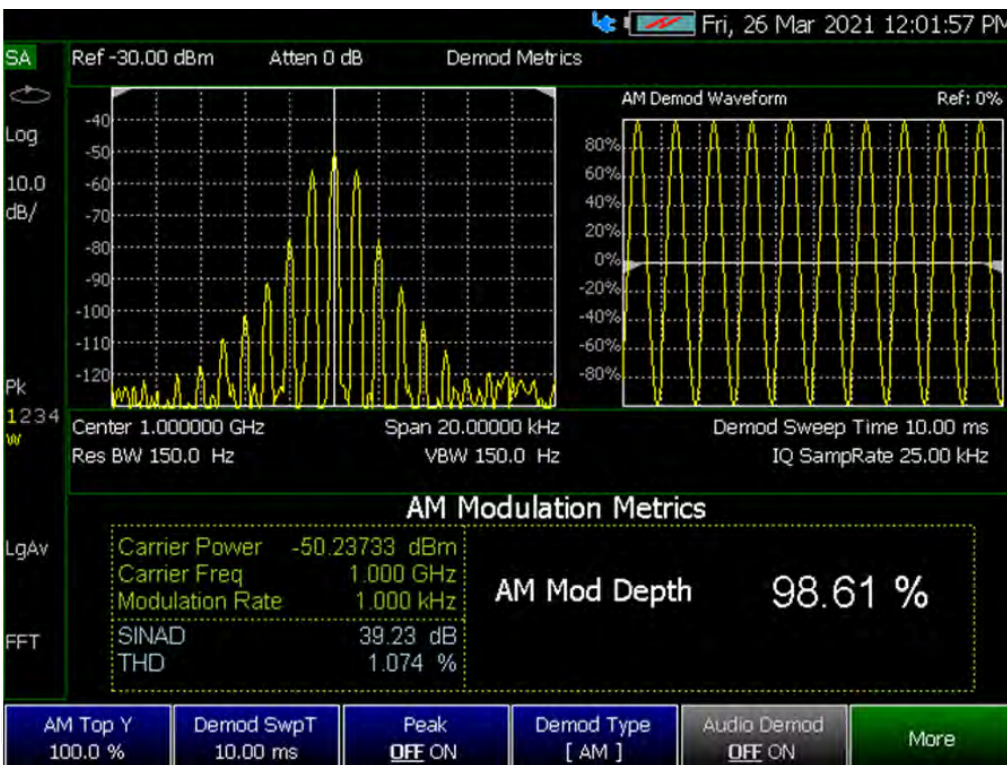

Figure 9-6 FM Metrics – Demodulation Spectrum

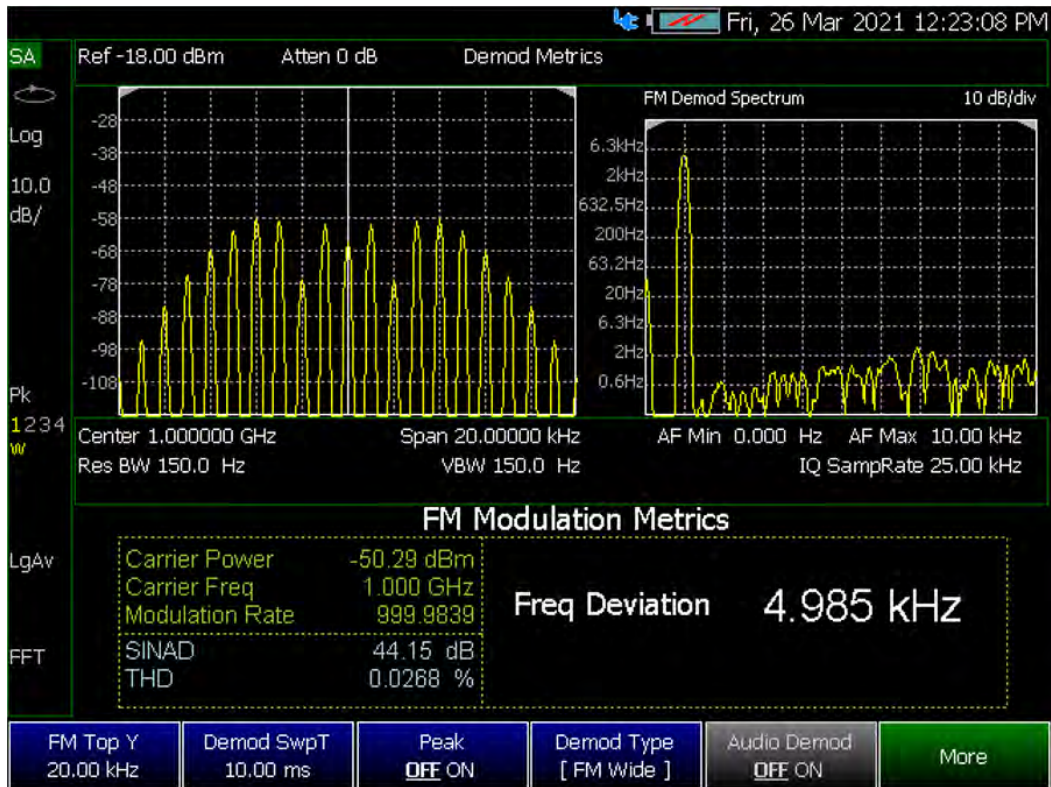

Figure 9-7 FM (Metrics) – Demodulation Waveform

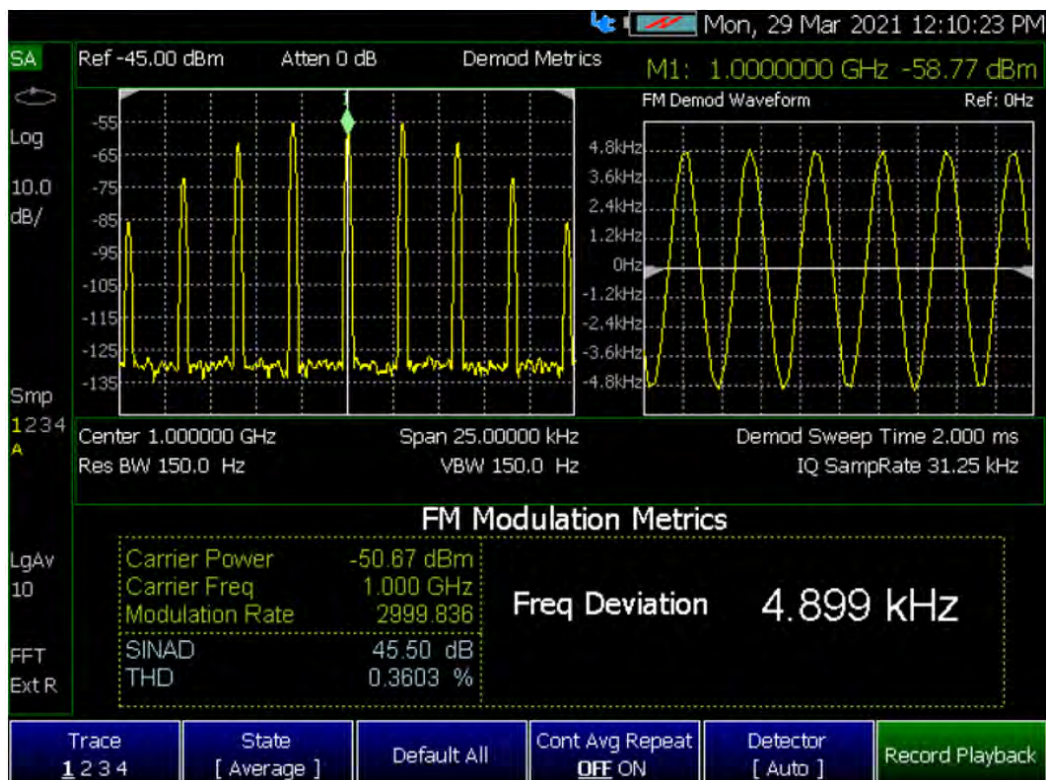

Figure 9-8 FM (Metrics) - Counter Gate and FM Demodulation Waveform

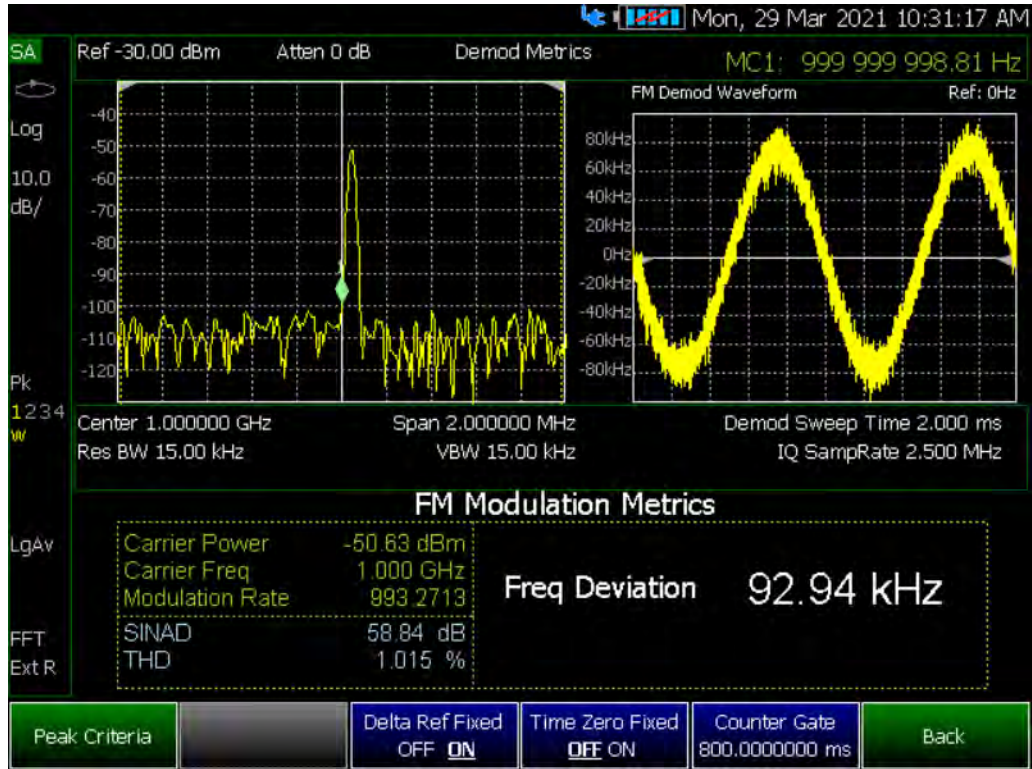
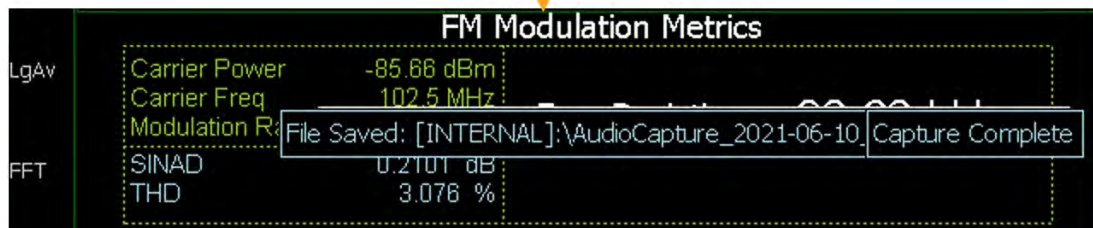
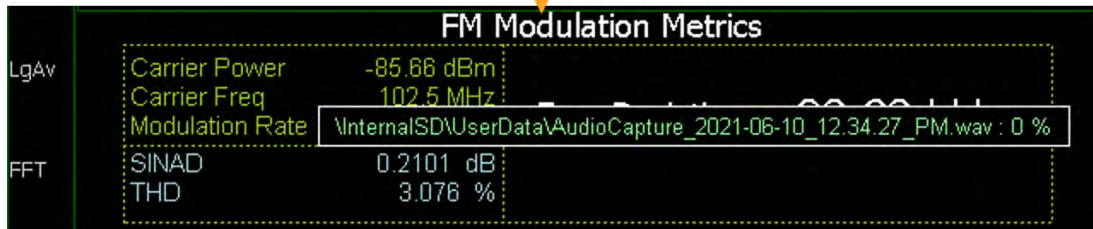
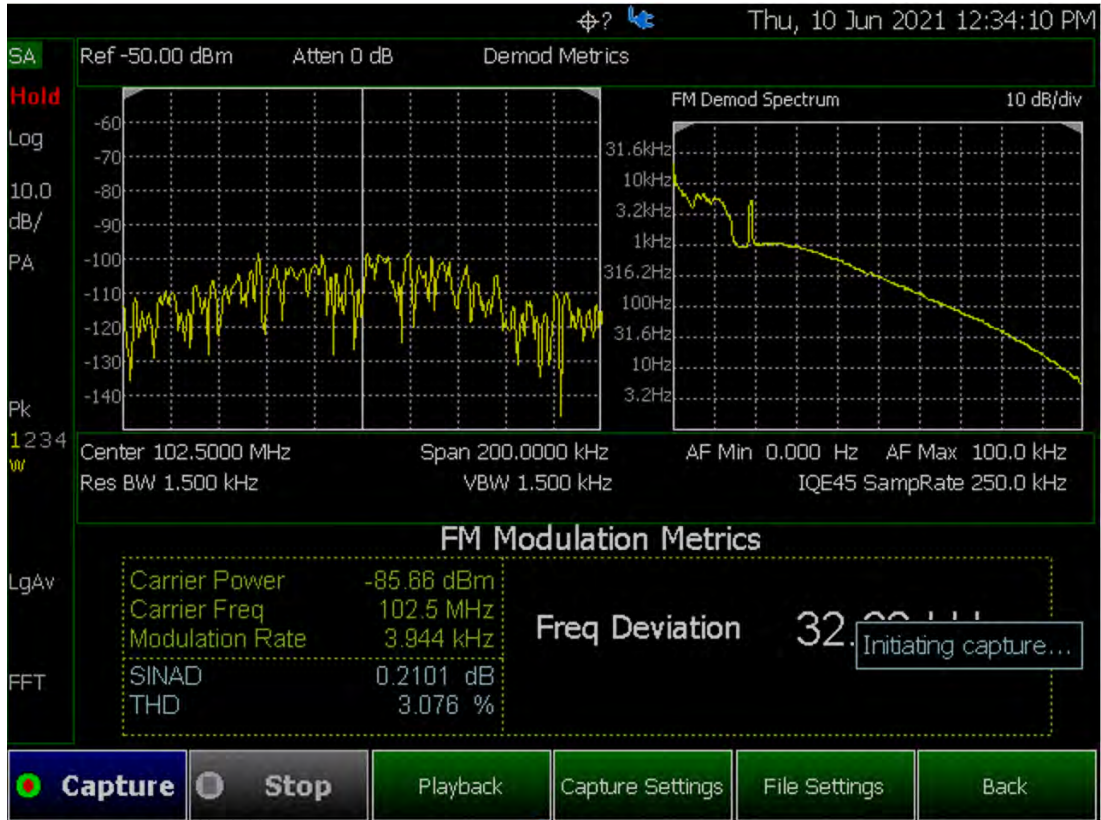

Figure 9-9 Audio Capture with Annotation Examples



Independent Source/Tracking Generator

NOTE

For best results, when using the independent source feature, InstAlign and the battery saver features should be turned off. Refer to “How to Access Individual Alignments” on page 215 and “Preferences” on page 733.

This feature may require an option. For a comprehensive list, view the FieldFox Configuration Guide at:

<https://www.keysight.com/us/en/assets/7018-03329/configuration-guides/5990-9836.pdf>.

A tracking generator, a popular option with Spectrum Analyzers, is a source which always tracks the SA receiver.

Like a traditional tracking generator, the Independent Source feature can set the internal FieldFox source to track the SA receiver frequency range. It can also set the internal source to a CW frequency that is independent of the SA frequency.

Independent Source can be enabled ONLY when the FieldFox is in SA mode.

To view the internal source, you must connect a cable or device between the RF Output connector and the RF Input connector.

How to make Independent Source Settings

- Press **Measure 1** > **Source**
- **Source Enable ON OFF**
 - **ON** Turns ON the internal source.
 - **OFF** Turns OFF the internal source.
- **Source Mode** Choose from the following:
 - **Tracking** The internal source frequency can track the SA receiver. Center frequency **Src** is annotated on the screen
 - **CW** The source is set to a CW frequency independent from the SA settings. **Srcw** is annotated on the screen.
 - **Coupled CW** The source is set to a CW frequency, but that frequency “tracks” the SA receiver Center Frequency settings. Therefore, the signal always appears at center of the display. **Srcp** is annotated on the screen.
- **Normalize ON OFF** With Source Enable ON and Source Mode = Tracking, Normalize ON stores the current measurement trace into Trace 4 in View state as a reference trace. All subsequent trace measurements subtract this Trace 4 reference trace, and therefore become relative to it. **SrcN** is

annotated on the screen. Normalize is automatically turned OFF when the frequency range or Resolution is changed. Learn more about Trace Display States in [“Trace Display States \(SA Mode\)” on page 208](#).

- **Source Power** Sets the source power level. Choose from:
 - **Leveled** Enter a value from -45 dBm to 0 dBm using the numeric keypad, **▲▼** arrows, or the rotary knob¹. The source power is reasonably flat across the frequency span.
 - **MAX** The power level is set to the maximum achievable power level at each frequency. This results in the power level NOT being flat across the frequency span.
- **Source CW Freq** Sets the CW frequency that is used when Source Mode is set to CW.

NOTE

By default, the source output will turn off momentarily at the end of each IQA and SA sweep and also every 300 seconds during the InstAlign process.

To cause the source to stay ON at the end of each sweep, turn battery saver OFF. (Learn more in [“How to Access Individual Alignments” on page 215](#).)

- Press **System 7** > **Preferences** > **Preferences** then
- In the table, select Battery Saver. Press **Edit** then **Battery Saver ON OFF**
To suspend InstAlign: (Learn more in [“How to Access Individual Alignments” on page 215](#).)
- Press **Cal 5**
- Then **Amptd Alignment OFF**

Resolution Bandwidth (Res BW)

In SA Mode, the Res BW provides the ability to resolve, or see closely spaced signals. The narrower (lower) the Res BW, the better the spectrum analyzer can resolve signals. In addition, as the Res BW is narrowed, less noise is measured by the spectrum analyzer ADC and the noise floor on the display lowers as a result. This allows low level signals to be seen and measured. However, as the Res BW is narrowed, the sweep speed becomes slower. See [“Very Long Sweep Times” on page 200](#).

How to set Res BW

- Press **BW 2**.
- Then **Res BW**.
- Then choose from the following:

1. N995xA/6xA cannot have the Leveled value set lower than -35 dBm.

- **Auto** Res BW is coupled to the frequency span. As the frequency span is narrowed, the Res BW is also narrowed providing increased ability to resolve signals.
To change this setting from **Man** to **Auto**, press **Res BW** twice.

- **Man** Enter a Res BW value using the numeric keypad, the **▲▼** arrows, or the rotary knob. Then press a multiplier if necessary or press **Enter**.

The current Res BW setting is shown at the bottom of the screen.

#Res BW x.xx XHz (#) means manual setting.

This setting could impact the accuracy of the measurement. See Specifications in Appendix B.

NOTE

The Res BW setting also affects the Sweep Type setting. Learn how in “Sweep Type” on page 196

Video Bandwidth (Video BW)

Video BW is a smoothing operation that is performed after measurement data is acquired. The trace data is effectively smoothed so that the average power level of the displayed noise is the same, but the peaks and valleys of adjacent data points are smoothed together. More smoothing occurs as the Video BW is set lower. However, as the Video BW is narrowed, the sweep speed becomes slower.

How to set VBW

- Press **BW 2**.
- Then **Video BW**
- Then choose from the following:
 - **Auto** Couples Video BW to the ResBW in a 1-to-1 ratio.
 - **Man** Enter a Video BW value using the numeric keypad, the **▲▼** arrows, or the rotary knob. Then press a multiplier if necessary or press **Enter**. Setting VBW higher than RBW may smooth the trace.

NOTE

To change this setting from Man to Auto, press Video BW twice.

The current Video BW setting is shown at the bottom of the screen.

VBW x.xx XHz (#) means manual setting.

When the Res BW/Video BW ratio exceeds 10,000, a **Meas UNCAL** warning may appear to indicate that the Video BW filter has reached the maximum capacity for averaging.

AF RBW (Audio-Frequency Resolution BW)

AF RBW - sets the audio-frequency resolution bandwidth for the selected frequency (Default = Auto).

How to set AF RBW

- Press **BW 2** > **AF RBW**
- Then choose from the following:
 - **Auto** Couples AF BW to the Resolution BW in a 1-to-1 ratio.
 - **Man** Enter a AF BW value using the numeric keypad, the **▲▼** arrows, or the rotary knob. Then press a multiplier if necessary or press **Enter**. Setting AF BW higher than RBW may smooth the trace.

NOTE

To change this setting from Man to Auto, press AF RBW twice.

The current AF RBW setting is shown at the bottom of the screen.

AF RBW x.xx XHz (#) means manual setting.

When the Res BW/AF RBW ratio exceeds 10,000, a **Meas UNCAL** warning may appear to indicate that the AF RBW filter has reached the maximum capacity for averaging.

Sweep Type

In SA mode, the FieldFox uses two sweep types to process inputs signals. The sweep type that is currently being used (**FFT** or **Step**) is displayed in the lower-left corner of the FieldFox screen.

For a more comprehensive tutorial, see Spectrum Analysis Basics (App Note 150) at

<https://www.keysight.com/us/en/assets/7018-06714/application-notes/5952-0292.pdf>

How to set Sweep Type

- Press **BW 2**.
- Then **Advanced**
- Then **Sweep Type**
- Then choose from the following:
 - **Auto** The FieldFox selects the most efficient sweep type based on the Res BW. When Res BW is set to 200 kHz and below, FFT sweep type is selected. Above 200 kHz, Step sweep type is being performed.
 - **FFT** The FieldFox uses FFT sweep type regardless of the Res BW.

- **Step** The FieldFox uses Step sweep type regardless of the Res BW. This is useful for capturing impulsive noise that may be generated from nearby electrical equipment.

Oversweep

In SA mode, the FieldFox uses Oversweep to quickly analyze input signals. Oversweep is meant to verify that your setup is correct, but Oversweep is **not** meant to be as accurate as **FFT** and **Step** sweeps. See also, “**How to set Sweep Type**” on page 196.

How to set Oversweep

- Press **BW 2** > **Advanced** then
- Press **Oversweep** – To enable/disable the Oversweep. Over sweep enables you to quickly evaluate your setup.

IF Output

The FieldFox IF (intermediate frequency) can be output for external signal processing. The signal is available from the IF Out connector on the FieldFox right-side panel. See the connector in “**Right Side Panel**” on page 49.

The IF Out signal, centered at approximately 33.75 MHz, is simply a down-converted version of the RF Input signal that is present at the tuned frequency.

While outputting an IF signal, the FieldFox stops performing the InstAlign process. Therefore, the amplitude of traces on the FieldFox screen is NOT accurate and **Meas UNCAL** appears on the screen to indicate this. Learn more in “**Individual Alignments**” on page 214.

Learn more about the IF Output frequencies and bandwidths in the Supplemental Online Help:

<http://na.support.keysight.com/fieldfox/help/SupHelp/FieldFox.htm>

Figure 9-10

IF Output Wide with CF-33.75 MHz

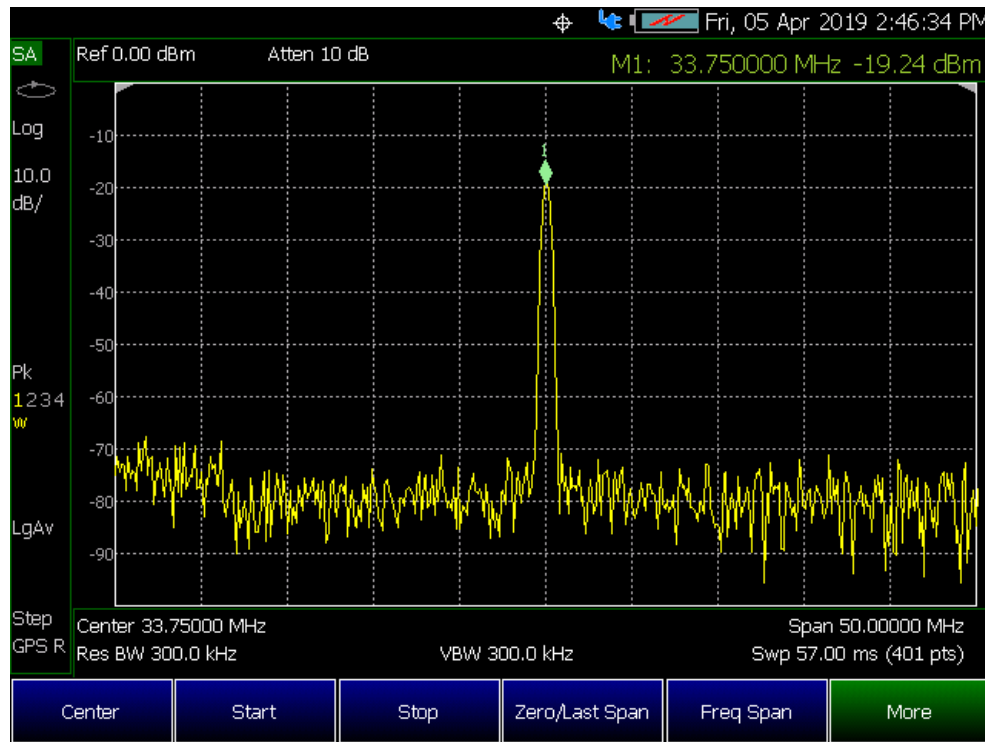

How to select IF Output

The IF Output signal is useful only in Zero Span. Learn more about Zero Span in [“Zero Span Measurements” on page 200](#).

At least one sweep must be made in order to tune the FieldFox.

- Press **BW 2**.
- Then **Advanced**
- Then **IF Output Use**
- Then choose from the following:
 - **OFF** The translated IF signal at the IF OUT connector is no longer guaranteed to be centered at 33.75 MHz.
 - **Narrow** The IF output signal has approximately 5 MHz bandwidth.
 - **Wide** The IF output signal has approximately 25 MHz bandwidth.

Sweep Acquisition

Available only in non-zero span measurements, when Sweep Acquisition is set to Auto, the fastest sweep rate is achieved while maintaining full amplitude accuracy.

NOTE

For zero span measurements, refer to “Zero Span Measurements” on page 200.

However, you can adjust this setting in order to increase the probability of intercepting and viewing pulsed RF signals.

For example, with **SwpAcquisition set to Auto** a pulsed GSM signal is NOT visible on the FieldFox screen, as shown in a blue trace in the following image.

While watching the trace, increase the SwpAcquisition value until the pulse spectrum rises out of the noise and reaches its maximum level. Increasing the SwpAcquisition value beyond this point only slows the update rate (increases the actual Sweep time readout) but does not improve measurement quality.

Figure 9-11 GSM Signal in Framed Data Format

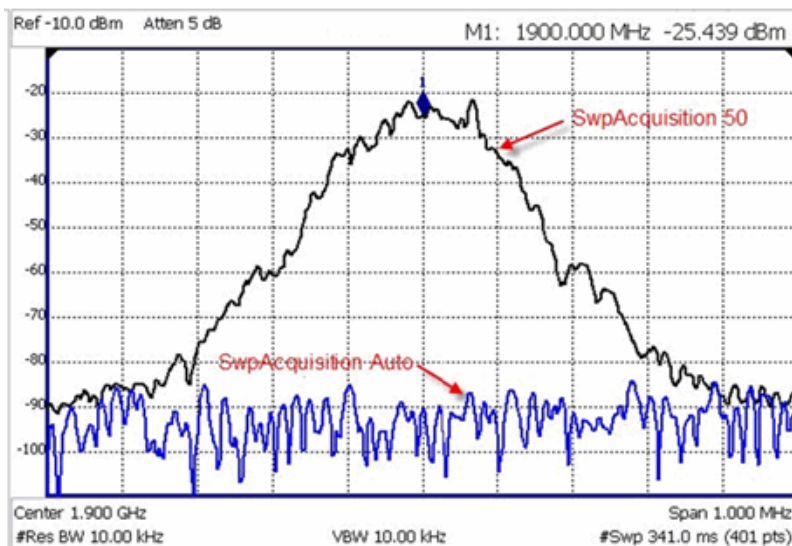

In the graphic above, a GSM signal in a framed data format; timeslot zero ON; all others OFF;

PRF = 218Hz, Duty Cycle = 12.5%. The pulsed signal becomes visible on every sweep update with SwpAcquisition = 50.

How to set Sweep Acquisition

SwpAcquisition is NOT an absolute measure of time, but a relative number between 1 (fastest) and 5000 (slowest) sweep time. The actual time that was required to complete a sweep is annotated on the screen.

- Press **Sweep 3**.

- Then **SwpAcquisition Auto Man**.
- Then choose from the following:
 - **Auto** Sweep is set to the fastest sweep possible with the current settings.
 - **Man** Enter a relative acquisition value between 1 and 5000, where:
 - Man Enter a relative acquisition value between 1 and 5000, where:
 - 1 = Fastest sweep possible
 - 5,000 = Slowest sweep possible
 - # is shown in front of the actual sweep time to indicate a manual setting.

Some Detector and Video Bandwidth settings will raise the Auto Sweep Acquisition value greater than 1. In these cases, manually setting Sweep Acquisition lower than the Auto value may have NO effect.

NOTE

Measurement speed specifications do NOT apply in Temperature Control Mode. Learn more in “Temperature Control Mode” on page 41.

Learn more about SA mode SwpAcquisition time in the Supplemental Online Help: <http://na.support.keysight.com/fieldfox/help/SupHelp/FieldFox.htm>

Very Long Sweep Times

Two primary settings are responsible for the sweep time: Res BW and SwAcquisition.

- When the sweep time exceeds 1200 seconds (20 minutes), an informational message: **Alert: Very long sweep in progress...** is annotated on the screen for the duration of the sweep.
- When the sweep time exceeds 4000 seconds (about 1 hour), **Meas UNCAL** is annotated on the screen. Accuracy cannot be guaranteed.
- InstAlign is always performed only at the beginning of the sweep regardless of the sweep time. Learn more in **“How to Access Individual Alignments” on page 215.**

Zero Span Measurements

When setting the frequency span to Zero, there is NO spectrum of frequencies to display, so the X-axis units becomes Time. The SA becomes like a tunable oscilloscope, with the center frequency being the frequency of interest. This capability is useful for analyzing modulation characteristics, such as pulsed measurements.

NOTE

For non-zero span measurements, refer to [“Sweep Acquisition” on page 199](#).

Figure 9-12 GSM Signal, Framed Data Format

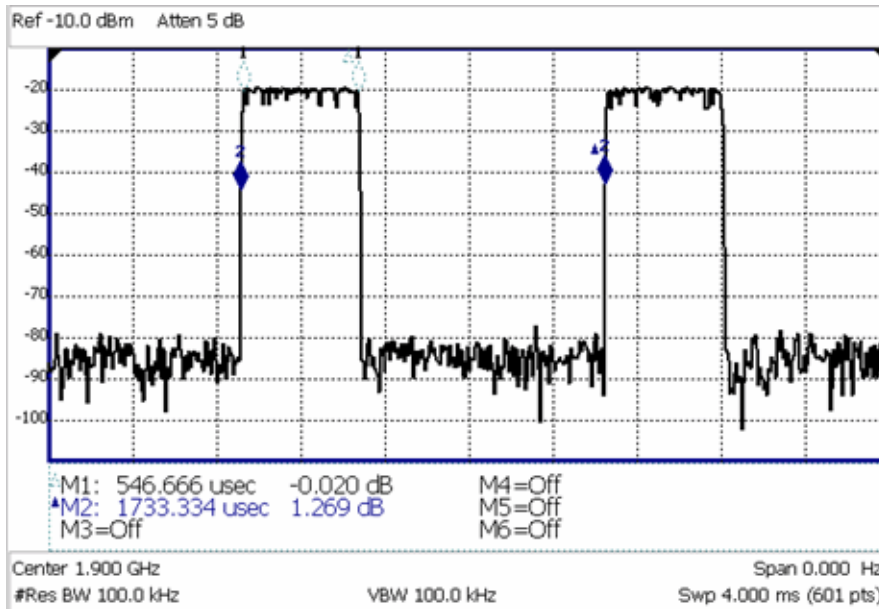

The graphic above shows a GSM signal, framed data format, with timeslot 0 and 3 “on”. Sweep Time is set to approximately the frame interval. Press Single several times until the waveform section of interest is viewable and stable. Then markers can be used to measure the timeslot width and interval as shown.

How to set Zero Span

- Set **Center** to the frequency of interest
 - then set **Span** to 0 Hz
 - or select **Zero/Last Span**. Each key press toggles the frequency span between 0 Hz and the last specified frequency span.

How to change Sweep Time in Zero Span

- Press **Sweep 3**
- Then **Sweep Time**
- Enter a value using the numeric keypad. Sweep time is limited to 1000 seconds for N991xA/2xA/3xA models and 6000 seconds for N995xA & N996xA models.
- Then select a multiplier key. Learn more in [“Multiplier Abbreviations” on page 53](#).

Previous FieldFox versions limited the sweep time / ResBW settings. This restriction is no longer necessary with release A.06.25.

Learn more about SA mode Sweep Time in the Supplemental Online Help:
<http://na.support.keysight.com/fieldfox/help/SupHelp/FieldFox.htm>

Triggering

External, Video, and RF Burst triggering allows you to initiate an SA mode sweep using an external event such as a signal burst.

All three trigger types can be used in either Zero Span (time domain) or FFT frequency sweeps. Learn more in “[Zero Span Measurements](#)” on page 200. Learn more in “[Sweep Type](#)” on page 196.

FFT Gating is available for non-zero span measurements. Learn more about FFT Gating in “[FFT Gating \(Opt 238\)](#)” on page 206.

Trigger Type

- Press **Sweep 3** > **Trigger Settings** > **Trig Type**
- Then choose from the following:
 - **Free Run** Triggering is provided by the FieldFox internal circuitry. A new sweep begins when the previous sweep ends.
 - **External** A sweep is triggered on an external TTL signal at the Ref In/Trig In connector on the FieldFox top panel. Choose to trigger on the rising slope at about 1.7 V or on the falling slope at about 1.0 V using the Trigger Slope setting (below).
 - **Periodic** sets a trigger that repeats at the period rate entered. Periodic trigger's phase can be altered by the Offset value.

The following two selections are similar in that they both trigger a sweep from a signal at the **SA RF Input** connector. Experiment with both selections to find the best trigger type for your application.

- **Video** A sweep is initiated when the displayed amplitude of an incoming signal crosses the settable Trigger Level. This selection can detect low-amplitude signals, but also has been filtered considerably and may not be a true representation of the incoming signal.
- **RF Burst** A sweep is initiated when the signal at the third IF (analog) stage crosses the settable Trigger Level. This selection offers a wider bandwidth and may be a better representation of the incoming signal than Video trigger. However, RF Burst is not as sensitive to triggering on low-level signals.

Sync

NOTE

This softkey is **ONLY** available when **Trigger Type** is set to **Periodic**.

Selects the type of signal the periodic trigger is synchronized.

- **None** No synchronization is selected for a Periodic trigger.
- **External** A sweep is triggered on an external TTL signal at the Ref In/Trig In connector on the FieldFox top panel. Choose to trigger on the rising slope at about 1.7 V or on the falling slope at about 1.0 V using the Trigger Slope setting (below).
- **RF Burst** uses an alignment process which is performed in the background to set the detected signal level accuracy. Learn more in “**RF Burst Amplitude Alignment**” on page 216.
- **1 PPS GNSS** Periodic trigger is synchronized to a 1 pulse per second GNSS signal.

Trigger Slope

Trigger Slope determines which edge of an External, Video, or RF Burst trigger signal initiates a sweep.

- Press **Sweep 3**
- Then **Trigger Settings**
- Then **Trig Slope**
- Then choose from the following:
 - **Pos** Sweep is triggered by the rising (positive) edge of signal.
 - **Neg** Sweep is triggered by the falling (negative) edge of signal.

Trigger Delay

After a valid trigger signal is received, the sweep begins after the specified Trigger Delay time.

To see the rising edge of a repetitive signal which is triggered on that edge, enter a negative trigger delay value (also known as pre-trigger). Adjust the sweep time to observe the pre-trigger time if necessary.

- Press **Sweep 3**
- Then **Trigger Settings**
- Then **Trig Delay**
- Enter a value using the numeric keypad, the **▲▼** arrows, or the rotary knob.

- Then select a multiplier key or press **Enter**. Learn more in [“Multiplier Abbreviations” on page 53](#).

In Zero span, you can use Trigger Position as an easy way to set Trigger Delay by positioning the trigger event on the FieldFox screen. See [“Triggering” on page 202](#).

Period

NOTE

This softkey is **ONLY** available when **Trigger Type** is set to **Periodic**.

Sets the length of time in seconds before a waveform repeats. (default = 20.00 ms).

Offset

NOTE

This softkey is **ONLY** available when **Trigger Type** is set to **Periodic**.

Sets the periodic trigger offset. (default = 0.00 s)

Trigger Level

Used with Video and RF Burst triggering, a sweep is initiated when an incoming signal crosses this level. The units depend on the Units setting. Learn more in [“Scale and Units” on page 168](#).

RF Burst Trigger Level uses an alignment process which is performed in the background to set the detected signal level accuracy. Learn more in [“RF Burst Amplitude Alignment” on page 216](#). **Video Trigger Level** is a zero span signal level comparison. Therefore, the sweep will trigger close to the displayed level in zero span measurements. In non-zero span measurements, processing can cause broadband signal energy to display at lower power levels than the originating time domain signal. Therefore, you may need to set the trigger level higher than the displayed level.

- Press **Sweep 3**
- Then **Trigger Settings**
- Then **Trig Level**
- Enter a value using the numeric keypad, the **▲▼** arrows, or the rotary knob.

- Then select a multiplier key or press **Enter**. Learn more in “Multiplier Abbreviations” on page 53.

Auto Trigger Time

While waiting for a valid trigger signal, **Wait** is annotated in the top left corner of the FieldFox screen.

If a valid trigger signal is not received before the specified Auto Trig Time, a sweep will occur automatically.

Enter **0** to set Auto Trigger **OFF**. When Auto Trigger is OFF, the FieldFox does NOT sweep unless a valid trigger signal is received.

- Press **Sweep 3**
- Then **Trigger Settings**
- Then **Auto Trigger [current setting]**
- Enter an Auto Trig Time using the numeric keypad.
- Then select a multiplier key. See “Multiplier Abbreviations” on page 53.

Trigger Position

Available ONLY in zero span measurements, this setting is an easy way to automatically set the Trigger Delay by positioning the trigger event (also known as T-zero) at any graticule along the X-axis. With T-zero in the center of the screen, you can zoom in and out by increasing or decreasing the sweep time. Using the Trigger Position and Sweep Time settings is a quick and efficient way to examine artifacts of a pulse, much easier than trying to set the Trigger Delay manually.

When Trigger Position is set to OFF, the Trigger Delay softkey is not available. The amount of Trigger Delay that is being used is displayed on the softkey. The Trigger Position is annotated on the screen. Learn how in the following section.

- Press **Sweep 3**
- Then **Trigger Settings**
- Then **Trig Position**. If Sweep Time is longer than 0.15 sec, this softkey is grayed out.
 - **ON**: The position of T-zero is set by the trigger delay.
 - **OFF**: Select, then enter a position value from 0 to 10 using the numeric keypad, the **▲|▼** arrows, or the rotary knob.
 - **0**: T-zero occurs at the left graticule.
 - **5**: T-zero occurs at the center of the screen.
 - **10**: T-zero occurs at the far right graticule.
- Then press **Enter**.

Trigger Settings Annotation

Trigger settings are annotated on the FieldFox screen as highlighted in **red** in the following image:

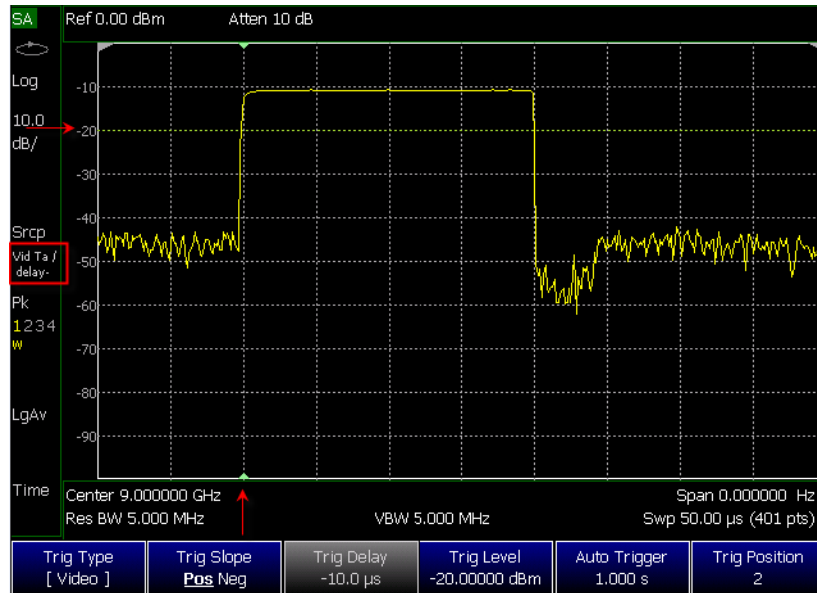

- Square: Trig Type (**VidT**), AutoTrigger (**a**), Pos Slope (**/**), Neg Delay (**delay-**)
- Horizontal arrow: Trig Level (green horizontal graticule at -20 dBm)
- Vertical arrow: Trig Position T-zero indicators (green arrows at 2nd vertical graticule)

FFT Gating (Opt 238)

Time-gated spectrum analysis allows you to obtain spectral information about signals occupying the same part of the frequency spectrum that are separated in the time domain. Using an external trigger signal to coordinate the separation of these signals, you can perform the following operations:

- Measure any one of several signals separated in time; for example, you can separate the spectra of two radios time-sharing a single frequency.
- Measure the spectrum of a signal in one time slot of a TDMA system.
- Exclude the spectrum of interfering signals, such as periodic pulse edge transients that exist for only a limited time.

FFT Gating is a simple, efficient way to set the proper amount of trigger delay and capture time so that signal artifacts of a repeating waveform or pulse can be examined in the frequency domain. Learn more about trigger settings in **“Triggering” on page 202**.

For best results, Auto Trigger should be used with this feature to ensure that the sweep does not wait indefinitely for a trigger. Set Auto Trigger to a time that is longer than the expected periodic rate of the signal. This is especially

important when using RF Burst or Video triggering in wider spans, because the signal providing those triggers has limited bandwidth. Learn more about Auto trigger in **“Auto Trigger Time” on page 205**.

For more conceptual information on this topic, please refer to Spectrum Analysis Basics (App Note 150), pages 31 - 35, at <https://www.keysight.com/us/en/assets/7018-06714/application-notes/5952-0292.pdf>.

How to set FFT Gating

- Create a non-zero span measurement. Wider frequency spans take more time to acquire.
- Press **Sweep 3**
- Then **Trigger Settings**
- Then **FFT Gating Setup**
- Then choose from the following:
 - **Gate View OFF ON** When ON, a separate zero span measurement is displayed below the non-zero span window. The gate view measurement helps to configure the gate width and delay by revealing (with green markers) the location of the gate relative to the trigger event. The zero span measurement is tuned to the center frequency of the non-zero span measurement with about 5 MHz of bandwidth. The Y-axis scale is the same for both windows.
 - **Gate View Time** Set the X-axis span for the non-zero span window. Enter a value using the numeric keypad, the **?** arrows, or the rotary knob. This value is annotated as Swp (nn) below the window.
 - **FFT Gating OFF ON** When ON, the trigger type, gate width, and delay are applied to the non-zero span measurement. The Res BW is set to a value that is inversely proportional to the gate width.
 - **Gate Width** Set the width of the gating area within the non-zero span window. The gating area is indicated by two vertical green lines. Enter a value using the numeric keypad, the **?** arrows, or the rotary knob.
 - **Gate Delay** Effectively moves the gating area left (negative delay) or right (positive delay) relative to the trigger event. Enter a value using the numeric keypad, the **▲▼** arrows, or the rotary knob.

When you have properly setup the Gate Trigger, Width, and Delay using the Gate View measurement, you can turn **Gate View OFF** to return to the full screen non-zero span measurement with FFT Gating ON, the RBW set, and the Trigger settings active.

Single / Continuous / Restart

This setting determines whether the FieldFox measures continuously or only once each time the **Single** or **Run / Hold +/-** button is pressed. Use **Hold / Single** or to conserve battery power or to allow you to save or analyze a specific trace.

How to set Single or Continuous

- Press **Sweep 3**.
- Then choose one of the following:
 - **Continuous**
 - **ON** Causes the SA to make continuous sweeps. This is the typical setting for making measurements. Each **Run / Hold +/-** press causes the SA to toggle between continuous sweep and Hold.
 - **OFF** Causes the SA to Hold. Each **Run / Hold +/-** or **Single** press causes the SA to make ONE sweep, then Hold. The Hold annotation changes to an arrow --> while the sweep occurs.
 - **Single** Automatically sets Continuous OFF and causes the SA to make ONE sweep, then Hold.
 - **Restart** Resets the Average counter to 1. The Average counter also is used with MaxHold and MinHold Trace States. Learn more in **“Average Count” on page 210**.

Points

Points is the number of measurements that are displayed along the X-axis. The higher number of data points, the better the ability to resolve closely spaced signals and the slower the sweep speed.

How to set number of points

- Press **Sweep 3**
- Then **Points [current setting]**
- Then choose from:
 - **101 | 201 | 401 | 601 | 801 | 1001**
 - **# Points** to enter a trace points value manually (Maximum = 20001).

Trace Display States (SA Mode)

In SA Mode you can display up to four of the following types of trace states. All SA settings are applied to all displayed traces. See also **“Marker Trace (IQA and SA Mode)” on page 696**.

A color-coded legend for displayed traces is visible in the left pane of the SA mode screen:

W = Clear/Write; **M** = MaxHold; **m** = MinHold; **A** = Average; **V** = View

How to display the Trace States

- Press **Trace 6**.
- Then **Trace 1,2,3,4** repeatedly to select a trace number to display or change its state. Traces are displayed in the following colors:
 - Trace 1 – **Yellow** Trace 2 – **Blue**
 - Trace 3 – **Orange** Trace 4 – **Green**
- Then **State [current setting]**
- Then choose from the following Trace States:
 - **Clr /Wr** (Clear/Write) Displays the actual measured data for each sweep.
 - **MaxHold** Displays the maximum response of the input signal at each data point over multiple sweeps. See also Average Count in **“Average Count” on page 210**.
 - **MinHold** Displays the minimum response of the input signal at each data point over multiple sweeps. See also Average Count in **“Average Count” on page 210**.
 - **Average** Each data point is averaged over multiple sweeps as set by the Average Count setting. Learn more in **“Average Count” on page 210**.
 - **View** Displays and then holds the last complete measurement trace on the screen. This is similar to storing a trace in memory.
 - **Blank** Displays no trace.
- Press **Default All** to return all traces to their default settings: Trace 1 (Clear/Write); all other traces (Blank).

NOTE

Trace 4 data WILL be overwritten by the FieldFox when using the Independent Source Normalize feature (**“Independent Source/Tracking Generator” on page 193**) or using Field Strength antenna or cable corrections (**“Field Strength Measurements” on page 172**).

Average Type

In SA Mode, there are four different processes in which Averaging is performed:

- Average Traces – Learn more in **“Averaging” on page 225**.
- Detection Method Averaging – Learn more in **“Detection Method” on page 218**.

- Noise Marker Averaging – Learn more in **“Noise Marker” on page 221**.
- Video BW filtering (for non–Zero Span measurements) – Learn more in **“Video Bandwidth (Video BW)” on page 195**.

There are three types of mathematical averaging that can be performed – Log, Linear, or Voltage (see **“How to set Average Type” on page 210**). Select ONE of these types and it is used for all of the above averaging processes.

How to set Average Type

- Press **Meas Setup 4** then **Average Type [current setting]**
- Then choose from the following:
 - **Auto** – The FieldFox chooses the most appropriate type of averaging for the current settings. When Detection Method is set to Average, a Noise Marker is present, or a Channel measurement is active, then Power Average is ALWAYS selected. Otherwise, Log Average is selected.
 - **Log** Averaging – Best for displaying Trace Averaging. LgAv is shown on the left side of the FieldFox screen when selected.
 - **Power** (Linear) Averaging – Best for measuring true power levels. Used in Detection Average and Noise Marker Average. Mathematically, trace noise is 2.5 dB higher than when using Log Average. PAVg is shown on the left side of the FieldFox screen when selected.
 - **Voltage** Averaging – Converts the amplitudes to a magnitude unit before averaging (e.g., Volts, Amps, microVolts, milliVolts, etc.) **VAvg** annotation is displayed.

Average Count

The Average Count setting is used mainly with the Average Trace State described in **“Trace Display States (SA Mode)” on page 208**. In this Trace State, the Average Count setting determines the number of sweeps to average. The higher the average count, the greater the amount of noise reduction.

When Trace (display) State is set to **Average**, **MaxHold**, or **MinHold**, the average counter is shown in the left edge of the screen below the Average Type.

For all three of these Trace States, when **Sweep 3 Continuous** is set to OFF, press **Restart** to reset the sweep count to 1, perform <n> sweeps, then return to **Hold**.

How to set Average Count

- Press **Meas Setup 4**
- Then **Average Count**

- Enter a value from 1 to 10,000 using the numeric keypad, the  arrows, or the rotary knob.
- Press **Enter**

Alignments

NOTE

To better reflect the enhancements implemented during the alignment process, for firmware versions >A.10.15 “IF Flatness Alignment” is now referred to as “Channel Equalization” or “Channel Equalization Alignment” ([ChanEQ Alignment](#)).

This section contains the following:

- [“Overview” on page 211](#)
- [“All Alignment and Align All Now” on page 213](#)
- [“Individual Alignments” on page 214](#)

Overview

All Alignment or **Align All Now** corrects for receiver drift over temperature and time. SA measurement applications monitor changes in internal temperature and the time since last alignment update and trigger the need for a new update when the alignment becomes stale. The alignment is deemed stale after a significant change in temperature or a significant time elapsed from the last update. The temperature change and time duration necessary to trigger an alignment update is predetermined in the factory. Until the update is performed, annotation indicating “questionable amplitude” is displayed **AMPTD?**

When **All Alignment** is enabled (by default) the FieldFox performs an alignment process using the internal RF source. Although some sweeps are delayed, measurement results are never disturbed.

If the Independent Source (tracking generator) is enabled for your measurement, it will be borrowed to perform the alignment. Again, the measurement results are not disturbed. Learn about the Independent Source in [“Independent Source/Tracking Generator” on page 193](#).

The alignment process can be disabled. You may want to do this, for example, if you are analyzing the amplitude stability of a signal.

SA and all modes built on its infrastructure require three types of alignments:

- InstAlign Amplitude Alignment
- RF Burst Amplitude Alignment
- Channel Equalization

These are referred to as [Individual Align](#).

SA (Spectrum Analyzer) Mode (Option 233–Mixed Analyzers)
SA Mode Settings

All three or a subset of the individual alignments are required for each specific mode, depending on the type of measurement supported by it:

SA:

- InstAlign Amplitude Alignment
- RF Burst Amplitude Alignment

RTSA:

- InstAlign Amplitude Alignment
- RF Burst Amplitude Alignment
- Channel Equalization

EMI Measurements:

- InstAlign Amplitude Alignment
- WidePath Burst Trigger Alignment
- Channel Equalization

Channel Scanner:

- InstAlign Amplitude Alignment

ERTA:

- InstAlign Amplitude Alignment

IQA:

- InstAlign Amplitude Alignment
- RF Burst Amplitude Alignment
- Channel Equalization

Built-in Power meter

- InstAlign Amplitude Alignment

Default settings and recommended use model for many applications:

- Coupled individual alignments
- Coupled state is Auto
- Individual alignments are not accessible via front panel soft-keys
- Individual alignments cannot be UnCoupled

For special cases, the individual alignments can be accessible via the front panel soft-keys using the Preference setting **SA - Individual Alignment Control > On/Off**. This enables a soft-key for access to **Individual Alignments** when this preference is set to ON: **Cal 5 > Individual Align**. For more refer to **“Preferences” on page 733**, in **Chapter 30** System Settings.

The individual alignments may be:

- Coupled (default) - when they are in the same state, or
- Uncoupled - when at least one of them is in a different state than the other ones
- Executed on demand, all of them, using the **Align All Now** softkey.

Each of the individual alignments:

- could be in one of three states:
 - **Off** - the alignment is not applied and is not updated automatically
 - **Auto** (default) - the alignment will be updated over time and temperature as needed, no user interaction required
 - **Hold** - the unit holds the alignment values from the last alignment-execution and does not execute another alignment automatically
- can be updated on demand using the corresponding **Align Now** soft-key. Refer to “**Individual Alignments**” on page 214.
- The **All Alignment** soft-key has the following functionality:
 - when the individual alignments are Coupled, the state of all of them can be changed simultaneously using the **All Alignment** soft-key sub-menus
 - when the individual alignments are UnCoupled, they will be coupled when using the **All Alignment** soft-key sub-menus and their state will be simultaneously changed accordingly

All Alignment and Align All Now

NOTE

IMPORTANT! It is recommended that you use **Align All Now**, because it includes the individual alignment **InstAlign**, **Amptd Align Now**, as well as, **Burst Align Now**, and **ChanEQ Align Now**. But, if you would prefer to have manual control over the individual alignments, then refer to the **SA Individual Alignment Control** setting in “**Preferences**” on page 733, in **Chapter 30** System Settings.

The notification **AMPTD?** displayed on screen means the **InstAlign** amplitude alignment or channel equalization is stale (if its state is Hold) and requires an update or it is in the OFF state. This situation does not occur when the respective alignment is in the Auto state. To clear this notification, press the **Align All Now** softkey.

How to set All Alignment and Align All Now

- Press **Cal 5**

- Then **All Alignment [Auto]** (to enable or disable the All Alignment) – Default is Auto.
- or
- Then **Align All Now** (to manually perform an Align All Now.) This performs an alignment on all three individual alignments: Amptd Align Now, Burst Align Now, and ChanEq Now). Refer to **“Individual Alignments” on page 214**.
- Press **Enter**

If you want to disable the All Alignment [Auto], you can do so in the FieldFox preferences (i.e., you may want to do this, for example, if you are analyzing the amplitude stability of a signal).

Refer to the **SA Individual Alignment Control** setting in **“Preferences” on page 733**, in **Chapter 30** System Settings. See also, **“Individual Alignments”**.

Individual Alignments

NOTE

IMPORTANT! It is recommended that you use **All Alignment [Auto]** or **Align All Now** in lieu of the individual alignments (**Amptd Align Now**, **Burst Align Now**, and **ChanEQ Align Now**), because All Alignment [Auto] and Align All Now includes the individual alignment InstAlign **Amptd Align Now**, **Burst Align Now**, and **ChanEQ Align Now**. But, if you would prefer to have manual control over the individual alignments, then refer to the **SA Individual Alignment Control** setting in **“Preferences” on page 733**, in **Chapter 30** System Settings.

The Individual Alignment softkey is only available, when the preference SA - Individual Alignment Control is set to On in the FieldFox Preferences menu. Refer to **“Preferences” on page 733**, in **Chapter 30** System Settings.

How to Access Individual Alignments

This section assumes access to individual alignments was activated using the FieldFox's system settings' Preferences. Once enabled, an **Individual Alignments** softkey is displayed. Refer to "**Preferences**" on page 733, in **Chapter 30 System Settings**.

- Press **Cal 5**
- Then **Individual Align**
- Then **Amptd Align Now** or
- Then **Burst Align Now** or
- Then **ChanEq Align Now**
- Press **Enter**

How to make Amplitude Alignment settings

NOTE

During continuous sweep ("acquisition" for IQA) operation, automatic Alignments will NOT interrupt the ongoing measurement, but when necessary, will occur opportunistically as settings are changed. When no automatic alignment updates occur, existing alignments can become stale over time and temperature drift, so a warning annotation on the left panel will light up indicating that alignments need updating.

SA, IQA, RTSA, and other modes use a proprietary amplitude alignment algorithm to make extremely accurate amplitude measurements over the full frequency range of the FieldFox.

These settings do NOT survive a Preset or Mode Preset.

- Press **Cal 5**
- Then **Individual Align**
- Then **Amptd Alignment**
- Then choose from the following:
 - **Auto** (Default setting) Alignments are required and are performed automatically, when necessary, at times when interrupting the RF Output is deemed acceptable. The alignment process is performed opportunistically when changes in settings require the measurement to stop momentarily and a significant time elapsed since the last alignment (predetermined in the factory) or the internal instrument temperature has changed sensibly (predetermined in the factory).

Some examples of the conditions when alignments occur are: This could be a Center frequency change, or it could be as simple as requesting a Single sweep. Also, unique alignments are required at different FieldFox receiver frequency bands, so even if the temperature hasn't changed, an alignment may be required when one changes the Center frequency.

If a needed alignment cannot be performed, the user is notified about questionable amplitude **AMPTD?**

- **OFF** Alignments are not performed. The most recent alignment result is cleared. Only factory corrections are applied to SA Receiver measurements. Questionable amplitude **AMPTD?** is always displayed.
- **Hold** The alignment process is stopped, but the last alignment values are applied to subsequent sweeps.
- **Amptd Align Now** An alignment is performed immediately, thus updating (clearing) any questionable amplitude status. If the Mode was previously Off, it is changed to Hold.

Amptd? is annotated in the lower left corner of the FieldFox screen when amplitude alignment is questionable. This is always true when OFF, and is conditionally true in Auto or Hold when the most recent alignment is deemed stale.

RF Burst Amplitude Alignment

RF Burst alignment calibrates the circuitry to provide accurate external RF Burst triggering. Learn more about RF Burst triggering in [“Triggering” on page 202](#)

When enabled (by default) the FieldFox performs an alignment process using the internal RF source. Although some sweeps are delayed, measurement results are never disturbed.

If the Independent Source is enabled for your measurement, it will be borrowed to perform the alignment. Again, the measurement results are not disturbed. Learn about the Independent Source in [“Independent Source/Tracking Generator” on page 193](#).

The alignment process can be disabled. You may want to do this, for example, if you are analyzing the amplitude stability of a signal.

How to make Burst Alignment settings

These settings do NOT survive a Preset or Mode Preset.

- Press **Cal 5**
- Then **Individual Align**

- Then **Burst Alignment**
- Then choose from the following:
 - **Auto** (Default setting) SA measurement applications monitor changes in internal temperature and the time since last alignment update and trigger the need for a new update when the alignment becomes stale. The alignment is deemed stale after a significant change in temperature or a significant time elapsed from the last update. The temperature change and time duration necessary to trigger an alignment update is predetermined in the factory.
 - **OFF** The alignment process is NOT performed. Only factory correction values are used.
 - **Hold** The alignment process is stopped, but the last alignment values are applied to subsequent sweeps.

Burst Align Now An alignment is performed once and applied to subsequent sweeps.

Channel Equalization (IQA and RTSA Only)

NOTE

During continuous sweep operation for RTSA and continuous acquisition for IQA, automatic Alignments will NOT interrupt the ongoing measurement, but when necessary, will occur opportunistically as settings are changed. When no automatic alignment updates occur, existing alignments can become stale over time and temperature drift, so a warning annotation on the left panel will light up indicating that alignments need updating. When alignments need updating, you will see a “Channel Equalization” or “ChanEq” error message displayed.

IQA and RTSA modes use proprietary channel equalization algorithms to make extremely accurate channel measurements over the full frequency range of the FieldFox.

How to make Channel Equalization Alignments settings

These settings do NOT survive a Preset or Mode Preset.

- Press **Cal 5**
- Then **Individual Align**
- Then **ChanEq Alignment**
- Then choose from the following:
 - **Auto** (Default setting) SA measurement applications monitor changes in internal temperature and the time since last alignment update and trigger the need for a new update when the alignment becomes stale. The alignment is deemed stale after a significant

change in temperature or a significant time elapsed from the last update. The temperature change and time duration necessary to trigger an alignment update is predetermined in the factory.

Some examples of the conditions when alignments occur are: This could be a Center frequency change, or it could be as simple as requesting a Single sweep. Also, unique alignments are required at different FieldFox receiver frequency bands, so even if the temperature hasn't changed, an alignment may be required when one changes the Center frequency.

- **Hold** The alignment process is stopped, but the last alignment values are applied to subsequent sweeps.
- **OFF** The alignment process is NOT performed, and the channel equalization is deactivated.
- **ChanEq Align Now** An alignment is performed immediately.

The **Amptd?** annotation lights up whenever the current channel equalization is deemed stale.

Detection Method

In SA Mode, the X-axis is comprised of data points, also known as “buckets”. The number of data points is specified using the Points setting. Learn more in [“Points” on page 208](#).

Regardless of how many data points are across the X-axis, each data point must represent what has occurred over some frequency range and time interval.

From the frequency span of the measurement, the span of each data point is calculated as $(\text{frequency span} / (\text{data points} - 1))$. The detection method allows you to choose how the measurements in each bucket are displayed.

Figure 9-13 Detection using One Bucket

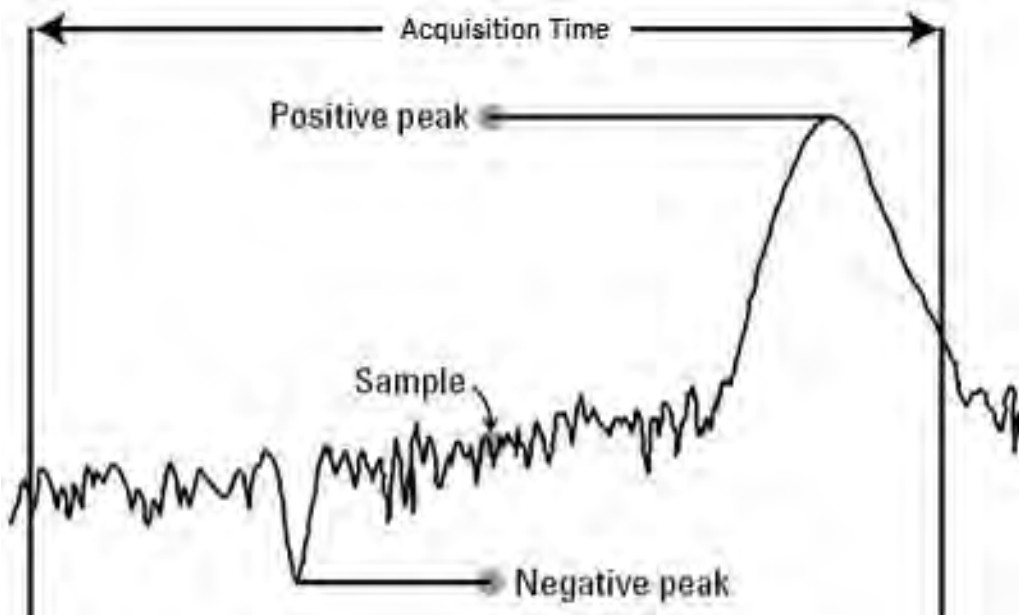

In the graphic above there is one bucket showing Positive peak, Sample, and Negative peak Detection methods.

How to set Detection Method

The current Detection method is labeled on the left edge of the screen. When a method is selected manually, a # precedes the label. For example: **# Nrm** means that **Normal** was selected from the softkeys.

- Press **Trace 6** > **Detector**
- Then choose from the following:
 - **Auto** Displays the most appropriate Detection method based on other settings. [**# is NOT shown**]
 - **Normal** [**#Nrm**] Provides a better visual display of random noise than **Positive peak** and avoids the missed-signal problem of the **Sample** Mode. Should the signal both rise and fall within the bucket interval, then the algorithm classifies the signal as noise. An odd-numbered data point displays the maximum value encountered during its bucket. An even-numbered data point displays the minimum value encountered during its bucket. If the signal is NOT classified as noise (does NOT rise and fall) then Normal is equivalent to Positive Peak.
 - **Positive Peak** [**#Pk**] Displays the maximum value of all the measurements in each bucket. This setting ensures that no signal is missed. However, it is not a good representation of the random noise in each bucket.
 - **Negative Peak** [**#NPK**] Displays the minimum value of all the measurements in each bucket.

- **Sample** [#Smp] Displays the center measurement of all the measurements in each bucket. This setting gives a good representation of the random noise in each bucket. However, it does not ensure that all signals are represented.
- **Average** [#RMS] Displays the Root Mean Squared (RMS) average power of all the measurements in each bucket. This is the preferred method when making power measurements.

Display Line

A display line is a simple, horizontal line that can be placed at any amplitude level on the SA screen or set to any level in IQA. Use a display line as mental guide for visual feedback. A display line is similar to a Limit Line, except that no PASS/FAIL testing occurs. A display line is easier to create than a Limit Line. Learn more in [“All about Limit Lines” on page 707](#).

Figure 9-14 Display Line with Annotations

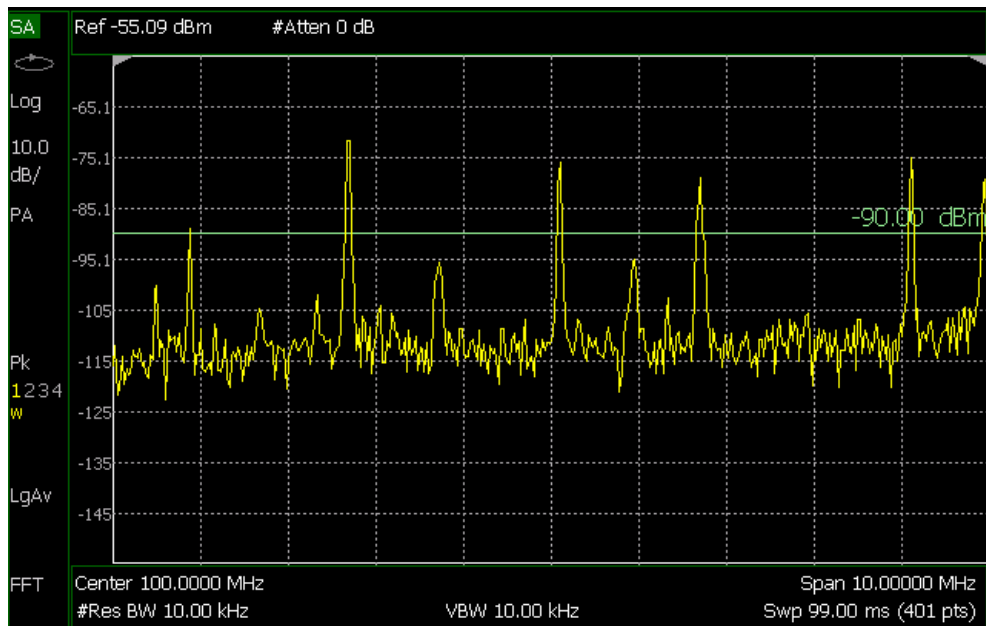

How to create and move a Display Line

- Press **Limit 8**
- Then **Display Line OFF ON**
- Then enter a Y-axis value using the **▲▼** arrows or the rotary knob, then press **Enter**. Or enter a value using the numeric keypad and press a suffix key or press **Enter**.

Learn more, [“All about Limit Lines” on page 707](#).

Noise Marker

For comparison purposes, electronic noise measurements are often displayed as though the measurement was made in a 1 Hz Res BW. However, making an actual measurement at a 1 Hz Res BW is extremely slow.

A Noise Marker, unique to SA Mode, mathematically calculates the noise measurement as though it were made using a 1 Hz bandwidth.

Several data points (or ‘buckets’) are averaged together to calculate the Noise Marker readout. To accurately measure noise, the Noise Marker should NOT be placed on, or too close to, a signal. The distance from a signal depends on several factors. To know if an accurate reading is being made, move the Noise Marker until consistent measurements are displayed in adjacent data points.

In addition, when a Noise Marker is displayed, the Detection method is automatically switched to Average and **PAvg** is shown on the FieldFox screen. This occurs only when Detector is set to Auto. Learn more in [“Detection Method” on page 218](#).

With a Noise Marker present, the Res BW can be changed and the displayed noise floor will also change, but the Noise Marker readout will remain about the same.

Noise Markers can be used like regular markers. A Noise Marker is distinguished from a regular marker by **(1Hz)** after the marker readout value. Learn more about regular markers in [“All about Markers” on page 692](#).

How to measure Noise with a marker

- Press **Marker** to create or select a Normal or Delta marker to use to measure Noise.
- Then **More**.
- Then **Marker Function**
- Then **Noise ON OFF**.

Band/Interval Power Marker

A Band/Interval Power marker—available in IQA and SA Modes—accumulates the power that is measured over several adjacent data points (or ‘buckets’). The range of buckets being measured is displayed with vertical posts around the marker. This Band Span value is selectable.

This feature is very similar to a channel power measurement ([“Channel Power \(CHP\)” on page 226](#)).

When the frequency span is set to Zero span, the marker is referred to as an Interval Band Marker because it averages power over a specific time interval. In this case the range is specified as the Interval Span. Learn more about Zero span measurements in [“Zero Span Measurements” on page 200](#).

If the Detection method and Averaging type are set to Auto when you enable a Band/Interval Power marker, the Detection method will change to Average (RMS) and Averaging type will change to Power average. Other Detection methods or Averaging type settings will usually cause measurement inaccuracy. Learn more about Detection method in [“Detection Method” on page 218](#), and Averaging Type in [“Average Type” on page 209](#).

Summary:

- In Zero span, an Interval Power Marker yields the average power over the specified time interval.
- In non-Zero span, a Band Power Marker yields the total power over the specified frequency range.

How to measure Band/Interval Power with a marker

- Press **Marker** to create or select a Normal or Delta marker to use to measure Band/Interval Power.
- Then press **More**
- Then **Marker Function**
- Then **Band/Int Power**
- Then **Band (or Interval) Span**
- Then choose from the following:
 - **Auto** Measures power over 5% of the displayed span, or ½ graticules. The Band Span is automatically updated to remain at 5% when you change the frequency span.
 - **Man** Enter a frequency or time value using the **▲▼** arrows or the rotary knob, then press **Enter**. Or enter a value using the numeric keypad and select a frequency or time suffix. The Band Span remains at the frequency or time value that you set as the span changes.

Frequency Counter at Marker

Available in SA Mode ONLY. Use any existing marker to make highly-accurate frequency counter readings. For highest accuracy, lock the FieldFox to a stable external frequency reference. Learn how in [“Frequency Reference Source” on page 754](#).

When Frequency Counter is ON, the FieldFox uses background sweeps to zoom on the signal, measure the signal peak with 1 Hz resolution, and display the frequency of the signal peak in the marker annotation area. The marker does not move to the signal peak.

When Freq Counter is ON, measurement sweeps are considerably slower.

How to use Frequency Counter

- Press **Marker**.
- Press Normal, Delta, or Peak, or select an existing marker to use as a frequency counter.
- Locate the marker somewhere on a CW signal. It does NOT have to be on the peak.
- Then **More**
- Then **Freq Count ON**
- With Freq Count ON, you can scroll through the existing markers that are located on a discrete CW signal, and read the frequency of the signal peak. However, each frequency count update requires another sweep. If the FieldFox is in HOLD, press **Single** to update the frequency count results.

Time Zero Fixed Marker

This feature was created to allow recall of vintage instrument states (older than Rev. 7.0) that included Zero span sweep with a trigger delay and at least one marker. Before Rev. 7.0, these instrument states were saved and recalled with the equivalent of the ON state of this setting. The default setting is OFF. Learn more about Triggering with negative delay in [“Triggering” on page 202](#).

- Press **Mkr->/Tools**
- Then **More**
- Then **Mkr Properties**
- Then **Time Zero Fixed**
- Then choose from the following:
 - **ON** Time Zero is fixed at the left-edge of the screen. A marker in negative delay resides at this point. This is the vintage behavior.
 - **OFF** (default) Time Zero is located at the T-zero indicators. A marker in negative delay appears to the left of T-zero.

Audio Beep at Marker Power

When enabled, the Audio Beep feature emits a repetitive beep sound which varies in tone pitch and repetition rate to indicate the relative power level of the active marker. The highest tone pitch and fastest beep rate occurs when the marker Y-axis position is at the top of the display. Conversely, the lowest pitch and repetition rate occurs at the bottom of the display. Therefore, it is important to scale the signals that you intend to measure between the top and bottom of the screen. Learn more about Scale in [“Scale and Units” on page 168](#).

Audio Beep can be used with any marker type or function, including

Band/Interval Power. Learn more in [“Audio” on page 738](#).

How to use Audio Beep

- Press **Marker**
- Optionally, press **Marker 1 2 3 4 5 6** to select an existing marker to use with Audio Beep. A marker will be created if one does not already exist.
- Then **More**
- Then **Marker Function**
- Then **Audio Beep ON OFF**

Audio Beep does NOT beep when the FieldFox is in Hold mode.

While Audio Beep is ON, press **Marker 1 2 3 4 5 6** to toggle Audio Beep through the existing markers.

To set FieldFox speaker volume control, press **System**, then **Volume**. Learn more in [“Audio” on page 738](#).

Meas UNCAL Error

Meas UNCAL appears in the lower-left corner of the screen when the FieldFox can NOT display accurate measurement results with the current settings. Usually, the part of the trace that is inaccurate is shown at –200 dB.

The following situation can produce **Meas UNCAL**:

- When the ResBW/VBW ratio exceeds 10,000, causing the VBW filter to reach the maximum capacity for averaging.

Old Data Indicator (*)

In SA mode, when the current trace does not exactly match the annotation that is on the screen, an asterisk is displayed in the upper-right corner of the screen graticule area. This would occur, for example, when the Res BW setting is changed while in sweep Hold mode. The annotation is changed immediately, but the trace is not updated until the next sweep occurs. Therefore, the current data trace does not match the screen annotation. See the asterisk in [Figure 9-1 on page 159](#).

Channel Measurements

The following Channel Measurements are offered in SA Mode:

- Channel Power [“Channel Power \(CHP\)” on page 226](#)
- Occupied Bandwidth [“Occupied Bandwidth” on page 228](#)
- Adjacent Channel Power Ratio [“Adjacent Channel Power Ratio \(ACPR\)” on page 230](#)

Radio Standards and Channel Measurements

To tune the frequency range of any of the Channel Measurements using channels instead of frequency, first select a Radio Standard, then select Units = CHAN. Learn how to select a Radio Standard and channels in [“How to select a Radio Standard” on page 165](#).

When you first select a Radio Standard, then select a Channel Measurement:

- With Units = FREQ selected, the center frequency and span will ALWAYS change to the full frequency range of that standard (Uplink and Downlink) to allow for a quick scan of energy. The X-axis annotation indicates the frequency range.
- With Units = CHAN selected, the FieldFox chooses either the uplink or downlink band, and displays that range of frequencies. You can then tune within that Standard using Start CHAN, Stop CHAN, or Center CHAN. The X-axis annotation indicates the frequency range.

When you **first select a Channel Measurement**, then select a **Radio Standard**, the BW, Offset, RRC, Integration BW, and Span settings are changed to those of the standard. In addition, Res BW can also change when set to ‘Auto(couple)’. However, center frequency is NOT changed unless you first select Units = CHAN.

Measurement Preset

Measurement Preset allows you to easily reset any of the channel measurements to its default settings. The Center Frequency, Preamp ON|OFF, RF Attenuation, Markers, Limits, and Radio Standard settings are NOT reset.

How to select Measurement Preset:

- Press **Preset** then **Mode Preset**

Averaging

By default in ALL Channel measurements, averaging is enabled and set to display the average of the last 15 measurements. When enabled, this average setting is automatically making the following ‘averaging’ settings in order to provide the most accurate power measurements:

SA (Spectrum Analyzer) Mode (Option 233–Mixed Analyzers) Channel Measurements

- Averaging Type is set to Power.
- Trace State is set to Average.
- Detector is set to Average.
- Count is set to 15.

Any of these settings can be changed manually during a Channel measurement. Learn more about these settings starting in **“Average Type” on page 209**.

To change Averaging:

- Press **Meas Setup 4**.
- Then **Average Enable ON OFF** OFF effectively sets the Average Count to 1.
- Then **Average Count**
- Enter a value between 1 and 10,000 using the numeric keypad, **▲▼** arrows, or the rotary knob.
- Press **Enter**.

Traces

Only one measurement trace can be displayed in Channel Measurements.

Channel Power (CHP)

Channel Power measures total power over the specified Integrated BW. The Integration Bandwidth (IBW) can be adjusted to measure the power over multiple channels.

Figure 9-15 Channel Power Measurement

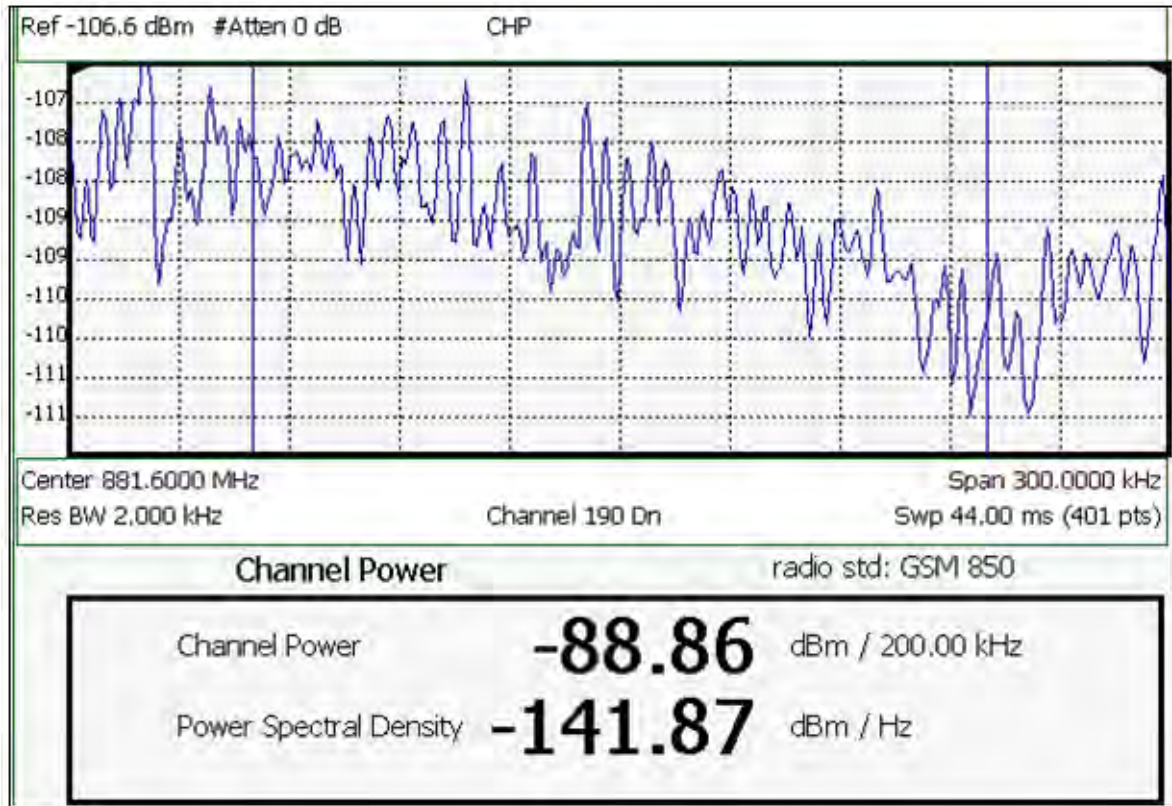

The following two Channel Power levels are displayed:

- **Channel Power** - measures total power over the specified Integrated BW.
- **Power Spectral Density** – same measured power, but mathematically normalized to a 1 Hz bandwidth using the same algorithm as Noise Marker. Learn more about the Noise Marker in [“Noise Marker” on page 221](#).

How to select Channel Power

- Press **Measure 1**
- Then **Channel Measurements**
- Then **Channel Power**

When Channel Power is selected, the following settings are maintained from a previous measurement: Center Frequency, Preamp ON|OFF, and RF Attenuation.

Integration Bandwidth

When Channel Power is selected, vertical posts appear on the display to mark the current Integration Bandwidth setting. The displayed Channel Power and Power Spectral Density values are measured and calculated over the specified Integration Bandwidth.

By default, the displayed frequency span is automatically coupled to the Integration Bandwidth. As you change the Integration Bandwidth, the frequency span is adjusted so that the vertical posts appear to NOT move. However, when you manually change the frequency span, the Integration Bandwidth is no longer coupled to the frequency span.

When a Radio Standard is selected, the appropriate Integration Bandwidth is set automatically. Learn more about Radio Standards in [“Radio Standard” on page 165](#).

To change Integration Bandwidth:

- Press **Meas Setup 4**
- Then **Integrating BW**
- Enter a value between 100 Hz and 3 GHz using the numeric keypad,  arrows, or the rotary knob.
- Press **Enter**

Other Channel Power Settings

All relevant FieldFox settings are made automatically to ensure the highest accuracy, such as ResBW, VideoBW, and sweep (SwpAcquisition) speed. These, and all other SA Mode settings, can be changed manually in a Channel Power measurement.

- Learn about Measurement Preset in [“Measurement Preset” on page 225](#).
- Learn about Averaging in [“Averaging” on page 225](#).
- Learn about RRC Weighting in [“RRC Weighting” on page 234](#).

Occupied Bandwidth

Occupied Bandwidth measures the power of the displayed frequency span and displays vertical posts at the frequencies between which the specified percentage of the power is contained. The frequency span between the two vertical posts is the Occupied Bandwidth. The Occupied Power, the power that is contained between the two posts, is also displayed in dBm.

Figure 9-16 Occupied Bandwidth Measurement

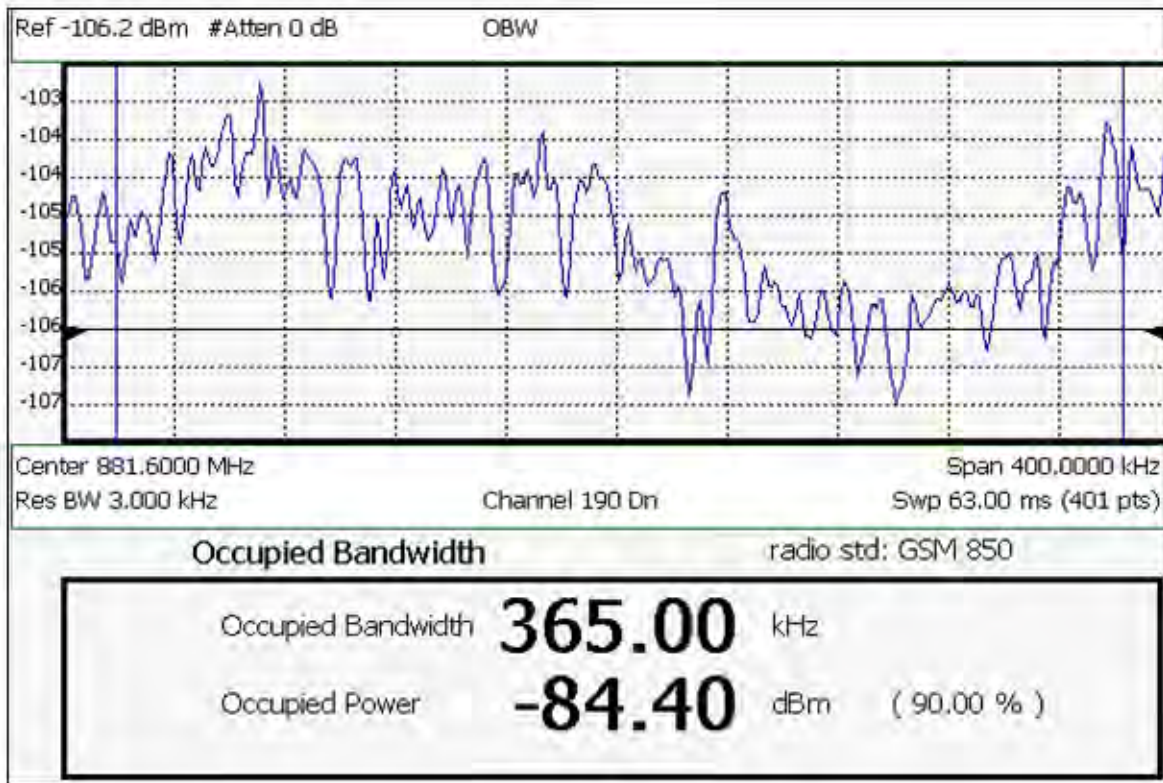

The graphic above shows an OBW measurement; Chan 190 Downlink; GSM850 Radio Standard

How to Select Occupied Bandwidth

- Press **Measure 1**
- Then **Channel Measurements**
- Then **Occupied BW**

When Occupied Bandwidth is selected, the following settings are maintained from a previous measurement: Center Frequency, Preamp ON|OFF, and RF Attenuation.

Frequency Span

Occupied BW is calculated from power that is measured over the entire displayed Frequency Span. The frequency span can be entered using arbitrary frequencies or by using a Radio Standard in conjunction with channel numbers. Learn how to select a Radio Standard and channels in **“Channel Selection” on page 166**.

To change Frequency Span:

- Press **Freq/Dist**

- Then **Freq Span**
- Enter a value using the numeric keypad, **▲▼** arrows, or the rotary knob.
- Press **Enter**

Power Percent

This setting specifies the percentage of total measured power to display between the vertical posts. The measurement defaults to 99% of the occupied bandwidth power. The remaining power (1% of default setting) is evenly distributed;.5% of the power on the outside of each side of the vertical posts.

To change Power Percent:

- Press **Meas Setup 4**
- Then **Power Percent**
- Enter a value between 10 and 99.99 using the numeric keypad, **▲▼** arrows, or the rotary knob.
- Press **Enter**.

Other Occupied Bandwidth Settings

All relevant FieldFox settings are made automatically to ensure the highest accuracy, such as ResBW, VideoBW, and sweep (SwpAcquisition) speed. These, and all other SA Mode settings, can be changed manually in a Occupied Bandwidth measurement.

- Learn about Measurement Preset in [“Measurement Preset” on page 225](#).
- Learn about Averaging in [“Averaging” on page 225](#).

Adjacent Channel Power Ratio (ACPR)

ACPR measures the power of a carrier channel and the power in its adjacent (offset) channels. The measurement results can help you determine whether the carrier power is set correctly and whether the transmitter filter is working properly.

You can measure the channel power in one, two, or three adjacent (offset) channels on the low frequency and high frequency side of the carrier channel.

Limits can be used to quickly see if too much power is measured in the adjacent channels.

Figure 9-17 GSM 850-Ch 251-Up with one Offset

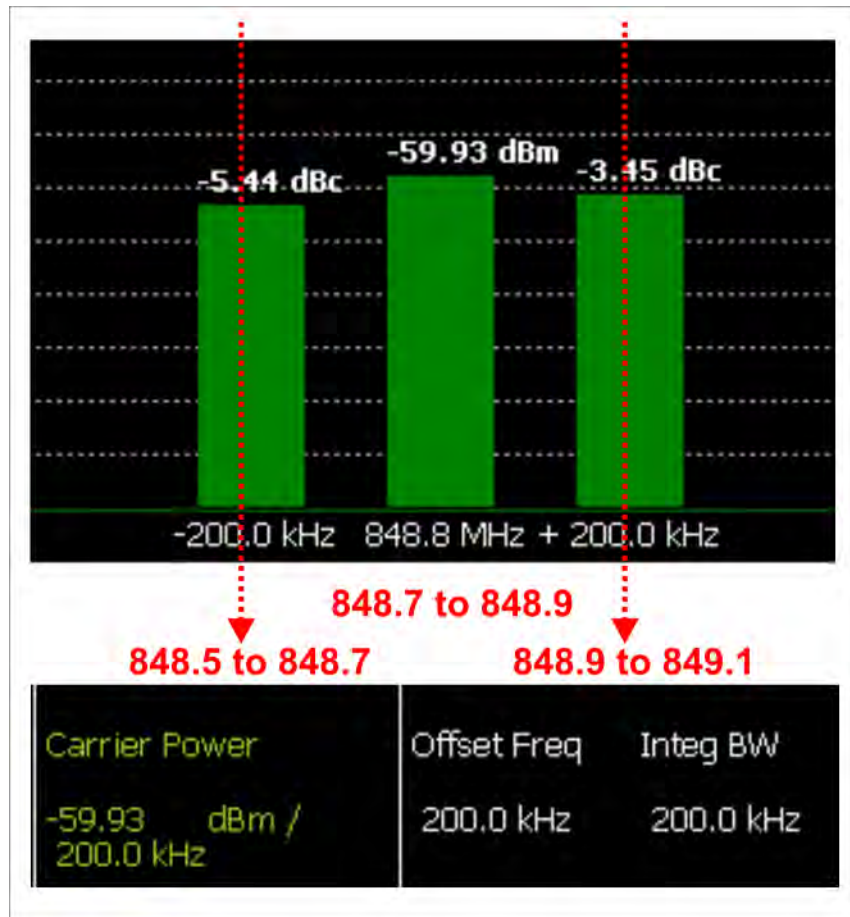

In the graphic above, red frequencies (MHz) are added to illustrate offset and integ BW.

Data in the ACPR graphical chart is always presented in dBm for the carrier, and dBc (dB below the carrier) for the offsets. This can NOT be changed. Use the **Meas Type** setting (next page) to change how the data is presented in the table below the graph.

How to select ACPR

- Press **Measure 1**
- Then **Channel Measurements**
- Then **Adjacent Channel Power**

When ACPR is selected, the following settings are maintained from a previous measurement: Center Frequency, Preamp ON|OFF, and RF Attenuation.

Frequency Range/Channel

When a Radio Standard is selected, the appropriate center frequency or channel and span is set automatically. The frequency or channel number can then be changed from the **Freq/Dist** menu. Learn how to select a Radio Standard and channels in **“Radio Standard” on page 165**.

The frequency range of an ACPR measurement can also be entered using arbitrary frequencies.

When a Radio Standard is NOT selected, the center frequency of a previous measurement is maintained when ACPR is selected.

Integration Bandwidth

The Integration Bandwidth of the carrier and offsets is the frequency span over which power is measured.

To change Integration Bandwidth:

- Press **Meas Setup 4**
- Then **Integrating BW**
- Enter a value between 100 Hz and 100 MHz using the numeric keypad, **▲▼** arrows, or the rotary knob.
- Press **Enter**

How to define adjacent (Offset) channels

An offset represents a difference in center frequencies of the carrier channel and its adjacent channel to be measured. The frequency range for each offset is specified with an Offset Freq and Integ BW. Each offset that is created has a Lower (carrier MINUS Offset Freq) and Upper (carrier PLUS Offset Freq) set of frequencies.

- Press **Meas Setup 4**
- Then **Offsets**
- Press **Offset 1 2 3** to select an offset.
- Then **Offset State** to set that offset ON or OFF.
- Select **Offset Freq** This is the difference between the **carrier center frequency** and the **center frequency of the offset channel**. Then enter a value using the numeric keypad.
- Select **Offset Integ BW** This is the frequency range over which power is measured in that offset; half of the range below and half above the Offset Freq.

How to set limits for adjacent channels

You can set a unique threshold power for each of the offsets that will cause a FAIL indication (RED bar). This occurs when the calculated **dBc** power (on top of the offset bar) is ABOVE the specified level.

To set limits, with an ACPR measurement on the screen:

- Press **Limit 8**
- Then **Offset (1,2,3)**
- Then choose from the following:
 - **LowerOffsetLimit** Sets a limit for the lower-frequency offset.
 - **Upper OffsetLimit** Sets a limit for the higher-frequency offset.
- Then enter a value using the numeric keypad, **▲▼** arrows, or the rotary knob.
- Then **Limit Test ON OFF**

Measurement Type

This setting determines how the measured carrier and offset power levels in the **table** are presented. (Data in the graphical chart is always presented in dBm for the carrier and dBc for the offsets.)

To select Meas Type:

- Press **Meas Setup 4**.
- Then **More**
- Then **Meas Type**
- Then choose from the following:
 - **Total Pwr Ref** – Integrated carrier power is represented in dBm, and relative powers between offsets and carrier are represented as dBc (dB below the carrier).
 - **PSD Ref (Power Spectral Density)** – Integrated carrier power is normalized to a 1 Hz density as dBm/Hz using a similar algorithm as Noise Marker. Learn more about the Noise Marker in **“Noise Marker” on page 221**.

For both Meas Types, choose the reference for the offset data.

- Press **Ref Value** to toggle between these settings:
 - **Auto** – dB or dBc value is computed by subtracting the measured carrier power from the measured offset power.
 - **Man** – dB or dBc value is computed by subtracting the entered RefValue from the measured offset power.

–Then enter a value to be used to reference the data using the numeric keypad,  arrows, or the rotary knob.

Other ACPR Settings

All relevant FieldFox settings are made automatically to ensure the highest accuracy, such as ResBW, VideoBW, and sweep (SwpAcquisition) speed. These, and all other SA Mode settings, can be changed manually in a ACPR measurement.

- Learn about Measurement Preset in [“Measurement Preset” on page 225](#).
- Learn about Averaging in [“Averaging” on page 225](#).

RRC Weighting

RRC, or Root-Raised-Cosign weighting, is offered with Channel Power and ACPR measurements.

When RRC Weighting is applied to transmitted and received power, the edges of the channel are ‘smoothed’ to help prevent interference. To accurately measure a channel that has RRC weighting, set the same value of RRC weighting as that used in the transmitter and receiver.

Figure 9-18 Channel power measurement with .22 RRC applied

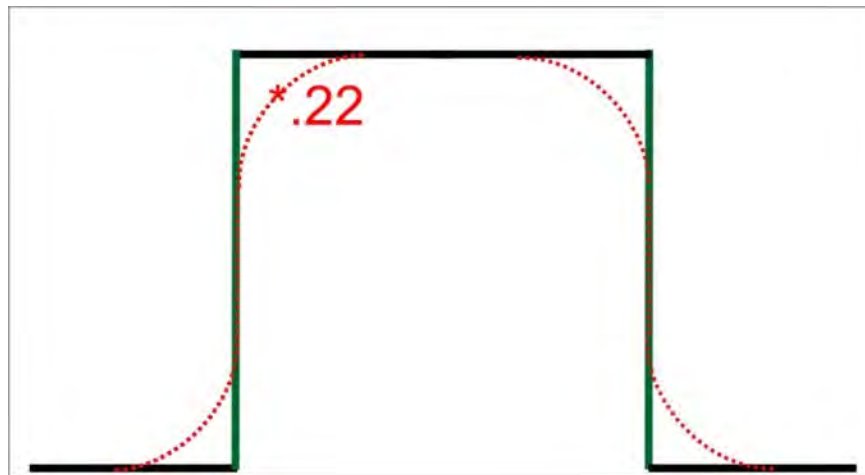

RRC Weighting is set and enabled automatically when included in a selected radio standard.

To set and enable RRC Weighting:

- Press **Meas Setup 4**
- Then **RRC Weighting ON OFF**
- Then **More**
- Then **RRC Alpha [current setting]**

SA (Spectrum Analyzer) Mode (Option 233–Mixed Analyzers)
Channel Measurements

- Enter a value between 0 (no smoothing) and 1 (most smoothing) using the numeric keypad,  arrows, or the rotary knob. A standard level of filtering is 22.
- Press **Enter**.

How to Set Up EMF Settings (Requires EMF (Option 358), GPS (Option 307), and SA Mode (Option 233–Mixed Analyzers))

CAUTION

If OTA or SA mode does **not** detect an EMF Option 358 license, then the EMF application and the USB antenna's axes must be set up manually. This use model is **not** recommended or supported by Keysight.

CAUTION

The USB antenna's cable loss is **not** included, in the antenna's correction factors. For an accurate EMF measurement, the cable loss values should be accounted for. Refer to **“Editing Cable Correction Factors and Adding New Cable Factors” on page 245.**

NOTE

IMPORTANT! The USB triaxial antenna—or equivalent—is required for EMF measurements. Refer to **Chapter 15, “USB Antennas – (Full Capability Requires EMF Option 358, and SA mode (Option 233 Mixed Analyzers)).”**

EMF mode measures signals at the SA RF Input Port 2 connector.

EMF mode requires the FieldFox to have SA mode (Option 233 on combination analyzers), GPS (Option 307), and CPU2 installed.

Recommended, but not required, preamplifier (Option 235) to improve receiver sensitivity.

With Option 358 (EMF), network designers can measure and verify the RF exposure compliance as required by each country.

If SA mode is licensed for EMF Option 358, the primary measurement performed is Channel Power (CHP) which automatically switches amongst the 3 TriAxial antenna axis (X/Y/Z), to provide a summation of “total power” detected, using unique Antenna supplied corrections for the individual axis, with results in FieldStrength units. This is accomplished within the existing SA Channel Power measurement.

Even without license EMF Option 358, the System Utilities menu enables one to Import Corrections and manually drive the Antenna to a particular axis (X, Y, or Z). The manual control thus allows any SA Receiver measurement to sweep that axis just like any other antenna transducer, however without license the imported corrections are not usable from the Apps. But with license the SA provides for easy use of the imported XYZ corrections, thus allowing presentation of correctly compensated FieldStrength measurements, for 1 axis at a time.

This section reviews the steps in setting up an EMF measurement, using a USB antenna. If you are not familiar with this process or would like more information, refer to **Chapter 15, “USB Antennas – (Full Capability Requires EMF Option 358, and SA mode (Option 233 Mixed Analyzers)).”**

This section consists of:

SA (Spectrum Analyzer) Mode (Option 233–Mixed Analyzers)
How to Set Up EMF Settings (Requires EMF (Option 358), GPS (Option 307), and SA
Mode (Option 233–Mixed Analyzers))

- “EMF Features” on page 237
- EMF Setup Procedure

EMF Features

EMF has the following features:

EMF Measurement Results:

- Measure and display corrected field strength in RMS average power
- Antenna control over X, Y, and Z antenna factors downloaded via USB
- Pass/Fail limit testing supported
- External PC **not** required

EMF uses the following data formats:

- Field Strength units:
 - dB μ V/m – For use with E-field signals
 - dB μ A/m – For use with H-field signals
 - dBG – dB Gauss
 - dBpT – dB Tesla

SA (Spectrum Analyzer) Mode (Option 233–Mixed Analyzers)

How to Set Up EMF Settings (Requires EMF (Option 358), GPS (Option 307), and SA Mode (Option 233–Mixed Analyzers))

Figure 9-19

Example of EMF with Triaxial Antenna

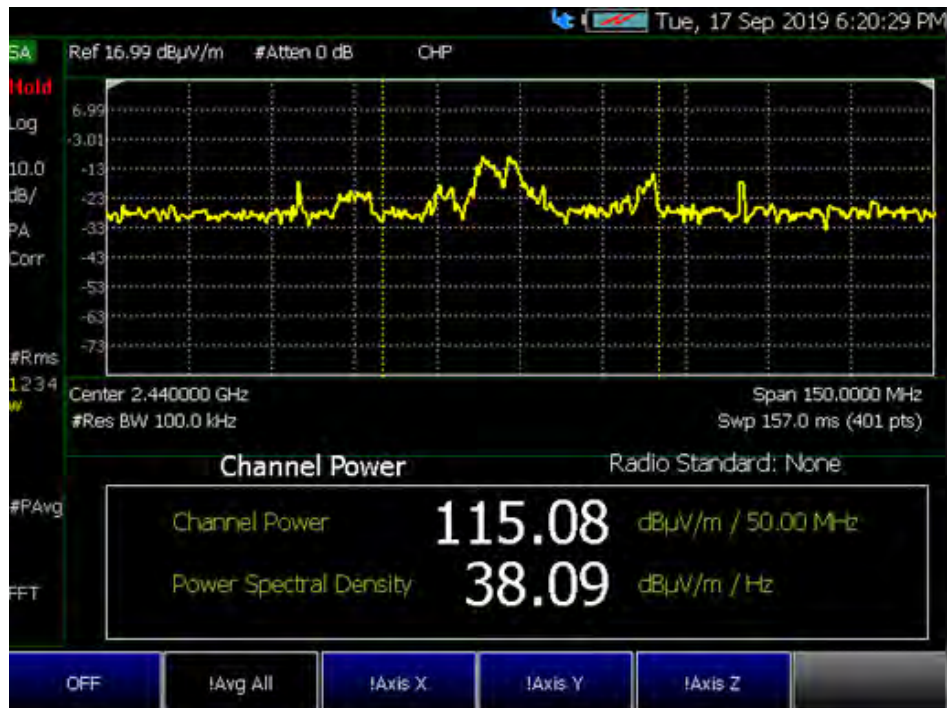
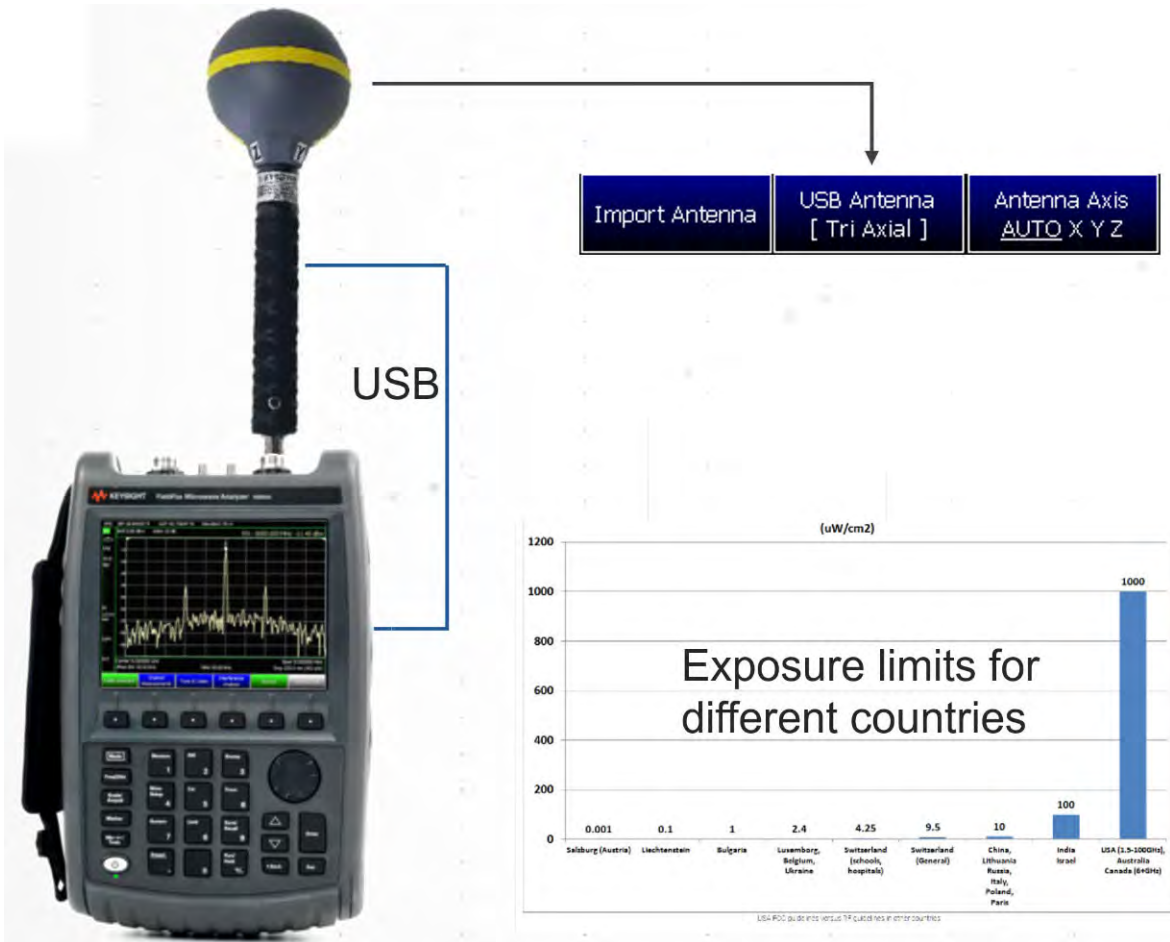

EMF Setup Procedure

NOTE

When the USB antenna correction factors are imported, EMF (Option 358) couples many settings to ease setting up the EMF measurement (e.g., **Apply Corrections** is enabled, all X, Y, and Z antenna axes are enabled, and **Amp Corr Select** is set to **TriAxial XYZ**).

1. Setup the FieldFox Spectrum Analyzer for a Channel Power measurement.

a. Press **Mode** > **SA** >

Press **Measure 1** > **Channel Measurements** > **Channel Power**

See also, “**Channel Measurements**” on page 225.

NOTE

If necessary, this step can be skipped and done **after** the USB antenna is set up.

2. Connect a USB antenna’s RF cable to the **SA RF Input**, port 2 and the USB connector to a FieldFox USB port. See also, **Figure 9-19 on page 238** and to **Chapter 15, “USB Antennas – (Full Capability Requires EMF Option 358, and SA mode (Option 233 Mixed Analyzers)).”**

CAUTION

Only Agos Advanced Technologies SDIA-6000 Triaxial Isotropic USB antenna is currently compatible with EMF (Option 358).

3. Importing and selecting the X/Y/Z antenna factors:

a. Press **System** > **Utilities** > **USB Antennas**

– Then **Import Antenna** – to import the antenna factors from the antenna’s memory over the USB connection (this may take 5 seconds or so and vary with the Triaxial antenna).

NOTE

If the antenna factor import is successful, the FieldFox displays:
"Success: Antenna Factors Imported: Tri-Ax Antenna ID:
->[R] Antenna ID: SDIA-6000-1006 ->[]". The last 4-digits will vary for each antenna (i.e., “1006” value will vary).

If the FieldFox displays this error **Error: USB antenna Error: Not found or Unable to communicate with antenna. Ensure it is connected.** is displayed, verify the USB antenna is connected correctly. See also, “**Troubleshooting**” on page 446.

– Then **USB Antenna [Tri Axial]** verify Triaxial (default) is selected.

– Optional: Press **Antenna Axis** the antenna axis should be set to **Auto** for default operation. When AUTO is selected the application (e.g., Channel Power or OTA) controls the axes and switches as needed. With the AUTO setting, all antenna elements (X, Y, and Z) are OFF.

SA (Spectrum Analyzer) Mode (Option 233–Mixed Analyzers)
 How to Set Up EMF Settings (Requires EMF (Option 358), GPS (Option 307), and SA Mode (Option 233–Mixed Analyzers))

- Press **Back** > **Back** to exit the USB Antenna softkey menu.

4. Modifying the EMF settings:

Press **Meas Setup 4**

- Then **More** > **EMF** then
 - **EMF Meas OFF ON** disable/enable the EMF measurement.
 - **EMF Units** choose dBuV/m (default) or V/m.
 - **Back** to exit to the previous softkey menu.

For more details on editing the USB antenna, refer to **Chapter 15, “USB Antennas – (Full Capability Requires EMF Option 358, and SA mode (Option 233 Mixed Analyzers)).”**

5. Enabling the imported USB antenna factors and Cable factors:

- Enabling the Channel Power: Press **Measure 1** > **Channel Measurements** > **Channel Power**
- To enable the Triaxial antenna for EMF: Press **Meas Setup 4** > **EMF Triaxial [OFF]** > **Sum All**

With Sum all, the field strength from all three axes is summed and displayed. The RF measurements are switched between the three different antennas (three dipoles), and the resulting summation of the total power collected, and averaged.

Alternatively, you can select either of three axes to individually measure the field strength in the one direction.

- Else, if the **SysCtrl Triaxial** softkey is viewable (i.e., **EMF TriAxial [OFF]** is **not** viewable). The **SysCtrl Triaxial** softkey is not editable, and indicates the System control softkeys are manually controlling a single X, Y, or Z antenna dipole for **uncorrected** use. [X, Y, or Z] is displayed to indicate which one of the X/Y/Z dipole axes is enabled. If for example the X axis has been selected in the **System > Utilities > USB Antenna** menu, then **USB Antenna [X]** is displayed to indicate the X axis measurement (i.e., this uncorrected manual mode is typically used when no EMF Option 358 is installed). Refer to **Figure 9-20**. See also step f.

Figure 9-20 SysCtrl Triaxial [N] Softkey – With the X–Axis Dipole Selected



d. Modifying the Amplitude Correction Selection:

Press **Scale/Amptd** > **More** > **Corrections** > **More** then

- **Amp Corr Select [Triaxial XYZ]** - then choose one of the following:

- **Default** Receiver side only antenna measurements.
 - **Src/Rcvr Split** to work with non-triaxial receiver and source side antenna measurements.
 - **Triaxial XYZ** (default, when Channel Power is on and when a compatible triaxial antenna's factors have been imported) for measuring channel measurements and EMF.
- Then **Back** to exit to the previous softkey menu.

e. Optional (Triaxial XYZ Antenna):

Verifying antenna and cable corrections are applied:

i. Press **Scale/Amptd** > **More** > **Corrections**

- Then verify the **Apply Corrections Auto Disabled** softkey is set to **Auto** (This is the default setting when a compatible USB antenna's correction factors have been imported, via the System softkeys).
- Verify the **X axis Antenna**, **Y axis Antenna**, and **Z axis Antenna** are all **ON**. These can each be enabled or disabled individually, but for EMF measurements all three axes should be enabled (i.e., Antenna = Off, the applications are setting the X/Y/Z).
- Verify **Cable** is **ON**. This can be disabled for applications where an additional cable has not been connected to the triaxial antenna. Before a cable can be used with the EMF measurements it needs to have corrections loaded. If you are going to use a cable, then choose as needed:
 - **Edit Cable** displays a cable corrections table that you can edit
 - **New** displays a cable corrections table that you can edit with new cable correction content.

Yes

– Choose **Yes** to overwrite the current cable data

No

– Choose **No** to exit the cable data edit table view

- **Save Cable** Opens a menu to name and save the cable corrections data
- **Recall Cable** Recalls the selected cable correction file from the \Cables folder.

SA (Spectrum Analyzer) Mode (Option 233–Mixed Analyzers)
How to Set Up EMF Settings (Requires EMF (Option 358), GPS (Option 307), and SA Mode (Option 233–Mixed Analyzers))

- **Storage Device** to select the storage device where your cable correction file is located (Internal/USB/SD Card)

ii. **Optional:** Press **More** then

- Press **View Corrections OFF ON** to turn ON and OFF Pink Trace - Antenna/Cable corrections. This is a composite of all cable/antenna corrections that are currently applied. Available as a useful visual aid, the zero “dB” level (no net correction) is mapped to appear at the -50 dBm on-screen level.
- Press **Src/Rcv Split** - selecting **Src/Rcv Split** selects Source and Receiver side measurements.

f. **Optional:** Example of editing X, Y, and Z axes manually.

NOTE

The USB antenna factors stored in the triaxial antenna itself cannot be overwritten. The antenna factors on FieldFox imported into FieldFox can be modified. To reset the antenna factors in FieldFox to the original factors, re-import the antenna factors.

-
- Press **X axis Antenna** – opens the X axis Antenna softkey menus. Then choose one or more of the following:
 - **X axis Antenna** – enable/disable the X axis antenna factors (default is coupled to other settings).
 - **Edit Antenna** – to edit the current imported X factor (if available). Refer to **“Editing Antenna Correction Factors and Adding New Antenna Factors” on page 243.**
 - **New** – to edit/define a new X factor value. Refer to **“Editing Antenna Correction Factors and Adding New Antenna Factors” on page 243.**
 - **Save Antenna** – to save either an edited X antenna factor or a new X antenna factor. See also **Chapter 30, “System Settings”** and then to **“Alpha Numeric Editing” on page 742.**
 - **Recall Antenna** – to recall a stored X antenna factor. See also **Chapter 30, “System Settings.”**
 - **Storage Device** – to select the location to store your new antenna factor. See also **Chapter 30, “System Settings.”**

Editing Antenna Correction Factors and Adding New Antenna Factors

This section contains two procedures illustrating how to edit the Antenna Factors settings table values.

NOTE

If **New** is selected under the **X, Y, or Z Antenna** or **Cable** softkey menu, whatever antenna or cable factors that have been imported as the default values and are displayed in the **Settings** table.

1. Selecting an antenna softkey menu:

Press **Scale/Amptd** > **More** > **Corrections** then choose one of these softkey menus:

- **X axis Antenna** – to open a softkey menu to edit the X axis of a triaxial antenna.
- **Y axis Antenna** – to open a softkey menu to edit the Y axis of a triaxial antenna.
- **Z axis Antenna** – to open a softkey menu to edit the Z axis of a triaxial antenna.
- **Cable** – to open a softkey menu to edit the cable factors for an antenna setup.

2. For this example, the X axis Antenna softkey menu has been selected:

- a. Then press **Edit Antenna** to edit the existing X axial antenna factor's Frequency and Antenna Factor table values that are stored in the FieldFox [:Internal] : \Antenna\ directory (Refer to **Figure 9-21**). Then you can edit the following:

- **Description** – edits the name of the current antenna settings table
- **Antenna Factor Unit** – edits the units from dB /m electric antenna factor (default) to dB S/m for the magnetic antenna factors. **None** is displayed, when no antenna is detected.
- **Frequency** – edits the frequency value measured that corresponds to a particular Antenna Factor.
- **Antenna Factor** – edits the Antenna Factor that corresponds to a particular frequency.

Refer to next step for details on editing the antenna Settings table.

- b. Use the **▲▼** arrows, the rotary knob, or numeric keypad to select the table cell value to be edited (i.e., the Frequency Interpolation value is not editable). Then:

- Press **Edit Antenna** to edit your existing antenna factors or press **New** to add a new antenna's factors or to write over your existing antenna's file (i.e., **Overwrite existing Antenna data?** is displayed above the table).
 - Choose **Yes** to write over the existing antenna file.
 - Choose **No** to create a new antenna file (default filename is Example).
- Press **Add Row** to create additional Frequency and Antenna Factor values.
- Press **Delete/Clear** then choose one of these:
 - **Delete Row** – when pressed this choice deletes the currently selected row of Frequency and Antenna Factors (i.e., you must press **Yes** to delete a row or **No** to exit the current softkey menu).
 - **Clear All** – when pressed this choice deletes all of the currently selected rows of Frequency and Antenna Factors (i.e., you must press **Yes** to delete the rows or **No** to exit the current softkey menu).
 - **Back** – To exit to previous softkey menu.
- Press **Done** when finished editing to exit.
- c. Press **Save Antenna** to save your changes. See also “File Saving Naming Options” on page 742 and then to “Alpha Numeric Editing” on page 742.

For more information:

- See also “GNSS (GPS+) and GPS” on page 749.

SA (Spectrum Analyzer) Mode (Option 233–Mixed Analyzers)
 How to Set Up EMF Settings (Requires EMF (Option 358), GPS (Option 307), and SA Mode (Option 233–Mixed Analyzers))

Figure 9-21 Example Editing and Adding a New X axis antenna is shown.

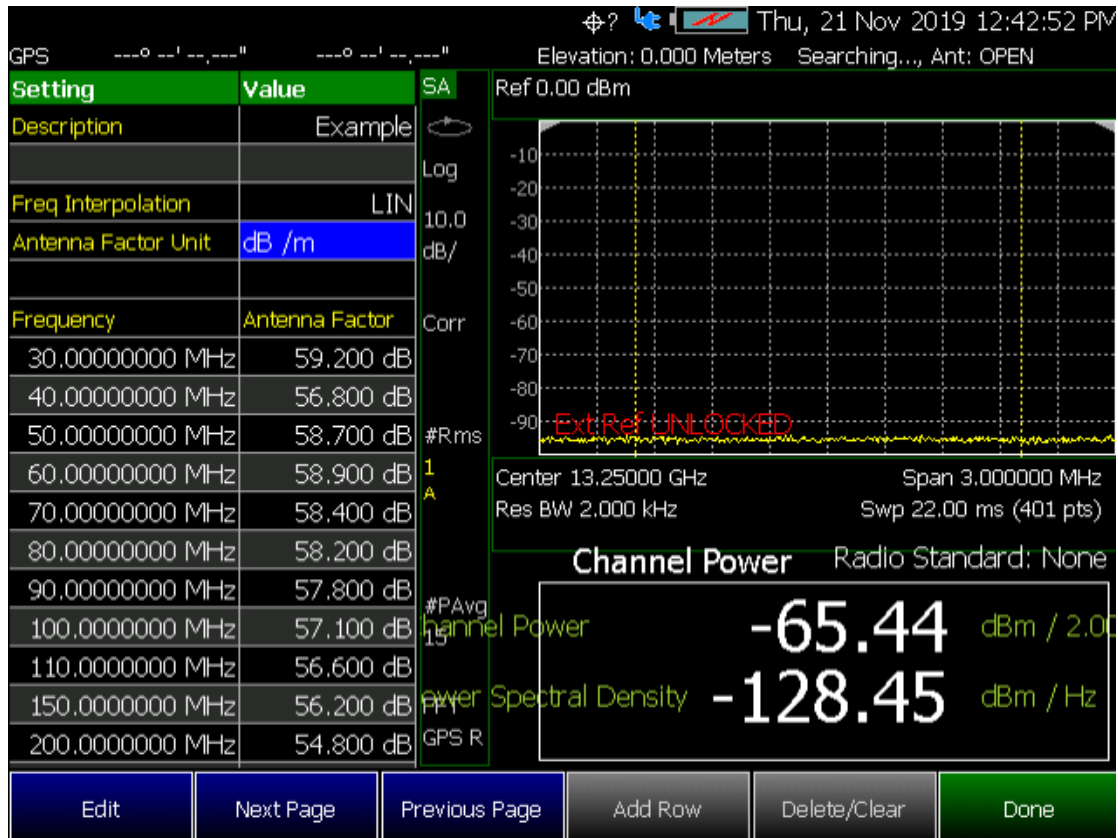

Editing Cable Correction Factors and Adding New Cable Factors

This section contains two procedures illustrating how to edit the Cable Factors settings table values.

NOTE

If **New** is selected under the **X, Y, or Z Antenna** or **Cable** softkey menu, whatever antenna or cable factors that have been imported as the default values and are displayed in the **Settings** table.

1. Selecting an cable softkey menu:

Press **Scale/Amptd** > **More** > **Corrections** then choose one of these softkey menus:

- **Cable Off** – to open a softkey menu to edit the cable factors for an antenna setup.

2. For this example, the Cable Off softkey menu has been selected:

- a. Then press **Cable Off** > **Edit Cable** to edit the existing cable's Frequency and Cable Loss table values that are stored in the FieldFox [:Internal] : \Cable\ directory (Refer to **Figure 9-21**). Then you can edit the following:
- **Description** – edits the name of the current cable correction settings table
 - **Frequency Interpolation** – sets the frequency interpolation to linear or to log.
 - **Frequency** – edits the frequency value measured that corresponds to a particular Cable Loss.
 - **Cable Loss** – edits the Cable Loss value that corresponds to a particular frequency.

Refer to next step for details on editing the cable Settings table.

- b. Use the **▲▼** arrows, the rotary knob, or numeric keypad to select the table cell value to be edited (i.e., the Frequency Interpolation value is not editable). Then:
- Press **Edit Cable** to edit your existing cable loss data or press **New** to add a new antenna's factors or to write over your existing antenna's file (i.e., **Overwrite existing Cable data?** is displayed above the table).
 - Choose **Yes** to write over the existing cable file.
 - Choose **No** to create a new cable file (default filename is Example).
 - Press **Add Row** to create additional Frequency and Cable Loss values.
 - Press **Delete/Clear** then choose one of these:
 - **Delete Row** – when pressed this choice deletes the currently selected row of Frequency and Cable Loss (i.e., you must press **Yes** to delete a row or **No** to exit the current softkey menu).
 - **Clear All** – when pressed this choice deletes all of the currently selected rows of Frequency and Cable Loss (i.e., you must press **Yes** to deleted the rows or **No** to exit the current softkey menu).
 - **Back** – To exit to previous softkey menu.
 - Press **Done** when finished editing to exit.

SA (Spectrum Analyzer) Mode (Option 233–Mixed Analyzers)
 How to Set Up EMF Settings (Requires EMF (Option 358), GPS (Option 307), and SA Mode (Option 233–Mixed Analyzers))

- c. Press **Save Cable** to save your changes. See also “File Saving Naming Options” on page 742 and then to “Alpha Numeric Editing” on page 742.

For more information:

- See also “GNSS (GPS+) and GPS” on page 749.

Figure 9-22 Example: Editing and Adding a New X axis antenna is shown. But, the Cable Loss table is similar.

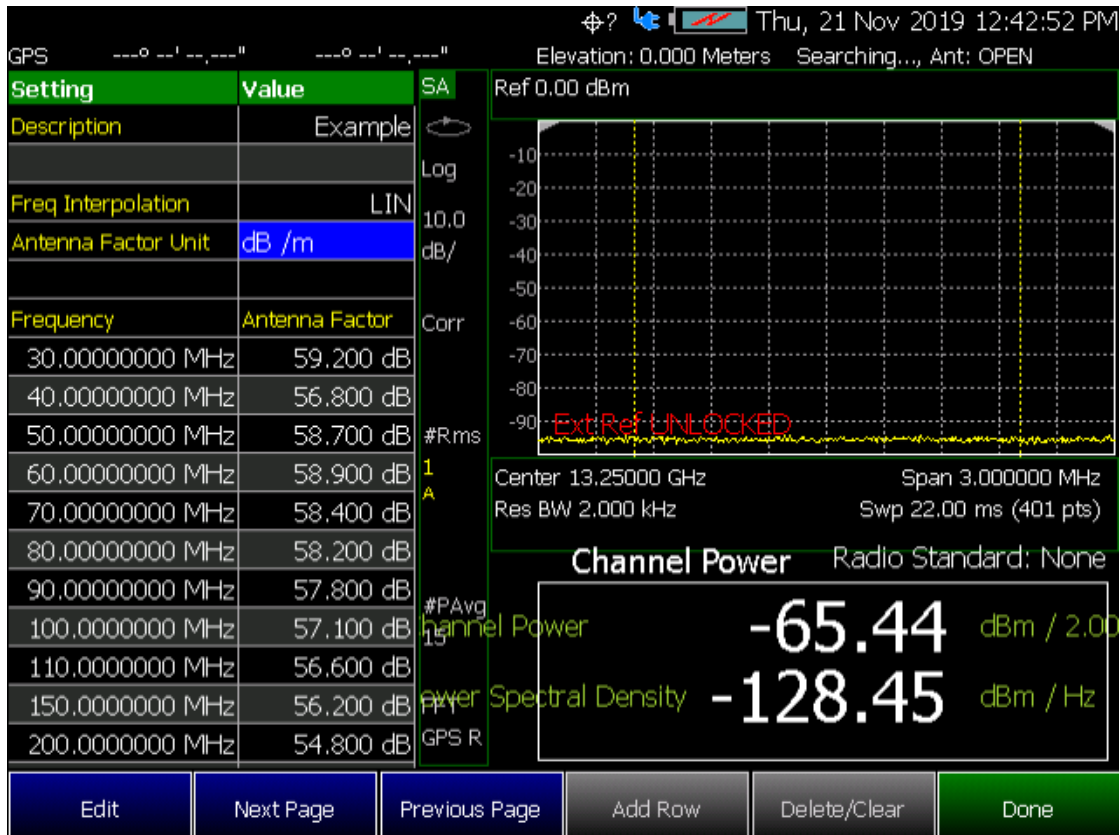

Spectrum Emission Mask (SEM) – (Requires CPU2, SA Mode Only)

This section explains how to make the spectrum emission mask, (SEM), measurement. SEM compares the total power level within the defined carrier bandwidth and offset channels on both sides of the carrier frequency, to levels allowed by standard. Results of the measurement of each offset segment can be viewed separately.

Purpose

The Spectrum Emission Mask measurement includes the in-band and out-of-band spurious emissions. It is the power contained in a specified frequency bandwidth at certain offsets relative to the total carrier power. It may also be expressed as a ratio of power spectral densities between the carrier and the specified offset frequency band.

The spectrum emission mask measurement is a composite measurement of out-of-channel emissions, combining both in-band and out-of-band specifications. It provides useful figures-of-merit for the spectral regrowth and emissions produced by components and circuit blocks.

Measurement Method

The spectrum emission mask measurement measures spurious signal levels in up to 8 pairs of offset/region frequencies and relates them to the carrier power.

The integration bandwidth method is used to perform a data acquisition. The reference channel integration bandwidth (Meas BW) is analyzed using the user defined resolution bandwidth (Res BW), which is much narrower than the channel bandwidth. The measurement computes an average power of the channel or offset/region over a specified number of data acquisitions, automatically compensating for resolution bandwidth and noise bandwidth.

This measurement requires the user to specify the measurement bandwidths of carrier channel and each of the offset/region frequency pairs up to 12 (A - L). Each pair may be defined with unique measurement bandwidths. The results are displayed both as relative power in dBc and as absolute power in dBm.

Summary

Similar to other Radio Channel measurements, SEM sweeps and measures the total power within a Reference channel. It also optionally performs sweeps of user defined offset segments both above and below the reference channel. The peak signals within the offsets are compared against limits, to determine PASS or FAIL results. Tabular data is presented showing individual offset segment results, one row for each offset. A final trace is displayed that contains all of offset segment sweeps and the reference channel sweep is formed and plotted along with the limits.

The following are displayed:

- **Total Power Ref (dBm / Hz)** - measures total power over the specified Integrated BW.

SA (Spectrum Analyzer) Mode (Option 233–Mixed Analyzers)
 Spectrum Emission Mask (SEM) – (Requires CPU2, SA Mode Only)

- **Spectrum Emission Mask Pass/Fail** – A PASS indicates the displayed SEM is within the current boundaries specified. A FAIL indicates the current signal fails with the specified parameters.

Figure 9-23 SEM Example

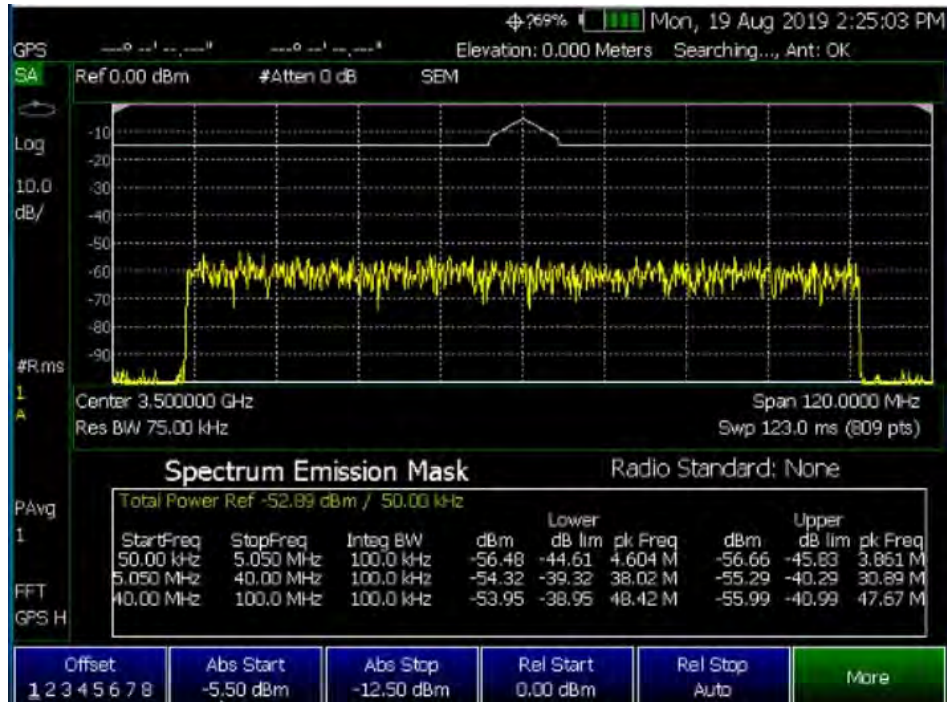
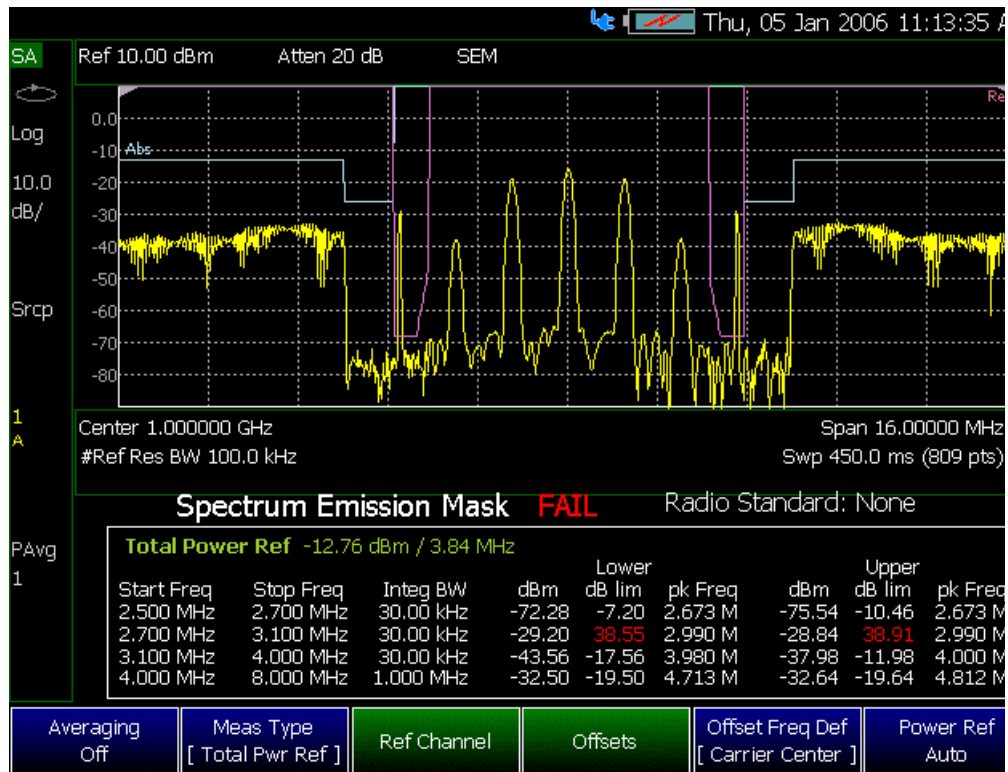

Figure 9-24

SEM Example FAIL Data - Absolute Limit (Blue), Relative Limit (Violet), Trace (Yellow), and Tabular Data



How to select Spectrum Emission Mask (SEM) Measurement

- Press **Measure 1**
- Then **Channel Measurements**
- Then **Spectrum Emission Mask**

When SEM is selected, the following settings are maintained from a previous measurement: Center Frequency, Preamp ON|OFF, and RF Attenuation.

Setting up the FieldFox for Spectrum Emission Mask (SEM) Measurement

1. Press **Measure 1** > **Channel Measurements** > **Spectrum Emission Mask**
2. Press **Meas Setup 4** then optionally select:
 - **Averaging** Enable/disables averaging and sets the number of trace averages (Default is OFF).
 - **Meas Type** Then select one of the following:

Measurement Type (Meas Type) enables the user to select the method used to calculate the reference power level.

NOTE

The displayed green power (dBm)/frequency (Hz) text changes as the Meas Type is toggled.

-
- **Total Pwr Ref** (Default is Total Pwr Ref) is the total integrated reference channel power (dBm) is measured and used as the Auto Power Ref value. Peaks found in Offset segments remain in (dBm) units for direct comparison with (dBm) limits.
 - **PSD Ref** the power spectral density (dBm/Hz) is measured and used as the Auto Power Ref value. Absolute Limits and Peaks found in Offset segments are normalized to their equivalent PSD value (dBm/Hz).
 - **Spec Pk Ref** the spectral peak value measured within the reference channel (dBm) is used as the Auto Power Ref value. Peaks found in Offset segments remain in (dBm) units for direct comparison with (dBm) limits. Values in the table are compared to the peak power of the spectrum.
 - **Ref Channel** Opens the Reference Channel softkey menu. Then select one of the following:
 - **Integ BW** Sets the Integrated bandwidth.
 - **Ref Chan Span** Sets the reference channel span. usually set equal or greater than the Integ BW, it is simply a way to reserve additional freq range to be measured for display presentation, if that range is not overlapped by the offset regions. The reference channel is always measured completely as specified, but only the central part of the reference channel that is NOT overlapped by active offset regions is displayed. (Minimum = 10 Hz/ Maximum = Value varies with model and options).
 - **Carrier Center** Tracks currently displayed carrier center frequency (Default = TrackCF). Set to Hold to disable the carrier frequency tracking.
 - **Res BW** Auto/Manual (Default is Auto). Sets the resolution bandwidth. See also, “Resolution Bandwidth (Res BW)” on page 194.
 - **Offsets** Opens the frequency Offsets softkey menu. Then select one of the following:
 - **Offset** Sets the number of pairs of frequencies to be offset (up to eight pairs can be selected).

- **Ofst Enable** Enables/disables the currently selected Frequency Start/Stop Offset values.
- **Ofst Freq Start** Sets the offset frequency start value. (Default/Maximum = Value varies with model and options, Minimum = 0 Hz).
- **Ofst Freq Stop** Sets the offset frequency stop value. (Default/Maximum = Value varies with model and options, Minimum = 0 Hz).
- **Res BW** Auto/Manual (Default is Auto). Sets the current resolution bandwidth value. See also, “Resolution Bandwidth (Res BW)” on page 194.
- **Offset Side Neg Both Pos** (Default is Both). Sets the offset side measurement value. Select Negative (Neg) to measure the negative side of the spectrum. Select Positive to measure the positive side of the spectrum.
- **Offset Freq Def** then select one of the following:
 - **Carrier Center** (Default) applies the frequency offsets to the current carrier center frequency.
 - **Carrier Edge** Selects the edge of the carrier for frequency offset definition.
- **Power Ref** – the reference power value can be fixed (which also fixes the Relative Limit line), but the user must then consider the unit being used (dBm or dBm/Hz) depending on the Meas Type selected. If Power Ref is left AUTO (Default) then its value will track the Meas Type and change units automatically. Both fixed and Auto settings display the power reference value measured.

3. Setting Center Frequency and Span

NOTE

Frequency control menu (Center and Span) provides an SEM Auto Span control (defaulted to ON) which automatically tracks the necessary span to cover all enabled offset segments. In the example in [Figure 9-24 on page 250](#), the necessary span is 16 MHz. But you can de-couple the span simply by narrowing or widening Span in order to zoom.

The Carrier Frequency (Ref Channel Center) by default tracks the specified Center Frequency, but can be forced to “Hold” at a particular location which would then allow the user Center Frequency to pan above or below for reasons similar to zooming with span.

Press **Freq/Dist** then

- **Center** - sets the center frequency.
- **SEM Auto Span** - Enables/disables the SEM Auto Span.
- **Freq Span** - sets the frequency span of the SEM measurement.

- **More** - optional to set Radio Standard controls. Refer to “Radio Standard” on page 165.

4. Setting the Limit Lines

Two Limit traces are available, an Absolute Limit and a Relative Limit. Both are defined and applied only over the Offset measurement regions. There is no Limit definition or application for the Reference Channel itself. The final Limit Trace displayed is a concatenation of all the individual Offset Limit segments, just as the final measurement trace is. Success or Failure is determined by Fail Mask per offset, to be based on either Relative or Absolute limits, Both (Abs AND Rel), or Either (Abs OR Rel).

Press **Limit 8** then

- **Offset** - selects the offset region to be edited.

The Limits per offset are determined by Start/Stop Amplitude level endpoints, which correspond exactly to the user specified Start/Stop frequency locations in the Offsets sub-menu. So each offset segment is a LINE defined by its two endpoints. In the Limit menu “Auto” means to match the Start limit value, hence creating a FLAT (horizontal) Limit Line segment. But the Stop value can be manually set as well, creating sloped Limit segments.

- **Abs Start** - Sets the start of an absolute limit line segment.
- **Abs Stop** - Sets the stop of an absolute limit line segment.
- **Rel Start** - Sets the amplitude limit at the start frequency of the offset, relative to the reference power level.

NOTE

The reference power level is displayed in green. The reference power level type can be selected through **Measure 1** > **Meas Type**, and the reference power settings defined through **Meas Setup** > **Ref Channel**.

Example: If the reference power level reads -15 dBm, and **Rel Start** is set to -10 dB, the level is -25 dBm. Since this limit line type is relative, it moves with the reference power reading.

-
- **Rel Stop Auto** - Sets the amplitude limit at the stop frequency of the offset, relative to the reference power level. (See also the note in the **Rel Start Auto** softkey description above.)
 - **Fail Mask** - Sets the Fail Mask offset parameters for the measurement. Then choose:
 - **Absolute** - Measured data outside the specified limit line data parameters generates fail message.

- **Relative** - A data point that exceeds the value of the reference setting determined by the Measurement Type (Meas Type) generates a fail message.
- **Abs OR Rel** - Either Abs or Rel data failure generates a fail message.
- **Abs AND Rel** - Requires a relative and an absolute data failure to generate a fail message.

5. Setting the Detectors

The Trace menu shows that two Detector controls are available, one for the Reference Channel (default Auto is Average to facilitate the Power Integration), and another for all the Offset segments (default Auto is PEAK, to facilitate finding PEAK signal energy when comparing against Limits). There is only 1 Trace available, and like the other Channel Measurements, it is set to average.

Press **Trace 6** then

- **State** - sets the measurement state. Refer to “Trace Display States (SA Mode)” on page 208.
- **Default All** - Sets the SEM settings to default
- **Chan Detector** - Sets the Reference Channel detector (default Auto is Average to facilitate the Power Integration). See also “Detection Method” on page 218.
- **Offset Detector** - Sets all of the Offset segments (default Auto is Peak, to facilitate finding peak signal energy when comparing against the Limits). See also “Detection Method” on page 218.
- **Record Playback** - Refer to “Record/Playback (SA Option)” on page 510.

SA (Spectrum Analyzer) Mode (Option 233–Mixed Analyzers)
IQ Analysis (Requires Option 351 IQ Analyzer and Option 353 IQ Streaming, SA Mode Only)

IQ Analysis (Requires Option 351 IQ Analyzer and Option 353 IQ Streaming, SA Mode Only)

CAUTION

This feature's intended use is that the Streamed data will be sent to another computer. That computer or another one will act as a SCPI controller and is required for actually controlling the streaming, in particular setting up network configuration data and starting and stopping the streaming.

NOTE

IMPORTANT!

- IQ Streaming is used by configuring the desired setup and then starting the acquisition/data stream. In order to make measurement changes (bandwidth, center frequency, etcetera) streaming must be stopped, the new setup configured, and then streaming restarted.
 - During streaming, the data displayed on the FieldFox is not updated.
 - For both Decodio and VITA49, FieldFox encodes all streamed I and IQ data as 32-bit IEEE 754 floating point values.
 - FieldFox does not support TCP networking.
 - Data for both protocols is 2 floating point values per sample (I and Q).
 - Except for the 32-bit floating point only option for I and Q data, FieldFox implements VITA 49A a subset of the VITA 49.2 protocol.
 - While in any IQ Analysis mode, the sample rate to frequency span will stay locked/coupled in a ratio of 1.25:1.
-

How to Select IQ Analysis

- Press **Meas Setup 4**
- Then **IQ Analysis** then choose from
 - Then **General** –
 - Then **Streaming** – to emit a sequence of packets from a specific location in a VRT (VITA49) enabled architecture (e.g., VRT packet class with a defined packet attribute used in one or more places in a architecture to create packet streams).

When IQ Analysis is selected, the following settings are maintained from a previous measurement: Center Frequency, Span, BW, Sample Rate, Preamp ON/OFF, and RF Attenuation.

How to Setup IQ Analysis General

General setup for IQ Analysis:

1. Press **Meas Setup 4** > **IQ Analysis** > **General**
2. Press **IQE Sample Rate** > Auto (default).
3. Press **Average Count** > 10 (default). Learn more refer to “[Adjusting the Measurement Setup Settings](#)” on page 306.
4. Press **Average Type** > Auto (default). Learn more refer to “[Adjusting the Measurement Setup Settings](#)” on page 306.
5. Press **Freq/Dist** > **Center** > 1 GHz
6. Press **Freq Span** > 1 MHz (default).

How to Setup IQ Analysis Streaming

CAUTION

This feature’s intended use is that the Streamed data will be sent to another computer. That computer or another one will act as a SCPI controller and is required for actually controlling the streaming, in particular setting up network data and starting and stopping the streaming.

The feature provides continuous streaming of IQ data up to 1.25 MSamples/sec over the Ethernet port in either VITA49A or Decodio formats.

If locked to GPS, will populate the timestamp applied to streamed data packets. If **not** locked to GPS, the system clock time is used to stamp the streamed data packets. Refer to [Chapter 30, “System Settings”](#) and to “[Frequency Reference](#)” on page 741.

General setup for IQ Streaming:

1. Press **Meas Setup 4** > **IQ Analysis** > **Streaming**
2. Then **IQE SampRate** > **Manual** > 1.25 MHz (default when set to **Auto**).
Setting the IQE sample rate to **Manual**, forces the Span to be:
 $\text{Span} = 0.8 * \text{Sample rate}.$
3. Configure Center Frequency, Span, Preamp, and RF Attenuation
 - a. Press **Freq/Dist** > **Center** > 1 GHz
 - b. Press **Freq Span** > 1 MHz (default).

This forces the Span to be:

$\text{Span} = 1.25 * \text{Span}.$

SA (Spectrum Analyzer) Mode (Option 233–Mixed Analyzers)
IQ Analysis (Requires Option 351 IQ Analyzer and Option 353 IQ Streaming, SA Mode Only)

a. Then to adjust receiver gain:

CAUTION

Typically, the goal is to be able to see the desired signal that you want to capture as close as possible to the top of the display grid on the screen, without causing an ADC over range to be displayed. This maximizes the signal-to-noise ratio.

Press **Scale/Amptd** then

- To configure automatically: Press **Ref Level** – adjust as needed.

or

To adjust manually:

- Press **Preamp ON** (default = OFF)
- Press **RF Atten** > Manual > 15 dB (default)

4. Setup IQ Streaming protocol, destination host, and port:

To set the destination host, IQ streaming protocol, and samples per packet, refer to the [:SENS] : IQST subsystem commands in the [FieldFox Handheld Analyzer SCPI Programming Guide](#) on www.keysight.com.

- Destination Host
- Destination Port – (default is 4991)
- Protocol – Choose Vita or Decodio
- Samples per packet

5. Start Streaming: Refer to the [FieldFox Handheld Analyzer SCPI Programming Guide](#) on www.keysight.com.

6. When done press **Exc** to stop streaming or refer to the [FieldFox Handheld Analyzer SCPI Programming Guide](#) on www.keysight.com.

Or via the FieldFox front panel, choose:

- Press **Meas Setup 4** > **IQ Analysis** > **None**

Or simply choose:

- Press **Measure 1** > **All Meas Off**

Effective Isotropic Radiated Power (EIRP) – (Requires CPU2, SA Mode Only)

How to Select Effective Isotropic Radiated Power (EIRP)

- Press **Measure 1**
- Then **Channel Measurements** > **More** > **EIRP** to open a menu of softkeys to set up EIRP.

How to Setup EIRP (Effective Isotropic Radiated Power)

General setup and an example for EIRP:

For this example we are using an isotropic antenna with the following specifications:

- Frequency range: 9 kHz to 9 GHz isotropic antenna
- Preamp stages: 2 (+15 dB each (@2 GHz))
- Chop/Switch speed rate: 1 Hz to 50 kHz
- Assume: 600 Series 50 Ω coaxial cable with 2.5 dB/100 feet

1. Press **Measure 1** > **Channel Measurements** > **Channel Power** > **More** > **EIRP** then choose from the following:

- **EIRP Meas** – Enables and disables the EIRP measurement.
- **Rx Ant Gain** – Enter the receiver ant gain (–100 db to 100 db; default = 0 dB).

For this example: **30 dB** > **Enter**.

- **Dist to Ant** – Enter the distance between the receiving and transmitting antennas (0 m to 25 km; default = 100m).

For this example: **100m** (default).

- **Rx Cable Loss** – Enter the receiver cable loss (0 to –100 dB; default = 0 dB).

For this example: **2.5 dB**.

- **Margin Comp** – Enter the margin compensation to remove known self-interference, antenna efficiency, fading and other errors (–100 db to 100 db; default = 0 dB).

- Then **More** and choose from the following:

- **Restart** – Press this softkey to restart an antenna measurement.
- **Save Horizontal** – Saves the current horizontal EIRP value (dBm).

- **Save Vertical** – Saves the current vertical EIRP value (dBm).
 - **Clear H & V** – Clears the saved horizontal and vertical EIRP values (dBm).
2. Configure Center frequency, Span, Preamp, and RF Attenuation
 - Press **Freq/Dist** > **Center** > 2 GHz
 - Press **Freq Span** > 3 MHz (default)
 - Press **Scale Amptd** > **Preamp** > **ON** (default = OFF)
 - Press **RF Atten Auto** (default = Auto)
 3. Configure Center frequency, Span, Preamp, and RF Attenuation
 - Press **Freq/Dist** > **Center** > 2 GHz
 - Press **Freq Span** > 3 MHz (default)
 - Press **Scale Amptd** > **Preamp** > **ON** (default = OFF)
 - Press **RF Atten Auto** (default = Auto)
 4. Summary of EIRP setup, per step 1.
 - Press **Rx Ant Gain** For this example: 30 dB > **Enter**).
 - Press **Dist to Ant** For this example: 100m (default)
 - Press **Rx Cable Loss** For this example: 2.5 dB
 - Press **Margin Comp**
 5. Start EIRP: Press **Restart**
 6. When done press:
Save Horizontal and
Save Vertical
 7. Optional: To clear the saved horizontal and vertical EIRP values press:
Clear H & V

SA (Spectrum Analyzer) Mode (Option 233–Mixed Analyzers)
Effective Isotropic Radiated Power (EIRP) – (Requires CPU2, SA Mode Only)

10 RTSA (Real-Time Spectrum Analyzer) Mode—Option 350 (CPU2 Only)

RTSA Mode measures signals at the **SA RF IN** connector.

For a comprehensive RTSA mode tutorial, see Understanding and Applying Probability of Intercept in Real-Time Spectrum Analysis (App Note) at <https://www.keysight.com/us/en/assets/7018-04381/application-notes/5991-4317.pdf>.

Figure 10-1 RTSA Display using Markers

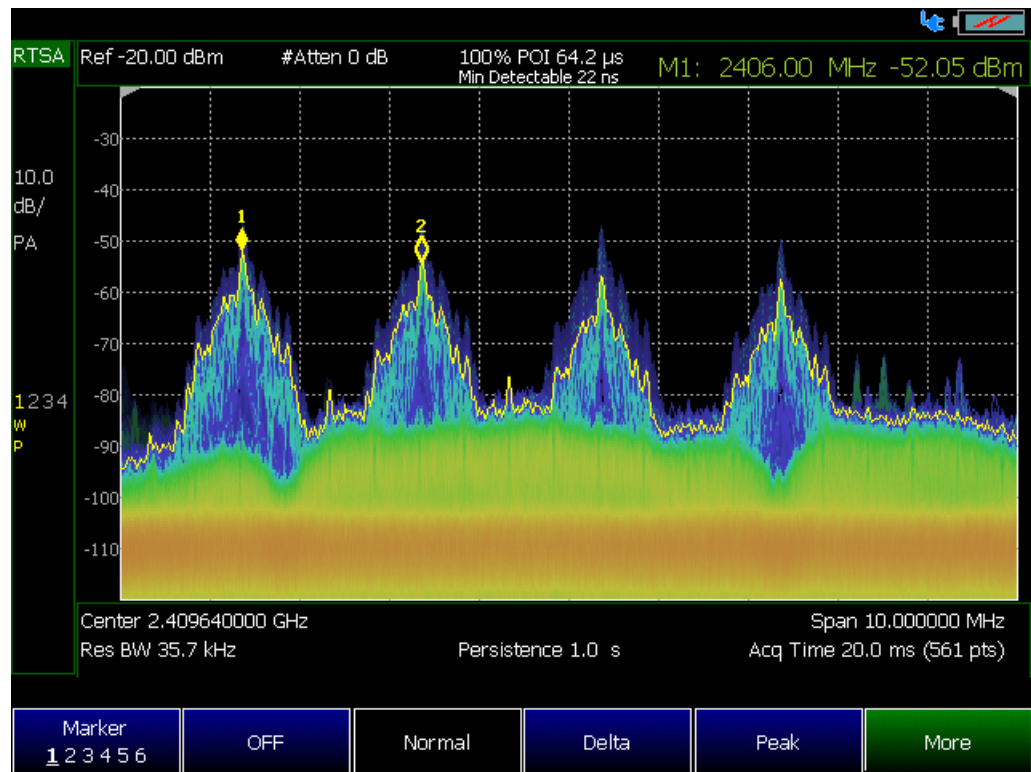

The graphic above shows an RTSA display of a *Bluetooth* signal using markers.

In this Chapter:

[“Frequency Range” on page 263](#)

[“Scale and Units” on page 264](#)

[“External Gain” on page 265](#)

[“Attenuation Control” on page 266](#)

[“Preamplifier Control \(Opt 235\)” on page 267](#)

[“Check for Compressed Measurements” on page 267](#)

[“Resolution Bandwidth \(Res BW\)” on page 271](#)

[“Triggering” on page 272](#)

[“Single / Continuous / Restart / Time Per Div” on page 275](#)

[“Points \(not user settable\)” on page 276](#)

[“Trace Display States \(RTSA\)” on page 277](#)

[“Average Count, Show Density, Blue, and Red Percentage Limits” on page 279](#)

[“Average Count” on page 280](#)

[“Alignments” on page 280](#)

[“Detection Method” on page 278](#)

[“Display Line” on page 280](#)

[“Spectrogram Display \(RTSA Option\)” on page 282](#)

[“Record/Playback \(RTSA Option\)” on page 284](#)

See Also

Optional Settings:

[“All about Markers” on page 692](#)

[“All about Limit Lines” on page 707](#)

[“Saving and Recalling Files” on page 768](#)

RTSA Mode Settings

Select RTSA Mode before making any setting in this chapter.

Because there is no calibration, these settings can be made in any order.

How to select RTSA Mode

- Press **Mode**
- Then **Real-Time SA**.

NOTE

When you initially select I/Q Analyzer, Real-Time SA, or some of the other spectrum settings (such as center frequency) a factory channel Equalization measurement is applied to the signal. During channel equalization measurement, the FieldFox displays a “Start Channel Equalization”. Stopping channel equalization is not permitted. See also, “Alignments” on page 211, in Chapter 9, “SA (Spectrum Analyzer) Mode (Option 233–Mixed Analyzers).”

Frequency Range

The X-axis frequency range determines the frequencies that are measured for each sweep. The default Start frequency is 995 MHz. However, the Start frequency can be set as low as –100 MHz. The internal LO of the FieldFox can be seen at 0 Hz, which will mask signals that may be present.

NOTE

Although the start frequency can be set as low as –100 MHz, amplitude accuracy is specified above 9 kHz to 100 kHz (depending on your model). Below 9 kHz to 100 kHz (depending on model), frequency accuracy is maintained, but amplitude accuracy is degraded. Refer to <https://www.keysight.com/us/en/assets/7018-03314/data-sheets/5990-9783.pdf>.

The FieldFox can be used with an OML frequency extender. Refer to “Utilities” on page 724, the *A Series FieldFox Configuration Guide 5990-9836EN*, and to “Contacting Keysight” on page 5.

The frequency range of the measurement can be changed using the following methods:

- Set Center and Span frequencies (Freq Span is settable from 280 Hz to 10 MHz)
- Set Start and Stop frequencies
- Toggle between Zero and Last selected span
- Using Marker -> Center

How to set Frequency Range

- Press **Freq/Dist**.
- Then choose from the following:
 - **Center** and **Freq Span** frequencies. This is the most common method of entering frequency range. Enter the frequency of interest. The Center frequency is at the exact center of the X-axis. The Frequency Span places half of the frequency range on either side of center. When the Center and Frequency Span values are entered, then the X-axis annotation on the screen shows the Center and Span frequencies.
 - **Start** and **Stop** frequencies. Start is the beginning of the X-axis and Stop is the end of the X-axis. When the Start and Stop frequencies are entered, then the X-axis annotation on the screen shows the Start and Stop frequencies.
 - Optionally, press **More** then:
 - **CF Step** then type a step size value using the numeric keypad, then select a multiplier key.
 - **Freq Annotation** and one of the following:
 - AutoSelect** (Default) – The FieldFox selects a frequency annotation setting (CenterSpan or StartStop).
 - CenterSpan** – The center frequency and span are displayed.
 - StartStop** – The start and stop frequencies of the frequency span are displayed.
 - **Full Span** the frequency span changes to 10 MHz.
- Follow each of these, when prompted, by entering a value using the numeric keypad, the **▲▼** arrows, or the rotary knob.
- When using the **▲▼** arrows, press **Enter**. The increment setting of the arrows is based on the current span. This can be changed in RTSA Mode.
- After using the keypad, select a multiplier key. Learn more in **“Multiplier Abbreviations” on page 53**.

Scale and Units

Adjust the Y-axis scale to see the relevant portions of the data trace.

The Y-axis is divided into 10 graticules. A acquisition is shown on the screen as a solid horizontal bar that can be placed at any graticule.

RTSA always uses logarithmic scale. The Y-axis reference line represents the specified absolute acquisition (dBm). Y-axis graticules show dB below or above the reference line.

When RF Attenuation set to **Auto**, the RF Attenuation is coupled to acquisition.

How to set Scale

Press **Scale / Amptd**. Then choose from the following:

Manually set Scale, acquisition, and Reference Position.

- **Scale** Manually adjust the dB scale per division to view specific areas of the current trace. Enter a value using the numeric keypad, the **▲▼** arrows, or the rotary knob. Then press **Enter**.
- **Ref Level** Manually set the value of the reference line. Enter a negative value by pressing **Run/Hold (+/-)** either before or after typing a value. This can also change the RF Attenuation setting. See **“Attenuation Control” on page 266**.
- **Ref Pos** Manually set the position of the reference line. Values must be between 0 (top line) and 10 (bottom line). Default position is zero (top).

External Gain

When using an external amplifier or attenuator, the RTSA mode trace amplitude values can be offset to compensate for the effect of the external device. This effectively moves the reference plane of the RTSA measurement port out to just beyond the external device. For example, when using an external preamp with gain of +10 dB, enter this value for External Gain, and the data trace across the displayed frequency span will be adjusted down by 10 dB.

When RF Atten is set to Auto, you may see a change in the RF Attenuation value. This is an attempt to measure the signal at top of screen (the acquisition) without overloading the RTSA first mixer.

How to Set External Gain

- Press **Scale/Amptd**.
- Then **External Gain**
- Enter a value using the numeric keypad, the **▲▼** arrows, or the rotary knob (positive for gain; negative for loss). Values in increments less than 5 dB must be typed using the numeric keypad. Then press **Enter**

ExtGain xx dB is shown at the top of the screen.

Attenuation Control

Both the RF Attenuation and Preamp functions control the power level into the RTSA.

When too much power is present at the RF Input port, **ADC Over Range** appears on the FieldFox screen. This does not necessarily mean that damage has occurred, but that the measurement is probably compressed.

When high power levels are present at the RF Input port, internal attenuation can be switched in to keep the FieldFox receiver from compressing. At extremely high power levels, use external attenuation to protect the internal circuitry from being damaged.

CAUTION

The FieldFox can be damaged with too much power. Refer to the FieldFox Data Sheet for your model on

<https://www.keysight.com/us/en/assets/7018-03314/data-sheets/5990-9783.pdf>.

Maximum Input Voltages and Power:

RF Output Connector: 50V DC, +23 dBm RF

Ext Trig/Ref Connector: 5.5 V DC

RF Input:

+27 dBm RF, ±50 VDC Max. (N991xA/B, N9925B, N9926A, N9928A, N993xA/B)

+23 dBm RF, ±50 VDC Max. (N9923A, N9923AN)

+25 dBm RF, ±40 VDC Max. (N995xA/B, N996xA/B)

DC Input: 19VDC, 4ADC, 60 Watts maximum when charging battery

The displayed power level is automatically adjusted for RF Attenuation. As the attenuation value changes, the displayed power level should NOT change.

How to set Attenuation

- Press **Scale/Amptd**.
- Then **RF Atten Man Auto**
- **Auto** RF Attenuation is set by adjusting the acquisition. As the acquisition is lowered, for example from –10 dBm to –30 dBm, the FieldFox assumes that you are looking at low-level signals. The RF Attenuation value is automatically lowered in 5 dB steps to allow low-level signals to be viewed.
- **Man** RF Attenuation is set manually. Enter a value between 0 to 30 dB in 5 dB steps using the numeric keypad, the **▲▼** arrows, or the rotary knob. Then press **Enter**.

#Atten xx dB is shown at the top of the screen. (#) means manual setting.

Preamplifier Control (Opt 235)

When **very low-level** signals are analyzed, an internal preamplifier can be used to boost the signal level by approximately 15 to 20 dB (depending on model). The gain of the preamp is NOT adjustable. The displayed signal level is automatically adjusted for the increase in system gain, therefore turning the Preamp ON should NOT cause a change to the displayed signal.

How to control the Preamp

By default, the preamp is OFF.

- Press **Scale/Amptd**.
- **Preamp ON OFF** When ON, **PA** is shown to the left of the graticules on the display.
- **Auto** When Auto is selected, the preamp setting is coupled to the RF attenuation and to the acquisition. When the acquisition reaches a certain value, the preamp is turned on and **PA** is shown to the left of the graticules on the display.

Check for Compressed Measurements

Compression occurs when too much power into an amplifier causes it to no longer amplify in a linear manner. When too much power goes into the FieldFox RF Input connector, the amplifiers in the RTSA receiver compress and signal power will not be displayed accurately. This can occur even if **ADC Over Range** is not displayed because devices other than the ADC, such as the mixer, might be compressed. Increase the RF Attenuation value to prevent the RTSA receiver from being compressed.

How to Check for a Compressed Measurement

- Using a marker at the signal peak, make note of the signal power level.
- Increase the RF Attenuation level by 5 dB.
 - If the signal level does NOT change, then NO compression exists. This indicates that the signal is in the linear region of the FieldFox receiver.
 - If the signal level DOES increase, then the receiver was compressed. Set the RF Attenuation value at the setting when further increases no longer result in an increase in the displayed power level.

Spectrum Selection

CAUTION

Density Spectrum and Spectrogram data is lost when you change modes, because the FieldFox optimizes the instrument's resources during mode changes.

To select the spectrum-type for your measurement:

How to make Spectrum Settings

- Press **Measure 1**
- Then Press:
 - **Density Spectrum** The signal displayed is a real-time spectrum with a histogram bitmap. Refer to **Figure 10-2 on page 269** and **Figure 10-3 on page 270**.
 - **Spectrogram** The signal is displayed is a real-time spectrum with a spectrogram bitmap. Spectrogram views are valuable in capturing signals that include both time and frequency variations. Refer to **Figure 10-4 on page 270**.
 - **Real-time Spectrum** The signal is displayed as a real-time spectrum. Use real-time spectrogram to quickly display measurements. Refer to **Figure 10-5 on page 271**.

In all three spectrum measurements, there are four available traces for representation of the real-time spectrum.

Figure 10-2

Density Spectrum (Histogram) FM Signal with 1 MHz FM Deviation & 400 Hz FM Rate

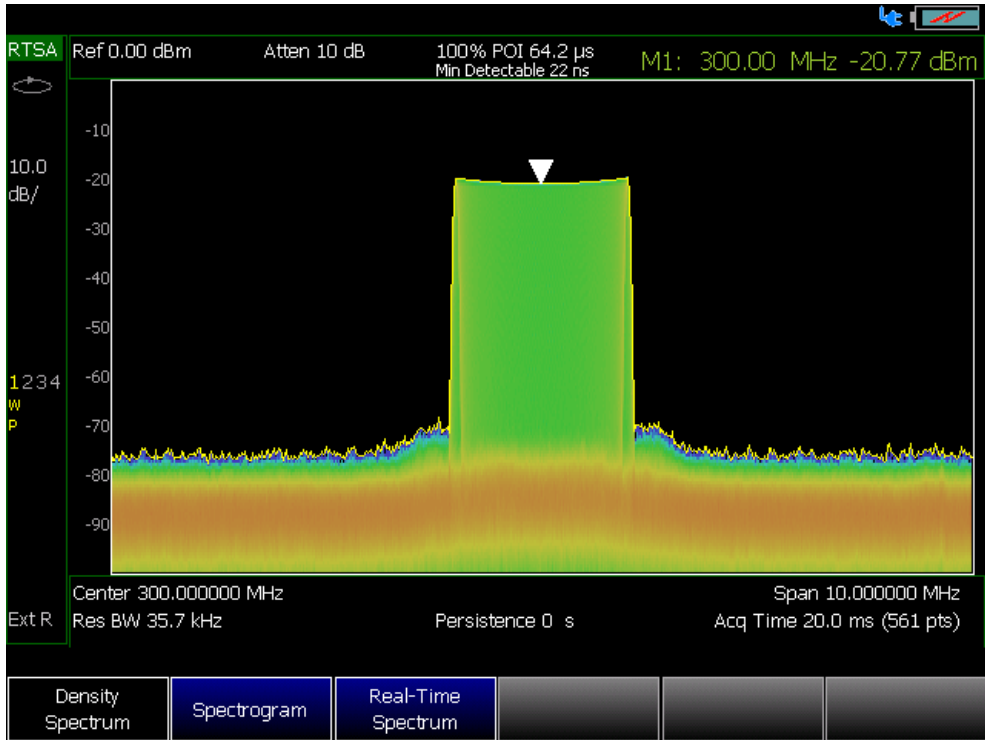

Figure 10-3

Density Spectrum (Histogram) with 2 Pulses (Blue color indicates pulse that occurs less frequently)

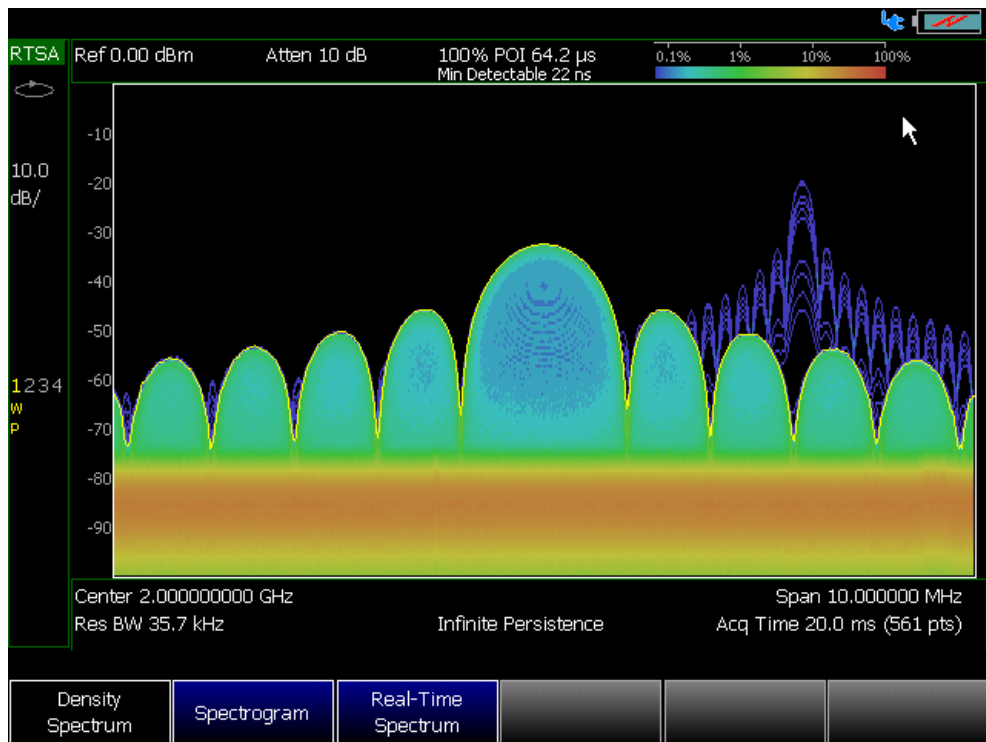
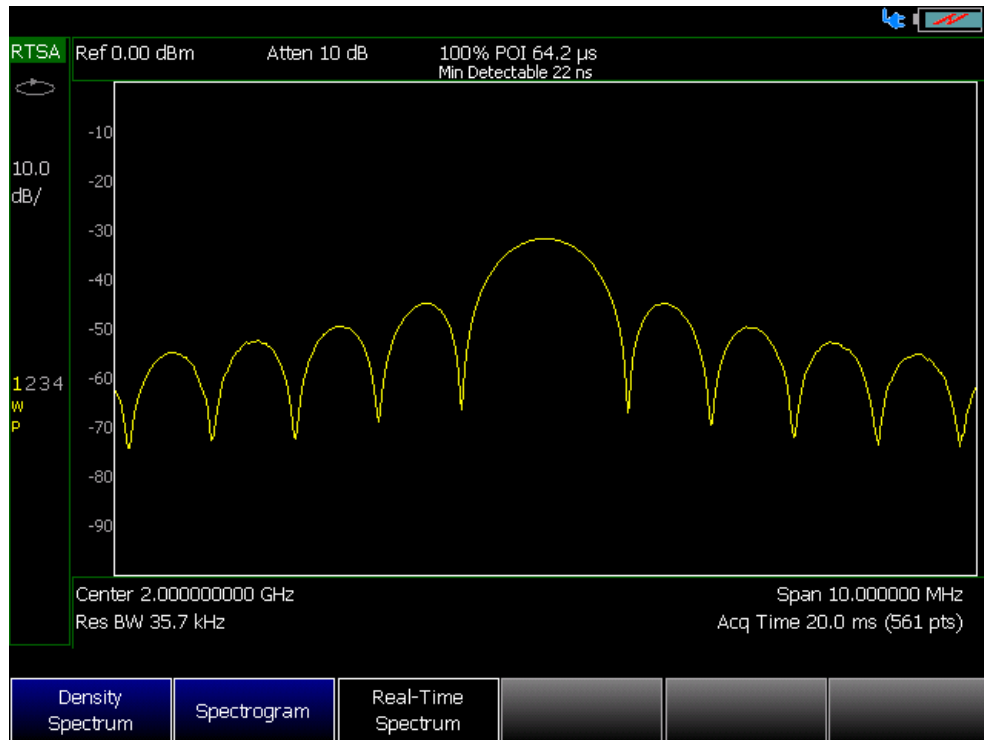

Figure 10-4

Spectrogram



Figure 10-5 Real-Time Spectrum



Resolution Bandwidth (Res BW)

CAUTION

For best results, use the AUTO setting for the Res BW values. Increasing the resolution BW could reduce pulse measurement capability by affecting the 100% POI duration and the minimum detectable signal level. The resolution BW must be as narrow as possible to maintain gapless measurements.

When Manual RBW is selected, the FieldFox attempts to set the RBW to the setting you request, but this setting is coupled to the current span settings. If the manually set RBW is not settable with the current frequency span value, the FieldFox defaults to the nearest achievable RBW setting to meet the manual RBW value.

In RTSA Mode, the Res BW provides the ability to resolve, or see closely spaced signals. The narrower (lower) the Res BW, the better the spectrum analyzer can resolve signals. In addition, as the Res BW is narrowed, less noise is measured by the spectrum analyzer ADC and the noise floor on the display lowers as a result. This allows low level signals to be seen and measured.

How to set Res BW

- Press **BW 2**.

- Then **Res BW**.
- Then choose from the following:
 - **Auto** Res BW is coupled to the frequency span. As the frequency span is narrowed, the Res BW is also narrowed providing increased ability to resolve signals.
To change this setting from **Man** to **Auto**, press **Res BW** twice.
 - **Man** Enter a Res BW value using the numeric keypad, the **▲▼** arrows, or the rotary knob. Then press a multiplier if necessary or press **Enter**.

The current Res BW setting is shown at the bottom of the screen.

#Res BW x.xx XHz (#) means manual setting.

This setting could impact the accuracy of the measurement. See Specifications in Appendix B.

Triggering

NOTE

Triggering only applies to Density Spectrum and Real-Time Spectrum.

External, Video, and RF Burst triggering enable you to initiate an RTSA mode sweep using an external event such as a signal burst.

Trigger Type

- Press **Sweep 3**
- Then **Trigger Settings**
- Then **Trig Type**
- Then choose from the following:
 - **Free Run** Triggering is provided by the FieldFox internal circuitry. A new sweep begins when the previous sweep ends.
 - **External** A sweep is triggered on an external TTL signal at the Ref In/Trig In connector on the FieldFox top panel. Choose to trigger on the rising slope at about 1.7 V or on the falling slope at about 1.0 V using the Trigger Slope setting (below).
 - **Periodic** sets a trigger that repeats at the period rate entered. Periodic trigger's phase can be altered by the Offset value.

The following two selections are similar in that they both trigger a sweep from a signal at the **SA RF Input** connector. Experiment with both selections to find the best trigger type for your application.

- **Video** A sweep is initiated when the amplitude of an incoming signal crosses the settable trigger level. The comparison is done in the time domain, before conversion to frequency domain. Refer to “**Trigger Slope**”, “**Trigger Delay**”, “**Trigger Level**” on page 274, “**Auto Trigger Time**” on page 274, and to “**Trigger Hold-Off**” on page 275.

NOTE

If your trigger level is set too high for the current measurement gain setup, you will see an error message, similar to this one, displayed: “Video TrigLevel was HW Limited, it is x.xx dB above current capability”. Adjust your trigger level settings until the message is no longer displayed.

- **RF Burst** A sweep is initiated when the signal at the third IF (analog) stage crosses the settable Trigger Level. This selection reacts to a wider bandwidth of the incoming signal than Video Trigger, which could be beneficial. However, RF Burst is not as sensitive to triggering on low-level signals. Refer to “**Trigger Slope**”, “**Trigger Delay**”, “**Trigger Level**” on page 274, “**Auto Trigger Time**” on page 274, and to “**Trigger Hold-Off**” on page 275.
- **Periodic** Trigger repeats at the period rate entered. Periodic trigger’s phase can be altered by the Offset value.

Then choose from the following:

- **Period** Enter a value for the trigger to repeat (100 ns to 400 ms).
- **Offset** Enter a offset value to offset the phase of the periodic trigger (-100 ms to 100 ms).
- **Reset Offset Display** Resets Offset to default 0.000000 s.

Trigger Slope

Trigger Slope determines which edge of an External, Video, or RF Burst trigger signal initiates a sweep.

- Press **Sweep 3**
- Then **Trigger Settings**
- Then **Trig Slope**
- Then choose from the following:
 - **Pos** Sweep is triggered by the rising (positive) edge of signal.
 - **Neg** Sweep is triggered by the falling (negative) edge of signal.

Trigger Delay

After a valid trigger signal is received, the sweep begins after the specified Trigger Delay time.

- Press **Sweep 3**

- Then **Trigger Settings**
- Then **Trig Delay**
- Enter a value using the numeric keypad, the **▲▼** arrows, or the rotary knob. (0 to 10 seconds)
- Then select a multiplier key or press **Enter**. Learn more in **“Multiplier Abbreviations” on page 53**.

Trigger Level

Used with Video and RF Burst triggering, a sweep is initiated when an incoming signal crosses this level. See also **“Scale and Units” on page 264**.

RF Burst Trigger Level uses an alignment process which is performed in the background to set the detected signal level accuracy. **Video Trigger Level** is a comparison done on the time domain signal, before conversion to the spectral frequency domain. Processing from the time to frequency domain can cause broadband (e.g., pulsed) signal energy to display at lower power levels than the peak power levels of the time domain signal. Therefore you may need to set the trigger level higher than the displayed spectral level.

- Press **Sweep 3**
- Then **Trigger Settings**
- Then **Trig Level**
- Enter a value using the numeric keypad, the **▲▼** arrows, or the rotary knob. (–210 to 30 dBm)
- Then select a multiplier key or press **Enter**. Learn more in **“Multiplier Abbreviations” on page 53**.

Auto Trigger Time

While waiting for a valid trigger signal, **Wait** is annotated in the top left corner of the FieldFox screen.

If a valid trigger signal is not received before the specified Auto Trig Time, a sweep will occur automatically.

When Auto Trigger is OFF, the FieldFox does NOT sweep unless a valid trigger signal is received.

- Press **Sweep 3**
- Then **Trigger Settings**
- Then **Auto Trigger**
- Enter an Auto Trig Time using the numeric keypad. (1 ms to 100 seconds)
- Then select a multiplier key. See **“Multiplier Abbreviations” on page 53**.

- Enter **0** to set Auto Trigger **OFF** or press the Auto Trigger softkey a second time to turn OFF Auto Trigger.

Trigger Hold-Off

Used with External, Video, and RF Burst triggering, sets the hold-off time between triggers. (Range: 0.000000 to 10.000000 seconds)

Once a trigger occurs, future triggers are ignored until the trigger hold-off time expires. Setting the trigger hold-off to zero, essentially turns off the trigger hold-off feature. Also, you can press **Trig Hold-Off > OFF**.

Trigger Settings Annotation

Trigger settings are annotated on the FieldFox screen as shown in the following figure:

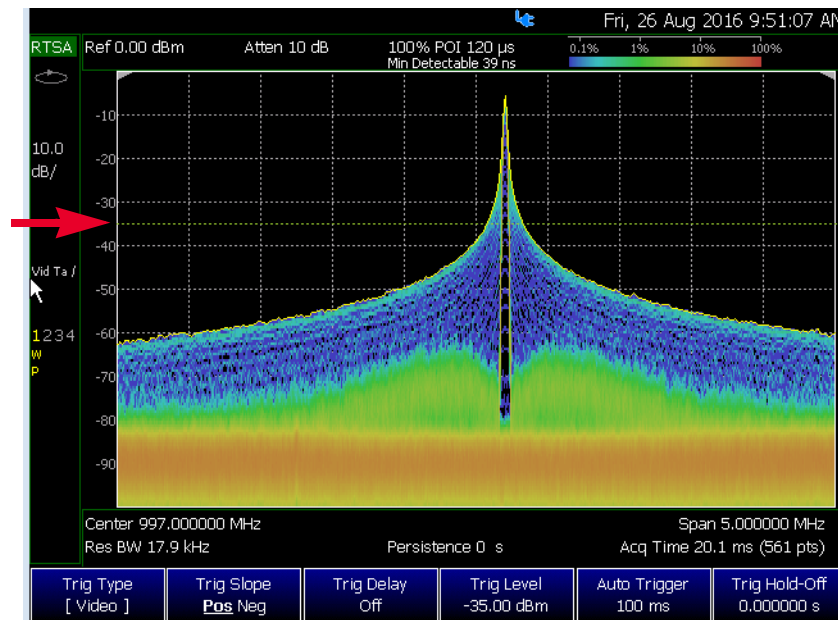

- Trig Type (**VidT**), AutoTrigger (**a**), Pos Slope (**/**)
- Horizontal arrow: Trig Level (green horizontal graticule at -35 dBm)

Single / Continuous / Restart / Time Per Div

This setting determines whether the FieldFox measures continuously or only once each time the **Single** or **Run / Hold +/-** button is pressed. Use **Hold / Single** to conserve battery power or to allow you to save or analyze a specific trace.

NOTE

To conserve battery power, in addition to using Hold / Single, you must also, set the System > preferences > Preferences > Battery Saver to On. For more, refer to the System Settings chapter and **“Preferences” on page 733**.

How to set Single or Continuous

- Press **Sweep 3**.
- Then choose one of the following:
 - **Continuous**
 - **ON** Causes the RTSA to make continuous sweeps. This is the typical setting for making measurements. Each **Run / Hold +/-** press causes the RTSA to toggle between continuous sweep and Hold.
 - **OFF** Causes the RTSA to Hold. Each **Run / Hold +/-** or **Single** press causes the RTSA to make ONE sweep, then Hold. The Hold annotation changes to an arrow --> while the sweep occurs.
 - **Single** Automatically sets Continuous OFF and causes the RTSA to make ONE sweep, then Hold.
 - **Restart** Resets the average counter to 1. If Continuous sweep is OFF, it also causes Average Count (n) sweeps to occur if any Trace State is set to RMS Average, MinHold, or MaxHold. This softkey is also used to clear the Spectrogram display. Learn more in **“Average Count” on page 280**.

Acq Time

Use the **Acq Time** setting to adjust acquisition time interval for each trace update in Density or Real-Time Spectrum measurements.

How to set Acq Time

- Press **Sweep 3**.
- Then choose:
 - **Acq Time** Acq Time affects the quantity of information being captured during a density or real-time spectrum measurement.
 - **Auto** (default) the FieldFox chooses the optimum Acq Time based on the span setting (default is 20 ms).
 - **Manual** enables user settable acquisition time values.

Points (not user settable)

Points is the number of measurements that are displayed along the X-axis. RTSA automatically sets the points to 561 and is not user settable.

Trace Display States (RTSA)

NOTE

You can use the FieldFox's Remote Server mode (89600 VSA software connectivity) to parse playback files and captured data as MATLAB files (*.mat). Learn more about FieldFox and 89600 VSA software, refer to [Chapter 17, "Remote Server Mode \(Requires CPU2 and SA Hardware/SA Option 233\)"](#) and to <http://rfmw.em.keysight.com/wireless/helpfiles/89600B/WebHelp/89600.htm>.

In RTSA Mode you can display up to four of the following types of trace states. All RTSA settings are applied to all displayed traces. These traces represent the Real-Time Spectrum in each of the three measurement modes.

A color-coded legend for displayed traces is visible in the left pane of the RTSA mode screen:

W = Clear/Write; **M** = MaxHold; **m** = MinHold; **A** = Average; **V** = View

How to display the Trace States

- Press **Trace 6**.
- Then **Trace 1,2,3,4** repeatedly to select a trace number to display or change its state. Traces are displayed in the following default colors (i.e., the colors are user settable):
 - Trace 1 – **Yellow** Trace 2 – **Blue**
 - Trace 3 – **Orange** Trace 4 – **Green**
- Then **State [current setting]**
- Then choose from the following Trace States:
 - **Clr /Wr [W]** (Clear/Write) Displays the actual measured data for each sweep.
 - **MaxHold [M]** Displays the maximum response of the input signal at each data point over multiple sweeps. See also Average Count in ["Average Count" on page 280](#).
 - **MinHold [m]** Displays the minimum response of the input signal at each data point over multiple sweeps. See also Average Count in ["Average Count" on page 280](#).
 - **RMS Average [A]** Each data point is averaged over multiple sweeps as set by the Average Count setting. Learn more in ["Average Count" on page 280](#).
 - **View [V]** Displays and then holds the last complete measurement trace on the screen. This is similar to storing a trace in memory.
 - **Blank** Displays no trace.

- Press **Default All** to return all traces to their default settings: Trace 1 (Clear/Write); all other traces, including trace detectors (Blank).

Detection Method

In RTSA Mode, the X-axis is comprised of data points, also known as “buckets”. Learn more in **“Points (not user settable)” on page 276**.

Regardless of how many data points are across the X-axis, each data point must represent what has occurred over some frequency range and time interval.

From the frequency span of the measurement, the span of each data point is calculated as (frequency span / (data points-1)). The detection method allows you to choose how the measurements in each bucket are displayed.

Using the RTSA feature, each of the four available traces can have an independent detection method.

How to set Detection Method

The current Detection method for each trace is labeled on the left edge of the screen. A corresponding letter appears below the corresponding Trace number selected. For example: **N** means that **Normal** was the selected detector.

- Press **Trace 6**
- Then **Detector**
- Then choose from the following:
 - **Auto** [...] Displays the most appropriate Detection method based on other settings.
 - **Normal** [**N**] Provides a better visual display of random noise than **Positive peak** and avoids the missed-signal problem of the **Sample** Mode. Should the signal both rise and fall within the bucket interval, then the algorithm classifies the signal as noise. An odd-numbered data point displays the maximum value encountered during its bucket. An even-numbered data point displays the minimum value encountered during its bucket. If the signal is NOT classified as noise (does NOT rise and fall) then Normal behaves equivalently as Positive Peak.
 - **Positive Peak** [**P**] Displays the maximum value of all the measurements in each bucket. This setting ensures that no signal is missed. However, it is not a good representation of the random noise in each bucket.
 - **Negative Peak** [**p**] Displays the minimum value of all the measurements in each bucket.

- **Sample [S]** Displays the center measurement of all the measurements in each bucket. This setting gives a good representation of the random noise in each bucket. However, it does not ensure that all signals are represented.
- **RMS Average [A]** Displays the Root Mean Squared (RMS) average power of all the measurements in each bucket. This is the preferred method when making power measurements.

Repeat the detection setup process as needed for up to 4 traces and 4 detection methods.

Average Count, Show Density, Blue, and Red Percentage Limits

How to set:

- Press **Meas Setup 4**

Then choose one of the following:

- **Average Count** – Changes the quantity of traces averaged for certain trace states (i.e., MaxHold, MinHold, or RMS Average). Refer to **“Average Count”**.
- **Show Density** – (Density Spectrum Only) Displays a histogram image of the traces.
- **Blue Limit %** – (Density Spectrum Only) Changes the percentage of the trace that has a blue limit (0.05% to 100%, default is 0.05%). This setting is coupled to the color bar in the upper right corner of the FieldFox display.
- **Red Limit %** – (Density Spectrum Only) Changes the percentage of the trace that has a blue limit (0.05% to 100%, default is 100%). This setting is coupled to the color bar in the upper right corner of the FieldFox display.
- **Blue Limit dBm** – (Spectrogram Only) Changes the power level (dBm) of the trace that has a blue limit (–210 dBm to 30, default is –90 dBm). This setting is coupled to the color bar in the upper right corner of the FieldFox display.
- **Red Limit dBm%** – (Spectrogram Only) Changes the power level (dBm) of the trace that has a blue limit (–210 dBm to 30, default is –50 dBm). This setting is coupled to the color bar in the upper right corner of the FieldFox display.

NOTE

Blue limit and red limit percentages are coupled to the density percentage limit bar in the upper right of the FieldFox display. Or, for the blue limit and red limit power levels (dBm) are coupled to the Spectrogram power level (dBm) limit bar in the upper right of the FieldFox display.

Average Count

The Average Count setting is used mainly with the RMS Average Trace State described above **“Trace Display States (RTSA)” on page 277**. (But, also applies to the MaxHold or MinHold trace states.) In the RMS Average Trace State, the Average Count setting determines the number of sweeps to average. The higher the average count, the greater the amount of noise reduction.

For all three of these Trace States (RMS Average, MaxHold, or MinHold), when **Sweep 3 Continuous** is set to OFF, press **Restart** to reset the sweep count to 1, perform $\langle n \rangle$ sweeps, then return to **Hold**.

How to set Average Count

- Press **Meas Setup 4**
- Then **Average Count**
- Enter a value from 1 to 10,000 using the numeric keypad, the **▲▼** arrows, or the rotary knob.
- Press **Enter**

Alignments

The RTSA mode requires all three alignment types: amplitude, RF burst, and channel equalization. Refer the SA chapter’s **“Alignments” on page 211** for information on all Alignments.

Display Line

A display line is a simple, horizontal line that can be placed at any amplitude level on the RTSA screen. Use a display line as mental guide for visual feedback.

Figure 10-6 Display Line with Annotations

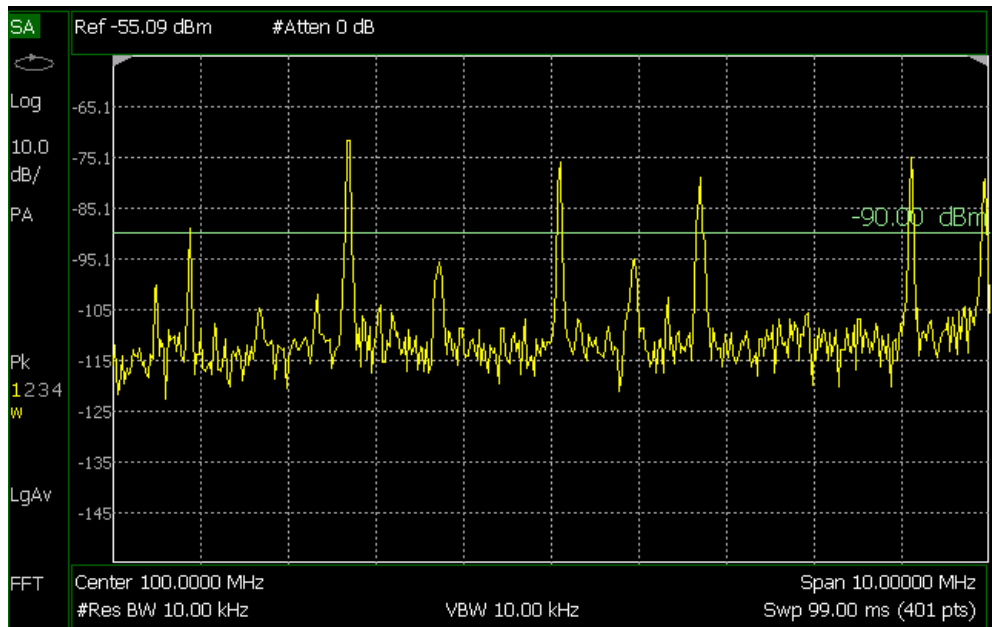

How to create and move a Display Line

- Press **Limit 8**
- Then **Display Line OFF ON**
- Then enter a Y-axis value using the **▲▼** arrows or the rotary knob, then press **Enter**. Or enter a value using the numeric keypad and press a suffix key or press **Enter**.

Learn more, [“All about Limit Lines” on page 707](#).

Spectrogram Display

Spectrogram display provides a visual history of the measured spectrum. This display type can be used to locate intermittent signals or to view signal levels and frequencies over time.

This display can NOT be used with Channel Measurements.

Spectrogram Display (RTSA Option)

Spectrogram draws the most recent trace record at the bottom of the stack of previously-drawn trace records. Drawing the live trace on the display is optional.

Figure 10-7

Spectrogram display- Overlay view

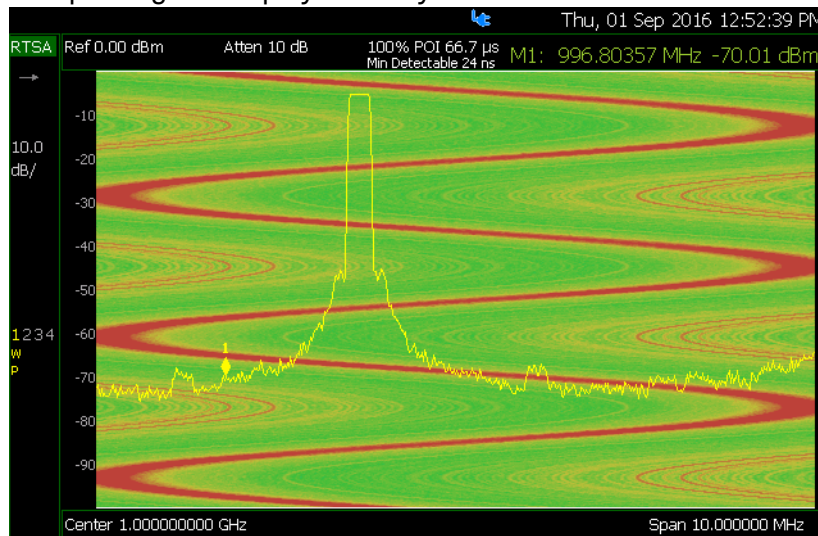

How to select Spectrogram

- Press **Meas 1**
- Then **Spectrogram**

How to modify the Spectrogram

You can change how the spectrogram is displayed relative to the data trace. This setting affects the total number of trace records that can be displayed.

For RTSA Mode:

- Press **Meas Setup 4**.
- Then **Spectrogram View**
- Then choose from the following:
 - **Overlay** Displays the data trace over the spectrogram with NO graticules. Total trace records: 340.

- **Top** Displays the data trace below the spectrogram. Total trace records: 130.
- **Bottom** Displays the data trace above the spectrogram. Total trace records: 130.

Common Settings for Spectrogram

Set Red and Blue Limits

The colors displayed on the Waterfall and Spectrogram represent the various measured power levels:

- Red = Highest power levels
- Blue = Lowest power levels

NOTE

The full Red-to-Blue color spectrum is visible only with Indoor display colors. Learn more in [“Display Colors” on page 721](#).

Adjust the Red and Blue limits to the power levels that you expect to measure. The Blue limit must always be less than the Red limit.

For RTSA Mode:

- Press **Meas Setup 4**.
- Then choose from the following:
 - **Red Limit** Using the **▲▼** arrows, rotary knob, or keypad, select the HIGHEST power level that you expect to measure. This power level, and those measured higher than this level, appear Red.
 - **Blue Limit** Using the **▲▼** arrows, rotary knob, or keypad, select the LOWEST power levels that you expect to measure. This power level, and those measured lower than this level, appear Blue.

How to Restart the Spectrogram

Press **Sweep 3** then **Restart**

Record/Playback (RTSA Option)

CAUTION

Density Spectrum information is not recorded. Only the trace data is saved. See [“How to Record a Session” on page 287](#).

NOTE

Record/Playback is only available in Density Spectrum and Real-Time Spectrum measurements. Record/Playback is not supported on Spectrogram. See [“How to Record a Session” on page 287](#).

Record Playback allows you to record RTSA trace sweeps and play them back at a later time. Use this feature to monitor spectrum activity over a period of time.

You can record traces continuously or record a specified number of traces (segments).

When GPS is enabled, the current location and elevation are saved and played back with traces.

Recordings can be saved to the FieldFox Internal memory, an SD Card, or a USB flash drive.

About Sessions

A Recording Session is a collection of recorded traces and the instrument states that generated them.

Before recording can occur, a new session must be initiated or an existing session must be opened. Sessions can later be opened for playing or continued recording. Only one session can be open at a time.

You close the session when finished recording or playing. A session is also closed when the FieldFox is Preset (or Mode Preset), an Instrument State is recalled, or when Mode is changed from RTSA.

Each session is saved as a folder containing a set of files on the specified storage device.

How long can a recording session last?

There are many variables that determine the possible length of a recording session. But one key variable is the amount of available memory.

When a session is opened or a new session is initiated, an estimate is made of the maximum number of traces that can be saved based on the available disk space and the current number of data points (resolution). Recording will stop when that number is reached. This estimate always keeps 4 MB of available disk space on the specified storage device. You can decrease the number of traces to further limit recording.

To maximize the amount of space that is available, save recorded traces to a USB Flash drive or SD card. Learn how in [“Manage Sessions” on page 291](#).

You can determine the length of time over which recording can occur by setting the Record Interval (the time between recorded traces) and other settings. Learn more in [“Recording Configuration” on page 289](#).

To view and edit the maximum number of records

Just after opening or initiating a session...

- Press **Session Data**
- Then **TraceRecordLimit <n>** (n = Max number of traces that can be recorded).
- **Clear All Records** Empties that session of recorded traces. Learn more in [“Manage Sessions” on page 291](#).

CAUTION

IMPORTANT! Pressing Clear All Records causes a loss of ALL of the session data.

FieldFox Setting Changes during Record and Playback

During Recording

When any of the following State settings are changed during recording, the State counter is incremented ([“About State and User Tags” on page 286](#)) and the settings are saved to the Session file along with the first trace to be recorded with the new setting. During playback, the trace and display annotation will reflect the change on the screen.

State settings:

Refer to [Table 10-1 on page 286](#) for a list of the applicable state settings for the RTSA options.

Table 10-1

Summary of RTSA State Settings

Option	Settings
RTSA	
	Acquisition Time
	Detector(s)
	External Gain
	Frequency Range
	Preamp On/Off
	Resolution BW
	RF Attenuation
	Trace State(s)
	Trigger Settings

Other display settings, such as Scale and acquisition, can also be changed during recording but are not saved with the session file. Think of these as settings that help YOU see the recording and playback activity. They do NOT change the data that is recorded.

During Playback

Changes to the states listed above are NOT allowed during playback.

However, all other display settings can be changed during playback to help you analyze the recorded data.

In RTSA mode, trace recordings are played back as is and the Trace State cannot be modified. No measurement post processing is allowed, and no Density or Spectrogram information can be recovered. This is because RTSA's Real-Time Spectrum and Density displays are not derived from the trace data, but instead require independent high speed hardware acquisition.

Record/Playback Exceptions

Markers can be activated and moved to help analyze recorded data. However, marker position control is only available when playback is Paused.

About State and User Tags

When any of the State settings (listed above) are changed during a recording, a 'state tag' is inserted at the first trace number to be recorded with the new setting.

In addition, you can insert a ‘User Tag’ at any time during a recording session to indicate an external event, such as when an antenna is moved. During playback, you can move quickly to any of these tags, or scroll through these tags.

A symbol is used on the screen annotation to distinguish a User Tag from a State Tag when scrolling through tags during playback.

Screen Annotation

During a record or playback session, the following is displayed in the top-left area of the screen:

– **AutoSession02: 92/95 (state 4/5) *_**
Sep.22.2018 09:15:15 AM

where:

- **AutoSession** is an auto-generated name for sessions. **02** is the auto-generated number, incremented with each new session. The name can be changed using Manage Sessions. Learn more in [“Manage Sessions” on page 291](#).
- **92/95** is the current and total trace number: currently trace is 92 of 95 total traces.
- **state 4/5** is the current and total state tag or user tag number: 4 of 5 total tags.
- ***** (Asterisk) indicates that a state has changed. **#** (Pound) indicates that a User Tag has been inserted.
- **Sep.22...** is the date and time of recording.

When GPS is enabled, the current location and elevation are annotated at the bottom of the playback display. Learn more in [“GNSS \(GPS+\) and GPS” on page 749](#).

NOTE

If Recording or Playback is not occurring when you think it should, check the following:

- Is the sweep in HOLD? (upper-left annotation), or check the Sweep menu for Continuous set to OFF.
- Is Recording or Playback Paused? (mid-left annotation)
- Is the Record or Playback Interval set too long? (Configuration settings.)

How to Record a Session

- Press **Trace 6**
- Then **Record Playback**
- Then either:

- **New Session** OR
 - **Recall Session** then **Open** and select a session.
 - Then **Recorder Player**
 - Then **Record**
- REC** is displayed in the left of screen graticules.
- During recording, choose from the following:
- **Pause Resume** Temporarily halts recording until pressed again. The incoming trace continues to sweep. Press again to continue recording.
 - **Stop** Immediately stops recording. Then choose from the following:
 - Press **Play** to start replaying the recording from the beginning.
 - Press **Record** to continue recording.
 - **User Tag** Press to insert a User Tag at the current recorded trace. This allows you to quickly move to this location during playback. Learn more in About State and User Tags in **“About State and User Tags” on page 286**.

How to Playback a Session

- Press **Trace 6**
- If the session is already open, skip the following step. Otherwise:
- Then **Record Playback Setup**
 - Press **Recall Session** Then select a session to playback and press **Open**.

NOTE

If these are large recordings on a device, it could take several seconds for the FieldFox to display the list.

-
- Then **Recorder Player**
 - Then **Play**

PLAY is displayed in the left of screen graticules during playback. When the end of the recording is reached, playback begins again at trace 1 and continues to loop indefinitely.

During playback, choose from the following:

- **Pause Resume** Temporarily halts playback. Then choose from the following:
 - **Pause Resume** Press to continue playing.

- **Playback State/Tag** Allows you to continue playback from a state tag, or scroll through the state tags. Enter a value between 1 and the total number of state tags using the numeric keypad, **▲▼** arrows, or the rotary knob. Active when playback is paused. Learn more in **About State and User Tags** in **“About State and User Tags” on page 286**.
- **Playback Trace** Activated automatically when Paused. Allows you to continue playback from a specific trace, or scroll through traces manually. Enter a value between 1 and the total number of traces using the numeric keypad, **▲▼** arrows, or the rotary knob.
- **Stop** Immediately stops playback. Then choose from the following:
 - **Play** Start playback from trace 1.
 - **Record** Resume recording from the last recorded trace.
 - **Record Playback Setup** Return to the setup menu to change Configuration settings or Close the session.

Recording Configuration

To change Recording Configuration settings:

- Press **Trace 6**
- Then **Record Playback**
- Then **New Session** or **Recall** an existing session.
- Then **Recording Configuration**

Then choose from the following:

- **Record Time** Sets the amount of time to record traces. Default is MAX, which is to record indefinitely. Enter a value between 1s and 1 Ms (million) seconds using the numeric keypad, **▲▼** arrows, or the rotary knob. When set, a timer appears during recording in the lower-left corner which counts DOWN from the specified time.
- **Record Source** Determines which trace is recorded. Sets where, in the FieldFox data flow, data is recorded. Learn more in **“Record Source” on page 290**. Choose from the following:
 - **First Active Trace** (Default) This setting automatically selects the first active trace (1,2, 3 or 4) (i.e., any state other than View or Blank).
 - **Trace 1,2,3,4** Records data from the corresponding trace in its current state.

- **Record Interval** Sets the amount of time to wait between individual trace recordings. Default is MIN, which is to wait 0 seconds (record traces as fast as possible). Enter a value in seconds between 0 (no delay) and 10,000 seconds - about 3 hrs) using the numeric keypad, ▲▼ arrows, or the rotary knob.
- **Segment Count** Sets the number of traces to record, after which the recording will automatically pause. Press Pause/Resume or Record to capture another N traces, or Stop to end recording. Default is OFF, which is NO limit to the number of traces to be recorded.

When set, a counter appears in the lower-left corner which counts UP to the specified number of recordings.

Record Source

NOTE

For this discussion, it is important to understand Trace States. Learn more in [“Trace Display States \(SA Mode\)” on page 208](#).

Figure 10-8

FieldFox RTSA Mode: Data Flow and Record Playback Data Points

RTSA Record/Playback Data Flow

Trace 1, 2, 3, 4

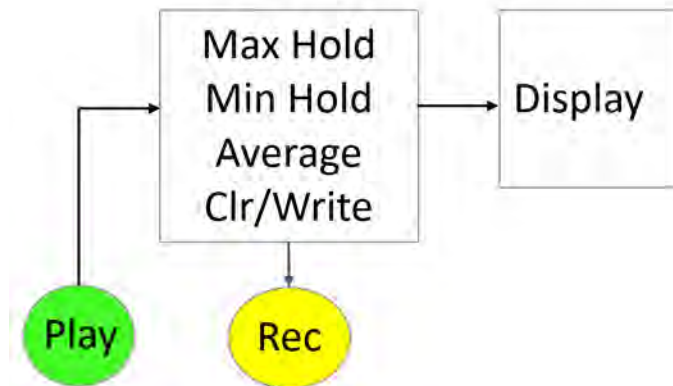

RTSA Data Recording:

CAUTION

Density Spectrum information is not recorded. Only the trace data is saved.

- Data is recorded at the trace state processing block.
- Data can be recorded from Traces 1,2,3, or 4 which includes the trace state (Max Hold, Min Hold, and so forth).

- Data is ALWAYS played back into the same trace number that was recorded. If four traces were active during the recording, but only one trace was recorded, then during Playback only that one recorded trace is visible.

Playback Configuration

By default, trace sweeps are played back as fast as the trace can be drawn on the screen. The following setting allows you to slow playback. In addition, you can manually scroll through individual traces using Playback Trace, or scroll through State and User Tags using Playback State/Tag. Learn more in **How to Playback a Session** in “**How to Playback a Session**” on page 288.

To slow playback of a session:

- Record a new session or Open an existing session.
- Press **Playback Configuration**
- Then **Playback Interval**
- Enter a value in seconds between 0 (no delay) and 100 using the numeric keypad, **▲▼** arrows, or the rotary knob. After using the keypad, select a multiplier key. Learn about multiplier abbreviations.
- Press **Enter**

Manage Sessions

- Press **Trace 6**
- Then **Record Playback**
- Then **Record Playback Setup** The following selections are available ONLY when a session is NOT open.
- Then **Storage Device** to select the media which stores the sessions to be managed. This is a different setting from the Save/Recall Storage Device setting.
- Then choose from the following:
 - **Internal** FieldFox memory (default)
 - **SD Card** An external SD Card (must be inserted)
 - **USB** An external USB flash drive (must be inserted)
- Then **Manage Sessions**

NOTE

If these are large recordings on a device, it could take several seconds for the FieldFox to display the list.

-
- Then choose from the following:

- **Rename** Using the FieldFox labeler, change the name of the session. AutoSession (n) is the default name where (n) is the next-available number. Learn more in [“How to use the FieldFox labeler ” on page 770.](#)
- **Sort** Arrange the listing of sessions **by Name**, **by Date**, or **by Size**. Sort can also be used during a Recall Session, before choosing a session to open.
- **Delete** After a confirmation prompt, removes the contents of the selected session from the list.
- **Copy** Copies the selected session to a different storage device, or the same storage device with ‘Copy(n)_’ appended to the beginning of the name so that duplication is prevented.
- **Copy All** Copies ALL of the listed sessions to a different storage device, or the same storage device with ‘Copy(n)_’ appended to the beginning of the names so that duplication is prevented.
- **Delete All** Deletes ALL of the listed sessions.

Record Playback Example (RTSA Mode Only)

The following “Interval Recording” example shows how you can record spectral activity over a longer period of time with less trace storage.

- Press **Trace 6**
- Then **Record Playback**
- Then **New Session**
- Then **Recording Configuration**
- Then **Record Source** to Trace1
- Then **Back**
- Then **Recorder Player**
- Then **Record** let the recorder run for several seconds.
- Then **Stop** to end the recording.

This session can be played back: For example:

- Press **Trace 6**
- Then **Record Playback**
- Then **Play**

11 IQ Analyzer (IQA) – Option 351 (CPU2 Only)

IQA mode measures signals at the **SA RF IN** connector.

IQA mode requires the FieldFox to have SA mode and CPU2 installed.

NOTE

The FieldFox can be used with an OML frequency extender. Refer to “Utilities” on page 724, the [A Series FieldFox Configuration Guide 5990-9836EN](#), and to “Contacting Keysight” on page 5.

Figure 11-1 IQ Analyzer (IQA) Display - LTE-TDD signal captured using the FieldFox's I/Q analyzer

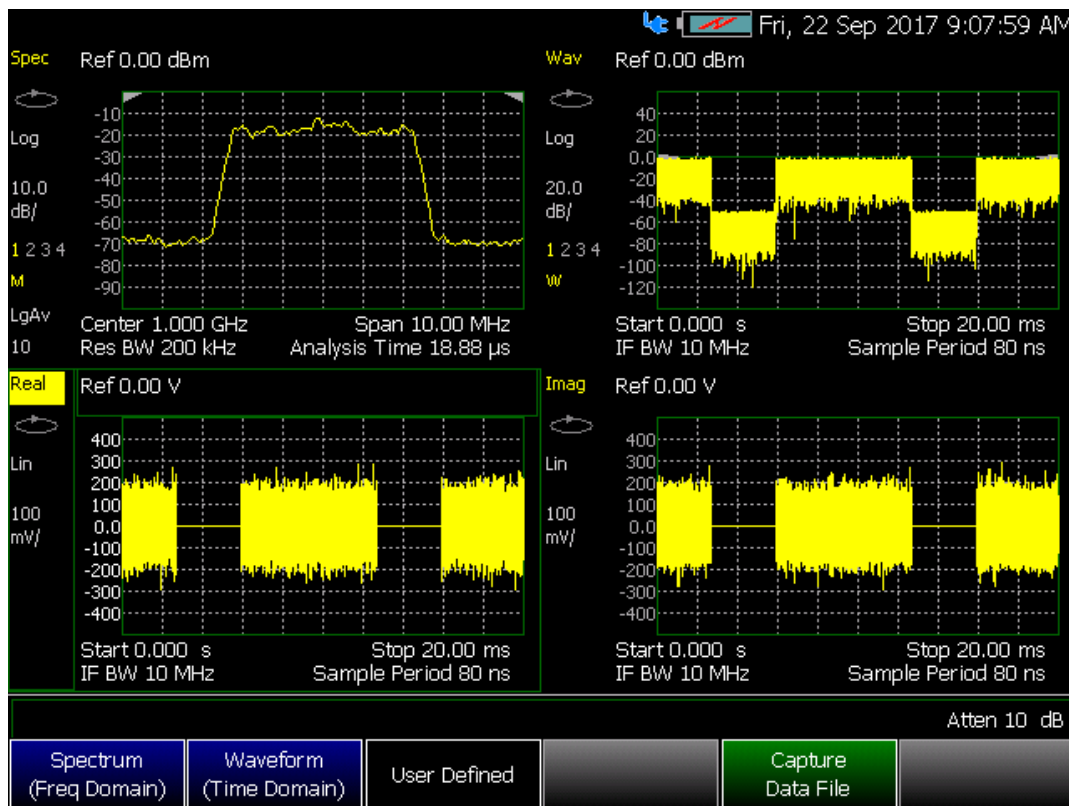

In this Chapter

[“About I/Q Analyzer \(IQA\) Measurements” on page 296](#)

[“I/Q Analyzer \(IQA\) Mode Settings” on page 297](#)

– [“How to Make Measurements Using the I/Q Analyzer Mode” on page 297](#)

– [“How to Capture I/Q Data to a File” on page 298](#)

– [“How to modify the I/Q data measurement parameters” on page 301](#)

[“Using Markers \(IQA\)” on page 312](#)

– [“Noise Marker” on page 312](#)

– [“Band/Interval Power Marker” on page 313](#)

– [“Band Span Marker \(Spectrum Only\)” on page 314](#)

– [“Interval Span Marker \(Waveform Only\)” on page 314](#)

– [“Coupled Markers \(Waveform Only\)” on page 314](#)

– [“Continuous Peak Search Marker” on page 316](#)

[“Alignments” on page 317](#)

[“Trace Display States \(IQA Mode\)” on page 317](#)

– [“How to display the Trace States” on page 317](#)

[“Other Features Available” on page 319](#)

– External Gain (SA chapter) – [“External Gain” on page 169](#)

– Display lines (SA chapter) – [“Display Line” on page 220](#)

– Limit Lines (Data Analysis chapter) – [“All about Limit Lines” on page 707](#)

See Also

[“Why and When to Calibrate” on page 134](#)

[“All about Markers” on page 692](#)

[“All about Limit Lines” on page 707](#)

[“All about Trace Math” on page 712](#)

[Chapter 29, “Data Analysis Features.”](#)

[Chapter 32, “File Management.”](#)

About I/Q Analyzer (IQA) Measurements

The I/Q Analyzer Mode makes general purpose frequency domain and time domain measurements. The mode enables two types of I/Q measurements:

- frequency domain and
- time domain measurements

In order to ensure consistent results between frequency domain and time domain, spectrum measurement and waveform measurement are based on the same I/Q acquisition. The following acquisition parameters are automatically calculated to satisfy these requirements:

1. RBW and IF BW specified in Spectrum measurement BW (**BW 2**) menu.
2. Start time and Stop time specified in Waveform measurement Sweep (**Sweep 3**) menu and IF BW specified in Waveform measurement BW (**BW 2**) menu.
3. I/Q signal capture related parameters specified in the Measurement Setup (**Meas Setup 4**) menu.

Some measurement parameters are auto-coupled and are not user-settable.

I/Q Analyzer (IQA) Mode Settings

NOTE

When you initially select I/Q Analyzer, Real-Time SA, or some of the other spectrum settings (such as center frequency) a factory channel Equalization measurement is applied to the signal. During channel equalization measurement, the FieldFox displays a “Start Channel Equalization”. Stopping channel equalization is not permitted. See also, “Alignments” on page 211, in Chapter 9, “SA (Spectrum Analyzer) Mode (Option 233–Mixed Analyzers).”

Select IQA Mode before making any settings in this chapter.

How to select IQA Mode

- Press **Mode**.
- Then **More** (may not be available—number of installed options dependent)
- Then **I/Q Analyzer**.

How to Make Measurements Using the I/Q Analyzer Mode

The Measure menu is used to set common parameters, predefined views selection, and measurement switching.

Spectrum has only one predefined view and Waveform measurement has two predefined views. There is a User Defined measurement, which can be used to display up to four different views (windows) simultaneously on the display screen. You can select which type of data to display in each of the views from the **Trace** menu.

See also, “How to Capture I/Q Data to a File” on page 298.

1. Press **Preset** then **Mode Preset (Factory)**
2. Press **Measure 1** then choose from the following:
 - **Spectrum (Freq Domain)** (Default) – Selects frequency spectrum as the current displayed measurement.
 - **Waveform** then choose one of the following:
 - **RF Envelope** Selects log RF envelope in time domain (default).
 - **I/Q Waveform** Selects linear Real and imaginary I/Q waveform values.
 - **User Defined** Selects a default user defined 4-quadrant display showing the following data:
 - Log magnitude of the spectrum of the I/Q data versus frequency
 - Log magnitude of the I/Q data (RF Envelope) versus time

- The real component of the I/Q data versus time
- The imaginary component of the I/Q data versus time

The user defined measurement can be modified to change the number of displays from 4 to 3, 2, or 1.

- **Capture Data File** Opens a menu to enable saving I/Q data to a file. When you press the **Start** capture softkey the data is saved to a file and the default file `IQDataFile.csv` is stored in the internal memory. Refer to **“How to Capture I/Q Data to a File” on page 298**.

How to Capture I/Q Data to a File

CAUTION

I/Q data cannot be recalled or displayed in the FieldFox instrument. The data file is intended for use in a PC.

There are two I/Q data file count capture modes, **Single** and **Multiple**. To capture your IQA data measurements:

- Press **Measure 1** > **Capture Data File** then choose one of the following:
 - **File Settings** Opens a menu to set the file choices:
 - **File Count** File count can be set to **Single** or 1 (all data saved into a single file for the current displayed data) or **Multiple**. When using Multiple as the file count, the user can enter the number of files to save, and the FieldFox is auto-coupled to Continuous acquisition mode and to Multiple capture and all data is saved to either an external SD card or USB storage device. Each acquisition is saved, before the next data acquisition occurs. (default: 1, minimum: 1, maximum: 1,000,000,000)
 - Single capture example (default): `IQDataFile.csv`
 - Multiple capture (default):
Example is: `IQDataFile_20171031 14.33.26.1050.csv`.
(format is: `IQDataFile_yyyymmdd hh.mm.ss.ffff.csv`).
 - Refer to the **Start** softkey on **page 299** and to the **“Example:” on page 300**.
 - **File Type** Selects the format of the output data file (CSV, TXT, SDF, or MAT). (Default: CSV)
 - **Device** Selects the storage location for your data files (Internal, SD Card, or USB). Internal is not available, if the File Count is set to Multiple (default: Internal).

If you do not have an external device connected and attempt to save your data, a warning message is displayed: "Warning: Only an external storage device can be used in multiple file mode."

Then select:

- **Internal** (default) Selects the internal memory of the FieldFox as the storage location for all data files. Internal is only available when File Count is set to Single.
- **SD Card** Selects the external SD card slot as the storage location for all data files.
- **USB** Selects an external USB storage device as the storage location for all data files.
- **Filename** Opens a file manager Labeler menu that enables you to customize your data filenames. Refer to **Chapter 32, "File Management."** (default: IQDataFile).
- **Back** Returns to the previous softkey menu.
- **Capture Settings** then choose one of the following:
 - **Capture Time** Sets the length of the I/Q trace capture time (default: 100 μ s, range: 80 ns to dynamic (i.e., Maximum capture time is 335.544 ms, which is associated with a sample rate of 12.5 MHz)).
 - **Sample Rate** Sets the I/Q data sample rate value (default: 12.5 MHz, maximum: 12.5 MHz, couplings: 1.25 * IF Bandwidth).
 - **Sample Period** Sets the 1/Sample Rate value (default: 80 ns, maximum: 80 ms, couplings: Sample Rate).
 - **Capture Samples** Sets the capture length using a sample number (default: 1251, minimum: 1, maximum: 4194304, couplings: Capture Time).
 - **Back** Returns to the previous softkey menu.
- **Start** Starts the I/Q data capture and stores the data into a default file and location (internal). Filenames and storage location can be customized. See also, the "Example:" on page 300 and to **Chapter 32, "File Management."**
 - Refer to the **File Count** softkey on **page 298**.

CAUTION

Each time you press the **Start** softkey the I/Q data writes to the current filename (i.e., Single capture default is IQDataFile.csv or for Multiple format is IQDataFile_YYYYMMDD hh.mm.ss.ffff.csv). To avoid overwriting your Single capture data or to add a unique filename for Single or Multiple capture data, use the **Measure 1 > Capture Data Settings > File Settings > Filename** softkey to modify your filename Refer to the **File Count** softkey on [page 298](#).

- **Stop** immediately stops the I/Q data file capture and stops writing data to the current I/Q data file (no data is saved). If the I/Q data was being saved when the Stop softkey is pressed, the file is deleted. Refer to **“Example:” on page 300**.

Example:

Single:

- If the **Capture Time** is set to 100 μ s, and you press the **Start** softkey, in **Single** mode the FieldFox saves 100 μ s of the current I/Q data.

Multiple:-

- If the File Count is set to 200, and you press the **Start** softkey, the FieldFox saves your 200 I/Q data files and stops. The I/Q data files are saved into 200 files similar to:
IQDataFile_YYYYMMDD hh.mm.ss.ffff.csv.
- If you press **Stop**, before the 200 I/Q data files have been saved, the FieldFox stops (interrupts) the multiple I/Q data file saving at the number of the current file. So, if you press Stop on file number 175, the saving process stops. If file number 175 has not been saved, it is deleted. But, I/Q data files 1 through 174 that have been saved prior to pressing **Stop**, are still saved for reference.

See also, [Chapter 32, “File Management.”](#)

How to modify the I/Q data measurement parameters

The following sections assume you have already selected your I/Q data measurement type (i.e., Spectrum, Waveform (RF Envelope or I/Q Waveform), or User Defined).

This section contains the following:

[“Adjusting the Bandwidth Settings” on page 301](#)

[“Changing between the Continuous and Single captures and adjusting the Trigger settings” on page 303](#)

[“Adjusting the Measurement Setup Settings” on page 306](#)

[“Adjusting the Trace Settings” on page 306](#)

[“Adjusting the Frequency Settings” on page 308](#)

[“Adjusting the Scale and Amplitude Settings” on page 308](#)

[“Preamplifier Control \(Opt 235\)” on page 310](#)

Adjusting the Bandwidth Settings

- Press **BW 2**.
- Then choose from the following:
 - **Res BW** (Spectrum only) – Sets the resolution bandwidth of the FFT analysis. Changing this value changes the FFT window size, analysis length, and the sweep time (data acquisition capture length). This softkey is only available when IQA is set to Spectrum (Freq Domain). When the resolution bandwidth value is set to Auto (default) the FieldFox automatically sets the optimum resolution bandwidth value. (Default: 200 kHz, Minimum: 0.1 Hz, maximum: 3 MHz).

NOTE

There is a significant difference between resolution BW in FFT measurements and the resolution BW of a traditional “sweeping” spectrum analyzer (SA) measurement. The resolution BW in FFT measurements does not directly control the IF BW like a traditional SA swept measurement. Resolution bandwidth is directly related to the analysis length (window) and or data acquisition capture length (sweep time).

- **Analysis Length** Sets the FFT analysis length that is the length of the complex I/Q data points (I/Q-pairs) vector that is used for spectrum analysis, expressed in the number of samples. (Couplings: In Auto, this setting is directly coupled to the Res BW and to Span. Minimum: 8, Maximum: 524,288. Where each FFT length “point” is equal to 1 I and 1 Q point. So, 237 is equal to 237 I and 237 Q points).

- **FFT Window** Sets the FFT filtering window (spectrum analysis window) shape for the I/Q data. Default: Flat Top

Then select one of the following:

FFT Window	Description
Uniform	No windowing
Triangular	Barlett windowing
Hanning	This is a Hann window, sometimes called Hanning or “raised cosine”.
Hamming	This window has lower side-lobe peaks than the Hann window, but has worse main-lobe flatness and poor side-lobe roll-off.
Blackman	This window is similar to the three-term Blackman-Harris window, but it has simpler fixed-form coefficients and better side-lobe roll-off.
Blackman Harris 3	This is the three-term Blackman-Harris window. This has the minimum side-lobe level for a three-term cosine window.
Blackman Harris	This is the four-term Blackman-Harris window. This has the minimum side-lobe level for a four-term cosine window with 60 dB/decade roll-off.
Gaussian Top	This is a five-term cosine window that resembles a Gaussian window.
Flat 4	This is a four-term flat-top window.
Flat Top (default)	This is the five-term flat-top window.
Flat 6	This is a six-term flat-top window.
Flat 7	This is a seven-term flat-top window.
P501	This is an alternative six-term flat-top window.
P601	This is an alternative seven-term flat-top window.
K-B (70 dB)	This is a Kaiser-Bessel window whose maximum side-lobe level is -70 dB.
K-B (80 dB)	This is a Kaiser-Bessel window whose maximum side-lobe level is -80 dB.
K-B (90 dB)	This is a Kaiser-Bessel window whose maximum side-lobe level is -90 dB.
K-B (100 dB)	This is a Kaiser-Bessel window whose maximum side-lobe level is -100 dB.
K-B (110 dB)	This is a Kaiser-Bessel window whose maximum side-lobe level is -110 dB.

FFT Window	Description
K-B (120 dB)	This is a Kaiser-Bessel window whose maximum side-lobe level is -120 dB.
Gaussian (60 dB)	This is a Gaussian window whose maximum side-lobe level is -60 dB.
Gaussian (70 dB)	This is a Gaussian window whose maximum side-lobe level is -70 dB.
Gaussian (80 dB)	This is a Gaussian window whose maximum side-lobe level is -80 dB.
Sinc	This window is the central lobe of the $\sin(x)/x$ (often called $\text{sinc}(x)$) function.
Tukey25	This is a tukey (cosine-tapered) window with alpha equal to 0.25.

- **IF BW** Sets the Digital IF bandwidth of the instrument. The relationship between the IF bandwidth and sample rate can be described by the following equation:

$$\text{sample rate} = 1.25 * \text{IF BW.}$$
 (Default: 10 MHz, minimum: 10 Hz, maximum: 10 MHz)

Changing between the Continuous and Single captures and adjusting the Trigger settings

- Press **Sweep 3**.
- Then choose from the following:
 - **Single** When pressed, Single automatically sets Continuous to OFF and causes the application to make one acquisition.
 - **Continuous** Toggles Continuous between ON and OFF. When Continuous is ON, each Run/Hold press causes the application to toggle between continuous acquisitions and Hold. When Continuous is OFF, each Run/Hold or Single press causes the application to make one acquisition.
 - **Restart** When pressed, Restart causes the FieldFox to restart trace averaging at count of 1. When in Single sweep mode, the IQA will perform a complete set of averages before returning to the hold state.
 - **Start Time (Waveform only)** Sets the start time of the waveform measurement (default: 0s, minimum: 0s, maximum: dynamic). In Waveform mode Setting the Start and stop time enables you to display a subset of the data on the display in order to speed up the

refresh rate when the acquisition time is long. Changing the Start Time changes which data point is displayed on the left side of the screen.

Couplings: When the change of Stop Time makes time domain display length exceed the limitation, the Start Time will change to satisfy time domain display length limitation:

--The maximum value is determined by current Sample Rate and the maximum capture samples.

--Start Time is adjusted to the nearest sample point based on the Sample Period.

--The maximum time domain display length is 524,288 points.

$$\text{Time Domain Display Length [pts]} = \{[\text{Sample Rate[pts/s]} \times (\text{Stop Time[s]} - \text{Start Time[s]})] + 1\}$$

Where:

pts = points

s = seconds

- **Stop Time** (Waveform only) Sets the stop time for the waveform display (default: 100 μ s, minimum: 0s, maximum: dynamic). In Waveform mode Setting the Start and stop time enables you to display a subset of the data on the display in order to speed up the refresh rate when the acquisition time is long. Changing the Stop Time changes which data point is displayed on the right side of the screen.

Couplings: When the change of Stop Time makes time domain display length exceed the limitation, the Start Time will change to satisfy time domain display length limitation:

--The maximum value is determined by current Sample Rate and the maximum capture samples.

--Stop Time is adjusted to the nearest sample point based on the Sample Period.

--The maximum time domain display length is 524,288 points.

$$\text{Time Domain Display Length [pts]} = \{[\text{Sample Rate[pts/s]} \times (\text{Stop Time[s]} - \text{Start Time[s]})] + 1\}$$

Where:

pts = points

s = seconds

- **Trigger Settings** Opens the Trigger Settings softkey menu.

Then:

-- **Trig Type** Then select one of the following:

Softkey	Description
Free Run	(Default.) – Triggering is provided by the FieldFox internal circuitry. A new acquisition begins when the previous acquisition ends.
External	An acquisition is triggered on an external TTL signal at the Ref In/Trig In connector on the FieldFox top panel. Choose to trigger on the rising slope at about 1.7 V or on the falling slope at about 1.0 V using the Trigger Slope setting (below).
Video	An acquisition is initiated when the displayed amplitude of an incoming signal crosses the settable Trigger Level. This selection can detect low-amplitude signals, but also has been filtered considerably and may not be a true representation of the incoming signal.
RF Burst	An acquisition is initiated when the signal at the third IF (analog) stage crosses the settable Trigger Level. This selection offers a wider bandwidth and may be a better representation of the incoming signal than Video trigger. However, RF Burst is not as sensitive to triggering on low-level signals.
Periodic	Periodic sets a trigger that repeats at the period rate entered. Periodic trigger's phase can be altered by the Offset value.

--Then depending on the trigger type selected, choose from the following:

Trig Level – Sets the trigger level. This softkey is only active for Video or RF Burst (default: -25 dBm, minimum: -210 dBm, maximum: 30 dBm).

Trig Slope – Sets the negative/positive trigger slope. This softkey is only active for External, Video, or RF Burst (default: Pos).

Trig Delay – Sets the trigger delay. This softkey is only active for External, Video, or RF Burst (default: 0s, minimum: -150 ms, maximum: 500 ms).

Glitch Mask – Enables the glitch mask to reduce incorrect triggering due to fast changes/glitches in the signal level that can be mistaken to be the edge of the RF burst. This softkey is only active for RF Burst (default: 0 ms, minimum: 0s, maximum: 5 ms).

Auto Trigger – While waiting for a valid trigger signal, **Wait** is annotated in the top left corner of the FieldFox screen.

If a valid trigger signal is not received before the specified Auto Trig Time, a acquisition will occur automatically.

Enter **0** to set Auto Trigger **OFF**. When Auto Trigger is OFF, the FieldFox does NOT perform an acquisition unless a valid trigger signal is received.

(Default: 100 ms, minimum: 1 ms, maximum: 100s)

Adjusting the Measurement Setup Settings

- Press **Meas Setup 4**.
- Then choose from the following:
 - **Average Type** Opens a menu of averaging softkeys.

Then select one of the following:

- **Power** (Linear) Averaging – Best for measuring true power levels. Used in Noise Marker Average. Mathematically, trace noise is 2.5 dB higher than when using Log Average. **PAvg** annotation is displayed.
- **Log** Averaging (default) – Best for displaying Trace Averaging. Also known as video averaging. **LgAvg** annotation is displayed.
- **Voltage** (Magnitude) Averaging – Converts the amplitudes to a magnitude unit before averaging (e.g., Volts, Amps, microVolts, millivolts, etc.) **VAvg** annotation is displayed.
- **Average Count** The Average Count setting is used with the Average Trace State. In this Trace State, the Average Count setting determines the number of acquisitions to average. The higher the average count, the greater the amount of noise reduction (default: 10, minimum: 1, maximum: 10000).
- **Sample Rate** Sets the I/Q data sample rate value (default: 12.5 MHz, maximum: 12.5 MHz, couplings: 1.25 * IF Bandwidth).
- **Sample Period** Sets the 1/Sample Rate value (default: 80 ns, minimum: 80 ns, maximum: 80 ms, couplings: 1/Sample Rate).

Adjusting the Trace Settings

The Trace menu is used to modify the existing predefined view, or create a customized view. Window and Win State softkeys are used to modify layout of view, the Data softkey is used to specify the displayed data results for the current window. Please note only in User Defined measurement are all of the data results from Spectrum measurement and Waveform measurement

available. Otherwise, only the data results from the current measurement (Spectrum or Waveform) are available. See also **“Trace Display States (IQA Mode)” on page 317.**

The Trace and Trace State keys are used to choose how many traces of the data result are displayed, and the trace data type (Clr/Wr, MaxHold, MinHold, Average, View, or Blank) that are displayed for each measurement.

- Press **Trace 6**.
- Then choose from the following:
 - **Window 1 2 3 4** Changes the selected window (default: 1).
Then select one of the following:
 - **Win State ON OFF** Enables or disables the current Window (1, 2, 3, or 4) selected by the Window 1 2 3 4 softkey (default: Window 1 is set to ON).
 - **Data** Sets the data type displayed.

Then select one of the following:

For **Spectrum Measurement:**

Mag Spectrum

Time Summary – Time Summary result includes the capture time, spectrum analysis time and waveform start/stop time.

For **Waveform Measurement:**

I vs. Time – Imaginary vs. Time

Q vs. Time – Quadrature vs. Time

Q vs. I – Quadrature vs. Imaginary

RF Envelope

Phase vs. Time

Unwrapped Phase vs. Time

Time Summary – Time Summary result includes the capture time, spectrum analysis time and waveform start/stop time.

- **Trace 1 2 3 4** Pressing the Trace key enables you to select a different trace number. This softkey is active when Data is set to Spectrum or RF Envelope.

NOTE

Spectrum and RF Envelope have six markers that can be applied to any of the 4 traces.

Waveform's six markers can be applied to RF Envelope, Real, Imaginary, Phase, Unwrapped Phase, and Q vs. I.

- RF Envelope has four traces.
- Real, Imaginary, Phase, Unwrapped Phase, and Q vs. I have 1 trace each.

-
- **Trace State** Sets a different trace state to each of four traces. This softkey is active when the data is set to Spectrum or RF Envelope (Log). Pressing the Trace State softkey enables you to change the State of the selected Trace number of the Trace Data (default: Clr/Wr – assigned to trace 1. Traces 2, 3, and 4 are set to Blank).

Adjusting the Frequency Settings

- Press **Freq/Dist**.
- Then select from the following:
 - **Center** Sets the center frequency of the measurement trace (default: 1 GHz, minimum: 0 Hz, maximum: FieldFox model dependent).
 - **Freq Span** (Spectrum Only) Sets the frequency span of the measurement trace. The analyzer's digital IF bandwidth is always equal to this value.

Changing the span causes the IF bandwidth and the sample rate to change automatically:

Span = IF bandwidth, sample rate = 1.25 * IF bandwidth

Res BW = Span /50, if resolution bandwidth = Auto.

Default: 10 MHz, minimum: 10 Hz, maximum: 10 MHz

Adjusting the Scale and Amplitude Settings

Enables you to change attenuation settings. When RF Attenuation Auto is ON, the RF Attenuation is set by adjusting the acquisition. As the acquisition is lowered, for example from -10 dBm to -30 dBm, the FieldFox assumes that you are looking at low-level signals. The RF Attenuation value is automatically lowered in 5 dB steps to allow low-level signals to be viewed. The RF Attenuation value is never automatically lowered below 5 dB.

How to set Scale/Amptd

- Press **Scale/Amptd**.

Manually set Log or Linear Scale Type (Spectrum and RF Envelope Only)

Then select from the following:

- **More**
 - **Scale Type [current setting]** (Spectrum and RF Envelope Only)
 - **Log** Logarithmic scale (default setting). The Y-axis reference line represents the specified absolute acquisition in the current Unit selection. Y-axis graticules show dB below or above the reference line (default: 10 dB, minimum: 0.01 dB, maximum: 20 dB).
 - **Lin** Linear scale. The Y-axis reference line represents the specified absolute acquisition in the current Unit selection.
 - Y-axis graticules show percent of acquisition (%) below or above the reference line (Spectrum).
 - Y-axis graticules show voltage (V) – (RF Envelope).

Manually set Scale, Unit, Acquisition, and Reference Position.

- **Autoscale** Automatically adjusts the Y-axis to comfortably fit the Minimum and Maximum amplitude of the trace on the screen. Also, optimizes the FieldFox's signal level at the mixer and adjusts the reference level to with the autoscale settings.
- **Scale/Div** Manually adjust the scale per division to view specific areas of the current trace. Enter a value using the numeric keypad, the **▲▼** arrows, or the rotary knob. Then press **Enter**.
- **Ref Level** Manually set the value of the reference line. Enter a negative value by pressing **Run/Hold (+/-)** either before or after typing a value. Use acquisition in combination with the RF attenuator and the Preamp so that the signal at the acquisition is at the optimum level for the FieldFox (Spectrum and RF Envelope Only). This can also change the RF Attenuation setting (default: 0). See **“Attenuation Control” on page 310**.
- **Ref Pos** Manually set the position of the reference line. Values must be between 0 (TOP line) and 10 (BOTTOM line). Default position is zero (top) (default: 0, minimum: 0, maximum: 10).
- **More**, then
 - **Unit** Sets the display units.

Attenuation Control

Both the RF Attenuation and Preamp functions control the power level into the FieldFox mixer.

When too much power is present at the RF Input port, **ADC Over Range** appears on the FieldFox screen. This does not necessarily mean that damage has occurred, but that the receiver is probably compressed.

When high power levels are present at the RF Input port, internal attenuation can be switched in to keep the FieldFox receiver from compressing. At extremely high power levels, use external attenuation to protect the internal circuitry from being damaged.

CAUTION

The FieldFox can be damaged with too much power.

RF Damage Level: +25 dBm (N995xA & N996xA) and +27 dBm (all others)

DC Damage Level: ±50 VDC

The displayed power level is automatically adjusted for RF Attenuation. As the attenuation value changes, the displayed power level should NOT change.

How to set Attenuation

- Press **Scale/Amptd**.
- Then **RF Atten Auto Man**.
- **Auto** RF Attenuation is set by adjusting the input power level. As the acquisition is lowered, for example from –10 dBm to –30 dBm, the FieldFox assumes that you are looking at low-level signals. The RF Attenuation value is automatically lowered in 5 dB steps to allow low-level signals to be viewed.
- **Man** RF Attenuation is set manually. The default Attenuation setting is 10 dB. Enter a value between 0 to 30 dB in 5 dB steps using the numeric keypad, the **▲▼** arrows, or the rotary knob. Then press **Enter**

#Atten xx dB is shown at the top of the screen. (#) means manual setting.

(Default: 10 dB, minimum: 0 dB, maximum: 30 dB.)

Preamplifier Control (Opt 235)

When very low-level signals are analyzed, an internal preamplifier can be used to boost the signal level by approximately 18 to 22 dB. The gain of the preamp is NOT adjustable. The displayed signal level is automatically adjusted for the increase in system gain.

How to control the Preamp

By default, the preamp is OFF.

- Press **Scale/Amptd**.
- Then **More**
- Then **Preamp Off** The displayed setting is the current setting. When ON, **PA** is shown to the left of the graticules on the display (default: OFF). When OFF, nothing is displayed in the left graticules.

When Auto is selected, the preamp setting is determined by the RF attenuation and to the input power level. When the input power level reaches a certain value, the preamp is turned on and **PA** is shown to the left of the graticules on the display.

Using Markers (IQA)

The markers described here are for I/Q Analyzer mode (exceptions are noted). For additional marker features, refer to [“All about Markers” on page 692](#).

NOTE

IMPORTANT! When using I/Q markers, it is important to either be in Single acquisition mode or for Continuous acquisition mode, to set the measurement in advance on the FieldFox to Waveform or to Spectrum. Refer to [“How to Make Measurements Using the I/Q Analyzer Mode” on page 297](#).

The spectrum measurement’s six markers can only be applied to a single displayed set of traces (Magnitude Spectrum).

The waveform measurement’s six markers can be applied to any of the six displayed parameter traces (RF Envelope, I (Imaginary), Q (Real), Phase, Unwrapped Phase, or Polar).

See also [“Trace Display States \(IQA Mode\)” on page 317](#).

This section contains the following:

[“Noise Marker” on page 312](#)

[“Band/Interval Power Marker” on page 313](#)

[“Band Span Marker \(Spectrum Only\)” on page 314](#)

[“Interval Span Marker \(Waveform Only\)” on page 314](#)

[“Coupled Markers \(Waveform Only\)” on page 314](#)

[“Continuous Peak Search Marker” on page 316](#)

Noise Marker

For comparison purposes, electronic noise measurements are often displayed as though the measurement was made in a 1 Hz Res BW. However, making an actual measurement at a 1 Hz Res BW is extremely slow.

A Noise Marker mathematically calculates the noise measurement as though it were made using a 1 Hz bandwidth.

Several data points are averaged together to calculate the Noise Marker readout. To accurately measure noise, the Noise Marker should NOT be placed on, or too close to, a signal. The distance from a signal depends on several factors. To know if an accurate reading is being made, move the Noise Marker until consistent measurements are displayed in adjacent data points.

With a Noise Marker present, the Res BW can be changed and the displayed noise floor will also change, but the Noise Marker readout will remain about the same.

Noise Markers can be used like regular markers. A Noise Marker is distinguished from a regular marker by **(1Hz)** after the marker readout value. Learn more about regular markers in **“All about Markers” on page 692**.

How to measure Noise with a marker

- Press **Marker** to create or select a Normal or Delta marker to use to measure Noise.
- Then **More**.
- Then **Marker Function**
- Then **Noise**.

Band/Interval Power Marker

A Band/Interval Power marker—available in IQA and SA Modes—integrates the power that is measured over several adjacent data points. The range of points being measured is displayed with vertical posts around the marker. This Band Span value is selectable.

This feature is very similar to a channel power measurement (see SA chapter, **“Channel Power (CHP)” on page 226**).

When the IQA is set to a waveform measurement, the marker is referred to as an Interval Marker because it averages power over a specific time interval. In this case the range is specified as the Interval Span.

How to measure Band/Interval Power with a marker

- Press **Marker** to create or select a Normal or Delta marker to use to measure Band/Interval power.
- Then press **More**
- Then **Marker Function**
- Then **Band/Int Power**
- Then **Band Span** (Spectrum) or **Interval/Span** (Waveform)
- Then choose from the following:
 - **Auto** Measures power over 5% of the displayed span, or ½ graticule. The Band Span is automatically updated to remain at 5% when you change the frequency span.
 - **Man** Enter a frequency or time value using the **▲▼** arrows or the rotary knob, then press **Enter**. Or enter a value using the numeric keypad and select a frequency or time suffix. The Band Span remains at the frequency or time value that you set as the span changes.

Band Span Marker (Spectrum Only)

Sets the width of the span (Hz) for the selected marker.

How to measure with the Band Span marker

- Press **Marker** to create or select a Normal or Delta marker to use to measure Band/Interval Power.
- Then press **More**
- Then **Marker Function**
- **Band Span** Enables or disables the Band Span marker (default: 500 kHz, minimum: 1 Hz, maximum: 10 MHz).

Interval Span Marker (Waveform Only)

Sets the width of the interval span (seconds) for the selected marker.

How to measure with the Interval Span marker

- Press **Marker** to create or select a Normal or Delta marker to use to measure Band/Interval power.
- Then press **More**
- Then **Marker Function**
- **Interval Span** Enables or disables the Band Span marker (default: 5% of the (start time – stop time), minimum: 1 ns, maximum: 10s).

Coupled Markers (Waveform Only)

When a Coupled marker is enabled in a window on the FieldFox, the current active marker in that window is enabled as the 'reference' coupled marker on the current trace and the x-axis value of any other active waveform markers on any other traces in other windows are updated to track that of the 'reference' coupled marker. Refer to [Figure 11-2 on page 315](#).

How to measure with the Coupled marker

- Press **Marker** to create or select a Normal, Delta, or Peak marker to use the Coupled Marker.
- Then **More**
- Then **Coupled Markers** Enables or disables the coupled marker (default: OFF).

Procedure to set coupled markers (Refer to [Figure 11-2 on page 315](#)):

1. Press **Preset** > **Mode Preset (Factory)**
2. Press **Measure 1** > **User Defined**

Four windows are displayed (Spectrum, Waveform, Real, and Imaginary)

3. Using the $\blacktriangle\blacktriangledown$ arrows or the rotary knob, move so Window 2 Waveform is selected (green border).
4. Press **Marker** > **Marker 1** > **Normal**
5. Press **Esc**
6. Repeat steps 3 through 5 while selecting the other measurement windows and markers:
 - Real using marker 2 and
 - Imaginary using marker 3
7. Press **Marker** > **More** > **Coupled Markers ON**
8. Press **Marker** and use the $\blacktriangle\blacktriangledown$ arrows or the rotary knob to move the coupled markers along the traces in Window 2 (Waveform), Window 3 (Real), and Window 4 (Imaginary).

Figure 11-2 IQ Analyzer (IQA) Display - Coupled markers with Waveform (marker 1), Real (marker 2), and Imaginary (marker 3) displays

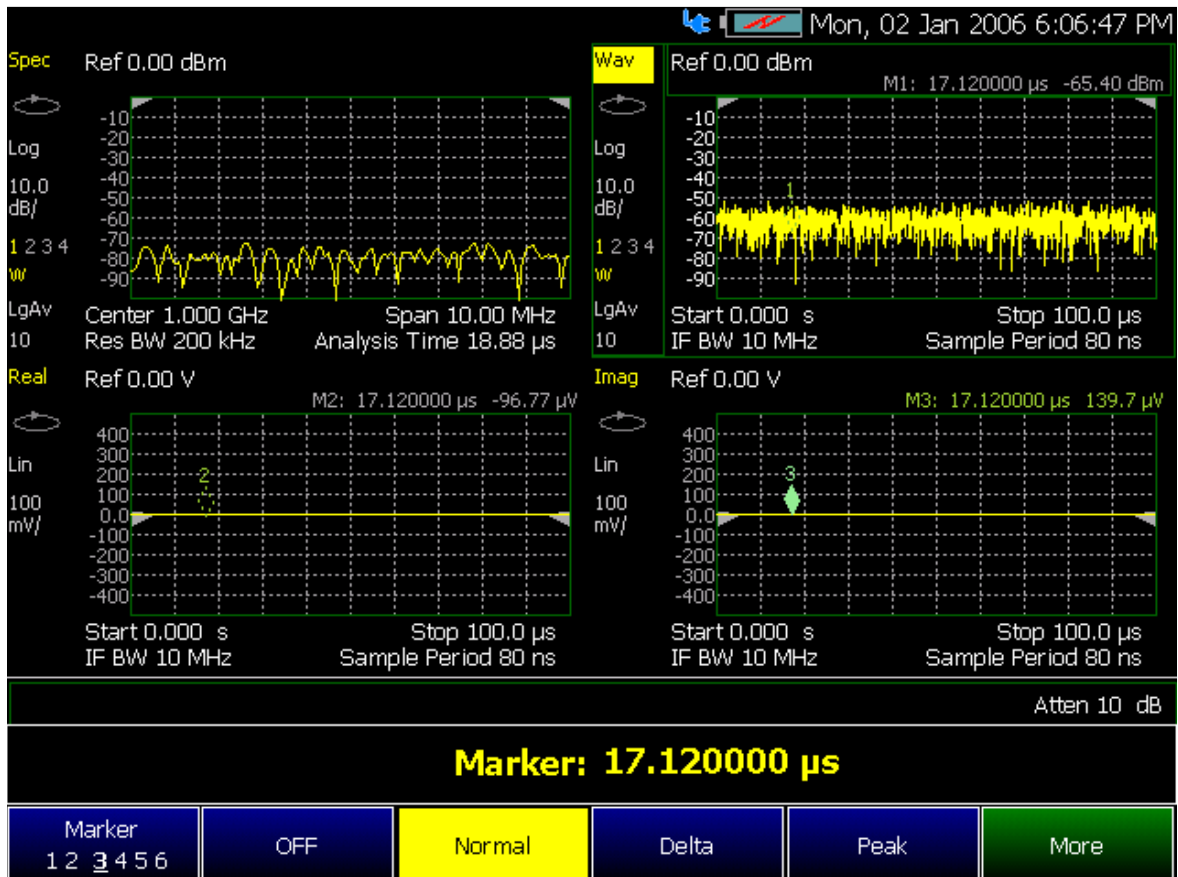

Continuous Peak Search Marker

When the Continuous Peak Search marker is on, a peak search is automatically performed for the selected marker after each acquisition. For additional marker functionality, refer to **“All about Markers” on page 692**.

Summary:

- **Cont Peak Search** Enables or disables the continuous peak search
- The rules for finding the peak are exactly the same as for Peak Search, including the use of peak criteria rules.

How to measure with the Continuous Peak Search marker

- Press **Mkr->/Tools** to create or select a Normal or Delta marker to use the Continuous Peak Search marker.
- Then press **More** (RF Spectrum Only)
- Then press **Mkr Properties**
- Then **Peak Criteria**
- Then **Cont Peak Search** Enables or disables the Continuous peak search marker (default: OFF).

Alignments

The IQA mode requires all three alignment types: amplitude, RF burst, and channel equalization. Refer to the SA chapter's "[Alignments](#)" on page 211 for information on all alignments.

Trace Display States (IQA Mode)

NOTE

If you have Option 351 I/Q Analyzer option, you can directly save your data as MATLAB files (*.mat). Refer to [Chapter 11, "IQ Analyzer \(IQA\) – Option 351 \(CPU2 Only\)"](#), on page 293 and to [Chapter 32, "File Management."](#)

If you have the FieldFox's Remote Server mode (89600 VSA software connectivity), you can use the VSA software to capture and record your data as MATLAB files (*.mat). Learn more about FieldFox and 89600 VSA software, refer to [Chapter 17, "Remote Server Mode \(Requires CPU2 and SA Hardware/SA Option 233\)"](#) and to <http://rfmw.em.keysight.com/wireless/helpfiles/89600B/WebHelp/89600.htm>.

In IQA Mode you can display up to four of the following types of trace states. All IQA settings are applied to all displayed traces. See also "[Marker Trace \(IQA and SA Mode\)](#)" on page 696.

A color-coded legend for displayed traces is visible in the left pane of the SA mode screen:

W = Clear/Write; **M** = MaxHold; **m** = MinHold; **A** = Average; **V** = View

How to display the Trace States

- Press **Trace 6**.
- Then **Trace 1,2,3,4** repeatedly to select a trace number to display or change its state. Traces are displayed in the following colors:
 - Trace 1 – **Yellow** Trace 2 – **Blue**
 - Trace 3 – **Orange** Trace 4 – **Green**
- Then **State [current setting]**
- Then choose from the following Trace States:
 - **Clr /Wr** (Clear/Write) Displays the actual measured data for each acquisition.
 - **MaxHold** Displays the maximum response of the input signal at each data point over multiple acquisitions. See also Average Count in "[Adjusting the Measurement Setup Settings](#)" on page 306.

- **MinHold** Displays the minimum response of the input signal at each data point over multiple acquisitions. See also Average Count in [“Adjusting the Measurement Setup Settings” on page 306](#).
- **Average** Each data point is averaged over multiple acquisitions as set by the Average Count setting. Learn more in [“Adjusting the Measurement Setup Settings” on page 306](#).
- **View** Displays and then holds the last complete measurement trace on the screen. This is similar to storing a trace in memory.
- **Blank** Displays no trace.

Other Features Available

- **External Gain** - Refer to refer to the SA chapter's section, "**External Gain**" on page 169.
- **Limit Lines** - For information on using Limit Lines, refer to "**All about Limit Lines**" on page 707.
- **Display Lines** - For information on using Limit Lines, refer to the SA chapter's section, "**Display Line**" on page 220.

IQ Analyzer (IQA) – Option 351 (CPU2 Only)
Other Features Available

12 Electromagnetic Interference (EMI) Measurements – Option 361

Requirements

- EMI mode measures signals at the **SA RF Input Port 2** connector.
- EMI mode requires the FieldFox to have SA mode (Option 233 on combination analyzers) and CPU2 installed.

Recommended, but not required:

- EMI chamber.
- Preamplifier (Option 235) to improve receiver sensitivity.
- Filters
- Line impedance stabilization network (LISN) – conducted emissions testing
- Transient limiter – conducted emissions testing
- Calibrated antenna – radiated emissions testing
- Signal generator (e.g., EXG, MXG)
- Set of antennas
- Set of near field probes (e.g., Keysight N9311X Series of antennas and field probes.)

EMI Option 361 measures radiated and conducted emissions. With EMI you can measure the unintentional generation, propagation, and reception of electromagnetic energy that might cause your device to violate pre-compliance/compliance testing. This includes the emissions and immunity (susceptibility) levels of electromagnetic energy.

In this Chapter

The following outline of this chapter is separated into two main sections:

- “EMI Measurements” and
- “Chapter Overview of EMI Measurements”

EMI Measurements

“Using EMI Measurements (Option 361)” on page 325

“EMI Measurements Mode Settings” on page 326

- “How to select EMI Measurements Mode” on page 326
- “Scale and Units” on page 328
- “CISPR (International Special Committee on Radio Interference) Control” on page 329
- “Resolution Bandwidth (Res BW)” on page 334
- “Single / Continuous / Restart” on page 335
- “Points” on page 336
- “Trace Display States (EMI Mode)” on page 336
- “Detection Method” on page 338
- “Input – (Trace Input for APD Measurements)” on page 339

“About Electromagnetic Interference (EMI) Measurements” on page 340

- “EMI Measurement Features (Option 361)” on page 341

“How to Set Up Electromagnetic Interference (EMI) Mode Settings” on page 343

- “EMI Measurement Mode Setup Procedure” on page 343

“Glossary (EMI)” on page 344

Chapter Overview of EMI Measurements

- “Using EMI Measurements (Option 361)” on page 315 – see [“EMI Measurements” on page 322](#)
- “EMI Measurements Mode Settings” on page 316 – see [“EMI Measurements” on page 322](#)
- “How to Select EMI Measurements Mode” on page 318 – see [“EMI Measurements” on page 322](#)
- [“Frequency Range” on page 326](#)
- “Scale and Units” on page 318 – see [“EMI Measurements” on page 322](#)
- [“External Gain” on page 328](#)
- [“Attenuation Control” on page 329](#)
- “CISPR (International Special Committee on Radio Interference) Control” on page 318 – see [“EMI Measurements” on page 322](#)
- [“Preamplifier Control \(Opt 235\)” on page 334](#)
- “Resolution Bandwidth (Res BW)” on page 323 – see [“EMI Measurements”](#)
- “Single / Continuous / Restart” on page 324 – see [“EMI Measurements” on page 322](#)
- “Points” on page 325 – see [“EMI Measurements” on page 322](#)
- “Trace Display States (EMI Mode)” on page 325 – see [“EMI Measurements” on page 322](#)
- [“Trace Averaging” on page 337](#)
- [“Alignments” on page 337](#)
- “Detection Method” on page 328 – see [“EMI Measurements” on page 322](#)
- “Input” on page 330 – see [“EMI Measurements” on page 322](#)
- “About Electromagnetic Interference (EMI) Measurements” on page 332 – see [“EMI Measurements” on page 322](#)
- [“EMI Measurement Features \(Option 361\)” on page 333 – see “EMI Measurements” on page 322](#)
- “How to Set Up Electromagnetic Interference (EMI) Mode Settings” on page 335 – see [“EMI Measurements” on page 322](#)

- “EMI Measurement Mode Setup Procedure” on page 335 – see “EMI Measurements” on page 322

“Glossary (EMI)” on page 337 – see “EMI Measurements” on page 322

Other Features available – Refer to Chapter 9, “SA (Spectrum Analyzer) Mode (Option 233–Mixed Analyzers)” and Chapter 29, “Data Analysis Features”:

- **Alignments (SA)** – “Alignments” on page 211
- **Attenuation Control (SA)** – “Attenuation Control” on page 170
- **External Gain (SA)** – “External Gain” on page 169
- **Field Strength Corrections (SA)** – “How to select and edit corrections for Field Strength measurements” on page 172
- **Preamp Control (SA)** – “Preamplifier Control (Opt 235)” on page 171
- **Source Tracking Offset and Offset Reversal (SA)** – “Source Tracking Offset and Offset Reversal” on page 176.
- **Independent Source/Tracking Generator (SA)** – “Independent Source/Tracking Generator” on page 193
- **Scale Settings (Data Analysis)** – “All about Scale Settings” on page 714

Optional Settings:

“All about Markers” on page 692

“All about Limit Lines” on page 707

“Saving and Recalling Files” on page 768

See Also

“Why and When to Calibrate” on page 134

Chapter 30, “System Settings.” (Changing display colors)

Chapter 32, “File Management.”

Using EMI Measurements (Option 361)

EMI enables you to do the following:

Measure and display EMI signals to verify your device/instrument's pre-compliance measurements

Electromagnetic Interference Features (EMI) - (Option 361)

- Amplitude Probability Distribution (APD) Statistics, both CCDF and Histogram
- Selectable CISPR bands (A, B, C, D, E)
- Fast SA Scan for quick setup check
- Frequency range coupled to CISPR bands
- Logarithmic frequency axis
- 200 Hz, 9 kHz, 120 kHz 6 dB resolution bandwidths, and 1 MHz impulse bandwidth, auto-coupled to CISPR bands
- EMI Detector settings, selectable per trace
 - Quasi-Peak
 - EMI Average
 - Positive Peak
- Simple Color coded Trace/Detector pair controls

EMI Measurements Mode Settings

This section contains content unique to EMI measurements mode and some features that are similar to SA mode settings. Unique Option 361 EMI measurements content can be found in this chapter. But, when EMI/SA mode's shared feature content is referenced, you are referred to **Chapter 9, "SA (Spectrum Analyzer) Mode (Option 233–Mixed Analyzers)."**

How to select EMI Measurements Mode

- Press **Mode** > **EMI Measurements**

Learn more see, "**CISPR (International Special Committee on Radio Interference) Control**" on page 329.

NOTE

When you initially select EMI, I/Q Analyzer, Real-time SA, or some of the other spectrum settings (such as center frequency) a factory channel Equalization measurement is applied to the signal. During a channel equalization measurement, the FieldFox displays a "Start Channel Equalization". Stopping channel equalization is not permitted. See also, "**Alignments**" on page 211, in **Chapter 9, "SA (Spectrum Analyzer) Mode (Option 233–Mixed Analyzers)."**

Frequency Range

The X-axis frequency range determines the frequencies that are measured for each sweep. The default Start and stop frequencies are dependent on the CISPR band selected.

NOTE

Although the start frequency can be set as low as -100 MHz, amplitude accuracy is specified above 9 kHz (depending on your model). Below 9 kHz (depending on model), frequency accuracy is maintained, but amplitude accuracy is degraded. Refer to <https://www.keysight.com/us/en/assets/7018-03314/data-sheets/5990-9783.pdf>.

The frequency range of the measurement can be changed using the following methods:

- Set Center and Span frequencies (Frequency Span varies with instrument model)
- Set Start and Stop frequencies
- Using Marker > Center

How to set Frequency Range and Frequency Context

For EMI mode, you are able to change the center, frequency span, start, and stop frequencies or select a specific CISPR band. See also, “[CISPR \(International Special Committee on Radio Interference\) Control](#)” on [page 329](#).

- Press **Freq/Dist**.
- Then choose from the following:
 - **Center** and **Freq Span** frequencies. This is the most common method of entering frequency range. Enter the frequency of interest. The Center frequency is at the exact center of the X-axis. The Frequency Span places half of the frequency range on either side of center. When the Center and Frequency Span values are entered, then the X-axis annotation on the screen shows the Center and Span frequencies.

NOTE

In the CISPR Band Scan measurement, the default span is the full range of the particular CISPR band selected. The Span can be changed, to examine part of the CISPR band in more detail, but the Span can never exceed the full width of the CISPR band, and never be less than the minimum span which CISPR Zoom Scan achieves. The Full Span button causes a CISPR Band Scan to return to the default full range of the particular CISPR band. Learn more, see “[CISPR \(International Special Committee on Radio Interference\) Control](#)” on [page 329](#).

-
- **Start** and **Stop** frequencies. Start is the beginning of the X-axis and Stop is the end of the X-axis. When the Start and Stop frequencies are entered, then the X-axis annotation on the screen shows the Start and Stop frequencies. **Start** and **Stop** are not active choices for **CISPR Zero Scan** (i.e., for **CISPR Band Scan** and **CISPR Zero Scan** **ZSpan** in the lower right of the display indicates you are at the span limit).
 - **Zero/Last Span** For EMI mode, which defaults to log sweep, this softkey toggles between log (FFT) – previous screen and start/stop frequencies and linear (Time) – in zero Span.
 - Optionally, press **More** then:
 - **Freq Annotation** and one of the following:
 - AutoSelect** (Default) – The FieldFox selects a frequency annotation setting (Center Span or Start Stop).
 - CenterSpan** – The center frequency and span are displayed.
 - StartStop** – The start and stop frequencies of the frequency span are displayed.



- **Log Freq AxisX** enables/disables the log frequency X-axis. Disabling the log frequency X-axis, enables the linear frequency X-axis (Default = ON).
- **CF Step** then type a step size value using the numeric keypad, then select a frequency unit terminator key (Default = Auto).
- **Full Span** the frequency span changes the instrument's full frequency span (frequency span is model dependent).

This softkey is inactive (grayed out), for **CISPR Zoom Scan** and **APD Statistics**, because RF tuning is fixed and Span changes are not allowed.

For CISPR Band Scan the Full Span varies based on the 6 dB resolution BW setting:

If the 6dB Resolution BW is auto-coupled, Full Span changes the span to match the Full CISPR Band you have selected. Learn more see, [“How to Set the EMI Measurement Settings \(Fast SA Scan, CISPR Band Scan, CISPR Zoom Scan, and APD Statistics\)” on page 329.](#)

If the 6 dB resolution BW is set to manual, Full Span changes the span to the maximum span limits described in the table in [“Resolution Bandwidth \(Res BW\)” on page 334.](#)

- Follow each of these, when prompted, by entering a value using the numeric keypad, the  arrows, or the rotary knob.
- When using the  arrows, press **Enter**. The increment setting of the arrows is based on the current span.
- After using the keypad, select a multiplier key. Learn more in [“Multiplier Abbreviations” on page 53.](#)

Scale and Units

NOTE

EMI Measurements mode defaults to Scale Type: Log.

Learn more, refer to [“Scale and Units” on page 168.](#)

External Gain

Refer to [“External Gain” on page 169.](#)

Attenuation Control

Refer to [“Attenuation Control” on page 170](#).

CISPR (International Special Committee on Radio Interference) Control

This section describes the FieldFox EMI measurement mode’s instrument controls for evaluating pre-compliance EMI of the equipment under test.

After EMI mode is selected or after a Mode Preset, the **Measure** menu is displayed. Two primary controls are available:

CISPR band and **Measurement** – there are 5 CISPR bands (A/ B/ C/ D/ E) which, when selected, automatically set the instrument to a CISPR defined frequency range and CISPR defined measurement bandwidth. Learn more, see [“Resolution Bandwidth \(Res BW\)” on page 334](#).

For this section, refer to [Figure 12-1 on page 331](#), [Figure 12-2 on page 332](#), [Figure 12-3 on page 332](#), [Figure 12-4 on page 333](#), and [Figure 12-5 on page 333](#).

This section contains:

- [“How to Set the EMI Measurement Settings \(Fast SA Scan, CISPR Band Scan, CISPR Zoom Scan, and APD Statistics\)” on page 329](#)
- [“How to set a CISPR Band” on page 331](#)

Learn more, see [“How to set the EMI Traces” on page 336](#).

How to Set the EMI Measurement Settings (Fast SA Scan, CISPR Band Scan, CISPR Zoom Scan, and APD Statistics)

Screen defaults to Log sweep, but you can toggle using **Freq/Dist** > **Zero/Last Span**. Learn more, see [“Frequency Range” on page 326](#) and [“How to set the EMI Traces” on page 336](#)

NOTE

Point quantities are not manually controllable within CISPR Band Scans or CISPR Zoom Scans. Rather, they are automatically derived from the bandwidths and Spans being used. CISPR Band E requires the most points to achieve the full band scan, but in all cases, total point quantity will not be allowed to exceed 75001. For manually coupled EMI Resolution BW, this hard limit on point quantity results in Span limitations (e.g., If the 9 kHz BW is used in CISPR band E, the hard point limit will cause the Span to be limited far short of the expected 17 GHz full range of CISPR band E).

NOTE

When selected, CISPR Band and Zoom Scan measurements use one of the 5 CISPR band frequency ranges to set the frequency range (Start and Stop) on the FieldFox. CISPR Zoom Scan selects a limited fix span (<entire band range). Learn more, see [“Resolution Bandwidth \(Res BW\)” on page 334](#) and [“How to set Frequency Range and Frequency Context” on page 327](#).

NOTE

Hint!

With any of the EMI measurement settings described in this section, you can toggle Zero Span and back (i.e., back to your previous measurement) using the “Zero / Last Span” softkey. Learn more, see [“How to set Frequency Range and Frequency Context” on page 327](#).

- Press **Measure 1** > **Measurement [Fast SA Scan]** then choose:
 - **Fast SA Scan** – (Default) Sets the Fast SA Scan. Fast SA Scan applies peak detection and is used to do a quick verification of your EMI measurement setup check using a normal SA speed sweep. **Pk** annotation is displayed when enabled.
 - **CISPR Band Scan** – Sets the primary EMI measurement which: sweeps over the specified CISPR band frequency range, uses CISPR defined specific EMI 6 dB Resolution bandwidths ((200 Hz, 9 kHz, and 120 kHz), and 1 MHz impulse bandwidth), with 3 specific detectors (Positive Peak, EMI Average, or Quasi Peak) which can be independently set per Trace. Individual trace annotation is displayed for the three traces (P, Q, and A). See also, [“How to set the EMI Traces” on page 336](#).
 - **CISPR Zoom Scan** – When set, behaves the same as CISPR Band Scan, except it represents the minimum Span setting, for any EMI resolution bandwidth selected, where the RF tuning can remain stationary (i.e., like Zero Span). While in CISPR Zoom Scan, you cannot change the Span, because it is meant to provide the fastest updates of the CISPR bandwidths and Detectors while targeting a specific RF frequency. Individual trace annotation is displayed for the three traces (P, Q, and A) and **ZSpan** is displayed in the lower right side of the display. See also, [“How to set the EMI Traces” on page 336](#).
 - **APD Statistics** – Sets a measurement that evaluates pulses statistically. APD statistics is essentially a Zero Span measurement of the Center Frequency. APD statistics uses a specific APD 6 dB resolution bandwidth (APD Res BW) to measure the power level detected while creating a histogram of those power levels over the **APD Dwell Time**. Next APD Statistics uses that histogram data to create a set of values to define that probability that the signal power is above a certain level (CCDF == complementary cumulative density function). The graphical axis changes radically, to reveal that

probability (i.e., a fraction from 0 to 1.0) on the Y axis, vs. Power on the X axis. Markers adapt correspondingly. **Histogram** and **CCDF** become the **Input** choices per trace, replacing **Detector** on the **Trace** menu. **APD** annotation is displayed on the left side when enabled. See also, “**Input – (Trace Input for APD Measurements)**” on page 339 and “**How to set the EMI Traces**” on page 336.

How to set a CISPR Band

By default, the preamp is OFF.

- Press **Measure 1** > **CISPR Band** then choose:
- **A – 9 kHz to 150 kHz**
- **B – 150 kHz to 30 MHz**
- **C – 30 MHz to 300 MHz** (Default)
- **D – 300 MHz to 1 GHz**
- **E – 1 GHz to 18 GHz**

Learn more, see “**Resolution Bandwidth (Res BW)**” on page 334.

Figure 12-1 CISPR Band C Example

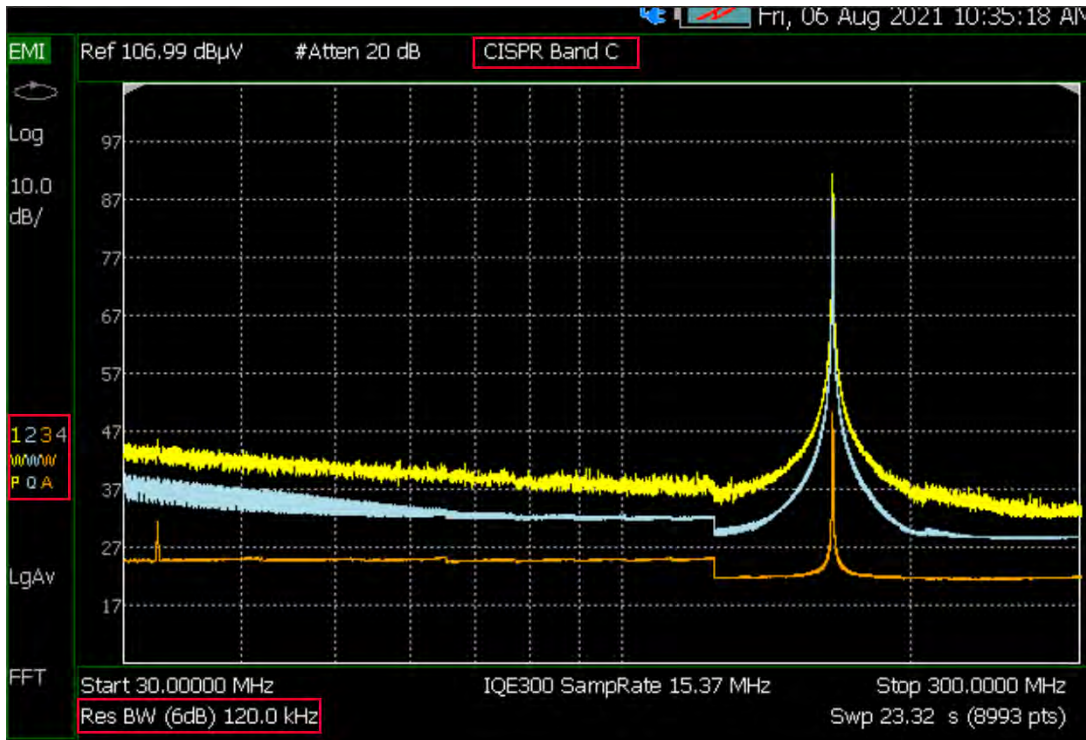

Figure 12-2 CISPR Band C Zoom Example 1 – Response to Pulse

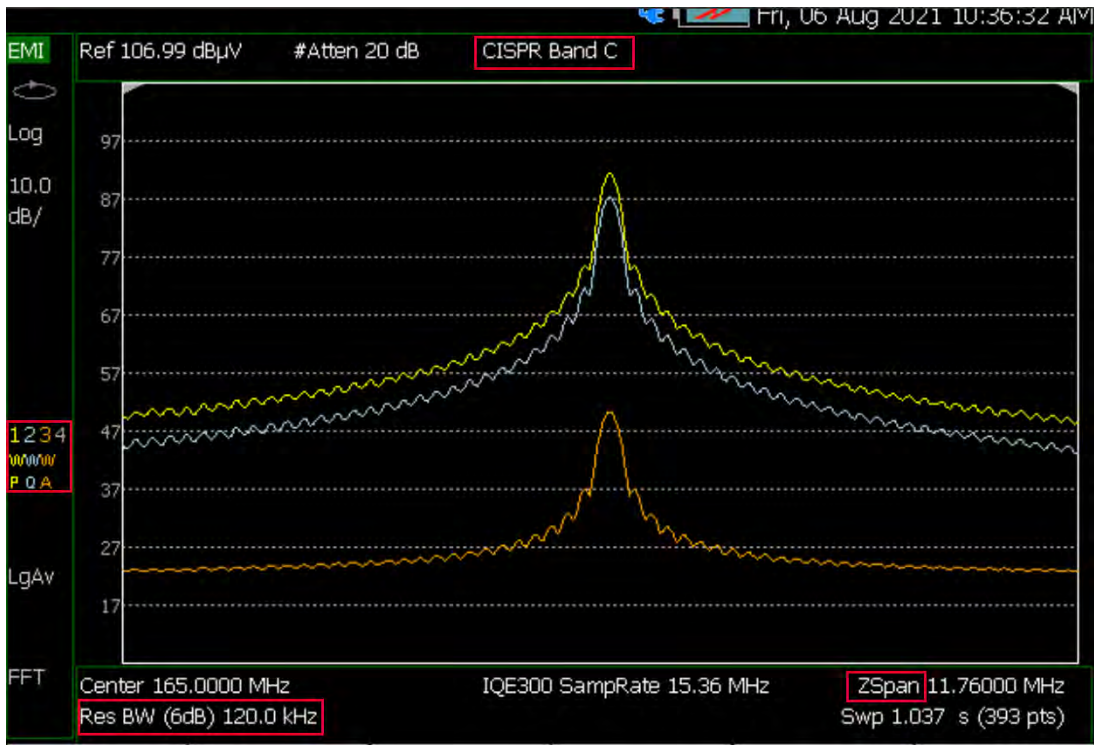

Figure 12-3 CISPR Band C Example 2 – Response to CW Signal

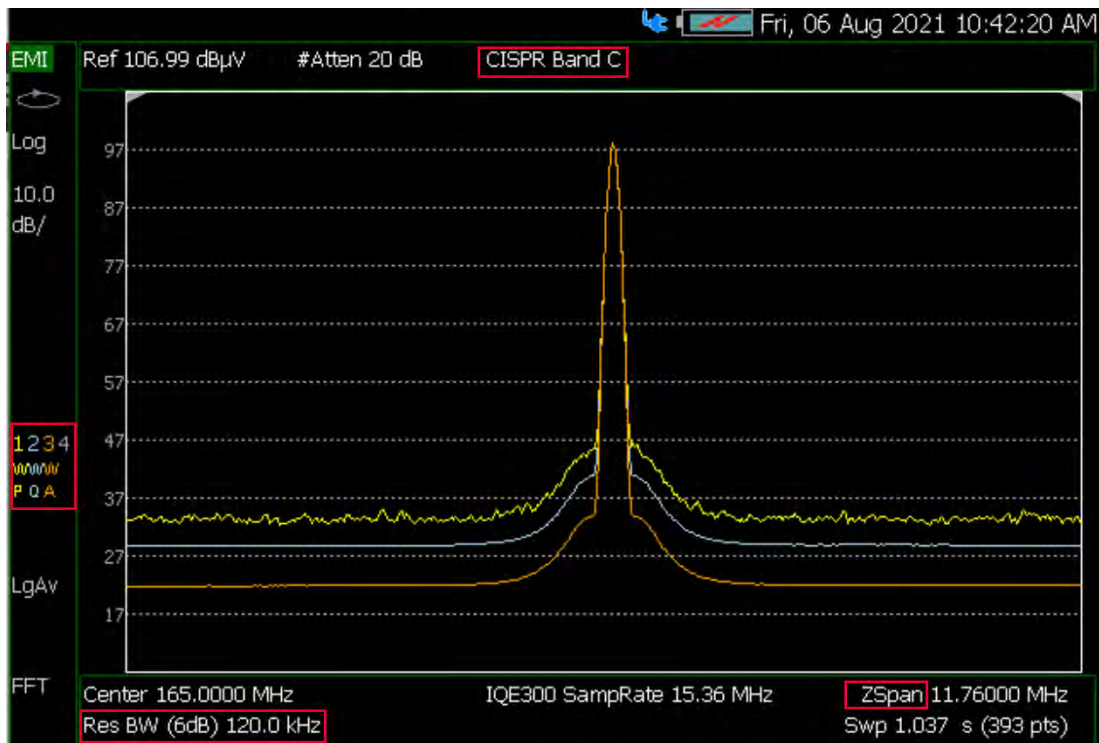

Figure 12-4 APD Statistics Example 1 – Pulse 5 μ S/1mS

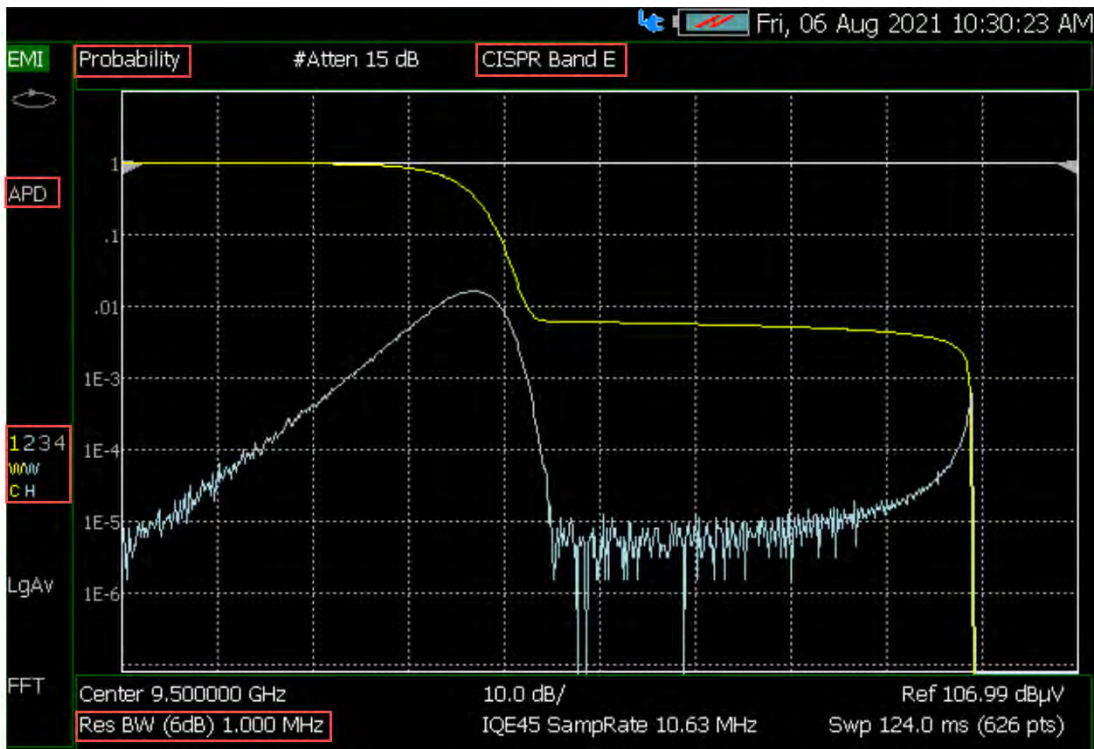
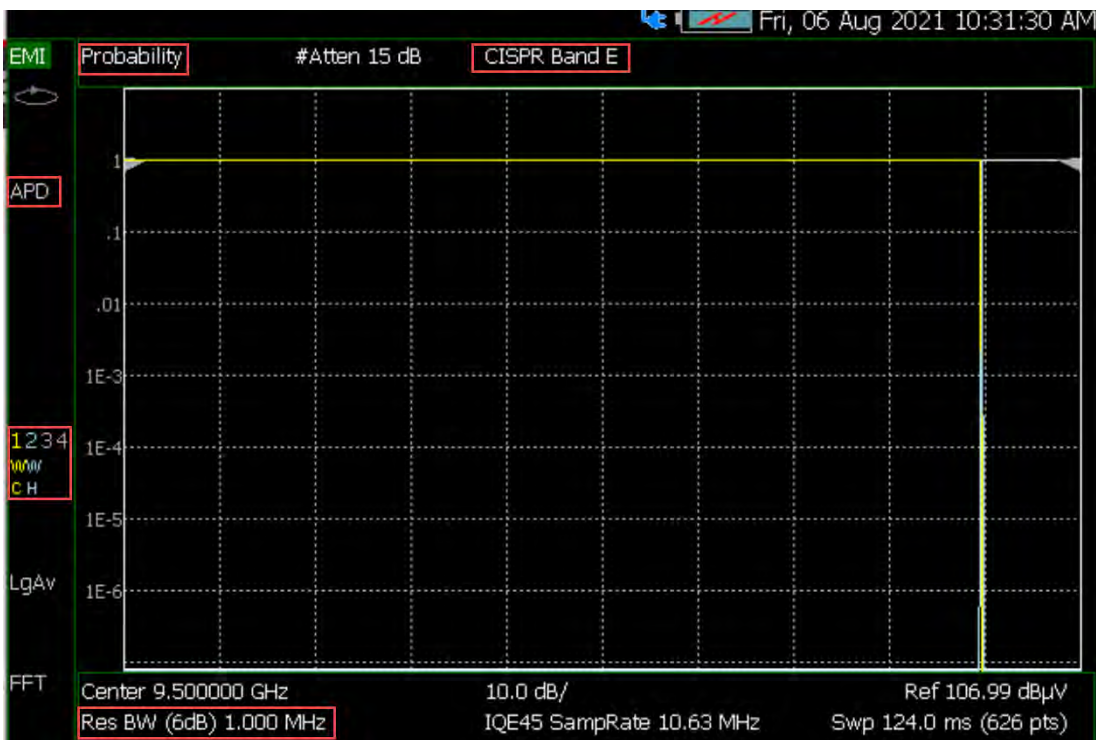

Figure 12-5 APD Statistics Example 2 – CW



Preamplifier Control (Opt 235)

Learn more, see [Chapter 9](#) refer to “[Preamplifier Control \(Opt 235\)](#)” on [page 171](#).

Resolution Bandwidth (Res BW)

EMI mode has a different resolution bandwidth type for each type of EMI measurement:

- **CISPR Band Scan**, **CISPR Zoom Scan**, and **APD Statistics** have of set values of 6 dB resolution bandwidths ((i.e., 200 Hz, 9 kHz, 120 kHz), and 1 MHz impulse bandwidth). “6 dB” is displayed in the Res BW value on the bottom left side of the display (e.g., **Res BW (6 dB) 120 kHz**).

CAUTION

The EMI Resolution bandwidth is auto-coupled to keep frequency range with the selected CISPR band. If the Start or Stop frequencies are changed, the FieldFox displays a reminder message about the CISPR band limits.

Example of CISPR messages: "CISPR band StartFreq limited to 30000000" and "CISPR band StopFreq limited to 300000000".

CISPR Band ^a	EMI 6 dB Resolution Bandwidth ^{d,e}	CISPR Band Scan Maximum Span Value ^{b,a,c}	CISPR Zoom Scan Minimum Span Value ^{d,e}
A – (9 Hz to 150 kHz)	200 Hz	3.735 MHz	19.6 kHz
B – (150 kHz to 30 MHz)	9 kHz	168.1 MHz	882 kHz
C – (30 MHz to 300 MHz)	120 kHz	2.243 GHz	3.96 MHz
D – (300 MHz to 1 GHz)	120 kHz	2.243 GHz	3.96 MHz
E – (1 GHz to 18 GHz)	1 MHz (impulse BW)	17.6 GHz	1.879 MHz

a. The maximum spans displayed in the CISPR Band table, are only achievable when one manually couples the resolution bandwidth (Res BW). Typically, the entire **CISPR Band** span (displayed in the first column) is used with auto-coupled resolution bandwidth (Res BW). The **CISPR Band Scan Maximum Span Values** (displayed in the third column) are actually the 75001 point limit applied to each resolution bandwidth (Res BW) when *manual coupling* (Manual) is used. When *manual coupling* (Manual) is used, you can go outside the selected CISPR Band.

b. The maximum number of points for a CISPR Band Scan is 75001 points.

c. The 75001 point limit is put in place, to keep the mode from trying to build traces that are any bigger than necessary. Basically, enough to cover CISPR Band E (1 GHz to 18 GHz) with its 1 MHz bandwidth, plus a little extra margin. This same point limit (75001) is applied to the other resolution bandwidths (Res BW), and also to the other **CISPR Band Scan Maximum Span Values** (displayed in the third column). There is no direct control permitted over the number of points used in the EMI scans. But, indirectly the SPAN and resolution bandwidth (Res BW) values, determine the number of points.

Exception: When using **Fast SA Scan** measurement (displayed in the fourth column), then you can control the number of points, similar to SA mode, where the point limit then becomes 20001.

- d. The Zoom scan span limits are associated with the **EMI 6 dB Resolution Bandwidth(s)** (Res BW (6 dB)) that are (displayed in the second column). The auto-coupled bandwidth choices match those CISPR Bands (displayed in the first column), but you can also choose to *manual couple* (Manual) the bandwidth. When the bandwidth is set to *manual couple* (Manual), the Zoom scan span limit follows the resolution bandwidth (Res BW), **not** the CISPR band.
- e. The Zoom scan span limits are actually the width of the FFT that is being used for the **EMI 6 dB Resolution Bandwidth** (minimum == 1 FFT, so the span is limited to 1 FFT width).
 - But, when using **Fast SA Scan**, you have a standard 3 dB resolution bandwidth over the entire range of 1 Hz to 5 MHz.

Learn more, see **Chapter 9** and then **“Resolution Bandwidth (Res BW)” on page 194.**

Single / Continuous / Restart

This setting determines whether the FieldFox measures continuously or only once each time the **Single** or **Run / Hold +/-** button is pressed. Use **Hold / Single** or to conserve battery power or to allow you to save or analyze a specific trace.

How to set Single or Continuous

- Press **Sweep 3**.
- Then choose one of the following:
 - **Continuous**
 - **ON** Causes the EMI to make continuous sweeps. This is the typical setting for making measurements. Each **Run / Hold +/-** press causes the SA to toggle between continuous sweep and Hold.
 - **OFF** Causes the EMI to Hold. Each **Run / Hold +/-** or **Single** press causes the SA to make ONE sweep, then Hold. The Hold annotation changes to an arrow --> while the sweep occurs.
 - **Single** Automatically sets Continuous OFF and causes the SA to make ONE sweep, then Hold.
 - **Restart** Resets the Average counter to 1. The Average counter also is used with MaxHold and MinHold Trace States.
 - **Dwell /Point** – (Active when the CISPR Measurement type == **CISPR Band Scan** or **CISPR Zoom Scan**.) Specifies a settling time (in seconds) between sweeps.
 - **SwpAcquisition** – (Active only for **Fast SA Scan**) Specifies a the number of sweep acquisitions. Press manual to enter a sweep acquisition value. (Default = Auto). Learn more, see **Chapter 9** and then **“Sweep Acquisition” on page 199.**

- **APD Dwell Time** – (Active only when the CISPR Measurement type = **APD Statistics**.) Sets the time to acquire statistics each cycle, and Trace Points (control grayed out) are derived from the total Amplitude range displayed on the X axis.

Points

In the EMI measurements mode, the Points softkey is only active when the Measurement CISPR softkey is set to **Fast SA Scan**. Otherwise EMI mode automatically sets the points (Default = 401). Learn more, see **Chapter 9** and then **“Points” on page 208**.

Trace Display States (EMI Mode)

NOTE

For EMI measurements mode this section defines the four trace state choices for the Fast SA Scan and for CISPR Band Scan, CISPR Zoom Scan, and APD Statistics choices, it defines the 4th trace display state choices. Learn more, see **“How to set the EMI Traces” on page 336**.

The behavior of EMI mode is similar to SA mode. This section describes the softkeys that have similar, but also different behaviors than SA mode. Learn more, refer to **Chapter 9, “SA (Spectrum Analyzer) Mode (Option 233–Mixed Analyzers)”**. See also **“Marker Trace (IQA and SA Mode)” on page 696**.

How to display the Trace States

- Press **Trace 6** > **Default All** is measurement specific and returns all traces to their default settings. For EMI mode the defaults are: Trace 1 (PosPeak T1), Trace 2 (QuasiPeak T2), Trace 3 (EMI Average T3); Trace 4 (Off, but defaults to Pos Peak).

How to set the EMI Traces

When the EMI measurement type is set to **CISPR Band Scan** or **CISPR Zoom Scan** Trace 1, Trace 2, Trace 3 have default values assigned. The trace can be disabled under the **Measure 1** (toggle to enable/disable) or the **Trace 6** hardkeys or re-assigned to measure a different value on the trace by using the **Trace 6** hardkey (e.g., you can re-assign trace 1 to measure Quasi-peak or EMI averaging). These detector choices are inactive when the EMI measurement type is set to, Fast SA Scan or APD Statistics. (i.e., APD statistics does not use detection; it uses inputs. Refer to **“Measure 1 Hardkey – EMI ‘Convenience’ Softkeys” on page 337** and **“Input – (Trace Input for APD Measurements)” on page 339**).

Learn more, see [“How to Set the EMI Measurement Settings \(Fast SA Scan, CISPR Band Scan, CISPR Zoom Scan, and APD Statistics\)”](#) on page 329.

NOTE

These softkeys are inactive when the EMI measurement choices are Fast SA Scan or APD Statistics. Learn more, see [“Input – \(Trace Input for APD Measurements\)”](#) on page 339.

Measure 1 Hardkey – EMI ‘Convenience’ Softkeys

NOTE

IMPORTANT!

When you press the **Measure 1** hardkey a softkey menu is displayed and has, as a convenience, fixed values for Trace 1 (PosPeak T1), Trace 2 (QuasiPeak T2), Trace 3 (EMIAverage T3) assigned. While the softkey labels cannot be re-assigned, the trace values can be changed manually under the **Traces 6** hardkey using the **Detector** softkey. Learn more, refer to [“How to set Detection Method”](#) on page 338.

-
- Press **Measure 1** then choose:
 - **PosPeak T1** – Enable/Disable trace 1 to display positive peak data and retains the peak value of a signal, indicating the worst-case summary data (Default = on). **P** annotation is displayed. This softkey is inactive, when APD Statics is ON.
 - **QuasiPeak T2** – Enable/Disable trace 2 to display quasi-Peak data that weighs each component based on its repetition rate: the faster repetition rate, the higher the weight given to that component (Default = on). **Q** annotation is displayed. This softkey is inactive, when APD Statics is ON.
 - **EMIAverage T3** – Enable/Disable trace 3 to display EMI average data displays the average amplitude of each signal component across its period (Default = on). **A** annotation is displayed. This softkey is inactive, when APD Statics is ON and or CISPR Band E is selected.

Trace Averaging

Within EMI mode, the detectors provide the critical necessary averaging (i.e., EMI Average and Quasi Peak), but similar to SA mode, if needed, you can perform Trace Averaging. Refer to [“Average Type”](#) on page 209 and [“Average Count”](#) on page 210 in Chapter 9, [“SA \(Spectrum Analyzer\) Mode \(Option 233–Mixed Analyzers\).”](#)

Alignments

EMI measurements mode uses amplitude alignment and channel equalization. Learn more, refer to the SA chapter’s [“Alignments”](#) on page 211 for information on all alignments.

Detection Method

Using the EMI feature, can have one of three specific independent detection methods: **Fast SA Scan**, is similar to the original detection method used in SA mode that can use only one detector. **CISPR Band Scan** and **CISPR Zoom Scan** use a newer detection method that uses one detector per trace (e.g., up to three detectors and three traces simultaneously). Learn more, refer to [“Trace Display States \(EMI Mode\)” on page 336](#).

APD Statistics uses trace inputs in lieu of detection. Learn more, refer to [“Input – \(Trace Input for APD Measurements\)” on page 339](#).

How to set Detection Method

The current Detection method for each trace is labeled on the left edge of the screen. A corresponding letter appears below the corresponding Trace number selected. For example: **P** means that **Positive Peak** was the selected detector.

- Press **Trace 6** > **Detector**
- Then choose from the following:

The following softkeys are only available when **CISPR Band** is set to **Fast SA Scan**:

- **Auto** Displays the most appropriate Detection method based on other settings. [**# is NOT shown**]
- **Normal** [**#Nrm** also referred to as Rosenfell] Provides a better visual display of random noise than **Positive peak** and avoids the missed-signal problem of the **Sample** Mode. Should the signal both rise and fall within the bucket interval, then the algorithm classifies the signal as noise. An odd-numbered data point displays the maximum value encountered during its bucket. An even-numbered data point displays the minimum value encountered during its bucket. If the signal is NOT classified as noise (does NOT rise and fall) then Normal is equivalent to Positive Peak.
- **Negative Peak** [**#NPK**] Displays the minimum value of all the measurements in each bucket.
- **Sample** [**#Smp**] Displays the center measurement of all the energy detected in each bucket. This setting gives a good representation of the random noise in each bucket. However, it does not ensure that all signals are represented.
- **Average** [**#RMS**] Displays the Root Mean Squared (RMS) average power of all the measurements in each bucket. This is the preferred method when making power measurements.

The following softkey is available for most **CISPR Band** choices, but **not** APD Statistics:

- **Positive Peak [P]** Displays the maximum value of all the measurements in each bucket. This setting ensures that no signal is missed. However, it is not a good representation of the random noise in each bucket.

The following softkeys are only available when the **CISPR Band** softkey is set to **CISPR Band Scan** scan or **CISPR Band Zoom Scan**.

- **Quasi Peak [Q]** Displays the quasi-peak response, as defined by CISPR 16.
- **EMI Average [A]** Displays the Root Mean Squared (RMS) average power of all the EMI measurements in each bucket. This is the preferred method when making power measurements.

Repeat the detection setup process as needed for up to 4 traces and 3 detection methods.

Input – (Trace Input for APD Measurements)

This softkey is active when **APD Statistics** is the selected CISPR Measurement. See also, “**CISPR (International Special Committee on Radio Interference) Control**” on page 329.

- Press **Trace 6** > **Input** – Selects the type of data type that is used to display the APD statistics trace based on the APD Dwell Time. Then choose:
 - **CCDF** – A CCDF curve shows how much time the signal spends at or above a given power level. The power level is expressed in dB relative to the average power. The percentage of time a signal spends at or above each line defines the probability for that particular power level. A CCDF curve is a plot of relative power levels versus probability.
 - **Histogram** – Displays the power levels detected over the APD Dwell Time.

About Electromagnetic Interference (EMI) Measurements

EMI mode enables you to make the following types measurements:

- Radiated – wireless EMI signals
- Conducted emissions from wires or other conducted paths.

Some measurement parameters are auto-coupled and are not user-settable.

EMI Measurement Features (Option 361)

CAUTION

The EMI Resolution bandwidth is auto-coupled to keep frequency range with the selected CISPR band. If the Start or Stop frequencies are changed, the FieldFox displays a reminder message about the CISPR band limits.

Example of CISPR messages: "CISPR band StartFreq limited to 30000000" and "CISPR band StopFreq limited to 300000000".

NOTE

In the CISPR Band Scan measurement, the Span can be changed. (Exception: CISPR Zoom Scan cannot change the Span.) As the SPAN changes, the resultant trace point quantity also changes proportionally, since every FFT spectral sample measured undergoes detection by the FieldFox firmware and becomes part of the trace (Maximum points == 75001). Learn more, see [“CISPR \(International Special Committee on Radio Interference\) Control” on page 329](#).

NOTE

When selected, CISPR Band and Zoom Scan measurements use one of the 5 CISPR band frequency ranges to set the frequency range (Start and Stop) on the FieldFox. CISPR Zoom Scan selects a limited fix span (<entire band range). Learn more, see [“Resolution Bandwidth \(Res BW\)” on page 334](#) and [“How to set Frequency Range and Frequency Context” on page 327](#).

NOTE

Hint!

With any of the EMI measurement settings described in this section, you can toggle Zero Span and back (i.e., back to your previous measurement) using the “Zero / Last Span” softkey. Learn more, see [“How to set Frequency Range and Frequency Context” on page 327](#).

NOTE

For EMI measurements mode this section defines the four trace state choices for the Fast SA Scan trace display states and for CISPR Band Scan, CISPR Zoom Scan, and APD Statistics choices, it defines the 4th trace display state choices. Learn more, see [“How to set the EMI Traces” on page 336](#).

EMI has the following features:

EMI Measurement Results:

- Amplitude Probability Distribution Statistics (APD)
 - Histogram
 - CCDF traces displayed

Electromagnetic Interference (EMI) Measurements – Option 361
About Electromagnetic Interference (EMI) Measurements

- Center frequency (active with APD Statistics)
- Selectable CISPR Bands (A, B, C, D, or E)
 - Positive Peak trace (active with APD Statistics OFF)
 - Quasi-Peak trace (active with APD Statistics OFF)
 - EMI Average trace (active with APD Statistics OFF)
- 200 Hz, 9 kHz, 120 kHz 6 dB resolution bandwidths, and 1 MHz impulse bandwidth
- Frequency bands can be coupled to CISPR bands
- Logarithmic frequency axis

Refer to **“EMI Measurement Mode Setup Procedure”** on page 343.

How to Set Up Electromagnetic Interference (EMI) Mode Settings

NOTE

IMPORTANT! See also, “Alignments” on page 211, in NA mode, Chapter 9, “SA (Spectrum Analyzer) Mode (Option 233–Mixed Analyzers).”

This section reviews the steps in setting up an example EMI measurement. If you are not familiar with this process or would like more information, refer to “Using EMI Measurements (Option 361)” on page 325.

EMI Measurement Mode Setup Procedure

1. Selecting EMI Measurement mode:

Press **Mode** > **More** (Depends on number of Options) > **EMI Measurements**

2. Setting the EMI Measurement type:

For this example, press **Measure 1** > **Measurement** > **CISPR Band Scan**

- The display updates to show three traces: PosPeak T1 (**P**), QuasiPeak T2 (**Q**), and EmiAverageT3 (**A**). Learn more, see “CISPR (International Special Committee on Radio Interference) Control” on page 329.

3. Setting the CISPR Band:

For **CISPR Band Scan**, these traces become active and begin sweeping. But, for this example, press **PosPeak T1**, **QuasiPeak T2**, or **EmiAverage T3** to enable/disable each detector/trace. (default = all on.)

Learn more, see “How to set the EMI Traces” on page 336.

4. Setting the EMI detectors for each trace:

For this example, press **CISPR Band** > **C 30 – 300 MHz** (default).

CAUTION

The EMI Resolution bandwidth is auto-coupled to keep frequency range with the selected CISPR band. If the Start or Stop frequencies are changed, the FieldFox displays a reminder message about the CISPR band limits.

Example of CISPR message: "CISPR band StartFreq limited to 30000000" and "CISPR band StopFreq limited to 300000000".

Learn more, see “How to set a CISPR Band” on page 331.

5. Setting the Log Freq AxisX state for the displayed trace:

For this example, press **Log Freq AxisX** > **ON** (default). Press to **OFF** to change display to linear view.

Learn more, see “How to set Frequency Range and Frequency Context” on page 327.

6. Setting the EMI resolution bandwidth state for the displayed trace:

For this example, press **EMI Res BW** > **Manual** (default = Auto). 120 kHz is displayed, but other **fixed** resolution bandwidths can be set (i.e., 200 Hz, 9 kHz, and 1 MHz).

Learn more, see **“Resolution Bandwidth (Res BW)” on page 334.**

7. Setting the Dwell Time:

For this example, press **Sweep 3** > **Dwell Time** > 100 ms (default)

Glossary (EMI)

This section provides a description of some of the terms used in the FieldFox’s EMI mode.

Table 12-1 EMI Abbreviations and Descriptions

Abbreviation	Description
APD Statistics	Amplitude Probability Distribution Statistics – Evaluates pulses statistically. Measurement done in zero span, at the specified center frequency, with a specific APD dB resolution bandwidth.
– CCDF	Complementary Cumulative Density Function – The probability of the signal power being above a certain level generated from the APD statistics’ histogram results.
– Histogram	Results of the APD statistics measurement and the power levels detected over the APD specified dwell time used to generate a CCDF results.
CISPR	International Special Committee on Radio Interference

13 Over-the-Air Measurements (OTA) – LTE FDD Option 370, LTE TDD Option 371, 5GTF Option 377 (CPU2 Only)

OTA mode measures signals at the **SA RF Input Port 2** connector.

OTA mode requires the FieldFox to have SA mode (Option 233 on combination analyzers), GPS (Option 307), and CPU2 installed.

Recommended, but not required, preamplifier (Option 235) to improve receiver sensitivity.

With Options 370 (LTE FDD), 372 (LTE TDD), 377 (5GTF), network designers can ensure that networks have enough resources to carry out handovers (re-selection) when users move between cell towers on the same 5G network as well as in between 5G and 4G networks (intra/inter-radio access technology).

The FieldFox OTA measurements support LTE FDD (Option 370), LTE TDD (Option 371), and Verizon 5G TF (Option 377) over-the-air demodulation of single acquisition, multiple cell towers, or multiple acquisitions for multiple component carriers (CCs). The FieldFox display can be configured to show data formats such as table, bar chart, spectrum and strip chart of key performance indicators (KPI's).

By integrating over-the-air (OTA) measurements with cable and antenna test (CAT), full 2-port vector network analysis, spectrum analysis, and real-time spectrum analysis (RTSA), the FieldFox can be used for base station setup and verification.

In this Chapter

“Using OTA (Options 370 – LTE FDD, 372 – TDD, and 377 – 5GTF)” on page 347

“About Over-the-Air (OTA) Measurements” on page 348

- “LTE FDD and LTE TDD Features (Option 370 and Option 371)” on page 348

- “5G TF Features (Option 377)” on page 352

“How to Set Up Over-the-Air (OTA) Mode Settings” on page 354

- “OTA Setup Procedure” on page 354

- “Optional: Using RTSA to verify the signal quality (Requires Option 350 and Preamp Option 235)” on page 367

- “How to Define a Cell or Cell(s) and Use OTA” on page 368

“How to Use Data Logging (OTA Options 370, 372, and 377)” on page 387

- “Screen Annotation” on page 387

- “How to Record a Data Log Procedure” on page 388

- “To change Data Logging Configuration settings:” on page 388

- “How to Play a Data Log” on page 390

“Other Features Available” on page 391

- Alignments (SA chapter) – “Alignments” on page 211

- External Gain (SA chapter) – “External Gain” on page 169

“Troubleshooting” on page 392

“Glossary (OTA)” on page 393

See Also

“Why and When to Calibrate” on page 134

Chapter 30, “System Settings.” (Changing display colors)

Chapter 32, “File Management.”

Using OTA (Options 370 – LTE FDD, 372 – TDD, and 377 – 5GTF)

OTA enables you to do the following:

Measure and display one component carrier (CC) with multiple cells or multiple cells with multiple component carriers (CCs)^{ab}

Four Display Types:

- Bar chart (color coded based on the selected scheme CC | PCC | Level)
- Strip Chart
- Table
- Spectrum

Color Coded Display Types:

- Specify high and low power with color bars

Flexible Data Sorting:

- LTE FDD: Sort Cells, component carriers (CCs), Frequency, RSRP, RSRQ, RSSI, PSS, SSS, and SINR scan results displayed by low to high, or high to low, or Auto (no order is involved)
- 5GTF: Sort Carrier Info, PCI (aka Cell IDs), Power, PSS, SSS, Sync Correlation (%) scan results displayed by low to high, or high to low, or Auto (no order is involved)
- LTE TDD: Sort Cells, component carriers (CCs), Frequency, RSRP, RSRQ, RSSI, PSS, SSS, and SINR scan results displayed by low to high, or high to low, or Auto (no order is involved)

Data Logging. Record GPS stamped data measurements

- Define measurement interval by time or distance
- Display files (KML) on Google Maps or Google Earth
- Show results in Table or Bar Chart

- a. When multiple component carriers are selected, the results of the component carrier (CC) with the highest power is displayed.
- b. LTE FDD and LTE TDD can measure and display multiple cells. 5GTF only has the ability to measure and display a single cell.

About Over-the-Air (OTA) Measurements

OTA mode supports these standards:

- LTE FDD
- LTE TDD
- 5GTF measurements

Some measurement parameters are auto-coupled and are not user-settable.

LTE FDD and LTE TDD Features (Option 370 and Option 371)

NOTE

IMPORTANT! LTE FDD, LTE TDD, and 5GTF only demodulate PSS and SSS signals using the FieldFox's 10 MHz demodulation path. User data channels are **not** demodulated.

LTE FDD and LTE TDD have the following features:

NOTE

IMPORTANT! LTE FDD and LTE TDD generally have similar cell features, but the Band and Channel choices are different for the Channel Table settings.

Cell Scan Results:

- Center frequency
- Physical Cell Information (PCI) – (Cell ID) – (C/S/G)
- RSRP (Reference Signal Received Power) (dBm)
- RSRQ (Reference Signal Received Quality) (dB)
- RSSI (Reference Signal Strength Indicator) (dBm)
- PSS (Primary Synchronization Signal) (dBm)
- SSS (Secondary Synchronization Signal) (dBm)
- SINR (Signal to Interference & Noise Ratio) (dB)
- Frequency error (Hz)

Data Formats:

User can set up and display 1, 2, 3 or 4 simultaneous measurements of key performance indicators (KPI's) for any component carrier (CC0 through CC4), up to 5 carriers, in any combination of the following:

- Table – Cell scan numeric results (for up to 6 cell sites (CCs) including Physical Channel Information (PCI) – (Cell ID), RSRP, RSRQ, RSSI, PSS, SSS, SINR, Freq Err.

Over-the-Air Measurements (OTA) – LTE FDD Option 370, LTE TDD Option 371, 5GTF Option 377 (CPU2 Only)

About Over-the-Air (OTA) Measurements

- Bar Chart – Vertical power bar graph of selectable cell scan result metric for up to 6 cell sites with adjustable color “heat” amplitude scale. And, color coded based on the selected scheme (i.e., CC, PCC, and Level).
- Spectrum – Magnitude spectrum frequency domain (fixed span). You can only view a single component carrier at a time with Spectrum (e.g., CC0 or CC2, etcetera).
- Strip Chart – Magnitude of selectable cell scan result metric graphed over time

Figure 13-1 Example of the LTE FDD with Four Multiple Display Options – (LTE TDD is similar)

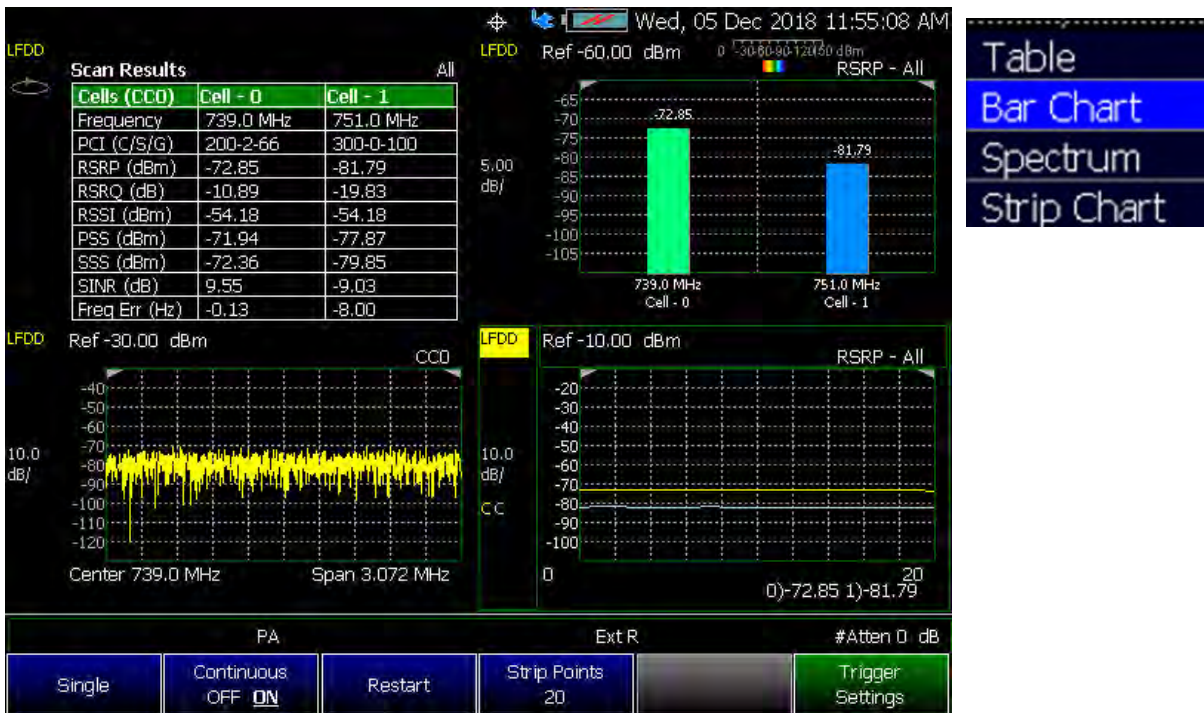

Figure 13-2 LTE FDD Bar Chart – CC Example



Figure 13-3 LTE FDD Bar Chart – PCC Example

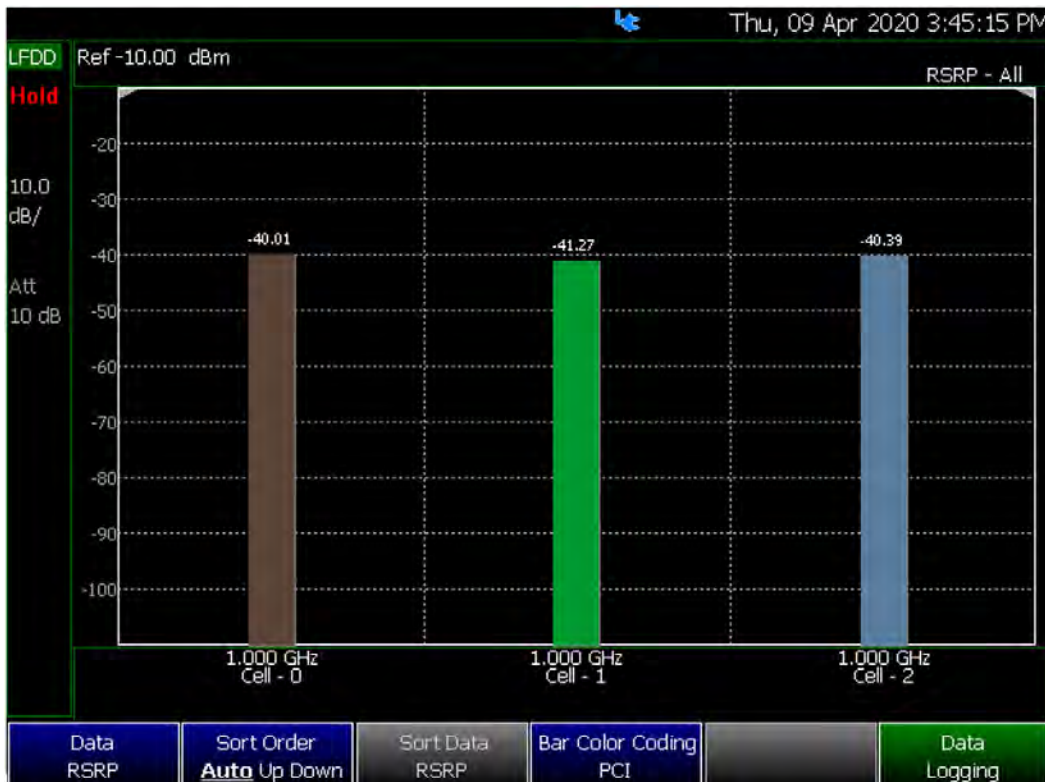
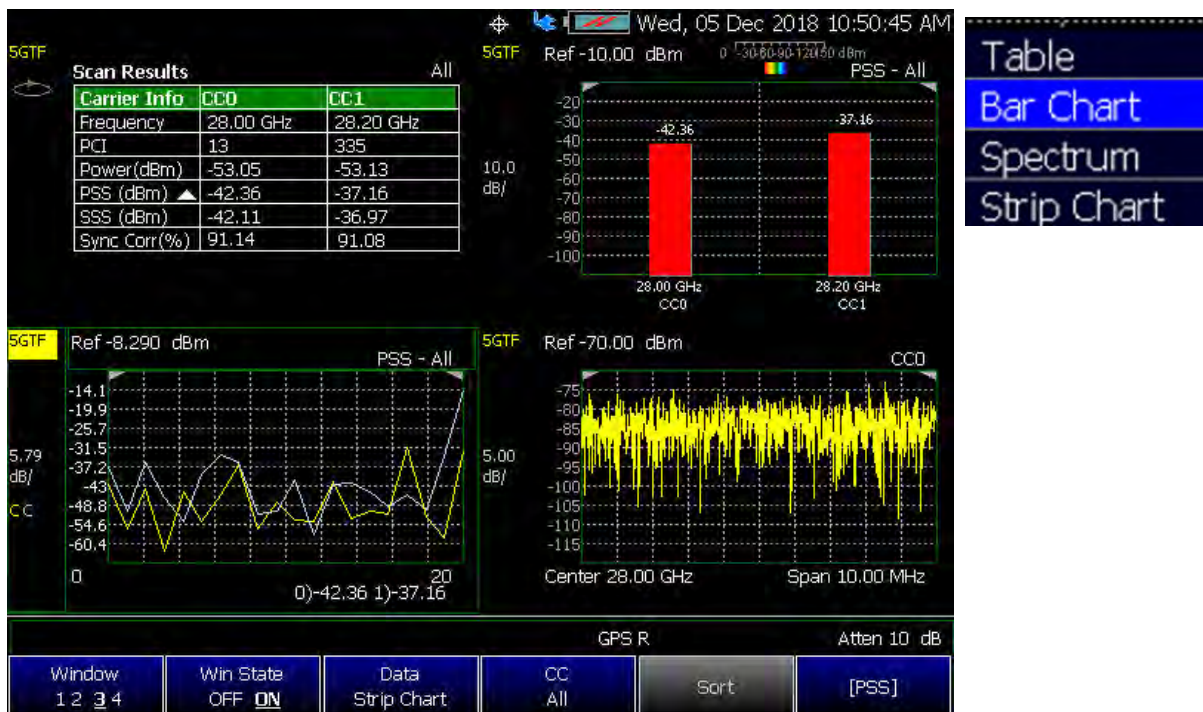

Figure 13-4 LTE FDD Bar Chart – Level Example



Figure 13-5 Example of the 5GTF with Four Multiple Display Options



5G TF Features (Option 377)

NOTE

IMPORTANT! LTE FDD, LTE TDD, and 5GTF only demodulate PSS and SSS signals using the FieldFox's 10 MHz demodulation path. User data channels are **not** demodulated.

5G TF has the following features:

Cell Scan Results:

- Center frequency
- Physical Cell Information (PCI) – (Cell ID)
- Power (Channel Power) (dBm)
- PSS (Primary Synchronization Signal) (dBm)
- SSS (Secondary Synchronization Signal) (dBm)
- Sync correlation (%)

Data Formats:

User can set up and display 1, 2, 3 or 4 simultaneous measurements of key performance indicators (KPI's) for any component carrier (CC0 through CC7), up to 8 carriers, in any combination of the following:

- Table – Cell scan numeric results (for up to 6 cell sites (ID's) including Cell ID, Channel Power, PSS, SSS, Sync Corr
- Bar Chart – Vertical power bar graph of selectable cell scan result metric for up to 8 cell sites with adjustable color “heat” amplitude scale
- Spectrum – Magnitude spectrum frequency domain (fixed span). You can only view a single component carrier at a time with Spectrum (e.g., CC0 or CC2, etcetera).
- Strip Chart – Magnitude of selectable cell scan result metric graphed over time

Figure 13-6 Example of 5GTF Single Carrier and Single Cell



How to Set Up Over-the-Air (OTA) Mode Settings

NOTE

IMPORTANT! See also, “Alignments” on page 211, in NA mode, Chapter 9, “SA (Spectrum Analyzer) Mode (Option 233–Mixed Analyzers),” and Chapter 10, “RTSA (Real-Time Spectrum Analyzer) Mode–Option 350 (CPU2 Only)” mode.

NOTE

The FieldFox can be used with an OML frequency extender. Refer to “Utilities” on page 724, the A Series FieldFox Configuration Guide 5990-9836EN, and to “Contacting Keysight” on page 5.

This section reviews the steps in setting up an OTA measurement. If you are not familiar with this process or would like more information, refer to “How to Define a Cell or Cell(s) and Use OTA”

This section consists of:

- “OTA Setup Procedure”
- “Optional: Using RTSA to verify the signal quality (Requires Option 350 and Preamp Option 235)”

OTA Setup Procedure

1. Modifying the Frequency Reference and GPS settings:

Press **System**

- Then **System Configuration** > **GNSS (GPS+)** > **GNSS Receiver** > **Internal** > **Esc**

- The left portion of the screen displays satellites and the corresponding number on the adjacent Satellite Power chart.
- The right portion of the screen displays Satellite Power Carrier to Noise (C/No) dBHz values on the tops of the satellite power chart.

- Then **System** > **System Configuration** > **Frequency Ref** > **Freq Ref Source [GPS]** > **Back**

NOTE

IMPORTANT! It is **not** sufficient to be locked to the GNSS satellite, the frequency reference must be locked to GPS.

Refer to “Example of the LTE FDD Scan Results Table (Five CCs and one cell) – LTE TDD is similar” on page 364.

And, refer to “Example of the 5G TF Scan Results Table (Two cc and one cell)” on page 364.

See also [“GNSS \(GPS+\) and GPS” on page 749](#).

2. Selecting OTA mode:

- Press **Mode**.
- Then **More** (may not be available—number of installed options dependent)
- Then **OTA**.

3. Selecting LTE FDD or 5GTF:

Press **Measure** – (When you initially select OTA mode, the FieldFox defaults to the Measure menu.)

- The Measure menu is used to select an OTA format (i.e., Option 370 LTE FDD, Option 371 LTE TDD, or Option 377 5GTF):
 - **LTE FDD** (default) or
 - **LTE TDD**
 - **5GTF**

The OTA format chosen begins scanning for signals. Additional FieldFox setting changes are required for OTA to display the available signals. Refer to the steps below and see also, [“How to Define a Cell or Cell\(s\) and Use OTA” on page 368](#).

4. Define some carrier and cell measurement information. See also, [“How to Define a Cell or Cell\(s\) and Use OTA”](#).

Then modify the carrier and cells based on the selected OTA technology (i.e., LTE FDD, LTE TDD, or 5GTF).

NOTE

If after making the setting changes in the steps below, no data is displayed, refer to [“Troubleshooting” on page 392](#).

Display does not update (refresh), until all active component carriers (CCs) have been scanned.

5. Press **Freq/Dist**

- Then **CC** (select component carriers)
 - **CC0**, **CC1**, **CC2**, **CC3**, or **CC4** (i.e., 5GTF has up to eight component carrier choices (**CC5**, **CC6**, and **CC7**)). If only one CC is selected, the FieldFox will not allow you to disable the scan. See also, the **Trace** hardkey in step 7.
- Then **Enabled ON** (Default is ON) – Enables/disables the CC scan results. If only one CC is selected, the FieldFox will not allow you to disable the scan

- Then **Center** – You can enter a frequency or for LTE FDD/LTE TDD (only), you can use the **Channel Table** softkey menu to enter an auto-coupled Center frequency (see LTE FDD and LTE TDD Channel Table softkey menu below).

6. **Optional (Option 370 LTE FDD and Option 371 LTE TDD Only):** Press **Freq/Dist** > **Freq Mode** > **Chan**

This changes the Center frequency value.

Press **Channel Table** opens a softkey menu, where you can select define your carrier, by Band and Channel. The Center frequency value is auto-coupled to the Band/Channel entered.

Option 370 LTE FDD and Option 371 LTE TDD Only:

- Then **Band** > n > **Enter**
(The **Channel**, **Band**, and the **Center** values are auto-coupled.)

NOTE

Band and Channel values vary between LTE FDD and LTE TDD.

- Then **Favorites List** (Option 370 LTE FDD and Option 371 LTE TDD Only) opens a softkey menu, where you can save your current Band and Channel setup.
 - Then **Setup 1** In the Favorites list softkey menu, the softkey displays the current Band and Channel displayed (e.g., **Setup 1 3,1200**). Select the Favorites List softkey again to observe the updated Setup 1 softkey.
 - Then **Back**

7. Select **Trace 6**—choose:

- **Window 1 2 3 4**
- Then **Win State OFF ON** to **ON**
- Then **Display Type**
 - **Table** or
 - **Bar Chart** or
 - **Spectrum** or

- [Strip Chart](#)

NOTE

The Spectrum view in 5GTF uses a center frequency that is +2.6 MHz offset from the carrier's center frequency. This is done so that FieldFox can capture the necessary xPBCH (physical broadcast channel) information to demodulate the signal. Be aware that all of the instrument's displayed numbers are rounded to three significant digits (e.g., 5.0026 GHz is displayed as 5.003 GHz).

- Then [CC](#) (select component carriers)
 - [All](#) (Not applicable for Spectrum. When **All** is specified, for Spectrum, the FieldFox defaults to CC0) or
 - [CC0](#), [CC1](#), [CC2](#), [CC3](#), or [CC4](#) (i.e., 5G TF and 5G NR have up to eight component carrier choices ([CC5](#), [CC6](#), and [CC7](#)))

Repeat process as needed for additional Windows, Data, and CC settings.

NOTE

IMPORTANT! When you select a multiple CCs (e.g., CC0, CC1, etcetera) and record data, you may actually see other cell signals that do not have sufficient power to be displayed, but are still detectable. When multiple component carriers are selected, the results of the component carrier (CC) with the highest power are displayed. Refer to [Figure 13-7 on page 363](#).

8. All OTA Options: Press [Trace 6](#) > [More](#)

- Then [Data RSRP](#) – Then select the data type:
 - LTE FDD and LTE TDD: RSRP, RSRQ, RSSI, SINR, PSS, SSS (Default = RSRP).
 - 5G TF: PSS, SSS or Power (Default = PSS).
- Then [Sort Order](#) and choose [Up](#) or [Down](#) (Default: Auto). Refer to [“About Over-the-Air \(OTA\) Measurements” on page 348](#). This softkey is inactive when **Sort Order** is set to **Auto**.
- Then [Sort Data RSRP](#) – Then select the type of data to be sorted:
 - LTE FDD and LTE TDD: RSRP, RSRQ, RSSI, SINR, PSS, SSS, Freq Error.
 - 5G TF: PSS, SSS, Power, Sync Corr.
- Then [Data Logging](#) – to record data. Refer to [“How to Use Data Logging \(OTA Options 370, 372, and 377\)” on page 387](#).

9. Optional: [Display Type Table](#) – Different softkey menus are displayed for the four different Display Types: **Table** (default), **Bar Chart**, **Spectrum**, and **Strip Chart**:

- a. Optional (When Display Type = **Table** or the **More** softkey is pressed for the other Display Types): Modify RF attenuator, Preamp, and other settings:

If Display Type = **Table**, then press **Scale/Amptd** or

If Display Type = **Bar Chart**, **Spectrum**, or **Strip Chart**, then press **More**, if

Then press the following:

- **RF Atten** to set the attenuator power (default: –10 dB). Set to **0 dB**.
- **Preamp** change to **ON**.
- **Range** to set the absolute power (dBm)
- Others (optional): **External Gain**

- b. Optional (When Display Type = **Bar Chart**): Modify scale and specify color bar limit values—Modify the bar chart display color coding scheme for the power channels (bars):

Press **Trace** > **More** > **Bar Color Coding**

Then one of the following:

- **CC** to set the CC (Component Carrier) associated with each bar.
- **PCI** to set the PCI (Physical Cell Identifier) associated with each bar.
- **Level** to set the level of the value associated with each bar.

When level is selected, you can set the channels' red and blue power level limits with the **Scale/Amptd** softkeys:

Press **Scale/Amptd**

Then one of the following:

- **Red Limit** to set the power level and color scale for high power channels.
- **Blue Limit** to set the power level and color scale for low power channels.
- Others: **Scale**, **Ref Level**, etcetera as desired.
- **More** opens a menu of softkeys that are the same as those that are defined when the Display Type = **Table**.
- Others (optional): **Autoscale**

- c. Optional (When Display Type = **Spectrum**): Modify RF attenuator, Preamp, and other settings:

Press **Scale/Amptd**

Then press the following:

- **Ref Pos** Manually set the position of the reference line. Values must be between 0 (TOP line) and 10 (BOTTOM line).
- **Scale** Manually enter a **scale per division** to view specific areas of the trace.
- **Ref Level** Manually set the value of the reference line. Enter a negative value by pressing **Run/Hold (+/-)** either before or after typing a value.
- **More** opens a menu of softkeys that are the same as those that are defined when the Display Type = **Table**.
- Others (optional): **Autoscale**

- d. Optional (When Display Type = **Strip Chart**): Modify RF attenuator, Preamp, and other settings:

Press **Scale/Amptd**

Then press the following:

- **Scale** Manually enter a **scale per division** to view specific areas of the trace.
- **Ref Level** Manually set the value of the reference line. Enter a negative value by pressing **Run/Hold (+/-)** either before or after typing a value.
- **More** opens a menu of softkeys that are the same as those that are defined when the Display Type = **Table**.
- Others (optional): **Autoscale**

10. Optional: Modify scale and specify color bar limit values—Modify the scale and assign colors to low and high power channels (bars):

Press **Scale/Amptd**

Then one of the following:

- **Red Limit** to set the power level and color scale for high power channels.
- **Blue Limit** to set the power level and color scale for low power channels.
- Others: **Scale**, **Ref Level**, etcetera as desired.

11. Optional (i.e., If the Scan Results table does not populate): Press **Meas Setup**

- **LTE FDD and LTE TDD:**
 - Then **FreqError Th** > **5 kHz** (enables data with larger frequency error to be displayed)

- or **Extend Freq Lock** > **ON** (disables **FreqError Th** softkey and displays all available cell results. (This may result in longer scan times, because display does not update until all potential cells and their frequency offsets are detected between signal and the OTA center frequency.)
- **LTE TDD (Only): UL-DL Config** (selects the type of Uplink-Downlink switch-point periodicity configuration). Choose from Config 0 (default) through Config 6.
 - **MBSFN** (opens a menu to configure the Multi-broadcast Single Frequency Network (MBSFN) frames to transmit 5G NR control channels (SSBs) and can be used to enable dynamic spectrum sharing (DSS)).
 - **MBSFN OFF ON** – Enables the MBSFN frames for NR control channels (SSBs). (Default = OFF.)
 - **Toggle All Subframes** – Enables or disables all of the MBSFN frames. Enabled by default when MBSFN is set to ON.
 - **Subframe 3 OFF ON** – Enables or disables subframe 3 as one of the MBSFN frames for NR control channels (SSBs). **Subframe 4 OFF ON**, **Subframe 7 OFF ON**, **Subframe 8 OFF ON**, and **Subframe 9 OFF ON** are similar to Subframe 3.
 - **More** – Opens a menu to enable/disable the **Subframe 8** and **Subframe 9** MBSFN frames that are NR control channels.
 - **5G TF: Then SyncCorr Th** > **0%** (enables data with greater than 0% of the specified Sync Correlation percentage to be displayed)
 - Once the table populates, enter the desired frequency error (LTE FDD and LTE TDD) or Sync Correlation (5GTF) threshold for your measurement (LTE FDD: Default = 900 Hz, i.e., if a carrier signal's error is greater than 900 Hz, no data is displayed. 5GTF: Default = 1%, i.e., if a carrier signal's sync correlation is smaller than 1%, no data is displayed).

NOTE

If after making the setting changes in this section, no data is displayed, refer to **“Troubleshooting” on page 392**.

Display does not update (refresh), until all active component carriers (CCs) have been scanned.

12. Enable the **Data Logging settings:**

- Press **Trace 6** > **More** (All Modes) > **More** (5G NR only) then **Data Logging** to view the Data Logging softkeys and set the **Record Settings**, **Record Save/Recall**, and **Indoor Map Data Logging**

- To set **Record Playback**—choose:
 - **Record** (Outdoor Logging) or
 - **Play** (If you have previously stored data recordings.)

CAUTION

Spectrum and Strip Chart information is not recorded. Only the Table and Bar Chart data are saved. See “[How to Record a Data Log Procedure](#)” on [page 388](#).

NOTE

Data Log-Play files are saved to:

- If File Folder is set to Default then Data Log-Play files are save-recalled to: "[CurrentDevice]\RecordPlayback\OTA"
- If File Folders are set to System, then Data Log-Play files are save-recalled to: "CurrentDevice\

- a. To set the **Record Settings** (Outdoor Mapping only) —then choose:
 - Then **Meas Interval** > ON
 - Then **Interval Type** > choose **Time** or **Distance**.
 - Then, if applicable **Time Interval** enter time interval in seconds.
 - Or
 - Then, if applicable **Distance Interval** enter distance interval in meters.
 - Then **Back**
- b. Then press **Record Save/Recall** To set file settings choose

NOTE

Learn more about file settings, refer to [Chapter 32, “File Management.”](#)

- **Save Log File** to save the current Table data (i.e., default save device is Internal). i.e., *.KML or *.CSV (default) files are saved to the file name and device type. See Settings below and “[To change Data Logging Configuration settings:](#)” on [page 388](#)
- **Recall Log File** select a filename from the list
- **File Folder**
Default - selects [Internal]:RecordPlayback\OTA (default) or **System** - selects [Internal] top of internal directory.
- **Device** choose where to store your data files
- **File Type** > **CSV** or **KML** choose a file type (Default: CSV)

- **Auto Save** OFF (default)/ON. When enabled, a temporary log file (e.g. TempAutoSave.csv) is automatically saved after each new record is recorded to guard against data lose in the case of an unexpected shutdown. The temporary log file is automatically deleted after you stop recording and manually save the log file.

or

- **Back**

c. **Indoor Map Data Logging** - then **Record Indoor Data** or **Recall Indoor Log File**.

- Then choose **Navigate OFF ON**, **Data Selection**, **Zoom**, **Pan**, **Record Data**, **More**

Learn more, refer to [Chapter 16 Mapping](#) and [“Setting up Data Logging” on page 475](#). See also, [Chapter 32, “File Management.”](#)

13. Outdoor Mapping only: If recording, then:

- **View Map OFF ON** To enable/disable the current map view (default = latitude/longitude = 0.00/00. Need GPS to view current location (default = OFF).
- **Pause Resume** Temporarily halts recording until pressed again. The incoming trace continues to sweep. Press again to continue recording.
- **Stop** Immediately stops recording and a “Save the Log File” menu opens to rename and save your data log file.
- (Press **Record** to begin a new recording.)
- Then **Maps** To enable map view and related features (e.g., Data Selection, Red/Blue Limits, Labels & Icons, Zoom).
 - **Data Selection** Opens a softkey menu to set the active data channel, sort type, and sort order. See also previous step 8 above.
 - **Red/Blue Limits** Opens a softkey menu to assign power values to the red (high power limits) and blue (low power limits) heat map display limits (defaults: Red Limit = -20 dBm, Blue limit = -90 dBm).

- **Labels & Icons** Opens a softkey menu to enable/disable map data point labels and icon types.

Labels OFF ON	Enables/Disables map data point labels. When enabled, a label is displayed for every map data point (e.g., "Data 1"). When disabled, labels are not displayed for the map data points.
Icons Flag Point Line	Sets the type of icon that is used to display a map's data points (default = Flag).

- **Save Image (PNG)** Saves the currents displayed map to a *.png file (default filename is "MapImageFile").

NOTE

Data Log-Play files are saved to:

- If File Folder is set to Default then Data Log-Play files are save-recalled to: "[CurrentDevice]\RecordPlayback\OTA"
- If File Folders are set to System, then Data Log-Play files are save-recalled to: "CurrentDevice\\"

14. Export KML file into 3rd party mapping software (i.e., Google Map or Google Earth). Refer to "Step 6: Import and Play back KML Files into 3rd Party Software (Example: Google Earth with Animation Tool)" on page 378.

Figure 13-7

Single cell selected, but other cells displayed when CC0 to CC_n has been enabled. If ALL is selected, only the CC with the highest power is displayed. (Not all of the detected data is displayed.)

Model	N9952A													
Serial	US55040053													
Standard	OTA-LTE FDD													
Record Nu	140													
Rec Num	Date	Time	Longitude	Latitude	Altitude	GPS Statu	Freq Ref S	Frequency	Carrier Inf	Cells	PCI (C/S/C	RSRP (dBm	RSRQ (dB)	RSSI (dBm)
Rec-1	12/10/2018	08:57:30	0	0	0	INT	INT	1.00E+09	CC0	Cell - 0	6-0-2	-42.6557	-10.4134	-24.46
	12/10/2018	08:57:41	0	0	0	INT	INT	1.00E+09	CC1	Cell - 0	3-0-1	-42.8541	-13.2659	-21.80
										Cell - 1	18-0-6	-42.8063	-13.2182	-21.80
Rec-2	12/10/2018	08:57:47	0	0	0	INT	INT	1.01E+09	CC2	Cell - 0	15-0-5	-43.2514	-10.3075	-25.16
	12/10/2018	08:57:57	0	0	0	INT	INT	1.00E+09	CC0	Cell - 0	6-0-2	-42.6552	-10.432	-24.44
	12/10/2018	08:58:08	0	0	0	INT	INT	1.00E+09	CC1	Cell - 0	3-0-1	-42.8407	-13.2599	-21.79
Rec-3	12/10/2018	08:58:20	0	0	0	INT	INT	1.01E+09	CC2	Cell - 0	15-0-5	-42.7929	-13.2121	-21.79
	12/10/2018	08:58:27	0	0	0	INT	INT	1.01E+09	CC2	Cell - 0	15-0-5	-43.2722	-10.3097	-25.1
	12/10/2018	08:58:27	0	0	0	INT	INT	1.00E+09	CC0	Cell - 0	6-0-2	-42.6485	-10.4182	-24.44
Rec-4	12/10/2018	08:58:40	0	0	0	INT	INT	1.00E+09	CC1	Cell - 0	3-0-1	-42.848	-13.2686	-21.79
										Cell - 1	18-0-6	-42.8	-13.2206	-21.79
	12/10/2018	08:58:50	0	0	0	INT	INT	1.01E+09	CC2	Cell - 0	15-0-5	-43.287	-10.319	-25.18
Rec-5	12/10/2018	08:58:54	0	0	0	INT	INT	1.00E+09	CC0	Cell - 0	6-0-2	-42.6599	-10.4128	-24.46
	12/10/2018	08:59:08	0	0	0	INT	INT	1.00E+09	CC1	Cell - 0	3-0-1	-42.8711	-13.2694	-21.82
										Cell - 1	18-0-6	-42.8258	-13.224	-21.82
	12/10/2018	08:59:19	0	0	0	INT	INT	1.01E+09	CC2	Cell - 0	15-0-5	-43.2606	-10.3014	-25.17

Figure 13-8 Example of the LTE FDD Scan Results Table (Five CCs and one cell) – LTE TDD is similar¹

Carrier Info	CC0 - 0	CC1 - 0	CC2 - 0	CC3 - 0	CC4 - 0	-
Frequency	1.000 GHz	1.003 GHz	1.006 GHz	1.012 GHz	1.030 GHz	-
PCI (C/S/G)	6-0-2	3-0-1	9-0-3	15-0-5	18-0-6	-
RSRP (dBm)	-42.50	-42.68	-42.76	-43.09	-43.08	-
RSRQ (dB)	-10.42	-10.36	-10.25	-10.31	-10.30	-
RSSI (dBm)	-24.31	-24.54	-24.73	-25.01	-25.00	-
PSS (dBm)	-42.49	-42.67	-42.74	-43.07	-43.05	=
SSS (dBm)	-42.50	-42.65	-42.75	-43.06	-43.08	=
SINR (dB)	29.29	27.45	28.63	27.14	29.21	=
Freq Err (Hz)	0.00	0.02	0.00	0.00	0.00	=

Figure 13-9 Example of the 5G TF Scan Results Table (Two cc and one cell)

Carrier Info	CC0	CC1	-	-	-	-
Frequency	28.00 GHz	28.20 GHz	-	-	-	-
PCI	28	98	-	-	-	-
Power(dBm)	-53.03	-52.90	-	-	-	-
PSS (dBm) ▲	-43.71	-35.82	-	-	-	-
SSS (dBm)	-43.73	-36.11	-	-	-	-
Sync Corr(%)	90.36	91.10	-	-	-	-

1. When multiple component carriers are selected, the results of the component carrier (CC) with the highest power is displayed.

Additional LTE FDD Examples (LTE TDD is Similar)

Figure 13-10 Example of LTE FDD with Single Carrier, Multiple Cell Sites, KPIs

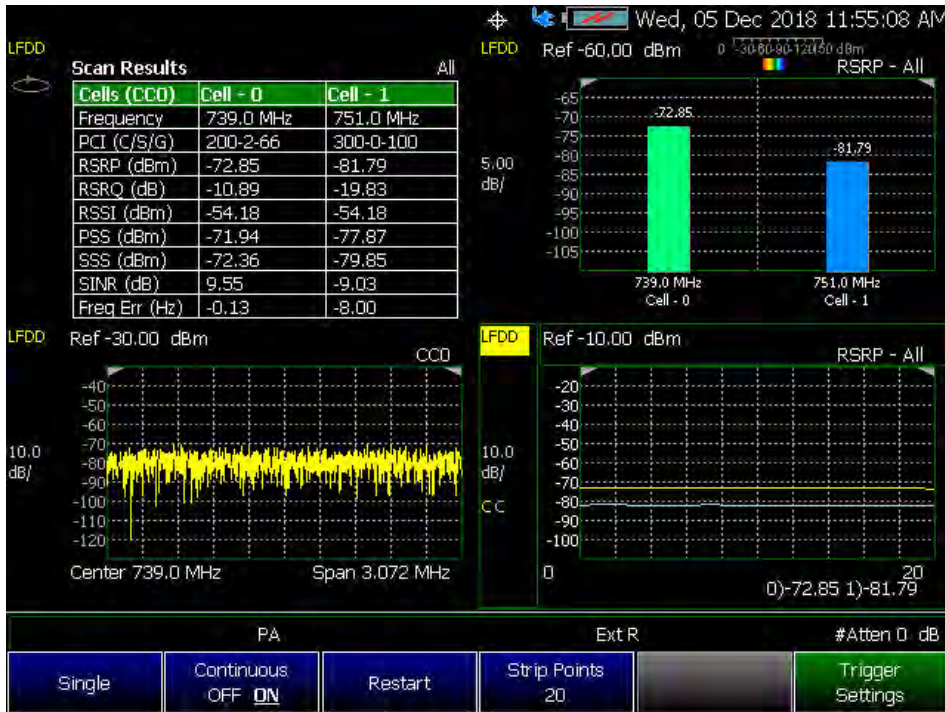
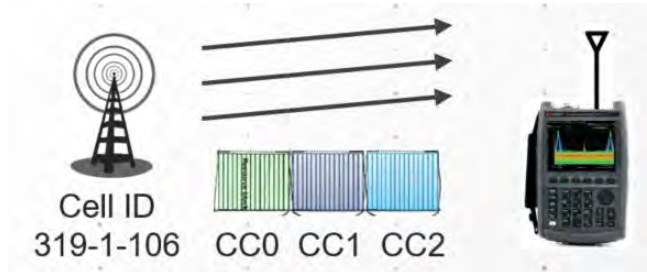

Figure 13-11 Example of LTE FDD with Multiple Carriers, Single Cell Site, and KPI's



Optional: Using RTSA to verify the signal quality (Requires Option 350 and Preamp Option 235)

- Press **Mode** > **RTSA**
 - Then **Density Spectrum** (Default)
- Press **Freq/Dist** > **Center** (Default) > **751 MHz**
(For this example, Center = 751 MHz.)
- Press **Scale/Amptd**
 - Then **Preamp [ON]**
 - Then **Ref Level** (Default). Then use the **▲▼** arrows, the rotary knob, or numeric keypad to position the trace for optimum viewing on the FieldFox display. Refer to **Figure 13-12 on page 367**.

You should see a ~20 dB or greater LTE FDD signal-to-noise level. If not refer to **“Troubleshooting” on page 392**.

Figure 13-12 Using RTSA to verify LTE FDD 751 MHz signal quality—20 dB Signal to Noise Displayed (Requires Option 350 and Preamp Option 235)

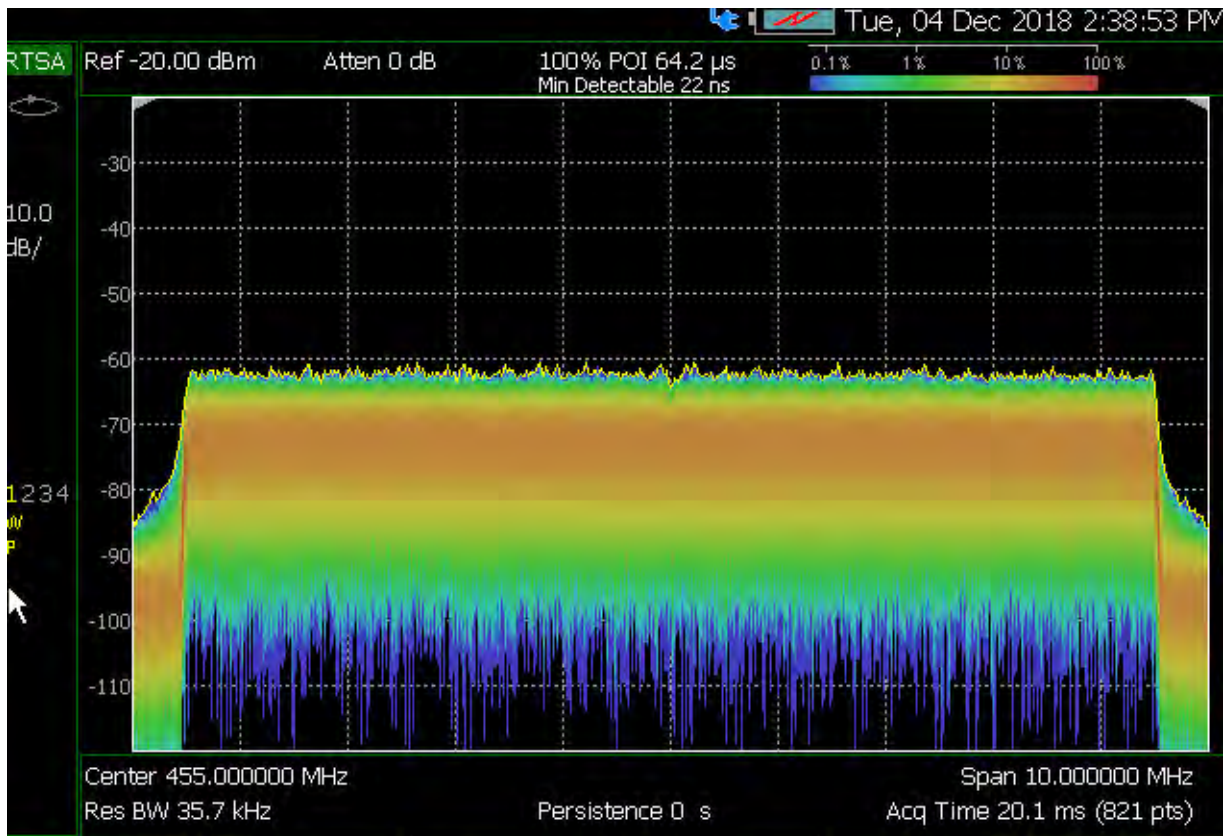

How to Define a Cell or Cell(s) and Use OTA

LTE FDD, LTE TDD, and 5GTF have only one predefined view (Table). You can define measurements, which can be used to display up to four different views (windows) simultaneously on the display screen. You can select which type of data to display in each of the views from the Trace menu.

Cell definitions consist of the following:

- Set frequency according to DUT requirements
- Define cell settings
- Define component carrier(s) (CCs) settings

Example: Using OTA LTE FDD or 5GTF, refer to:

- **“Step 1: LTE FDD (Option 370), LTE TDD (Option 371), and 5GTF (Option 377): Component Carrier (CC) and Cell Defined” on page 368**

Then:

- **“Step 2: Select Trace Type” on page 371**
- **“Step 3. Modify Scale and the Display Color Bar Settings” on page 373**
- **“Step 4: Enable Data Logging and Playback the Results” on page 374**
- **“Save 5: Save the Log Results:” on page 377**
- **“Step 6: Import and Play back KML Files into 3rd Party Software (Example: Google Earth with Animation Tool)” on page 378**

Figure 13-13

Cell Definition (LTE FDD) – (LTE TDD is similar)

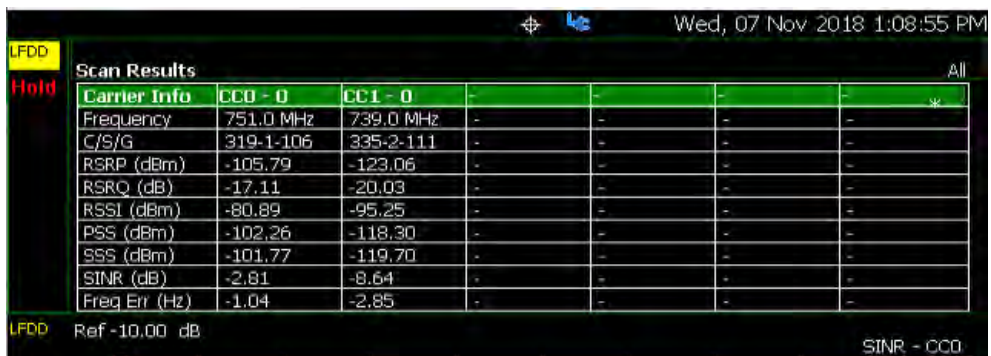

The screenshot shows the 'Scan Results' screen in FieldFox. The title bar indicates 'Wed, 07 Nov 2018 1:08:55 PM'. The screen displays a table of scan results for LTE FDD. The table has columns for 'Carrier Info', 'CC0 - 0', 'CC1 - 0', and several other columns. The rows include Frequency, C/S/G, RSRP (dBm), RSRQ (dB), RSSI (dBm), PSS (dBm), SSS (dBm), SINR (dB), and Freq Err (Hz). The SINR (dB) row shows values of -2.81 and -8.64. The Freq Err (Hz) row shows values of -1.04 and -2.85. The bottom of the screen shows 'Ref -10.00 dB' and 'SINR - CC0'.

Carrier Info	CC0 - 0	CC1 - 0					
Frequency	751.0 MHz	739.0 MHz	-	-	-	-	*
C/S/G	319-1-106	335-2-111	-	-	-	-	-
RSRP (dBm)	-105.79	-123.06	-	-	-	-	-
RSRQ (dB)	-17.11	-20.03	-	-	-	-	-
RSSI (dBm)	-80.89	-95.25	-	-	-	-	-
PSS (dBm)	-102.26	-118.30	-	-	-	-	-
SSS (dBm)	-101.77	-119.70	-	-	-	-	-
SINR (dB)	-2.81	-8.64	-	-	-	-	-
Freq Err (Hz)	-1.04	-2.85	-	-	-	-	-

Step 1: LTE FDD (Option 370), LTE TDD (Option 371), and 5GTF (Option 377): Component Carrier (CC) and Cell Defined

1. Press **Preset** then **Mode Preset (Factory)**
2. Selecting an OTA mode: Press **Measure** > **LTE FDD** or **LTE TDD** or **5GTF**
3. Optimizing the FieldFox to scan for signals:

How to Set Up Over-the-Air (OTA) Mode Settings

– Set the **System** > **System Configuration** > **Frequency Ref** > **Freq Ref Source** **[GPS]** > **Back**

– Set the **GNSS (GPS+)** > **GNSS Receiver** > **Internal** > **Esc**

See also “GNSS (GPS+) and GPS” on page 749.

– Set the **Scale/Amptd** to:

– **RF Atten** > 0 dB

– **Preamp** > **ON**

– Set the **Freq/Dist** > **Center** to:

All Measurement Setups:

– Press **CC CCO**

– Press **Enabled OFF ON** Enable/disable selected component carriers. If only one CC is enabled, the OFF key press is ignored (default = ON).

– Press **Center** to select the currently displayed component carrier center frequency.

For **LTE FDD** and **LTE TDD** (instrument dependent)

– Optional (LTE FDD and LTE TDD only):

– **Freq Mode** > **Chan**

– Then **Channel Table** – Opens a menu to choose your **CC**, **Band**, **Channel**, and then use **Favorites List**, to open a softkey menu to save your **Setup**.

– For **5GTF** (instrument dependent)

4. Select **Trace 6**—choose:

– **Window 1 2 3 4**

– Then **Win State OFF ON** to **ON**

– Then **Data**

– **Table** or

– **Bar Chart** or

– **Spectrum** or

- **Strip Chart**

NOTE

The Spectrum view in 5G TF uses a center frequency that is +2.6 MHz offset from the carrier's center frequency. This is done so that FieldFox can capture the necessary xPBCH (physical broadcast channel) information to demodulate the signal. Be aware that all of the instrument's displayed numbers are rounded to three significant digits (e.g., 5.0026 GHz is displayed as 5.003 GHz).

- Then **CC** (select component carriers)
 - **All** (Not applicable for Spectrum. When **All** is specified, for Spectrum, the FieldFox defaults to CC0) or
 - **CC0**, **CC1**, **CC2**, **CC3**, or **CC4** (i.e., 5GTF has up to seven component carrier choices (**CC5**, **CC6**, and **CC7**))
- Then **PCI All** (select PCIs)
 - **All** (Not applicable for Spectrum. When **All** is specified, for Spectrum, PCI is set to single). For all other display types, the results for any cells with any PCI are displayed (default = All).
 - **Single** displays the results for the selected PCI.

Repeat process as needed for additional Windows, Data, and CC settings.

NOTE

IMPORTANT! When you select a multiple CCs (e.g., CC0, CC1, etcetera) and record data, you may actually see other cell signals that do not have sufficient power to be displayed, but are still detectable. When you select ALL, multiple component carriers are selected, but the results of the component carrier (CC) with the highest power is displayed. Refer to [Figure 13-7 on page 363](#).

5. Optional: Press **Sweep 3** and modify/select items:

- **Single**
- **Continuous OFF ON** to **ON** (default)
- **Restart**
- **Strip Points**
- **Log Meas Status OFF ON**

6. Press **Trigger Settings**

- **Freerun** (default) or
- **External** sets a sweep to trigger on an external TTL signal at the External Trigger connector. External trigger is available only after initial setting.

- **Periodic** sets a trigger that repeats at the period rate entered. Periodic trigger's phase can be altered by the Offset value.
7. Optional: Press **Meas Setup 4** – Only required if scan does not display data.
- **LTE FDD** and **LTE TDD**: Press **FreqError Th** and change to **5 kHz** – Wait a few seconds until Table populates or set **FreqLock Range** to **Extended**.
 - Then change back to the desired Frequency Error Threshold for your measurement.
 - **5GTF**: Press **SyncCorr Th** and change to **0%** – wait a few seconds until the Table populates and
 - Then change back to the desired Sync Correlation Threshold for your measurement.
8. Press **Trace 6**
- And, set up your Windows and component carriers (CCs) as indicated in “**How to Set Up Over-the-Air (OTA) Mode Settings**” on page 354.
9. Press **System**
- Press **GNSS** > **GNSS Receiver** > **Internal** > **Esc**
 - Press **System** > **FrequencyRef** > **Internal** > **Back**

NOTE

IMPORTANT! It is **not** sufficient to be locked to the GNSS satellite, the frequency reference must be locked to GPS.

Step 2: Select Trace Type

Select one of the following display orientations:

- Press **Trace 6**—choose:
 - **Table** or
 - **Bar Chart** or
 - **Spectrum** or
 - **Strip Chart** or

Figure 13-14 Table and Bar Chart Display Types – LTE FDD – (LTE TDD is similar)



Figure 13-15 Spectrum and Strip Chart Display Type – 5GTF



Step 3. Modify Scale and the Display Color Bar Settings

To assign colors to low and high power values:

1. Press **Scale/Amptd** > **Red Limit** to set high power values and to set the color.
2. Press **Blue Limit** to set low power values and to set the color.
3. And, then press **System** > **Display** > **Display Colors**, to set Indoor, Outdoor, or other display colors. See also **Chapter 30, “System Settings.”**

Figure 13-16 Outdoor Display Colors

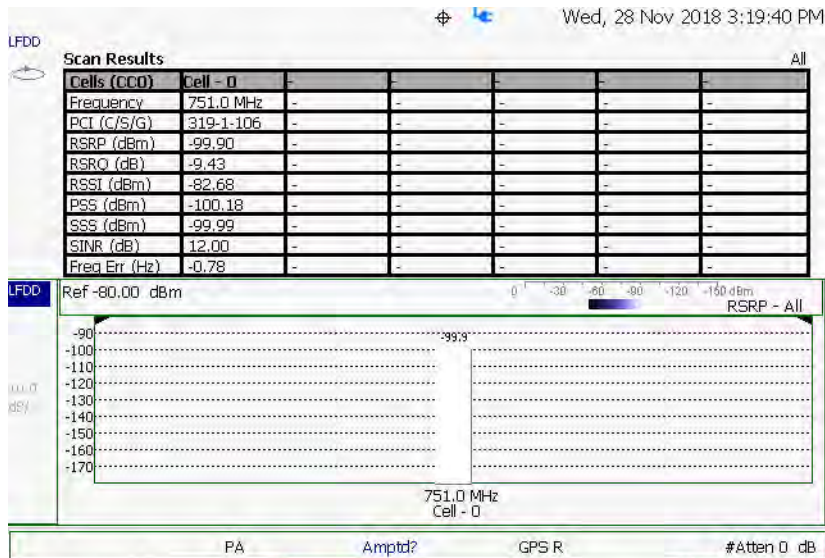

Figure 13-17 Indoor Display Colors



Step 4: Enable Data Logging and Playback the Results

CAUTION

Spectrum and Strip Chart information is not recorded. Only the Table and Bar Chart data are saved. See [“How to Record a Data Log Procedure” on page 388](#).

Recording creates a record of your data with a timestamp and GPS stamp (refer to [“GNSS \(GPS+\) and GPS” on page 749](#)). GPS must be enabled for the log results to include a GPS stamp or use Preferences to enable the timestamp. Refer to [Chapter 30, “System Settings.”](#)

Features

- Log files contain cell results for different component carriers (CCs) including timestamps and/or distance stamps.
 - Timestamps are included in log files with or without GPS.
 - GPS must be enabled for log altitude results.
See also [“GNSS \(GPS+\) and GPS” on page 749](#).
- Data results can be logged
- Data results can be saved to a *.CSV or *.KML file. Refer to [“Save 5: Save the Log Results:” on page 377](#).
- User specifies how often results are stored.
 - Time: Store results every “n” seconds
 - Altitude: Store results every “n” meters. GPS must be enabled to store results by altitude.

Procedure

1. Press **Trace 6** > **More** > **Data Logging** to view the Data Logging softkeys and set the **Record Settings**, **Record Save/Recall**, and **Indoor Map Data Logging**
 - **Record** (Outdoor Logging) or
 - **Play** (If you have previously stored data recordings.)
 - a. **Outdoor Mapping only:** To set the **Record Settings**—choose:
 - **Meas Interval**
 - **Interval Time**
 - **Time Interval** or
 - **Distance Interval**
 - b. Then press **Record Save/Recall**
 - Then **File Folder Default System**

- **Default** – Sets the default User Folder path:
 - List files (*.csv and *.kml) are save-recalled to:
"[CurrentDevice]:\RecordPlayback\
CS\"
 - Data Log-Play files are save-recalled to:
"[CurrentDevice]:\RecordPlayback\
CS\"

Or

- **System** – Sets the User Folder to the user defined system folder path/name:
 - List files are save to-from
"CurrentDevice\<<UserSelectedFolder>\\"
 - Data Log-Play files are save-recalled to:
"CurrentDevice\<<UserSelectedFolder>\\"

Refer to **“File Management” on page 767.**

- Then **File Type**
 - KML (default) or
 - CSV
- Then **Save Log File.**

or

- Then Recall Log File.
- **Auto Save OFF ON** - (default = OFF) Press to toggle to ON to enable Auto Save.
- Then **Back**

c. Optional: Press **Indoor Map Data Logging** then

- **Record Indoor Data** or **Recall Indoor Log File.** Refer to **“How to Use Data Logging (OTA Options 370, 372, and 377)” on page 387.**

Learn more, refer to **Chapter 16 Mapping** and **“How to Set Up Mapping Settings” on page 460.**

2. Press **Back** to return to previous menu.
3. Outdoor Mapping: Press **Record** to begin a new recording and then
 - Then **Maps** To enable map view and related features (e.g., Data Selection, Red/Blue Limits, Labels & Icons, Zoom).

- **View Map OFF ON** Displays the current GPS location.
- **Data Selection** Opens a softkey menu to set the active data channel, sort type, and sort order. See also previous steps 8 in “How to Set Up Over-the-Air (OTA) Mode Settings” on page 354.
- **Red/Blue Limits** Opens a softkey menu to assign power values to the red (high power limits) and blue (low power limits) heat map display limits (defaults: Red Limit = -20 dBm, Blue limit = -90 dBm).
- **Labels & Icons** Opens a softkey menu to enable/disable map data point labels and icon types.

Labels OFF ON	Enables/Disables map data point labels. When enabled, a label is displayed for every map data point (e.g., “Data 1”). When disabled, labels are not displayed for the map data points.
Icons Flag Point Line	Sets the type of icon that is used to display a map’s data points (default = Flag).

- **Save Image (PNG)** Saves the current displayed map to a *.png file (default filename is “MapImageFile”).
4. When done press **Stop**. The log file is automatically saved to the defined Device Type and File Type.

Else, edit the file name, and then press **Done**.

See also, [Chapter 16 Mapping](#) and “[Setting up Data Logging](#)” on [page 475](#).

NOTE

Learn more about file settings, refer to [Chapter 32, “File Management.”](#)

5. Press **Back**

Playing a Data Log and Viewing the Data

To play the log results:

1. Press **Record Save/Recall** > **Recall Log File**

And, use the Use the RPG or the **▲▼** arrow keys to highlight the file to be played.

2. Press **Recall File** > **Back** > **Play**
3. Optional: Press **Scale/Amptd**

Then choose:

- Optional (Bar Chart and Spectrum only): To adjust the following, use the RPG (fine adjust) or the ▲▼ arrow keys (coarse adjust) to change the color bar.
 - **Autoscale** to have the FieldFox optimize the scale for the current measurement.
 - **Ref Pos** to change the reference line position (0 to 10).
 - **Scale** to change the reference line position (0.01 to 100 dB).
 - **Ref Level** to change the top reference position in the Bar Chart, Strip Chart, and Spectrum.
 - **Red Limit** to change the red color high power value (dBm). Bar chart only.
 - **Blue Limit** to change the blue color low power value (dBm). Bar chart only.
- 4. Press **Stop** to exit the log playing.

To pause the log play:

1. Press **Pause Resume** to pause or resume the log playing.
2. Press **Stop** to exit the log playing.

Save 5: Save the Log Results:

Two file types are supported for save or recall log results:

- KML file format
 - Files stored in this format can be imported into 3rd party applications like Google Earth or Google Maps.
- CSV file format. Files stored into this format can be imported into spreadsheet applications.

Procedure:

1. Press **When done** press **Stop**. Immediately stops recording and a “Save the Log File” menu opens to rename and save your data log file.

NOTE

Record-Play files are saved to:

- If File Folder is set to Default then Record-Play files are save-recalled to: "[CurrentDevice]\RecordPlayback\[Current mode]\\"
- If File Folders are set to System, then Record-Play files are save-recalled to: "CurrentDevice\<UserSelectedFolder>\\"

2. In the “Save the log file” window that opens, optionally change the name of the default file displayed, else press **Done**.

Saves the file and exits the current softkey menu.

3. To begin recording: Press **Record**
4. When done press **Stop**. The file is automatically saved to the defined Device Type and File Type.

Else, edit the file name and folder path, under **Record Save/Recall** > **File Folder** where the file results will be stored.

NOTE

Learn more about file settings, refer to [Chapter 32, “File Management.”](#)

5. Press **Back**

Learn more, refer to [Chapter 16 Mapping](#) and [“How to Use Data Logging \(OTA Options 370, 372, and 377\)” on page 387.](#)

Step 6: Import and Play back KML Files into 3rd Party Software (Example: Google Earth with Animation Tool)

Features

Use the Playback Slider to replay measurement results. See also Google Maps and or Google Earth’s help.

- Open the FieldFox *.KML file in Google Earth. Time Slider appears in upper left of the map.
- Manual Mode – Move the time slider cursor to see color-coded icons pop-up according to the timestamp.
- Loop mode has a Fast-Slow Replay Option.

Over-the-Air Measurements (OTA) – LTE FDD Option 370, LTE TDD Option 371, 5GTF Option 377 (CPU2 Only)

How to Set Up Over-the-Air (OTA) Mode Settings

- Click on each color coded balloon to see the table of measurement results for that location.

Figure 13-18 Importing a KML File Into Google Earth

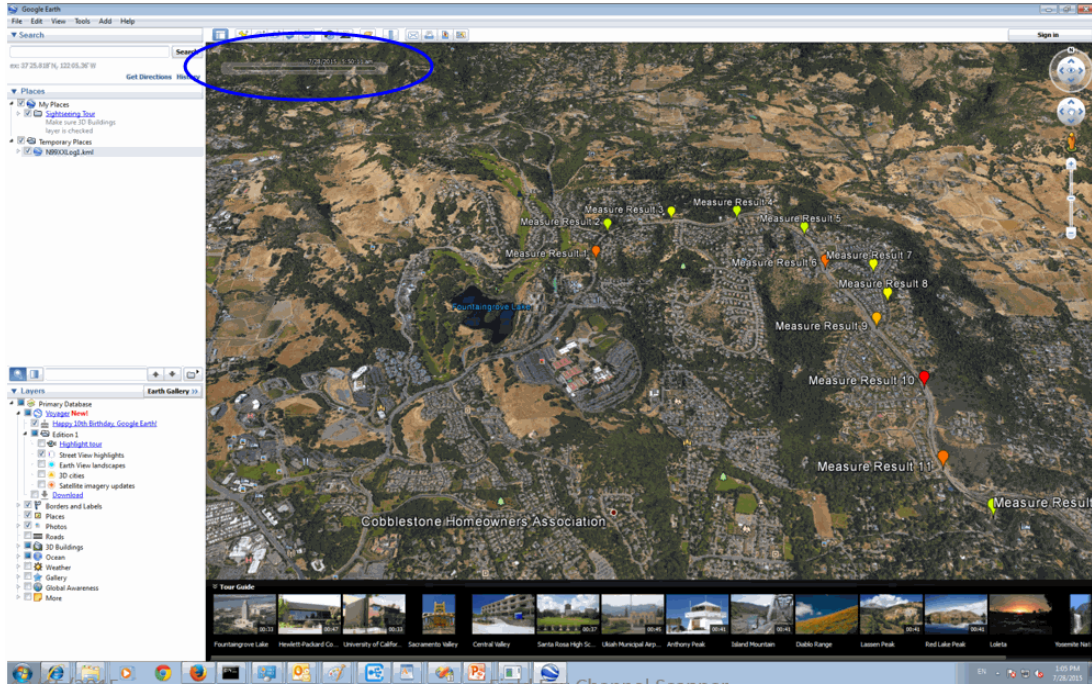

How to Set Up EMF Settings (Requires EMF (Option 358))

CAUTION

If OTA or SA mode does **not** detect an EMF Option 358 license, then the EMF application and the USB antenna's axes must be set up manually. This use model is **not** recommended or supported by Keysight.

CAUTION

The USB antenna's cable loss is **not** included, in the antenna's correction factors. For an accurate EMF measurement, the cable loss values should be accounted for. Refer to **“EMF Setup Procedure” on page 383.**

NOTE

IMPORTANT! The USB triaxial antenna—or equivalent—is required for EMF measurements. Refer to **Chapter 15, “USB Antennas – (Full Capability Requires EMF Option 358, and SA mode (Option 233 Mixed Analyzers)).”**

EMF mode measures signals at the SA RF Input Port 2 connector.

EMF mode requires the FieldFox to have SA mode (Option 233 on combination analyzers), or 5G NR Option 378), and CPU2 installed.

Recommended, but not required, preamplifier (Option 235) to improve receiver sensitivity.

With Option 358 (EMF), network designers can measure and verify the RF exposure compliance as required by each country.

This section reviews the steps in setting up an EMF measurement, using a USB antenna. If you are not familiar with this process or would like more information, refer to **Chapter 15, “USB Antennas – (Full Capability Requires EMF Option 358, and SA mode (Option 233 Mixed Analyzers)).”**

This section consists of:

- **“EMF Features”**
- **“EMF Setup Procedure”**

EMF Features

EMF has the following features:

EMF Measurement Results:

- Measure and display corrected field strength in RMS average power
- Antenna control over X, Y, and Z antenna factors downloaded via USB
- Pass/Fail limit testing supported
- External PC **not** required

EMF uses the following data formats:

Over-the-Air Measurements (OTA) – LTE FDD Option 370, LTE TDD Option 371, 5GTF
Option 377 (CPU2 Only)

How to Set Up EMF Settings (Requires EMF (Option 358))

- Field Strength units:
 - dB μ V/m – For use with E-field signals
 - dB μ A/m – For use with H-field signals
 - dBG – dB Gauss
 - dBpT – dB Tesla

Over-the-Air Measurements (OTA) – LTE FDD Option 370, LTE TDD Option 371, 5GTF Option 377 (CPU2 Only)
 How to Set Up EMF Settings (Requires EMF (Option 358))

Figure 13-19 Example of EMF with Triaxial Antenna

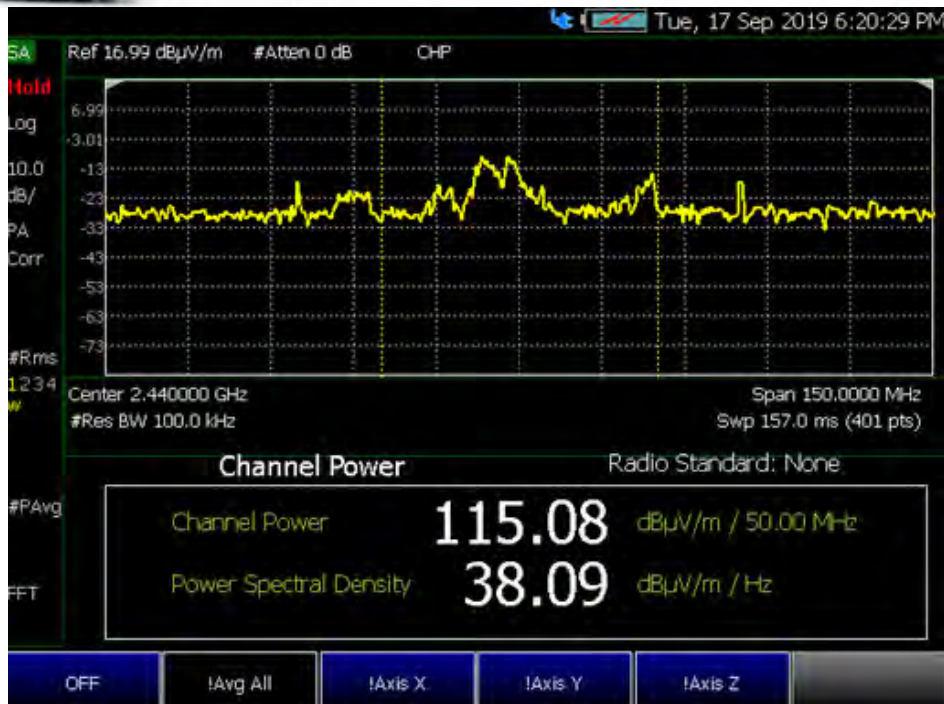
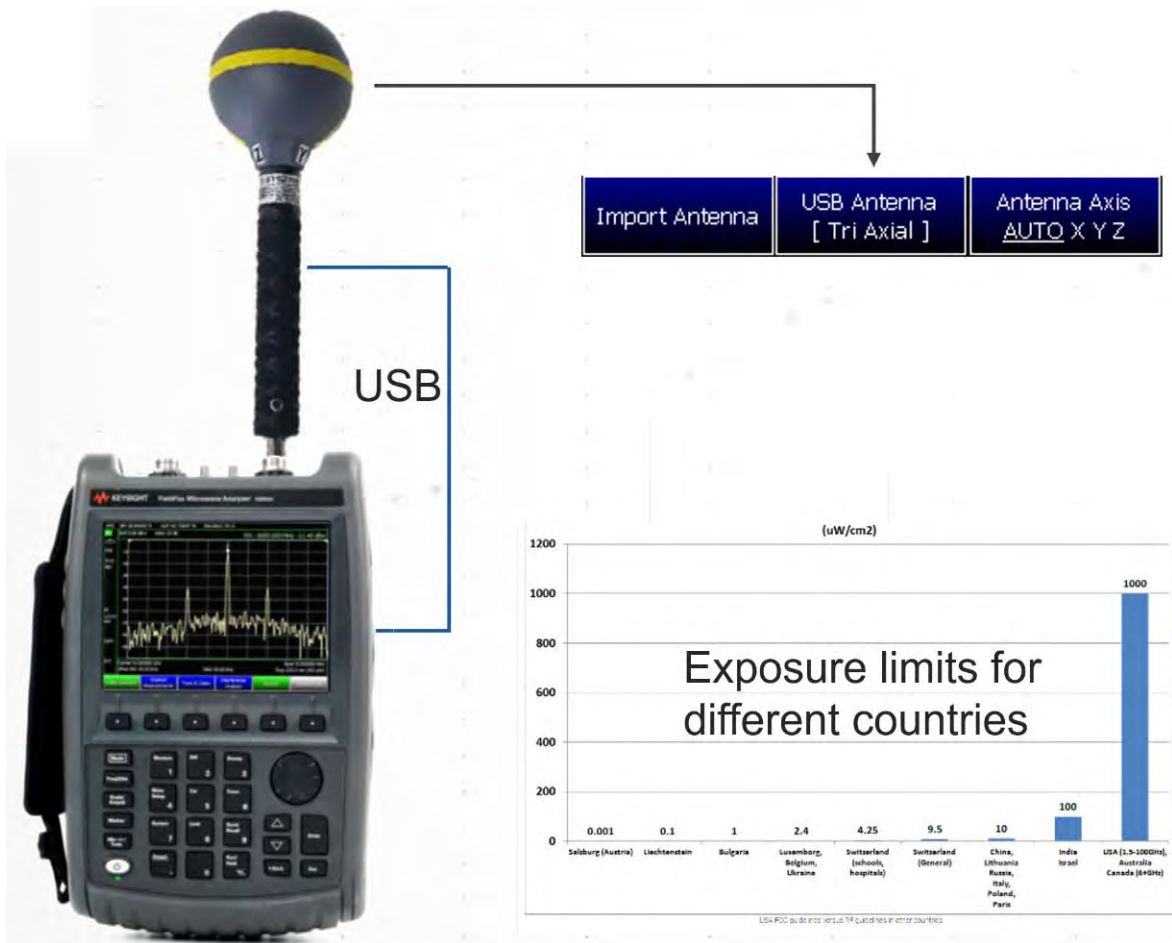

EMF Setup Procedure

CAUTION

When the USB antenna correction factors are imported, EMF (Option 358) couples many settings to ease setting up the EMF measurement (e.g., **Apply Corrections** is enabled, all X, Y, and Z antenna axes are enabled, and **Amp Corr Select** is set to **TriAxial XYZ**).

1. Setup the FieldFox Spectrum Analyzer for a Channel Power measurement.

a. Press **Mode** > **OTA** >

Press **Measure 1** then one of the following:

- **LTE FDD**
- **LTE TDD**
- **5G TF**

NOTE

If necessary, this step can be skipped and done **after** the USB antenna is set up.

2. Connect the USB antenna to the **SA RF Input**, port 2 and to a FieldFox USB port. See also, [Chapter 15, “USB Antennas – \(Full Capability Requires EMF Option 358, and SA mode \(Option 233 Mixed Analyzers\)\)”](#) and to [Figure 15-1 on page 436](#).

CAUTION

Only Agos Advanced Technologies SDIA-6000 Triaxial Isotropic USB antenna is compatible with EMF (Option 358).

3. Importing and selecting X/Y/Z antenna factors:

Press **System** > **Utilities** > **USB Antennas**

- Press **Import Antenna** to import the antenna factors from the antenna’s memory over the USB connection (this may take 5 seconds or so and vary with the Triaxial antenna).

NOTE

If the antenna factor import is successful, the FieldFox displays:
"Success: Antenna Factors Imported: Tri-Ax Antenna ID: ->[R] Antenna ID: SDIA-6000-1006 ->[]". The last 4-digits will vary for each antenna (i.e., "1006" is changeable).

If the FieldFox displays this error Error: USB antenna Error: Not found or Unable to communicate with antenna. Ensure it is connected. is displayed, verify the USB antenna is connected correctly. Refer to [“Troubleshooting” on page 392](#).

- Press **USB Antenna** then:

- Then **USB Antenna Tri Axial** verify **Tri Axial** (default) is selected.
- Optional: Press **Antenna Axis** the antenna axis should be set to **Auto** for default operation. When AUTO is selected the application (e.g., Channel Power or OTA) controls the axes and switches them as needed. With the AUTO setting, all antenna elements (X, Y, and Z) are OFF.
- Press **Back** > **Back** to exit the USB Antenna softkey menu.

4. Modifying the EMF settings:

Press **Meas Setup 4**

- Then **More** > **EMF** then
 - **EMF Meas OFF ON** disable/enable the EMF measurement.
 - **EMF Units** choose dBuV/m (default) or V/m.
 - **Back** to exit to the previous softkey menu.

For more details on editing the USB antenna, refer to [Chapter 15, “USB Antennas – \(Full Capability Requires EMF Option 358, and SA mode \(Option 233 Mixed Analyzers\)\)”](#)

5. Once you have finished with your USB antenna setup:

- a. Press **Sweep 3** > **Single** > **Restart**

The FieldFox should display in order Analyzing CCO X-Axis, Analyzing CCO Y-Axis, and Analyzing CCO X-Axis and then do a square root sum of the X, Y, and Z measurement values in the FieldFox. Multi-cell measurements are done similarly for each cell ID (i.e., Cell CCO to CCn). Refer to [Figure 13-20 on page 385](#).

- b. Verify OTA 5G NR X, Y, and Z Axes Factors in SA Mode (e.g., 3.5 GHz signal). Refer to [Figure 13-21 on page 386](#).
 - i. Press **Mode** > **SA** then
 - ii. Press **Freq/Dist** > **Center** > **3.5 GHz** then
 - iii. Press **Freq Span** > **120 GHz** then
 - iv. Press **System** > **Utilities** > **USB Antennas** then
 - v. Press **Antenna Axis X** to view the X axis
 - vi. Press **Antenna Axis Y** to view the Y axis and
 - vii. Press **Antenna Axis Z** to view the Z axis

6. Verify EMF in 5G NR Mode:

- a. Press **Mode** > **OTA** > **5G NR** then

Over-the-Air Measurements (OTA) – LTE FDD Option 370, LTE TDD Option 371, 5GTF Option 377 (CPU2 Only)

How to Set Up EMF Settings (Requires EMF (Option 358))

b. Press **Meas Setup 4** > **More** > **EMF** > **dBuV/m**

(i.e., For this example. Other units are selectable.)

For more information:

- Refer to **Figure 13-20**.
- See also **“Utilities”** on page 724.

Figure 13-20 Example Summing of Triaxial Values



Over-the-Air Measurements (OTA) – LTE FDD Option 370, LTE TDD Option 371, 5GTF Option 377 (CPU2 Only)
How to Set Up EMF Settings (Requires EMF (Option 358))

Figure 13-21

Using SA Mode (Example) to Verify the Triaxial Values – Axis Y is Displayed

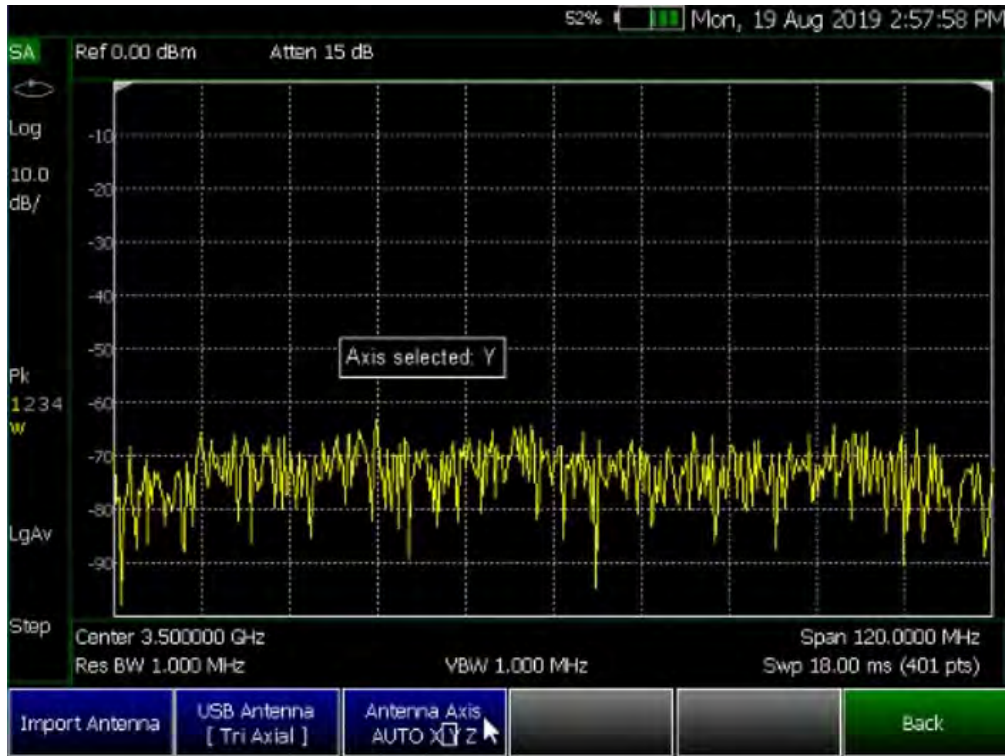

How to Use Data Logging (OTA Options 370, 372, and 377)

CAUTION

Spectrum and Strip Chart information is not recorded. Only the Table data is saved. See [“How to Record a Data Log Procedure” on page 388.](#)

NOTE

While the Record/Playback softkey is displayed in all measurements, Record/Playback only records and plays back Table and Bar Chart data. See [“How to Record a Data Log Procedure” on page 388.](#)

NOTE

Data Log-Play files are saved to:

- If File Folder is set to Default then Data Log-Play files are save-recalled to: “[CurrentDevice]\RecordPlayback\OTA“
 - If File Folders are set to System, then Data Log-Play files are save-recalled to: “CurrentDevice\
-

Data Logging allows you to record OTA trace data and play them back at a later time. Use this feature to monitor table data activity over a period of time.

Data Logs can be saved to the FieldFox Internal memory, an SD Card, or a USB flash drive.

This section assumes you have already completed the initial setup and have either an LTE FDD, LTE TDD, cell or 5GTF setup displayed on the FieldFox.

Screen Annotation

During a record or playback session, the following is displayed in the top-center area of the screen:

– **Rec: 55/55 2018-12-31 03:26:11 PM**

where:

- **55/55** is the current and total trace number: currently trace is 55 of 55 total scans.
- **2018-12-3103:26:11 PM** is the date and time of recording.
- The name of a recording can be changed using Manage Sessions. Learn more in [“To change Data Logging Configuration settings:” on page 388.](#)

See also [Chapter 30, “System Settings.”](#)

Over-the-Air Measurements (OTA) – LTE FDD Option 370, LTE TDD Option 371, 5GTF Option 377 (CPU2 Only)

How to Use Data Logging (OTA Options 370, 372, and 377)

When GPS is enabled, **GPS R** is indicated at the bottom of the FieldFox display. Learn more in [“GNSS \(GPS+\) and GPS” on page 749](#).

NOTE

If Data Logging or Playback is not occurring when you think it should, check the following:

- Is the sweep in HOLD? (upper-left annotation), or check the Sweep menu for Continuous set to OFF.
- Is Recording or Playback Paused? (mid-left annotation)
- Is the Data Logging or Playback Interval set too long? (Configuration settings.)

How to Record a Data Log Procedure

NOTE

Data Log-Play files are saved to:

- If File Folder is set to Default then Data Log-Play files are save-recalled to: “[CurrentDevice]\RecordPlayback\OTA“
- If File Folders are set to System, then Data Log-Play files are save-recalled to: “CurrentDevice\\

– Press **Trace 6** > **More** > **Data Logging** >

– Then for Outdoor Logging, press **Record**

REC is displayed in the left of screen graticules.

During recording, choose from the following:

- **Pause Resume** Temporarily halts recording until pressed again. The incoming trace continues to sweep. Press again to continue recording.
- **Stop** Immediately stops recording. For more, refer to [“How to use the FieldFox labeler ” on page 770](#).
- **Record Settings** (Outdoor Mapping only) opens a softkey menu to enable you change your record related settings. For more, refer to [“To change Data Logging Configuration settings:” on page 388](#).
- **Recall Save/Recall** opens a softkey menu to enable you to save and recall your data log and related file settings. For more, refer to [“To change Data Logging Configuration settings:” on page 388](#).

To change Data Logging Configuration settings:

1. Press **Trace 6** > **More** > **Data Logging**
2. Then choose from the following:

- a. To set the **Record Settings** (Outdoor Mapping only)–choose:
 - **Meas Interval OFF ON** Enable to make the measurement interval softkeys active (default = OFF).
 - **Interval Type** Choose: Time or Distance
 - If applicable, **Time Interval** Enter time in seconds (1s to 3.6 ks) or
 - If applicable, **Distance Interval** Enter time in miters (10m to 10 km)
- b. To set the **Record Save/Recall**
 - **File Folder Default System**
 - **Default** – Sets the default User Folder path:
 - List files (*.csv and *.kml) are save-recalled to:
“[CurrentDevice] : \RecordPlayback\
CS\“
 - Data Log-Play files are save-recalled to:
“[CurrentDevice] : \RecordPlayback\
CS\“
 - Or
 - **System** – Sets the User Folder to the user defined system folder path/name:
 - List files are save to-from
“CurrentDevice\<<UserSelectedFolder>\“
 - Data Log-Play files are save-recalled to:
“CurrentDevice\<<UserSelectedFolder>\“
 - Refer to **Chapter 32, “File Management”, on page 767.**
 - Then **File Type**
 - KML (default) or
 - CSV
 - Then **Save Log File.**
 - or
 - Then **Recall Log File.**
 - **Auto Save (default = OFF)**

- Then **Back**

c. Optional: Press **Indoor Map Data Logging** then

- **Record Indoor Data** or **Recall Indoor Log File**. Learn more, refer to **Chapter 16** Mapping and “**Setting up Data Logging**” on page 475.

Then choose **Navigate OFF ON**, **Data Selection**, **Zoom**, **Pan**, **Record Data**, **More**

Learn more, refer to **Chapter 16** Mapping and “**Setting up Data Logging**” on page 475. See also, **Chapter 32**, “**File Management**.”

How to Play a Data Log

- Press **Measure 1**
- If the session is already open, skip the following step. Otherwise:
- Then **Record Playback**

NOTE

If these are large recordings on a device, it could take several seconds for the FieldFox to display the list.

- Then **Playback**
- Then **Recall Log File** and select a file
 - Then **Recall File**
- Then **Play** to playback your Table data.

PLAY is displayed in the left of screen graticules during playback. When the end of the recording is reached, playback begins again at trace 1 and continues to loop indefinitely.

During playback, choose from the following:

- **Pause Resume** Temporarily halts playback. Then choose from the following:
 - **Pause Resume** Press to continue playing.
- **Stop** Immediately stops playback. Then choose from the following:
 - **Play** Start playback from trace 1.
 - **Recall Log File** Opens a list of stored data files. Select a file to playback.
 - **Recall File**
 - **Back**

Over-the-Air Measurements (OTA) – LTE FDD Option 370, LTE TDD Option 371, 5GTF
Option 377 (CPU2 Only)
Other Features Available

- **PlayTrace ID Auto** resume playing by selecting a trace number to playback between 1 and the record length (MAXimum = 2000 (multiple CC) and 1000 (single CC)).

Other Features Available

- **Alignments** - For information on using alignments, refer to the SA chapter's section, "**Alignments**" on page 211.
- **Scale Settings** – For information on using scale settings, refer to the Data Analysis chapter's section, "**All about Scale Settings**" on page 714 (not all settings apply to OTA Options 370 and 377).
- **External Gain** - Refer to refer to the SA chapter's section, "**External Gain**" on page 169.

Troubleshooting

If your OTA setup is not behaving as expected:

- Verify setup is correct by referring to “**How to Set Up Over-the-Air (OTA) Mode Settings**” on page 354.
 - Attenuator set to **0 dB**
 - Preamplifier set to **ON**
 - Correct **Band, Channel**, and **Center** Frequency entered
 - GNSS set to **Internal**
 - Frequency Ref set to **GPS**
 - For LTE FDD and LTE TDD: Verify that the Frequency Error Threshold (dB)–(**FreqError Th**) value is large enough or not too large
 - For LTE FDD and LTE TDD: Verify that the **Extend Freq Lock** value is enabled and then adjust settings to improve your measurement. For 5GTF: Check that the Frequency Correction Threshold value (%)–(**Sync Corr Th %**) is small enough or not too large.
 - ADC errors: Use **Scale/Amptd** > **Range** to adjust the absolute power level (dBm).
For some data views, you need to press **More** to view the **Range** softkey.
- No data displayed: Press **Meas Setup 4** – Only required if scan does not display data.
 - **LTE FDD** and LTE TDD: Press **FreqError Th** and change to **5 kHz**
 - Wait a few seconds until table populates or set **FreqLock Range** to **Extended**.
 - Then change back to the desired Frequency Error Threshold for your measurement.
 - **5GTF**: Press **SyncCorr Th** and change to **0%** – wait a few seconds until the Table populates and
 - Then change back to the desired Sync Correlation Threshold for your measurement.

Glossary (OTA)

This section provides a description of some of the terms used in the FieldFox's OTA mode.

Table 13-1 **OTA Abbreviations and Descriptions**

Abbreviation	Description
LTE FDD & LTE TDD	
Center Frequency	The specified LTE FDD carrier center frequency.
C/S/G	Physical Cell information (PCI), or Cell ID – C/ S /G
Cell ID (PCI)	Physical cell ID – The Primary Sync Signal and Secondary Sync Signal largely define the PCI. PCI is also referred to sometimes as Cell ID.
PSS	PSS (dBm) is the Primary Synchronization signal for an LTE downlink frame.
RSRP	Reference Symbol Received Power (dBm)
RSRQ	Reference Signal Received Quality (dBm)
RSSI	Reference Signal Strength Indicator (dBm)
SINR	Signal to Interference & Noise Ratio (dB)
SSS	SSS is the Secondary Synchronization signal for an LTE downlink frame (dBm).
Freq Error Th	LTE FDD and LTE TDD Frequency Error Threshold (Hz). Any data that is does not meet the defined Frequency Error value, is not displayed.
5GTF	
Center Frequency	The specified 5GTF carrier center frequency.
Cell ID (PCI)	Physical cell ID – The Primary Sync Signal and Secondary Sync Signal largely define the PCI. PCI is also referred to sometimes as Cell ID.
Power	(Channel Power) (dBm)
PSS	PSS (dBm) is the Primary Synchronization signal for an LTE downlink frame.
SSS	SSS is the Secondary Synchronization signal for an 5GTF downlink frame (dBm).
SyncCorr Th	5GTF Synchronization Correlation Threshold (%). Any data with errors that are less than the Synchronization Correlation Threshold (%) are not displayed.

Over-the-Air Measurements (OTA) – LTE FDD Option 370, LTE TDD Option 371, 5GTF
Option 377 (CPU2 Only)
Glossary (OTA)

14 5G Rapid Prototype Phased Array Antenna – Option 360

CAUTION

IMPORTANT!

85571A-028 (28 GHz 5G Phased Array Antenna) accessories not suitable for use in wet locations.

PAA is compatible with the frequency converter heads, but cannot apply or edit the frequency head corrections. Refer to [“Utilities” on page 724](#).

NOTE

The FieldFox can be used with an OML frequency extender. Refer to [“Utilities” on page 724](#), the [A Series FieldFox Configuration Guide 5990-9836EN](#), and to [“Contacting Keysight” on page 5](#).

Option 360 measures signals at the **SA RF Input Port 2** connector.

Option 360 requires the FieldFox to have SA mode (Option 233 on combination analyzers), and GPS (Option 307) installed.

Recommended, but not required, preamplifier (Option 235) to improve receiver sensitivity.

Keysight's FieldFox handheld analyzer (with Option 360) combined with a Ball Aerospace / Anokiwave 64-element antenna array provides a unique, portable solution for measuring and analyzing the 5G air interface in the field.

- Reduce measurement complexity with integrated RF probe and phased array solution to capture energy radiated from gNB
- Calibrated metrology milli-meter wave phased array antenna simulates 5G UE antenna performance
- Troubleshoot the 5G radio access network with 3D test coverage and path loss measurements utilizing the built-in CW generator
- Phased array performance verification showing bore sight, polar antenna pattern with compass, heat map and beam sweep to map display views

In this Chapter

[“Using the Phased Array Antenna \(Option 360\)” on page 397](#)

[“About Phased Array Antenna Measurements” on page 398](#)

- “Phased Array Antenna Features (Option 360)” on page 398
- “How to Set Up Phased Array Antenna Settings” on page 407
- “Option 360 Setup Procedure” on page 407
- “How to Define a Set Up a Scan and Use Option 360” on page 419
- “How to Use Data Logging/Playback (Option 360)” on page 428
- “Screen Annotation” on page 428
- “How to Record a Data Log” on page 430
- “To change Data Logging Configuration settings.” on page 430
- “How to Play a Data Log” on page 431
- “Other Features Available” on page 432
- Alignments (SA chapter) – “Alignments” on page 211
- External Gain (SA chapter) – “External Gain” on page 169
- “Troubleshooting” on page 433

See Also

- “Why and When to Calibrate” on page 134
- Chapter 30, “System Settings.” (Changing display colors)
- Chapter 32, “File Management.”

Using the Phased Array Antenna (Option 360)

Option 360 enables you to do the following:

Measure and display phased array antenna elevation and azimuth

Four Display Types:

- Bore-Site
- Heat Map
- Polar Antenna
- Park Antenna
- Polar with Image Overlay

Color Coded Display Types:

- Specify high and low power with color bars

Azimuth and Elevation:

- 8 x 8 phased array antenna
- Covers beam sweep –60 to +60 degrees azimuth, 90-degree elevation with 1 degree per step
- Individually factory characterized elements, magnitude and phase

Data Logging. Record GPS stamped data measurements

- Define measurement interval by time or distance
- Display files (KML) on Google Maps or Google Earth
- Show results in TableChart

About Phased Array Antenna Measurements

Some measurement parameters are auto-coupled and are not user-settable.

Phased Array Antenna Features (Option 360)

NOTE

IMPORTANT! Option 360 antenna requires a static IP address. If it is required to have available an IP address that can be accessed over your company's network, work with your company's IT team to set up a static IP that works over the network.

IMPORTANT! If you forget you N9910X-028 Ball Antenna's static IP address, refer to this link and the **Support** tab for assistance: www.keysight.com/find/fieldfox and then to the **Phase Array Antenna Support Document**.

Phased array antenna has the following features:

Scan Results:

- 28 GHz operation
- gNB RF parametric test over-the-air in the field
- Measure EIRP (effective isotropic radiated power)
- Milli-meter wave beam sweep survey with map
- Support for real-time spectrum analysis, transmitter power and spectrum emission mask (SEM) – (Requires CPU2)

Data Formats:

User can set up and display the following:

- **Bore-Sight** – Elevation angle is fixed. Scan azimuth –60 degrees to +60 degrees.
- **Heat Map** – Scan both elevation and azimuth angle with adjustable color "heat" amplitude scale.
- **Polar ANT** – Scan azimuth angle. Elevation is fixed.
- **Park ANT** – Polar image overlay load image:
 - Resize polar coordinates
 - Specify alignment angles
 - Specify compass true north
 - Define antenna direction (azimuth degrees)

Figure 14-1 Example of local point-to-point LAN connection



Figure 14-2 Bore-Sight Scan – CW RF

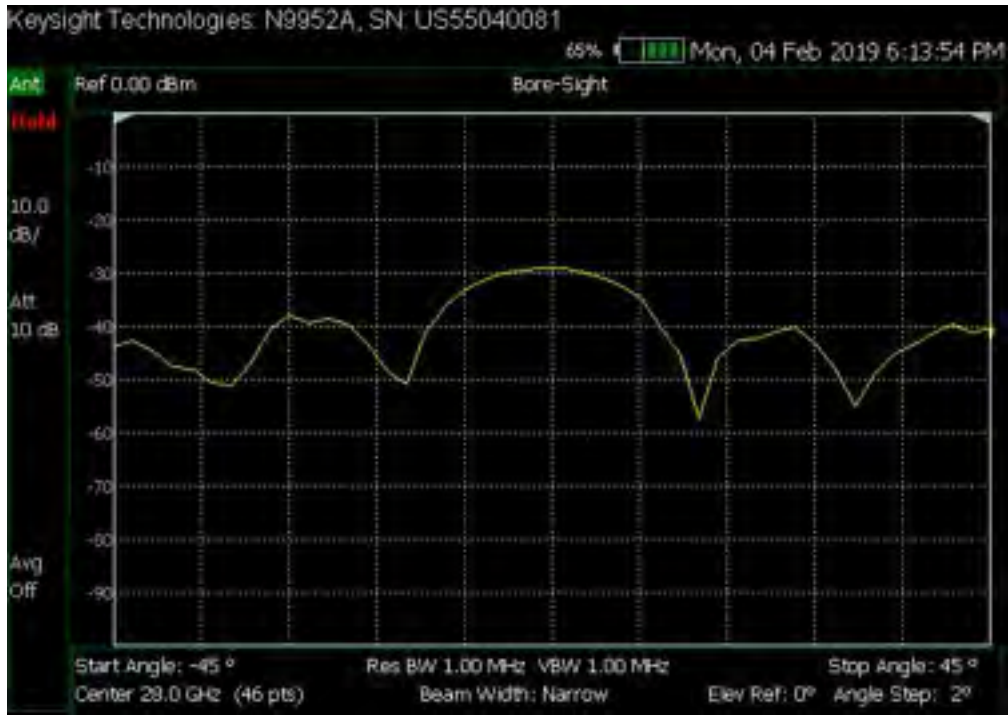

Figure 14-3 Polar Scan with compass displayed



Figure 14-4 Heat Map (Azimuth vs. Elevation) - Parked Antenna

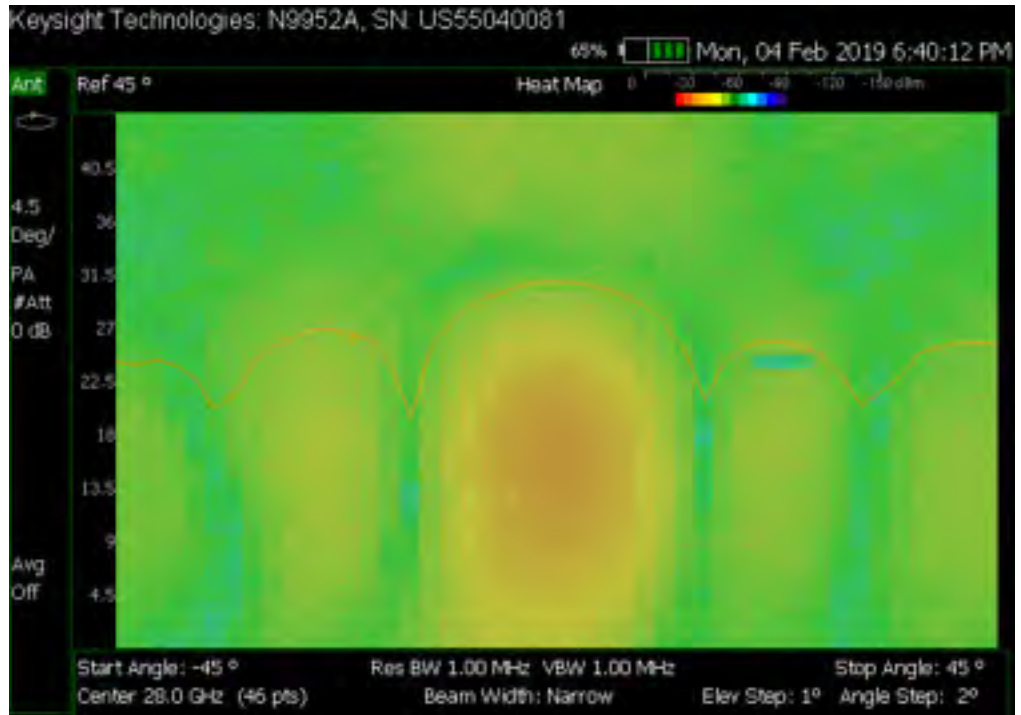
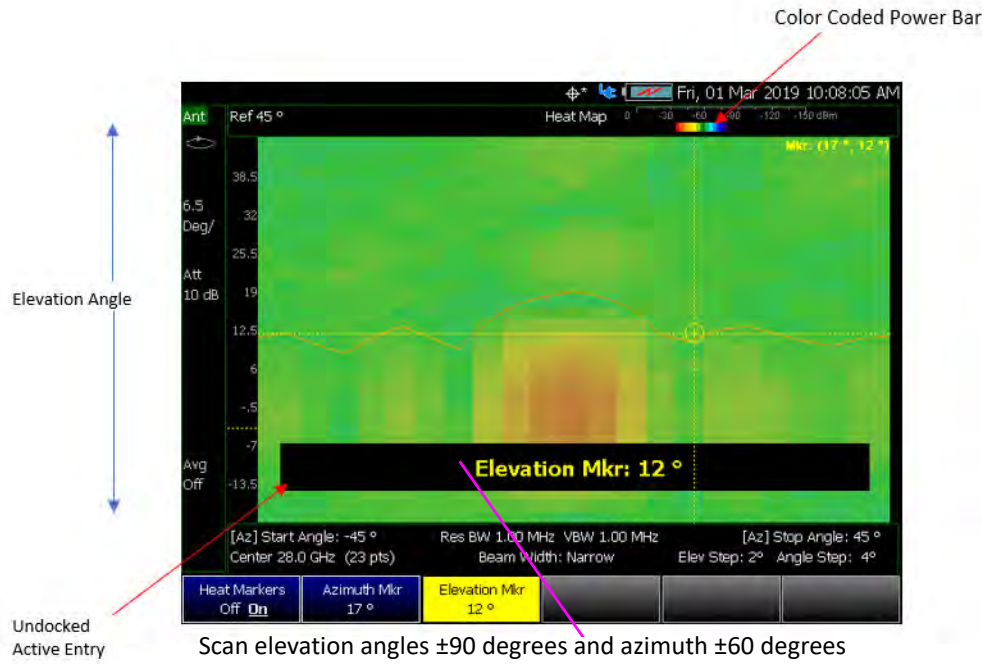
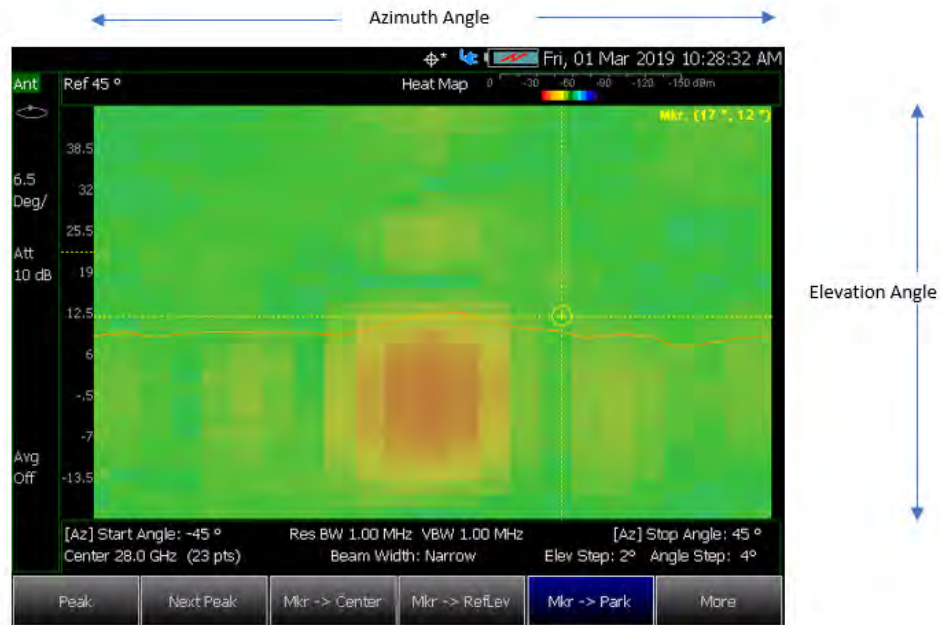

Figure 14-5 Heat Map and Undocked Active Entry – Parked Antenna



Scan Elevation Angle (Y) vs Azimuth Angle (X)



- Select [Mkr > Park] to park the antenna at fixed elevation, azimuth.
- Marker value shows (azimuth, elevation) pair on Heat Map

Figure 14-6 Polar Assign Orientation and Polar with Compass Orientation

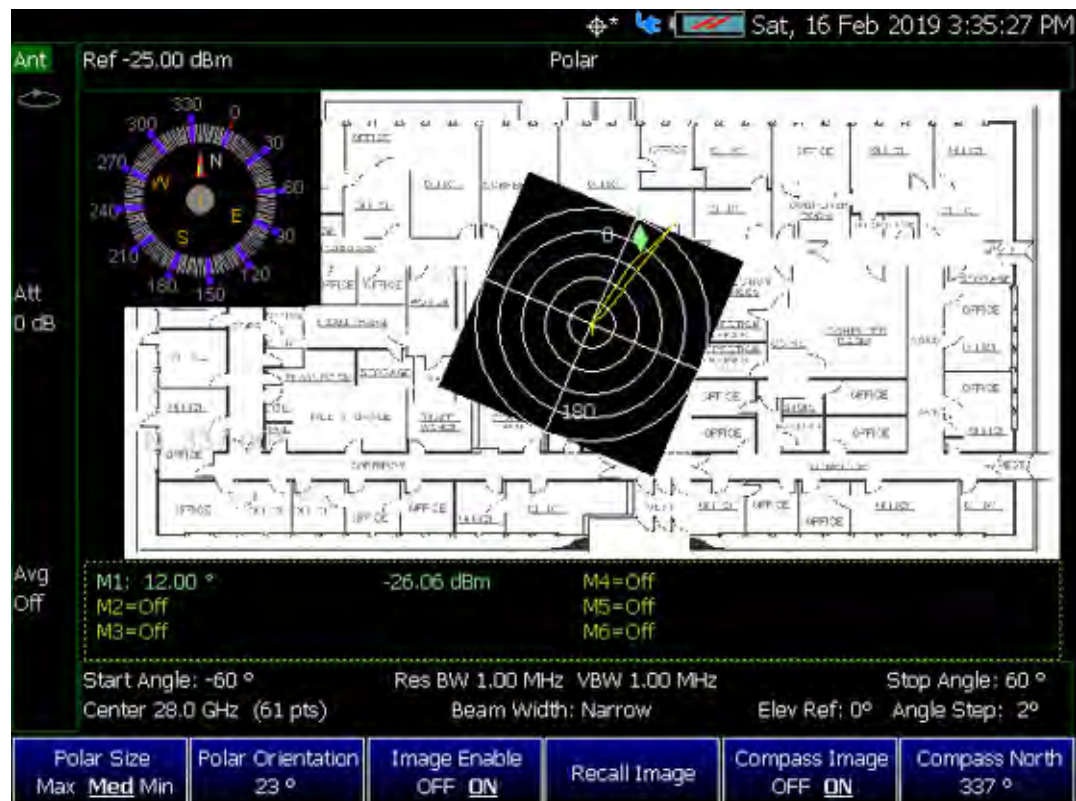
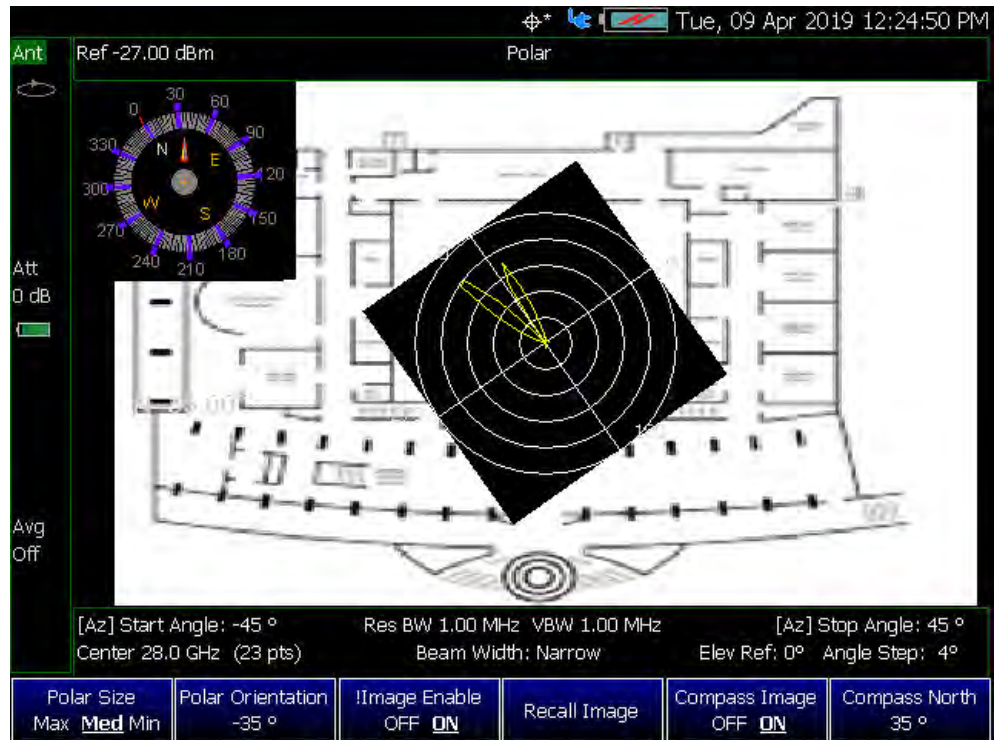

Figure 14-7

Polar Measurement with Compass with Recalled Image of Indoor Auditorium



CW vs. Pulsed RF Measurements

NOTE

IMPORTANT! For pulsed RF measurements, increasing the Dwell Time is recommended for faster throughput and accurate signal capture in a single sweep.

Figure 14-8

Bore-Site Measurement with CW RF (Dwell Time=10 ms, Max Hold=OFF)

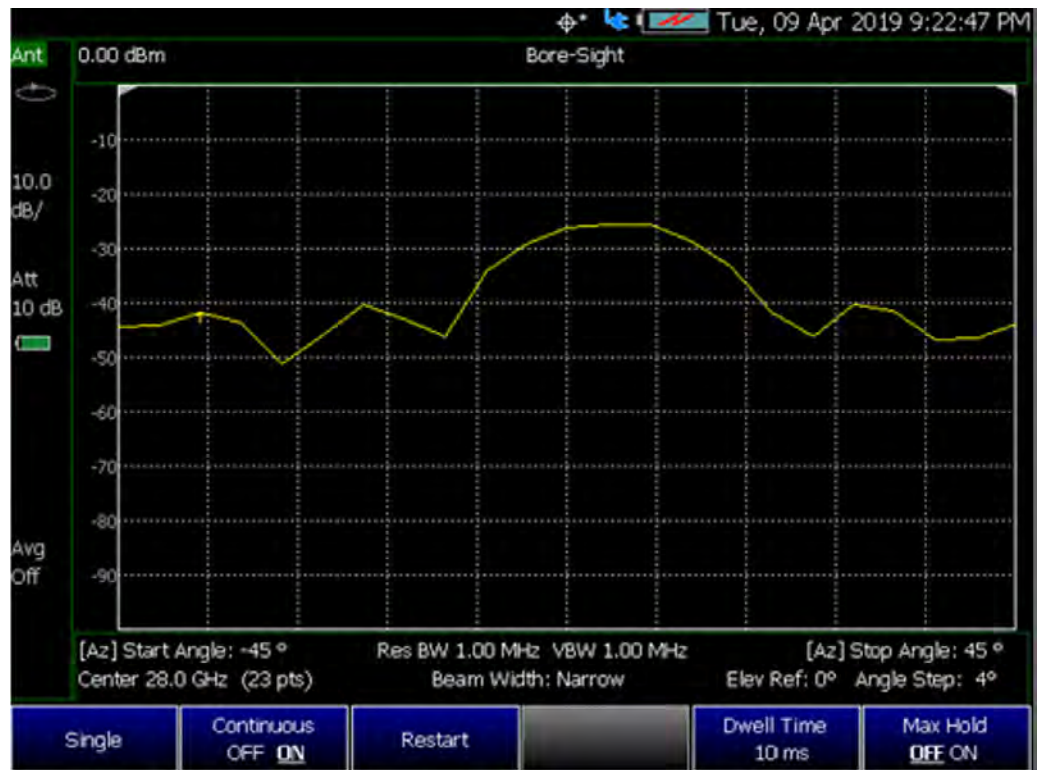

Figure 14-9 Bore-Site Measurement with Pulsed RF (Dwell Time=10 ms, Max Hold=OFF)

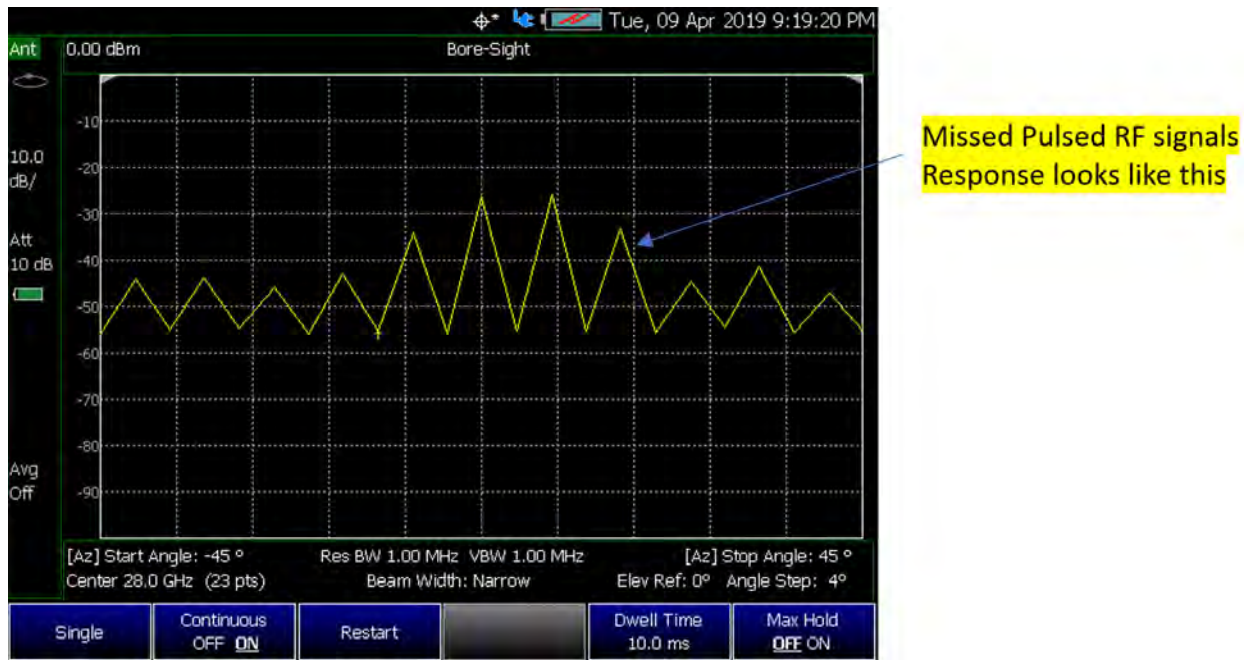

Figure 14-10 Bore-Site Measurement with Pulsed RF (Dwell Time=100 ms, Max Hold=OFF)



How to Set Up Phased Array Antenna Settings

NOTE

IMPORTANT! See also, “Alignments” on page 211, in NA mode, Chapter 9, “SA (Spectrum Analyzer) Mode (Option 233–Mixed Analyzers),” and Chapter 10, “RTSA (Real-Time Spectrum Analyzer) Mode–Option 350 (CPU2 Only)” mode.

This section reviews the steps in setting up an Option 360 measurement. If you are not familiar with this process or would like more information, refer to “How to Define a Set Up a Scan and Use Option 360”

This section consists of:

- “Option 360 Setup Procedure”

Figure 14-11 Setting Up Option 360 Using Other Modes

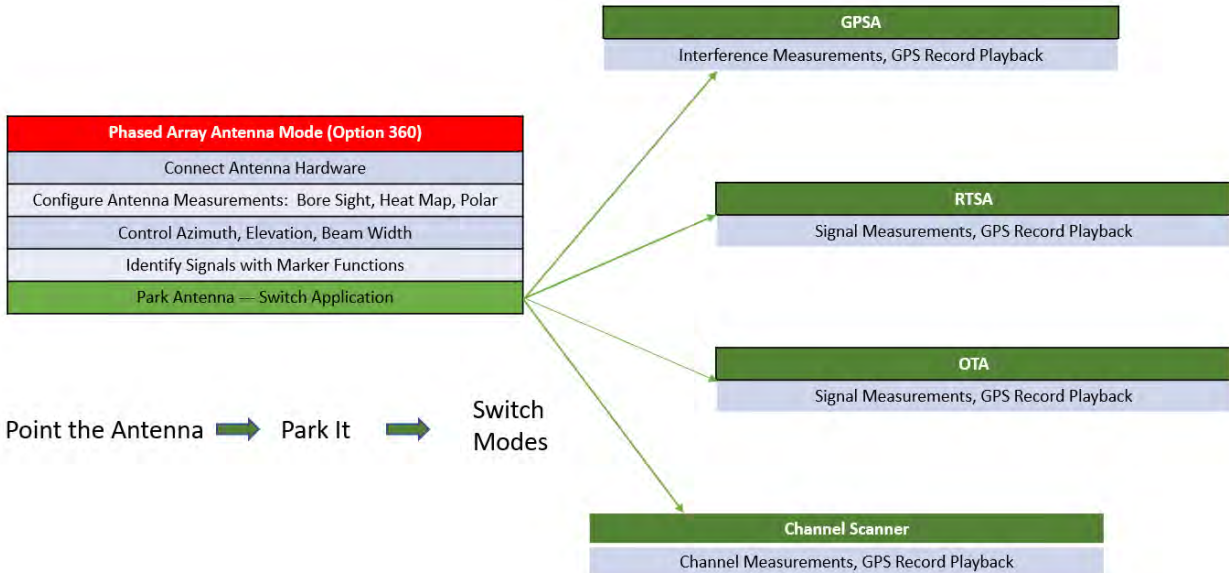

Option 360 Setup Procedure

1. Connect your equipment similar to Figure 14-1 on page 399.
2. Set FieldFox to use static IP address:

Press **System**

- Then **System Configuration** > **More** > **LAN**

- a. In the Setting screen, use the ▲▼ arrows, the rotary knob, or numeric keypad to highlight Obtain IP.
- b. Press Edit > **Obtain IP Static**

- c. Press **Done Edit** > **Done**

NOTE

IMPORTANT! The LAN address for first 3 fields must match the Static IP address of FieldFox. For example, if the Ball Antenna IP address is **192.168.1.10**, set FieldFox Static IP address to **192.168.1.xx**. “xx” must be different number than shown in the last field of the for Ball Antenna. Refer to **Figure 14-15 on page 417**.

IMPORTANT! If you forget you N9910X-028 Ball Antenna’s static IP address, refer to this link and the **Support** tab for assistance: www.keysight.com/find/fieldfox and then to the **Phase Array Antenna Support Document**.

3. Selecting phased array antenna mode using the Antenna Wizard:

- a. Press **Measure**.
- b. Then **Antenna Wizard**
- c. Follow the prompts. See **Figure 14-12**.

NOTE

Once the connect is correct, the FieldFox’s displayed annotation indicating "Check LAN connection. Check IP address." is no longer displayed during pinging of the Host IP address.

Figure 14-12 Antenna Wizard Screen



4. Aligning the antenna’s azimuth and elevation orientation:

Refer to **Figure 14-14 on page 410**.

Figure 14-13 Site Wide LAN Configurations and Field Measurements Configurations

i. System > System Configure > More LAN

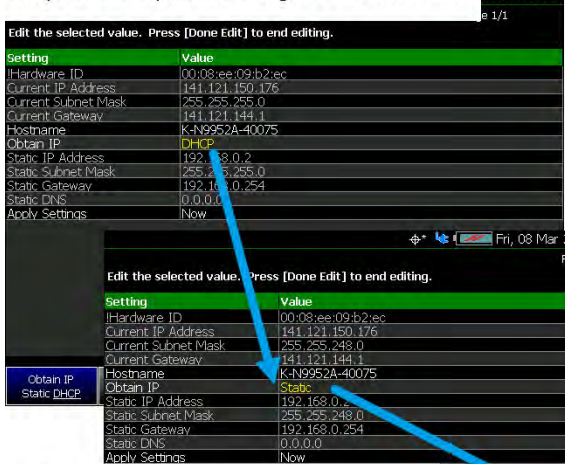

View Ball Antenna Default Static IP address:
 Measure > Ant LAN IP



ii. Set **Obtain IP** to **Static**.

iii. Press **Done Edit**

iv. Press **Clear**, then set **Static IP** address to **192.168.0.2** and

v. Then **Done**.



Static IP Address with unique Static IP 4th field.

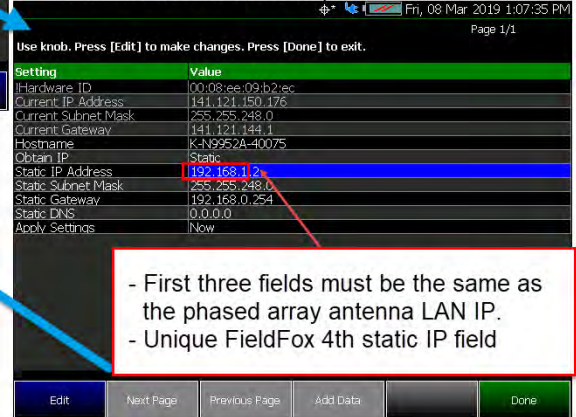

- v. Repeat steps. iii and iv for:
 - **Static Subnet Mask** to **255.255.255.0**
 - **Static Gateway** to **192.168.0.254**
- vi. Scroll to **Apply Settings**, then press **Edit**, then select **Now**
- iv. Then **Done Edit** > **Done**

- First three fields must be the same as the phased array antenna LAN IP.
 - Unique FieldFox 4th static IP field

Figure 14-14 Site Wide LAN Configurations and Field Measurements Configurations

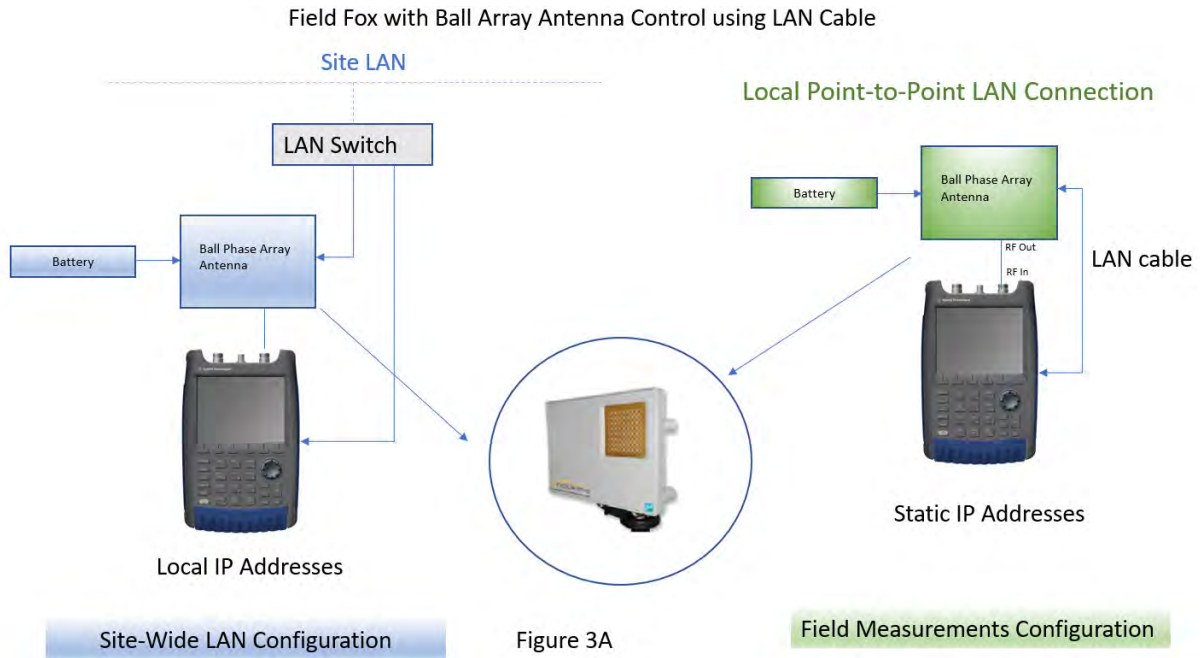

Azimuth and Elevation Alignment Orientation Diagram



Antenna Orientation Diagram

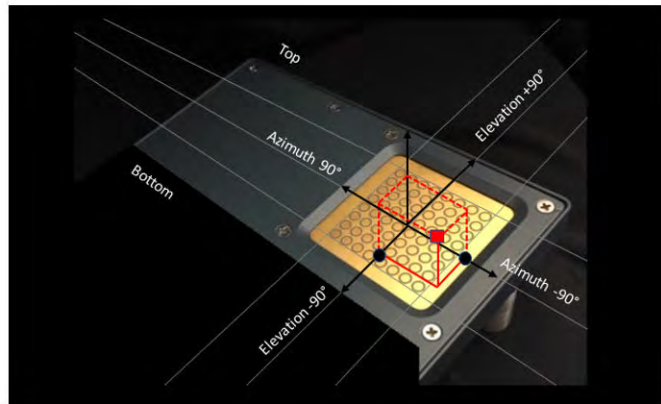

5. Entering the phased array antenna measurement type:

Refer to **“Data Formats:” on page 398.**

Select **Measure**:

- **Measure**—choose:
 - **Bore-Sight** or
 - **Heat Map** or
 - **Polar ANT** or
 - **Park ANT**

6. Using the table to enter phased array antenna settings, presetting the antenna, setting the antenna LAN IP, and clearing the graphics:

Refer to **Figure 14-16 on page 418.**

Select **Meas Setup**:

- **Antenna Settings**—choose:
 - **Ball Antenna** > LAN Address
 - **Settings**—choose:
 - Res BW or
 - Video BW
 - Beam Width
 - **Array Antenna**—choose:
 - Center
 - Azimuth Ref
 - Elevation Ref
 - **Polar Display** >Ref
 - **Sweep** > **Dwell Time** (Optional. For pulsed RF measurements it is recommended that the Dwell Time is increased.)
 - **Sweep** > **Max Hold** (Optional. For pulsed RF measurements it is recommended that Max Hold is set to OFF when using the Heat Map display. (Default = OFF).)
- **Preset Antenna** presets the antenna settings factory defaults.
- **Ant LAN IP** enter the Ball antenna’s LAN IP. First three fields must match the FieldFox’s static IP address (default: 192.168.1.10). Refer to **Figure 14-15 on page 417.**

- **Clear Graphics** If applicable, this clears the current displayed PNG graphic from the screen.

NOTE

If after making the setting changes in the steps below, no data is displayed, refer to **“Troubleshooting” on page 433**.

7. User markers to identify azimuth and elevations settings:

Select **Marker** –choose:

- **Marker 1 2 3 4 5 6** – You can set up to six markers. The OFF, Normal, Delta, or Peak softkey is black to indicate the current setting of each marker.
- **Normal** displays a marker.
- **Delta** displays a marker relative to another active marker.
- **Peak** displays a marker on the peak point of the displayed trace.
- **More** – choose.
- **Marker Trace** – You can set up to four traces.
- **Marker Table** – Enable or disable the marker table that displays the current markers and their values.

Learn more about markers. Refer to the **Chapter 29, “Data Analysis Features.”**

See also **Figure 14-5 on page 402**.

8. Enable the Data Logging settings:

- Press **Trace 6** > **Data Logging** then
 - **Record** (Outdoor Logging) or
 - **Play** (If you have previously stored data recordings.) or
- To set **Data Logging** –choose:

a. Outdoor Mapping only: **Record Settings** then choose:

- Optional: Then **Meas Interval** > **ON**
- Then **Interval Type** > choose **Time** or **Distance**.
- Then, if applicable **Time Interval** enter time interval in seconds.
- Or
- Then, if applicable **Distance Interval** enter distance interval in meters.
- Then **Back**

- b. **Record Save/Recall** (If you have previously stored data recordings.)
- **Save Log File** or
 - **Recall Log File** or
 - **User Folder Def System** (Default = Default) or
 - **File Type** (Default = KML) CVS or DREC (DREC is only available with Option 360 only)
 - Then **Auto Save OFF ON** (Default = OFF).

CAUTION

Spectrum information is not recorded. Only the TableChart data are saved. See [“How to Record a Data Log” on page 430.](#)

NOTE

Data Log-Play files are saved to:

- If File Folder is set to Default then Data Log-Play files are save-recalled to: "[CurrentDevice]\RecordPlayback\PAA"
 - If File Folders are set to System, then Data Log-Play files are save-recalled to: "CurrentDevice\\
-

NOTE

Learn more about file settings, refer to [Chapter 32, “File Management.”](#)

- c. Optional: Press **Indoor Map Data Logging** then
- **Record Indoor Data** or **Recall Indoor Log File**. Learn more, refer to [Chapter 16 Mapping](#) and [“Setting up Data Logging” on page 475.](#)

9. Press **Back** to return to previous menu.

10. If recording, then:

- **Pause Resume** Temporarily halts recording until pressed again. The incoming trace continues to sweep. Press again to continue recording.
- **Stop** Immediately
 - The Save the log file menu opens. Edit the filename and press Done to exit menu. See Settings below and [“To change Data Logging Configuration settings:” on page 430.](#)
 - To change your file settings or measurement interval. Learn more, refer to [“To change Data Logging Configuration settings:” on page 430.](#)
- (Press **Record** to begin a new recording.)

- Then **Maps** To enable map view and related features (e.g., Data Selection, Red/Blue Limits, Labels & Icons, Zoom).

Then choose from the following:

- **View Map OFF ON** To enable/disable the current map view (default = latitude/longitude = 0.00/00. Need GPS to view current location (default = OFF).
- **Data Selection** Opens a softkey menu to set the active data channel, sort type, and sort order.

Learn more, refer to [Chapter 16 Mapping](#) and [“Setting up Data Logging” on page 475](#). See also, [Chapter 32, “File Management.”](#)

- **Red/Blue Limits** Opens a softkey menu to assign power values to the red (high power limits) and blue (low power limits) heat map display limits (defaults: Red Limit = -20 dBm, Blue limit = -90 dBm).
- **Labels & Icons** Opens a softkey menu to enable/disable map data point labels and icon types.

Labels OFF ON	Enables/Disables map data point labels. When enabled, a label is displayed for every map data point (e.g., “Data 1”). When disabled, labels are not displayed for the map data points.
Icons Flag Point Line	Sets the type of icon that is used to display a map’s data points.

- **Save Image (PNG)** Saves the current displayed map to a *.png file (default filename is "MapImageFile").

NOTE

Data Log-Play files are saved to:

- If File Folder is set to Default then Data Log-Play files are save-recalled to: "[CurrentDevice]\RecordPlayback\PAA"
- If File Folders are set to System, then Data Log-Play files are save-recalled to: "CurrentDevice\\

11. Export KML file into 3rd party mapping software (i.e., Google Map or Google Earth). Refer to [“Step 7: Import and Play back KML Files into 3rd Party Software \(Example: Google Earth with Animation Tool\)” on page 426](#).

12. Select **Trace 6**—choose:

For this step, refer to [Figure 14-6 on page 403](#).

- **Polar Size Max Med Min** Sets the size of the polar display. Smaller sizes used to overlay PNG maps. (Default = Max)

- **Polar Orientation** Aligns the antenna polar display to a selected direction.
- **Image Enable OFF ON** (Optional to overlay antenna bore-sight direction. Only active if you have recalled a PNG image to display on the FieldFox as a map. (Default = OFF)
- **Recall Image** Use to recall PNG map to overlay antenna direction.
- **Compass Image OFF ON** To display a compass indicating true north for antenna. (Default = ON)
- **Compass North** Use this softkey to align the compass' true north value in degrees.

Repeat process as needed for additional settings.

13. Optional: Press **Freq/Dist**

- Press **Antenna Settings** opens the table antenna settings softkey menu, where you can define your phased array antenna settings, Ball Antenna: LAN address, Settings: Resolution BW, Video BW, Beam Width, Array Antenna: Center frequency, Azimuth Ref, Elevation Ref, and Polar Display: Ref. For details, refer to step 6 above.
- Then **Start Azimuth** +/-45 degrees. (Default = 45 degrees)
- Then **Stop Azimuth** +/-45 degrees. (Default = 45 degrees)
- Then **Ref Elevation** +/-45 degrees. (Default = 0 degrees)

14. Optional: choose change sweep, dwell time, and max hold settings:

Press **Sweep**

Then choose:

- **Dwell Time** to set the delay between the antenna positioning from 1 ms to 10 seconds (default: 10 ms). For pulsed RF measurements it is recommended that you increase the Dwell Time to ~100 ms.
- **Max Hold** For pulsed RF measurements, it is recommended that Max Hold is set to OFF when using the Heat Map display. (Default = OFF)
- **Single**
- **Continuous** to enable or disable the continuous sweep (default: ON).

Learn more, refer to [Chapter 9, “SA \(Spectrum Analyzer\) Mode \(Option 233–Mixed Analyzers\).”](#)

- **Restart**

15. Optional: choose devices and save files:

Press **Save/Recall**

Then choose:

- **Save** to set the attenuator power (default: –10 dB). Set to **0 dB**.
- **Recall** change to **ON**.
- **Device** to set the absolute power (dBm)
- **File Type** then choose:
 - **State** Saves the current state settings
 - **Trace+State** Saves the current Trace+State information
 - **Picture (PNG)** to save the current displayed trace as a PNG
 - **Data (CSV)** save files as a CSV file

Learn more, refer to [Chapter 32, “File Management.”](#)

16. Optional: Modify scale and amplitude values:

Press **Scale/Amptd**

Then one of the following:

- **Autoscale** Automatically adjusts the Y-axis minimum and maximum values.
- **Scale** Manually enter a **scale per division** values.
- Others: **Scale**, **Ref Level**, etcetera as desired.

Learn more, refer to [Chapter 29, “Data Analysis Features.”](#)

17. Optional: Modify the averaging and Integrated BW settings:

Press **BW**

Then one of the following:

- **Average Enable OFF ON**
- **Average Count**
- **Integ BW**

Learn more, refer to [Chapter 29, “Data Analysis Features”](#) and [Chapter 9, “SA \(Spectrum Analyzer\) Mode \(Option 233–Mixed Analyzers\).”](#)

Figure 14-15 Example of Phased Array Antenna and FieldFox Static IP Setup - First Three Static IP Fields Are the Same

Setting the phased array antenna IP address



Setting the FieldFox static IP address - First three fields the same as the antenna



Figure 14-16 Example Antenna Settings Table



How to Define a Set Up a Scan and Use Option 360

You can define measurements by selecting which type of data to display.

Data definitions consist of the following:

- Select the measurement type
- Define the antenna setting, using the antenna settings table
- Define other optional marker, sweep, averaging, bandwidth settings

Example: Refer to:

- “[Step 1. Connect Your Equipment](#)” on page 419
- “[Step 2. Set FieldFox to Use Static IP with Your Ball Antenna](#)” on page 419
- “[Step 3. Define the measurement](#)” on page 420

Then:

- “[Step 4: Select Polar Settings](#)” on page 422
- “[Step 5. Modify Scale and Attenuator Settings](#)” on page 422
- “[Step 6: Enable Data Logging and Playback the Results](#)” on page 423
- “[Step 7: Import and Play back KML Files into 3rd Party Software \(Example: Google Earth with Animation Tool\)](#)” on page 426

Step 1. Connect Your Equipment

Connect your equipment similar to [Figure 14-1 on page 399](#).

Step 2. Set FieldFox to Use Static IP with Your Ball Antenna

NOTE

IMPORTANT! The LAN address for first 3 fields must match the Static IP address of FieldFox. For example, the Ball Antenna’s factory IP address is **192.168.0**.10, set FieldFox Static IP address to **192.168.0**.xx. “xx” must be different number than shown in the last field of the for Ball Antenna. Refer to [Figure 14-15 on page 417](#).

IMPORTANT! If you forget you N9910X-028 Ball Antenna’s static IP address, refer to this link and the **Support** tab for assistance: www.keysight.com/find/fieldfox and then to the **Phase Array Antenna Support Document**.

-
- The Ball antenna’s default static IP address is: 192.168.1.10
 - Set FieldFox to use static IP address:

Press **System**

- Then **System Configuration** > **More** > **LAN**

1. In the Setting screen, use the ▲▼ arrows, the rotary knob, or numeric keypad to highlight Obtain IP.
2. Press **Obtain IP Static**
3. Press **Clear**, then set the **Static IP Address** to: 192.168.1.2
and
4. Press **Done**
5. Press **Clear**, then set the **Static Subnet Mask** to:
255.255.255.0
and
6. Press **Done**
7. Press **Clear**, then set the **Static Gateway** to: 192.168.1.254
and
8. Press **Done**
9. Using the ▲▼ arrows, the rotary knob, or numeric keypad to select Apply Settings.
10. Press **Edit**, then select **Now**.
11. Press **Done Edit** > **Done**

Step 3. Define the measurement

1. Press **Preset** then **Mode Preset (Factory)**
2. Selecting Phased Array Antenna mode: Press **Mode** > **Phased Array Antenna**. Depending on the number of options loaded on your FieldFox, it may be necessary to press **More**.
3. Optimizing the FieldFox to scan for signals:
 - a. Run the Antenna Wizard: Measure > **Antenna Wizard** and follow the prompts.
 - b. Set the **Measure** type (i.e., Bore-Sight, Heat Map, Polar ANT, or Park ANT).

See also “How to Set Up Phased Array Antenna Settings” on page 407.
 - c. Set the **Meas Setup** > **Antenna Settings** table:
 - Ball Antenna: LAN address
 - Settings: Res BW, Video BW, and Beam Width

- Array Antenna: Center frequency, Azimuth Ref, and Elevation Ref
- Polar Display: Ref

See also “How to Set Up Phased Array Antenna Settings” on page 407.

d. Optional: **Measure** > **Data Logging**:

- **Record Settings** (Outdoor Mapping only) then choose
 - **Measure Interval OFF ON**
 - **Interval Type Time Distance**
 - **Time Interval** if applicable (only active when Interval Type = Time) or
 - **Distance Interval** if applicable (only active when Interval Type = Distance)
 - **Auto Save OFF ON**
 - **Back** to return to previous menu

e. **Record Save/Recall** (Save Log File, Recall or

f. **Record** or

g. **Play** if you have a previously stored data scan

See also “How to Set Up Phased Array Antenna Settings” on page 407 and “Step 6: Enable Data Logging and Playback the Results” on page 423.

Learn more, refer to Chapter 16 Mapping and “Setting up Data Logging” on page 475

h. Optional: Press **Sweep 3** and modify/select items:

- **Single**
- **Continuous OFF ON** to ON (default)
- **Restart**
- **Dwell Time** For pulsed RF measurements, it is recommended that the Dwell Time is increased to ~100 ms. Default = 10 ms.
- **Max Hold** For pulsed RF measurements, it is recommended that Max Hold is set to OFF when using the Heat Map display. (Default = OFF)

NOTE

IMPORTANT! It is **not** sufficient to be locked to the GNSS satellite, the frequency reference must be locked to GPS. Refer to Chapter 30, “System Settings” and then to “How to make GPS settings” on page 749.

Step 4: Select Polar Settings

Select one of the following display orientations:

Select **Trace 6**—choose:

For this step, refer to **Figure 14-6 on page 403** and see also **“How to Set Up Phased Array Antenna Settings” on page 407**.

- **Polar Size Max Med Min** or
- **Polar Orientation** or
- **Image Enable OFF ON** or
- **Recall Image** or
- **Compass Image OFF ON** or
- **Compass North** or

Step 5. Modify Scale and Attenuator Settings

To set the scan’s scaling and receiver corrections:

Learn more, see **“How to select and edit corrections for Field Strength measurements” on page 172**.

1. Press **Scale/Amptd** > **Corrections** then choose:

- **Apply Corrections OFF ON**
- **RcvrSide Antenna** then choose:
 - **Antenna OFF ON**
 - **Edit Antenna**
 - **New**
 - **Save Antenna**
 - **Recall Antenna**
 - **Storage Device**
- **RcvrSide Cable** then choose:
 - **Cable OFF ON**
 - **Edit Cable**
 - **New**
 - **Save Cable**
 - **Recall Cable**

- **Storage Device**

2. Press **Scale/Amptd** then choose:

- **Autoscale**
- **Unit dBm**
- **External Gain**
- **External Gain**

Step 6: Enable Data Logging and Playback the Results

CAUTION

Spectrum and Strip Chart information is not recorded. Only the Table and Bar Chart data are saved. See [“How to Record a Data Log” on page 430.](#)

GPS must be enabled for the log results to include a GPS stamp or use Preferences to enable the timestamp. Refer to [Chapter 30, “System Settings.”](#)

Features

- Log files contain cell results for different component carriers (CCs) including timestamps and/or distance stamps.
 - Timestamps are included in log files with or without GPS.
 - GPS must be enabled for log altitude results.
- Data results can be logged
- Data results can be saved to a *.CSV, DREC (Option 360 only), or *.KML file. Refer to [“To change Data Logging Configuration settings:” on page 430.](#)
- User specifies how often results are stored.
 - Time: Store results every “n” seconds
 - Altitude: Store results every “n” meters. GPS must be enabled to store results by altitude.

Procedure

1. Press **Trace 6** > **Data Logging** to view the Data Logging softkeys and set the **Record Settings**, **Record Save/Recall**, and **Indoor Map Data Logging**.
 - **Record** (Outdoor Logging) or
 - **Play** (If you have previously stored data recordings.)
 - a. **Outdoor Mapping only:** To set the **Record Settings**—choose:
 - **Meas Interval**
 - **Interval Type** Time or Distance

- **Time Interval** or
- **Distance Interval**
- b. Then press **Record Save/Recall**
 - Then **File Folder Default System**
 - **Default** – Sets the default User Folder path:
 - List files (*.csv and *.kml) are save-recalled to:
"[CurrentDevice]:\RecordPlayback\
PAA\"
 - Data Log-Play files are save-recalled to:
"[CurrentDevice]:\RecordPlayback\
PAA\"
 - Or
 - **System** – Sets the User Folder to the user defined system folder path/name:
 - List files are save to-from
"CurrentDevice\<<UserSelectedFolder>\"
 - Data Log-Play files are save-recalled to:
"CurrentDevice\<<UserSelectedFolder>\"
 - Refer to **"File Management" on page 767.**
 - Then **File Type**
 - KML (default) or
 - CSV
 - DCREC (Option 360 only)

NOTE

Three file types are supported for save or recall log results:

- KML file format
 - Files stored in this format can be imported into 3rd party applications like Google Earth or Google Maps.
- CSV file format. Files stored into this format can be imported into spreadsheet applications.
- DREC file format. This file type is a binary file. File contains recorded state and trace data, with GPS time and locations stamps if enabled. Available with Option 360 only.

-
- Then **Save Log File.**

or

- Then Recall Log File.
- **Auto Save (default = OFF)**
- Then **Back**

c. Optional: Press **Indoor Map Data Logging** then

- **Record Indoor Data** or **Recall Indoor Log File**. Learn more, refer to **Chapter 16 Mapping** and “**Option 352 Indoor Maps Setup Procedure**” on page 463.
- Then choose from **Navigate OFF ON**, **Data Selection**, **Zoom**, **Pan**, **Record Data**, **More**
- See also, **Chapter 16 Mapping** and “**Setting up Data Logging**” on page 475.

2. Press **Back** to return to previous menu.

3. Outdoor Mapping only: Press **Record** to begin a new recording and then

- **Pause Resume** Temporarily halts recording until pressed again. The incoming trace continues to sweep. Press again to continue recording.
- **Stop** Immediately stops recording and a “Save the Log File” menu opens to rename and save your data log file.
- (Press **Record** to begin a new recording.)
- Then **Maps** To enable map view and related features (e.g., Data Selection, Red/Blue Limits, Labels & Icons, Zoom).
 - **View Map OFF ON** Displays the current GPS location.
 - **Data Selection** Opens a softkey menu to set the active data channel, sort type, and sort order. See also previous step 10 in “**How to Set Up Phased Array Antenna Settings**” on page 407.
 - **Red/Blue Limits** Opens a softkey menu to assign power values to the red (high power limits) and blue (low power limits) heat map display limits (defaults: Red Limit = -20 dBm, Blue limit = -90 dBm).
 - **Labels & Icons** Opens a softkey menu to enable/disable map data point labels and icon types.

Labels OFF ON

Enables/Disables map data point labels. When enabled, a label is displayed for every map data point (e.g., “Data 1”). When disabled, labels are not displayed for the map data points.

Icons
Flag Point Line

Sets the type of icon that is used to display a map's data points (default = Flag).

- **Save Image (PNG)** Saves the current displayed map to a *.png file (default filename is “MapImageFile”).

4. When done press **Stop**. The log file is automatically saved to the defined Device Type and File Type.

Else, edit the User Folder and File Type, under **Record Save/Recall** where the file results will be stored.

NOTE

Learn more about file settings, refer to the [Chapter 32, “File Management”](#).

5. Press **Back**

Playing a Data Log and Viewing the Data

To play the log results:

1. Press **Record Save/Recall** > **Recall Log File**

And, use the Use the RPG or the **▲▼** arrow keys to highlight the file to be played.

2. Press **Recall File** > **Back** > **Play**

3. Press **Stop** to exit the log playing.

To pause the log play:

1. Press **Pause Resume** to pause or resume the log playing.

2. Press **Stop** to stop the log playing.

Learn more, refer to [Chapter 16 Mapping](#) and [“Setting up Data Logging” on page 475](#). See also, [Chapter 32, “File Management.”](#)

Step 7: Import and Play back KML Files into 3rd Party Software (Example: Google Earth with Animation Tool)

Features

Use the Playback Slider to replay measurement results. See also Google Maps and or Google Earth's help. Refer to [Figure 14-17 on page 427](#).

- Open the FieldFox *.KML file in Google Earth. The time slider appears in upper left of the map.
- Manual Mode – Move the time slider cursor to see color-coded icons pop-up according to the timestamp.

5G Rapid Prototype Phased Array Antenna – Option 360 How to Set Up Phased Array Antenna Settings

- Loop mode has a Fast-Slow Replay Option.
- Click on each color coded balloon to see the table of measurement results for that location.

Figure 14-17 Importing a KML File Into Google Earth

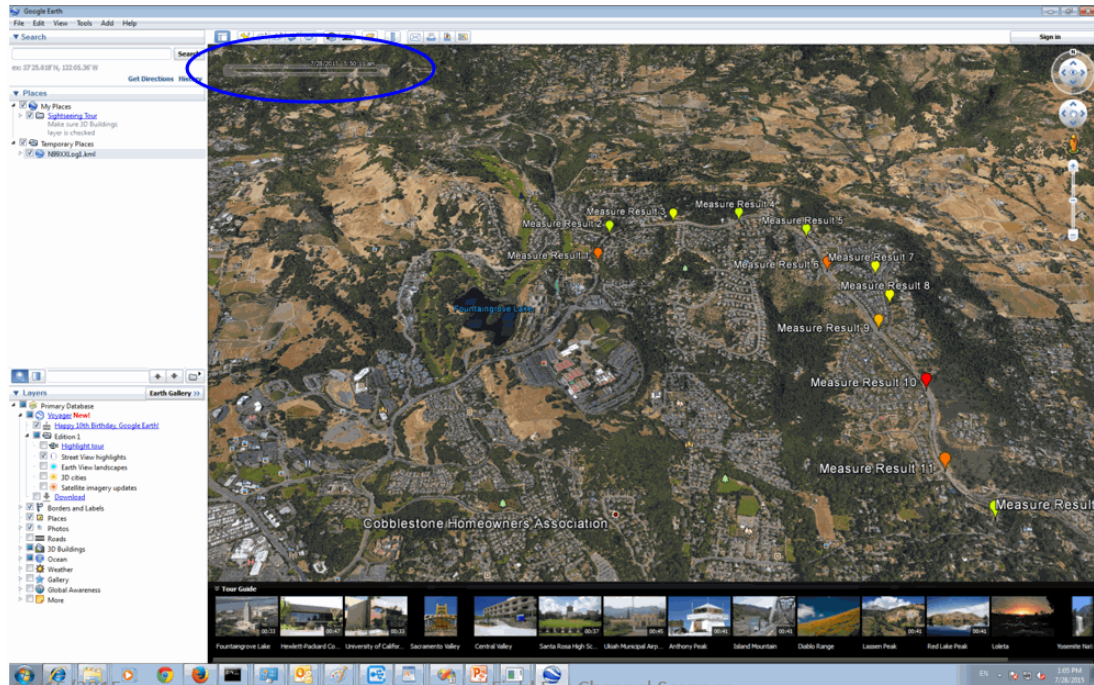

How to Use Data Logging/Playback (Option 360)

NOTE

Data log-Play files are saved to:

- If File Folder is set to Default then Data Log-Play files are save-recalled to: "[CurrentDevice]\RecordPlayback\PAA"
- If File Folders are set to System, then Data Log-Play files are save-recalled to: "CurrentDevice\\"

Data Logging and Playback enables you to log phased array antenna trace data and play them back at a later time. Use this feature to monitor table data activity over a period of time.

Data logs can be saved to the FieldFox Internal memory, an SD Card, or a USB flash drive.

This section assumes you have already completed the initial setup and have a phased array antenna scan displayed on the FieldFox.

Screen Annotation

During a data logging or playback session, the following is displayed in the top-center area of the screen:

– **Rec: 55/55 2018-12-31 03:26:11 PM**

where:

- **55/55** is the current and total trace number: currently trace is 55 of 55 total scans.
- **2018-12-3103:26:11 PM** is the date and time of recording.
- The name of a recording can be changed using Manage Sessions. Learn more in [“To change Data Logging Configuration settings:” on page 430](#).

See also, the FieldFox User’s Guide’s “System Settings” chapter.

When GPS is enabled, **GPS R** is indicated at the bottom of the FieldFox display. Learn more, see the FieldFox User’s Guide’s “System Settings” chapter.

The Phased Array Antenna mode can display and be data logging/played back in field strength units, when the units are changed:

- Press **Scale /Amptd** > **More** > **Unit** then choose:
 - **dBmV**, **dBuV**, **W**, **V**, **A**, **dBmA**, or **dbuA** (Default Units: dBm)

See [Figure 14-18 on page 429](#).

Figure 14-18 Field Strength Annotation that can be Recorded and Played Back

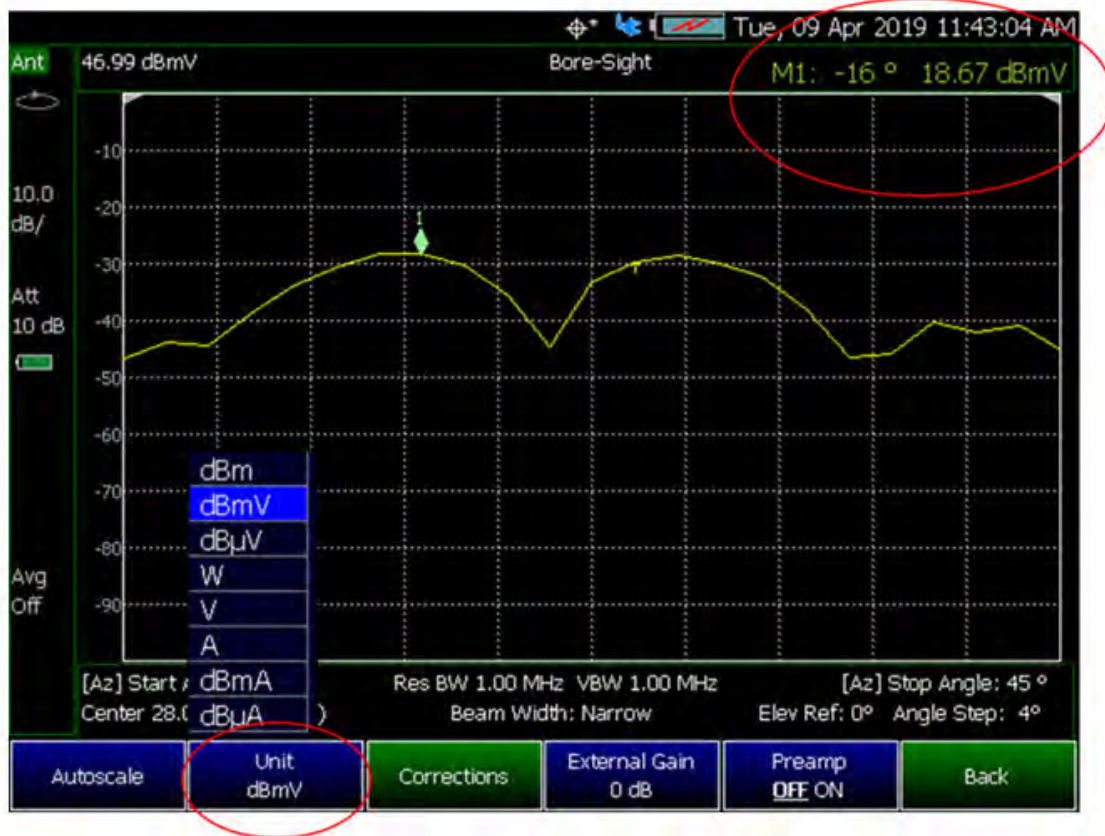

NOTE

If Data Logging or Playback is not occurring when you think it should, check the following:

- Is the sweep in HOLD? (upper-left annotation), or check the Sweep menu for Continuous set to OFF.
- Is Recording or Playback Paused? (mid-left annotation)
- Is the Data Logging or Playback Interval set too long? (Configuration settings.)

How to Record a Data Log

NOTE

Data Log-Play files are saved to:

- If File Folder is set to Default then Data Log-Play files are save-recalled to: "[CurrentDevice]\RecordPlayback\PAA"
 - If File Folders are set to System, then Data Log-Play files are save-recalled to: "CurrentDevice\
-

- Press **Trace 6**
- Then **Data Logging**
- Then **Record**

REC is displayed in the left of screen graticules.

During recording, choose from the following:

- **Pause Resume** Temporarily halts recording until pressed again. The incoming trace continues to sweep. Press again to continue recording.
- **Stop** Immediately stops recording. Then choose from the following:
 - Then **Record Save/Recall** To save a log file, recall logs, or change your file settings. Learn more, refer to **“To change Data Logging Configuration settings:” on page 430.**
 - Press **Save Log File** to save the current Table data (i.e., default save device is Internal).
 - Then **Record Settings (Outdoor Mapping only)** To change your measurement interval settings. Learn more, refer to **“To change Data Logging Configuration settings:” on page 430.**

To change Data Logging Configuration settings:

- Press **Trace 6**
- Then **Data Logging** then choose:
- Then **Record Settings (Outdoor Mapping only)**
 - Optional: Then **Meas Interval** > ON
 - Then **Interval Type** > choose **Time** or **Distance**.
 - Then, if applicable **Time Interval** enter time interval in seconds.
 - Or
 - Then, if applicable **Distance Interval** enter distance interval in meters.

- Then **Record Save/Recall**
 - Then **Device** (**Internal** (default), **SD Card**, or **USB**)
 - Then **File Type** (**CSV**, **DREC** (Option 360 only), or **KML** (default))

Learn more, refer to **Chapter 32, “File Management”**.

How to Play a Data Log

- Press **Trace 6**
- If the session is already open, skip the following step. Otherwise:
- Then **Data Logging** > **Record Save/Recall**

NOTE

If these are large recordings on a device, it could take several seconds for the FieldFox to display the list.

- Then **Recall Log File** use the Use the RPG or the **▲▼** arrow keys to highlight the file to be played.
 - Then **Recall File**
 - Then **Back**
- Then **Play** to playback your Table data.

PLAY is displayed in the left of screen graticules during playback. When the end of the recording is reached, playback begins at the start of scan and continues to loop indefinitely.

During playback, choose from the following:

- **Pause Resume** Temporarily halts playback. Then choose from the following:
 - **Pause Resume** Press to continue playing.
- **Stop** Immediately stops playback. Then choose from the following:
 - **Play** Start playback from start of scan.
 - **Recall Logs** Opens a list of stored data files.
Select a file to playback.
 - **Recall File**
 - **Back**
- **Cursor Position** use this softkey to move the data log play cursor in the current data log being played (i.e., **Cursor Position** is active only when playback is paused).

This softkey is only available in Channel Scanner and Phased Array Antenna modes (i.e., The Cursor Position softkey is **not** available for OTA mode).

- **Red Limit** to edit the red limit dBm value.
- **Blue Limit** to edit the blue limit dBm value.

Using Mapping

The Phased Array Antenna mode has indoor and outdoor mapping capability. Refer to **Chapter 16, “Indoor and Outdoor Mapping – Option 352 (Requires Spectrum Analyzer Mode (Option 233 on N991xA), and GPS Receiver (Option 307)).”**

Other Features Available

- **Alignments** - For information on using alignments, refer to the SA chapter’s section, **“Alignments” on page 211**.
- **Scale Settings** – For information on using scale settings, refer to the Data Analysis chapter’s section, **“All about Scale Settings” on page 714** (not all of the settings apply to OTA Option 360).
- **External Gain** - Refer to refer to the SA chapter’s section, **“External Gain” on page 169**.

Troubleshooting

If your Phased Array Antenna setup is not behaving as expected:

- Verify setup is correct by referring to “[How to Set Up Phased Array Antenna Settings](#)” on page 407.

- Attenuator set to **0 dB**
- Preamplifier set to **ON**
- Correct **Band, Channel,** and **Center** Frequency entered
- GNSS set to **Internal**
- Frequency Ref set to **GPS**
- ADC errors: Use **Scale/Amptd** > **Range** to adjust the absolute power level (dBm).

For some data views, you need to press **More** to view the **Range** softkey.

- No data displayed: Press **Meas Setup 4** then
 - Verify the correct **Antenna Settings** have been entered.
- The FieldFox’s displayed annotation indicates "Check LAN connection. Check IP address." during pinging.

Verify:

- The LAN address for first 3 fields matches the Static IP address of FieldFox. For example, if the Ball Antenna IP address is **192.168.1**.10, set FieldFox Static IP address to **192.168.1**.xx. “xx” must be different number than shown in the last field of the for Ball Antenna. Refer to [Figure 14-15 on page 417](#).
- Power is connected to the PAA. If the power is **not** connected indicator is flashing () on the left side of the FieldFox display, verify your connections.

NOTE

IMPORTANT! If you forget you N9910X-028 Ball Antenna’s static IP address, refer to this link and the **Support** tab for assistance: www.keysight.com/find/fieldfox and then to the **Phase Array Antenna Support Document**.

15 USB Antennas – (Full Capability Requires EMF Option 358, and SA mode (Option 233 Mixed Analyzers))

CAUTION

Triaxial USB antennas can be used without EMF Option 358, but with limited capability and doing so is **not** recommended or supported by Keysight.

NOTE

IMPORTANT! EMF is only compatible with 5G NR/5G NR EVM Conducted (Option 378) and SA Mode (Requires Option 233—combination analyzers). User data channels are **not** demodulated.

NOTE

For more information on the SDIA-6000 Triaxial Isotropic Antenna, refer to http://en.agos.co.kr/emf_measurement.do.

USB antennas measures signals at the **SA RF Input Port 2** connector.

USB antennas mode requires the FieldFox to have SA mode (Option 233 on combination analyzers), EMF (Option 358), GPS (Option 307), and CPU2 installed.

Recommended, but not required, preamplifier (Option 235) to improve receiver sensitivity.

With USB antennas, 377 (5G TF) network designers can ensure that networks have enough resources to carry out handovers (re-selection) when users move between cell towers on the same 5G network as well as in between 5G and 4G networks (intra/inter-radio access technology).

By integrating over-the-air (OTA) measurements with cable and antenna test (CAT), full 2-port vector network analysis, spectrum analysis, and real-time spectrum analysis (RTSA), the FieldFox can be used for base station setup and verification.

With USB Antennas (p/o EMF measurements – Option 358):

- Reduce measurement complexity with a triaxial antenna to capture energy radiated from gNB
- Calibrated metrology milli-meter wave triaxial antenna simulates 5G UE antenna performance
- Troubleshoot the 5G radio access network with 3D test coverage and path loss measurements utilizing the built-in CW generator

USB Antennas – (Full Capability Requires EMF Option 358, and SA mode (Option 233 Mixed Analyzers))

- Triaxial antenna performance verification showing bore sight, polar antenna pattern with compass, heat map and beam sweep to map display views
- Measure and display corrected field strength in RMS average power
- Antenna control and X, Y, and Z antenna factors can be downloaded via a USB

Figure 15-1 FieldFox With USB Antenna



In this Chapter

“Using USB Antennas” on page 438

“About USB Antenna Measurements” on page 439

– “USB Antenna Features” on page 439

“How to Set Up a USB Antenna” on page 441

– “USB Antenna Setup Procedure” on page 441

“Other Features Available” on page 445

– Alignments (SA chapter) – “Alignments” on page 211

– External Gain (SA chapter) – “External Gain” on page 169

– Record Playback – “Record/Playback (SA Option)” on page 510

– Scale Settings – “All about Scale Settings” on page 714

“Troubleshooting” on page 446

See Also

“Why and When to Calibrate” on page 134

Chapter 30, “System Settings.” (Changing display colors)

Chapter 32, “File Management.”

Using USB Antennas

CAUTION

Triaxial USB antennas can be used without EMF Option 358, but with limited capability and doing so is not recommended by Keysight.

USB antennas enables you to do the following:

Measures electro-magnetic fields (EMF) for radio frequencies in proximity of radio and television stations, and repeaters for cell phones^a

Seven Independent Antenna/Cable Amplitude Correction Types:

- | | |
|-------------------------------|----------------------------|
| – Triaxial antenna (X/Y/Z) | – Antenna – Source Side |
| – Cable – triaxial connection | – Antenna – (Triaxial off) |
| – Cable – Receiver Side | – Source and |
| – Antenna – Receiver side | – Receiver sides |
| – Cable – Source Side | |

Color Coded Display Types:

- Specify high and low power with color bars

Features:

- | | |
|--|--|
| – Automatic detection of previously imported USB antenna corrections (i.e., to view pre Apply Corrections) | – Automatic selection of field strength units, when USB antenna corrections are applied |
| – OTA (5G NR) mode can connect to the USB antenna, when an Option 358 license is detected | – Auto selection provides ability to cycle through each axis (X, Y, and Z) to provide RMS average of the three axes results in trace and channel power |

Record GPS stamped data measurements

- | | |
|--|--|
| – Define measurement interval by time or distance | – Display files (KML) on Google Maps or Google Earth |
| – Show results in Table or Bar Chart (Channel Power) | |

a. Requires Option 358 for EMF measurements. Else, antenna can be used manually with X/Y/Z axis.

About USB Antenna Measurements

USB antenna feature supports these standards:

- SA
- OTA – 5G NR

Some measurement parameters are auto-coupled and are not user-settable.

USB Antenna Features

NOTE

For more information on the SDIA-6000 Triaxial Isotropic Antenna, refer to http://en.agos.co.kr/emf_measurement.do.

USB antenna feature has the following features:

- SA mode automatically detect if Import antenna factors are present applies correct X/Y/Z antenna amplitude corrections for EMF measurements
- SA mode X/Y/Z factors—if available—are enabled by default
- OTA mode 5G NR – EMF can be manually enabled

Figure 15-2

Example Summing of Triaxial Values



USB Antennas – (Full Capability Requires EMF Option 358, and SA mode (Option 233 Mixed Analyzers))

About USB Antenna Measurements

Figure 15-3

Example Verifying the Triaxial Values – Axis Y is Displayed

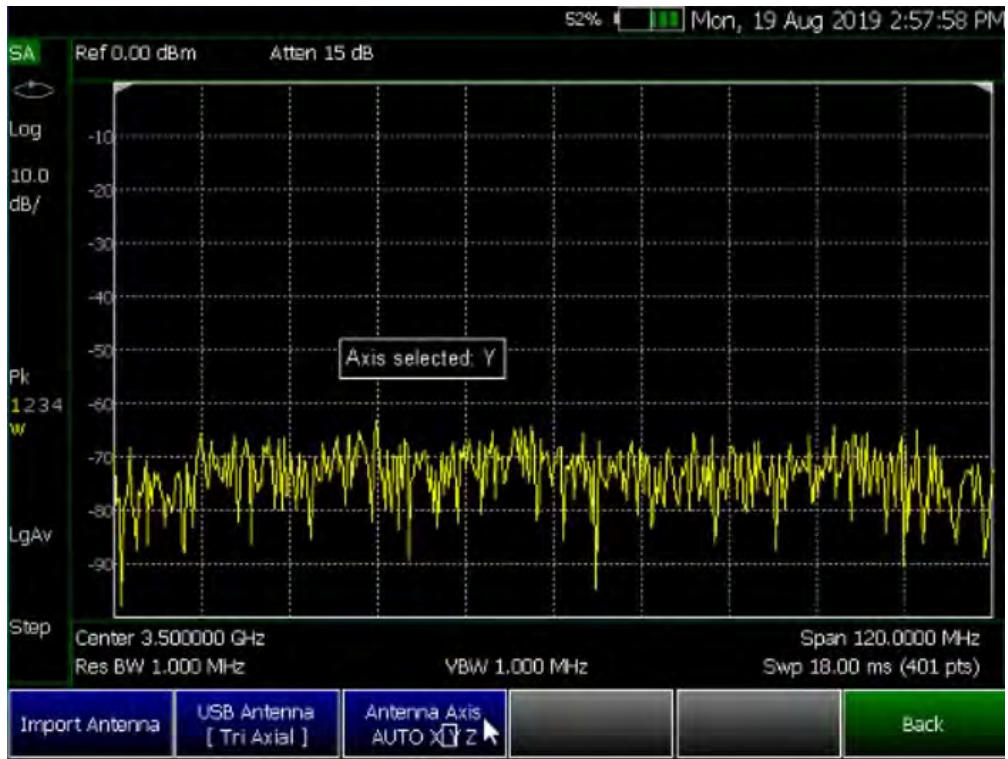

How to Set Up a USB Antenna

NOTE

IMPORTANT! See also, “Alignments” on page 211, in NA mode, Chapter 9, “SA (Spectrum Analyzer) Mode (Option 233–Mixed Analyzers),” and Chapter 10, “RTSA (Real-Time Spectrum Analyzer) Mode–Option 350 (CPU2 Only)” mode.

This section reviews some general high level steps in setting up a USB antenna measurement. If you are not familiar with this process or would like more information on specific EMF measurement setups, refer to:

- SA Mode: “How to Set Up EMF Settings (Requires EMF (Option 358), GPS (Option 307), and SA Mode (Option 233–Mixed Analyzers))” on page 236
- OTA Mode: “How to Set Up EMF Settings (Requires EMF (Option 358))” on page 380

USB Antenna Setup Procedure

1. Select the mode and set up your measurement. Refer to Chapter 13, “Over-the-Air Measurements (OTA) – LTE FDD Option 370, LTE TDD Option 371, 5GTF Option 377 (CPU2 Only)” or to Chapter 9, “SA (Spectrum Analyzer) Mode (Option 233–Mixed Analyzers)”.

NOTE

If necessary, this step can be skipped and done **after** the USB antenna is set up.

2. Connect a USB antenna. Refer to Figure 15-1.

CAUTION

Only Agos Advanced Technologies SDIA–6000 Triaxial Lsotropic USB antenna is compatible with EMF (Option 358). See also Chapter 9, “SA (Spectrum Analyzer) Mode (Option 233–Mixed Analyzers)” and Chapter 13, “Over-the-Air Measurements (OTA) – LTE FDD Option 370, LTE TDD Option 371, 5GTF Option 377 (CPU2 Only)”.

3. Importing and selecting the X/Y/Z antenna factors:

- a. OTA – 5G NR and SA Mode:

Press **System** > **Utilities** > **USB Antennas**

- Then **Import Antenna** – to import the antenna factors from the USB antenna connected to the FieldFox.

NOTE

If the antenna factor import is successful, the FieldFox displays:

"Success: Antenna Factors Imported: Tri-Ax Antenna ID: ->[R] Antenna ID: SDIA-6000-1006 ->[]". The last 4-digits will vary for each antenna (i.e., "1006" is changeable).

If the FieldFox displays this error `Error: USB antenna Error: Not found or Unable to communicate with antenna. Ensure it is connected.` is displayed, verify the USB antenna is connected correctly. Refer to ["Troubleshooting" on page 446](#).

- Then **USB Antenna [Tri Axial]** verify Tri-Axial (default) is selected. Only compatible USB triaxial antennas can be used for EMF measurements.
- Optional: Press **Antenna Axis** with **Auto** (default) selected the FieldFox determines the X/Y/Z settings for the current measurement. Alternately, you can select either X, Y, or Z to enable and to edit a position manually (i.e., an example of editing X, Y, and Z axes is covered in step 5).

4. If you have not selected a mode and set up your measurement, then do so now. Refer to step 1.

5. Enabling the imported USB antenna factors and Cable factors:

Choose one of these:

- SA Mode: ["How to Set Up EMF Settings \(Requires EMF \(Option 358\), GPS \(Option 307\), and SA Mode \(Option 233–Mixed Analyzers\)\)" on page 236](#)
- OTA Mode: ["How to Set Up EMF Settings \(Requires EMF \(Option 358\)\)" on page 380](#)

6. If you need to edit or add new antenna factors or cable factors, then repeat step 5 as required for Y, Z, and the Cable Factors. See also, ["How to Set Up EMF Settings \(Requires EMF \(Option 358\), GPS \(Option 307\), and SA Mode \(Option 233–Mixed Analyzers\)\)" on page 236](#) and ["How to Set Up EMF Settings \(Requires EMF \(Option 358\)\)" on page 380](#).

7. Once you have finished with your USB antenna setup:

- a. Press **Sweep 3** > **Single** > **Restart**

The FieldFox should display in order `Analyzing CCO X-Axis`, `Analyzing CCO Y-Axis`, and `Analyzing CCO X-Axis` and then do a square root sum of the X, Y, and Z measurement values in the FieldFox. Multi-cell measurements are done similarly for each cell ID (i.e., Cell CCO to CCn). Refer to [Figure 15-4 on page 443](#).

USB Antennas – (Full Capability Requires EMF Option 358, and SA mode (Option 233 Mixed Analyzers))

How to Set Up a USB Antenna

Figure 15-4

Example Summing of Triaxial Values



Figure 15-5

Example Verifying EMF



USB Antennas – (Full Capability Requires EMF Option 358, and SA mode (Option 233 Mixed Analyzers))

How to Set Up a USB Antenna

Editing Antenna Correction Factors and Adding New Antenna Factors

CAUTION

Keysight does **not** recommend editing a USB antenna’s correction factors.

NOTE

If **New** is selected under the **X, Y, or Z Antenna** or **Cable** softkey menu, whatever antenna or cable factors that have been imported as the default values and are displayed in the **Settings** table.

For procedures illustrating how to edit the Antenna Factors settings table values, refer to:

- SA Mode: “[How to Set Up EMF Settings \(Requires EMF \(Option 358\), GPS \(Option 307\), and SA Mode \(Option 233–Mixed Analyzers\)\)](#)” on page 236
- OTA Mode: “[How to Set Up EMF Settings \(Requires EMF \(Option 358\)\)](#)” on page 380

Figure 15-6 SA Mode – Example Editing and Adding a New X axis antenna

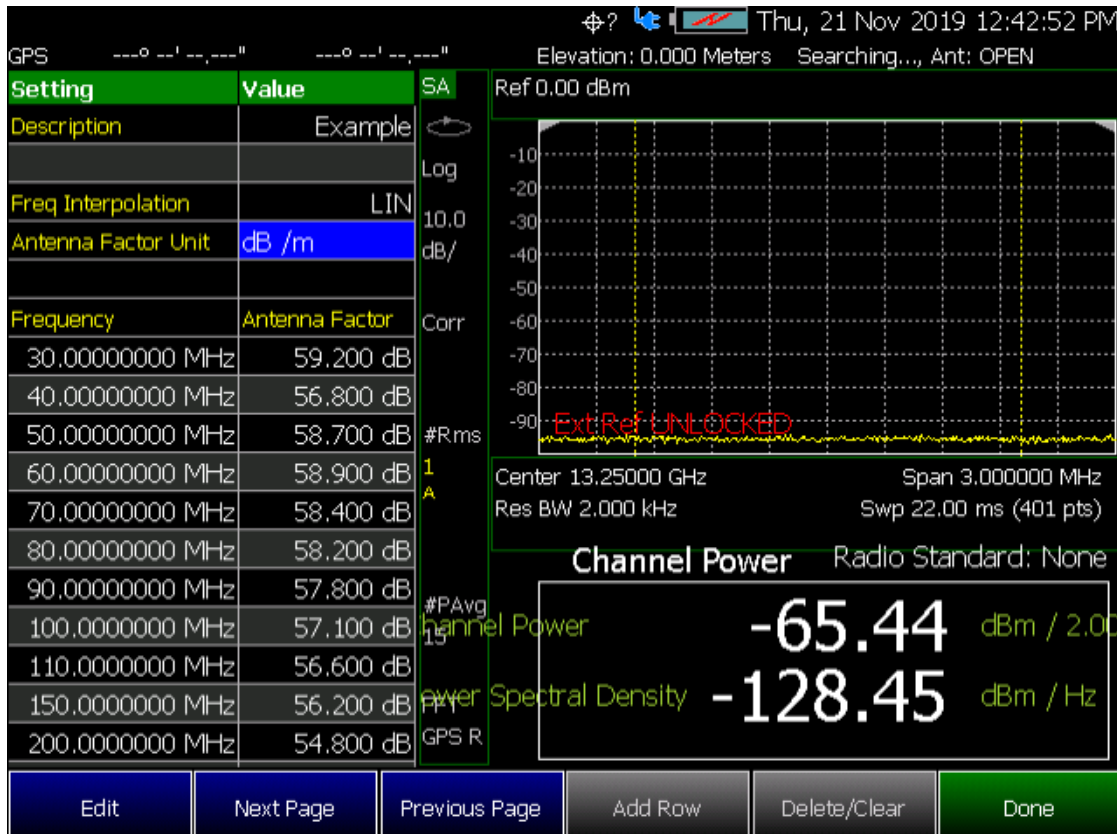

USB Antennas – (Full Capability Requires EMF Option 358, and SA mode (Option 233 Mixed Analyzers))
Other Features Available

Other Features Available

- **Alignments** - For information on using alignments, refer to the SA chapter's section, "**Alignments**" on page 211.
- **Scale Settings** – For information on using scale settings, refer to the Data Analysis chapter's section, "**All about Scale Settings**" on page 714 (not all settings apply to a USB antenna).
- **External Gain** - Refer to refer to the SA chapter's section, "**External Gain**" on page 169.
- **Record Playback** - Refer to refer to the Interference Analyzer chapter's section, "**Record/Playback (SA Option)**" on page 510 and to the OTA chapter's "**How to Use Data Logging (OTA Options 370, 372, and 377)**" on page 387.

Troubleshooting

If your USB antenna setup is not behaving as expected:

- Verify setup is correct by referring to **“How to Set Up a USB Antenna” on page 441**.
 - If the FieldFox displays this error `Error: USB antenna Error: Not found` is displayed, verify the USB antenna is connected correctly **or** `Unable to communicate with antenna`. Ensure it is connected. Verify the antenna connection (i.e., Disconnect and reconnect the USB cable).
Press **USB Antennas** > **Import Antenna**
 - If the FieldFox still displays the USB antenna error, try a different USB antenna.
 - If you are unable to view the X,Y, and Z antenna correction factors, then:
Press **Scale/Amptd** > **Corrections** > **Amp Corr Select** > **TriAxis XYZ**
 - If you are having problems with your measurement, verify the antenna corrections have been enabled:
Press **Scale/Amptd** > **Corrections** > **Apply Corrections** > **ON**

Preamplifier set to **ON**

16 Indoor and Outdoor Mapping – Option 352 (Requires Spectrum Analyzer Mode (Option 233 on N991xA), and GPS Receiver (Option 307))

CAUTION

IMPORTANT!

B Model FieldFoxes measurements require an OML head^a. Refer to <https://www.omlinc.com/>.

- a. Requires external mixer to down convert millimeter wave frequency to intermediate frequency (IF). Recommend OML Inc. Contact OML directly www.omlinc.com for ordering information.

Option 352 maps signals that were measured using the **SA RF Input Port 2** connector.

Option 352 requires the FieldFox for outdoor mapping, GPS (Option 307) installed. And, one of the following, an Over-the-air (OTA) mode (LTE FDD Option 370, LTE TDD (Option 371), 5G TF Option 377, or Channel Scanner mode (Option 312), IQA (Option 351), or Phased Array Antenna (Option 360). Also, requires browser that supports HTML5 (i.e., web browsers **not** supported: IE6, IE7, and IE8).

Recommended, but not required, preamplifier (Option 235) to improve receiver sensitivity.

Keysight's FieldFox handheld analyzer (with Option 352) combined with a USB triaxial antenna (p/o EMF Measurements – Option 358) provides a unique, portable solution for indoor and outdoor mappings in the field. Option 352 adds indoor and outdoor mapping capability to FieldFox analyzers, so that FieldFox can import maps from OpenStreetMap (OSM) for data collection and data plotting to the map directly on the FieldFox instrument display. The FieldFox indoor and outdoor mapping feature resides at the System level and the mapping capability can be enabled within the following modes:

- Channel Scanner (Option 312)
- Phased Array Antenna Support (Option 360)
- Over-the-Air (OTA) LTE FDD (Option 370)
- Over-the-Air (OTA) LTE TDD (Option 371)
- Over-the-Air (OTA) 5G TF (Option 377)

Indoor and Outdoor Mapping – Option 352 (Requires Spectrum Analyzer Mode (Option 233 on N991xA), and GPS Receiver (Option 307))

Using a direct wired LAN connection, FieldFox will automatically access OSM once location coordinates (latitude and longitude) and zoom levels are entered the Map Explorer menu. If using the FieldFox Map Support Tool, OSM map files can be downloaded to a .zip file and imported to FieldFox internal memory. If the FieldFox GPS receiver is enabled and OSM maps have been previously saved to FieldFox with those GPS coordinates, FieldFox will automatically load the corresponding map to match the GPS coordinates.

With Indoor Mapping:

Using the FieldFox:

- Import floor plans or site maps from picture files (PNG, JPG, BMP)
- Interactive Walk Test data collection with location pointer.
- Save Indoor Map files (kDAT)
- Indoor Map file Viewer with results presentation options

With Coverage Mapping vs. Off-Box Mapping Outdoor Mapping:

Using the FieldFox:

- Begin with Record/Playback recorded data results
- Overlay GPS located measured results onto maps
- LAN connection optional. GPS is required.
- Built-in Longitude, Latitude map search
- Save KML or CSV files
- Built-in Map Viewer with results presentation options

Using Google Earth or other software:

- View KML files

In this Chapter

“How to Install Node.js and Running the FieldFox Mapping Software” on page 452

“Downloading and Using the FieldFox Map Support Tool” on page 454

“Importing a .zip File to the FieldFox” on page 458

“How to Set Up Mapping Settings” on page 460

Indoor and Outdoor Mapping – Option 352 (Requires Spectrum Analyzer Mode (Option 233 on N991xA), and GPS Receiver (Option 307))

- “How to Set Up Mapping When the FieldFox Is On The LAN” on page 461
- “Option 352 Indoor Maps Setup Procedure” on page 463
- “Option 352 Outdoor Maps Setup Procedure” on page 467
- “Setting up Data Logging” on page 475
- “How to Use Data Logging (Option 352)” on page 483
- “Screen Annotation” on page 483
- “How to Add Directional Finding (DF) Bearing” on page 485
- “How to Record a Data Log (Outdoor Logging Only)” on page 488
- “To change Data Logging Configuration settings:” on page 489
- “How to Play a Data Log” on page 489
- “Update Available Message” on page 491
- “Troubleshooting” on page 491
- “General Troubleshooting” on page 493
- “Port 5000 in Use Error” on page 493
- “Miscellaneous Mapping Errors” on page 495

See Also

Other Features Available:

- Alignments (SA chapter) – “Alignments” on page 211
- External Gain (SA chapter) – “External Gain” on page 169
- Scale Settings (Data Analysis chapter) – “All about Scale Settings” on page 714

“Why and When to Calibrate” on page 134

Chapter 30, “System Settings.” (Changing display colors)

Chapter 32, “File Management.”

Indoor and Outdoor Mapping – Option 352 (Requires Spectrum Analyzer Mode (Option 233 on N991xA), and GPS Receiver (Option 307))

Option 352 enables you to do the following:

Measure and display indoor and outdoor mapping	
Two Mapping Types:	
– Indoor Maps	– Outdoor Maps (Requires Option 307)
Color Coded Display Types:	
– Specify high and low power with color bars	
Store Geo-location to external or connect to LAN and Download to PC memory:	
– SD card	– Connect to LAN and download to PC memory
– USB card	
Data Logging. Record GPS stamped data measurements	
– Define measurement interval by time or distance	– Add Directional Finding bearing
– Show results in TableChart	– Display files (KML) on Google Maps or Google Earth

Figure 16-1

Maps (Outdoor) With Line Feature Enabled

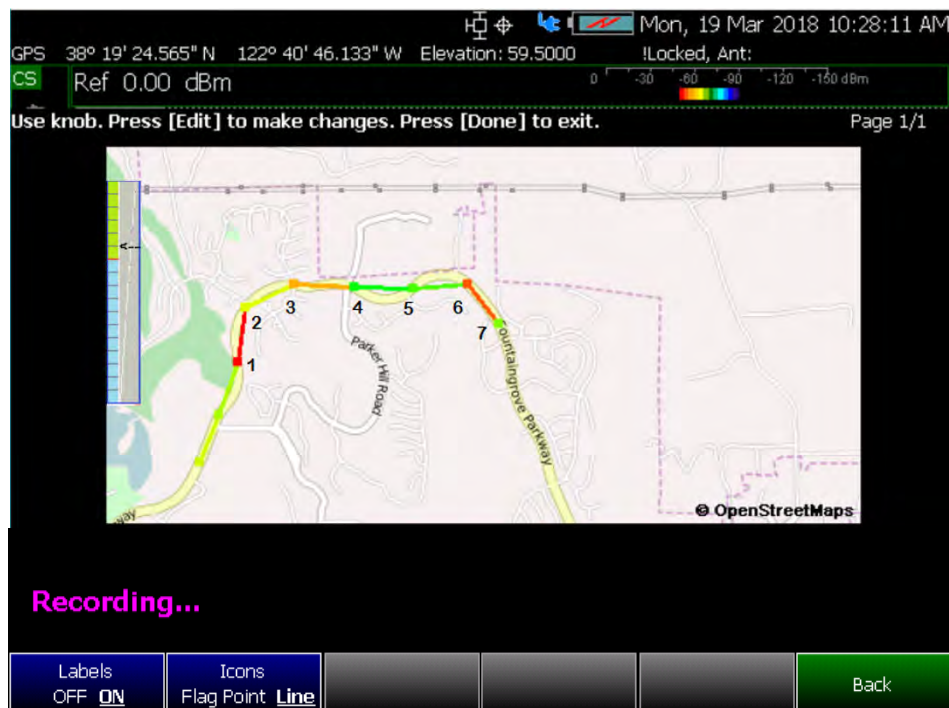

Indoor and Outdoor Mapping – Option 352 (Requires Spectrum Analyzer Mode (Option 233 on N991xA), and GPS Receiver (Option 307))

Figure 16-2 Maps With Current Position Marker Displayed - (OpenStreetMaps)

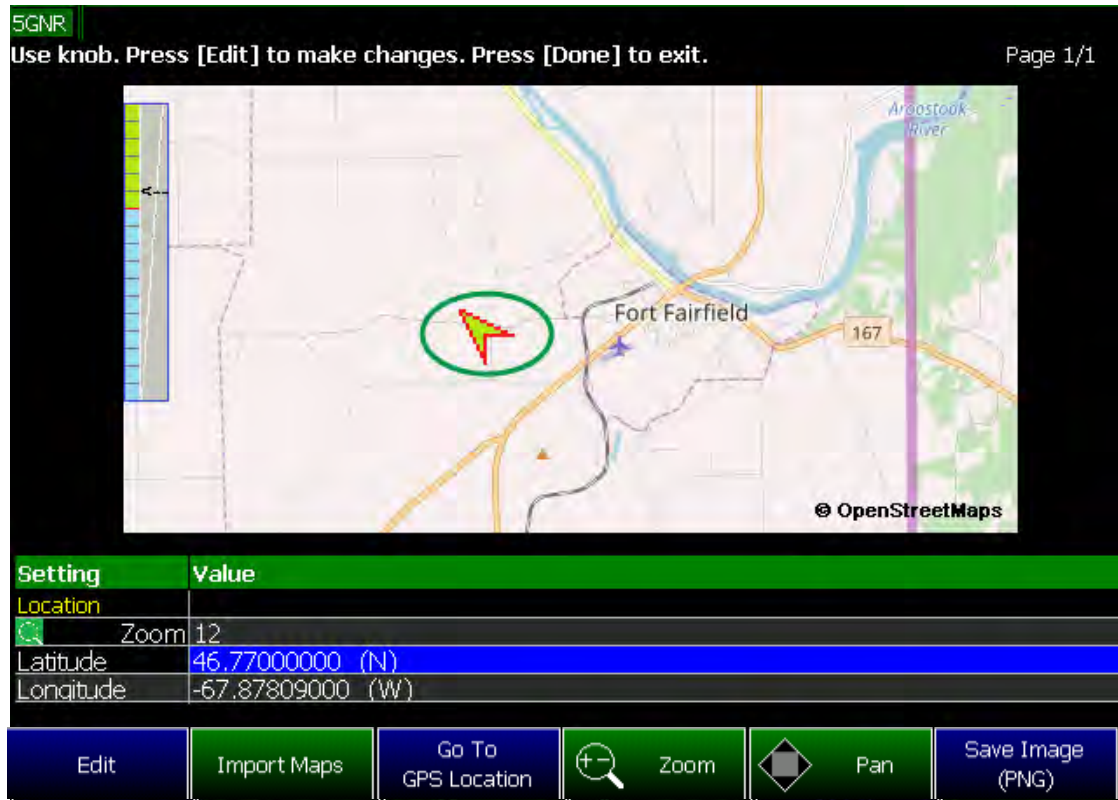
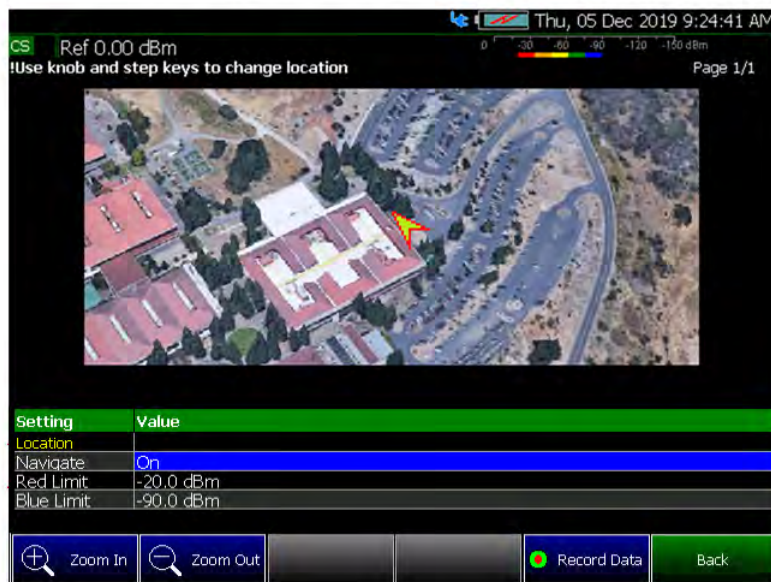

Figure 16-3 Using Mapping (Option 352) - Satellite View for Indoor Mapping

Indoor Maps: RPG Functions with [Navigate] ON OFF



Navigate OFF: RPG moves up and down in table

Navigate ON: RPG zooms picture in/out

How to Install Node.js and Running the FieldFox Mapping Software

NOTE

IMPORTANT! If your FieldFox is connected directly to the LAN, you can skip the section on downloading Node.js and go to “[How to Set Up Mapping When the FieldFox Is On The LAN](#)” on page 461.

This section contains the procedure to download Node.js to access OpenStreetMap files and to process and save those files using the FieldFox mapping software. For details on how to use those on files once they are downloaded to the FieldFox, refer to “[How to Set Up Mapping Settings](#)” on page 460.

1. Open an HTML5 compatible browser and download Node.js to a PC (e.g., Google Chrome, Mozilla Firefox, Safari, or Microsoft Edge):

<https://nodejs.org/en/download>

CAUTION

IMPORTANT!

Do not change the default name of the directory path for downloading the Node.js program, because FieldFox uses the default program path name to run the Mapping feature. Refer to [Figure 16-4](#).

Examples of Web Browsers that not supported are Internet Explorer 6, 7, and 8.

2. Run the Node.JS installation file, by accepting the wizard’s defaults (i.e., including leaving the “Automatically install the necessary tools. Note that...” check box **empty (unchecked)**). Refer to [Figure 16-4](#) and [Figure 16-5](#) on page 453.

Figure 16-4 Downloading the Node.js Installer to a PC

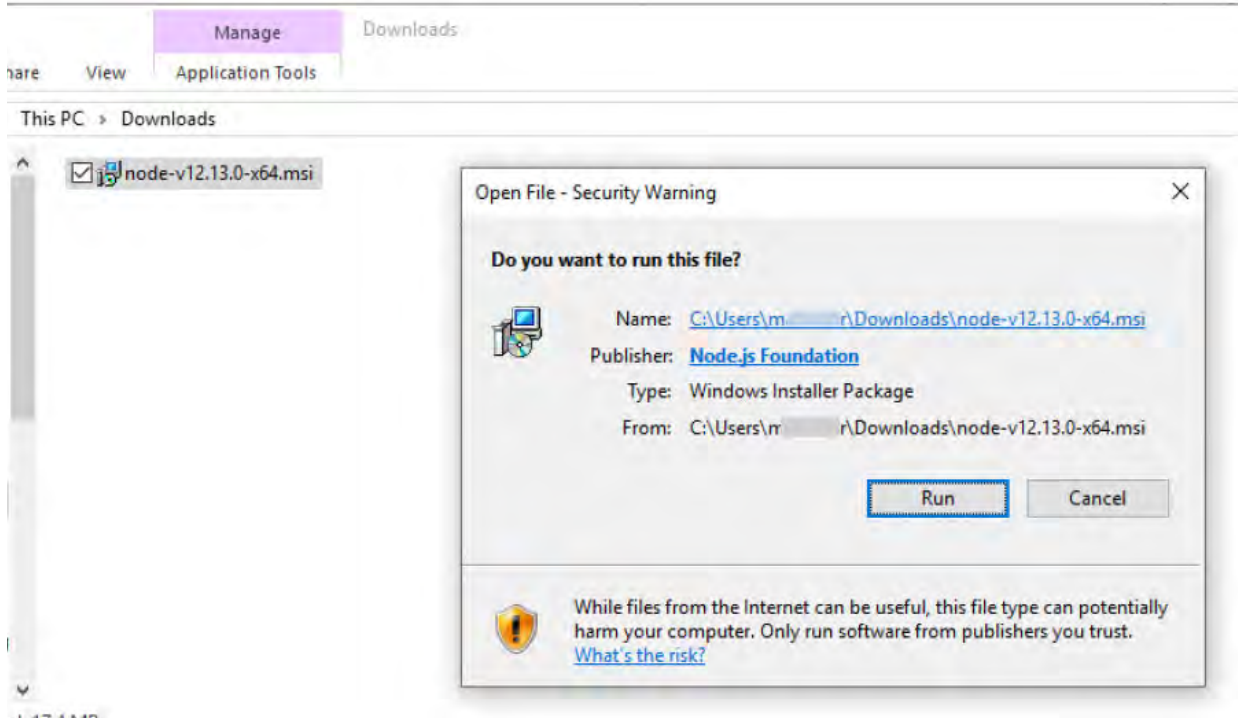
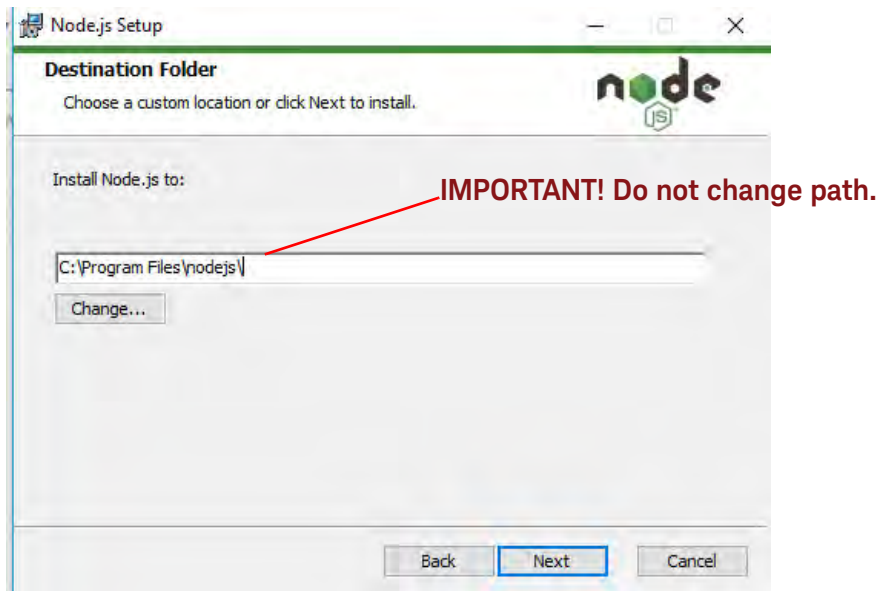

Figure 16-5 Default Download Path for Node.js Installer to a PC



Downloading and Using the FieldFox Map Support Tool

1. Download the FieldFox Mapping software (“FFMapSupportInstall.msi”) to a PC’s Downloads folder. Refer to www.keysight.com/find/fieldfoxsupport and then download the FieldFoxMapping.zip.

Refer to [Figure 16-6](#).

2. Paste and Enter the address into a HTML5 compatible browser. Refer to [Figure 16-6](#) (The Mapping software is **not** compatible with Internet Explorer).

Figure 16-6 FieldFox Mapping Opens in HTML5 Compatible Browser (Overview)

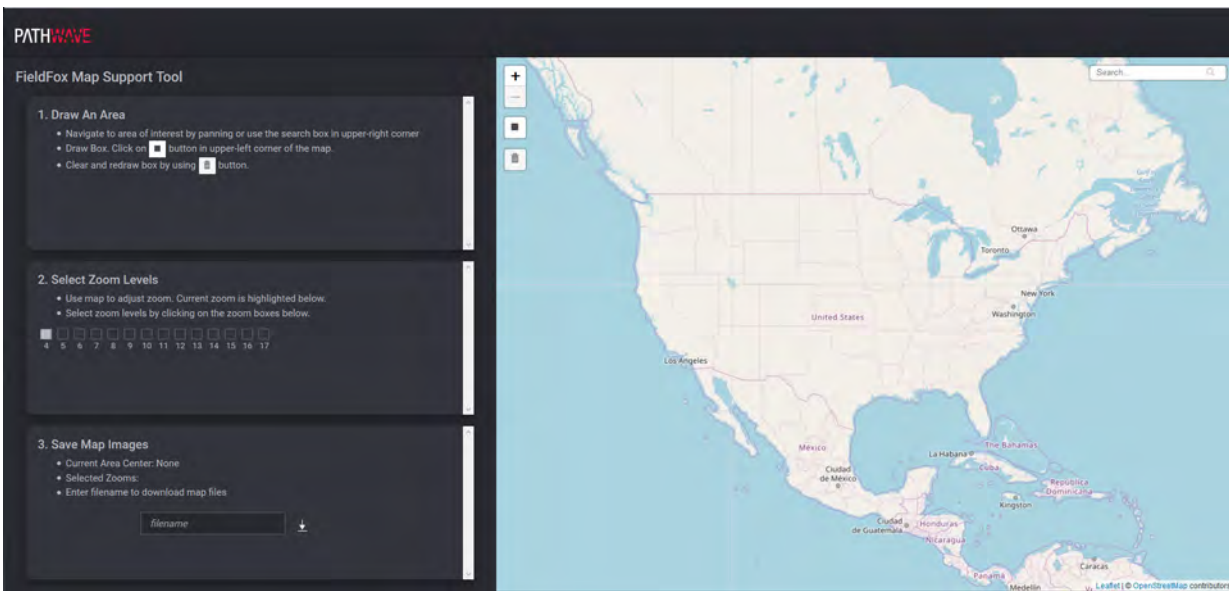

3. Run the FieldFox Map Support Tool software’s, installation software. Refer to [Figure 16-7 on page 455](#).

Figure 16-7 Command Window Opens With Address Copied to Clipboard

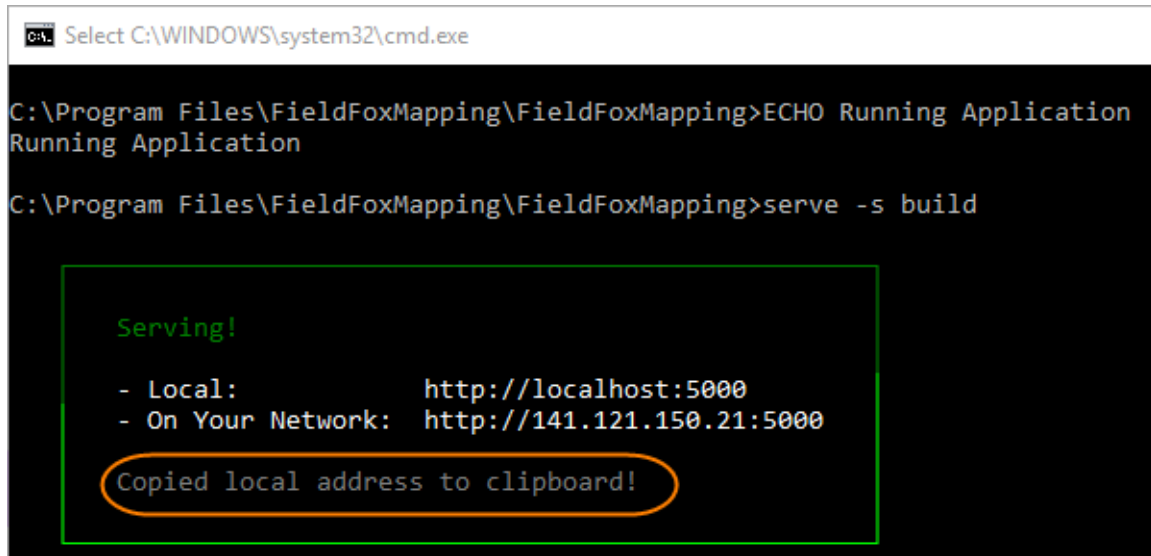

```
cmd Select C:\WINDOWS\system32\cmd.exe

C:\Program Files\FieldFoxMapping\FieldFoxMapping>ECHO Running Application
Running Application

C:\Program Files\FieldFoxMapping\FieldFoxMapping>serve -s build

Serving!
- Local: http://localhost:5000
- On Your Network: http://141.121.150.21:5000

Copied local address to clipboard!
```

4. If you FieldFox is connected directly to the LAN, begin here: Select **Draw An Area** to map and download the selected area:

For this step and sub-steps, refer to [Figure 16-8 on page 456](#).

CAUTION

IMPORTANT!

The more Zoom boxes that you check, the more data is selected for download. For faster downloads click least Zoom boxes. Refer to [Figure 16-8 on page 456](#).

a. Step 1. Select Draw An Area to map:

- Enter a location in the search area and click on the map and use the Zoom In/Zoom Out buttons () to select the area to map. Also, your mouse scroll wheel can be used for zooming in and out.

Hint: The larger the map area selected for final mapping, the longer it takes for the file download.

- Click on the box button () and click and drag to select the map area.

Hint: To clear and redraw the box choices, click the trashcan button ().

b. Step 2. Select Zoom Levels to Save and Download:

- Select all Zoom levels of the map you wish to save.

Hint:

Indoor and Outdoor Mapping – Option 352 (Requires Spectrum Analyzer Mode (Option 233 on N991xA), and GPS Receiver (Option 307))
Downloading and Using the FieldFox Map Support Tool

- To select Zoom levels, click the zoom boxes.
- The more Zoom levels checked, the more map images that have to be saved and it will take longer to download the images.

c. **Step 3. Input a filename** to store your requested images from OpenStreetMaps. The *.zip file is then stored in your PC's Downloads folder.

Figure 16-8 FieldFox Mapping Opens in HTML5 Compatible Browser (Zoom)

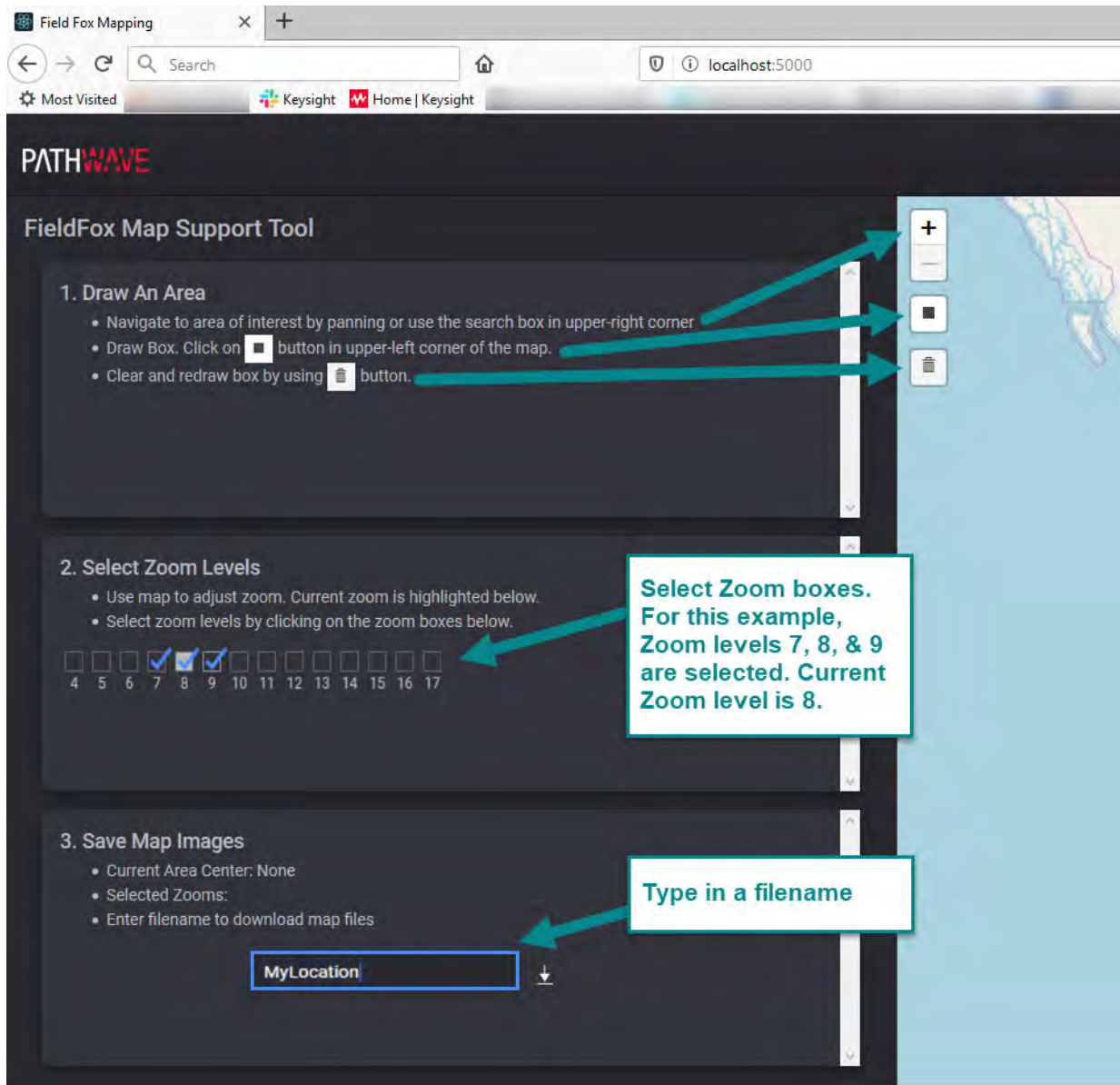

Indoor and Outdoor Mapping – Option 352 (Requires Spectrum Analyzer Mode (Option 233 on N991xA), and GPS Receiver (Option 307))
Downloading and Using the FieldFox Map Support Tool

5. Saving your *.zip file to a storage device and importing your *.zip to the FieldFox:

NOTE

For FTP, refer to Refer to [Using FTP with FieldFox](#) and to the [FieldFox Programming Guide](#) one www.keysight.com.

- a. Insert an SD card or USB storage device into your PC.
- b. Open the PC's Downloads folder and find your *.zip file. (e.g., MapsZIP_Example_1). Refer to [Figure 16-9 on page 457](#).
- c. Find your maps *.zip file.
- d. Copy the *.zip file to your SD card or USB storage device.
- e. Remove the SD card/USB storage device from your PC.
- f. Insert the SD card/USB storage device into the FieldFox.

CAUTION

IMPORTANT!

In the folder that contains your unzipped files, do NOT change any of the Map file folders or filenames. Doing so will prevent the FieldFox from being able to recognize the map files.

New downloaded Map folders, for the same map locations and zoom levels, will overwrite any existing folders on the FieldFox.

Figure 16-9 New Maps Zip File – MapExample_1

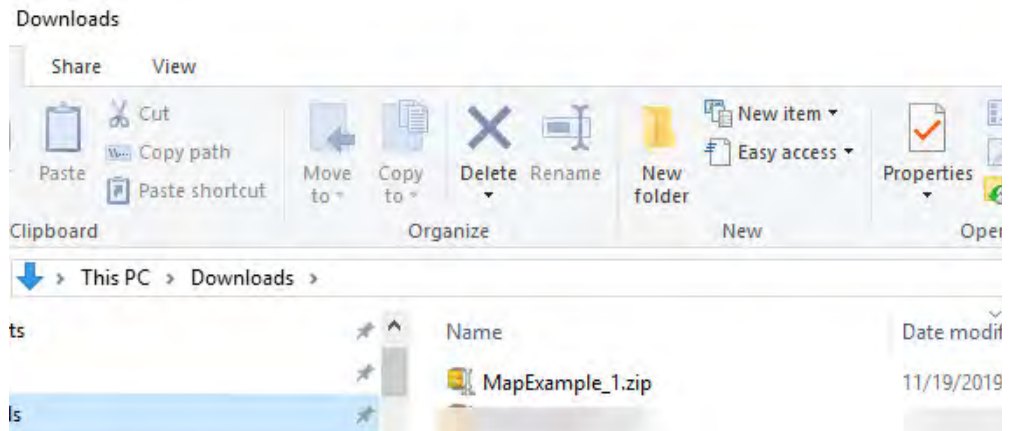

Importing a .zip File to the FieldFox

NOTE

For FTP, refer to [Using FTP with FieldFox](#) and to the [FieldFox Programming Guide](#) on www.keysight.com. See also, “[How to Set Up Mapping When the FieldFox Is On The LAN](#)” on page 461.

On the FieldFox:

Press **System 7** > **Utilities** > **Mapping** > **Map Explorer (Get Maps)**

1. Press **Import Maps**
2. Verify your SD card/USB Source Device is selected.
If not then:
Press **Source Device [Internal]** > **SD Card** | **USB**
3. Press **Import Maps (.zip)**
4. In the "Select .zip file to import" window that opens, if there is more than one .zip file listed, select the .zip file you want to load by using the **▲▼** arrows, or the rotary knob and then press **Recall File**.
Refer to [Figure 16-11 on page 459](#) and [Figure 16-11 on page 459](#).
5. Press **Back** to return to the previous menu.

Figure 16-10 Example of a Maps *.zip Being Recalled From a USB Storage Device

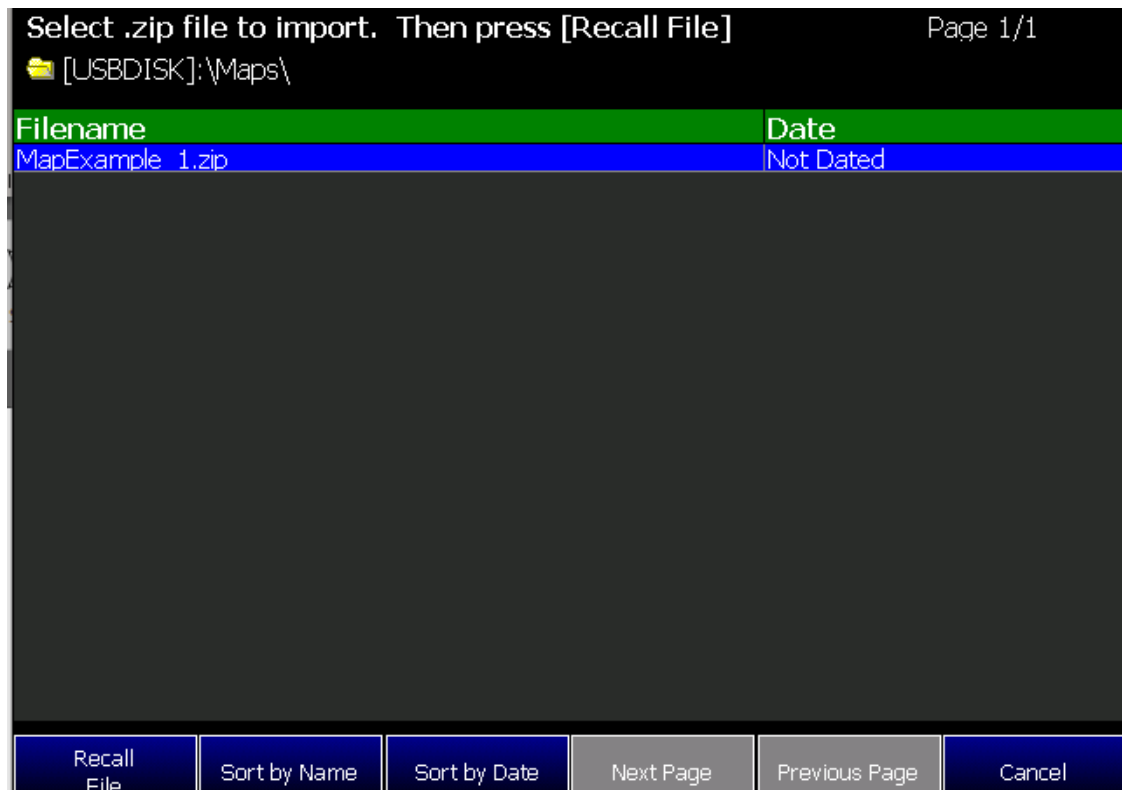

Indoor and Outdoor Mapping – Option 352 (Requires Spectrum Analyzer Mode (Option 233 on N991xA), and GPS Receiver (Option 307))
Importing a .zip File to the FieldFox

Figure 16-11

Example of Maps Folder Containing Imported Maps *.zip Files to the FieldFox's InternalSD\UserData\Maps Folder

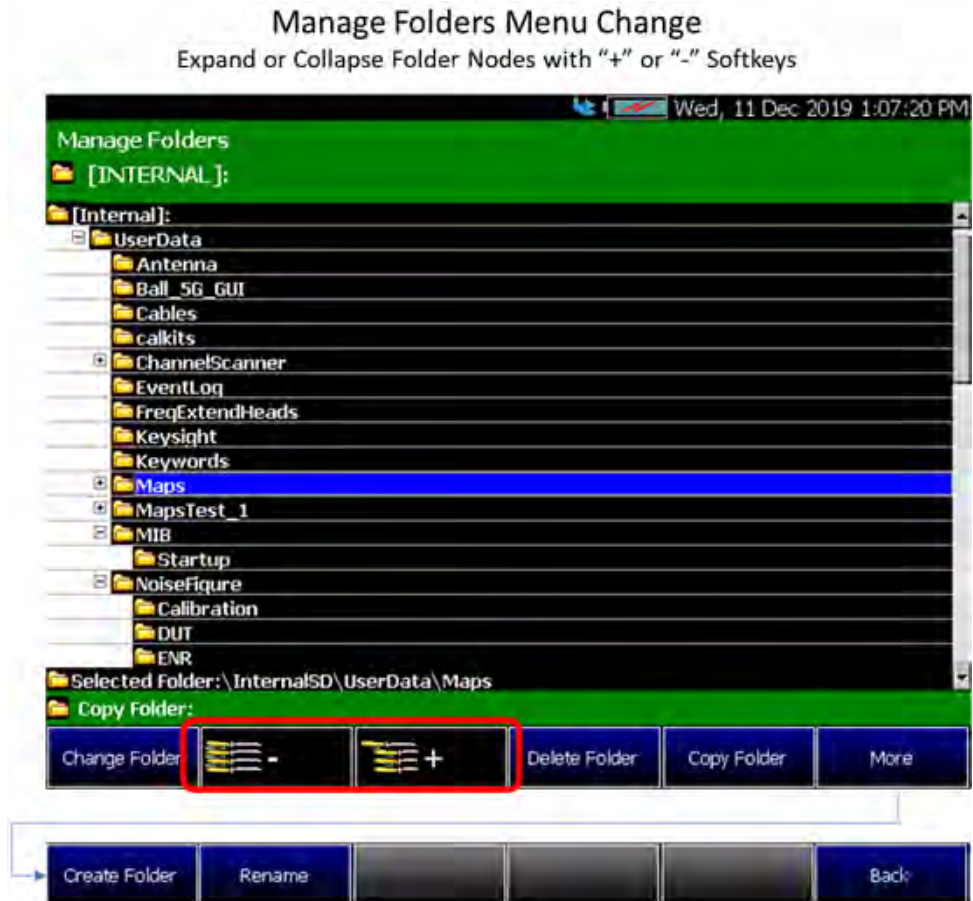

How to Set Up Mapping Settings

NOTE

IMPORTANT! See also, **“Alignments”** on page 211, in SA mode.

This section reviews the steps in setting up an Option 352 Mapping measurement.

This section consists of:

- **“How to Set Up Mapping When the FieldFox Is On The LAN”**
- **“Option 352 Indoor Maps Setup Procedure”**

Figure 16-12 Overview – Setting Up Option 352 (Indoor Mapping) Using Other Modes

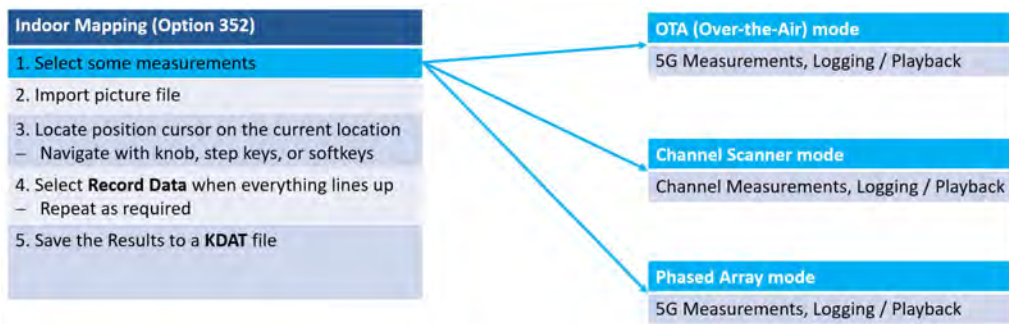

- **“Option 352 Outdoor Maps Setup Procedure”** (Requires GPS Option 307)

Figure 16-13 Overview – Setting Up Option 352 (Outdoor Mapping) Using Other Modes

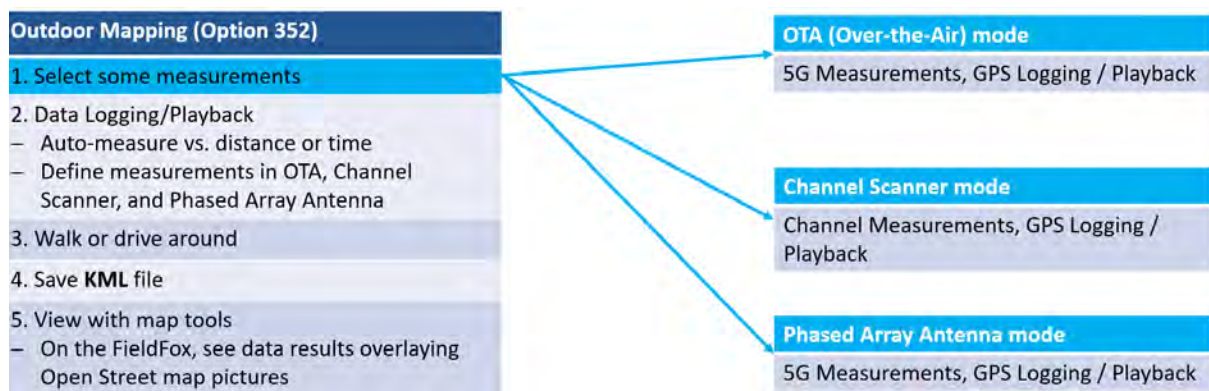

How to Set Up Mapping When the FieldFox Is On The LAN

If your FieldFox is connected directly to the LAN, you can view your maps by using OpenStreetMaps directly (i.e., no need to use the FieldFox Map Support Tool to download the maps as a *.zip file). But, you will need a valid GPS signal (Option 307 required). Refer to [“Display a Map File” on page 461](#).

Display a Map File

1. Press **System 7** > **Utilities** > **Mapping** > **Map Explorer (Get Maps)**
2. Then choose from the following:
 - Press **Edit**
 - Enter a **Zoom** by using the RPG or the **▲▼** arrow keys to highlight Zoom and then enter a value between 4 and 17.
 - Press **Go to GPS Location** – sets the current displayed map to the current GPS location.

NOTE

If a "Warning: GPS data invalid - GPS data must be valid to show current GPS location" is displayed, verify your GPS signal is connected and working properly.

-
- Press **Zoom** – opens a menu of **Zoom In** and **Zoom Out** softkeys
 - Press **Pan** – Opens a menu of softkeys to move **East**, **West**, **North**, and **South** on the current displayed map area
 - **Save Image (PNG)** – To save the current map as a PNG file. When selected, the "Save Map picture file" feature opens to the current storage location (default = [INTERNAL]:) where you can name and save your current displayed map area.
3. If you do not see your Map on the FieldFox display: Use the RPG or the **▲▼** arrow keys to highlight **Latitude** and then enter a value for latitude that corresponds closely to the “Current Area Center” value displayed in the FieldFox Mapping software. Refer to [Figure 16-14](#).

Optional: If you want to stop the "Reading map..." process, press **Esc** to stop map search.
 4. Repeat step 3 for **Longitude**.

Figure 16-14 Example of Current Area Center Latitude and Longitude Values

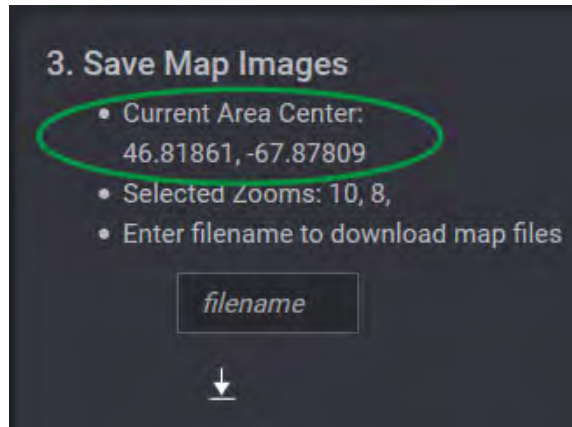

Option 352 Indoor Maps Setup Procedure

CAUTION

IMPORTANT!

85571A-028 (28 GHz 5G Phased Array Antenna) accessories not suitable for use in wet locations.

1. Set up your measurements in Channel Scanner, OTA, or Phased Array Antenna. See also, [Chapter 13, “Over-the-Air Measurements \(OTA\) – LTE FDD Option 370, LTE TDD Option 371, 5GTF Option 377 \(CPU2 Only\),”](#) and [Chapter 27, “Channel Scanner \(Option 312\).”](#)

One or more are required:

- For setting up a phased array antenna, refer to [Chapter 14, “5G Rapid Prototype Phased Array Antenna – Option 360.”](#)
- For setting up a USB antenna, refer to [Chapter 15, “USB Antennas – \(Full Capability Requires EMF Option 358, and SA mode \(Option 233 Mixed Analyzers\)\).”](#)

Optional:

- For setting up GPS Option 307, refer to [Chapter 30, “System Settings,”](#) and then [“GNSS \(GPS+\) and GPS” on page 749.](#)

2. Plan your **Indoor Map**:

NOTE

Importing floor plans can be imported now or after the indoor map locations have been measured.

- a. Save mapping pictures to the FieldFox using USB storage device, SD card, or connect to LAN with internet and download.
- b. Import floor plans or site maps to the FieldFox from pictures (PNG, JPG, and BMP).

Press **System 7** > **Utilities** > **Mapping** > **Map Explorer (Get Maps)** > **Import Maps** > **Import Maps (ZIP)**

Optional:

- Press **Source Device [Internal]** – **Internal** (default), **SD Card**, **USB**, or **CD Drive**
- Press **Destination Device [Internal]** – **Internal** (default), **SD Card**, **USB**, or **CD Drive**

- c. Recommended: Do an interactive Walk Test data collection using the location pointer.

3. If you are using an antenna with your measurements, then Connect your equipment similar to [Figure 14-1 on page 399 in Chapter 14, “5G Rapid Prototype Phased Array Antenna – Option 360”](#) or to [Figure 15-1 on page 436 in Chapter 15, “USB Antennas – \(Full Capability Requires EMF Option 358, and SA mode \(Option 233 Mixed Analyzers\)\)”](#).
4. Then press **Esc** > **Back** > **Measure 1** or **Trace 6** > **More** (required for OTA only) > **Data Logging** to view the Data Logging softkeys and set the **Record Settings**, **Record Save/Recall**, and **More** > **Indoor Map Data Logging** or **Signal Locate**.
 - For Outdoor Mapping: **Record Save/Recall** > **File Folder Default System**
 - **Default** – Sets the default User Folder path:
 - List files (*.csv and *.kml) are save-recalled to:
"[CurrentDevice]:\RecordPlayback\CS\"
 - Record-Play files are save-recalled to:
"[CurrentDevice]:\RecordPlayback\CS\"
 - Or
 - **System** – Sets the User Folder to the user defined system folder path/name:
 - List files are save to-from
"CurrentDevice\ - Record-Play files are save-recalled to:
"CurrentDevice\
 - Refer to [Chapter 32, “File Management.”](#)
 - Then **File Type**
 - KML (default) or
 - CSV
 - Then **Save Log File**.
 - or
 - Then **Recall Log File**.
 - Optional **Auto Save ON** (default = OFF). To avoid loss of data, if power loss occurs.
 - Then **Back**
5. Set up the indoor mapping press **More** > **Indoor Map Data Logging** then choose
 - Press **Record Indoor Data** – opens a menu of previously stored PNG files to select to record a new data log

- a. The Scroll to indoor floor plan *.png file
- b. Press **Recall File** - enables you to recall previously stored *.kdat file that you can view or modify.
- c. Move the position cursor to current location:
 - Then press **Pan** to open a menu of softkey to enable you to move the position cursor to current location and mark data points, using **East**, **West**, **North**, and **South** softkeys.
 - Or you can use the  arrows, the rotary knob, or numeric keypad locate the position cursor to current location.
- d. Then press **Record Data** when data pointer is in desired position to enter a new data point.

NOTE

If a "Error: This data point not ready..." is displayed, verify antenna setup.

- e. Repeat step **c** and **d** for all other required position locations.
Else, continue to next step.
- f. When done, press **Back** (If you used the Pan softkey menu) > **More** > **Save Map** to save results to a *.KDAT file.

NOTE

A KDAT file is the file FieldFox uses to recall an indoor mapping/data logging session ("Recall Indoor Log File"). It's an archive file that contains information about the original image file, the location of the recorded data on the image and the actual recorded data. KDAT files can only be opened with FieldFox itself. KDAT files cannot be opened via Data Link.

An auxiliary CSV data file is generated automatically, each time a KDAT file is saved during an indoor mapping session. The CSV contains the recorded data, without the image, location of the recorded data, etcetera.

Indoor and Outdoor Mapping – Option 352 (Requires Spectrum Analyzer Mode (Option 233 on N991xA), and GPS Receiver (Option 307))
 How to Set Up Mapping Settings

Figure 16-15 Example of an Indoor Building Map with Single Icon and Bore Sight Pointer

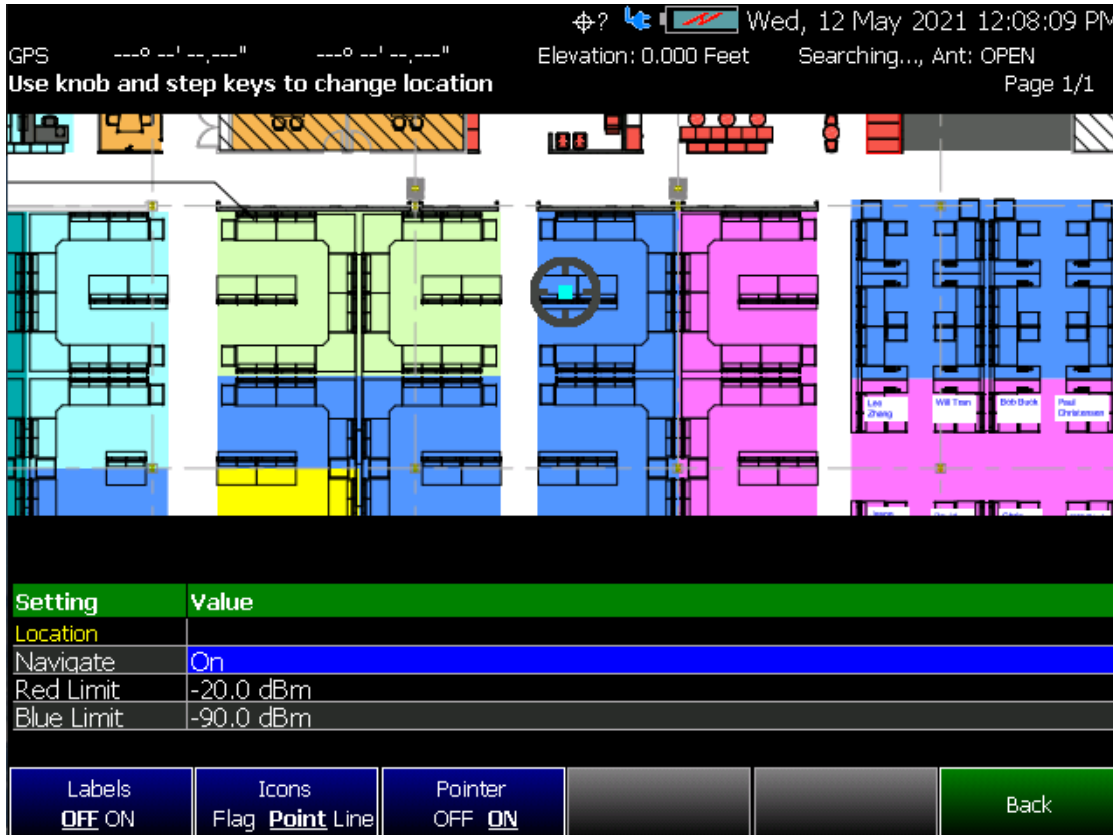

Option 352 Outdoor Maps Setup Procedure

Outdoor mapping requires GPS Option 307.

CAUTION

IMPORTANT!

85571A-028 (28 GHz 5G Phased Array Antenna) accessories not suitable for use in wet locations.

NOTE

Saving and importing maps can be done now or after the outdoor map locations have been measured. Before you can save and import maps via the internet, your PC requires the FieldFoxMapping software. Refer to [“How to Install Node.js and Running the FieldFox Mapping Software” on page 452.](#)

1. Set up your measurements in Channel Scanner, OTA, or Phased Array Antenna. See also, [Chapter 13, “Over-the-Air Measurements \(OTA\) – LTE FDD Option 370, LTE TDD Option 371, 5GTF Option 377 \(CPU2 Only\),”](#) and [Chapter 27, “Channel Scanner \(Option 312\).”](#)

One or more are required:

- For setting up GPS Option 307, refer to [Chapter 30, “System Settings,”](#) and then [“GNSS \(GPS+\) and GPS” on page 749.](#)
- For setting up a phased array antenna, refer to [Chapter 14, “5G Rapid Prototype Phased Array Antenna – Option 360.”](#)
- For setting up a USB antenna, refer to [Chapter 15, “USB Antennas – \(Full Capability Requires EMF Option 358, and SA mode \(Option 233 Mixed Analyzers\)\).”](#)

2. Plan the area you want to map with GPS Option 307 enabled.

NOTE

Saving and importing maps can be done now or after the outdoor map locations have been measured. Refer to [“How to Install Node.js and Running the FieldFox Mapping Software” on page 452.](#)

- a. Optional (Can be done later): Save mapping pictures to the FieldFox using USB storage device, SD card, or connect to LAN with internet and download. Refer to [“How to Install Node.js and Running the FieldFox Mapping Software” on page 452.](#) For FTP, refer to <http://na.support.keysight.com/fieldfox/help/Programming/webhelp/FFProgrammingHelp.htm>.
- b. Optional (Can be done later):
 - **Set up the Record Settings (Outdoor Mapping only):** Press **Trace 6** > **More** (OTA mode) > **Data Logging** > **Record Settings** > **Meas Interval ON** > **Interval Type Time Distance** (select one of these) then **Back**, to exit the Record Settings menu.

How to Set Up Mapping Settings

- To enable Auto Save to avoid loss of data, if loss of power occurs: Press **Record Save/Recall** > **Auto Save OFF ON** > **ON**

c. Walk or drive around the area you want to map.

d. Optional: If you know your route, and have already downloaded a zip file of your mapping location or are connected to the LAN, then press **System 7** > **Utilities** > **Mapping** > **Map Explorer (Get Maps)** then:

- Move the position cursor to current location:
 - Then use the  arrows, the rotary knob, or numeric keypad locate the position cursor to current location.
- Then **Edit** to change the value of:
 - **Zoom** – If a zoom value is not found, the FieldFox ignores the entered value and returns to the previously displayed Zoom setting (i.e., values must be between 4 and 17).
 - **Latitude** – If a latitude value is not found the FieldFox displays a gray grid.
 - **Longitude** – If a longitude value is not found the FieldFox displays a gray grid.
 - **Easting** – Enter an eastern measured distance (i.e., x Cartesian coordinate).
 - **Northing** – Enter a northward-measured distance (i.e., y Cartesian coordinate).
 - **Grid Reference** – Valid in UK only.
 - **Red Limit** – Determines the dBm value of the red limit (default = -20 dBm).
 - **Blue Limit** – Determines the dBm value of the blue limit (default = -90 dBm).

When done entering each setting, press **Enter**.

Figure 16-16 Example of England Displayed Text

Import ZIP file using FieldFox Map Support Tool with Do Import softkey

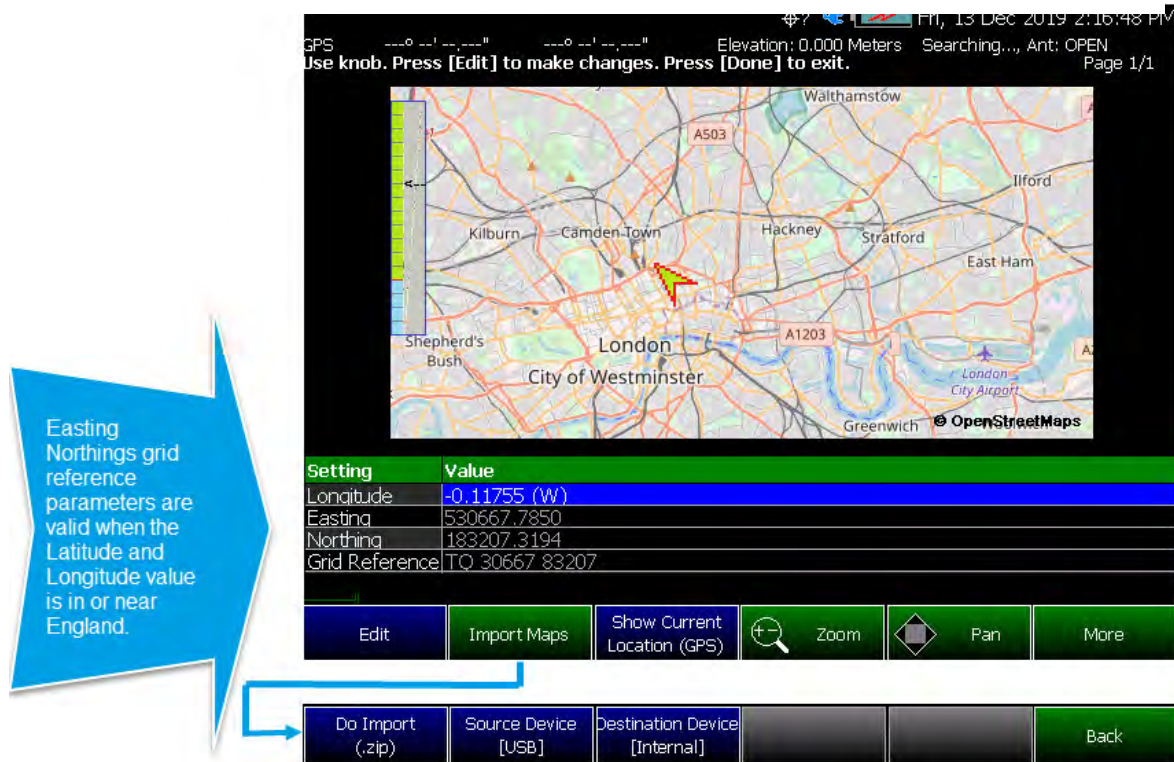

Unzip file found on **Source Device**. Store contents to /Maps folder of **Destination Device**.

- e. Else, to import a *.zip file (i.e., you can come back and do this later after the mapping route is defined).
 - i. Press **System 7** > **Utilities** > **Mapping**
 - ii. Then to import map pictures, press **Map Explorer (Get Maps)** > **Import Maps**
 - iii. Press **Import Maps (ZIP)** > **Recall File** and change latitude and longitude values to view site maps from pictures (KML).
3. If not done, connect your equipment similar to **Chapter 14, "5G Rapid Prototype Phased Array Antenna – Option 360"**, **Chapter 15, "USB Antennas – (Full Capability Requires EMF Option 358, and SA mode (Option 233 Mixed Analyzers))"**, and to **Figure 14-1 on page 399**

See also,

- For setting up GPS Option 307, refer to **Chapter 30, "System Settings,"** and then **"GNSS (GPS+) and GPS"** on page 749.
- For setting up a phased array antenna, refer to **Chapter 14, "5G Rapid Prototype Phased Array Antenna – Option 360."**

How to Set Up Mapping Settings

- For setting up a USB antenna, refer to [Chapter 15, “USB Antennas – \(Full Capability Requires EMF Option 358, and SA mode \(Option 233 Mixed Analyzers\)\).”](#)
4. Install street maps into the FieldFox. Refer to [“How to Install Node.js and Running the FieldFox Mapping Software”](#) on page 452.

Options for downloading maps:

- Store the maps *.zip file onto USB or SD card and the FieldFox can load from USB, SD card, or internal drive (if the maps are saved to the FieldFox).
 - Connect the FieldFox to the LAN with internet access and use the FieldFox Mapping software to download a maps image *.zip file.
 - If necessary, you can download the maps at later time
5. Using Discrete Colors softkey Menu, set the red (maximum) and blue (minimum) values. For setting color coded bar scale preferences, refer to [Chapter 30, “System Settings,”](#) and [“Using the Discrete Colors Softkey Menu”](#) on page 747.

- a. Press **System 7** > **Utilities** > **Mapping** > **Map Explorer (Get Maps)**
- b. Optional: Select the Red or Blue Limits to edit by using the  arrows, the rotary knob, or numeric keypad to position the trace for optimum viewing on the FieldFox display.

Then **Edit** (the color coded bar scale Red or Blue limits are at the top of the FieldFox display).

Indoor and Outdoor Mapping – Option 352 (Requires Spectrum Analyzer Mode (Option 233 on N991xA), and GPS Receiver (Option 307))
 How to Set Up Mapping Settings

Figure 16-17 Using Maps Explorer to Set the Red and Blue Power Limits

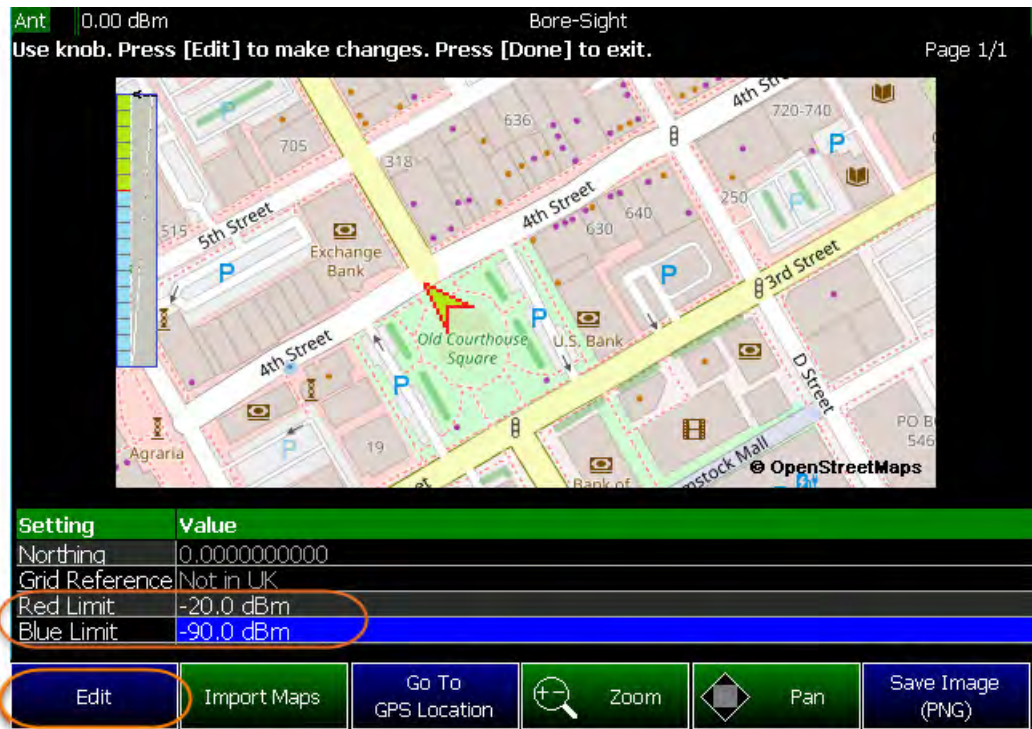

- c. Optional: Then **System 7** > **Preferences** > **Discrete Colors** > **Discrete Colors** > **Discrete Colors** and change value as desired (Maximum = 6).

Figure 16-18 Display Example: Color Coded Bar Scale Before Selecting x6 Colors



Figure 16-19 Display Example: Color Coded Bar Scale After Selecting x6 Colors

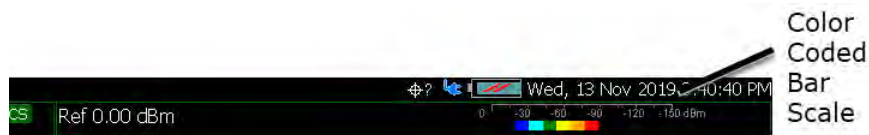

- Verify you have enabled GPS. Refer to your measurements procedure and to **“GNSS (GPS+) and GPS”** on page 749.
- Then press **Esc** > **Back** > **Trace 6** > **More** (required for OTA only) > **Data Logging** > **Record Save/Recall**
 - Then **File Folder Default System**
 - Default** – Sets the default User Folder path:

--List files (*.csv and *.kml) are save-recalled to:
"[CurrentDevice]:\RecordPlayback\CS\"

--Record-Play files are save-recalled to:
"[CurrentDevice]:\RecordPlayback\CS\"

Or

- **System** – Sets the User Folder to the user defined system folder path/name:

--List files are save to-from
"CurrentDevice\<UserSelectedFolder>"

--Record-Play files are save-recalled to:
"CurrentDevice\<UserSelectedFolder>"

Refer to **Chapter 32, "File Management."**

- Then **File Type**
 - KML or
 - CSV (default)
- Then **Save Log File.**
- or
- Then **Recall Log File.**
- Optional **Auto Save ON** (default = OFF). To avoid loss of data, if power loss occurs.
- Then **Back**

8. Set up the outdoor mapping:

- Press **Trace 6** > **Data Logging**
- Then press **Record**
- When done, **Stop**
- Save results to KML file.

9. View KML with map tools.

- On the FieldFox, see the data results overlaying OpenStreetMaps' pictures.

Or use Google Maps or similar to view your maps on your PC. Refer to **"Import and Play back KML Files into 3rd Party Software (Example: Google Earth with Animation Tool)"** on page 473.

Indoor and Outdoor Mapping – Option 352 (Requires Spectrum Analyzer Mode (Option 233 on N991xA), and GPS Receiver (Option 307))
 How to Set Up Mapping Settings

Figure 16-20 FieldFox Display with View Map ON and OFF Displayed



[Playback] with View Map OFF

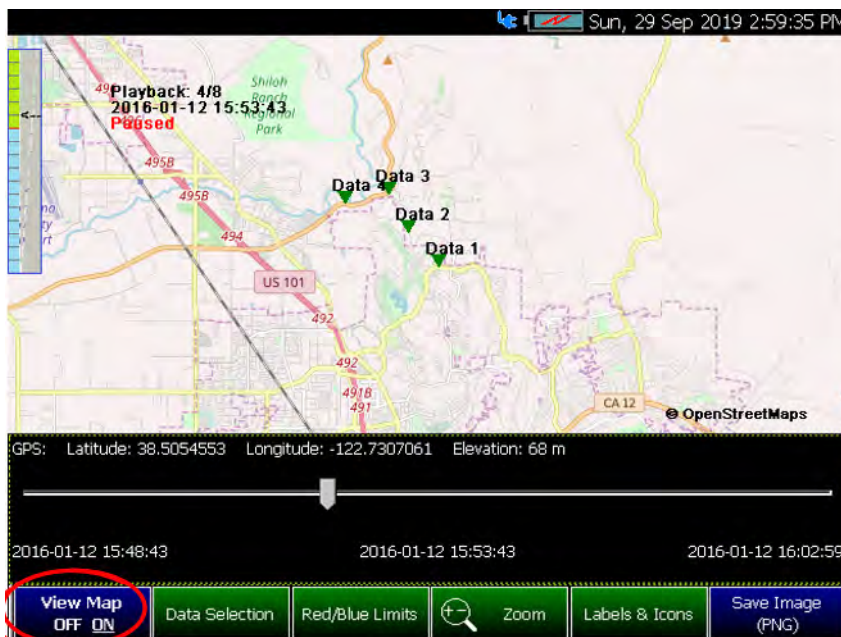

[Playback] with View Map ON

Import and Play back KML Files into 3rd Party Software (Example: Google Earth with Animation Tool)

Features

Use the Playback Slider to replay measurement results. See also Google Maps and or Google Earth's help. Refer to [Figure 16-21 on page 474](#).

Indoor and Outdoor Mapping – Option 352 (Requires Spectrum Analyzer Mode (Option 233 on N991xA), and GPS Receiver (Option 307))

How to Set Up Mapping Settings

- Open the FieldFox *.KML file in Google Earth. The time slider appears in upper left of the map.
- Manual Mode – Move the time slider cursor to see color-coded icons pop-up according to the timestamp.
- Loop mode has a Fast-Slow Replay Option.
- Click on each color coded balloon to see the table of measurement results for that location.

Figure 16-21 Importing a KML File Into Google Earth

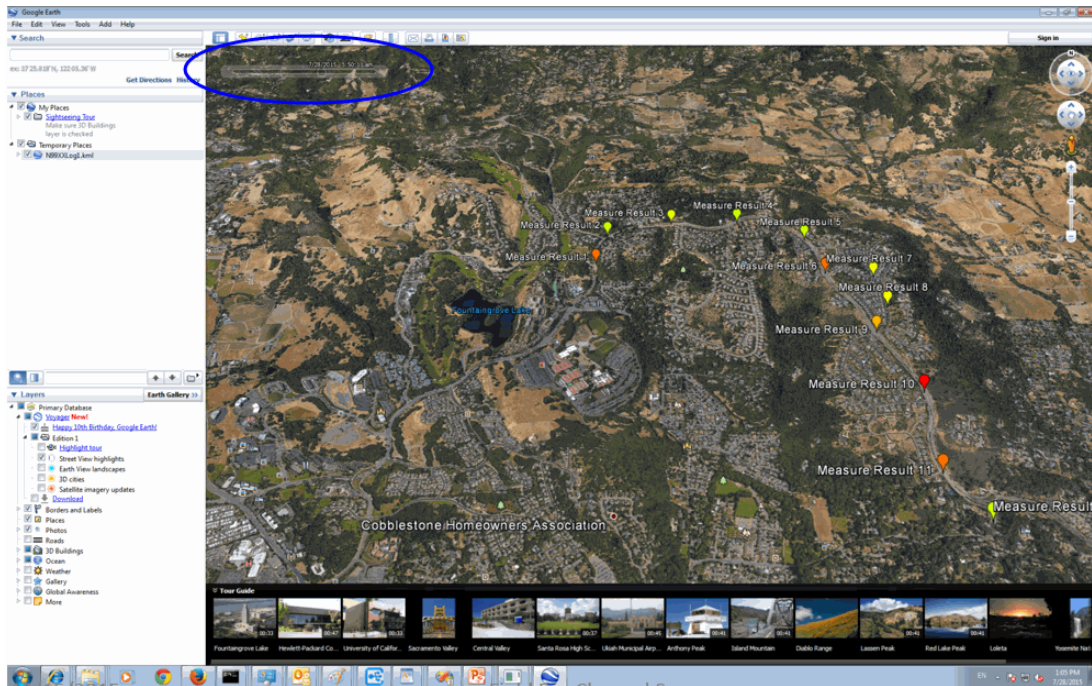

Setting up Data Logging

There are two types of data logging:

“**Enabling Outdoor Map Logging**” on page 475 and

“**Enabling and Setting Up Indoor Map Logging**” on page 478

See also, “**Option 352 Indoor Maps Setup Procedure**” on page 463 and
“**Option 352 Outdoor Maps Setup Procedure**” on page 467.

Opening the **Data Logging** settings:

- Press **Measure 1** (Channel Scanner (Option 312) only) or **Trace 6** > **Data Logging**

Enabling Outdoor Map Logging

If you have already set up your outdoor map logging:

- Then **Record** to begin logging data or
- Then **Play** if this softkey is active, you are currently recording or you have recalled a previously stored data logging file

When Play is pressed, then choose:

- **Cursor Position** use this softkey to move the data log play cursor in the current data log being played (i.e., **Cursor Position** is active only when playback is paused).

This softkey is only available in Channel Scanner and Phased Array Antenna modes (i.e., The Cursor Position softkey is **not** available for OTA mode).

- **Maps** – to open a softkey menu enable map view and related features (e.g., Data Selection, Red/Blue Limits, Labels & Icons, Zoom). Learn more, refer to step 3.

or

- Then **View** (available in Channel Scanner mode and with outdoor mapping only).

Then choose:

- **Exit** to leave the current View softkey menu and return to the previous menu.
- **Zoom** use this softkey zoom in/out.

This softkey is only available in Channel Scanner and Phased Array Antenna modes (i.e., The Cursor Position softkey is **not** available for OTA mode).

How to Set Up Mapping Settings

- **Red Limit** to edit the red maximum power limit dBm value.
- **Blue Limit** to edit the blue minimum power limit dBm value.

Setting up **Outdoor** Mapping

1. Press **Record Settings** – then choose:
 - **Meas Interval OFF ON** Enable to make the measurement interval softkeys active (default = OFF).
 - **Interval Type** choose **Time** or **Distance**.
 - **Time Interval** Enter time in seconds (1s to 3.6 ks) or
 - **Distance Interval** Enter time in miters (10m to 10 km)
2. Press **Record Save/Recall** Opens a softkey menu to manage your data logging filenames and file folder locations
 - **Save Log File** or
 - **Recall Log File** (if you have previously stored data)
 - **File Folder Default System** (Default = Default) or
 - **File Type** (Default = CSV) KML or DREC (DREC applies to Option 360 only)
 - **Auto Save OFF ON** To enable/disable auto save to protect your data, if power is lost (Default = OFF)
 - Then **Back**
3. Then choose from the following:
 - Press **Record** to begin a new data log recording.
 - Press **Pause Resume** (only displayed after **Record** has been pressed) Temporarily halts recording until pressed again. The incoming trace continues to sweep. Press again to continue recording.
 - Press **Play** (only displayed after **Stop** has been pressed or a CSV/KML file has been recalled) to play the current recording in memory.
 - Press **Stop** Immediately
 - The Save the log file menu opens. Edit the filename and press Done to exit menu. See Settings below and “**To change Data Logging Configuration settings:**” on page 489.

- To change your file settings or measurement interval. Learn more, refer to **“To change Data Logging Configuration settings:” on page 489.**

- Outdoor Mapping only: Press **Maps** – to open a softkey menu enable map view and related features (e.g., Data Selection, Red/Blue Limits, Labels & Icons, Zoom).

Then choose from the following:

- **View Map OFF ON** – To enable/disable the current map view (default = latitude/longitude = 0.00/00. Need GPS to view current location (default = OFF).
- **Data Selection** – Opens a softkey menu to set the active data channel, sort type, and sort order.

Then Choose:

Channel 1	Sets the data channel being recorded. Available channels will vary within each mode.
Sort Power Freq	Sets the type of measurement displayed (Power or Frequency).
Sort Order Up Down	Sets the sort order to ascending (Up) greater power/frequencies displayed first or descending (Down) lowest power or frequency values displayed first.
Back	Returns to previous softkey menu.

- **Red/Blue Limits** – Opens a softkey menu to assign power values to the red (high power limits) and blue (low power limits) heat map display limits (defaults: Red Limit = -20 dBm, Blue limit = -90 dBm).
- **Zoom** – Zoom in/out on the map displayed.
- **Labels & Icons** – Opens a softkey menu to enable/disable map data point labels and icon types.

Then choose from the following:

Labels OFF ON	Enables/Disables map data point labels. When enabled, a label is displayed for every map data point (e.g., “Data 1”). When disabled, labels are not displayed for the map data points.
----------------------	--

Icons
Flag Point
Line

Sets the type of icon that is used to display a map's data points (default = Flag).

- **Save Image (PNG)** Saves the current displayed map to a *.png file (default filename is "MapImageFile"). This softkey is available (active) when View Maps = ON.

NOTE

Record-Play files are saved to:

- If File Folder is set to Default then Record-Play files are save-recalled to: "[CurrentDevice]\RecordPlayback\[Current mode]\"
- If File Folders are set to System, then Record-Play files are save-recalled to: "CurrentDevice\\"

NOTE

Learn more about file settings, refer to [Chapter 32, "File Management."](#)

Enabling and Setting Up Indoor Map Logging

1. Press **Measure 1** > **Data Logging** > **More**
2. Press **Indoor Map Data Logging** – then choose:
 - **Record Indoor Data** – by selecting a previously stored *.png file or
 - **Recall Indoor Log File** (if you have previously stored data (*.kdat)). You can recall a log file and add/delete directional finding lines of bearing and map data to previously saved files. Re-save them and resume data collection at a later time.

After a *.png is opened for a new recording or a *.kdat file is recalled for editing and displayed on the FieldFox, then choose from the following:

CAUTION

IMPORTANT!

When you recall a *.kdat file, you are able to add mapping points, but you will only be able to save the changes as a *.png. file. Optionally, if you save a file as a *.png file and then recall the file, you can add data points and save the changes as a *.kdat file.

NOTE

A KDAT file is the file FieldFox uses to recall an indoor mapping/data logging session (“Recall Indoor Log File”). It's an archive file that contains information about the original image file, the location of the recorded data on the image and the actual recorded data. KDAT files can only be opened with FieldFox itself. KDAT files cannot be opened via Data Link.

An auxiliary CSV data file is generated automatically, each time a KDAT file is saved during an indoor mapping session. The CSV contains the recorded data, without the image, location of the recorded data, etcetera.

- **Navigate OFF ON** To enable/disable map location changes using arrow keys and the RPG (when **ON**). When **OFF** the arrow keys and RPG enable you to highlight and **Edit** the Navigate, Red Limit, and Blue Limits in the **Setting** table. (Default = OFF)
- **Pan** Navigate map East, West, North, South using arrow keys).
- **Zoom** – Zoom in/out on the map displayed.
- **Bearing Line** This similar to the outdoor direction finding feature. It allows a “Bearing line” to be on or off, the angle of Bearing Line to be setup, and its length to be set. All very similar to the outdoor direction finding procedure. From this Bearing Line menu, you can also select a point to edit/change.

NOTE

Before you can set a Bearing Line value, you first must “Record” a point, before you can turn its bearing line on or off, change its length, and angle. See also, “**How to Add Directional Finding (DF) Bearing**” on page 485.

Bearing Line OFF ON	Enables and disables the Bearing Line between two points.
Angle	Sets the angle of the Bearing Line (default = 0°, 0 to 360°).
Line Length	Sets the length of the Bearing Line to connect two points (default = 100).
Select Point	Sets the point to be edited.
Back	Takes you back to the previous softkey menu.

- **Record Data** To record a data point in the specified intervals using currently selected labels and icons.

To enable the **Record Data** softkey, move the cursor using the arrow hardkeys or the RPG to highlight the **Location: Value** cell in the table. Begin walking with an antenna and press Record Data as required to map a location.

- **More** Opens a menu of softkeys to Undo, set Labels & Icons, RPG actions, Save Image, and Back.

Labels & Icons	Opens a softkey menu where you can enable/disable and select map icons: <ul style="list-style-type: none">– Labels OFF ON - Enables/Disables map data point labels. When enabled, a label is displayed for every map data point (e.g., “Data 1”). When disabled, labels are not displayed for the map data points.– Icons Flag Point Line - Sets the type of icon that is used to display a map’s data points.– Pointer OFF ON - Enables/disables the bore sight pointer.
Undo	To undo last indoor map setting change
RPG [Zoom]	Opens a menu to set the RPG’s functionality for mapping. Choose from: <ul style="list-style-type: none">– Zoom - (default) Zooms in/out.– <--> - RPG knob moves the map East or West.– ^v - RPG knob moves the map north or south.

Data Selection	<p>Opens a softkey menu to set the active data channel, sort type, and sort order.</p> <ul style="list-style-type: none">-- Channel 1 - Sets the data channel being recorded. Available channels will vary within each mode.-- Sort Power Freq - Sets the type of measurement displayed (Power or Frequency).-- Sort Order Up Down - Sets the sort order to ascending (Up) greater power/frequencies displayed first or descending (Down) lowest power or frequency values displayed first.
Save	<p>Opens a softkey menu to enable you to save your map (.kdat) or your image (.png).</p> <ul style="list-style-type: none">-- Save Map - Opens “Save the log file” where you can name and save your map file (kDAT). Softkey is only visible when data is recorded on a *.png file using Labels & Icons feature and the Record softkey.-- Save Image (PNG) - Saves the current displayed map to a *.png file (default filename is “MapImageFile”). This softkey is on active when View Maps = 0.
Back	<p>Returns to previous softkey menu.</p>

NOTE

A KDAT file is the file FieldFox uses to recall an indoor mapping/data logging session (“Recall Indoor Log File”). It's an archive file that contains information about the original image file, the location of the recorded data on the image and the actual recorded data. KDAT files can only be opened with FieldFox itself. KDAT files cannot be opened via Data Link.

An auxiliary CSV data file is generated automatically, each time a KDAT file is saved during an indoor mapping session. The CSV contains the recorded data, without the image, location of the recorded data, etcetera.

3. Press **Record Save/Recall** Opens a softkey menu to manage your data logging filenames and file folder locations

Indoor and Outdoor Mapping – Option 352 (Requires Spectrum Analyzer Mode (Option 233 on N991xA), and GPS Receiver (Option 307))

How to Set Up Mapping Settings

- **Save Log File** or
- **Recall Log File** (if you have previously stored data)
- **File Folder Default System** (Default = Default) or
- **File Type** (Default = CSV) KML or DREC (DREC applies to Option 360 only)
- **Auto Save OFF ON** To enable/disable auto save to protect your data, if power is lost (Default = OFF)
- Then **Back**

NOTE

Record-Play files are saved to:

- If File Folder is set to Default then Record-Play files are save-recalled to: "[CurrentDevice]\RecordPlayback\[Current mode]\"
- If File Folders are set to System, then Record-Play files are save-recalled to: "CurrentDevice\\"

NOTE

Learn more about file settings, refer to [Chapter 32, "File Management."](#)

Outdoor Mapping Only: Export KML File Into 3rd Party Mapping Software

- Export KML file into 3rd party mapping software (i.e., Google Map or Google Earth). Refer to ["Import and Play back KML Files into 3rd Party Software \(Example: Google Earth with Animation Tool\)"](#) on page 473.

How to Use Data Logging (Option 352)

NOTE

Data Log-Play files are saved to:

- If File Folder is set to Default then Record-Play files are save-recalled to: “[CurrentDevice]\RecordPlayback\[Current mode]\”
 - If File Folders are set to System, then Record-Play files are save-recalled to: “CurrentDevice\\”
-

Data Logging allows you to GPS mapping data and play them back at a later time. Use this feature to overlay Maps pointers on your indoor or outdoor files.

Data logs can be saved to the FieldFox Internal memory, an SD Card, or a USB flash drive.

This section assumes you have already completed the initial setup and have a measurement setup in the FieldFox.

This section contains the following sections:

- [“Screen Annotation” on page 483](#)
- [“How to Add Directional Finding \(DF\) Bearing” on page 485](#)
- [“How to Record a Data Log \(Outdoor Logging Only\)” on page 488](#)
- [“To change Data Logging Configuration settings:” on page 489](#)
- [“How to Play a Data Log” on page 489](#)

Screen Annotation

During a record or playback session, the following is displayed in the top-center area of the screen:

- **Rec: 55/55 2018-12-31 03:26:11 PM**

where:

- **55/55** is the current and total trace number: currently trace is 55 of 55 total scans.
- **2018-12-3103:26:11 PM** is the date and time of recording.
- The name of a recording can be changed using Manage Sessions. Learn more in [“To change Data Logging Configuration settings:” on page 489](#).

See also, the FieldFox User’s Guide’s “System Settings” chapter.

When GPS is enabled, **GPS R** is indicated at the bottom of the FieldFox display. Learn more, see the FieldFox User’s Guide’s “System Settings” chapter.

The Mapping mode can display and be recorded/played back in field strength units, when the units are changed:

Indoor and Outdoor Mapping – Option 352 (Requires Spectrum Analyzer Mode (Option 233 on N991xA), and GPS Receiver (Option 307))

How to Use Data Logging (Option 352)

– Press **Scale /Amptd** > **More** > **Unit** then choose:

– **dBmV**, **dBuV**, **W**, **V**, **A**, **dBmA**, or **dbuA** (Default Units: dBm)

See [Figure 16-22 on page 484](#).

Figure 16-22 Field Strength Annotation that can be Recorded and Played Back

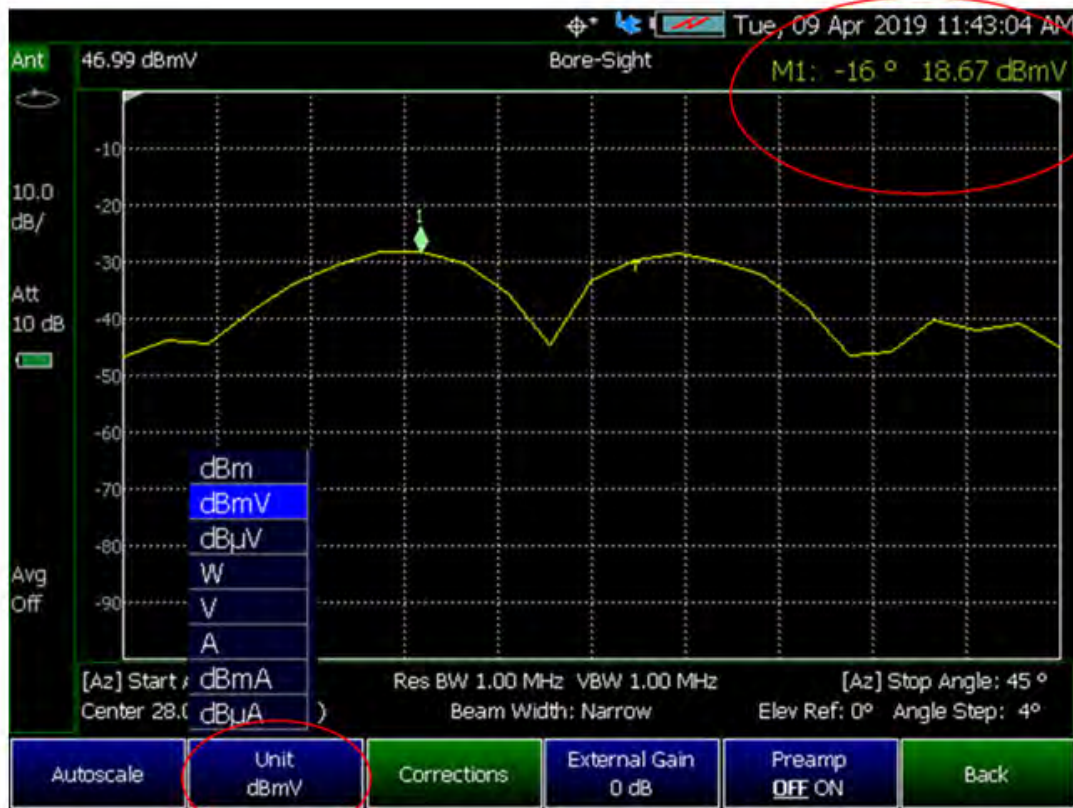

NOTE

If Data Logging or Playback is not occurring when you think it should, check the following:

- Is the sweep in **HOLD**? (upper-left annotation), or check the Sweep menu for **Continuous** set to OFF.
- Is Recording or Playback **Paused**? (mid-left annotation)
- Is the Record or Playback Interval set too long? (Configuration settings.)

How to Add Directional Finding (DF) Bearing

NOTE

IMPORTANT! You must be in Channel Scanner Mode to use this feature.

DF Bearing adds angles and horizontal lines between the direction of an object (point) and another object. Refer to [Figure 16-23 on page 487](#) and [Figure 16-24 on page 488](#).

See also, [“Downloading and Using the FieldFox Map Support Tool” on page 454](#).

- Press **Mode** > **More** (Depending on installed options, may not be necessary.) > **Channel Scanner**
- Press **Measure 1** > **Data Logging** > **More**
- Optional (Ignore for Outdoor Mapping): Press **Indoor Map Data Logging** then choose:
 - Press **Record Indoor Data** – by selecting previously stored *.png file or
 - Press **Recall Indoor Log File** – (if you have previously stored data (*.kdat)). You can recall a log file and add/delete directional finding lines of bearing and map data to previously saved files. Re-save them and resume data collection at a later time.

CAUTION

IMPORTANT!

When you recall a *.kdat file, you are able to add mapping points, but you will only be able to save the changes as a *.png. file. Optionally, if you save a file as a *.png file and then recall the file, you can add data points and save the changes as a *.kdat file.

Indoor and Outdoor Data Logging

- Then **Signal Locate**
- Then **Add Point** – adds a new bearing location then:
 - **Press Direction Line OFF ON** – Enables/disables the line of bearing (default = OFF).
 - **Press Adjust Angle** – Enters the angle of the current point’s line. Rotate the line about the current point (your current location) to point towards the highest signal strength seen by your directional antenna. You can rotate the knob to rotate the line, or you can type an angle into the active entry directly.

How to Use Data Logging (Option 352)

- **Press Line Length** – Enters a value for the line's length. Adjusts the length of the line of bearing to extend it far enough to allow other points to cross, indicating a possible emitter location.
- Press **Accept Point** or **Back** – verifies the new point is to be added and returns to the previous menu.
- Then **Edit Points** – Opens up menu of bearing point editing softkeys. Choose from:
 - **Select Point** – Enter the point you want to edit. Then you can directly enter a new angle or line length or use the **▲▼** arrows, or the rotary knob to edit these values.
 - **Direction Line OFF ON** – Enables/disables the direction line (default = OFF).
 - **Press Adjust Angle** – Enters the angle of the current point's line. Rotate the line about the current point (your current location) to point towards the highest signal strength seen by your directional antenna. You can rotate the knob to rotate the line, or you can type an angle into the active entry directly.
 - **Press Line Length** – Enters a value for the line's length. Adjusts the length of the line of bearing to extend it far enough to allow other points to cross, indicating a possible emitter location.
 - **Delete Point** – deletes the currently selected point.
- Then **Clear Points** – Deletes all of the displayed bearing points and lines.

Indoor and Outdoor Mapping – Option 352 (Requires Spectrum Analyzer Mode (Option 233 on N991xA), and GPS Receiver (Option 307))
How to Use Data Logging (Option 352)

Figure 16-23 Directional Finding (DF) Bearing – Outdoor Map Data Logging Example



Indoor and Outdoor Mapping – Option 352 (Requires Spectrum Analyzer Mode (Option 233 on N991xA), and GPS Receiver (Option 307))
 How to Use Data Logging (Option 352)

Figure 16-24 Directional Finding (DF) Bearing – Indoor Map Data Logging Example

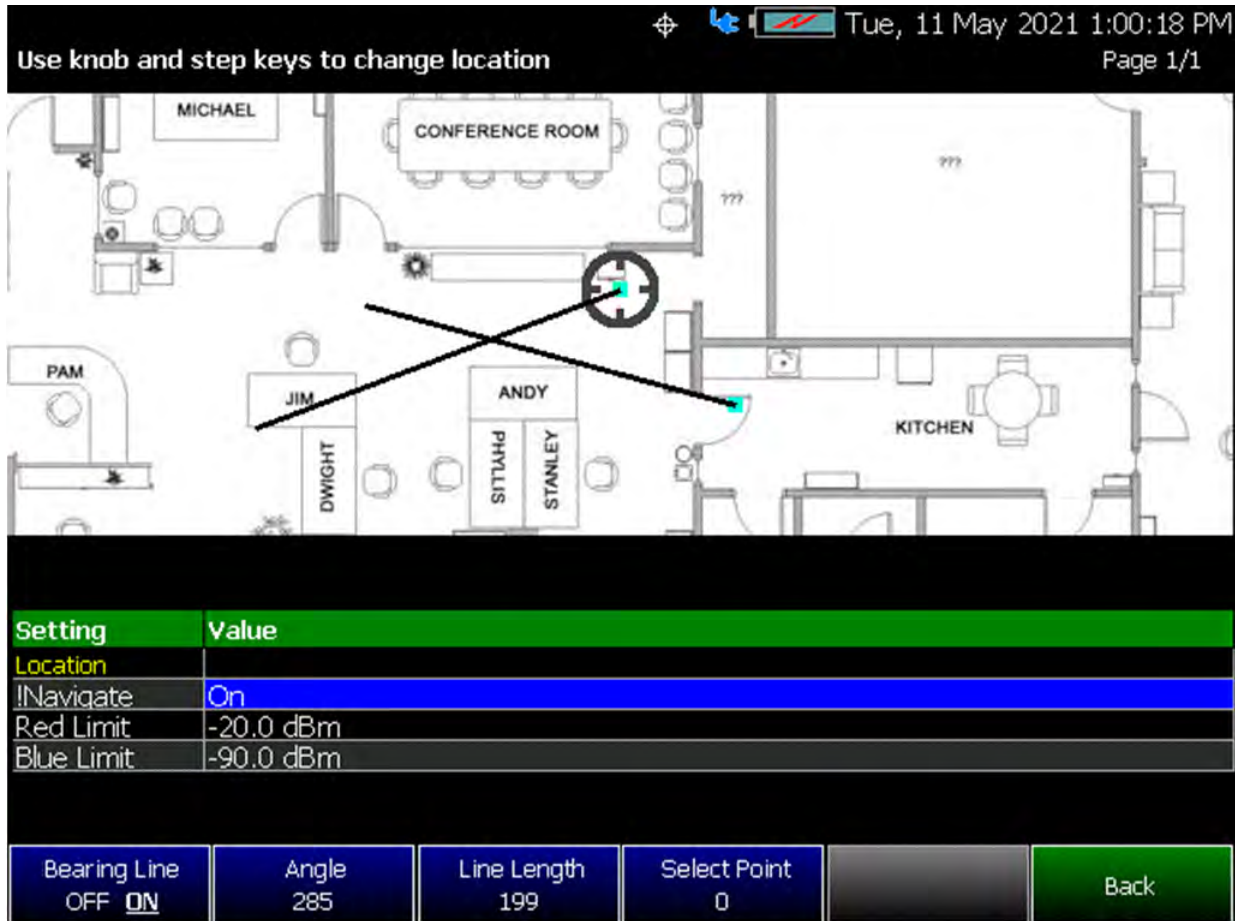

How to Record a Data Log (Outdoor Logging Only)

For Indoor Logging, refer to [“Enabling and Setting Up Indoor Map Logging” on page 478](#).

NOTE

Data Log-Play files are saved to:

- If File Folder is set to Default then Data Log-Play files are save-recalled to: "[CurrentDevice]\RecordPlayback\[Current mode]\"
- If File Folders are set to System, then Data Log-Play files are save-recalled to: "CurrentDevice\\"

- Press **Trace 6** > **Data Logging**
- Then **Record** (Outdoor Logging Only)

REC is displayed in the left of screen graticules.

Indoor and Outdoor Mapping – Option 352 (Requires Spectrum Analyzer Mode (Option 233 on N991xA), and GPS Receiver (Option 307))
How to Use Data Logging (Option 352)

During recording, choose from the following:

- **Pause Resume** Temporarily halts recording until pressed again. The incoming trace continues to sweep. Press again to continue recording.
- **Stop** Immediately stops recording. Then choose from the following:
 - Then **Record Save/Recall** To save a log file, recall logs, or change your file settings. Learn more, refer to **“To change Data Logging Configuration settings:” on page 489**.
 - Press **Save Log File** to save the current Table data (i.e., default save device is Internal).
 - Then **Record Settings (Outdoor Mapping only)** To change your measurement interval settings. Learn more, refer to **“To change Data Logging Configuration settings:” on page 489**.

To change Data Logging Configuration settings:

- Press **Trace 6**
- Then **Data Logging** then choose:
- Then **Record Settings** (Outdoor Mapping only)
 - Optional: Then **Meas Interval** > ON
 - Then **Interval Type** > choose **Time** or **Distance**.
 - Then, if applicable **Time Interval** enter time interval in seconds.
 - Or
 - Then, if applicable **Distance Interval** enter distance interval in meters.
- Then **Record Save/Recall**
 - Then **Device** (**Internal** (default), **SD Card**, or **USB**)
 - Then **File Type** (**CSV** (default), **DREC**, or **KML**)

Learn more, refer to the **Chapter 32, “File Management”**.

How to Play a Data Log

- Press **Trace 6**
- If the session is already open, skip the following step. Otherwise:

- Then **Data Logging** > **Record Save/Recall**

NOTE

If these are large recordings on a device, it could take several seconds for the FieldFox to display the list.

- Then **Recall Logs** use the Use the RPG or the **▲▼** arrow keys to highlight the file to be played.
 - Then **Recall File**
 - Then **Back**
- Then **Play** to playback your Table data.

PLAY is displayed in the left of screen graticules during playback. When the end of the recording is reached, playback begins at the start of scan and continues to loop indefinitely.

During playback, choose from the following:

- **Pause Resume** Temporarily halts playback. Then choose from the following:
 - **Pause Resume** Press to continue playing.
- **Stop** Immediately stops playback. Then choose from the following:
 - **Play** Start playback from start of scan.
 - **Recall Logs** Opens a list of stored data files.
Select a file to playback.
 - **Recall File**
 - **Back**
- **Cursor Position** use this softkey to move the data log play cursor in the current data log being played (i.e., **Cursor Position** is active only when playback is paused).

This softkey is only available in Channel Scanner and Phased Array Antenna modes (i.e., The Cursor Position softkey is **not** available for OTA mode).

- Press **Maps** – to open a softkey menu enable map view and related features (e.g., Data Selection, Red/Blue Limits, Labels & Icons, Zoom). Learn more, [“Enabling Outdoor Map Logging” on page 475.](#)

Indoor and Outdoor Mapping – Option 352 (Requires Spectrum Analyzer Mode (Option 233 on N991xA), and GPS Receiver (Option 307))
Update Available Message

Update Available Message

- If you see this message after opening and running the Run.bat file, ignore it and follow the procedure listed in, **“Downloading and Using the FieldFox Map Support Tool” on page 454.**

If you are unsuccessful in opening and running the FieldFox Map Support Tool when using the Run.bat then refer to, **“Contacting Keysight” on page 5.**

Refer to **Figure 16-25.**

Figure 16-25 Example of “UPDATE AVAILABLE” Message

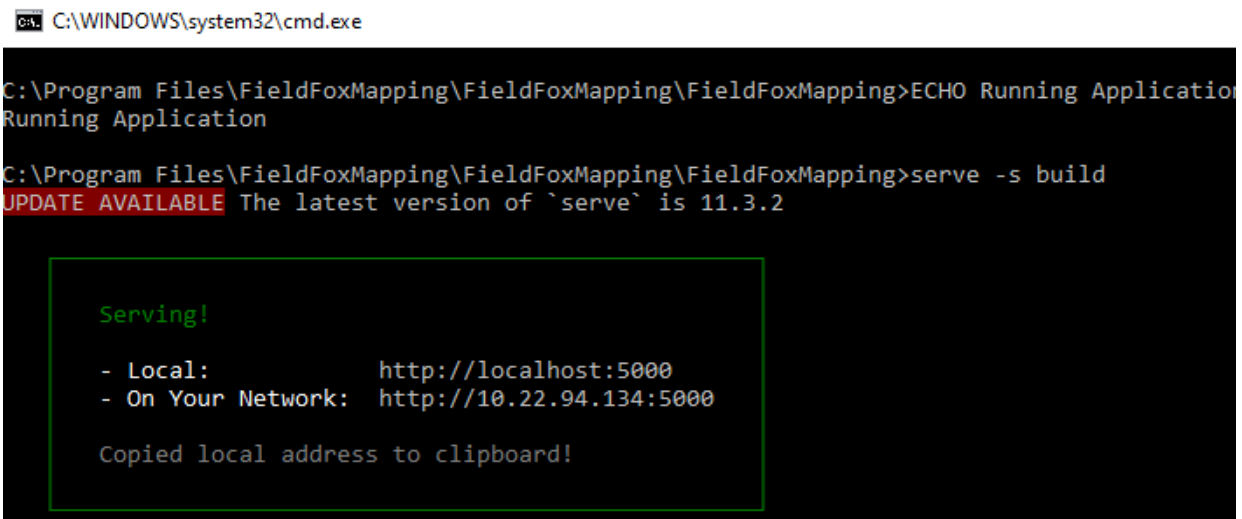

```
C:\WINDOWS\system32\cmd.exe

C:\Program Files\FieldFoxMapping\FieldFoxMapping\FieldFoxMapping>ECHO Running Application
Running Application

C:\Program Files\FieldFoxMapping\FieldFoxMapping\FieldFoxMapping>serve -s build
UPDATE AVAILABLE The latest version of `serve` is 11.3.2

  Serving!

  - Local:          http://localhost:5000
  - On Your Network: http://10.22.94.134:5000

  Copied local address to clipboard!
```

Troubleshooting

This section contains the following:

- **“General Troubleshooting”**
- **“Port 5000 in Use Error” on page 493**
- **“Miscellaneous Mapping Errors” on page 495**

CAUTION

IMPORTANT!

Do not change the default name of the directory path for downloading the Node.js program, because FieldFox uses the default program path name to run the Mapping feature. Refer to [Figure 16-4](#).

Examples of Web Browsers that not supported are Internet Explorer 6, 7, and 8.

General Troubleshooting

If your Mapping setup is not behaving as expected:

- Verify setup is correct by referring to “[How to Set Up Mapping Settings](#)” on [page 460](#).

- Attenuator set to **0 dB**
- Preamplifier set to **ON**
- Correct **Band**, **Channel**, and **Center** Frequency entered
- GNSS set to **Internal**
- Frequency Ref set to **GPS**
- ADC errors: Use **Scale/Amptd** > **Range** to adjust the absolute power level (dBm).

For some data views, you need to press **More** to view the **Range** softkey.

- No data displayed: Press **Meas Setup 4** then
 - Verify the correct **Antenna Settings** have been entered.
- The FieldFox’s displayed annotation indicates “Check LAN connection. Check IP address.” during pinging.

Verify:

- The LAN address for first 3 fields matches the Static IP address of FieldFox. For example, if the Ball Antenna IP address is **192.168.1**.10, set FieldFox Static IP address to **192.168.1**.xx. “xx” must be different number than shown in the last field of the for Ball Antenna. Refer to [Figure 14-15 on page 417](#).

NOTE

IMPORTANT! If you forget you N9910X-028 Ball Antenna’s static IP address, refer to [this link](#) and the **Support** tab for assistance: www.keysight.com/find/fieldfox and then to the **Phase Array Antenna Support Document**.

Port 5000 in Use Error

- If the cmd.exe window displays a “This port was picked because 5000 is in use.” error, then:
 - a. Type **Ctrl + c** in the command window
 - b. Press **Enter**
 - c. The command window should display text “Terminate batch job? (Y/N)”:

Type **y** and then press **Enter**

The command window should display message confirming the termination of the batch job and close.

Refer to **Figure 16-26**.

Figure 16-26 Example of “This port...because 5000 is in use.” Error

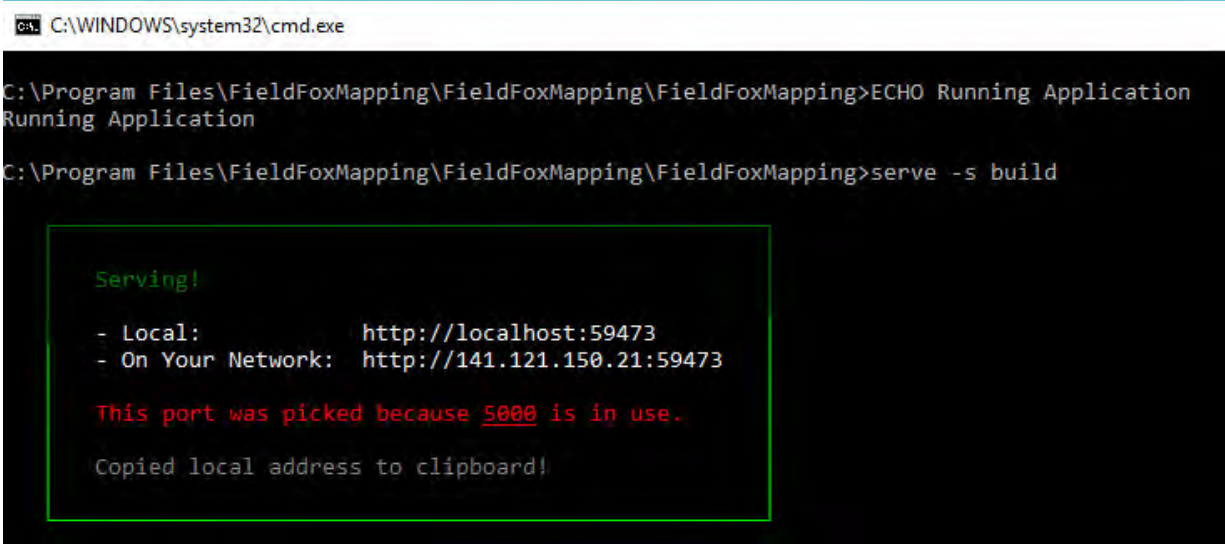

```
C:\WINDOWS\system32\cmd.exe

C:\Program Files\FieldFoxMapping\FieldFoxMapping\FieldFoxMapping>ECHO Running Application
Running Application

C:\Program Files\FieldFoxMapping\FieldFoxMapping\FieldFoxMapping>serve -s build

Serving!

- Local:          http://localhost:59473
- On Your Network: http://141.121.150.21:59473

This port was picked because 5000 is in use.

Copied local address to clipboard!
```

If the Map Support Tool displays the error shown in **Figure 16-26**, it means the selected map area is outside the current viewable area.

- You can either:
 - Move the map area by clicking the left mouse to the area you have selected or
 - Click the “Red X” to cancel the download

Figure 16-27 Example of “This port...because 5000 is in use.” Error

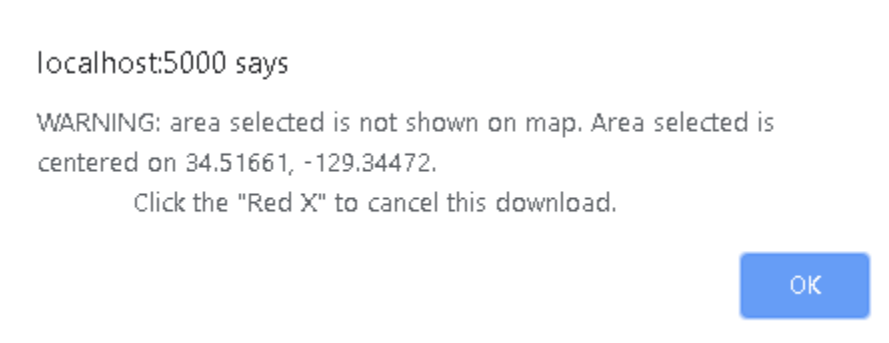

Miscellaneous Mapping Errors

When you are on step 3. Save Map Images, you may see a “fetch” error or a ‘checkerboard’ map displayed. Refer to [Figure 16-28](#) and [Figure 16-29 on page 496](#).

If you see a “fetch”, ‘checkerboard’, or other map errors:

1. Close your current browser window with OpenStreetMaps.org.
2. Open a different browser.
3. If necessary, re-run the FieldFox mapping script (`run.bat`) to re-copy the “localhost:5000” address into your clipboard.
4. Paste the “localhost:5000” address into a different browser and use OpenStreetMaps.org to save your Map image zip file.

Figure 16-28

Example of “This site says... Got error: Failed to fetch” Error

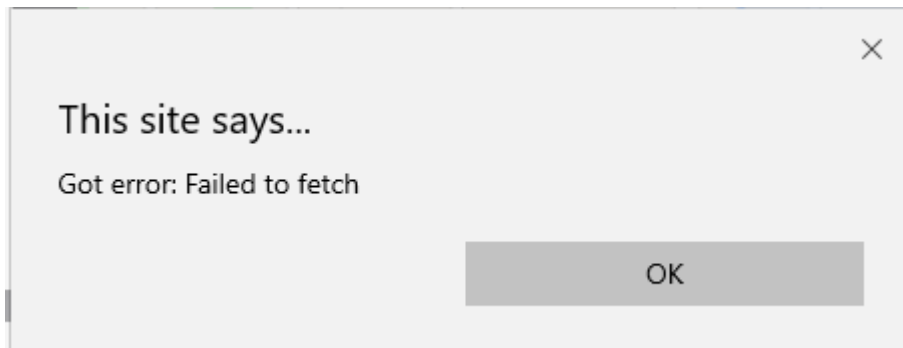
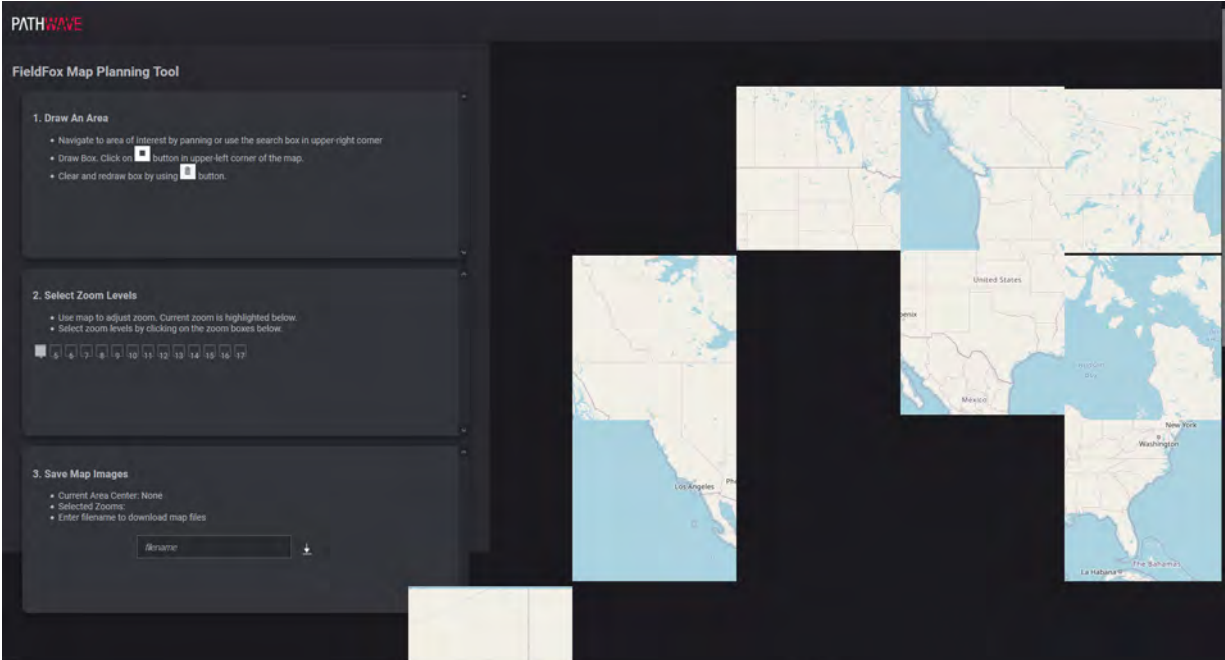

Figure 16-29 Example of 'Checkerboard' Mapping Error



17 Remote Server Mode (Requires CPU2 and SA Hardware/SA Option 233)

Remote server mode enables you to connect your FieldFox to compatible PC-based licensed software applications (e.g., 89600 VSA software¹). Refer to <http://www.keysight.com/find/assist>.

CAUTION

89600 VSA (via the Remote Server feature) is compatible with the frequency converter heads, but cannot apply or edit the frequency head corrections. Refer to “Utilities” on page 724.

NOTE

The FieldFox can be used with an OML frequency extender. Refer to “Utilities” on page 724, the *A Series FieldFox Configuration Guide 5990-9836EN*, and to “Contacting Keysight” on page 5.

1. To order the 89600 VSA Software, refer to <http://www.keysight.com/find/assist>.

NOTE

FieldFox with a Remote Server mode (available with FieldFox firmware \geq A.10.00) does not display a mode softkey, because Remote Server mode is only enabled when you have a SA Option 233 on the FieldFox, compatible 89600 VSA software license loaded and running on a remote PC, and connected via LAN to your FieldFox. (i.e., Requires 89600 VSA software version \geq 22.01). Refer to <http://www.keysight.com/find/assist>.

When in Remote Server mode, **most** of the front panel hardkeys are locked and will beep, but perform no actions when pressed (i.e., the FieldFox front panel hardkeys are not relevant when connected via LAN to the 89600 VSA software on your remote PC). In Remote Server mode only:

- **System 7** hardkey lets you change the system settings
- **Esc** (escape) hardkey lets you forcefully disconnect from the PC-based software

To **gracefully** disconnect (recommended) from the software, exit using the PC-based software's disconnect option or shutdown the software. Refer to [“Initial Waiting for a Connection from a PC-based and Compatible Licensed Software or No Remote Connection”](#) on page 500.

If you to attempt connect a non-compatible FieldFox you will see the following error message:

“Error: 38, The requested functionality is not available.”

Remote Server Mode (Requires CPU2 and SA Hardware/SA Option 233)
In this Chapter:

In this Chapter:

[“Connecting Using Remote Server” on page 500](#)

[“89600 VSA Software Overview \(Requires CPU2 and N991xA/3x/A5x/A6xA and SA Option 233\)” on page 502](#)

See Also

Optional Settings:

[“LAN Settings” on page 758](#)

[“All about Markers” on page 692](#)

[“All about Limit Lines” on page 707](#)

[“All about Trace Math” on page 712](#)

Connecting Using Remote Server

CAUTION

IMPORTANT!

When using a frequency converter head with remote server and 89600A VSA software, first verify the head has been selected in SA mode, before connecting to the VSA using IO Libraries. See also, [“Utilities” on page 724](#).

This section provides an overview of the FieldFox’s Remote Server mode instrument display messages that occur during the remote connection process. For more information on specific compatible PC-based licensed procedures refer to:

- [“89600 VSA Software Overview \(Requires CPU2 and N991xA/3x/A5x/A6xA and SA Option 233\)” on page 502](#)

Figure 17-1

Initial Waiting for a Connection from a PC-based and Compatible Licensed Software or No Remote Connection

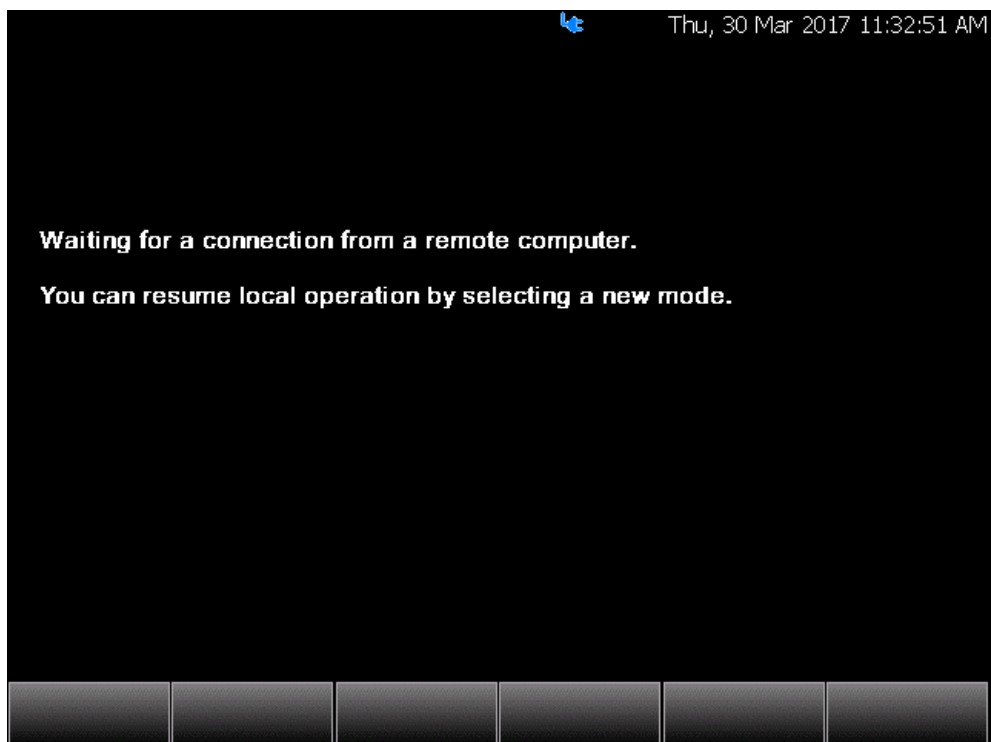

The graphic above shows the FieldFox in the process of connecting to a PC-based and compatible licensed software.

Figure 17-2

FieldFox Display When Remotely Connected to a PC-based Software

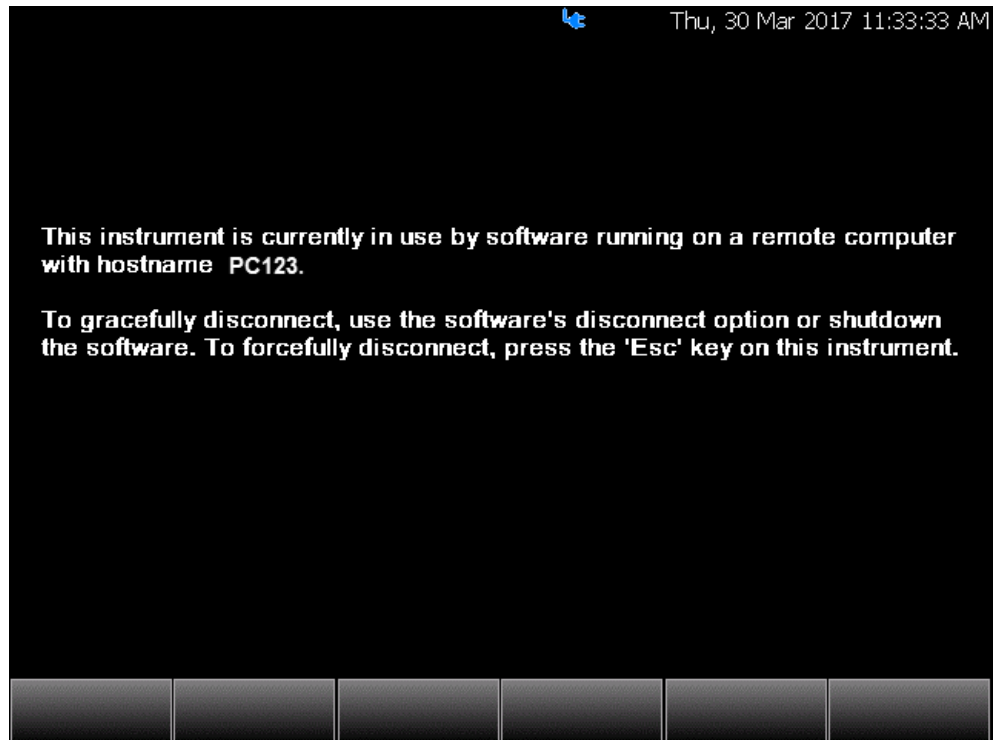

The graphic above shows the FieldFox successfully connected to a PC—with an example hostname “PC123”—and to a compatible licensed PC-based software.

Changing Frequency Converter Head Settings

If you want to change the frequency converter head settings while using the VSA, first it is necessary to disconnect from the 89600A VSA:

1. Disconnect from the 89600A VSA software, using the VSA's disconnect icon ().
2. Change modes to another frequency converter compatible mode (e.g., SA/RTSA/IQA/...)
3. Change the settings on your frequency converter head.

The frequency range in the VSA should always reflect the frequency converter head settings when you last connected.

4. Reconnect the FieldFox to the VSA using the VSA's software ().

For more information, refer to [“89600 VSA Software Overview \(Requires CPU2 and N991xA/3x/A5x/A6xA and SA Option 233\)”](#) on page 502.

89600 VSA Software Overview (Requires CPU2 and N991xA/3x/A5x/A6xA and SA Option 233)

NOTE

IMPORTANT! The following is a description of the 89600 VSA Software's overall capabilities. Your instrument may not have all of the hardware and firmware required to use all of the 89600 VSA Software's listed features.

The FieldFox remote server mode, requires 89600 VSA Software with firmware version ≥ 22.01 .

NOTE

If you have the FieldFox's Remote Server (89600 VSA software connectivity), you can use the VSA software to capture and record your data as MATLAB files (*.mat). Learn more about FieldFox and 89600 VSA software, refer to <http://www.keysight.com/find/assist>.

If you have Option 351 I/Q Analyzer option, you can directly save your data as MATLAB files (*.mat). Refer to **Chapter 11, "IQ Analyzer (IQA) – Option 351 (CPU2 Only)"**, on page 293 and to **Chapter 32, "File Management."**

Connecting the FieldFox remotely to a PC running the 89600 VSA software, will start the FieldFox's Remote Server mode. The 89600 VSA software is powerful, PC-based software, offering the industry's most sophisticated general purpose and standards specific signal evaluation and troubleshooting tools for R&D engineers. Even for proprietary and non-standard signals in SATCOM or MILCOM applications, you can make signal quality measurements with customized IQ constellation. Reach deeper into signals, gather more data on signal problems, and gain greater insight.

- General-purpose analog and digital demodulators ranging from 2FSK to 4096QAM
- Flexible and custom IQ and OFDM signal analysis
- Standards specific modulation analysis including:
 - Cellular: 5G, LTE & LTE-Advanced (FDD, TDD), W-CDMA, GSM/EDGE, cdma2000, 1xEV-DO, TD-SCDMA,
 - Wireless connectivity: 802.11ax, 802.11n/ac, 802.11a/b/g/j/p, 802.16 WiMAX (fixed/mobile), 802.15.4 Wi-SUN
 - RFID
 - Digital satellite video and other satellite signals, radar, LMDS
- Up to 400K bin FFT, for the highest resolution spectrum analysis
- A full suite of time domain analysis tools, including signal capture and playback, time gating, and CCDF measurements
- Unlimited trace displays and the industry's most complete set of marker functions

Remote Server Mode (Requires CPU2 and SA Hardware/SA Option 233)
89600 VSA Software Overview (Requires CPU2 and N991xA/3x/A5x/A6xA and SA
Option 233)

- Easy-to-use Microsoft Windows graphical user interface

For a comprehensive FieldFox VSA mode help, refer to
<http://rfmw.em.keysight.com/wireless/helpfiles/89600B/WebHelp/89600.htm>

For additional information on the 89600 VSA Software brochure, refer to
<https://www.keysight.com/us/en/assets/7018-02714/brochures/5990-6553.pdf>

For Technical Overview, refer to
<https://www.keysight.com/us/en/assets/7018-02679/technical-overviews/5990-6405.pdf>

Remote Server Mode (Requires CPU2 and SA Hardware/SA Option 233)
89600 VSA Software Overview (Requires CPU2 and N991xA/3x/A5x/A6xA and SA
Option 233)

18 Interference Analyzer (SA Mode) – Option 236

Option 236 provides Spectrogram display, Waterfall display, and Record/Playback.

In this Chapter

[“Spectrogram Display \(SA Option\)” on page 506](#)

[“Common Settings for Waterfall and Spectrogram” on page 508](#)

[“Waterfall Display” on page 509](#)

[“About Sessions” on page 510](#)

[“FieldFox Setting Changes during Record and Playback” on page 511](#)

[“About State and User Tags” on page 512](#)

[“How to Record a Session” on page 513](#)

[“How to Playback a Session” on page 514](#)

[“Recording Configuration” on page 515](#)

[“Playback Configuration” on page 518](#)

[“Manage Sessions” on page 519](#)

[“Record Playback Example \(SA Only\)” on page 520](#)

Spectrogram and Waterfall Displays

Spectrogram and Waterfall displays provide a visual history of the measured spectrum. Each display type can be used to locate intermittent signals or to view signal levels and frequencies over time.

Spectrogram is a single horizontal line of color-coded power while Waterfall uses a 3-D color-coded display. The functional difference between these two displays is that Spectrogram provides less trace detail than Waterfall display. However, it also allows more traces to be viewed.

These two displays can NOT be used with Channel Measurements.

In SA mode, Traces can be recorded from, or played back into, any measurement type (such as Channel Power or Occupied BW) or any display type (such as Spectrogram and Waterfall). See **“How to Record a Session”** on **page 513** to learn how to save traces.

Spectrogram Display (SA Option)

Spectrogram draws the most recent trace record at the bottom of the stack of previously-drawn trace records. Drawing the live trace on the display is optional.

Figure 18-1

Spectrogram display- Overlay view- with time markers 23 seconds apart.

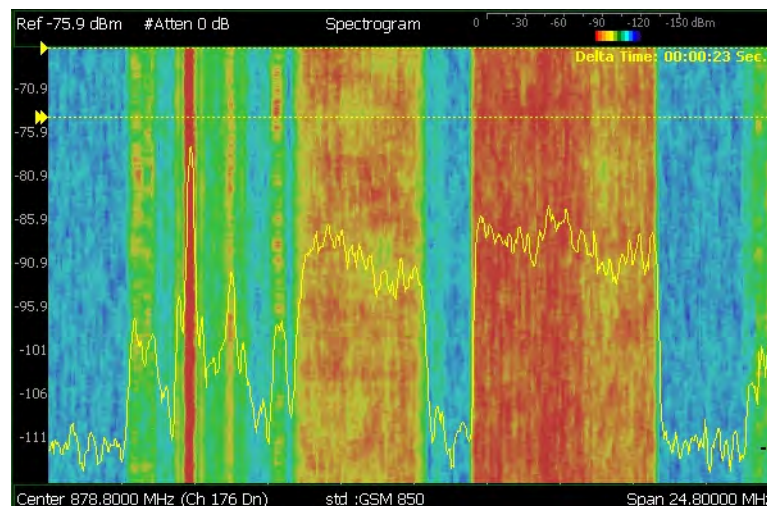

The following settings all contribute to the sweep time of an individual trace, and therefore, the total elapsed time that can appear on the screen in Spectrogram display:

- Frequency Range. Learn more in **“Frequency Range”** on **page 163**.
- Resolution BW and Video BW. Learn more in **“Resolution Bandwidth (Res BW)”** on **page 194** and **“Video Bandwidth (Video BW)”** on **page 195**.
- Sweep Time (Acquisition). Learn more in **“Sweep Acquisition”** on **page 199**

- Resolution (Number of Points). Learn more in **“Points” on page 208.**

How to select Spectrogram

- Press **Meas 1**
- Then **Interference Analysis**
- Then **Spectrogram**

How to modify the Spectrogram

You can change how the spectrogram is displayed relative to the data trace. This setting affects the total number of trace records that can be displayed.

For SA Mode:

- Press **Meas Setup 4.**
- Then **Spectrogram Settings**
- Then **Spectrogram View**
- Then choose from the following:
 - **Overlay** Displays the data trace over the spectrogram with NO graticules. Total trace records: 340.
 - **Full Screen** Displays the spectrogram with NO data trace. Total trace records: 340.
 - **Top** Displays the data trace below the spectrogram. Total trace records: 130.
 - **Bottom** Displays the data trace above the spectrogram. Total trace records: 130.

How to create Time Markers (SA Only)

Use Time Markers to determine the elapsed time between any two displayed records. The most recent record appears at the bottom of the screen.

- Press **Meas Setup 4**
- Then **Time Markers**
- Then **Time**
- Then enter a value from 0 (the most recent sweep record) to the maximum value, using the numeric keypad, **▲▼** arrows, or the rotary knob. A **>** indicates the Time Marker.
- Then **Delta**
- Then enter a value from 0 (the most recent sweep record) to the maximum value, using the numeric keypad, **▲▼** arrows, or the rotary knob. A **>>** indicates the Delta Marker.

- At the current sweep speed, the difference in time between these two markers appears at the upper-right corner of the view as **Delta Time: hh:mm:ss Sec**.
- An invalid number (very large positive or negative) appears when a trace record is not available at either marker. 00:00:00 Sec appears when both markers are not available.

Common Settings for Waterfall and Spectrogram

NOTE

Waterfall settings only apply to the SA option.

Set Red and Blue Limits

The colors displayed on the Waterfall and Spectrogram represent the various measured power levels:

- Red = Highest power levels
- Blue = Lowest power levels

NOTE

The full Red-to-Blue color spectrum is visible only with Indoor display colors. Learn more in [“Display Colors” on page 721](#).

Adjust the Red and Blue limits to the power levels that you expect to measure.

The Blue limit must always be less than the Red limit.

For SA Mode:

- Press **Meas Setup 4**.
- Then **Spectrogram Settings** or **Waterfall Settings**
- Then choose from the following:
 - **Red Limit** Using the **▲▼** arrows, rotary knob, or keypad, select the HIGHEST power level that you expect to measure. This power level, and those measured higher than this level, appear Red.
 - **Blue Limit** Using the **▲▼** arrows, rotary knob, or keypad, select the LOWEST power levels that you expect to measure. This power level, and those measured lower than this level, appear Blue.

How to Restart the Spectrogram/Waterfall

Press **Sweep 3** then **Restart**

Averaging

Averaging can be enabled on the underlying measurement. Press **Meas 4** then **Average Type**. Learn more in [“Average Type” on page 209](#).

Mode Preset

Mode Preset resets ONLY the Spectrogram and Waterfall display settings. It does not reset the measurement settings.

- Press **Preset**
- Then **Mode Preset**

Waterfall Display

The live trace is always drawn on a Waterfall display. Older trace records scroll up from the displayed trace and eventually off the screen. Because of this, locate the live trace on the bottom of the screen using the scale and reference settings. Learn how in [“Scale and Units” on page 168](#).

NOTE

Although this document refers to past traces as ‘records’ these traces are not saved. They are only drawn on the FieldFox screen. See [“Record Playback Example \(SA Only\)” on page 520](#) for how to save traces.

The following settings all contribute to the sweep time of an individual trace, and therefore, the total elapsed time that can appear on the screen in Waterfall display:

- Frequency Range. Learn more in [“Frequency Range” on page 163](#).
- Resolution BW and Video BW. Learn more in [“Resolution Bandwidth \(Res BW\)” on page 194](#) and [“Video Bandwidth \(Video BW\)” on page 195](#).
- Sweep Time (Acquisition). Learn more in [“Sweep Acquisition” on page 199](#)
- Resolution (Number of Points). Learn more in [“Points” on page 208](#).

Waterfall Angle

This setting allows you to show more or less detail. More detail provides fewer (time) records.

- Press **Meas Setup 4**
- Then **Waterfall Settings**
- Then **Waterfall Angle**
- Then choose from the following:
 - **Moderate** Compromise between detail and number of records.
 - **Steep** Least detail with highest number of records.
 - **Gradual** Most detail with lowest number of records.

- **Wide Angle** Moderate angle with increased space between records.

Learn how to set **Red and Blue Limits** in **“Set Red and Blue Limits”** on **page 508**.

Record/Playback (SA Option)

Record Playback allows you to record SA trace sweeps and play them back at a later time. Use this feature to monitor spectrum activity over a period of time.

You can record traces continuously, record a specified number of traces (segments), or record when triggered by a specified power level.

Traces can be recorded from, or played back into, any measurement type (such as Channel Power or Occupied BW) or any display type (such as Spectrogram and Waterfall).

When GPS is enabled, the current location and elevation are saved and played back with traces.

Recordings can be saved to the FieldFox Internal memory, an SD Card, or a USB flash drive.

About Sessions

A Recording Session is a collection of recorded traces and the instrument states that generated them.

Before recording can occur, a new session must be initiated or an existing session must be opened. Sessions can later be opened for playing or continued recording. Only one session can be open at a time.

You close the session when finished recording or playing. A session is also closed when the FieldFox is Preset (or Mode Preset), an Instrument State is recalled, or when Mode is changed from SA.

Each session is saved as a folder containing a set of files on the specified storage device.

How long can a recording session last?

There are many variables that determine the possible length of a recording session. But one key variable is the amount of available memory.

When a session is opened or a new session is initiated, an estimate is made of the maximum number of traces that can be saved based on the available disk space and the current number of data points (resolution). Recording will stop when that number is reached. This estimate always keeps 4 MB of available disk space on the specified storage device. You can decrease the number of traces to further limit recording. The resolution setting can NOT be changed after a session is opened.

To maximize the amount of space that is available, save recorded traces to a USB Flash drive or SD card. Learn how in [“Manage Sessions” on page 519](#).

You can determine the length of time over which recording can occur by setting the Record Interval (the time between recorded traces) and other settings. Learn more in [“Recording Configuration” on page 515](#).

To view and edit the maximum number of records

Just after opening or initiating a session...

- Press **Session Data**
- Then **TraceRecordLimit <n>** (n = Max number of traces that can be recorded).
- **Clear All Records** Empties that session of recorded traces. Learn more in [“Manage Sessions” on page 519](#).

FieldFox Setting Changes during Record and Playback

During Recording

When any of the following State settings are changed during recording, the State counter is incremented ([“About State and User Tags” on page 512](#)) and the settings are saved to the Session file along with the first trace to be recorded with the new setting. During playback, the trace and display annotation will reflect the change on the screen.

State settings:

Refer to [Table 18-1](#) for a list of the applicable state settings for the SA option.

Table 18-1

Summary of SA State Settings

Option	Settings
SA	
	Average Type
	Detector(s)
	External Gain
	Frequency Range
	Preamp On/Off
	Resolution BW
	RF Attenuation
	Source Settings
	Sweep Acquisition

Table 18-1

Summary of SA State Settings

Option	Settings
	Trigger Settings
	Video BW
	Zero Span Sweep Time

Other display settings, such as Scale and acquisition, can also be changed during recording but are not saved with the session file. Think of these as settings that help YOU see the recording and playback activity. They do NOT change the data that is recorded.

During Playback

The State setting changes listed above are NOT allowed during playback.

However, all other display settings can be changed during playback to help you analyze the recorded data.

In SA mode, when recordings are played back further trace processing is possible. The Trace State(s) can be modified for post processing, and different measurements such as Channel Power, Occupied BW, Spectrogram, and Waterfall can be activated. This is because in SA all these measurements are derived from the raw traces. If not compatible with the measurement type, a **MEAS UNCAL** message will appear on the screen.

Record/Playback Exceptions

- Markers can be activated and moved to help analyze recorded data. However, marker position control is only available when playback is Paused.
- Field Strength Corrections is saved with the session file and it is also allowed during playback. Learn about this Field Strength Corrections in **“Field Strength Measurements” on page 172.**
- Frequency Counter at Marker is NOT allowed during Recording or Playback. Learn about this feature in **“Frequency Counter at Marker” on page 222.**

About State and User Tags

When any of the State settings (listed above) are changed during a recording, a ‘state tag’ is inserted at the first trace number to be recorded with the new setting.

In addition, you can insert a ‘User Tag’ at any time during a recording session to indicate an external event, such as when an antenna is moved. During playback, you can move quickly to any of these tags, or scroll through these tags.

A symbol is used on the screen annotation to distinguish a User Tag from a State Tag when scrolling through tags during playback.

Screen Annotation

During a record or playback session, the following is displayed in the top-left area of the screen:

– **AutoSession02: 92/95 (state 4/5)_***
Sep.22.2018 09:15:15 AM

where:

- **AutoSession** is an auto-generated name for sessions. **02** is the auto-generated number, incremented with each new session. The name can be changed using Manage Sessions. Learn more in [“Manage Sessions” on page 519](#).
- **92/95** is the current and total trace number: currently trace is 92 of 95 total traces.
- **state 4/5** is the current and total state tag or user tag number: 4 of 5 total tags.
- ***** (Asterisk) indicates that a state has changed. **#** (Pound) indicates that a User Tag has been inserted.
- **Sep.22..** is the date and time of recording.

When GPS is enabled, the current location and elevation are annotated at the bottom of the playback display. Learn more in [“GNSS \(GPS+\) and GPS” on page 749](#).

NOTE

If Recording or Playback is not occurring when you think it should, check the following:

- Is the sweep in **HOLD**? (upper-left annotation)
- Is Recording or Playback **Paused**? (mid-left annotation)
- Is the Record or Playback **Interval** set too long? (Configuration settings.)

How to Record a Session

- Press **Trace 6**
- Then **Record Playback**
- SA Only: Optionally set resolution (points). Learn how in [“Points” on page 208](#). This can NOT be changed after a session is opened.
- Then either:
 - **New Session** OR
 - **Recall Session** then **Open** and select a session.
- Then **Recorder Player**
- Then **Record**

REC is displayed in the left of screen graticules.

During recording, choose from the following:

- **Pause Resume** Temporarily halts recording until pressed again. The incoming trace continues to sweep. Press again to continue recording.
- **Stop** Immediately stops recording. Then choose from the following:
 - Press **Play** to start replaying the recording from the beginning.
 - Press **Record** to continue recording.

How to Playback a Session

- Press **Trace 6**
- If the session is already open, skip the following step. Otherwise:
- Then **Record Playback Setup**
 - Press **Recall Session** Then select a session to playback and press **Open**.
- Then **Recorder Player**
- Then **Play**

PLAY is displayed in the left of screen graticules during playback. When the end of the recording is reached, playback begins again at trace 1 and continues to loop indefinitely.

During playback, choose from the following:

- **Pause Resume** Temporarily halts playback. Then choose from the following:
 - **Pause Resume** Press to continue playing.
 - **Playback State/Tag** Allows you to continue playback from a state tag, or scroll through the state tags. Enter a value between 1 and the total number of state tags using the numeric keypad, **▲▼** arrows, or the rotary knob. Active when playback is paused. Learn more in **About State and User Tags** in **“About State and User Tags” on page 512**.
 - **Playback Trace** Activated automatically when Paused. Allows you to continue playback from a specific trace, or scroll through traces manually. Enter a value between 1 and the total number of traces using the numeric keypad, **▲▼** arrows, or the rotary knob.
- **Stop** Immediately stops playback. Then choose from the following:
 - **Play** Start playback from trace 1.
 - **Record** Resume recording from the last recorded trace.

- **Record Playback Setup** Return to the setup menu to change Configuration settings or Close the session.

Recording Configuration

To change Recording Configuration settings:

- Press **Trace 6**
- Then **Record Playback**
- Then **New Session** or **Recall** an existing session.

If **New Session** is selected:

- Then **Session Data** and choose one of the following:
- Then **CSV SaveStyle**
 - **Single Trace** (default) saves the currently displayed trace.
 - **Range Traces** saves the currently displayed trace. This selection requires you to manually select a range of traces to be recorded in the Playback Configuration menu. Refer to **“Playback Configuration” on page 518**.
 - **AllTraces** saves all traces.
- Then **TraceRecordLimit** to change the maximum recording file size.
- Then **Clear AllRecords** to clear all traces out of memory.
- Then **Back** to return to previous menu.
- Then **Recording Configuration**

Then choose from the following:

- **Record Time** Sets the amount of time to record traces. Default is MAX, which is to record indefinitely. Enter a value between 1s and 1 Ms (million) seconds using the numeric keypad, **▲▼** arrows, or the rotary knob. When set, a timer appears during recording in the lower-left corner which counts DOWN from the specified time.
- **Record Source** Sets where, in the FieldFox data flow, data is recorded. Learn more in **“Record Source” on page 517**. Choose from the following:
 - **RawMeas** Records raw measurement data.
 - **Trace 1,2,3,4** Records data from the corresponding trace in its current state.
- **Record Interval** Sets the amount of time to wait between individual trace recordings. Default is MIN, which is to wait 0 seconds (record traces as fast as possible). Enter a value in seconds between 0 (no delay) and 10,000 seconds - about 3 hrs) using the numeric keypad, **▲▼** arrows, or the rotary knob.

- **Segment Count** Sets the number of traces to record, after which the recording will automatically pause. Press Pause/Resume or Record to capture another N traces, or Stop to end recording. Default is OFF, which is NO limit to the number of traces to be recorded.

When set, a counter appears in the lower-left corner which counts UP to the specified number of recordings.

- **FreqMaskTrigger OFF ON**
Sets the power level which will trigger a recording. Set these power levels (mask) exactly as you would set Limit Lines. (See “All about Limit Lines” on page 707.) With **Record ON**, when any data point measurement is higher than an upper limit, or lower than a lower limit, recording begins. See Frequency Mask Trigger Configuration in the following section to learn how to configure the mask.

Typically you would use FreqMaskTrigger with Segment Count, but it can also be used with Record Time and Record Interval.

When used with **Segment Count**:

- When a mask limit is exceeded, subsequent traces are recorded until the specified segment count is reached. Once segment count is reached, exceeding another mask limit will again cause traces to be recorded until the segment count is reached, and so forth.
- To record only those traces that exceed the limit, set Segment Count to 1
- To record ALL traces after a limit is exceeded, set Segment Count OFF.

When used with **Record Time**, the timer counts down even when traces are not being recorded (limits are not being exceeded). Recording starts when a limit is exceeded and stops when the timer reaches 0.

When used with **Record Interval**, a trace is recorded when a limit is exceeded, then no recordings during the specified ‘wait’ interval, then the next trace is recorded, followed by another time delay, and so forth. This pattern repeats indefinitely if Segment Count is OFF, or (if ON) until Segment Count is reached.

Frequency Mask Trigger Configuration (SA Mode Only)

Create or recall a Frequency Mask to be used with the FreqMaskTrigger feature.

NOTE

Frequency Mask Trigger only applies to SA mode.

NOTE

- The Mask file is saved to, and recalled from, the Save /Recall Storage Device location – NOT from the Record Playback Storage Device location. These are two different settings. Learn how to set the Save /Recall Storage Device in [“Set File Type and Select Device” on page 773](#).

A mask that is in use during a recording is NOT saved with the recording and does NOT automatically appear during playback. Like Limits Lines, it is saved and recalled with a state file.

Although they are created in the same manner, Limit Line files and FreqMask files can NOT be used interchangeably.

- Press **Trace 6**
- Then **Record Playback**
- Then **New Session** or **Recall** an existing session. The current mask appears as soon as a session is opened.
- Then **FreqMaskTrigger Configuration**
- Then choose from the following
 - **Edit Mask** Create or modify the current mask. Learn how to edit the Mask / Limit Line table in [“All about Limit Lines” on page 707](#).
 - **Save Mask** Saves the current mask to a file.
 - **Recall Mask** Loads a mask file.

Record Source

NOTE

The RawMeas data setting only applies to SA Mode.

For SA mode, the simplest way to use Record Playback is to record RawMeas data, which can then be played back into all of the current Trace States.

However, for more complicated processing, refer to the following diagrams. These figures illustrate where in the FieldFox data flow data is recorded and played back.

NOTE

For this discussion, it is important to understand Trace States. Learn more in [“Trace Display States \(SA Mode\)” on page 208](#).

Figure 18-2

FieldFox SA Mode: Data Flow and Record Playback Data Points

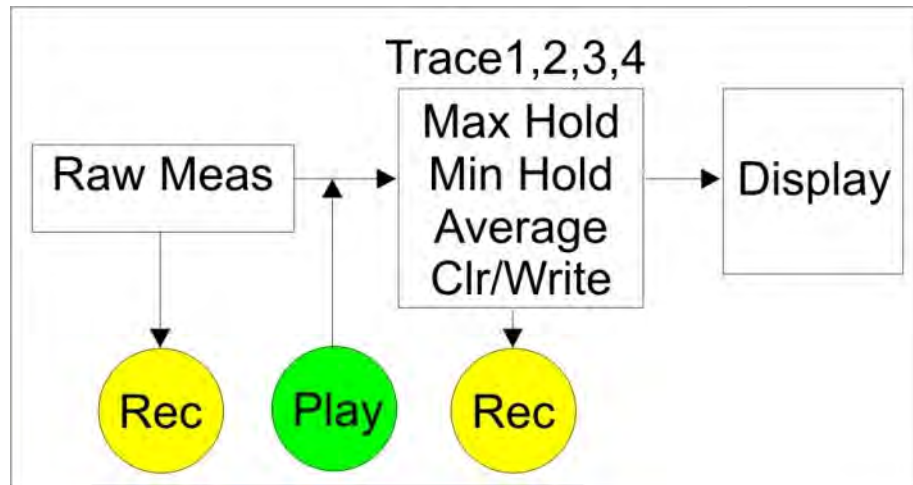

SA Data Recording:

- Data can be recorded at the **Raw Meas** block where data is acquired after ResBW, VideoBW, and Detector processing, but before any trace state processing.
- Data can be recorded from Traces 1,2,3, or 4 which includes the trace state (Max Hold, Min Hold, and so forth).
- Recording from a Clear/Write trace yields exactly the same data as recording from the Raw Meas block.
- Data is ALWAYS played back at the same location in the data flow: just after the Raw Meas block, through all currently active Traces, and onto the display.
- See an **example** using Record Playback with Max Hold traces in **“Record Playback Example (SA Only)”** on page 520.

Playback Configuration

By default, trace sweeps are played back as fast as the trace can be drawn on the screen. The following setting allows you to slow playback. In addition, you can manually scroll through individual traces using Playback Trace, or scroll through State and User Tags using Playback State/Tag. Learn more in **How to Playback a Session** in **“How to Playback a Session”** on page 514.

To slow playback of a session:

- Record a new session or Open an existing session.
- Press **Playback Configuration**
- Then **Playback Interval**

- Enter a value in seconds between 0 (no delay) and 100 using the numeric keypad, **▲▼** arrows, or the rotary knob. After using the keypad, select a multiplier key. Learn about multiplier abbreviations.
- Press **Enter**
- **First Trace** to define the first trace in a Range of traces to be recorded/played/saved.

Manage Sessions

- Press **Trace 6**
- Then **Record Playback**
- Then **Record Playback Setup** The following selections are available ONLY when a session is NOT open.
- Then **Storage Device** to select the media which stores the sessions to be managed. This is a different setting from the Save/Recall Storage Device setting.
- Then choose from the following:
 - **Internal** FieldFox memory (default)
 - **SD Card** An external SD Card (must be inserted)
 - **USB** An external USB flash drive (must be inserted)
- Then **Manage Sessions**
- Then choose from the following:
 - **Rename** Using the FieldFox labeler, change the name of the session. AutoSession (n) is the default name where (n) is the next-available number. Learn more in **“How to use the FieldFox labeler ” on page 770.**
 - **Sort** Arrange the listing of sessions **by Name**, **by Date**, or **by Size**.
 - **Delete** After a confirmation prompt, removes the contents of the selected session from the list.
 - **Copy** Copies the selected session to a different storage device, or the same storage device with ‘Copy(n)_’ appended to the beginning of the name so that duplication is prevented.
 - **Copy All** Copies ALL of the listed sessions to a different storage device, or the same storage device with ‘Copy(n)_’ appended to the beginning of the names so that duplication is prevented.
 - **Delete All** Deletes ALL of the listed sessions.

Record Playback Example (SA Only)

The following “Interval Recording” example shows how you can record spectral activity over a longer period of time with less trace storage.

- Press **Trace 6** then, with **Trace** = 1, press **State** then **Max Hold**
- Then **Record Playback**
- Then **New Session**
- Then **Recording Configuration**
- Then **Record Source** to Trace1
- Then **Record Interval** to 10 **s** (seconds).
- Then **Back**
- Then **Recorder Player**
- Then **Record** At the end of each 10 second record interval, the Max Hold trace is recorded and the Max Hold processing is reset for the next 10 second record interval.
- Then **Stop** to end the recording.

This session can be played back into any Trace State. For example:

Play the Max Hold recording into a **Clear/Write trace** to see the data exactly as it was recorded.

- Press **Trace 6** then with **Trace** = 1 and press **State** then **Clr/Wr**
- Then **Record Playback**
- Then **Play**

Play the Max Hold recording into a Max Hold trace to show the accumulation of “Max Hold” activity over the entire recording.

- Press **Trace 6** then with **Trace** = 1 and press **State** then **Max Hold**
- Then **Record Player**
- Then **Play**

19 Reflection Mode (SA Models) - Option 320

NOTE

Option 320 requires Option 220 Tracking Generator. N9938A models require Option 100 3.5 mm connectors and Option 220.

- Option 100 3.5 mm connectors must be installed by the factory. Option 100 is only available on N9938A at the time of purchase. It is not available as a trial/upgrade.
- Option 220 Tracking Generator can be ordered via software license on www.keysight.com.

Option 320 is not available on N991xA, N992xA, or N995xA models.

This feature may require an option. Please view the FieldFox Configuration Guide at: [A Series FieldFox Configuration Guide 5990-9836EN](#).

Reflection Mode measurements are very similar to CAT mode reflection measurements. They provide 1-port scalar reflection measurements in selected FieldFox **SA-Only** models. The FieldFox source is routed internally to Port 1 and used to stimulate a Device Under Test (DUT). The energy that is reflected off the DUT is measured and displayed on the screen.

SA mode reflection measurements are **CalReady**. Learn more in [“CalReady” on page 135](#). In addition, Normalization is available. Learn how [“Normalize” on page 524](#). However, other calibration types are NOT offered.

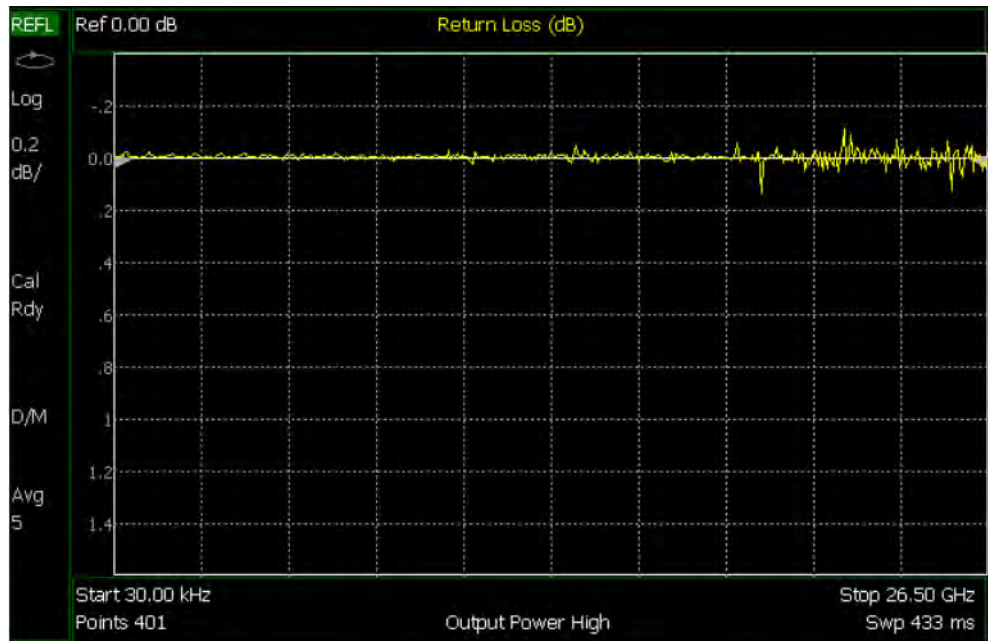

In this Chapter

[“How to select Reflection Mode” on page 524](#)

[“Measurement Selection” on page 524](#)

[“Normalize” on page 524](#)

The following settings are available exactly as they function in CAT mode:

“Frequency Range” on page 59

“Scale Settings” on page 59

“Averaging” on page 60

“Single or Continuous Measure” on page 61

“Resolution (Number of Data Points)” on page 62

“Sweep Time” on page 62

“Output Power” on page 63

“Interference Rejection” on page 64

“All about Markers” on page 692

“All about Limit Lines” on page 707

Reflection Mode Settings

Select **Reflection Mode** before making any setting in this chapter.

How to select Reflection Mode

- Press **Mode**
- Then **Reflection**

Measurement Selection

How to select a Reflection Mode Measurement

Learn more about these two measurements in the Supplemental Online Help:
<http://na.support.keysight.com/fieldfox/help/SupHelp/FieldFox.htm>

- Press **Measure 1**
- Then choose one of the following: These softkeys also appear after Reflection Mode is selected.
 - **Return Loss** 1-port scalar reflection measurement that displays the amount of incident signal energy MINUS the amount of energy that is reflected. The higher the trace is on the screen, the more energy being reflected back to the FieldFox.
 - **VSWR** (Voltage Standing Wave Ratio – also known as SWR) 1-port reflection measurement that displays the ratio of the maximum reflected voltage over the minimum reflected voltage. The higher the trace is on the screen, the more energy being reflected back to the FieldFox.

Normalize

Normalization can be used to effectively 'Zero' a trace, which removes frequency response errors introduced by the components of the test setup before making the measurement. To normalize a reflection measurement, the DUT is removed and a known device is connected to Port 1. When you choose Normalize, the displayed trace is stored into memory and then the displayed data is divided by the memory trace. The displayed data trace now shows the difference between the stored memory response and the measured response.

You could normalize while measuring the reflection response of any type of device. For example, the device could be:

- An Open or Short (with maximum reflection)

How to perform Normalization

To Port 1, connect a known device (usually an Open or Short) to which reflection measurements are to be normalized.

Reflection Mode (SA Models) - Option 320
Reflection Mode Settings

- Press **Trace 6**
- Then **Normalize**

The yellow data trace displays the current measurement with trace math applied. The math operation symbol **[D/M]** is displayed on the lower left corner of the screen. Learn more about Trace Math in **“All about Markers” on page 692**.

NOTE

Data interpolation is NOT supported. If the Resolution setting is changed with Trace Math enabled, the FieldFox will disable the math operation.

Reflection Mode (SA Models) - Option 320
Reflection Mode Settings

20 Built-in Power Meter Mode – Option 310

Built-in Power Meter (also known as Channel Power Meter) uses the SA input connector to make quick and simple power measurements over a selectable frequency band. A power sensor is NOT required.

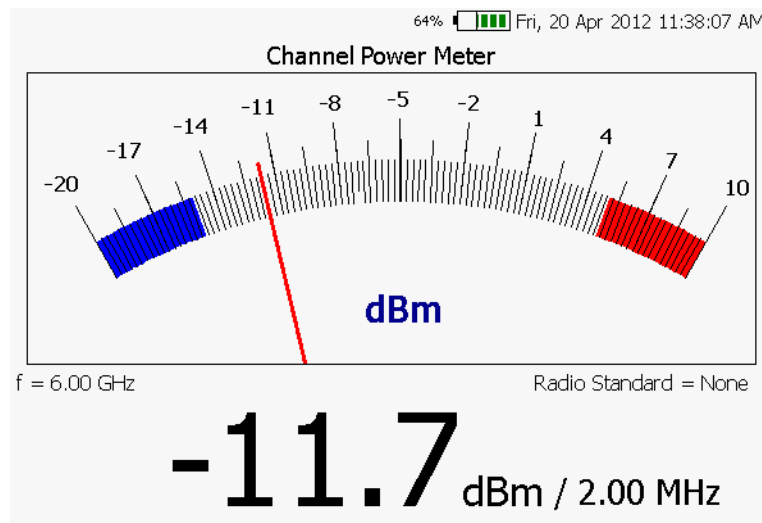

In this Chapter

[“Frequency/ Span / Step” on page 529](#)

[“Radio Standard” on page 530](#)

[“How to set Attenuation” on page 530](#)

See Also

The following Built-in Power Meter settings are identical to the standard Power Meter settings:

[“Scale” on page 539](#)

[“Relative and Offset Power Measurements” on page 540](#)

[“Display Units” on page 540](#)

[“Averaging” on page 541](#)

[“Single or Continuous Measure” on page 541](#)

[“Limits” on page 542](#)

The following Built-in Power Meter settings are identical to SA Mode settings:

[“Radio Standard” on page 530](#)

[“How to Access Individual Alignments” on page 215](#)

Built-in Power Meter Settings

Select Built-in Power Meter Mode before making any setting in this section.

How to select Built-in Power Meter Mode

- Press **Mode**
- Then **More**
- Then **Power Meter (Built-in)**

CAUTION

Please observe the SA RF Input port damage level.

+27 dBm (320 mW) average

+33 dBm peak (2 W) <10 μ s

+50 VDC

Frequency/ Span / Step

Valid Built-in Power Meter measurements can be made over the entire frequency range of the FieldFox. Although it is possible to enter a center frequency below the FieldFox minimum frequency, the LO feed-thru of the internal SA hardware will invalidate these Built-in Power Meter measurements.

The measurement span (also known as Channel Width and Integration BW) is the frequency range, half above and half below the center frequency, over which power is detected and displayed. The maximum measurement span is 100 MHz.

How to enter center frequency, step size, and span

The default frequency is 50 MHz.

- Press **Freq/Dist**
- Then **Center**
- Then type a value using the numeric keypad. Then press a multiplier key. Learn about multiplier abbreviations “**Multiplier Abbreviations**” on page 53. The current frequency (f) is shown on the FieldFox screen.
- Optionally, use the **▲▼** arrows or rotary knob to quickly change Center frequency. The size of the frequency step can also be changed. Press **CF Step** then type a step size value using the numeric keypad, then select a multiplier key.
- Optionally press **Span** Type a value using the numeric keypad. Then press a multiplier key. The default span is 20 MHz. The maximum span is 100 MHz. The current span setting is shown as the dividend in the digital display. For example: **-10 dBm / 1.00 MHz**

Radio Standard

A Radio Standard can be used to integrate power within specific radio channels. When a Radio Standard is selected, the **Span** setting is automatically coupled to the defined Channel Width for that standard. (Width is the same for all channels within a standard.) Also, **Unit** is set to **Chan**, and **CF** is set to the nearest specific Channel defined in the standard.

Learn more about Radio Standards, including Importing and Deleting Custom Radio Standards, beginning in [“Custom Radio Standards” on page 165](#)

How to select a Radio Standard

- Press **Measure 1** OR **Freq/Dist**
- Then **Radio Standard**
- Then select a standard using the **▲▼** arrows or rotary knob and press **Enter**.

Attenuation

The Attenuation setting controls the power level into the FieldFox.

To compare Built-in Power Meter Mode measurements to SA Channel Power measurements, use the same attenuation settings. Built-in Power Meter Mode defaults to 30 dB attenuation, while SA mode defaults to 10 dB attenuation. In Built-in Power Meter, the attenuation setting is NOT annotated on the screen.

How to set Attenuation

- Press **Scale/Amptd**
- Then **More**
- Then **RF Atten**
- Then use the **▲▼** arrows or rotary knob to choose from either **30 dB** or **10 dB**

NOTE

The following Built-in Power Meter settings are identical to the standard Power Meter settings. To learn about these settings, please refer to the following pages:

[“Scale” on page 539](#)

[“Relative and Offset Power Measurements” on page 540](#)

[“Display Units” on page 540](#)

[“Averaging” on page 541](#)

[“Scale” on page 539](#)

[“Limits” on page 542](#)

21 Power Meter (USB/LAN) Mode - Option 302

NOTE

LAN sensors require the FieldFox to have CPU2.

Power Meter measurements, available with Option 302, are made with Keysight USB power sensors. Power readings are displayed on the FieldFox screen.

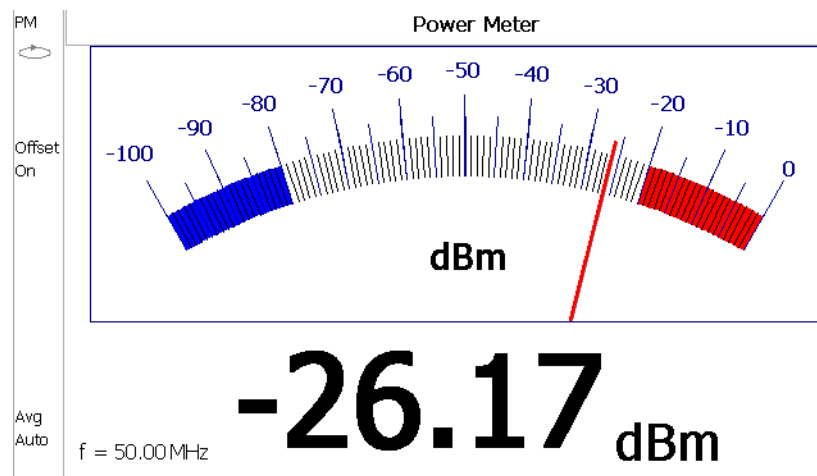

In this Chapter

- “Supported Power Sensors” on page 533
- “How to Connect a USB Power Sensor” on page 533
- “How to Connect a LAN Power Sensor” on page 534
- “Average / Peak ” on page 536
- “Zeroing” on page 537
- “Frequency” on page 537
- “Source Control” on page 538
- “Source Power Measurements” on page 539
- “Relative and Offset Power Measurements” on page 540

[“Display Units” on page 540](#)

[“Resolution” on page 541](#)

[“Averaging” on page 541](#)

[“Single or Continuous Measure” on page 541](#)

[“Step Detection Mode” on page 542](#)

[“Limits” on page 542](#)

See Also

[“FOPS Settings” on page 551](#)

[“All about Markers” on page 692](#)

[“All about Limit Lines” on page 707](#)

[“All about Trace Math” on page 712](#)

[“All about Scale Settings” on page 714](#)

Supported Power Sensors

For a complete list of supported Keysight USB and LAN Power Sensors, please visit: www.keysight.com/find/usbsensorsforfieldfox

NOTE

The FieldFox does NOT support the following Keysight USB and LAN Power Sensor features: External Triggering (Time Gated Burst Power Measurement), Power Sweep Operation, and Frequency Sweep Operation. External Zeroing is NOT allowed on the U2020 X-series Power Sensors.

CAUTION

Please refer to your USB and LAN Power Sensor User's Guide and observe the damage levels of your device.

How to Connect a USB Power Sensor

Connect your Power Sensor to one of the FieldFox USB ports.

NOTE

IMPORTANT! When a USB power sensor is initially connected to the FieldFox, it may take ~10 seconds for the USB power sensor to finish zeroing and for the FieldFox to recognize the USB power sensor. If your USB power sensor is not operating as expected:

- Verify the latest firmware is loaded on the FieldFox. Refer to www.keysight.com/find/fieldfoxsupport.
- Verify the latest firmware is loaded on the Power Sensor. Refer to <https://www.keysight.com/main/editorial>.
- Remove and re-connect the USB power sensor

NOTE

Use an attenuator between the DUT and the power sensor when measuring power levels that are higher than +20 dBm. The attenuator value can be subtracted from the measurement using the Offset feature, discussed in **“Relative and Offset Power Measurements” on page 540.**

A sequence of status lights are displayed on the base of the power sensor, when the FieldFox is in Power Meter (USB Sensor) mode.

- **Green blinking** light indicates the power sensor is communicating or self-tests are being performed. Because the FieldFox is usually communicating with the power sensor when it is connected, this is the normal mode of operation.
- **Amber light** indicates Zeroing is being performed.
- **Red light** indicates an error has occurred with the power sensor. Refer to power sensor documentation.

- **No light** indicates the FieldFox is not communicating with the power sensor. This is the case when in Hold mode or when NOT in Power Meter Mode.

How to Connect a LAN Power Sensor

CAUTION

Disconnecting a LAN sensor from its cable or disconnecting a LAN sensor while communicating with the FieldFox is not recommended. Either of these actions causes the LAN sensor to lose its internal state settings. Learn more, refer to [“LAN Sensor Settings” on page 534](#) and to [“Troubleshooting” on page 544](#).

NOTE

IMPORTANT!

LAN sensors require that the FieldFox has a CPU2 installed.

Connect the LAN power sensor to a LAN port. This section provides some general LAN power sensor connection information and some specific FieldFox-related LAN connection information. For more details, refer to your LAN power sensor’s User’s Guide.

Connect the LAN sensor via any of the following LAN operating modes:

- Dynamic IP (Dynamic Host Configuration Protocol or DHCP)
- Auto IP (Local PC control or isolated (non-site) LAN)
- Static IP (Manual mode)

The default LAN operating mode of the LAN sensor is Dynamic IP.

Dynamic IP and Auto IP are enabled on the LAN sensor shipped from Keysight. This allows the LAN sensor to automatically obtain an address on the network.

The LAN sensor communicates with the DHCP server to obtain the LAN interface configuration. If the DHCP server is not detected, then either the DHCP server is not present or it does not allow the LAN sensor to obtain an IP address. The LAN sensor will then try to obtain the LAN configuration using AutoIP if enabled, otherwise the LAN sensor will try to use the static IP set in the LAN sensor. If required, push the LAN reset switch to reset the LAN sensor LAN configuration to a known default state.

LAN Sensor Settings

The LAN Sensor settings enable you to

- Select your model of sensor
- Enter your **Sensor I.D.** via **DNS serial number** or **IP address**

Learn more, refer to [“USB and LAN Power Meter Settings” on page 536](#).

To access the LAN Sensor Settings:

- Press **Meas Setup 4** > **More** > **LAN Sensor Settings**

Using the LAN Sensor Settings

- Press **Sensor Name [U2049XA]** – then select your LAN sensor model from the drop down list.
- Press **Sensor ID** – then choose
 - **DNS Ser num** – Enter the DNS Serial Number's last 5 digits as a way for the FieldFox to connect with your LAN power sensor.
 - **IP Address** – Enter the IP address of your LAN power sensor as a way for the FieldFox to connect with your LAN power sensor.
- Press **DNS Ser Num** – to enter a DNS serial number's last 5 digits to enable the FieldFox to identify a LAN power sensor. This softkey is inactive Sensor I.D. is set to **IP Address**.
- Press **LAN IP Addr Not Specified** – to enter an IP address to enable the FieldFox to identify a LAN power sensor. This softkey is inactive Sensor I.D. is set to **DNS Ser Num**.
- Press **Reconnect** – While it is not recommended to remove the LAN cable from either the Sensor or the FieldFox during a LAN Sensor based measurement, the **Reconnect** button should allow the measurements to resume if they are lost. Learn more, refer to **"Troubleshooting" on page 544**.

NOTE

The LED indicator will turn red indicating the following error when the DHCP server is not detected: -310, "system error; The sensor could not obtain a LAN configuration using DHCP. The sensor will try to obtain IP address using AutoIP if enabled". For more information on LAN instrument connectivity, refer to the *Keysight IO Libraries Suite Connectivity Guide*.

NOTE

IMPORTANT! When a LAN power sensor is initially connected to the LAN, it may take ~10 seconds for the LAN power sensor to finish zeroing and for the FieldFox to recognize the LAN power sensor. If your LAN power sensor is not operating as expected:

- Verify the latest firmware is loaded on the FieldFox. Refer to www.keysight.com/find/fieldfoxsupport.
- Verify the latest firmware is loaded on the Power Sensor. Refer to <https://www.keysight.com/main/editorial>.
- Press the LAN reset switch to reset the LAN sensor LAN configuration to a known default state
- Remove and re-connect the LAN power sensor

NOTE

Use an attenuator between the DUT and the power sensor when measuring power levels that are higher than +20 dBm. The attenuator value can be subtracted from the measurement using the Offset feature, discussed in [“Relative and Offset Power Measurements” on page 540](#).

A sequence of status lights are displayed on the base of the power sensor, when the FieldFox is in Power Meter (LAN Sensor) mode.

- **Green / Green blinking** light indicates the power sensor’s identification indicator is communicating. After successful identification, the green LED stops blinking. No indication when the operating speed is 10 Mbps or during line isolation.
- **Amber light** indicates Zeroing is being performed. And, blinks when a valid link activity is detected.
- **Red light** indicates an error has occurred with the power sensor. Refer to power sensor documentation.
- **No light** indicates the FieldFox is not communicating with the power sensor. This is the case when in Hold mode or when NOT in Power Meter Mode.

USB and LAN Power Meter Settings

Select Power Meter Mode before making any setting in this section.

How to select Power Meter Mode

- Press **Mode**.
- Then **Power Meter (USB Sensor)**.

How to select a Sensor Type

- Press **Meas Setup 4**.
- Then **Sensor Type USB LAN** (Default = USB).

Average / Peak

- Press **Measure 1**
- Then choose from the following:
 - **Average** Measures and reports the average of the power measurements.

- **Peak** Available ONLY on the X-Series power sensors. Measures and reports peak power detected at sensor input. See also, **Table 23-1, “Pulse Measurement X-Series USB and LAN Power Sensors,” on page 559.**

Zeroing

The Keysight USB and LAN Power Sensors perform Internal Zeroing automatically. Because Keysight USB and LAN Power Sensors have an internal switch, Internal Zeroing does NOT require that the power source be turned OFF.

For highest measurement accuracy, when measuring power levels below -30 dBm, External Zeroing should be performed.

During External Zeroing, the power source MUST be turned OFF or the power sensor disconnected from the power source (device under test). Power is OFF when power sensor measurements are below -60 dBm (-50 dBm for LAN sensors). When power higher than this is detected at the sensor, a warning message is shown on the FieldFox and External Zeroing will not proceed.

NOTE

External Zeroing is NOT allowed on the U2020 X-series Power Sensors.

How to perform External Zeroing

- Press **Cal 5**.
- Then **External Zero**.

While either Internal or External Zeroing is being performed, “Zeroing...” is shown on the FieldFox screen. While this message is present, do NOT make any changes to the FieldFox.

In addition, once External Zeroing has started, the power source must be OFF for the entire time that the Zeroing message is present. Otherwise, the calibration will be compromised but NO warning is shown.

Frequency

A table of correction factors versus frequency is stored within Keysight Power Sensors. The frequency of the power to be measured is entered in the FieldFox so that the appropriate correction factor can be used.

The Source Control feature (see following section) will determine the frequency range of the power measurement.

How to enter Frequency of the Power Measurement

- Press **Freq/Dist** or **Meas Setup 4**.
- Then **Frequency**.

- Then type a value using the numeric keypad. The default frequency is 50 MHz.
- Then press a multiplier key. Learn about multiplier abbreviations in [“Multiplier Abbreviations” on page 53](#).

The current frequency is shown on the FieldFox screen.

Source Control

This feature may require an option on some FieldFox models.

With the FieldFox internal source enabled, these settings allow you to make simple, absolute power measurements. The source and the power sensor can be physically separated by a long distance when using a long USB cable.

Set the internal source frequency by setting the frequency of the power measurement. Learn how in the previous section.

Power Meter measurements are limited by the combined frequency ranges of the internal source when enabled and the frequency range of the power sensor. For example, assume the frequency range of your sensor is 9 kHz to 18 GHz and the frequency range of the FieldFox is 2 MHz to 6 GHz.

- With the Source ON, measurements are limited to 2 MHz to 6 GHz.
- With the Source OFF, measurements are allowed from 9 kHz to 18 GHz.

How to Set Source Control and Power Level

- Press **Freq/Dist**
- Then **Advanced**

NOTE

When Option 208 (FOPS) is enabled, to access Source Control, press Sweep 3, then **Power Setup**. Learn more about FOPS beginning on page [Chapter 22, “Frequency Offset Using Power Sensor \(FOPS\) – Option 208”, on page 547](#).

- Then **Source Enable**
 - **ON** Turn ON the internal source
 - **OFF** Turn OFF the internal source

Optionally set the power level.

- Press **Src Nom Power** (-15 dBm default setting) Set output power to an arbitrary value at the displayed CW frequency.
- Then enter a value using the numeric keypad, the **▲▼** arrows, or the rotary knob.
- Press **Enter**

Scale

The scale of the Power Meter display can be set manually or automatically. The major and minor ticks are set automatically and can NOT be changed. Although the scale settings are limited, you can view measurements beyond these settings by performing Autoscale.

How to Scale the Power Meter Display

These softkeys are **not** available when **Rx Power** is enabled. See also “**Source Power Measurements**” on page 539.

Manually:

- Press **Scale / Amptd**.
- Then choose from the following:
 - **Scale Min** Sets the low power level of the power meter display. Type a number and select the units or press Enter. This value is limited to -100 dBm.
 - **Scale Max** Sets the high power level of the power meter display. Type a number and select the units or press Enter. This value is limited to 100 dBm.

Autoscale:

Using Autoscale, the current reading is used for the center of the scale, and Min and Max values are set accordingly.

- Press **Scale / Amptd**.
- Then **More**.
- Then **Autoscale**.

Source Power Measurements

Before making a source power measurement, a calibration is required. Requires a compatible USB power sensor. Learn more about supported Keysight USB and LAN Power Sensors, please visit:

www.keysight.com/find/usbsensorsforfieldfox.

How to make a Source Power Measurement

- Press **Measure 1** > **Src Power Measure** to open the Source Power Measure wizard.
- Follow the Source Power Measure Wizard’s instructions.

When you select the **Src Power Measure** softkey the **Rx Power** is enabled and the **Average** (default) is disabled. And, the displayed power meter is replaced by a Power vs. Frequency grid display of the source and receiver power.

- Press **Src Power Memory** - to store the source power measurement
- Press **Gain** - applies the stored source power measure

Relative and Offset Power Measurements

Power measurements can be made that are relative to another reading or that are offset by a fixed value.

- Use Relative to measure the difference between power levels.
- Use Offset to account for components or a long length of cable that is used before the power sensor. For example, if using a 10 dB attenuator to protect the FieldFox, enter an Offset Value of 10 to read the power as it would appear without attenuation. If using a 10 dB amplifier, enter an Offset Value of -10 to read the power as it would appear without amplification.

How to set Relative and Offset Power Measurements

- Press **Scale / Amptd**.
- Then choose from the following:
 - **Relative Off On** When switched to ON, the FieldFox measures and stores the current power level. Subsequent power measurements display a power level which is relative to the stored value. When relative is ON, the units change from dBm to dB or from Watts to %.

This softkey is **not** available when **Rx Power** is enabled. See also **“Source Power Measurements” on page 539**.
 - **Offset Off On** Toggles ON and OFF the displayed power level using the Offset value.

This softkey is **not** available when **Rx Power** is enabled. See also **“Source Power Measurements” on page 539**.
 - **Offset Val** Value by which the power meter display is offset. A positive value compensates for a component with loss. A negative value compensates for a component with gain. Offset values are limited to +/- 100 dB.

Display Units

Select whether to display power in dBm or Watts. When making relative power measurements, these change to dB and %.

This softkey is **not** available when **Rx Power** is enabled. See also **“Source Power Measurements” on page 539**.

How to set Power Meter display units

- Press **Meas Setup 4** or **Scale / Amptd**, **More**
- Then **Unit**.

- Then choose from the following:
 - **dBm (dB)** Sets Power Meter display to dBm or dB.
 - **Watt (%)** Sets Power Meter display to Watts or %.

Resolution

Resolution sets the number of digits to display after the decimal point on the digital power meter display.

This softkey is **not** available when **Rx Power** is enabled. See also “**Source Power Measurements**” on page 539.

How to set Resolution

- Press **Scale / Amptd.**
- Then **More.**
- Then, in **Resolution**, choose from 0, 1, 2, or 3.

Averaging

Averaging is used to improve measurement accuracy in low power or noisy power situations. Increased averaging improves measurement accuracy, but also reduces measurement speed.

How to set Power Meter Averaging

- Press **BW 2** or **Meas Setup 4.**
- Then choose from the following:
 - **Averaging Auto Man Off**
 - **Auto** Allows the USB Power Sensor to use its Auto Averaging settings. See the USB Power Sensor documentation for details.
 - **Man** Manually enter an averaging count by setting **Num Averages.**
 - **OFF** Performs NO averaging.
 - **Num Averages** Sets the number of Power Meter readings to be averaged before a valid reading is displayed. When the number is changed, **Averaging** is automatically set to Man.

Single or Continuous Measure

This setting determines whether the FieldFox measures continuously or only once each time the **Single** button is pressed. Use **Single** to conserve battery power or to allow you to save or analyze a specific measurement.

This setting can be changed at any time without affecting calibration accuracy.

How to set Single or Continuous

- Press **Sweep 3**.
- Then choose one of the following:
 - **Single** Automatically sets Continuous OFF and causes FieldFox to make ONE measurement, then hold for the next **Single** key press. When a data trace is displayed, the entire trace is measured, then holds. The **Hold** annotation changes to an arrow --> while the measurement occurs.
 - **Continuous OFF ON** Makes continuous measurements. This is the typical setting when battery power is not critical.

You can also use **Run / Hold +/-** to toggle between Single and Continuous.

Step Detection Mode

The FieldFox supports the Step Detection feature that is present in Keysight USB power sensors. When enabled, this feature reduces settling time after a significant step in the measured power. For more information, please refer to the USB Power Meter documentation.

How to set Step Detection mode

- Press **Meas Setup 4**.
- Then **Step Detection OFF ON**
- Then choose from the following:
 - **ON** Enables step detection (default setting)
 - **OFF** Disables step detection

Limits

In Power Meter Mode, Minimum and Maximum limits set a visible range of acceptable readings between these two values. Readings that are below the minimum or above the maximum are clearly visible on the power meter display.

How to set Limits

- Press **Limit 8**.
- Then choose from the following:
 - **Min Limit OFF ON** Toggles the display of the Minimum limit ON and OFF.
 - **Min Limit Value** Sets the Minimum limit power value. Power reading lower than this will exceed the limit.

Power Meter (USB/LAN) Mode - Option 302
USB and LAN Power Meter Settings

- **Max Limit OFF ON** Toggles the display of the Maximum limit ON and OFF.
- **Max Limit Value** Sets the Maximum limit power value. Power reading higher than this will exceed the limit.

Troubleshooting

This section contains the following:

LAN Sensors

- “If the FieldFox LAN is removed during the use of the LAN sensor, the following steps can be taken to re-establish control of the Sensor:” on page 544
- “If the Sensor LAN is removed during the use of the LAN sensor, the following steps can be taken to re-establish control over the measurement:” on page 544

LAN Sensors

If a LAN sensor cable or LAN sensor is not communicating properly with the FieldFox:

If the FieldFox LAN is removed during the use of the LAN sensor, the following steps can be taken to re-establish control of the Sensor:

1. Reconnect the LAN sensor to the FieldFox and await confirmation the FieldFox has obtained its IP address via the connection.

A self-assigned IP address may be shown briefly while FieldFox tries to get connected to the LAN again after it has been removed. Before proceeding to the next step, ensure the correct IP has been obtained by the FieldFox.

- a. You can view the IP address by selecting:
System > **System Configuration** > **More** > **LAN** to display the current IP address.
 - b. Press **Done** to exit the LAN menu.
2. Once FieldFox has obtained its IP address again, press the **Reconnect** button:
Press **Meas Setup 4** > **More** > **LAN Sensor Settings** > **Reconnect** location in the softkey menu.

The FieldFox will attempt to restore the connection and the settings for the sensor.

If the Sensor LAN is removed during the use of the LAN sensor, the following steps can be taken to re-establish control over the measurement:

1. Reconnect the LAN cable to the sensor.
2. Observe the LEDs near the LAN cable connection:
 - a. The PWR LED will turn on while the Sensor is waking up and initializing.

- b. The PWR LED will turn off when the Sensor is ready to be reconnected. The other LED next to it should be off as well.
- c. Then press, **Meas Setup 4** > **More** > **LAN Sensor Settings** > **Reconnect**.

NOTE

The LEDs may turn on and off during the reconnection, and the sensor may report “Zeroing” or “Attempting to connect” messages. This reconnection attempt could take up to a minute or so. The data acquisition will resume once the connection is re-established.

Power Meter (USB/LAN) Mode - Option 302
Troubleshooting

22 Frequency Offset Using Power Sensor (FOPS) – Option 208

FOPS is accessed through (and requires) Option 302 USB Power Meter Mode. With both options installed, you can send a signal with the FieldFox internal source at one frequency, and measure this signal with a Keysight U-Series USB Power Sensor at another frequency.

Figure 22-1 Display for FOPS

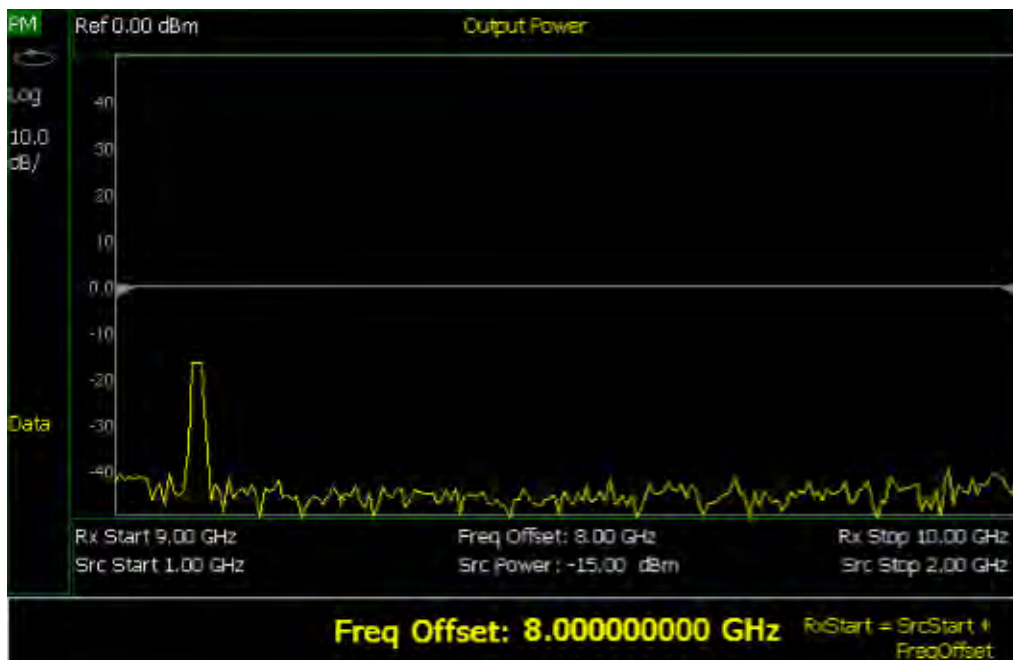

In this Chapter

[“How to select Power Meter \(USB Sensor\)” on page 551](#)

[“Measurement Selection” on page 551](#)

[“Sweep Type and Frequency” on page 552](#)

[“Power Sensor Settling” on page 554](#)

[“Sweep Settings” on page 554](#)

[“Amplitude Markers” on page 555](#)

[“Trace Math” on page 555](#)

See Also

[“All about Scale Settings” on page 714](#)

Overview

This feature allows the FieldFox source frequency to be set independently from the power sensor (receiver) frequency. With frequency offset using power sensor (FOPS), the frequency of both the source and receiver are swept, and the two track each other. The offset frequency can be negative, zero, or positive.

FOPS can be used to characterize the scalar transmission response of devices such as mixers and converters. This frequency offset capability is necessary for conversion loss/gain measurements on frequency-translating devices since, by definition, the input and output frequencies of the DUT are different. The FieldFox source stimulates the DUT and the power sensor is used as the measurement receiver.

Since power sensors are inherently broadband devices (not frequency-selective), it is your responsibility to ensure that ONLY the signal of interest is present at the power sensor input and that all other signals are filtered appropriately.

For some DUTs, the output frequency may sweep in a reverse direction, as compared to the source frequency. The FieldFox analyzer includes an offset calculator that ensures a fast measurement setup.

The following shows a typical use case for FOPS:

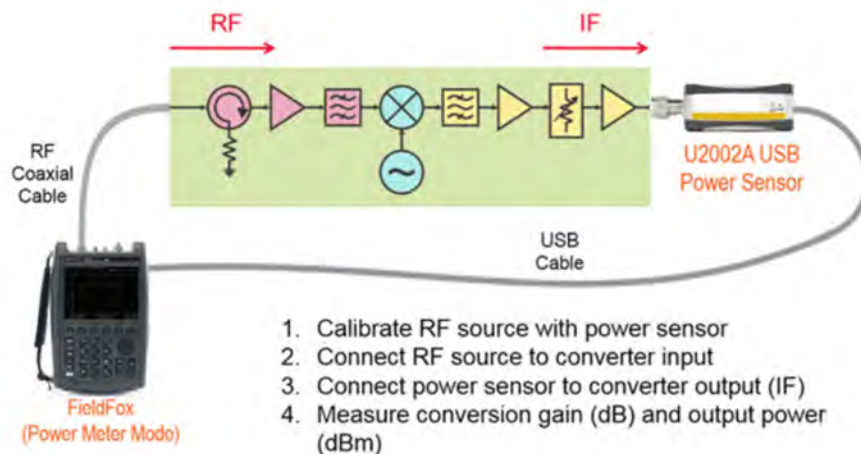

- The DUT is a long section of cable and a frequency converter.
- The FieldFox source is tuned to the RF frequency.
- The USB power sensor, with an equally long USB/LAN cable, is connected to the IF Output. USB/LAN extenders are NOT provided with the FieldFox or Keysight USB power sensors.
- Conversion gain/loss is measured at power sensor.

NOTE

The dynamic range with FOPS may be significantly different when using various power sensors. In general, the lower frequency range sensors have better dynamic range.

FOPS Settings

The following settings are unique to FOPS. Standard USB Power Meter mode settings, which may be useful with FOPS, are documented in that chapter starting in “**USB and LAN Power Meter Settings**” on page 536

Select Power Meter (USB Sensor) before making any setting in this section.

How to select Power Meter (USB Sensor)

- Press **Mode**
- Then **Power Meter (USB Sensor)**
- Then connect a USB Power Sensor to either FieldFox USB port.
- For a complete list of supported Keysight USB Power Sensors, please visit: www.keysight.com/find/usbsensorsforfieldfox

Measurement Selection

- Press **Measure 1**
- Then choose from the following:
 - **Src Power Measure** Similar to a ‘normalization’ cal, this selection guides you through the following steps to make a measurement at the reference plane and then store the data trace into memory.
 - Connect the power sensor to the measurement reference plane. This is the location to where power measurements are to be referenced. For example, to measure only the conversion loss through a converter, attach the power sensor to the cable that connects to the converter input.
 - Press **Measure**. When finished, press **Src Data -> Mem** to store the measured data into FieldFox memory. Preset or Mode Preset will clear the stored memory.
 - 3. Optionally choose from the following:
 - **Re-Measure** Make another measurement
 - **Src Data** View only the re-measured data.
 - **Src Memory** View only the stored memory data.
 - **Src Data & Memory** View both the re-measured data and the stored memory data.
 - 4. Press **Done**
 - **Src Power Memory** Not available until source data is stored into memory. Displays only the source power memory trace.

- **Gain** Not available until source data is stored into memory. Displays the Output power / Source power (memory trace).
- **Rx Power** Displays the raw received power at the USB power sensor.

Sweep Type and Frequency

Set the source and receiver frequencies for the FOPS measurements. The receiver is a Keysight U-Series Power Sensor. These are broadband measurement devices, which means that they measure power over a very wide frequency range. Tables of frequency and power correction factors are stored within the power sensors. The receiver (Rx) frequencies are used ONLY to apply the appropriate correction factors to the power levels measured with the power sensor.

NOTE

It is YOUR responsibility to ensure that ONLY the signal of interest is present at the power sensor. All other signals MUST be filtered appropriately.

How to set Sweep Type and Frequency

- Press **Freq/Dist**
- Then **Sweep Type**
- Then choose from the following:
 - **CW** Used to make standard (non-offset) power meter measurements at a single frequency. Learn more in “**Power Meter (USB/LAN) Mode - Option 302**” on page 531.

NOTE

To make FOPS measurements at a single frequency, choose Swept, then enter a Src Center frequency, then Span = 0 Hz.

- **Swept** Used to make swept FOPS measurements.
 - Then enter source (Src) frequencies as either Center and Span or Start and Stop. Both methods set the FieldFox internal source sweep range out the Port 1 RF Output connector.
 - The frequency limits are determined by the limits of both the FieldFox and the power sensor.
 - The LOW frequency is limited by the higher of either the FieldFox or the power sensor minimum frequencies.
 - The HIGH frequency is limited by the lower of either the FieldFox or the power sensor maximum frequencies.
 - Then **More**.

- Then **Freq Display**. This determines how the receiver frequencies below the gratitudes are displayed. Choose from the following:
 - Start** Annotated as Start and Stop frequencies.
 - Center** Annotated as Center and Span frequencies.
- Then choose from the following two methods to determine the **offset frequency** (the frequency that the receiver is offset from the source). This is typically the frequency of the LO that is used with the frequency converter. The frequency offset may be positive, negative, or zero.
- Freq Offset** Enter an Offset frequency. The receiver frequencies are calculated.
- Offset Calculator** Enter the Receiver Start and Stop frequencies. Then press **Calculate Offset**.
- Press **Rx Sweep** to select the receiver sweep direction.
 - Fwd** Used for systems for which the output frequency is $\text{Offs} + \text{Src}$. The output frequency of the DUT and the receiver sweeps in the same direction as the source.
 - Rev** Used for systems for which the output frequency is $\text{Offs} - \text{Src}$. The output frequency of the DUT and the receiver sweeps in reverse direction as compared to the source.

Invalid Settings

Violations of the following conditions will return an error message:

- The frequency span for the source and receiver must be the same.
- Both the source and receiver frequencies must be positive.

FOPS Configuration Examples

Negative Offset, RxSwp = **Fwd** ($\text{Offs} + \text{Src}$)

Src = 2 GHz to 3 GHz

Offset = -1 GHz

Rx = 1 GHz to 2 GHz

Positive Offset, RxSwp = **Rev** ($\text{Offs} - \text{Src}$)

Src = 2 GHz to 3 GHz

Offset = 3.8 GHz

Rx = 1.800 GHz to 800 MHz

Positive Offset, RxSwp = **Fwd** ($\text{Offs} + \text{Src}$)

Src = 2 GHz to 3 GHz

Offset = 3.8 GHz

Rx = 5.8 GHz to 6.8 GHz

Power Sensor Settling

The following two settings work together to allow you to choose the right compromise between measurement speed and accuracy.

Each power sensor reading is considered “settled” when either:

- The difference between two consecutive readings are within the Tolerance value.
- **Or** the Max (number of) Readings has been made.

The readings that were taken are averaged together to become the displayed reading.

How to choose Power Sensor settling

- Press **BW 2**
- Then **Tolerance**. Enter a value in dB between 0 and 10 using the numeric keypad, the **▲▼** arrows, or the rotary knob. Tolerance of 0 will never be achieved, so the Max Readings will always be made. Press **Enter**
- Then **Max Readings**. Enter a value between 1 and 20 using the numeric keypad, the **▲▼** arrows, or the rotary knob. Press **Enter**

Sweep Settings

These settings provide added control of the FOPS measurement.

How to make additional sweep settings

- Press **Sweep 3**
- Then choose from the following:
 - **Power Setup**
 - **Source Enable**
 - **ON** Turn ON the internal source (required for FOPS).
 - **OFF** Turn OFF the internal source
 - **Src Nom Power** (-15 dBm default setting) Set output power to an arbitrary value at the source CW frequency. Then enter a value using the numeric keypad, the **▲▼** arrows, or the rotary knob. Press **Enter**

- **Num Points** or **Freq Step Size** Both settings control the number of power sensor measurements between the Start and Stop frequencies. Enter one setting and the other will be changed automatically. There must be at least two data points.
- **Dwell /Point** Specifies a settling time (in seconds) after the internal source steps to the next frequency and before the power sensor makes a measurement.

Amplitude Markers

Amplitude markers are horizontal dotted lines that you can move to any amplitude level on the screen. The two amplitude markers can be set independently or used as a pair of delta markers. Amplitude markers can be used as a visual comparison aid with the data trace.

How to make Amplitude Marker settings

- Press **Marker**
- Then **More**
- Then **Ampl Markers**
- Then choose from the following:
 - **OFF** Amplitude markers are NOT displayed.
 - **ON** Amplitude markers ARE displayed at their previous positions.
- Then **Ampl Mkr 1 or 2**
- Enter a value in dBm for the marker using the numeric keypad, the **▲▼** arrows, or the rotary knob.
- Press **Delta Ampl Mkr**
- Then choose from the following:
 - **ON** AmplitudeMkr 2 value is relative to AmplitudeMkr 1. When AmplitudeMkr 1 is moved, AmplitudeMkr 2 also moves to maintain the AmplitudeMkr 2 value between them.
 - **OFF** The two amplitude markers move independent of one another.

Trace Math

Trace Math allows you to compare data traces and perform simple math. Learn how to use Trace Math in **“All about Markers” on page 692**. All Data and Memory features work as documented EXCEPT for the following:

NOTE

When Trace, then Data -> Mem is pressed, if a Src Power trace is active, then RxPower is actually stored into memory.

To Compare Src Power (Input) and Rx Power (Output):

1. Meas Rx Power
2. Store to memory

- 3. View Data & Memory**
- 4. Meas Src Power.**

23 Pulse Measurements Mode – Option 330

Pulsed power meter measurements, available with Option 330, are made with Keysight X-Series USB and LAN Peak Power Sensors. These sensors are capable of detecting, measuring, and storing data from a train of pulses at the RF input. This data is queried from the USB and LAN Power Sensor and displayed on the FieldFox screen. You can then analyze the data using several selectable settings.

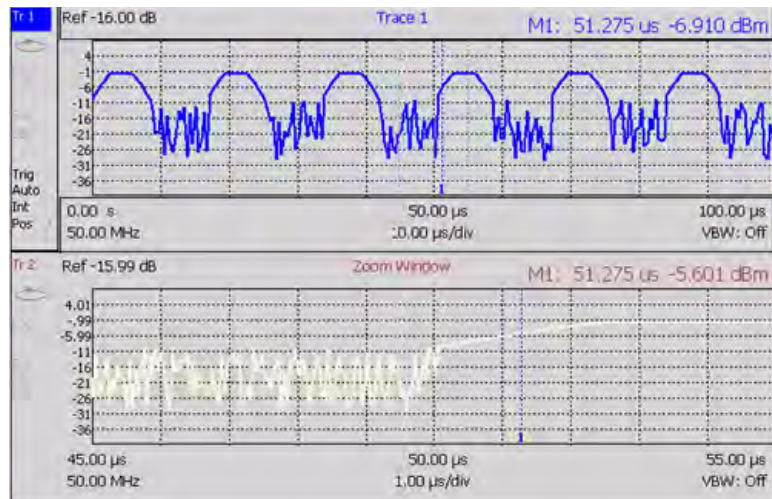

In this Chapter

[“Supported Power Sensors” on page 559](#)

[“Measurement Selection” on page 563](#)

[“Frequency / Time” on page 563](#)

[“Zoom Window” on page 564](#)

[“Scale” on page 565](#)

[“Averaging ” on page 565](#)

[“Video Bandwidth” on page 566](#)

[“Single or Continuous Measure” on page 566](#)

[“Resolution” on page 567](#)

“Triggering” on page 567

“Marker Settings” on page 570

“Amplitude Markers” on page 571

“How to Search with Markers” on page 571

“How to enable Auto Analysis” on page 573

“Pulse Top” on page 573

“Grid” on page 573

“Trace Memory” on page 574

See Also

“FOPS Settings” on page 551

“All about Markers” on page 692

“All about Limit Lines” on page 707

“All about Trace Math” on page 712

“All about Scale Settings” on
page 714

NOTE

Many of the features included with the FieldFox Pulse Measurements Mode are discussed in detail in the following documents:

USB Power Sensors^a

- Keysight U2020 X-Series USB Peak Power Sensors User’s Guide (U2021-90002).
<https://www.keysight.com/us/en/assets/9018-02579/user-manuals/9018-02579.pdf>
- Keysight U2020 X-Series USB Peak Power Sensors Programmer’s Guide (U2021-90003).
<https://www.keysight.com/us/en/assets/9018-06011/programming-guides/9018-06011.pdf>

LAN Power Sensors^a

- Keysight U2050/60 X-Series USB Peak Power Sensors User’s Guide (U2063-90002).
<https://www.keysight.com/us/en/assets/9018-04734/user-manuals/9018-04734.pdf>
- Keysight U2050/60 X-Series USB Peak Power Sensors Programmer’s Guide (U2063-90003).
<https://www.keysight.com/us/en/assets/9018-04755/programming-guides/9018-04755.pdf>

USB and LAN Power Sensors^a

– “Best Practices For Making The Most Accurate Radar Pulse Measurements”
<https://www.keysight.com/us/en/assets/7018-03483/application-notes/5991-0434.pdf>

a. Learn more, refer to the User’s Guide and Programming Guide for your USB or LAN model power sensor.

Supported Power Sensors

Pulse measurements are made using any of the Keysight X-Series USB and LAN Peak Power Sensors.

Table 23-1 Pulse Measurement X-Series USB and LAN Power Sensors

USB Power Sensor Model Numbers	LAN Power Sensor Model Numbers ^a
U2021XA	L2061XA
U2022XA	L2062XA
U2042XA	U2063XA
U2044XA	L2064XA
U2049XA	L2065XA
U2062XA	L2065XT
U2063XA	
U2065XA	

a. LAN power sensors require FieldFoxes to have CPU2 installed.

Zeroing of the U2020 X-Series USB Peak Power Sensors is performed automatically at power up, every 5 seconds, and prior to measuring low level signals.

Switching between Pulse Measurement Mode and Power Meter Mode

NOT Supported - Using a single USB or LAN Peak Power Sensor and switching between Power Meter Mode and Pulse Measurement Mode. Both modes will attempt to program the sensor, which could cause one or both modes to hang, or at least report inaccurate data.

Supported - Using one X-Series Average Power Sensor connected to the top USB port for Power Meter Mode, and X-Series Peak Power Sensor connected to the bottom USB port for Pulse Measurement Mode.

How to Connect the USB Power Sensor

Connect your Power Sensor to one of the FieldFox USB ports.

NOTE

Use an attenuator between the DUT and the power sensor when measuring power levels that are higher than +20 dBm. The attenuator value can be subtracted from the measurement using the Offset feature, discussed in [“Relative and Offset Power Measurements” on page 540](#).

A sequence of status lights are displayed on the base of the power sensor.

- **Green blinking** light indicates the power sensor is communicating or self-tests are being performed. Because the FieldFox is usually communicating with the power sensor when it is connected, this is the normal mode of operation.
- **Amber light** indicates Zeroing is being performed.
- **Red light** indicates an error has occurred with the power sensor. Refer to power sensor documentation.
- **No light** indicates the FieldFox is not communicating with the power sensor. This is the case when in Hold mode or when NOT in Pulsed Measurement Mode.

How to Connect the LAN Power Sensor

Connect the LAN power sensor to a LAN port. This section provides some general LAN power sensor connection information and some specific FieldFox-related LAN connection information. For more details, refer to your LAN power sensor’s User’s Guide.

Connect the LAN sensor via any of the following LAN operating modes:

- Dynamic IP (Dynamic Host Configuration Protocol or DHCP)
- Auto IP (Local PC control or isolated (non-site) LAN)
- Static IP (Manual mode)

The default LAN operating mode of the LAN sensor is Dynamic IP.

Dynamic IP and Auto IP are enabled on the LAN sensor shipped from Keysight. This allows the LAN sensor to automatically obtain an address on the network.

The LAN sensor communicates with the DHCP server to obtain the LAN interface configuration. If the DHCP server is not detected, then either the DHCP server is not present or it does not allow the LAN sensor to obtain an IP address. The LAN sensor will then try to obtain the LAN configuration using AutoIP if enabled, otherwise the LAN sensor will try to use the static IP set in the LAN sensor. If required, push the LAN reset switch to reset the LAN sensor LAN configuration to a known default state.

LAN Sensor Settings

The LAN Sensor settings enable you to

- Select your model of sensor
- Enter your **Sensor I.D.** via **DNS serial number** or **IP address**

Learn more, refer to **“Power Meter (USB/LAN) Mode - Option 302”** on **page 531**.

To access the LAN Sensor Settings:

- Press **Meas Setup 4** > **More** > **LAN Sensor Settings**

Using the LAN Sensor Settings

- Press **Sensor Name [U2049XA]** – then select your LAN sensor model from the drop down list.
- Press **Sensor ID** – then choose
 - **DNS Ser num** – Enter the DNS Serial Number’s last 5 digits as a way for the FieldFox to connect with your LAN power sensor.
 - **IP Address** – Enter the IP address of your LAN power sensor as a way for the FieldFox to connect with your LAN power sensor.
- Press **DNS Ser Num** – to enter a DNS serial number’s last 5 digits to enable the FieldFox to identify a LAN power sensor. This softkey is inactive Sensor I.D. is set to **IP Address**.
- Press **LAN IP Adtrs Not Specified** – to enter an IP address to enable the FieldFox to identify a LAN power sensor. This softkey is inactive Sensor I.D. is set to **DNS Ser Num**.

NOTE

The LED indicator will turn red indicating the following error when the DHCP server is not detected: `-310, "System error; The sensor could not obtain a LAN configuration using DHCP. The sensor will try to obtain IP address using AutoIP if enabled"`. For more information on LAN instrument connectivity, refer to the *Keysight IO Libraries Suite Connectivity Guide*.

NOTE

IMPORTANT! When a LAN power sensor is initially connected to the LAN, it may take ~10 seconds for the LAN power sensor to finish zeroing and for the FieldFox to recognize the LAN power sensor. If your LAN power sensor is not operating as expected:

- Verify the latest firmware is loaded on the FieldFox. Refer to www.keysight.com/find/fieldfoxsupport.
 - Verify the latest firmware is loaded on the Power Sensor. Refer to <https://www.keysight.com/main/editorial>.
 - Press the LAN reset switch to reset the LAN sensor LAN configuration to a known default state
 - Remove and re-connect the LAN power sensor
-

NOTE

Use an attenuator between the DUT and the power sensor when measuring power levels that are higher than +20 dBm. The attenuator value can be subtracted from the measurement using the Offset feature, discussed in [“Relative and Offset Power Measurements” on page 540](#).

A sequence of status lights are displayed on the base of the power sensor, when the FieldFox is in Power Meter (LAN Sensor) mode.

- **Green / Green blinking** light indicates the power sensor’s identification indicator is communicating. After successful identification, the green LED stops blinking. No indication when the operating speed is 10 Mbps or during line isolation.
- **Amber light** indicates Zeroing is being performed. And, blinks when a valid link activity is detected.
- **Red light** indicates an error has occurred with the power sensor. Refer to power sensor documentation.
- **No light** indicates the FieldFox is not communicating with the power sensor. This is the case when in Hold mode or when NOT in Power Meter Mode.

Pulse Measurement Settings

Select Pulse Measurement Mode before making any setting in this section.

How to select Pulse Measurement Mode

- Press **Mode**
- Then **More** if your FieldFox contains more than five measurement modes.
- Then **Pulse Measurements**

Measurement Selection

The pulse measurement results are presented as either a traditional power meter display or as a trace graph.

How to select the Measurement

- Press **Measure 1**
- Then choose from the following:
 - **Average** Average power (Meter display)
 - **Peak** Peak power (Meter display)
 - **Pk to Avg** Displays the difference between the above two measurements (Meter display)
 - **Trace Graph** (default) The primary trace (Tr 1) plots pulse data in amplitude versus time. Optionally, you can enable a secondary ‘zoom’ trace. Learn how in [“Zoom Window” on page 564](#).
 - When a ‘Meter display’ measurement is selected, the following Pulse Measurement Mode settings are identical to the standard USB Power Meter Mode settings.
 - Learn how to set Scale in [“Scale” on page 565](#).
 - Learn how to set **Relative and Offset Power** in [“Relative and Offset Power Measurements” on page 540](#).
 - Learn how to set **Display Units** in [“Display Units” on page 540](#).
 - Learn how to set **Limits** in [“Limits” on page 542](#).

Frequency / Time

How to set Frequency

- Press **Freq/Dist**
- Then choose from the following:

- **Frequency** Sets the center frequency of the carrier on which pulse modulation resides. This is used to set amplitude correction of the USB Power Sensor.

How to set Time

Specify the time over which data will be acquired by the USB Power Sensor. When Trace Graph is selected, **Tr 1** is annotated with these values. Time can be specified using either of the following pairs of values:

- **Center 1** and **Time/div 1** Specify the center time and time per division.
- **Start Time** and **Time Length** Specify the start time and length of acquisition.
- A positive start time indicates a delay after the sensor detects a pulse signal.
- A negative start time displays data that is acquired BEFORE the sensor detects a pulse signal (or T-zero).
- Follow each by entering a value using the numeric keypad, the **▲▼** arrows, or the rotary knob.
- After using the keypad, select a multiplier key. Learn about multiplier abbreviations.

Zoom Window

When Trace Graph is selected as the measurement, a secondary Zoom Trace can be used to view a zoomed portion of **Tr 1**. When Zoom Window is ON, blue vertical posts appear on **Tr 1** to indicate the current start, center, and stop times of the zoom window. The zoom window can be scaled using the standard Scale settings.

How to make Zoom Window settings

- Press **Measure**
- Then **Trace Graph**
- Press **Trace 6** or **Freq/Dist** > **More**
- Then **Zoom Window OFF ON**
- Then choose from the following:
 - **ON** Opens the zoom window on the bottom half of the FieldFox screen. The window includes the zoomed trace.
 - **OFF** Closes the zoom window.
- **Zoom Center** While monitoring the T within the blue vertical posts on **Tr 1**, enter a value for the center time using the numeric keypad, the **▲▼** arrows, or the rotary knob.

- **Zoom Time/div** While monitoring the blue vertical posts on the primary trace, enter a value for the zoom window span using the numeric keypad, the \leftarrow / \rightarrow arrows, or the rotary knob.
- **Trace 1** (Only available under the **Trace 6** hardkey.) Press to select **Tr 1**. This can also be done by using the \uparrow / \downarrow arrows. Select a trace before making trace settings, such as Scale.
- **Zoom Trace** (Only available under the **Trace 6** hardkey.) Press to select the zoom trace.

Scale

For Meter-style measurements, learn how to set Scale, Relative and Offset Power, display Units, and Resolution beginning in **“Scale” on page 565**.

How to set Scale for Trace Graph measurements

- Select a trace to scale using the \uparrow / \downarrow arrows.
- Press **Scale / Amptd**
- Then choose from the following methods:
 - **Autoscale** Automatically adjusts the Y-axis to comfortably fit the Minimum and Maximum amplitude of the trace on the screen.
 - Set Scale, acquisition, and Reference Position:
 - **Scale** Manually enter a **scale per division** to view specific areas of the trace.
 - **Ref Level** Manually set the value of the reference line. Enter a negative value by pressing **Run/Hold (+/-)** either before or after typing a value.
 - **Ref Pos** Manually set the position of the reference line. Values must be between 0 (TOP line) and 10 (BOTTOM line).
 - **Offset ON** Enable Offset. When only trace 1 is visible, **Offset ON** appears to the left of the trace.
 - **Offset Val** Enter a value by which all amplitude values will be offset. This can have the effect of virtually removing a component from the measurement path. A positive value compensates for a component with loss. A negative value compensates for a component with gain. Offset values are limited to +/- 100 dB.

Averaging

Averaging helps to reduce the effects of random noise on a measurement. The more measurements that are averaged, the greater the amount of noise reduction. Averaging is allowed for all pulse measurements.

Averaging is performed in the USB and LAN Power Sensors before the data is sent to the FieldFox.

Annotation in the left pane shows the state of the Average setting. When Manual is selected, the 'Num of Averages' setting is also shown.

How to set Averaging

- Press **BW 2**.
- Then **Averaging**
- Then choose from the following:
 - **Auto** Averaging is set to a reasonable value by the USB Power Sensor.
 - **Man** Averaging is set to the value specified in the 'Num Averages' setting.
 - **Off** Averaging is OFF
- **Num Averages** Select a value using the numeric keypad, then press **Enter**.

Video Bandwidth

The Video Bandwidth setting enables an FIR (finite impulse response) filter within the USB Power Sensor. The filter setting affects the appearance of the trace results.

Video Bandwidth is allowed for all pulse measurements

How to set Video Bandwidth

- Press **BW 2**.
- Then **Video Bandwidth**
- Then choose from the following:
 - **Off** Video Bandwidth is disabled.
 - **Low** Similar to a low pass filter, ripple in the pass band is minimized but allows higher side-lobes on the filter skirt.
 - **Medium** Smooth pass band with reasonable transition ripple.
 - **High** The pass band ripple is similar to the OFF setting, but the transition skirts are smoother.

Single or Continuous Measure

This setting determines whether the FieldFox continuously queries the USB Power Sensor for data, or only once each time the **Single** button is pressed. Use **Single** to conserve battery power or to allow you to save or analyze specific data.

How to set Single or Continuous

- Press **Sweep 3**
- Then choose one of the following:
 - **Single** Automatically sets Continuous OFF and causes the FieldFox to query the USB Power Sensor ONCE, then hold for the next Single key press. Hold is annotated in the upper left corner of the display.
 - **Continuous OFF ON** Queries the USB Power Sensor whenever a valid trigger signal is present. This is the typical setting when battery power is not critical.

You can also use **Run / Hold +/-** to toggle between Single and Continuous.

Resolution

Resolution is the number of individual acquisitions that occur in the USB Power Sensor. This data is read by the FieldFox and plotted across the X-axis to form a trace. More data points increases measurement resolution. However, more data points requires more time to acquire, query, and plot.

How to set Resolution

- Press **Sweep 3**
- Then **Resolution**
- Then choose from the following:
 - **Low** 240 data points.
 - **Medium** 1000 data points.
 - **High** Calculated value - approximately 8000 data points.

Triggering

For pulse measurements, a trigger signal refers to the event that causes the USB Peak Power Sensor to initiate measurement acquisition. It does NOT refer to triggering the FieldFox.

Trigger settings can be used with ALL pulse measurements unless stated otherwise.

A **Waiting for Trigger** message on the FieldFox screen is posted on behalf of the USB Power Sensor when it is waiting for a pulse signal at the RF Input (Internal) or a TTL signal at the USB Sensor External Trigger input.

How to make Trigger settings

- Press **Sweep 3**
- Then **Trigger**

- Then **Trig Type**
- Then choose from the following:
 - **Freerun** The USB Power Sensor acquires data without waiting for a trigger. This mode is NOT supported for Trace Graph measurements.
 - **Internal** The USB Power Sensor acquires data when a valid pulse signal is detected at the RF input. The following Trigger settings determine the validity of the trigger signal.
 - **External** The USB Power Sensor acquires data when a valid TTL signal is detected at the USB Power Sensor external trigger input.

Trigger Edge

This setting determines which edge of a trigger signal initiates data acquisition.

- Press **Sweep 3**
- Then **Trigger**
- Then **Trigger Edge**
- Then choose from the following:
 - **Pos** Acquisition is triggered by the rising (positive) edge of a valid signal.
 - **Neg** Acquisition is triggered by the falling (negative) edge of a valid signal.

Trigger Delay

After a valid trigger signal is received at the USB Power Sensor, data acquisition begins after the specified Trigger Delay time PLUS the specified Start time. See the Pulse Timing diagram in “**Trigger Settings Annotation**” on **page 570** for more information.

- Press **Sweep 3**
- Then **Trigger**
- Then **Trigger Delay**
- Then enter a value using the numeric keypad, the **▲▼** arrows, or the rotary knob.

Auto Trigger

Used ONLY when Trigger Type = Internal, this setting determines whether the trigger level is set manually or is set to the default level in the USB Power Sensor firmware.

- Press **Sweep 3**
- Then **Trigger**

- Then **Auto Trigger**
- Then choose from the following:
 - **ON** Trigger level is determined by the USB Power Sensor firmware.
 - **OFF** The trigger level is set manually using the Trigger Level setting.

Trigger Level

Used when Trigger Type = Internal AND Auto Trigger = OFF (Manual).

- Press **Sweep 3**
- Then **Trigger**
- Then **Trig Level**
- Then set the trigger level using the numeric keypad, the **▲▼** arrows, or the rotary knob. A line appears on **Tr 1** at the current trigger level setting. Data acquisition occurs when the RF input signal crosses the line. This setting can be used with either Positive or Negative edge triggering.

Qualification

Use the qualification setting to avoid triggering on false pulses and to aid in stabilizing the power trace.

The qualification time defines the time the signal has to remain below the trigger threshold before a transition through the threshold will qualify as a trigger. This can help stabilize a power trace, particularly with digitally modulated pulses that may have many transitions through the trigger threshold. By setting the qualification time longer than the short transitions of the data signal the sensor will reliably trigger on the pulse and not on the data. It will also eliminate triggering on very short noise spikes when the trigger level has to be set to low power.

NOTE

It may be necessary to set the qualification time to the minimum 20 ns in order to trigger on very short pulses.

-
- Press **Sweep 3**
 - Then **Trigger**
 - Then **Qualification**
 - Then set the qualification value using the numeric keypad or the rotary knob (default: 100 ns, minimum: 25 ns, maximum: 50 μ s).

Trigger Settings Annotation

Trigger settings are annotated on the FieldFox screen as highlighted in **red** in the following image:

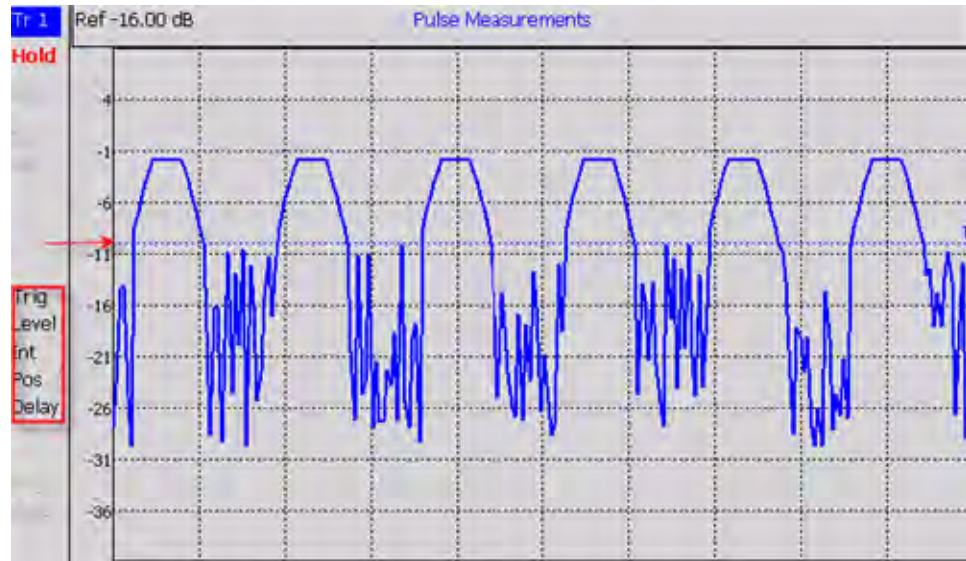

In the previous graphic, the settings are: Trig Level = -10 dBm, Trig Type (Int), Pos Slope (/), Delay

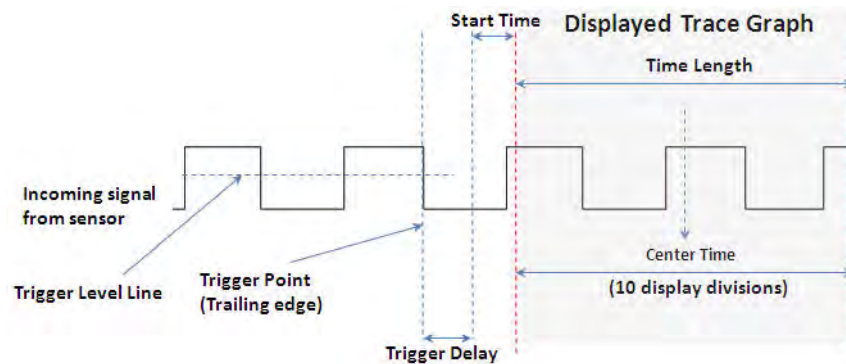

Marker Settings

Markers are not allowed with Meter-style measurements.

Markers are displayed on **Tr 1** and also on the zoom trace if the marker is within the zoom window time span.

Up to six standard markers can be used to provide readouts of the Y-axis amplitude at the current X-axis location.

The six standard markers can also be used as Delta Markers.

Learn more about standard markers in **“All about Markers” on page 692.**

Amplitude Markers

Amplitude markers are horizontal dotted lines that you can move to any amplitude level on the screen. The two amplitude markers can be set independently or used as a pair of delta markers.

Amplitude markers can be used as a visual comparison aid with the pulse measurement traces.

How to make Amplitude Marker settings

- Press **Marker**
- Then **More**
- Then **Ampl Markers**
- Then choose from the following:
 - **OFF** Amplitude markers are NOT displayed.
 - **ON** Amplitude markers ARE displayed at their previous positions.
- Then **Ampl Mkr 1 or 2**
- Enter a value in dBm for the marker using the numeric keypad, the **▲▼** arrows, or the rotary knob.
- Press **Delta Ampl Mkr**
- Then choose from the following:
 - **ON** AmplMkr 2 value is relative to AmplMkr 1. When AmplMkr 1 is moved, AmplMkr 2 also moves to maintain the AmplMkr 2 value between them.
 - **OFF** The two amplitude markers move independent of one another.

Marker Search

Use Marker Search to find and move markers to locations on the **Tr 1** trace.

How to Search with Markers

- Activate the marker to be used for the search
- Then press **Mkr ->/Tools**.
- Then **Marker Search**
- Then **Zone Search**
- Then choose from the following:
 - **ON** Available ONLY when the zoom window is enabled, the search is limited to the zone defined by the zoom window.
 - **OFF** The search is performed over the entire Tr 1 trace.

Then choose from the following:

- **Target**, **Peak**, and **Minimum**. Learn more about these standard features beginning in **“Searching with Markers” on page 698**.
- **Rise Time** Select, then set a value in dB. Delta markers are created and placed at the Peak and at the specified value BEFORE the Peak.
- **Fall Time** Select, then set a value in dB. Delta markers are created and placed at the Peak and at the specified value AFTER the Peak.

NOTE

Rise and Fall time in Marker Search uses different criteria than in Auto Analysis and will therefore result in different reported values.

Auto Analysis

Auto Analysis reports the following TEN pulse measurements:



NOTE

For more information on peak power measurements refer to the documentation for your power sensor. Learn more, <https://www.keysight.com/us/en/assets/7018-03076/application-notes/5990-8708.pdf>.

1 - Average Power	Average power level of all measured data points
2 - Peak Power	Highest reading of all measured data points
3 - Peak minus Average	Difference between the above two results
4 - Pulse Top	Power value based on the specified Pulse Top setting.
5 - Rise Time	The time it takes for a pulse to rise from 10% to 90% of its peak value.
6 - Fall Time	The time it takes for a pulse to fall from 90% to 10% of its peak value.
7 - Pulse Width	The time between the rising edge and falling edge of a pulse.
8 - Pulse Period	The time of one complete pulse cycle

9 - Duty Cycle	The ratio of the pulse width / pulse period.
10 - Pulse Rep Freq	The rate, in pulses / sec, at which pulses recur.

How to enable Auto Analysis

- Press **Mkr ->/Tools**.
- Then **Auto Analysis**
- Then choose from the following:
 - **OFF** Analysis OFF
 - **ON** The Analysis values appear below trace 1.

Pulse Top

Pulse Top is NOT the same as the pulse Peak. Pulse Top is used to set and report the reference power level. You enter a value in percent, and the Pulse Top value is reported in the Auto Analysis table in dB down from 100% of the reference power level.

How to set Pulse Top

- Press **Mkr ->/Tools**
- Then **Pulse Top**
- Then enter a percent value between 0 and 100 using the numeric keypad, the **▲▼** arrows, or the rotary knob.
 - When set to 10%, 10 dB down from the 100% acquisition is reported.
 - When set to 50%, 3 dB down from the 100% acquisition is reported.
 - When set to 90%, 0.5 dB down from the 100% acquisition is reported.

Grid

Enables and disables the display of a 10 x 10 grid on the FieldFox screen.

How to enable Grid display

- Press **Mkr ->/Tools**
- Then **Grid**
 - **OFF** Grid OFF
 - **ON** A grid of X/Y lines appears on the screen.

Trace Memory

A memory trace is a pulse measurement **Tr 1** data trace (NOT the trace in the Zoom window) that has been stored in the FieldFox volatile memory. It then becomes static, meaning it is not updated with normal pulse measurements. It can be displayed on the screen by itself, or with a pulse trace for comparison purposes.

The **Tr 1** data trace is displayed in **yellow**.

The memory trace is displayed in **blue**.

How to display data and memory traces

- Press **Trace 6**.
- Then **Trace Memory**
- Then **Data->Mem** to store the current live trace into memory. A ‘beep’ sounds to confirm the data trace has been saved to memory. There is no display annotation that indicates that the memory trace has been stored.
 - Press **Data** to view only the data trace.
 - Press **Memory** to view only the memory trace.
 - Press **Data & Memory** to view both the live trace and the stored memory trace.

24 VVM (Vector Voltmeter) Mode - Option 308

VVM Mode (Option 308) measures the electrical length of cables and other devices. The 1-Port Cable Trimming and 2-Port Transmission measurement displays the electrical length in both Magnitude and Phase.

Figure 24-1 Display for the 1-Port Cable Trimming measurement

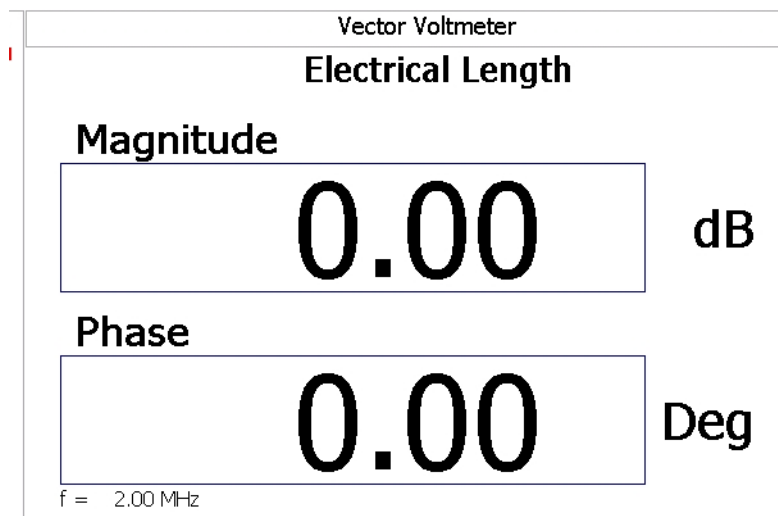

In this Chapter

- [“Overview” on page 577](#)
- [“Measurement Selection” on page 578](#)
- [“Frequency Selection” on page 578](#)
- [“Display Resolution” on page 578](#)
- [“IF Bandwidth” on page 579](#)
- [“Output Power” on page 579](#)
- [“Averaging” on page 580](#)
- [“Single or Continuous Measure” on page 581](#)
- [“VVM Calibration” on page 581](#)
- [“Zeroing” on page 581](#)

Procedures

[“1-Port Cable Trimming Measurements ” on page 583](#)

[“2-Port Transmission Measurements” on page 585](#)

[“A/B and B/A Measurements” on page 587](#)

Overview

In the FieldFox, both 1-port and 2-port measurement types use a different configuration setup from the HP/Keysight 8508A Vector Voltmeter.

Figure 24-2 Typical 8508A measurement configuration –as shown in the 8508A manual.

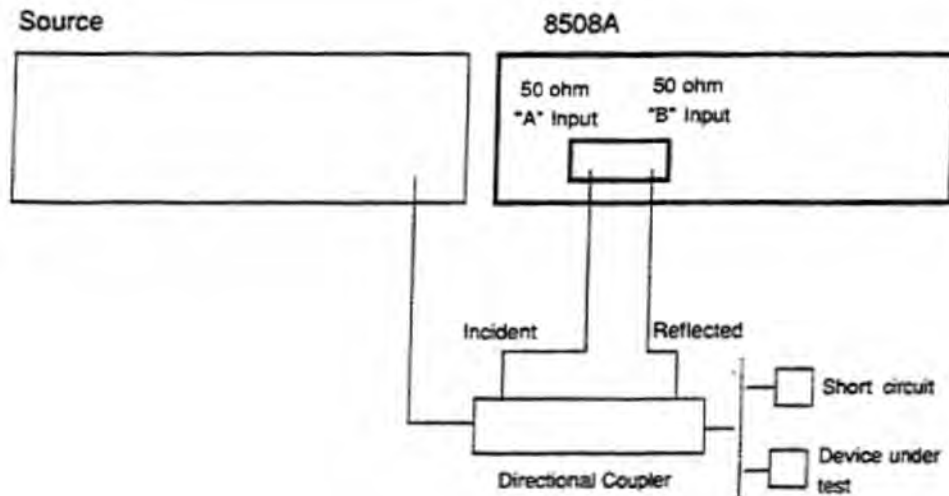

The above block diagram requires an external source and directional coupler to measure the electrical length of a DUT or cable to be trimmed. Separate paths are used to measure the Incident signal (A) and Reflected signal (B). To measure the ratio of the Reflected/Incident signals, you were required to select B/A for both the Magnitude and Phase display.

In the FieldFox, the source and directional coupler are inside the instrument. This allows you to connect the DUT to ONLY the FieldFox PORT 1, with NO external instruments, in order to make Cable Trimming measurements.

See the FieldFox block diagram and Cable Trimming procedures beginning in **“1-Port Cable Trimming Measurements” on page 583.**

VVM Mode Settings

Select VVM Mode before making any setting in this section.

How to select VVM Mode

- Press **Mode**
- Then **VVM**

Measurement Selection

How to select a VVM Measurement

- Press **Measure 1**
- Then choose from the following:
 - **1-Port Cable Trimming** 1-port reflection measurement. Learn how to make this measurement in [“1-Port Cable Trimming Measurements” on page 583.](#)
 - **2-Port Transmission** 2-port transmission measurement. Learn how to make this measurement in [“2-Port Transmission Measurements” on page 585.](#)
 - **B/A** and **A/B** 2-port ratioed receiver measurements using external sources. Learn more in [“A/B and B/A Measurements” on page 587.](#)

Frequency Selection

How to set Frequency

- Press **Freq/Dist**
- Then **Frequency**
- Enter a value using the numeric keypad, the **▲▼** arrows, or the rotary knob.
- After using the **▲▼** arrows or the rotary knob, press **Enter**. The increment setting of the arrows is based on the current span and can NOT be changed in VVM Mode.
- After using the keypad, select a multiplier key. Learn about multiplier abbreviations in [“Multiplier Abbreviations” on page 53.](#)

Display Resolution

You can display either one digit or two digits after the decimal point for both magnitude and phase readings.

This setting survives a Preset and Mode Preset.

How to set Resolution

- Press **Scale/Amptd**
- Then **Resolution**
- Then choose:
 - **1** 0.0 (default)
 - **2** 0.00

IF Bandwidth

Reducing the IF receiver bandwidth reduces the effect of random noise on a measurement. However, narrower IF bandwidths cause longer measurement times.

For highest accuracy, Zero AFTER changing the IF Bandwidth. Learn about Zeroing in [“Zeroing” on page 581](#).

How to set IF BW

- Press **BW 2**
- Then **IF BW**
- Then choose from the following:
 - **10 Hz | 100 Hz | 1 kHz | 10 kHz | 100 kHz**
 - **More 30 Hz | 300 Hz | 3 kHz | 30 kHz**

Output Power

Set the power level out of the FieldFox to High, Low, or manually set power level to a value between High and Low.

Generally, the high power setting is used when measuring passive, high-loss devices to place the signal farther from the noise floor. However, for devices that are sensitive to high power levels such as amplifiers, use the Low power setting.

For best measurement accuracy, use the Manual power setting at -15 dBm. After calibration, the power level can be decreased for amplifiers, or increased for higher dynamic range.

CAUTION

Power Level settings in this mode will NOT change Power Level settings in other modes. To help prevent damage to your DUT, use caution when changing modes with your DUT connected to the FieldFox test ports.

How to set Output Power

- Press **Meas Setup 4**.
- Then **More**
- Then **Output Power**
 - **High** (Default setting) Sets output power to the maximum achievable power at all displayed frequency.
 - **Low** Sets output power to approximately –45 dBm.
 - **Man** Set output power to an arbitrary value.
 - Then press **Power Level**
 - Then enter a value using the numeric keypad, the **▲▼** arrows, or the rotary knob.
 - Press **Enter**.

Averaging

Averaging helps to reduce the effects of random noise on a measurement. The FieldFox computes the displayed value over several consecutive readings. Average count determines the number of readings to average. The higher the average count, the greater the amount of noise reduction.

An average counter is shown in the left edge of the screen as **Avg N**. This shows the number of previous readings that have been averaged together. When the counter reaches the specified count, then a 'running average' of the last **N** readings is displayed.

Average count = 1 means there is NO averaging.

This setting can be changed at any time without affecting calibration accuracy.

How to set Averaging

- Press **Meas Setup 4**
- Then **More**
- Then **Avg N** where **N** is the current count setting.
- Enter a value using the numeric keypad. Enter **1** for NO averaging.
- Press **Enter**.

To restart the averaging process, press **Meas Setup 4**, then **More**, then **Restart**

Single or Continuous Measure

This setting determines whether the FieldFox measures continuously or only once each time the **Single** button is pressed. Use **Single** to conserve battery power or to allow you to save or analyze a specific measurement.

This setting can be changed at any time without affecting calibration accuracy.

How to set Single or Continuous

- Press **Meas Setup 4**
- Then choose one of the following:
 - **Single** Automatically sets Continuous OFF and causes the FieldFox to make ONE measurement, then hold for the next **Single** key press. The **Hold** annotation changes to an arrow --> while the measurement occurs.
 - **Continuous OFF** and **Hold** both put the FieldFox in Hold mode.
 - **Continuous ON** Makes continuous measurements. This is the typical setting when battery power is not critical.
- You can also use **Run / Hold +/-** to toggle between Single and Continuous.

VVM Calibration

CalReady is accurate for most zeroed VVM measurements at frequencies below about 6 GHz. For the very highest accuracy, especially above 6 GHz, then perform a QuickCal or Mechanical Cal. Learn more in [“How to Perform a Calibration” on page 135](#).

NOTE

QuickCal is only available on N991xA/2xA/3xA models.

Press **Zero OFF** before calibrating (sets Zero to OFF).

Zeroing

Zeroing, also known as Normalization, or Data/Memory, simply “Zeroes” the Magnitude and Phase display when **Zero ON** is pressed. All subsequent measurements are relative to the measurement that was made when Zero was pressed.

When an instrument state is saved with Zero ON, the zeroing data is saved with the state file, similar to how a calibration is saved with a state file.

- When performing a 1-Port Cable Trimming operation, a reference cable is connected and measured. Then Zero is pressed, and subsequent cables are measured and trimmed to match electrical length of the reference cable.

- For 2-port measurements, Zero is typically pressed when a THRU connection is made in place of a DUT. Learn more in [“2-Port Transmission Measurements” on page 585](#).

Press Zero OFF before performing a QuickCal or Mechanical Cal (sets Zero to OFF).

NOTE

QuickCal is only available on N991xA/2xA/3xA models.

How to select Zeroing

- Press **Meas Setup 4**
- Then **Zero Ref**
 - **Open** – select to display Phase = 0.0 Deg when zeroed.
 - **Short** – select to display Phase = 180.0 Deg when zeroed.
- Then **Zero ON**
- Select **Zero OFF** to turn zeroing off.

1-Port Cable Trimming Measurements

A 1-Port Cable Trimming measurement is used in a cable fabrication procedure to validate proper electrical length.

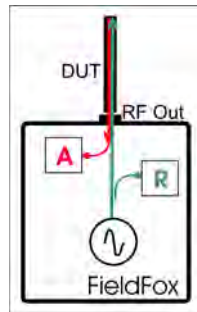

- The R receiver measures incident signal (green line) out of the source.
- The A receiver measures reflected signal (red line) from the end of the DUT (black line).
- In VVM mode, the display ALWAYS shows ratioed (A/R) measurements which is the electrical length of the DUT.

How to make a 1-Port Cable Trimming Measurement

1. Press **Mode** then **VVM** then **1-Port Cable Trimming**.
2. Press **Freq/Dist** then enter the frequency for the measurement.
3. To improve measurement stability, change the IF Bandwidth, Output Power, and Averaging settings as needed.
4. Press **Meas Setup 4** then **Zero OFF**.
5. Optionally calibrate the FieldFox. Learn more about VVM calibration in “**VVM Calibration**” on page 581.
6. To ensure that the calibration is adequate, perform the following **optional Measurement Verification** procedure.

NOTE

This measurement verification procedure is suitable for low frequency measurements. However, for high frequency measurements, a more sophisticated procedure is required.

- a. Connect a short standard to **PORT 1** where cables to be trimmed will be connected.
 - b. Press **Meas Setup 4** and press **Zero**.
 - c. Remove the short standard and connect the open standard.
 - d. Confirm that magnitude measurement is less than -0.1 dB and that the phase value reads 180° degrees.
7. Attach the shortest cable to the FieldFox **PORT 1** connector. This cable is the reference cable. Leave the end of the reference cable open (unterminated).
 8. Press **Meas Setup 4** then press **Zero**.

9. Remove the reference cable from the FieldFox **PORT 1** connector.
10. Connect an unterminated, longer cable to the FieldFox **PORT 1** connector.
11. Observe the displayed phase difference between the reference cable and the untrimmed cable.

NOTE

The VVM phase reading shows a maximum of $\pm 180^\circ$. Therefore, the electrical length of the untrimmed cable **MUST** be within 180° of the reference cable.

12. Carefully trim the cable until the phase shift reads zero. The attached cable's electrical length is now matched to the reference cable.
13. Repeat steps 10 through 12 for the remaining cables to be trimmed.

2-Port Transmission Measurements

A 2-Port Transmission measurement is used for measuring electrical length, insertion loss, gain, or isolation of a DUT at a single CW frequency. The FieldFox signal source is transmitted out the port 1 connector, through the DUT, and into the port 2 connector. In the following image, the gain of an amplifier is being measured.

Figure 24-3 2-Port Transmission measurement of an amplifier

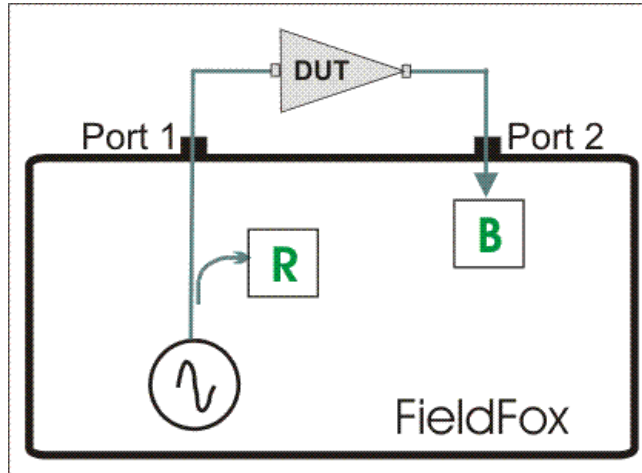

How to make a 2-Port Transmission Measurement

1. Press **Mode** then **VVM** then **2-Port Transmission**.
2. Press **Freq/Dist** and enter the measurement frequency.
3. Press **Meas Setup 4** then **More** then **Output Power**. Select **High** for passive devices. Select **Low** for amplifiers.
4. Calibrate the FieldFox using one of the methods described in “**VVM Calibration**” on page 581. Before performing a QuickCal or Mechanical Cal, press **Meas Setup 4** then **Zero OFF**.

NOTE

QuickCal is only available on N991xA/2xA/3xA models.

5. 5.Connect the DUT.

Notes:

- The magnitude value is the gain (positive value) or the loss (negative value) of the DUT.
- The phase value is the difference in phase (in degrees) between the DUT input and output.

VVM (Vector Voltmeter) Mode - Option 308
2-Port Transmission Measurements

- To measure isolation of the amplifier, reverse the connection to the amplifier (**PORT 1** to the amplifier output).

A/B and B/A Measurements

These measurements allow you to use the FieldFox A and B receivers, along with an external source, to make ratioed measurements.

NOTE

These measurements require the “Full 2-port S-parameters” option.

The image below shows a typical configuration for a B/A magnitude and phase measurement of a 2-port DUT. This DUT can be an antenna / probe setup. Using network analyzer terms, the image shows the A receiver as the reference receiver which measures the signal that is applied to the DUT. The B receiver is the test port receiver which measures the DUT response.

Figure 24-4

B/A Transmission measurement with external source

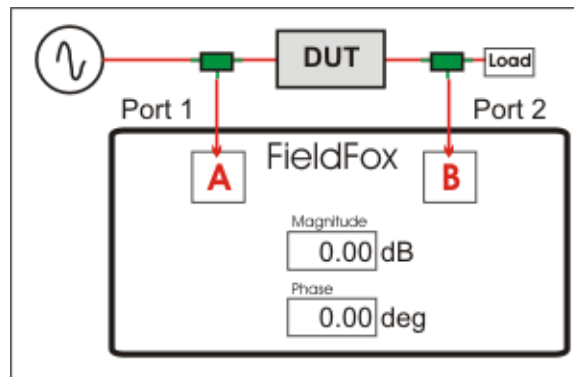

Procedure

1. Connect the external source's frequency reference output to the FieldFox **Freq Ref IN** on the top panel. If you are unable to use a common frequency reference, then increase the IFBW to ensure you are measuring the peak of the correct signal. After locating and tuning to the signal, you may be able to lower the IFBW to reduce noise.
2. On the FieldFox, select **System 7**, then **System Configuration**, then **Frequency Ref**, then **Freq Ref Source** then **Ext**.
3. Press **Mode**, then **VVM**, then **B/A** or **A/B**
4. The FieldFox internal source is NOT used, so the output power setting is not relevant.
5. To calibrate, replace the DUT with a THRU connection, preferably by connecting together the two Power Splitters (shown in green). For low frequency measurements, TEEs can be used.
6. Press **Meas Setup 4**, then **Zero**.
7. Connect the DUT and measure.

VVM (Vector Voltmeter) Mode - Option 308
A/B and B/A Measurements

25 ERTA (Extended Range Transmission Analysis) Mode - Option 209

ERTA (also known as **FoxTrot**) uses two FieldFox units to make long-distance scalar transmission measurements. One unit is the source and the other unit is the Receiver.

In this Chapter

[“Overview” on page 590](#)

[“Requirements and Limitations” on page 591](#)

[“Start Connection Wizard” on page 592](#)

[“Configure Measurement Settings” on page 596](#)

[“Select Measurement” on page 596](#)

[“Normalize” on page 597](#)

[“Source Tracking Offset and Offset Reversal” on page 597](#)

[“Improve Dynamic Range” on page 598](#)

[“Source Enable and Source Mode” on page 598](#)

Overview

ERTA uses two FieldFox units to make long-distance scalar, tracking transmission measurements. One unit is the source and the other unit is the Receiver.

Communication takes place between the two units with a LAN connection and hard-wired trigger signals. Once the two units are synchronized, the Receiver unit becomes the **primary** and measures the output of a DUT, while the Source unit responds as secondary supplying signal at the DUT input. The two units, possibly separated by hundreds of meters, step together through the selected frequency range making measurements such as long cable characterization.

With a power splitter at the Source unit, the SA Receiver can be used to measure the reference signal to make a true B/R ratio measurement. Because the reference trace is updated on every sweep, there is no need for static trace normalization. Accuracy is further enhanced with input and output cable corrections. Furthermore, the alignment process keeps the SA receivers calibrated. For information on alignments, refer to the SA mode chapter's section, "[Alignments](#)" on page 211.

Requirements and Limitations

Requirements

- Two FieldFox units with option 209 installed. SA Mode is required for option 209.
- Ethernet LAN cable(s). Either TWO cables that are used to connect both units to the internet or ONE cable that is long enough to connect the two FieldFox units. This may require a cross-over cable.

NOTE

When you change network connections, it may take up to 2 minutes for the old address to be replaced by the new address. If the FieldFox was initially assigned an IP address by a DHCP server, and then the FieldFox LAN connection with a DHCP server is removed and is the FieldFox is reconnected to a LAN segment with no DHCP server (such as a direct connect to another FieldFox), the FieldFox may take up to two minutes to self-assign an automatic private IP address. During this connection time the last recognized DHCP address is displayed on the FieldFox, but is invalid.

-
- Two trigger cables that are long enough to connect the two FieldFox units, each with SMB (m) to SMA (f) connectors.
 - RF cabling to and from DUT.
 - Power Splitter (Optional) for enhanced B/R ratio measurements.

Limitations

The following SA features are removed in ERTA mode (Option 209):

- Channel Measurements, Tune and Listen, Interference Analysis, Radio Standards, and Sweep Triggering.

The following SA features are disabled during partnership synchronization:

- Video BW, SwpAcquisition, Frequency Count, Record/Playback, and certain Amplitude Units.
- The only keystrokes allowed on the Source unit are **Send Text Message** and **Exit**.

Start Connection Wizard

Use the FieldFox Connection Wizard to guide you through the following physical setup.

On the Receiver unit:

- Press **Mode** then **ERTA**
- Then **Meas Setup 4** then **Connection Wizard** then **Start**.

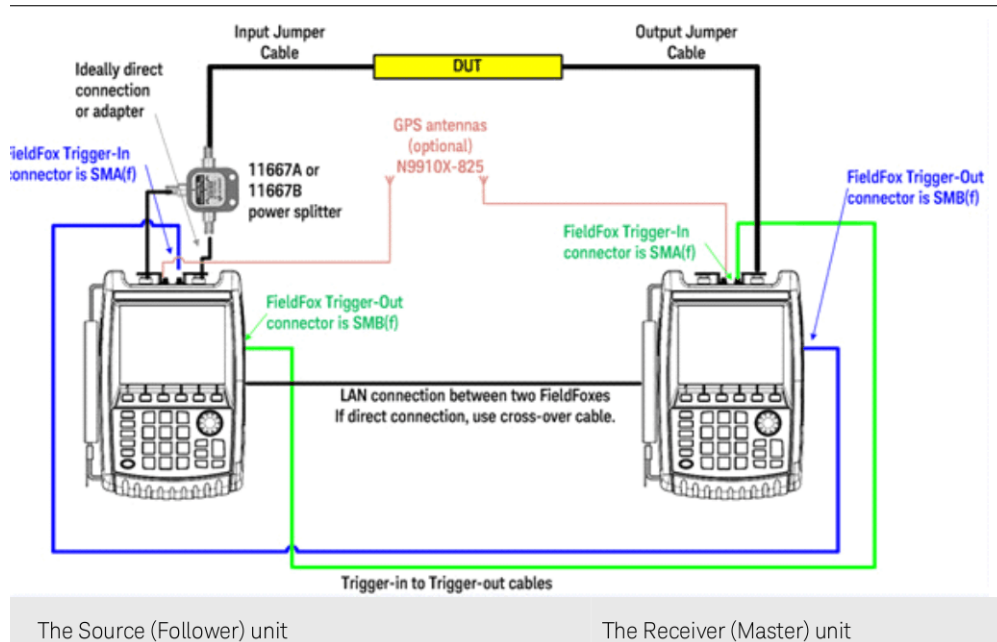

STEP 1: Select [Start] when ready

- Press **Start**
- At any step, press **Exit** to end the wizard.

STEP 2: Connect Trigger and LAN cables

- **LAN:** Connect a LAN cable to each unit. The units can either both be connected to the internet on the same network through a switch or router, or they can be connected directly to each other (a crossover cable may be necessary).
- **Trigger signals:** On each unit, connect the **Ref/Trig Out** SMB (m) connector on the FieldFox side panel to the **Ref/Trig In** SMA (f) connector on the other FieldFox top panel.
- **RF connections**
Preferred method (pictured above):

- On the Source unit, connect the Port 1 RF Output connector to the input of a power splitter.
- Connect one power splitter output to the Source unit Port 2 RF Input.
- Connect the other power splitter output to the DUT input.
- Connect the DUT output to the Port 2 RF Input of the Receiver unit.

Simplified method (not shown):

- Omit the power splitter. Connect the Source unit Port 1 RF Output connector to the DUT input. **The measurement is a raw B receiver.** Specs do NOT apply.

STEP 3: Select LAN address of ERTA Partner

The Receiver unit is the primary partner, annotated with **RCVR Primary**.

The Source unit is the secondary partner, annotated with **SRC Secondary**.

On the Receiver unit:

- Press **ERTA Partner (not specified)**. The IP addresses of potential FieldFox units are displayed. Select the IP address of the Source unit. If 10.10.10.1 appears, then NO FieldFox units were found. The LAN setting “Obtain IP Address using” MUST be set to DCHP. Learn more in **“LAN Settings” on page 758**. Also be sure that Opt. 209 has been installed correctly on the Source unit.
- Press **Continue**.

STEP 4: Test Partnership

- Press **Test Partnership**. If the Source unit is NOT already in ERTA mode, it will be started, which may take a several seconds. When successful, LAN OK and Trigger OK will appear on the screen.
- If either the LAN or Trigger test fails, then press **Clear Test**, then **Test Partnership** to retry the test.
- Optional: Press **Send Text Message**, then enter a message to send to the Receiver unit. A LAN connection is necessary. For quick communication, custom Keywords can be setup using the FieldFox labeler. Learn how in **“Edit Keywords” on page 779**.

Any of the following will end the partnership:

- Press **EXIT Partnership**
- Select Global or Mode Preset
- Change Modes
- Recalling a non-ERTA State file. Recalling an ERTA State file can re-establish a partnership if the Source unit is still on the network at the same location.

- Press **Continue**.

STEP 5: Measure Jumper Cables

These steps can be used to characterize an Input and Output jumper cable that may be connect the DUT to the FieldFox. The loss of the characterized jumper cables can then be removed from the DUT measurements. The measurements are stored to the internal Cables folder using an auto-generated *.csv filename.

- The Input cable is attached between the Source/splitter output and the DUT input.
- The Output cable is attached between the DUT output and the Receiver unit.

NOTE

For optimum flexibility, use the Scale, then More, then Corrections menu to measure, save, and recall cable characterizations. These softkeys are duplicated from the SA Field Strength - Antenna/Cable characterization. Learn more in [“Field Strength Measurements” on page 172](#).

Figure 25-1

Input and Output jumper cables are measured on the Receiver unit

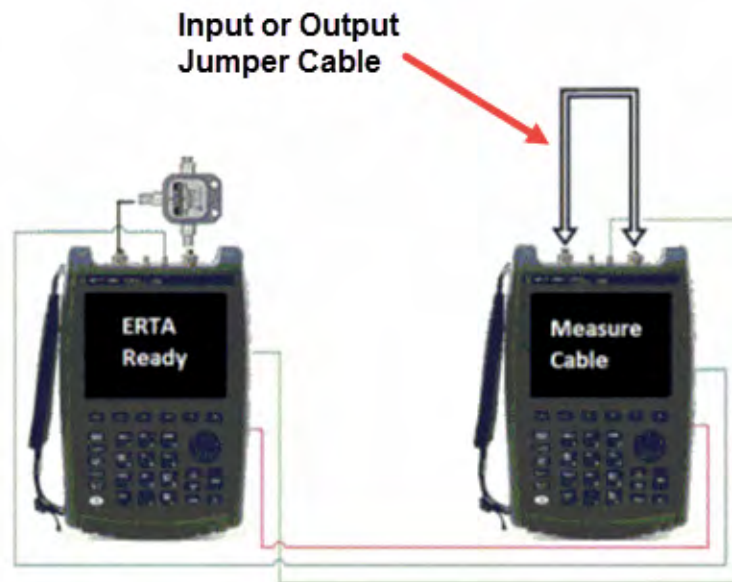

If your DUT input **AND** output is connected directly to the FieldFox, or you choose to ignore the loss of BOTH jumper cables, then press **Skip this step**.

Otherwise, press **Measure Jumper Cables**.

Do the following for both the Input and Output jumper cables:

- Press **Skip this step** to skip the cable measurement.
- Otherwise, connect the Input / Output jumper cable as shown below, then press **Measure Input (or Output) Cable**.

ERTA (Extended Range Transmission Analysis) Mode - Option 209
Start Connection Wizard

- Press **Re-measure** or **Continue**.
- Press **Apply Corrections Auto** to remove the jumper cables from subsequent DUT measurements (default = Auto).
- Press **Done** to exit the Connection Wizard.
- On the Receiver unit, press **Primary ERTA Partnership**. The Source unit enters ERTA mode as the secondary.

Configure Measurement Settings

On the Receiver unit, select measurement settings such as Frequency range, Res Be, Points, and so forth. Zeros pan frequency is allowed even though the frequency is fixed and no stepping is required.

Learn about these settings in **“SA Mode Settings” on page 163.**

Select Measurement

The following traces are provided for your convenience. They are all configured as Clear/Write.

Press **Meas 1**, then choose one or more of the following:

Softkey	Shown on screen	Description
Input Power R	2 w r	R receiver. Reference power measured by the Source unit before entering the DUT.
Output Power B	3 w B	B receiver. Power out of the DUT measured at the Receiver unit.
Gain or Loss B/R	1 w G	Gain or Insertion Loss. The B receiver data divided by the R receiver data (B/R) This measurement can be displayed accurately with, or without, displaying the R or B measurements.

Figure 25-2

Input power, Output power, and gain measurement traces

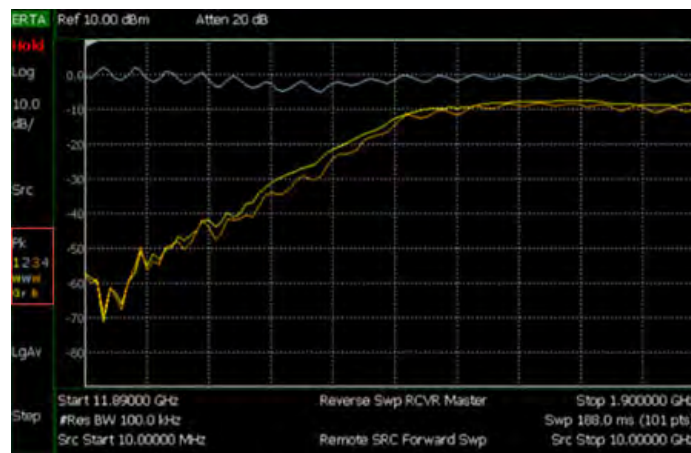

To change the trace numbers of these three measurements, or to select a trace state other than Clear/Write, press **Trace 6**.

Learn more about Trace Display States in [“Trace Display States \(SA Mode\)” on page 208](#).

Normalize

Normalize can be used to quickly provide ‘zeroing’ for any of the ERTA (B, R, or G) traces. On the sweep AFTER selecting Normalize, Trace 1 is copied to Trace4. It is then put into View state and subtracted from that input on subsequent sweeps. Any trace (1, 2, or 3) which is set to process that same input (B, R, or G) will therefore be processing normalized measurement data. This continues as long as the frequency span, number of points, and the trace input (B, R, or G) is NOT changed. If any of these settings change, Normalize is deactivated.

How to Normalize the B trace

- Press **Meas Setup 4**
- Then **Remote Source**
- Then **Normalize ON**

Source Tracking Offset and Offset Reversal

Source offset tracking is used to offset the Source frequency from the Receiver frequency by a fixed offset at every tune frequency. This feature is used when the DUT contains a frequency converter.

How to set Tracking Offset and Offset Reversal

- On the Receiver unit, press **Meas Setup 4**,
- Then **Remote Source**
- Then **Advanced**
- Then choose one or both of the following:
 - **Tracking Offset** Enter an offset value.
 - **OfsTrkReversal** Determines whether Receiver Freq is added to or subtracted from the Offset Freq.
 - **OFF** SourceFreq = Offset + RecFreq. Use to measure Upconverters.
 - **ON** SourceFreq = Offset - RecFreq. Use to measure Downconverters. The source sweeps in Reverse direction.

NOTE

The Offset Freq. MUST be larger than the Receiver Stop Freq.

Improve Dynamic Range

The following settings can be made to reduce measurement noise which improves Dynamic Range.

Increase source power as much as possible while maintaining a leveled source.

How to set Source Power

- Press **Meas Setup 4**
- Then **Remote Source**
- Then **Source Power**
- Then either **Max Power** or **Leveled** - Increase source power until the unlevelled warning appears. Then decrease power until power is again leveled.

To further reduce measurement noise, on the Receiver unit:

- Reduce **Attenuation** to 5 dB, then turn the **Preamp ON**. Learn how in [“Preamplifier Control \(Opt 235\)” on page 171](#).
- Decrease the **Res BW**. Learn how in [“Resolution Bandwidth \(Res BW\)” on page 194](#).
- Set Frequency Reference to GPS on both units. This requires Option 307 (Built-in GPS) and two GPS antennae. The GPS reference can be enabled for several sweeps. Then if you move to a location without an adequate GPS signal, Hold-over Mode will occur. Learn more about GPS as a frequency reference in [“Frequency Reference Source” on page 754](#).

Source Enable and Source Mode

When **Source Enable [OFF]** is selected, or when **Source Mode [CW or CoupledCW]** is selected, then synchronization ends and the two partner units revert to general SA (non-tracking) sweeps. However, the units are still in partnership, and other settings continue to be synchronized such as Frequencies, ResBw, and Points.

26 AM/FM Metrics (SA Only and Option 355)

NOTE

The FieldFox assumes you have manually set up the CF, span, and amplitude settings. Refer to [Chapter 9, “SA \(Spectrum Analyzer\) Mode \(Option 233–Mixed Analyzers\).”](#)

In this Chapter

[“Using AM/FM Metrics” on page 599](#)

[“SINAD and THD Calculations” on page 606](#)

[“Interpreting AM/FM Metrics Error Messages” on page 609](#)

Using AM/FM Metrics

Using FieldFox's analog demodulation, users maintaining AM/FM radio systems can demodulate and characterize AM and FM signals. They can tune to the signal and listen to the audio tones using FieldFox's built-in speakers or a headphone. They can also display the RF spectrum, the demodulated waveform and AM/FM metrics such as carrier power, modulation rate, and SINAD.

AM/FM Metrics enables you to make the following measurements:

- | | |
|------------------|--|
| AM Measurements: | – AM Measurements: Carrier power, AM rate, AM modulation index |
| FM Measurements: | – FM deviation (peak and RMS), Modulation Rate, Carrier power, Demodulated voltage, SINAD, THD (total harmonic distortion) |

And, can be enabled/disabled simultaneously with Tune and Listen.

Overview of Measurement Types

If you are familiar with the AM/FM measurements and terms, skip to [“How to Set Up AM/FM Metrics” on page 602.](#)

Table 26-1 Measurement Details

Measurement details	
Modulation Rate	The modulation rate quantifies how fast the modulation is and equates to the frequency of the baseband signal that modulates the carrier.
SINAD (Signal to Noise and Distortion Ratio)	<p>Another commonly used distortion measure is signal to noise and distortion ratio (SINAD). SINAD, in nature, is the reciprocal of the modulation distortion provided by the “distortion/total Vrms,” but the SINAD is usually expressed in a logarithmic term as follows:</p> <p>Where:</p> <p>S = Signal Power</p> $D = \sum_{k=0}^n D_n$ <p>N = Noise</p> <p>SINAD = [(S + D + N) / (D + N)] OR</p> <p>Refer to “SINAD and THD Calculations” on page 606.</p>
THD (Total Harmonic Distortion)	<p>The total harmonic distortion (THD) measurement further isolates the total harmonic distortion component from the noise component in the total unwanted signal. It helps the user to troubleshoot the root causes of modulation distortion.</p> <p>S = Signal Power</p> $D = \sum_{k=0}^n D_n$ <p>N = Noise</p> $THD = [(D + N) / (S + D + N)]$
RF spectrum of the modulated signal	This is the most traditional spectrum analyzer measurement viewing the modulated carrier signal power in frequency domain. Prior to being modulated, the signal power of a sinusoidal carrier concentrates at the carrier frequency. By contrast, modulation causes sidebands indicating the power redistribution over frequencies. The pattern of the sidebands depends upon the modulation format.
Demod waveform	This measurement retrieves the baseband signal from the modulated signal via the demodulation process, and displays the baseband signal in a pattern of modulation depth/deviation versus time. Since the modulation depth/deviation is directly proportional to the instantaneous amplitude of the baseband signal, the measurement result helps to intuitively evaluate the quality of the baseband signal.
AM modulation depth	AM modulation depth = (Peak-to-Peak / 2)

Table 26-1 Measurement Details

Modulation Metrics	
FM deviation	The FM deviation reflects the amount of the frequency modulation to which the baseband signal modulates the carrier signal. The quantity being measured is the peak frequency deviation that is the maximum frequency excursion from the carrier frequency.
Carrier power	This measures the power of the carrier signal without the modulation. Ideally, power for a sinusoidal carrier signal is concentrated around its carrier frequency.

How to Set Up AM/FM Metrics

- Connect a test tone to the FieldFox SA Port 2 (Port 2)
- Press **Measure** > **Analog Demod Tune & Listen** > **Analog Demod**
- Then **Analog Demod / Tune & Listen**

NOTE

Selecting FM Wide vs. FM Narrow does not effect the displayed waveforms or metrics. But, if you are using the Audio Demod feature and listening to the demodulated waveform, then select the appropriate FM type, because the tones do differ based on the FM type selected. Refer to [Table 26-1 on page 600](#).

See also, [Chapter 9, “SA \(Spectrum Analyzer\) Mode \(Option 233–Mixed Analyzers\)”](#) and to [“Analog Demod \(Requires CPU2\)” on page 181](#).

Left display - Frequency Spectrum (Power vs. Frequency)

Right display - Demodulated waveform vs. time where **Demod SwpT** sets the width of the demod window.

- Then **Freq/Dist** > **Center** to set the carrier frequency.
- Set **Freq Span** so that all sidebands above -60 dB are displayed in the left window.
- Optionally, adjust the **AF Res BW** to better identify audio frequency side bands. Learn more, refer to [Chapter 9, “SA \(Spectrum Analyzer\) Mode \(Option 233–Mixed Analyzers\)”](#) and [“AF RBW \(Audio-Frequency Resolution BW\)” on page 196](#).
- Optionally, **FreSq/Dist** > **Tune & Listen OFF** – Opens a menu of Tune & Listen demod softkeys. Tune & Listen can be set when you are in Analog Demodulation mode, so you can enable Tune & Listen sweeps in between your Analog Demod sweeps. To learn more about the Tune & Listen softkey menu choices, refer to [“Tune & Listen \(AM/FM\)” on page 177](#).

Metrics are displayed in the **AM/FM Modulation Metrics** table on the FieldFox. For AM and FM Metrics examples, refer to [Figure 26-1 through Figure 26-8 on page 611](#).

Figure 26-1 AM Metrics - Example 1

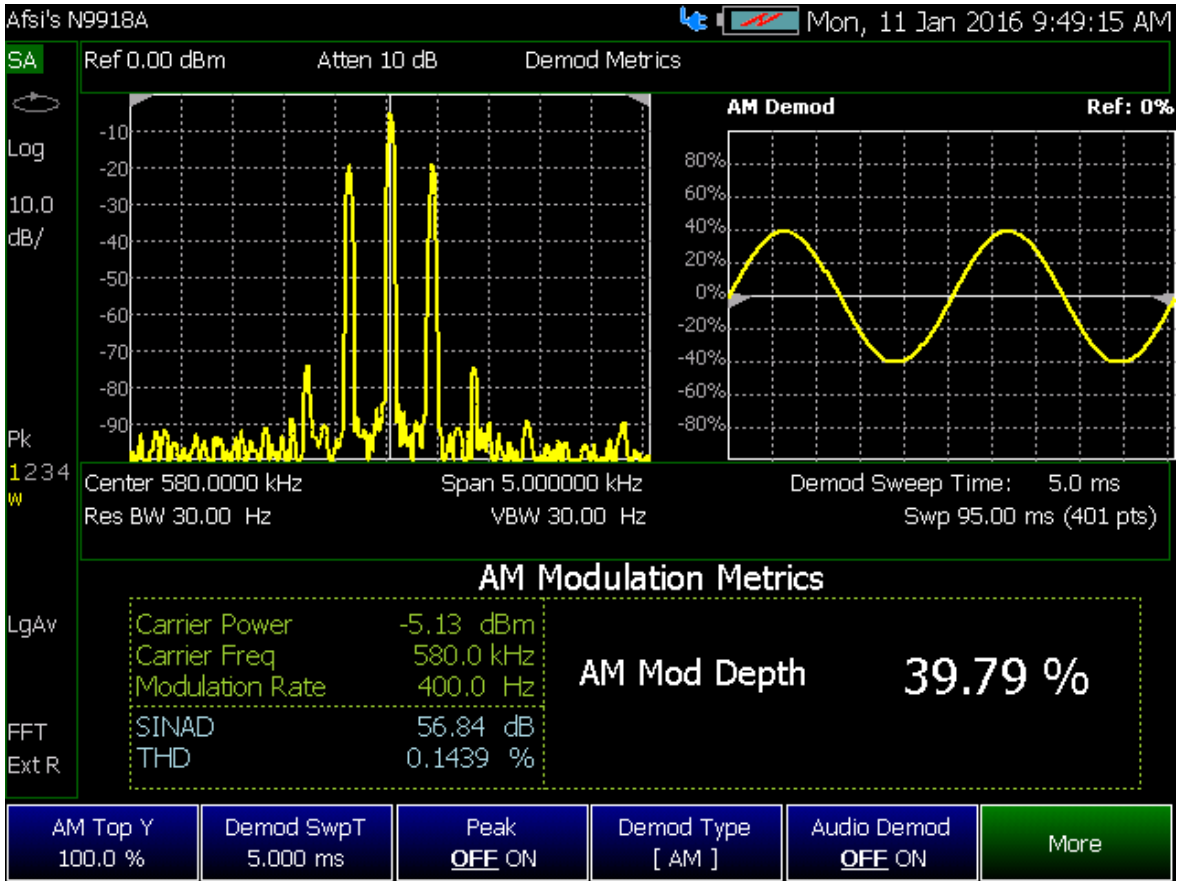

Figure 26-2 AM Metrics - Example 2

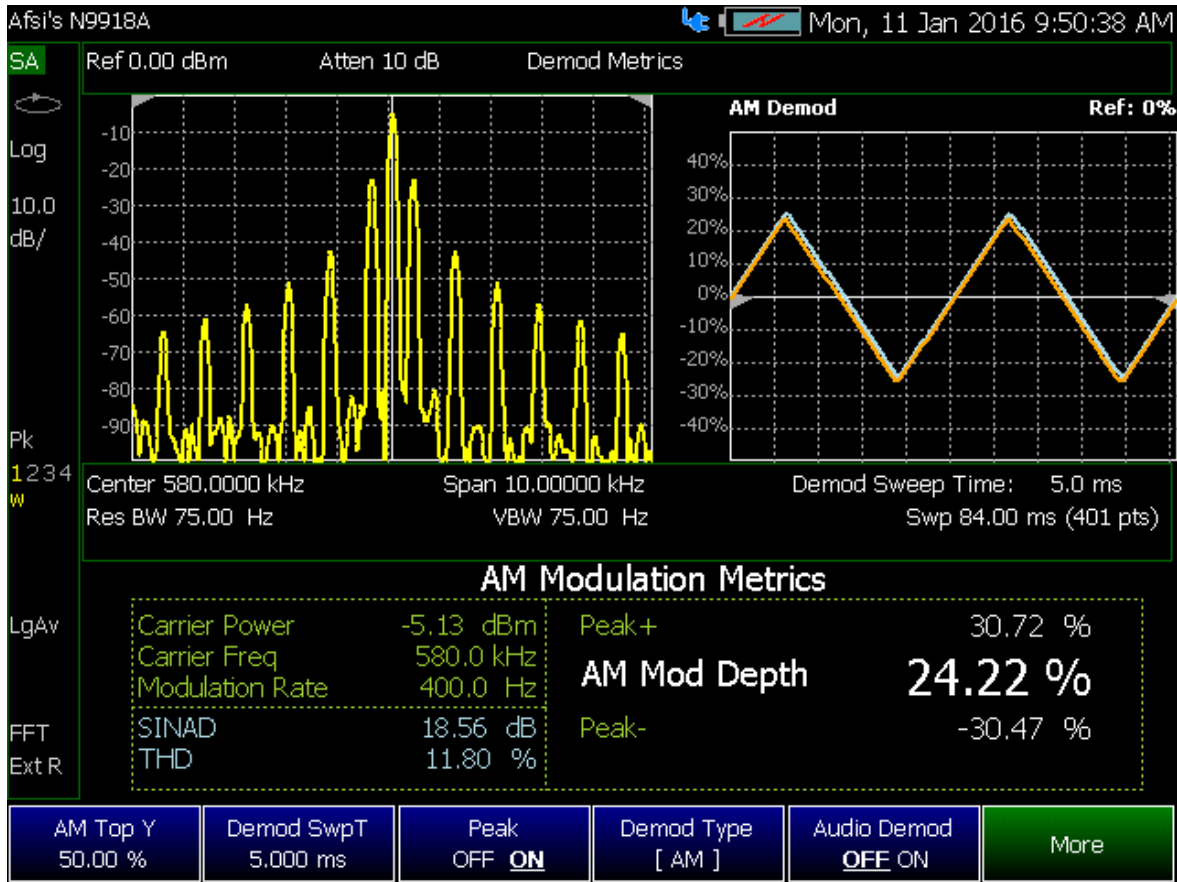
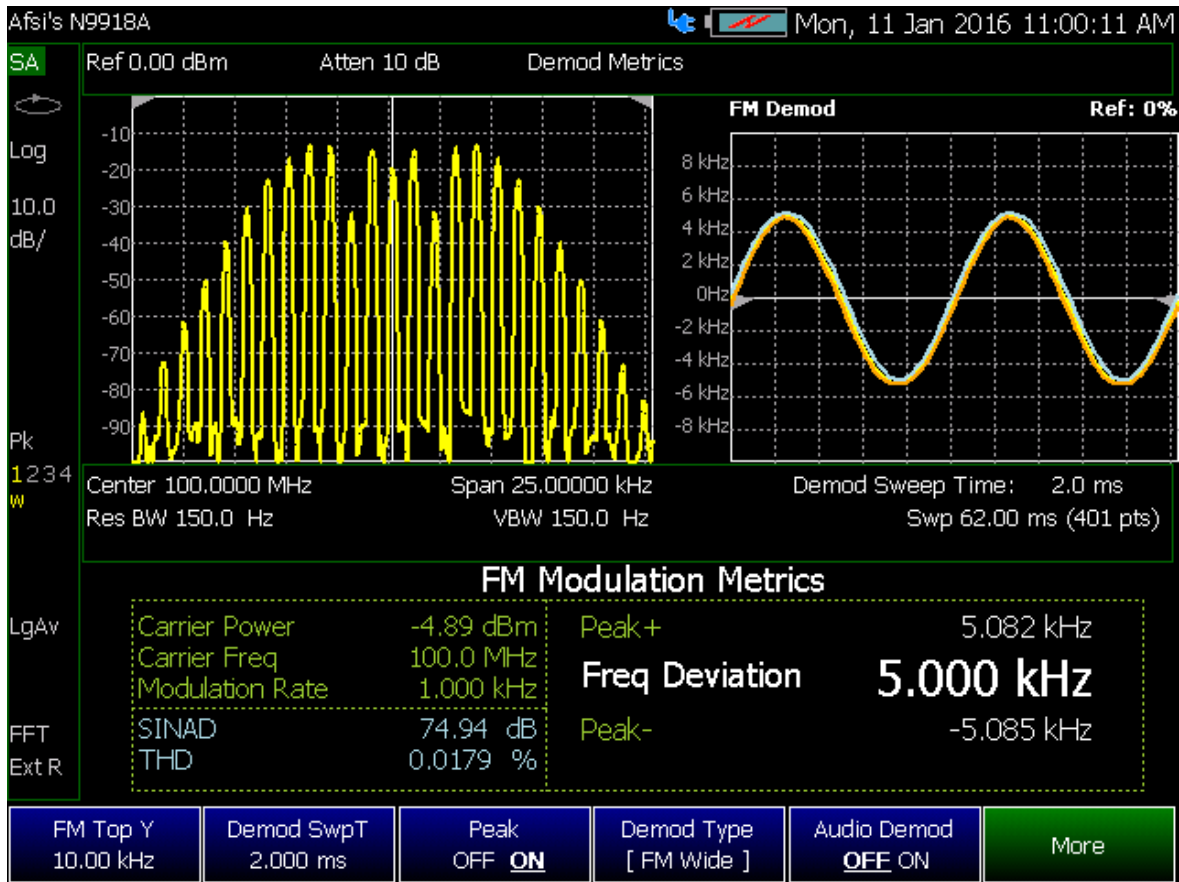

Figure 26-3 FM Metrics - Wide band Example



SINAD and THD Calculations

- FieldFox converts the audio waveform to the audio frequency spectrum using an FFT (i.e., The FFT result is not displayed). Refer to **Figure 26-4 on page 606**.
- The FFT waveform is used to calculate SINAD and THD distortion metrics
- The fundamental signal, harmonics, and noise from 0 Hz to 24 kHz are applied to the formulas. Refer to **Figure 26-5 on page 607**.
- For more on calculations, refer to “**Overview of Measurement Types**” on **page 599**.
- See also, <https://www.keysight.com/us/en/assets/7018-04493/application-notes/5991-4913.pdf>.

Figure 26-4 Audio Waveform with FFT Calculations

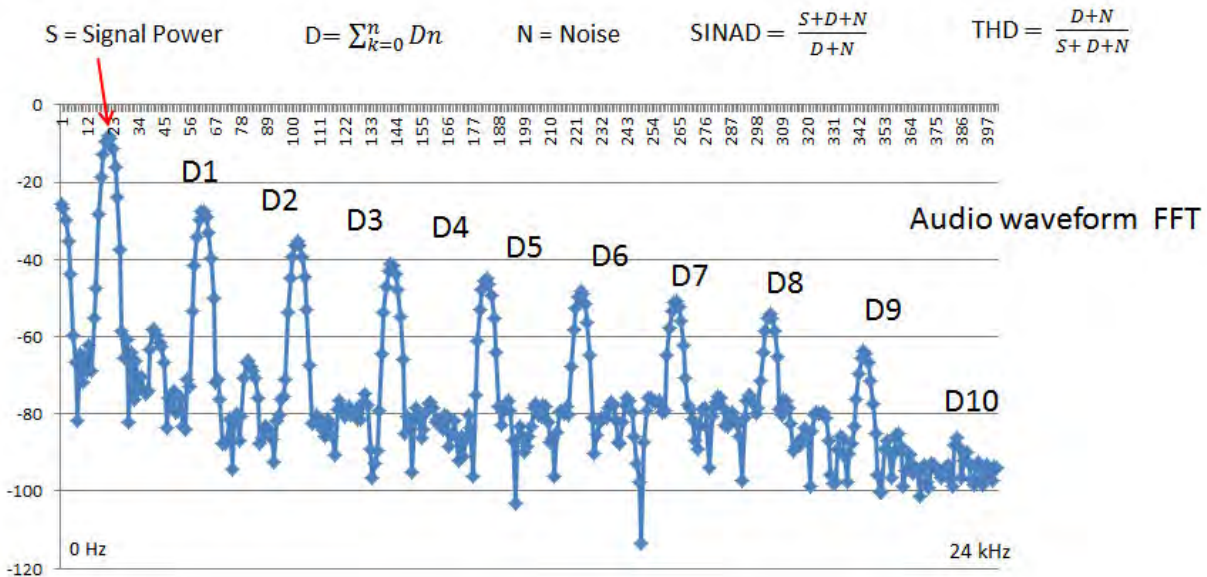

AM/FM Metrics (SA Only and Option 355)
 SINAD and THD Calculations

Figure 26-5 SINAD and THD Results - Example 1

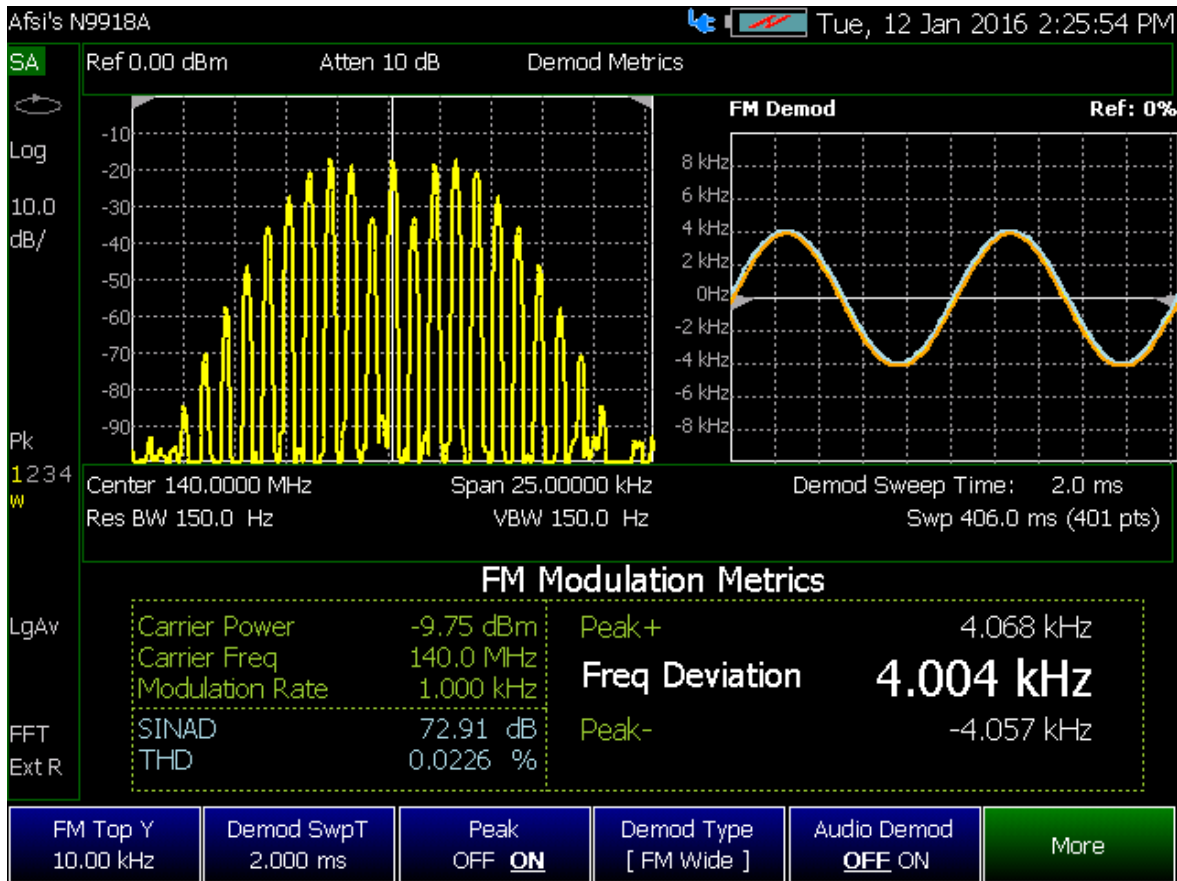
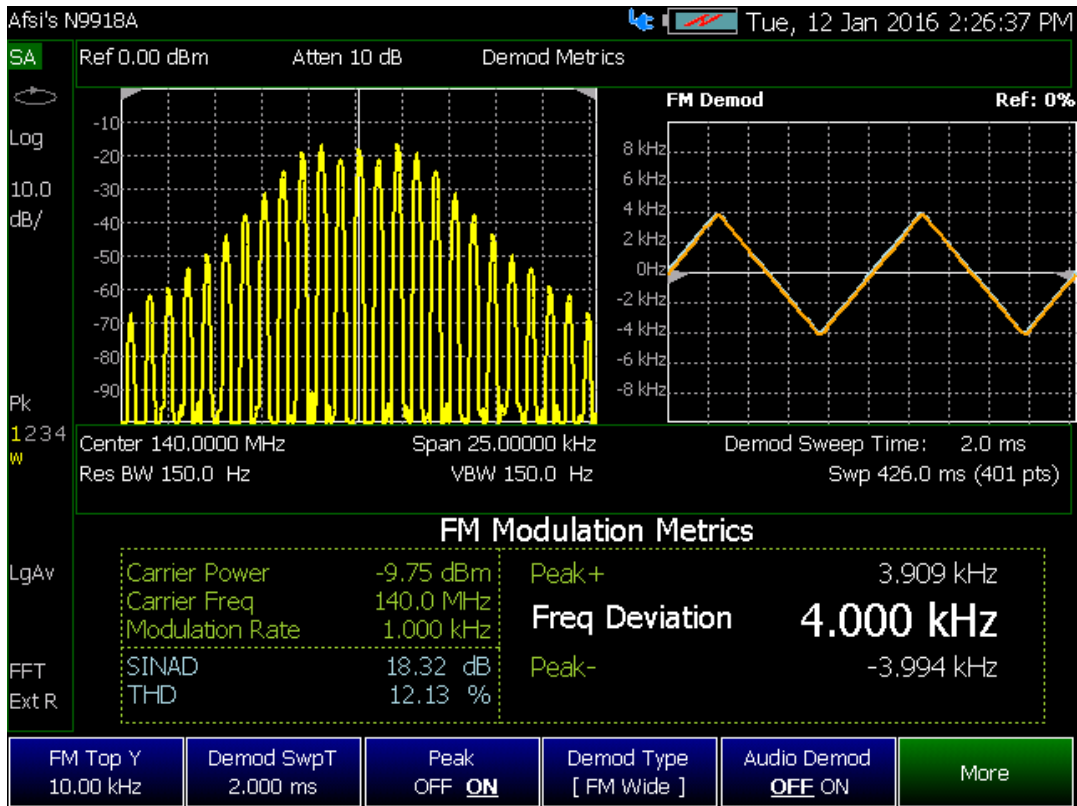

Figure 26-6 SINAD and THD Results - Example 2



Interpreting AM/FM Metrics Error Messages

This section discusses possible AM/FM Metrics error messages and how to correct them.

Test Tone Not Found

A Test Tone Not Found message is displayed under the following circumstances:

- FieldFox frequency span is too wide
- No side lobes are displayed in the results

Refer to the examples in **“Test Tone Not Found - Example” on page 610** and **“Test Tone Not Found - Corrected Example” on page 611**.

Test Tone Not Found - Example

The following response had the following settings:

- Source CF: 140 MHz
- FM Deviation: 18 kHz
- Modulation Rate: 1 kHz

Reasons for error:

- Frequency span of 1.0 MHz is too wide
- No side lobes displayed, so test tone not found

Figure 26-7

Test Tone Not Found - Example

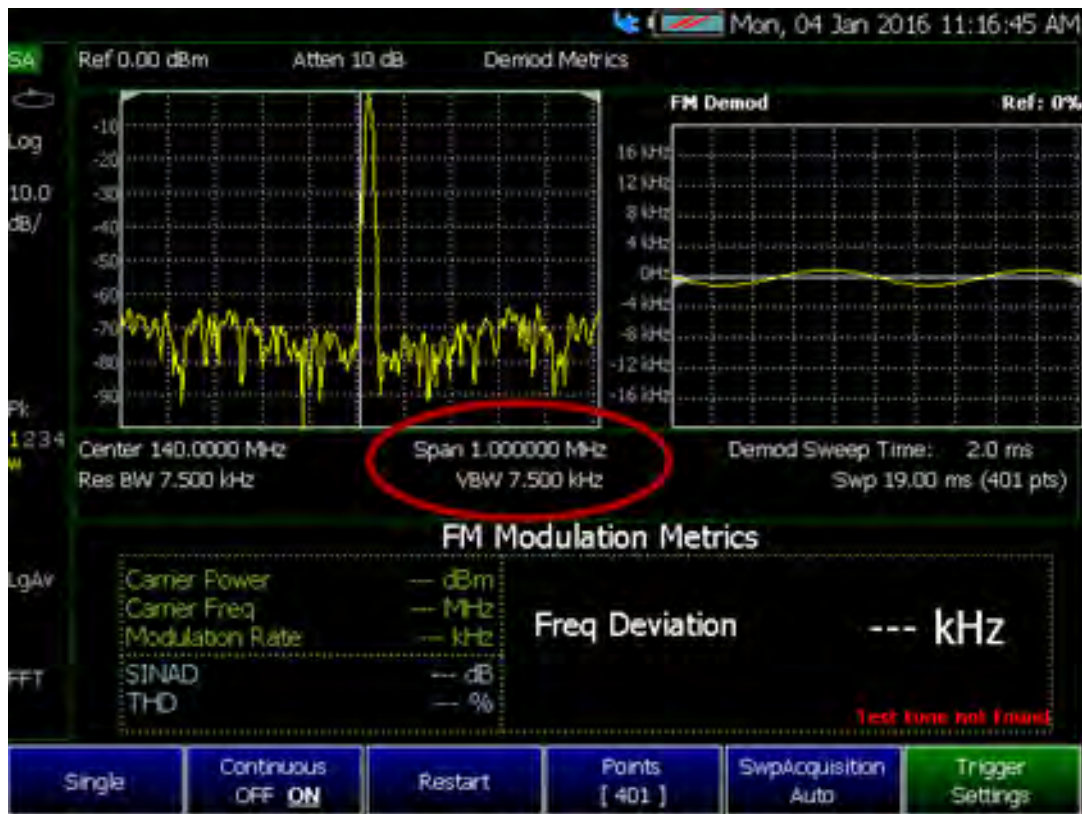

Test Tone Not Found - Corrected Example

The following response was corrected with these setting changes:

- Frequency set to narrower frequency span of 50 kHz
- Ideally the frequency span should show the modulation envelope down to -60 dB below the RF power level

Response corrected, because:

- Narrowing the frequency span enables the modulation envelope's side lobes to be identified
- FM algorithm identifies the side lobes
- The algorithm matches the modulation envelope to the mathematically calculated FM modulation or distortion patterns

Figure 26-8 Test Tone Not Found - Corrected Example

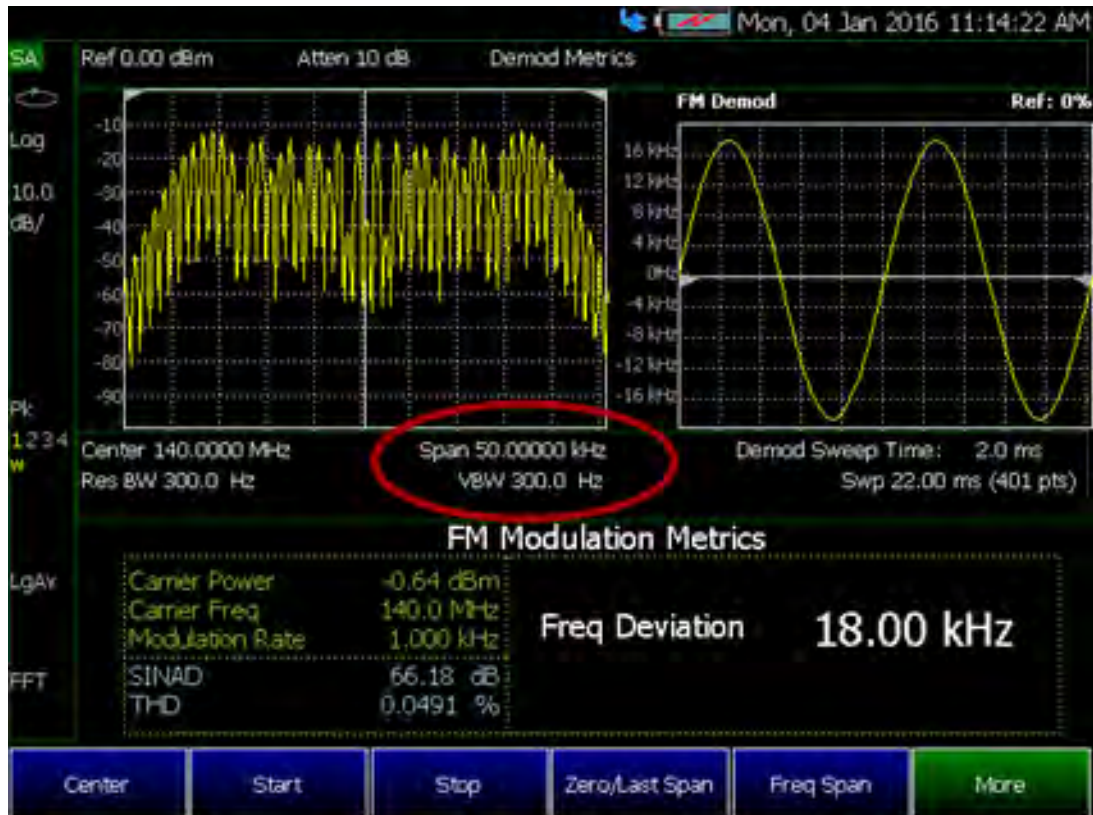

AM/FM Metrics (SA Only and Option 355)
Interpreting AM/FM Metrics Error Messages

27 Channel Scanner (Option 312)

In this Chapter:

- “Using Channel Scanner” on page 614
- “How to Set Up Channel Scanner” on page 615
 - “Field Strength Measurements” on page 632
 - “Using the Antenna/Cable Editor” on page 638
 - “Using Mapping” on page 640

See Also

- “Why and When to Calibrate” on page 134
- Chapter 16, “Indoor and Outdoor Mapping – Option 352 (Requires Spectrum Analyzer Mode (Option 233 on N991xA), and GPS Receiver (Option 307)).”
- Chapter 30, “System Settings.” (Changing display colors)
- Chapter 32, “File Management.”

Using Channel Scanner

Channel Scanner enables you to do the following:

Measure and display channel power vs. frequency for up to 20 channels simultaneously.	
Six Display Types:	
– Bar graph vertical display orientation	– Strip Chart
– Bar graph horizontal display orientation	– Strip Chart and Overlay
– Channel Power	– Scan & Listen
Color Coded Display Types:	
– Specify high and low power with color bars	
Flexible Data Sorting:	
– Sort results displayed by power or frequency, low to high, or high to low	
Data Logging. Record GPS stamped data measurements	
– Define measurement interval by time or distance	– Replay files on Google Maps or Google Earth
– Show results in spectrogram	

Figure 27-1

Display Example: Measure 5 Channels Spaced 2 MHz Apart

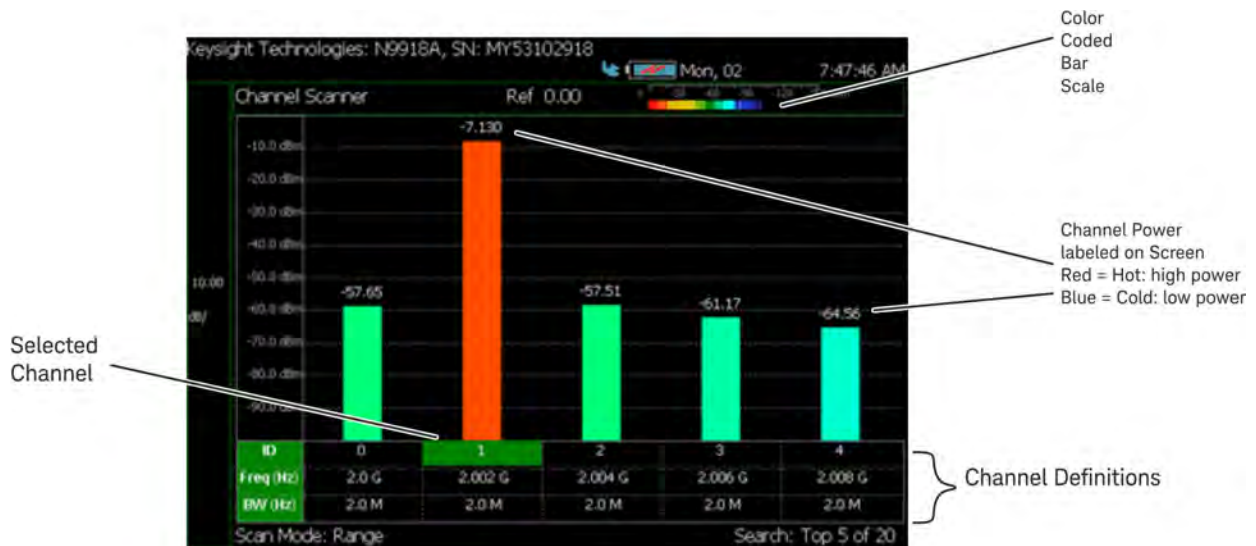

How to Set Up Channel Scanner

This section briefly reviews the steps in setting up a channel scan measurement. If you are not familiar with this process or would like more information, refer to “[How to Define a Channel and Use Channel Scanner](#)”.

1. Define some channels (refer to “[How to Define a Channel and Use Channel Scanner](#)”).
 - a. Select a **Scan Mode**—choose:
 - **Range** Specify total channels, channel spacing or
 - **Custom List** Specify a list of channels from an editor
 - b. Then modify channels based on the selected scan mode
2. Select **Display Type**—choose:
 - **Bar ChartV** or
 - **Bar ChartH** or
 - **Channel Pow** or
 - **Strip Chart** or
 - **Chart Overlay** or
 - **Scan&Listen**
3. Modify scale and specify color bar coding—Modify the scale and assign colors to low and high power channels (bars):

Press **Scale/Amptd**

Then one of the following:

 - **Red Limit** to set the power level and color scale for high power channels.
 - **Blue Limit** to set the power level and color scale for low power channels.
 - Others: **Scale**, **Ref Level**, **RF Atten**, etcetera as desired.
4. Enable **Data Logging** Settings: Press **Measure 1** or **Trace 6** > **Data Logging** to view the Data Logging softkeys and set the **Record Settings**, **Record Save/Recall**, and **Indoor Map Data Logging**.
 - **Record** (Outdoor Logging) or
 - **Play** (If you have previously stored data recordings.) or
 - **View** (Option 312 only)
 - a. To set the **Record Settings** (Outdoor Mapping only)—then choose:
 - **Meas Interval**

- **Interval Type** Time or Distance
 - **Time Interval** or
 - **Distance Interval**
 - Then **Back**
- b. Then press **Record Save/Recall**
- Then **File Folder Default System**
 - **Default** - Sets the default User Folder path:
 - List files (*.csv and *.kml) are save-recalled to:
"[CurrentDevice]:\RecordPlayback\
CS\"
 - Data Log-Play files are save-recalled to:
"[CurrentDevice]:\RecordPlayback\
CS\"
 - Or
 - **System** - Sets the User Folder to the user defined system folder path/name:
 - List files are save to-from
"CurrentDevice\<<UserSelectedFolder>\"
 - Data Log-Play files are save-recalled to:
"CurrentDevice\<<UserSelectedFolder>\"
- Refer to **"File Management" on page 767.**
- Then **File Type**
 - KML (default) or
 - CSV
 - Then **Save Log File.**
 - or
 - Then Recall Log File.
 - **Auto Save (default = OFF)**
 - Then **Back**
- c. Optional: Press **Indoor Map Data Logging** then

- **Record Indoor Data** or **Recall Indoor Log File**. Learn more, refer to **Chapter 16 Mapping** and **“Option 352 Indoor Maps Setup Procedure”** on page 463 and **“Setting up Data Logging”** on page 475.
 - d. Optional: Press **Signal Locate** – Opens a softkey menu of directional finding (DF) bearing softkeys. Learn more, refer to **Chapter 16 Mapping** and **“How to Add Directional Finding (DF) Bearing”** on page 485.
5. Press **Back** to return to previous menu.
6. Outdoor Mapping only: If recording, then:
- **View Map OFF ON** To enable/disable the current map view (default = latitude/longitude = 0.00/00. Need GPS to view current location (default = OFF).
 - **Pause Resume** Temporarily halts recording until pressed again. The incoming trace continues to sweep. Press again to continue recording.
 - **Stop** Immediately stops recording and a “Save the Log File” menu opens to rename and save your data log file.
 - (Press **Record** to begin a new recording.)
 - Then **Maps** To enable map view and related features (e.g., Data Selection, Red/Blue Limits, Labels & Icons, Zoom).
 - **Data Selection** Opens a softkey menu to set the active data channel, sort type, and sort order.

Learn more, refer to **Chapter 16 Mapping** and **“Setting up Data Logging”** on page 475. See also, **Chapter 32, “File Management.”**
 - **Red/Blue Limits** Opens a softkey menu to assign power values to the red (high power limits) and blue (low power limits) heat map display limits (defaults: Red Limit = -20 dBm, Blue limit = -90 dBm).
 - **Labels & Icons** Opens a softkey menu to enable/disable map data point labels and icon types.

Labels OFF ON	Enables/Disables map data point labels. When enabled, a label is displayed for every map data point (e.g., “Data 1”). When disabled, labels are not displayed for the map data points.
Icons Flag Point Line	Sets the type of icon that is used to display a map’s data points (default = Flag).

- **Save Image (PNG)** Saves the current displayed map to a *.png file (default filename is “MapImageFile”).

NOTE

Data Log-Play files are saved to:

- If File Folder is set to Default then Data Log-Play files are save-recalled to: “[CurrentDevice]\RecordPlayback\CS”
- If File Folders are set to System, then Data Log-Play files are save-recalled to: “CurrentDevice\<UserSelectedFolder>\

7. Outdoor Mapping: Export KML file into 3rd party mapping software (i.e., Google or Google Earth)

Learn more, refer to [Chapter 16 Mapping](#) and [“Setting up Data Logging” on page 475](#). See also, [Chapter 32, “File Management.”](#)

How to Define a Channel and Use Channel Scanner

Channel definitions consist of the following:

- Each channel is defined by CF and Integration BW.
- Frequency span is set automatically to 1.5 x Integration BW
- Power is measured over the Integration BW

Using Channel Scanner, refer to:

- [“Step 1A: Scan Mode: Range Channel Defined” on page 619](#) or
- [“Step 1B: Scan Mode: Custom List Channel Defined” on page 620](#)

Then:

- [“Step 2: Select Display Type” on page 621](#)
- [“Step 3. Modify Scale and the Display Color Bar Settings” on page 625](#)
- [“Step 4: Enable Data Logging and Record Results” on page 626](#)
- [“Step 5: Save the Log Results:” on page 629](#)
- [“Step 6: Import and Play back KML Files into 3rd Party Software \(Example: Google Earth with Animation Tool\)” on page 631](#)

Figure 27-2 Channel Definition



Step 1A: Scan Mode: Range Channel Defined

1. Define some channels: Press **Measure** > **Scan Mode** > **Range**
2. Press **Edit Range** and modify table items:
 - Total Channels
 - Search Count
 - Start Channel CF
 - CF Step Size

Figure 27-3 Range Table Settings



3. Press **Done**

Step 1B: Scan Mode: Custom List Channel Defined

1. Define some channels: Press **Measure** > **Scan Mode** > **Custom List**
2. Press **Edit Custom List** and modify table items:
 - Add table rows
 - Then for each row:
 - Edit Center Frequency (CF)
 - Edit Integration BW (IBW)

Figure 27-4 Custom List Table Settings

Use knob. Press [Edit] to make changes. Press [Done] to exit. Page 1/1

ID	CF	BW
Chan	Center	Integration BW
1	93.700000 MHz	100.000 kHz
1	100.100000 MHz	100.000 kHz
2	97.300000 MHz	100.000 kHz
3	99.700000 MHz	100.000 kHz
4	96.500000 MHz	100.000 kHz

Edit Next Page Previous Page Add Row Delete/Clear Done

3. Press **Done**
4. Press **Save Recall List** > **Save List** to save a custom list. See also “How to use the FieldFox labeler” on page 770.

NOTE

Press **Recall List** to bring back a previously stored custom list

Step 2: Select Display Type

Select one of the following display orientations:

- Select **Display Type**—choose:
 - **Bar ChartV** or
 - **Bar ChartH** or
 - **Channel Pow** or
 - **Strip Chart** or
 - **Chart Overlay** or
 - **Scan&Listen**

Figure 27-5 Bar Chart Vertical Display Type



Figure 27-6 Bar Chart Horizontal Display Type



Figure 27-7 Channel Power Display Type

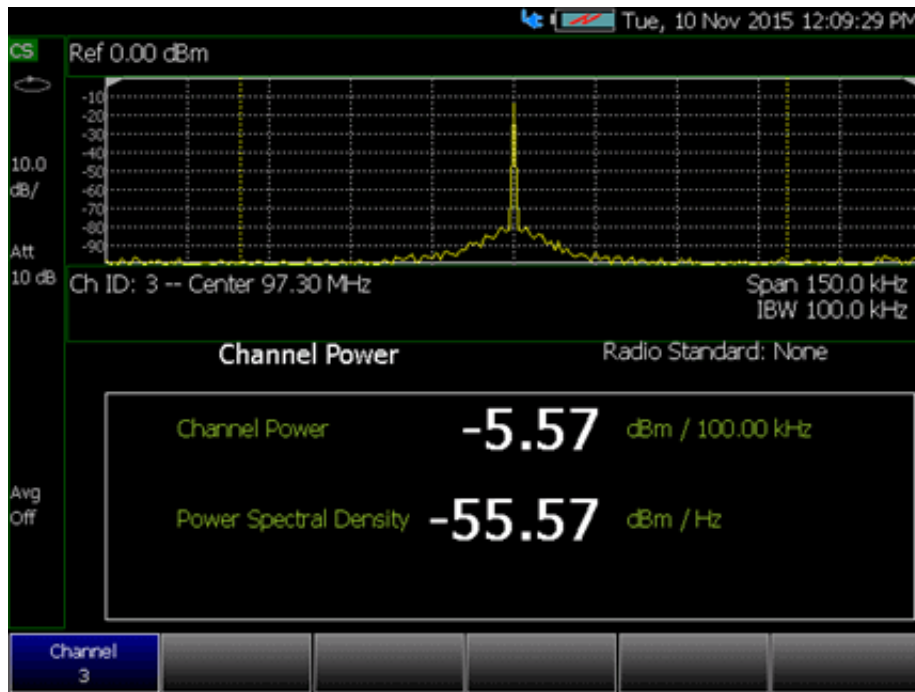

Figure 27-8 Strip Chart Display Type



Figure 27-9 Strip Chart Overlay Display Type



Figure 27-10 Scan & Listen Display Type

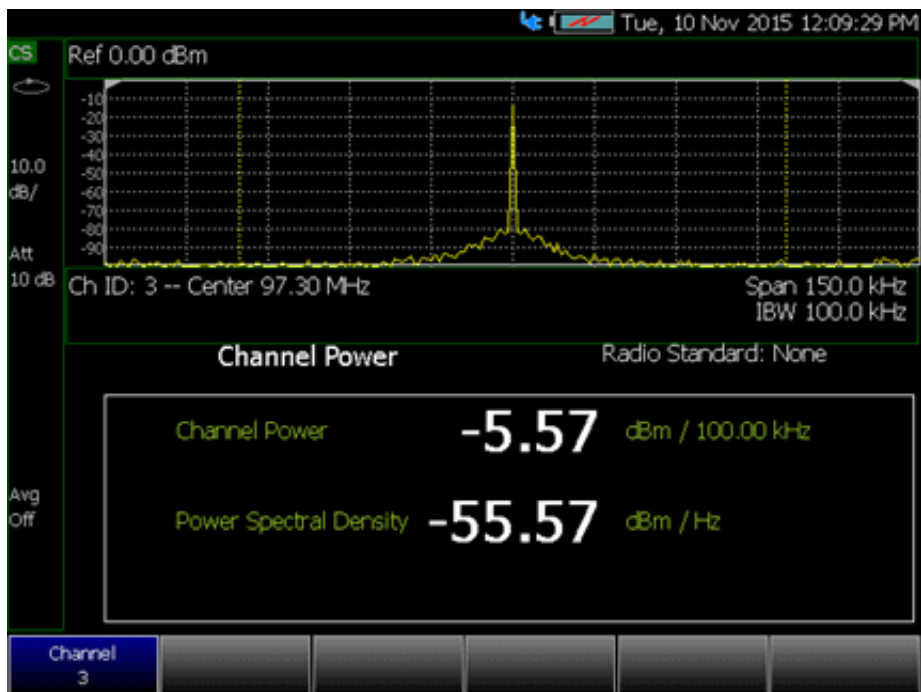

Step 3. Modify Scale and the Display Color Bar Settings

To assign colors to low and high power values:

1. Press **Scale/Amptd** > **Red Limit** to set high power values and to set the color.
2. Press **Blue Limit** to set low power values and to set the color.
3. And, then press **System** > **Display** > **Display Colors**, to set Indoor, Outdoor, or other display colors. See also [Chapter 27, "Channel Scanner \(Option 312\)", on page 613](#).

Figure 27-11 Outdoor Display Colors

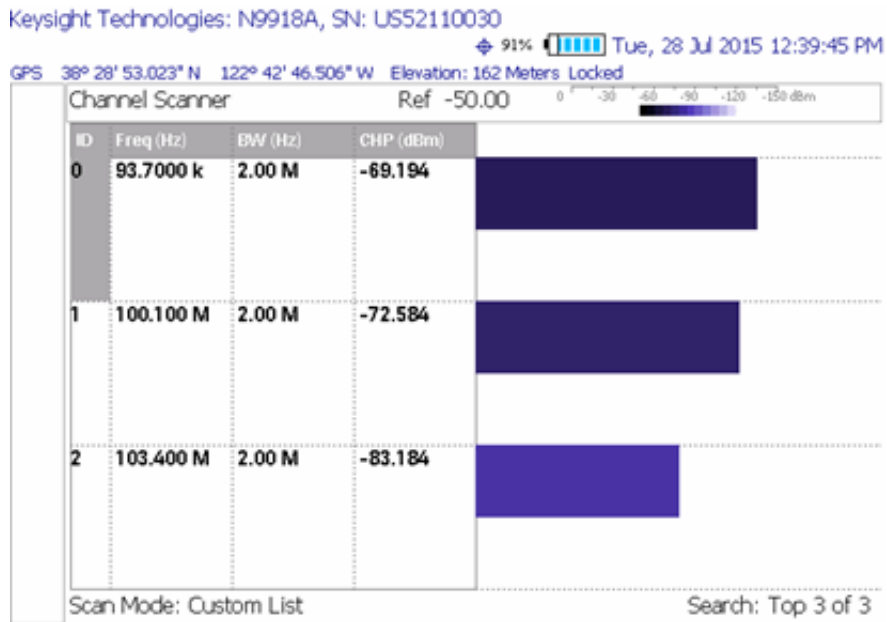
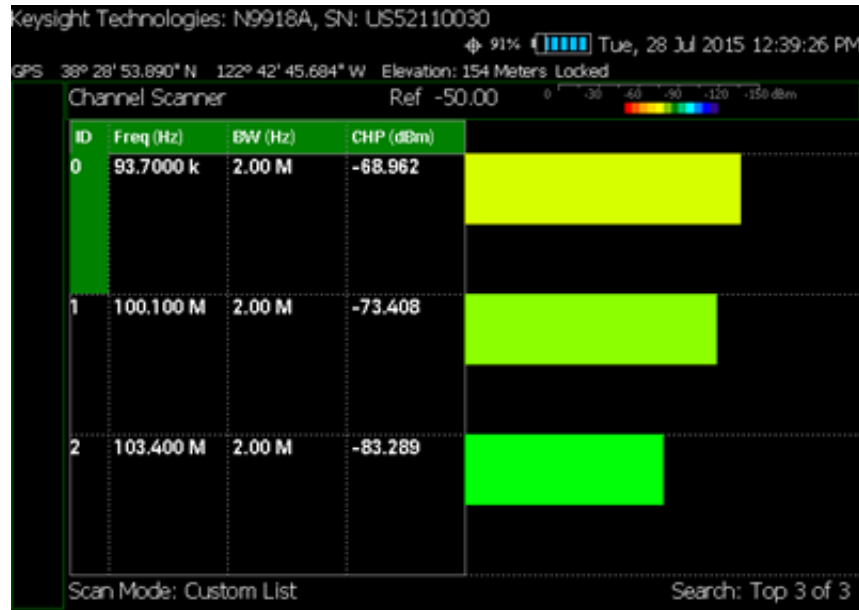

Figure 27-12 Indoor Display Colors



Step 4: Enable Data Logging and Record Results

Data logging records your data with a timestamp and GPS stamp (refer to **“GNSS (GPS+) and GPS”** on page 749). GPS must be enabled for the log results to include a GPS stamp.

Features

- Log files contain measured channel results including timestamps and/or distance stamps.
 - Timestamps are included in log files with or without GPS.
 - GPS must be enabled for log results to include distance stamps.
- Data results can be logged
- Data results can be saved to a *.CSV or *.KML file. Refer to **“Step 5: Save the Log Results:”** on page 629.
- User specifies how often results are stored.
 - Time: Store results every “n” seconds
 - Distance: Store results every “n” meters. GPS must be enabled to store results by distance.

Outdoor Mapping Procedure

For Indoor Mapping and more on Outdoor Mapping, see also [Chapter 16 Mapping](#) and [“Option 352 Indoor Maps Setup Procedure” on page 463](#), [“Option 352 Outdoor Maps Setup Procedure” on page 467](#), and [“Setting up Data Logging” on page 475](#). See also, [Chapter 32, “File Management.”](#)

1. Press **Measure 1** or **Trace 6** > **Data Logging**
2. **Outdoor Mapping Only:** Press **Record Settings** then:
 - **Meas Interval OFF ON** (default = OFF) - set to ON
 - **Interval Type Time Distance** (default = Time) - choose a setting
 - **Time Interval** 1 sec to 3,600 seconds or
 - **Distance Interval** from 1m to 10 km
 - When done, press **Back**
3. Press **Record Save/Recall** then:
 - **Recall Log File**
 - **File Folder Default System** - (default = Default).
 - **File Type** - CSV or KLM
 - **Auto Save OFF ON** - (default = OFF). Press to enable/disable.
 - then **Back**

Learn more, see [“How to Set Up Channel Scanner” on page 615](#), step b.

4. To begin outdoor logging recording: Press **Record**

If Auto Save is On (default = OFF) Measurements are stored automatically accorded to the specified time or distance interval values. Refer to step 5.
5. Optional: **Auto Save OFF** (default)–When Auto Save is on, during recording, the FieldFox stores intermediate results in a temporary file. If the power fails during recording you can retrieve the results. Select **Recall Log File**. Select the temporary file name.

Press **Record Save/Recall** > **Auto Save On Off**
6. When done press **Stop** or **Esc**. The files save dialog is displayed. Edit the file name where the file results will be stored.
7. Press **Done**

Learn more, refer to [Chapter 16 Mapping](#) and [“Option 352 Outdoor Maps Setup Procedure” on page 467](#) and [“Setting up Data Logging” on page 475](#). See also, [Chapter 32, “File Management.”](#)

Playing a Data Log and Viewing the Spectrogram

To play the log results:

Refer to **Figure 27-13 on page 629**.

1. Press **Data Logging** > **Play**
2. Then choose:
 - Optional: Use the RPG (fine adjust) or the arrow keys (coarse adjust) to change the color bar.
See also, **“How to Set Up Channel Scanner” on page 615**.
3. Press **Stop** or **Esc** to exit the log recording.

To pause the log play:

1. Optional: Press **Pause Resume** to pause or resume the log recording.
2. Then choose:
 - Optional: Use the RPG (fine adjust) or the arrow keys (coarse adjust) to change the color bar.
 - **Cursor Position** to change the position along the time record's results to change the position along the time record's results (i.e., **Cursor Position** is active only when playback is paused).
 - **Maps** > **Red/Blue Limits** then
 - Red Limit** to change the color bar.
 - Blue Limit** to change the color bar.
3. Press **Stop** or **Esc** to stop the log recording.

To View the spectrogram of recorded results:

1. Press **View** (Applies to Option 312 Only)
2. Then choose:
 - **Zoom** to zoom in on spectrogram time record results.
 - **Red Limit** to change the color bar.
 - **Blue Limit** to change the color bar.
3. Press **Exit** or **Esc** to exit view.

Figure 27-13 Spectrogram View

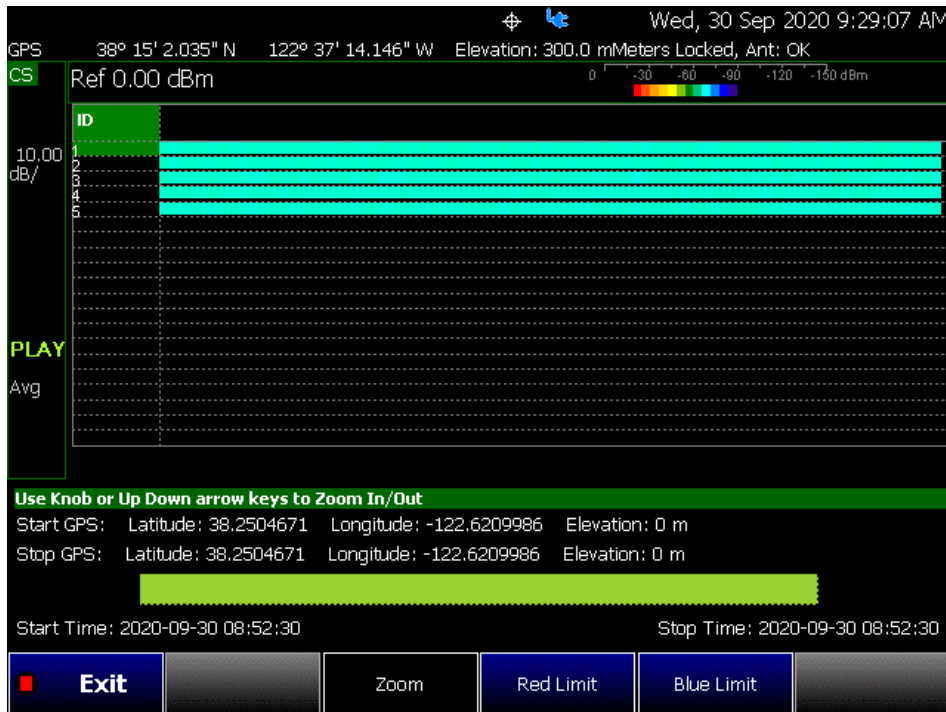

Step 5: Save the Log Results:

Two file types are supported for save or recall log results:

- KML file format
 - Files include bar color
 - Files stored in this format can be imported into 3rd party applications like Google Earth or Google Maps.
- CSV file format. Files stored into this format can be imported into spreadsheet applications.

1. Press **Record Save/Recall** > **File Type** CSV or KLM > **Back**

2. To begin recording: Press **Record**

Measurements are stored automatically according to the specified time or distance interval values.

3. When done press **Stop**. The files save dialog is displayed. Edit the file name where the file results will be stored.

4. Press **Done**

- Optional: **Auto Save** ON (OFF = default)—When Auto Save is on, during recording, the FieldFox stores intermediate results in a temporary file. If the power fails during recording you can retrieve the results. Select **Recall Log File**. Select the temporary file name.

Press **Record Settings** > **Auto Save On Off**

Optional Step: Indoor Map Data Logging

Once you have selected a channel to measure, you can record data logging using Indoor Mapping. Refer to “**Step 1A: Scan Mode: Range Channel Defined**” on page 619.

Learn more, see “**How to Set Up Channel Scanner**” on page 615, step 4.

- Press **Measure 1** > **Data Logging** > **More** then
- Press **Indoor Map Data Logging** then
 - **Record Indoor Data** (new indoor mapping file (*.png)) or **Recall Indoor Log File** (recall a previously stored *.kdat, to modify). Learn more, refer to **Chapter 16 Mapping** and “**Option 352 Indoor Maps Setup Procedure**” on page 463 and “**Setting up Data Logging**” on page 475.
- Measurements are displayed on the current indoor map in the specified intervals.
 - Use **More** > **Data Selection** softkey menu to select the **Channel** displayed, the **Sort Power Freq**, and the **Sort Order Up Down**. Then **Back**.
 - Use the **Labels & Icons** softkey menu to select **Labels OFF ON**, **Icons Flag Point Line**, and **Pointer OFF ON**. Then **Back**.
Learn more, refer to **Chapter 16 Mapping** and to “**Enabling and Setting Up Indoor Map Logging**” on page 478.
Use the **Labels & Icons**, **RPG [Zoom]** settings, **Save Map**, and **Save Image (PNG)**.
 - Use the **PAN** softkey menu to change locations on the indoor map.
- To begin recording (add a data point): Press **Record Data**.
- Optional: Set **Bearing Line**, refer to “**Enabling and Setting Up Indoor Map Logging**” on page 478.
- Repeat steps 4 and 5 as necessary.
- When done press **Back** or **Esc**. The files save dialog is displayed. Edit the file name where the file results will be stored as a *.kdat file.

8. Press **Done**

Learn more, refer to **Chapter 16** Mapping and **“Setting up Data Logging”** on **page 475**. See also, **Chapter 32, “File Management.”**

Step 6: Import and Play back KML Files into 3rd Party Software (Example: Google Earth with Animation Tool)

Features

Use the Playback Slider to replay measurement results. See also Google Maps and or Google Earth’s help.

- Open the FieldFox *.KML file in Google Earth. Time Slider appears in upper left of the map.
- Manual Mode – Move the time slider cursor to see color-coded icons pop-up according to the timestamp.
- Loop mode has a Fast-Slow Replay Option.
- Click on each color coded balloon to see the table of measurement results for that location.

Figure 27-14 Importing a KML File Into Google Earth

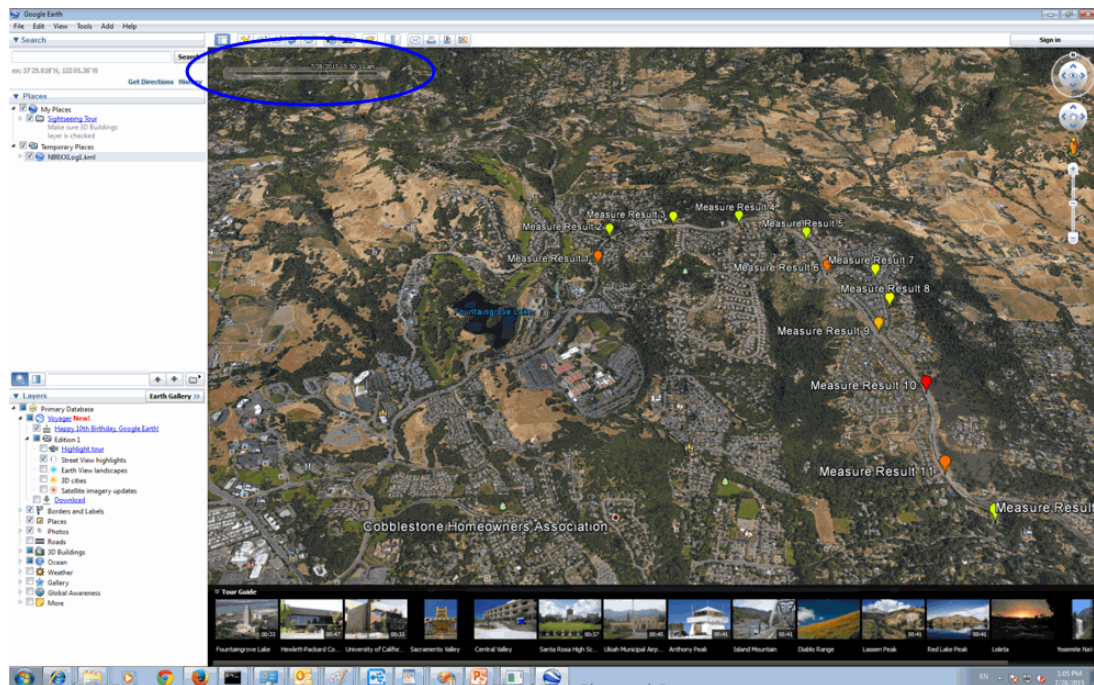

Field Strength Measurements

To measure the strength of any signal transmitted through the air, an antenna must be connected to the FieldFox. The Field Strength feature allows you to enter the frequency response of the receiving antenna (the Antenna Factor) and associated cabling, and then have amplitude corrections automatically compensate the displayed trace for that response.

Figure 27-15 Overview of Field Strength for Channel Scanner (See also, [Figure 27-16 on page 633.](#))



FieldFox Field Strength Channel Scanner

Refer to [Figure 27-16 on page 633](#)

Figure 27-16 Editing Antenna Factor Units (See also, [Figure 27-15 on page 632.](#))



Figure 27-17 Yellow Trace with Cable and Antenna Corrections



Yellow trace: Cable correction, which is the sum of the antenna correction and the cable correction (These corrections are linearly interpolated).

Field Strength Measurements

Yellow Trace - Corrected trace with antenna factor. This correction, includes the sum of the antenna correction and the cable correction (These corrections are linearly interpolated). (Antenna = ON, Apply Corr = ON). Refer to **Figure 27-17 on page 634**.

For information, refer to **“Trace Display States (SA Mode)” on page 208**

- Learn how to set Y-Axis **Units** on **“How to Set Y-axis Units” on page 169**.
- Use a Band Power marker to measure total power over a range of frequencies. Learn how in **“Band/Interval Power Marker” on page 221**

How to select and edit corrections for Field Strength measurements

The Antenna and Cable correction data survives a Mode Preset and Preset.

All Correction ON/OFF states survive a Mode Preset, but NOT a Preset.

- Press **Scale/Amptd**.
- Then **More**
- Then **Corrections**
- Then choose from the following:
 - **Apply Corrections Auto Disabled** Use Auto and Disabled correction for all settings.
 - **RcvrSide Antenna Off / On** Edit/Recall an Antenna file to be used on the receiver side.
 - **RcvrSide Cable Off / On** Edit/Recall a Cable file to be used on the Receiver side.

- **View Corrections** > **View Corrections ON OFF** Turn ON and OFF Yellow Trace - Antenna/Cable corrections. This is a composite of all cable/antenna corrections that are currently applied. Available as a useful visual aid, the zero “dB” level (no net correction) is mapped to appear at the -50 dBm on-screen level.

The following menu appears when any of the above Antenna or Cable softkeys are pressed:

- **Antenna/Cable ON OFF** Turn correction ON or OFF for this Antenna/Cable.
- **Edit Antenna/Cable** Edit an Antenna/Cable Correction table. See Using the Antenna/Cable Editor (below) for more information.
- **New** Create a new Antenna/Cable. See Using the Antenna/Cable Editor (below) for more information.
- **Save Antenna/Cable** Save the modified Antenna/Cable to a file on the specified Storage Device.
- **Recall Antenna/Cable** Read an existing Antenna/Cable file from the specified Storage Device.
- **Storage Device** Choose from: Internal, USB, SD. Learn more about these selections in **“Set File Type and Select Device” on page 773**.

When finished, press **Back** to return to the previous menu.

Field Strength Correction Examples

Refer to **Figure 27-18 on page 636** and **Figure 27-19 on page 637**.

Figure 27-18 Apply Corrections Set to Auto



Figure 27-19 Apply Corrections Set to Disabled

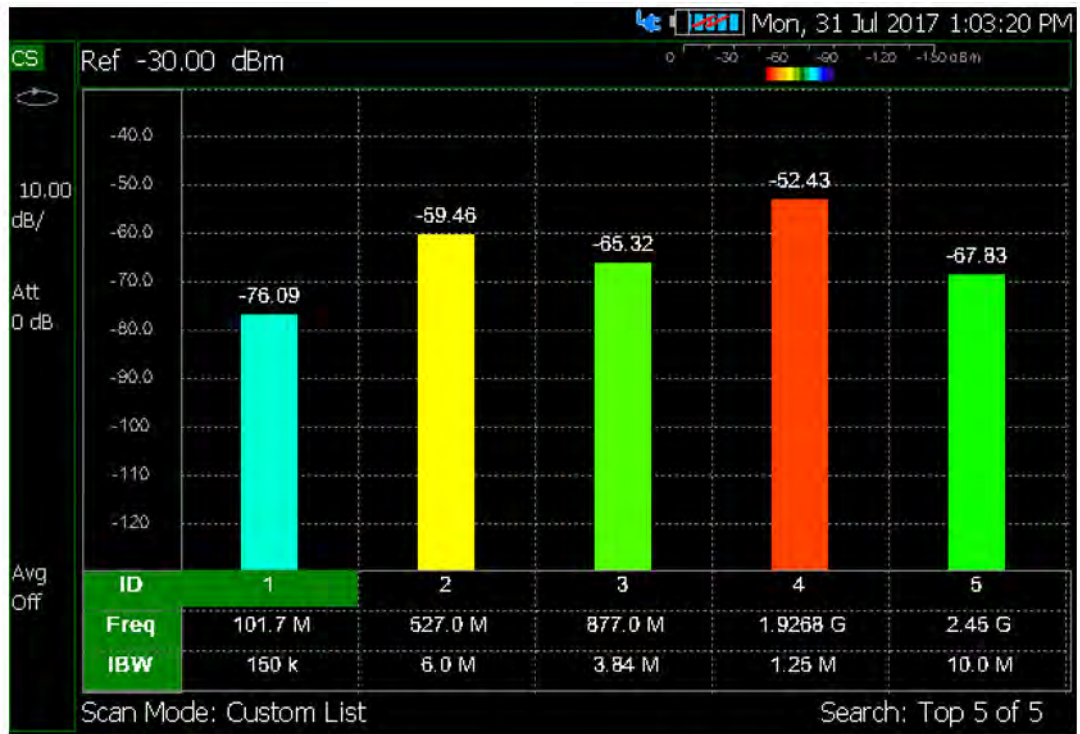

Using the Antenna/Cable Editor

The Antenna Editor and the Cable Editor menus are very similar. Both tables include header information, and a Frequency/Value table.

Figure 27-20 FieldFox Antenna Editor

Setting	Value
Description	Correction Fact
Freq Interpolation	LIN
Antenna Factor Unit	dB S/m
Frequency	Antenna Factor
26.00000000 MHz	20.000 dB S/m
30.00000000 MHz	17.500 dB S/m

How to use the Antenna/Cable Editor

- Press **New** then **Yes** to clear all data from the existing Antenna or Cable table and reset header information to default settings.
- Then **Edit Antenna** or **Edit Cable** to open the Antenna / Cable Editor.
- Then use the **▲▼** arrows to select a field.
 - To edit header information, press **Edit** then modify the selected field using the FieldFox labeler.
 - **Description**: Enter a description for the antenna or cable correction table. This is NOT the filename used to save the file.
 - **Antenna Factor Unit (Rcvr-side Antennas only)**: Units in which the measurement will be displayed. Select **NONE** (default setting) to select from standard Channel Scanner Units on the Scale menu. Learn how in **“Scale and Units” on page 168**.
 - Choose from: **dB μ V/m** - (dB micro Volts per meter), **dB μ A/m** - (dB micro Amps per meter), **dBG** (gauss), **dBpT** (tesla).
 - **Freq Interpolation**: Set to LINear and can NOT be edited.
 - To edit Frequency/Value pairs, enter numbers using the numeric keypad, and a frequency suffix when necessary.

- For both **Cable and Antenna correction**, Positive numbers indicate loss (we need ADD something positive to compensate for it), and Negative is indicative of some existing gain.
- Antenna Factor** describes the dB value needed to accurately display a far-field signal in terms that are in the units listed below. When the antenna has low gain, or low efficiency, the dB value to be added is larger.
- When one Freq/Value pair is entered, that correction value is applied to the entire displayed frequency span.
- When two or more Freq/Value pairs are entered, the data points between the lowest and highest frequencies are corrected. Linear interpolation is applied between frequencies when necessary.
- Optionally choose from the following:
 - Previous / Next Page** Quickly scrolls through pages of Freq/Value data.
 - **Add Row** Add a blank Freq/Value pair to the table,
 - Delete/Clear** then:
 - Delete Row** Remove the selected Freq/Value pair from the table.
 - Clear All** then **Yes** Remove all Freq/Value pairs from the table and resets header information to default settings.

When the table edits are complete

- Press **Done** to close the Antenna/Cable Editor.
- Press **Save Antenna** or **Save Cable** to save your changes to the specified Storage Device. Enter a filename using the FieldFox labeler (learn more in **“How to use the FieldFox labeler ” on page 770**). Learn more about Antenna and Cable files below.
- Press **Recall Antenna** or **Recall Cable** to load an Antenna or Cable file from the specified Storage Device.
- **Storage Device** Changes the device used to save or recall files. Choose from Internal (default setting), USB (must be connected) or SD card. This is a different setting from the Save/Recall Storage Device setting.

About Antenna and Cable files

- Cable files are saved and recalled from the **Cables** folder.
- Antenna files are saved and recalled from the **Antenna** folder.
- To **DELETE** Cable or Antenna files, use the Manage Files feature. Learn more in **“Manage Files” on page 776**.
- If the folder does not already exist on a USB or SD card, it is created automatically before storing the file.

Channel Scanner (Option 312) How to Set Up Channel Scanner

- All Channel Scanner mode Antenna and Cable files are saved and recalled as *.csv files, which allows them to also be read by spreadsheet programs.
- The FieldFox can also read *.ANT (Antenna) files that were created from older Keysight Spectrum Analyzers.
- Channel Scanner Mode cable or antenna (*.csv or *.ANT) files can NOT be edited in Data Link software.

How to create a Cable file from an S21 (NA mode) or an Insertion Loss (CAT mode) measurement

1. Measure the S21 or Insertion Loss of a cable. In NA mode, select either LogMag, Linear, or VSWR formats.
2. Use **Manage Folders** to change the active folder to CABLES. Learn how in **“Manage Folders” on page 778**.
3. While in NA mode, save the measurement as a *.csv file. Learn how in **“How to Save a File” on page 768**.
4. In Channel Scanner mode, select **Corrections**, then recall the *.csv file for correction.

Using Mapping

Channel Scanner mode has indoor and outdoor mapping capability. Refer to **Chapter 16, “Indoor and Outdoor Mapping – Option 352 (Requires Spectrum Analyzer Mode (Option 233 on N991xA), and GPS Receiver (Option 307))”**.

Using Resolution Bandwidth Tradeoff (Res BW Tradeoff)

This feature controls the resolution bandwidth for the current measurement.

To use this feature, press **BW 2** > **Res BW Tradeoff** then choose from the following:

- **High Sensitivity** – Use this setting for greatest accuracy (Res BW = 1500).
- **Medium** – This is the default setting (Res BW = 450).
- **Speed** – When you want the fastest possible measurement (Res BW = 150).

28 Noise Figure Mode (Option 356 – CPU2 Only)

CAUTION

IMPORTANT! Noise Figure mode uses DC variable voltage source (VVS) – (Option 309) during the measurements. The voltage might be as high as 28V during the measurement. During the noise figure measurement, always make sure there are no voltage sensitive devices connected to the DC SMB output port. When you exit the Noise Figure mode, the VVS voltage is reset to 1V to avoid potentially damaging your devices. Refer to “[Variable Voltage Source \(Opt. 309\)](#)” on page 755.

When you initially change the FieldFox mode to Noise Figure, the FieldFox displays the following message for ten seconds:
"Ensure your Noise Source is connected to the VVS DC Output
It (VVS) will be driven up to +28V during the measurement".

NOTE

Noise figure requires these options:

- Spectrum analyzer mode (Option 233–Combination Analyzers Only)
- Preamplifier (Option 235)
- DC variable voltage source (Option 309)
- Noise source (Refer to <https://www.keysight.com/us/en/assets/7018-03314/data-sheets/5990-9783.pdf>)

Not required, but recommended for improved accuracy:

- External preamplifier (U7227A/C/F and U7228A/C/F). Refer to www.keysight.com/find/usb-preamp.
-

NOTE

Noise figure mode sets the sweep to **Continuous OFF** to allow time for connecting a noise source, before beginning any measurements.

Figure 29-1

Example of Jitter Uncertainty (21 points)—with Uncertainty Bars. Learn more in [“How to use Auto-Integration” on page 682.](#)

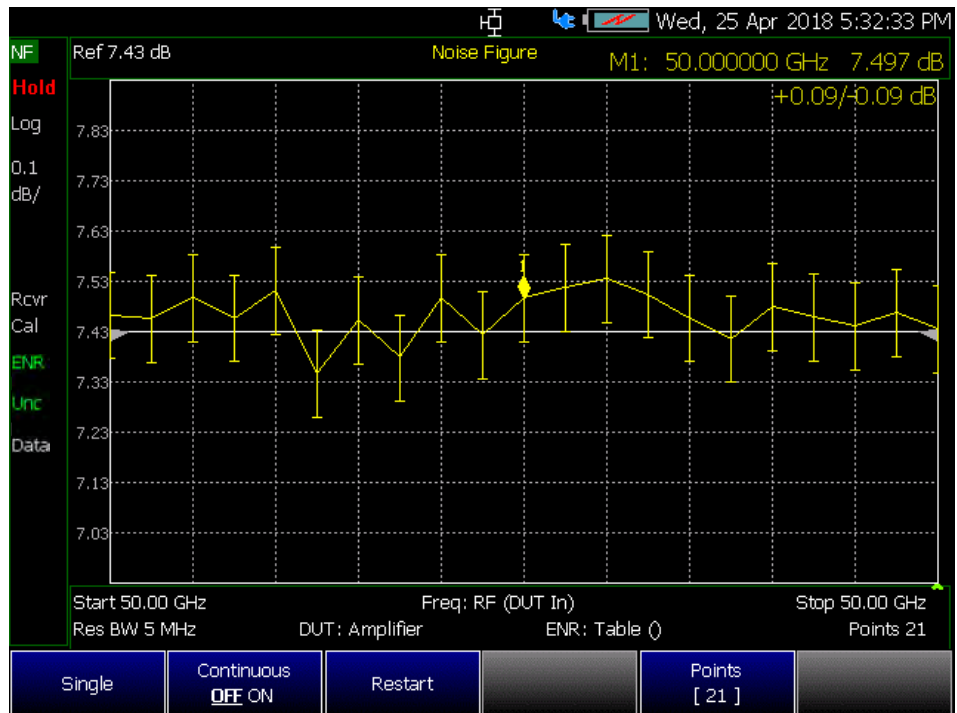
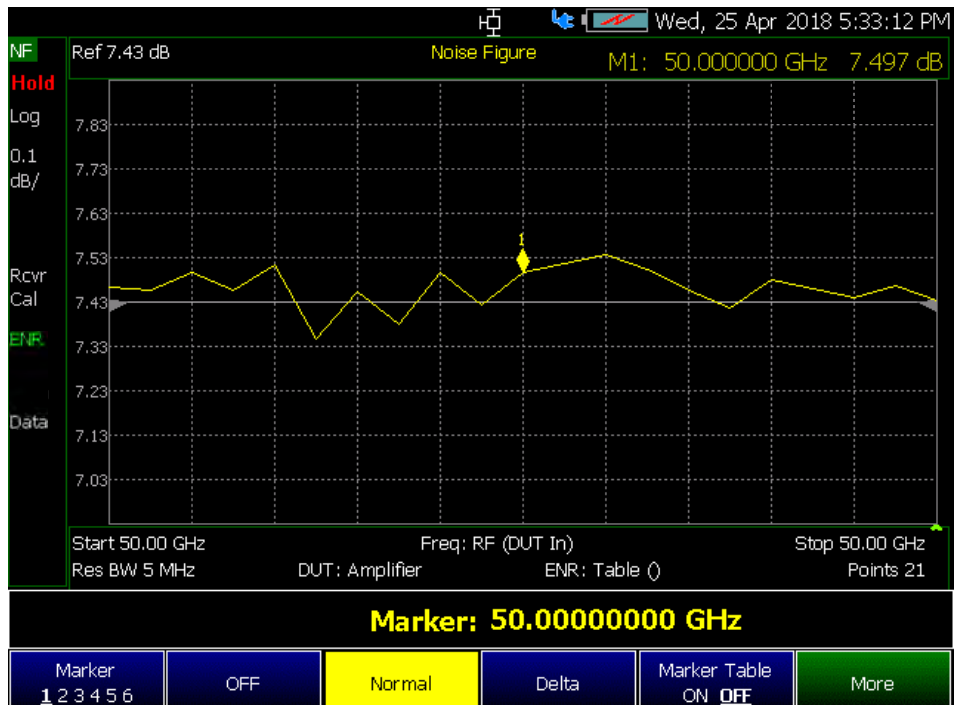

Figure 29-2

Example of Jitter Uncertainty (21 points)—with Uncertainty Bars Disabled. Learn more in [“How to use Auto-Integration” on page 682.](#)



In this Chapter:

- “Using Noise Figure” on page 644
- “How to Define a Noise Figure Measurement” on page 648
 - “Example: Typical Noise Figure Measurement Procedure” on page 648
 - “Overview of Softkey Menus” on page 649
 - “How to Use DUT Measurement Setups” on page 656
 - “Single / Continuous / Restart” on page 668
 - “Points ” on page 668
 - “Alignments” on page 669
 - “Calculating Noise Figure Measurement Uncertainty” on page 670
 - “Using ENR Tables” on page 675
 - “About ENR (*.enr), Preamplifier (*.amp), and DUT (*.dut) Files” on page 676
 - “Using Markers (Noise Figure)” on page 678
- “Calibration Wizard” on page 679
- “How to use Auto-Integration” on page 682
- “Other Features Available” on page 688
- “Troubleshooting” on page 689

See Also

- “All about Markers” on page 692
- “All about Limit Lines” on page 707
- “All about Trace Math” on page 712
- “All about Scale Settings” on page 714
- Chapter 29, “Data Analysis Features.”
- Chapter 32, “File Management.”

Using Noise Figure

Noise Figure enables you to do the following:

The FieldFox uses the Y-Factor technique to accurately verify and characterize the noise figure of devices. Option 356 has these features:

Five Measurement Types

- Noise Figure
- Noise Temperature
- Noise Factor
- Y-Factor
- Gain

Four Measurement Setup Types

- Noise Source
- Integration
- DUT
- Uncertainty

Four Pre-configured DUT Measurement Types

- Amplifier
- Upconverter
- Downconverter
- Multi-Stage Converter

Uncertainty Contribution Values can be Customized for Your Device

- Jitter uncertainty
- Mismatch uncertainty
- ENR uncertainty
- User calibration uncertainty
- Uncertainty bars

Select Noise Figure Mode before making any setting in this chapter.

How to select Noise Figure Mode:

- Press **Mode**.
- Then **More**.
- Then **Noise Figure**.

Noise Figure Mode (Option 356 – CPU2 Only)
Using Noise Figure

Figure 29-3 Display Annotation—Overview

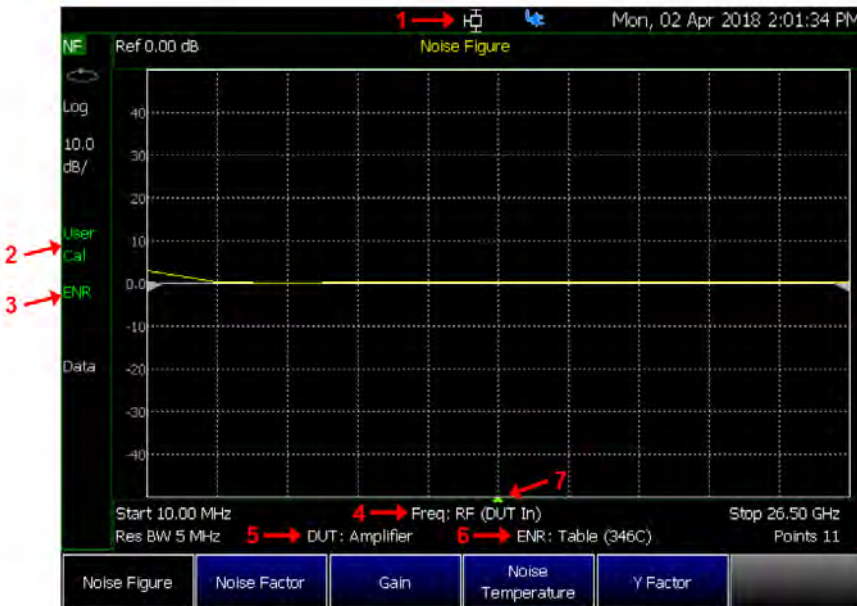

1. Variable Voltage Source (VVS) Status (appears when VVS is on. Refer to “Variable Voltage Source (Opt. 309)” on page 755.
2. Calibration Status
3. Excess Noise Ratio (ENR) Status
4. Frequency Context
5. DUT Type
6. Excess Noise Ratio (ENR) Mode
7. Sweep point caret (shows last point measured)

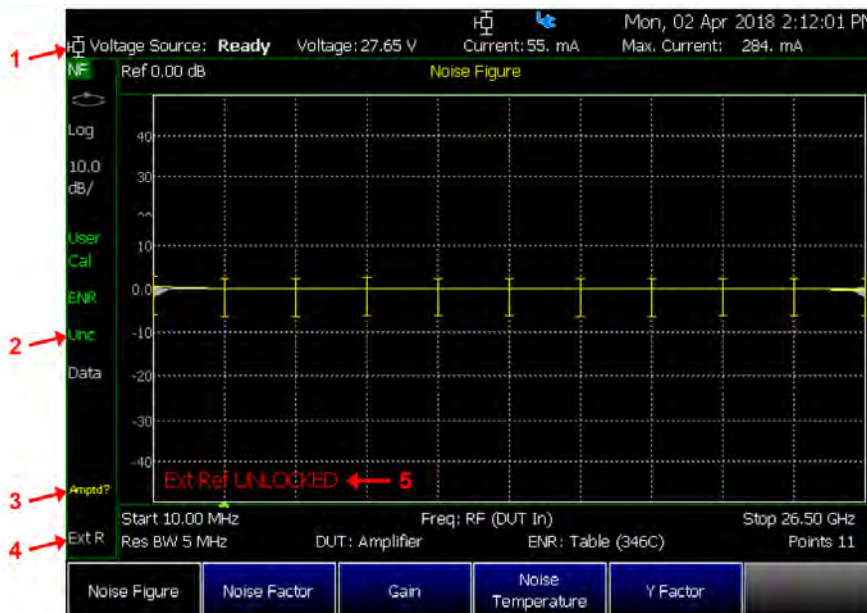

1. Variable Voltage Source (VVS) Status line (appears when the VVS status line is turned on in the system menu). Refer to “Variable Voltage Source (Opt. 309)” on page 755.
2. Uncertainty status annotation (displayed when the uncertainty bars are enabled)
3. Questionable Amplitude annotation (displayed when the Amplitude Alignment is stale)
4. External Reference annotation (displayed when external reference is selected)
5. Warning message annotation. Used to display the following warnings:
 - Invalid frequency settings
 - VVS trip
 - ADC Over Range
 - Ext Ref unlock

Figure 29-4 Dual Window Display Annotation

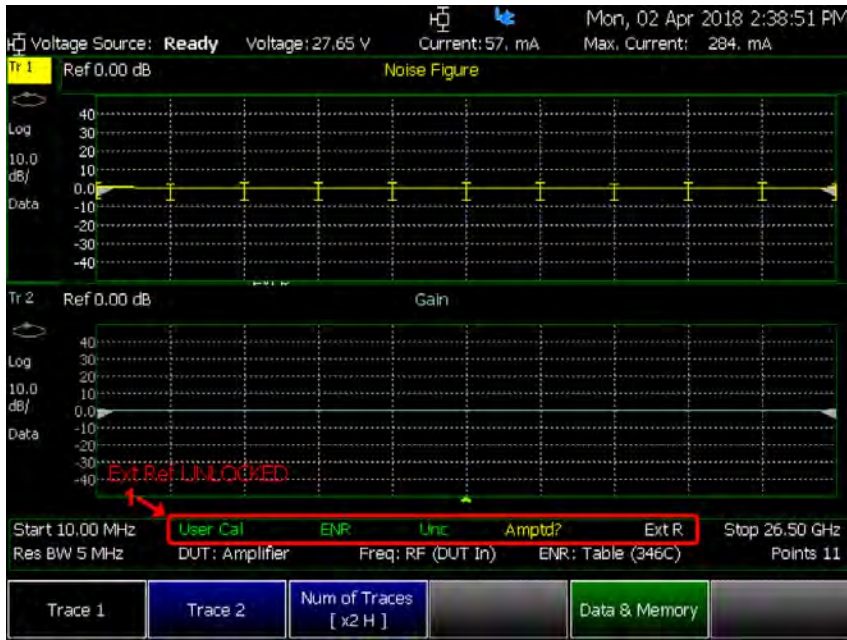

1. In the dual-window layout, non-trace-specific annotations are moved from the left of the traces to the bottom of the traces

Figure 29-5 Calibration Annotation

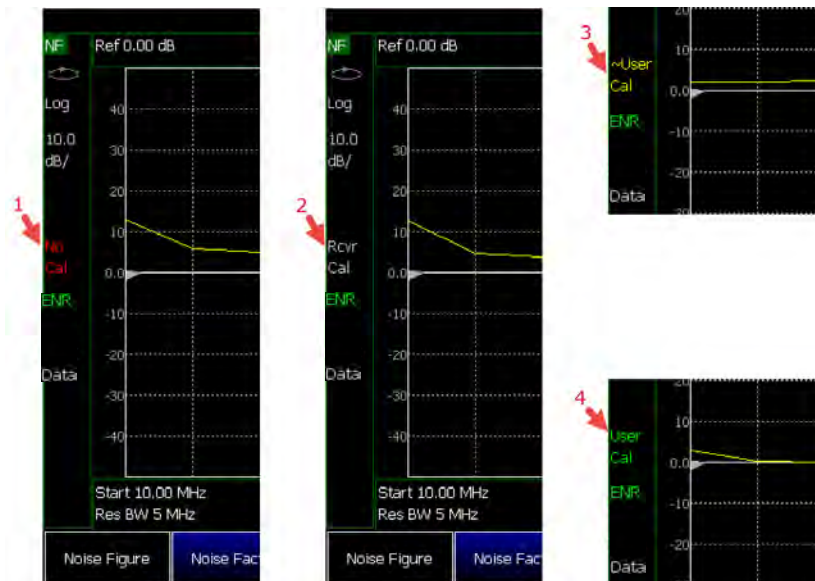

1. No Cal = No calibration applied
2. Rcvr Cal = Only receiver calibration applied
3. ~User Cal = Receiver Cal + User Cal applied, but User Cal is interpolated (the calibration frequency points do not match up with sweep frequency points)
4. User Cal = Receiver cal + User Cal applied and User Cal is not interpolated (the calibration frequency points match up with sweep frequency points)

Figure 29-6 ENR Status and Mode Annotation

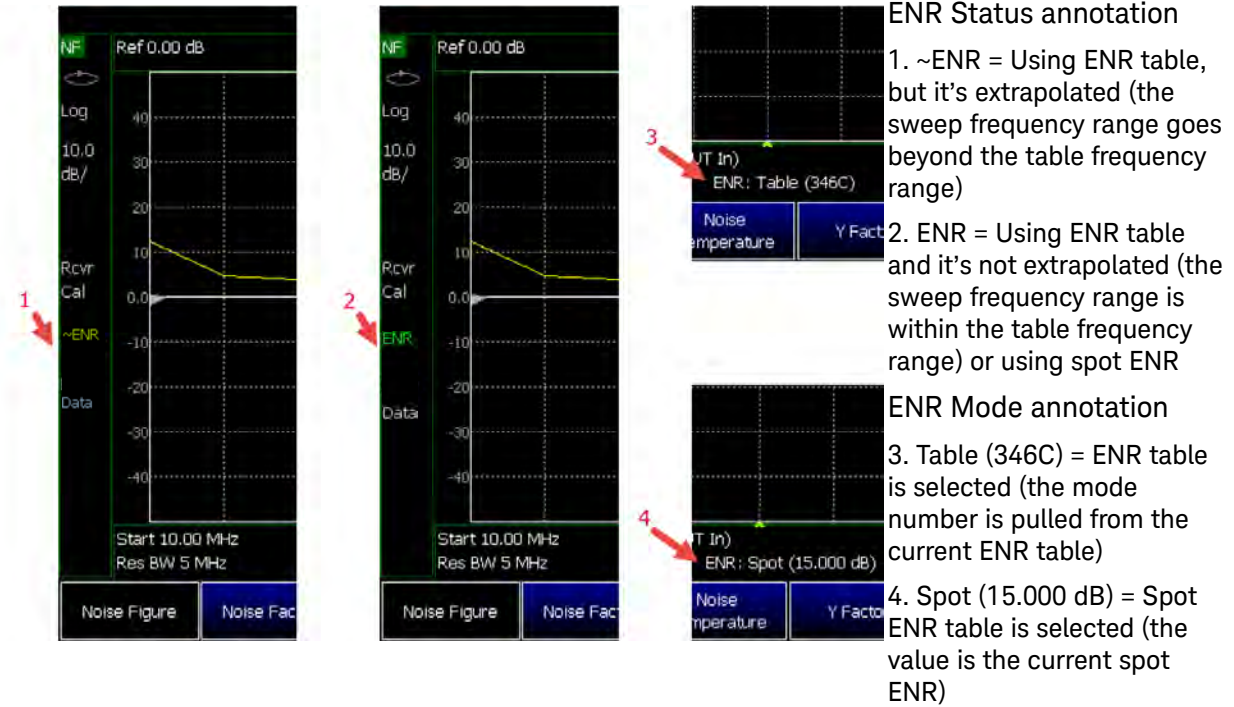
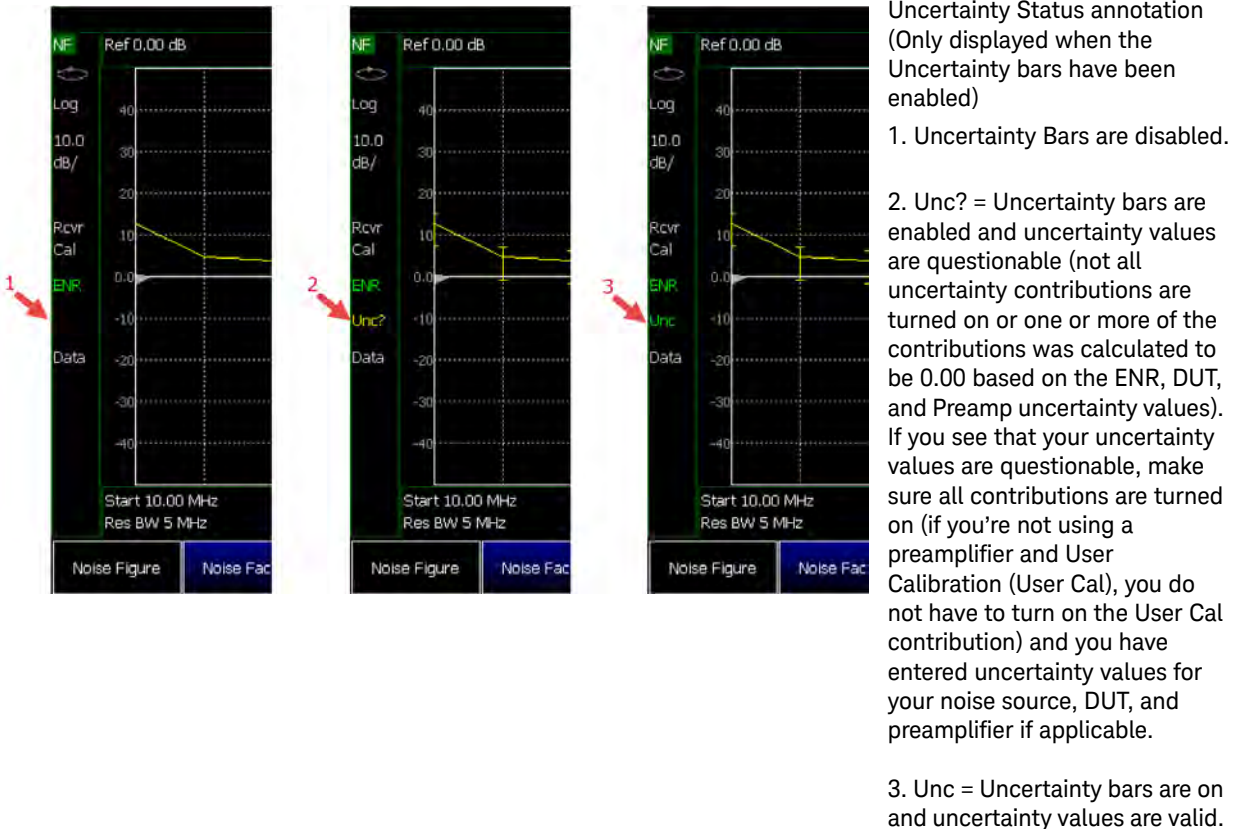

Figure 29-7 Uncertainty Annotation



How to Define a Noise Figure Measurement

The Option 356 Noise Figure mode uses the Y-factor method to calculate the noise figure.

This section contains the following:

- “[Example: Typical Noise Figure Measurement Procedure](#)” on page 648
- “[Overview of Softkey Menus](#)” on page 649
- “[How to Use DUT Measurement Setups](#)” on page 656
- “[Single / Continuous / Restart](#)” on page 668
- “[Points](#)” on page 668
- “[Resolution Bandwidth \(Res BW\)](#)” on page 669
- “[Alignments](#)” on page 669
- “[Calculating Noise Figure Measurement Uncertainty](#)” on page 670
- “[Using ENR Tables](#)” on page 675
- “[Using Markers \(Noise Figure\)](#)” on page 678

Example: Typical Noise Figure Measurement Procedure

This section briefly reviews the steps in setting up a noise figure measurement. If you are not familiar with this process or would like more information, refer to “[Overview of Softkey Menus](#)” on page 649 and “[How to Use DUT Measurement Setups](#)” on page 656.

1. Set up a Noise Source ENR Table:
(**Meas Setup** > **Noise Source** > **ENR Table Edit/Save/Recall**).
2. Set the resolution bandwidth: **BW** > **Res BW**
3. Set the frequency range: **Freq/Dist** >
 - **Start**,
 - **Stop**,
 - **Center**, and
 - **Span**
4. Set the number of points: **Sweep** > **Points** (minimum = 3 points, maximum = 1001 points, default = 21)
5. Use **Meas Setup** > **Integration** Setup Integration (See also “[How to use Auto-Integration](#)” on page 682.)
 - **Max. Time/Pt.** (Available when Mode = Auto) or
 - **Time/Pt.** (available when Mode = Fixed)

6. Perform a Receiver Calibration: (**Cal** > **Run Receiver Cal** and follow prompts).
7. Enter DUT setup type: **Meas Setup** > **DUT** > **Type**
 - **Amplifier** (default),
 - **Downconverter**,
 - **Upconverter**, or
 - **Multi-Stage Converter**
8. Run a User Calibration (i.e., If you are using an external preamp). (**Cal** > **Run User Cal** and follow prompts).
9. Use **Measure** to select the type of noise figure measurement:
 - **Noise Figure**,
 - **Noise Factor**,
 - **Gain**,
 - **Noise Temperature**, or
 - **Y-Factor**
10. Use **Meas Setup** > **Uncertainty** > **Uncert Contributions** to Enable/Disable Uncertainty Contributions:
 - **Jitter Uncert OFF ON**,
 - **ENR Uncert OFF ON**,
 - **Mismatch Uncert OFF ON**,
 - **User Cal Uncert OFF ON** (applies the current User Cal uncertainty to the current measurement's uncertainty calculations), and
 - Then **Back** > **Uncert Bars** to **ON**.

Overview of Softkey Menus

This sections describes the Noise Figure's Measure, Measure Setup softkeys, and related sub-menu softkeys.

1. Define a measurement type.
 - a. Select a **Measure**—choose:
 - **Noise Figure** Specify Noise Figure (default) or

NOTE

Noise Figure has asymmetrical uncertainty (i.e., log measurement). Noise Factor and Noise Temperature have symmetrical uncertainty (i.e., linear measurement). Uncertainty is not displayed for Gain and Y-Factor.

-
- **Noise Factor** Specify a Noise Factor or

- **Gain** Specify Gain or
- **Noise Temperature** Specify Noise Temperature or
- **YFactor** Specify Y-Factor

30 Then modify the settings based on the selected noise figure type

2. Select **Measure Setup**—choose:

- **Noise Source** or “**DUT** or” on page 652, “**Integration** or” on page 653, or “**Uncertainty**” on page 653.

Opens a menu of softkeys to define the Noise Figure’s ENR Mode Spot or Table and uncertainty values.

Then choose:

- **ENR Mode Spot Table** You can enter ENR data for the noise source you are using as a table of values or as a single spot value. The values held in the table can be used for measurements at a range of frequencies as well as at a fixed frequency.

The single spot value is used either for measurements at a single frequency, or for measurements across a range of frequencies that is narrow enough such that the ENR value does not change significantly across that range. (Default is Table).

- **ENR Spot Values** Opens a menu to enter a spot value either for measurements at a single frequency or for measurements across a range of frequencies that is narrow enough such that the ENR value does not change significantly across that range (Inactive with ENR Mode set to Table).

Then choose:

- **ENR** sets the ENR spot value in dB (default is 15 dB).
- **ENR Uncert.** sets the ENR spot uncertainty value in dB (default is 0.000 dB).
- **On Γ** sets the On value (hot) of the ENR spot value’s 50 Ω match, Γ (0.000 to 1.000).
- **Off Γ** sets the Off value (cold) of the ENR spot value’s 50 Ω match, Γ (0.000 to 1.000).
- **ENR Uncert. Cov. [2 σ]** Opens a menu to set the value of the ENR uncertainty coverage.

Then choose: **1 σ** , **2 σ** (default), or **3 σ** .

- **More** opens additional ENR Spot Value softkey menu choices
- **Γ Spec. Style [95th %ile]** Opens a menu of softkeys to set the Γ specification style.
Then choose **Maximum**, **95th %ile** (default), **80th %ile**, **Median**, **Mean**, or **Fixed**.
- **Γ Distribution [Rayleigh]** Opens a menu of softkeys to set the type of Γ distribution.
Then select **Rayleigh** (default), **Fixed**, or **Uniform in Circle**.
- **ENR Table Edit/Save/Recall** Opens the ENR table menu to edit, save, or recall noise source values (Not active with ENR Mode set to Spot).

Then choose:

- **Edit ENR Table** Opens the currently selected table of noise source values (generic default noise source values are populated for quick check). Enter your noise source's values for more accurate measurements.

CAUTION

IMPORTANT! Save your noise source table with a unique filename to avoid loss of table data. All noise figure files are saved with *.enr type suffixes.

- **New ENR Table** opens a new ENR table for entering and saving additional noise source values.

CAUTION

The FieldFox displays *Replace existing file?*, because the displayed default filename is the one last saved. Enter a unique filename to avoid loss of table data (i.e., all noise figure files are saved with *.enr type suffixes).

- **Save ENR Table** Opens a menu of softkeys to enable you to enter a unique noise source filename.
- **Recall ENR Table** Opens a menu of file recall softkeys and displays a list of stored noise source files.
- **Storage Device [Internal]** Opens a menu of softkeys to set the storage location for your files.
Then choose **Internal** (default), **SD Card**, or **USB**.
- **Back** to return to previous menu.

Noise Figure Mode (Option 356 – CPU2 Only)
How to Define a Noise Figure Measurement

- **T Cold Default** When making measurements at different ambient temperatures, you can set the T_{cold} value in Kelvin (K) manually (User). When set to Default, the T_{cold} value is set to the 296.5 K (Default = Default).
- **Back** to return to previous menu.

- **DUT** or
Opens a menu of softkeys to define your DUT Type (Amplifier, Downconverter, Upconverter, or Multi-Stage Converter), frequency context, and loss compensation. Refer to **“How to Use DUT Measurement Setups”** on page 656.

– **Integration** or

Opens a menu of softkeys to define the Integration's Mode Auto or Fixed and Jitter values.

CAUTION

For optimum speed and performance measurement results, it is recommended that auto-integration is used in all noise figure measurements.

Then choose:

- **Mode Auto Fixed** Select Auto (default) to let the FieldFox select the optimum coupled instrument settings. Changes can be made to the Jitter Goal and Max Time/Pt. values. When integration Mode is set to Fixed, the Time/Pt. softkey is active and can be modified.
- **Jitter Goal** Sets the maximum peak-to-peak jitter value. Values greater than this value triggers the Jitter Warning (i.e., if Jitter Warning = ON). (Only active when Mode = Auto.) (Default is 0.5 dB.)
- **Max Time/Pt.** Sets the maximum amount of time the jitter is measured at a given point to attempt to reach the Jitter Goal value (i.e., the measurement time per point is automatically adjusted to the minimum time required, but will never exceed the displayed Max Time/Pt.). After this time, values in excess of the jitter Goal value trigger the Jitter Warning.
- **Jitter Warning** Enables/Disables the Jitter Warning. The Jitter Warning displays when the Jitter value exceeds the Jitter Goal value. (Default = ON.)
- **Time/Pt.** Sets the Time/Pt. when Mode is set to Fixed. (Only active when Mode = Fixed.)
- **Back** to return to previous menu.

– **Uncertainty**

Opens a menu of uncertainty softkeys for setting the DUT, Preamp, and Uncert. Contributions.

Then choose:

- **DUT** Sets the DUT Mode to either Spot (default) or Table.

Then choose:

- **DUT Mode** Set to Spot (default) or to Table

For DUT MODE Spot choose:

- **DUT Spot Values** (Only active when DUT Mode = Spot).
Then choose:
 - **Input Γ** Sets the input Γ value.
 - **Output Γ** Sets the output Γ value.
 - **Γ Spec. Style [Fixed]** Opens a menu of softkeys to set the Γ specification style.
Then choose **Maximum**, **95th %ile**, **30th %ile**, **Median**, **Mean**, or **Fixed** (default).
 - **Γ Distribution [Fixed]** Opens a menu of softkeys to set the type of Γ distribution.
Then select **Rayleigh**, **Fixed** (default), or **Uniform in Circle**.
 - **Back** to return to previous menu.

- **DUT Table Edit/Save/Recall** (Only active when DUT Mode = Table).
Then choose:
 - **Import DUT Data** Opens a menu of softkeys where you can select a DUT *.csv or *.snp data file to import into your table.
Then choose **Recall File**, **Sort by File Name**, **Sort by Date**, **Next Page**, **Previous Page**, or **Cancel**.
 - **Edit DUT Data** Opens a menu of softkeys where you can edit the current selected DUT table data file (e.g., serial number, model number, Γ Spec. Style, Γ Distribution, Input Γ , Output Γ , and frequencies).
Then choose **Edit**, **Next Page**, **Previous Page**, **Add Row** (only active for Frequency), **Delete/Clear** (only active for Frequency), or **Done**.
 - **New DUT Table** Opens a menu of softkeys to choose a new DUT table.

CAUTION

IMPORTANT! The FieldFox displays *Replace existing file?*, because the displayed default filename is the one last saved. Enter a unique filename to avoid loss of table data.

- **Save DUT Table** Opens a Create a filename menu of softkeys to enter a DUT table filename and then to save the file.
- **Recall DUT Table** Opens a Select a file menu of softkeys to enter a DUT table filename to recall.
- **Storage Device [Internal]** Opens a set of softkeys to select where your DUT table is saved.
Then choose **Internal**, **SD Card**, or **USB**.
- **Back** to return to previous menu.

- **Preamp** Sets the DUT Mode to either Spot (default) or Table.

Then choose:

- **Preamp Mode** Set to Spot (default) or to Table.
For Preamp MODE Spot choose:
 - **Preamp Spot Values** (Only active when DUT Mode = Spot).
Refer to similar "**DUT Spot Values (Only active when DUT Mode = Spot).**" on page 654.
 - **Back** to return to previous menu.
 - **Preamp Table Edit/Save/Recall** (Only active when Preamp Mode = Table).
Refer to similar "**DUT Table Edit/Save/Recall (Only active when DUT Mode = Table).**" on page 654.
 - **Back** to return to previous menu.

- **Uncert Contributions** Opens a menu of uncertainty contribution softkeys.

Then choose:

- **Jitter Uncert.** Enable/disable the Jitter Uncertainty.
- **ENR Uncert.** Enable/disable the ENR Uncertainty.
- **Mismatch Uncert.** Enable/disable the Mismatch Uncertainty.

- **User Cal Uncert.** Enable/disable the User Cal Uncertainty.
- **Back** to return to previous menu.

- **Uncert Cover** Sets the uncertainty coverage value for the current settings.
Then choose: **1 σ** , **2 σ** (default), or **3 σ** .
- **Uncert Bars** Enables/disables the uncertainty calculator uncertainty bars values for the current settings.
- **Back** to return to previous menu.

How to Use DUT Measurement Setups

Noise figure Option 356 has four predefined measurement setups:

- Amplifier
- Downconverter
- Upconverter
- Multi-Stage Converter

Refer to [“Using Measure Setup to Choose DUT Type” on page 656](#).

Each of the four measurements has frequency context and loss compensation softkeys that can be used to optimize the DUT’s noise figure measurement. Refer to [“DUT Type and Frequency Context” on page 661](#) and to [“DUT Type Loss Compensation” on page 666](#).

Using Measure Setup to Choose DUT Type

This section contains the following:

- Setting **DUT** > **Type [Amplifier]**, see [Figure 30-1 on page 657](#)
- Setting **DUT** > **Type [Downconverter]**, see [Figure 30-2 on page 658](#)
- Setting **DUT** > **Type [Upconverter]**, see [Figure 30-3 on page 659](#)
- Setting **DUT** > **Type [Multi-Stage Converter]**, see [Figure 30-4 on page 660](#)

Figure 30-1 DUT – Measurement Setup – Type [Amplifier] Screen

DUT – Measurement Setup – Type [Amplifier]

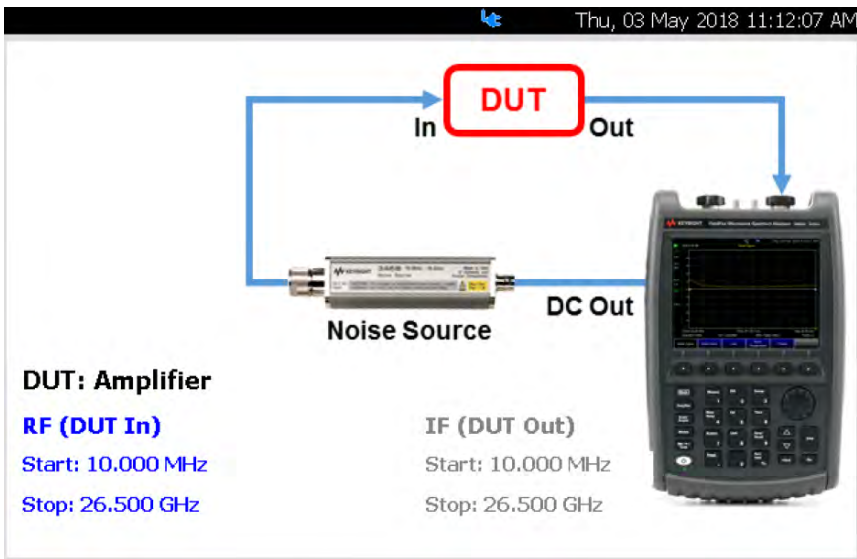

Used for setting up DUT parameters without an external preamplifier (LNA)

– Type [Amplifier]

--DUT displays does not display LO if not frequency converting

---Displays preamp (LNA), if User Cal is available. See next image this figure.



DUT – Measurement Setup – Type [Amplifier] with External Amplifier (LNA) and User Calibration

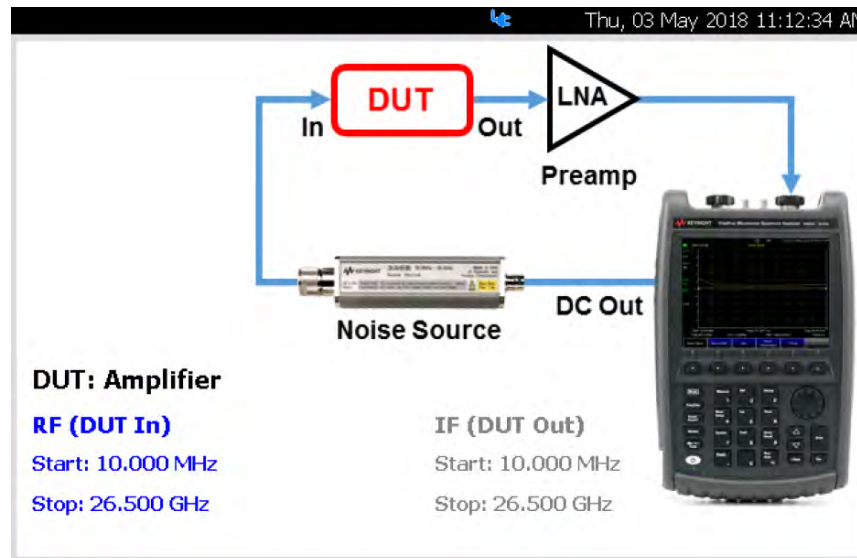

Used for setting up DUT parameters with an external preamplifier (LNA)

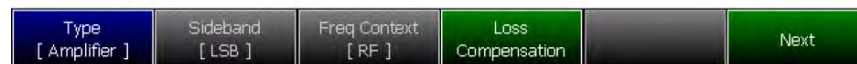

Figure 30-2 DUT Measurement Setup – Type [Downconverter] Screen

DUT – Measurement Setup – Type [Downconverter]

DUT: Downconverter (LSB)

RF (DUT In)	LO	IF (DUT Out)
Start: 9.000 GHz	10.000 GHz	Start: 1.000 GHz
Stop: 8.000 GHz		Stop: 2.000 GHz

Navigation: Type [Downconverter], Sideband [LSB], Freq Context [IF], Loss Compensation, Next

Used for setting up DUT parameters without an external preamp

- Type [Downconverter]
- Performs internal frequency downconversion (converts RF down to IF)
- Sideband:
 - LSB: Lower Sideband (available for downconverter and upconverter)
 - USB: Upper Sideband (available for downconverter and upconverter)
 - DSB: Double Sideband (available for downconverter; averages LSB and USB ENR values)

DUT – Measurement Setup – Type [Downconverter] with External Amplifier (LNA) and User Calibration

DUT: Downconverter (LSB)

RF (DUT In)	LO	IF (DUT Out)
Start: 9.000 GHz	10.000 GHz	Start: 1.000 GHz
Stop: 8.000 GHz		Stop: 2.000 GHz

Navigation: Type [Downconverter], Sideband [LSB], Freq Context [IF], Loss Compensation, Next

Used for setting up DUT parameters with an external preamp

Figure 30-3 DUT Measurement Setup – Type [Upconverter] Screen

DUT – Measurement Setup – Type [Upconverter]

DUT: Upconverter (LSB)

RF (DUT In)	LO	IF (DUT Out)
Start: 9.000 GHz	10.000 GHz	Start: 1.000 GHz
Stop: 8.000 GHz		Stop: 2.000 GHz

Buttons: Type [Upconverter], Sideband [LSB], Freq Context [IF], Loss Compensation, Next

Used for setting up DUT parameters without an external preamp

–Type [Upconverter]

--Performs internal frequency upconversion (technically, converts IF up to RF, but for this case RF always = DUT In and IF always = DUT Out and so, converts RF up to IF)

–Sideband

--LSB: Lower Sideband (available for downconverter and upconverter)

--USB: Upper Sideband (available for downconverter and upconverter)

DUT – Measurement Setup – Type [Upconverter] with External Amplifier (LNA) and User Calibration

DUT: Upconverter (LSB)

RF (DUT In)	LO	IF (DUT Out)
Start: 9.000 GHz	10.000 GHz	Start: 1.000 GHz
Stop: 8.000 GHz		Stop: 2.000 GHz

Buttons: Type [Upconverter], Sideband [LSB], Freq Context [IF], Loss Compensation, Next

Used for setting up DUT parameters with an external preamp

Figure 30-4 DUT Measurement Setup – Type [Multi-Stage Converter] Screen

DUT – Measurement Setup – Type [Multi-Stage Converter]

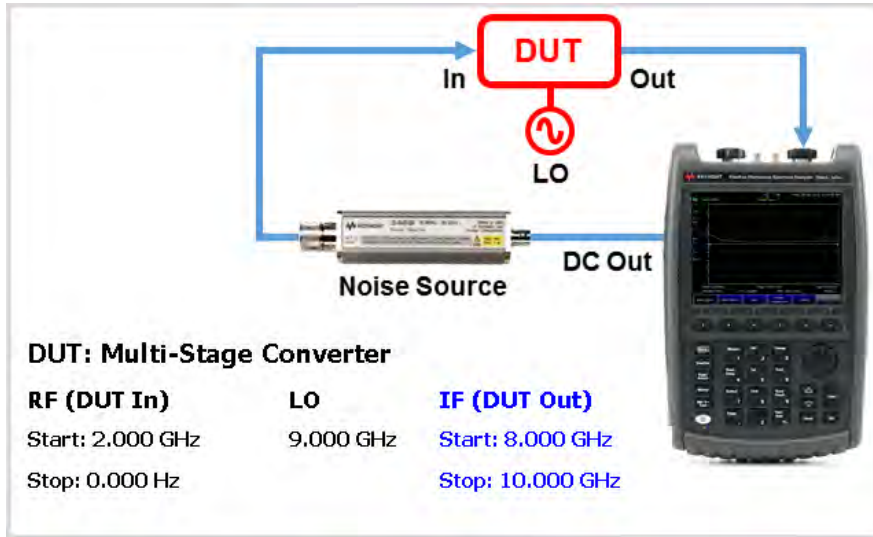

Used for setting up DUT parameters
 – Type [Multi-Stage Converter]
 --Multi-Stage Converter: Performs multi-stage frequency conversion (converts RF down/up to IF)



DUT – Measurement Setup – Type [Multi-Stage Converter] with External Preamp (LNA) and User Calibration

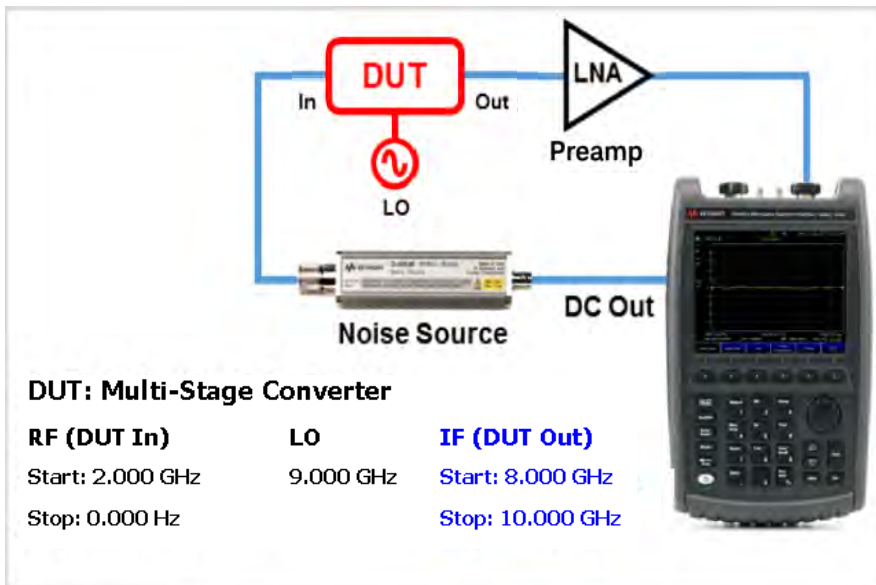

Used for setting up DUT parameters with preamp and User Cal

DUT Type and Frequency Context

Noise figure enables you to define the frequency context for your noise figure measurements:

- RF (DUT In):
 - Start
 - Stop
 - Center
 - Span
- Freq Context—(Inactive for Amplifier):
 - RF
 - IF
- LO—(Inactive for Amplifier)
- IF (DUT Out)—(Inactive for Amplifier)
 - Start
 - Stop
 - Center
 - Span

This section contains the following:

- Setting **Meas Setup** > **DUT** > **Next** > **RF (OUT in)**, see [Figure 30-5 on page 662](#)
- Setting **Meas Setup** > **DUT** > **Next** > **IF (DUT Out)**, see [Figure 30-6 on page 663](#)
- Setting **Meas Setup** > **DUT** > **Freq Context [IF]**, see [Figure 30-7 on page 664](#)

Frequency Context – RF (DUT In)

The RF (DUT In) softkey can be used to define the DUT Type’s RF Start, Stop, Center, and Span frequencies. Refer to “[Frequency Range and Frequency Context](#)” on page 665.

Figure 30-5 DUT >Type [Amplifier] and [Multi-Stage Converter] > RF (DUT In)–Frequency Context

DUT – Measurement Setup – Type [Amplifier] and [Multi-Stage Converter]

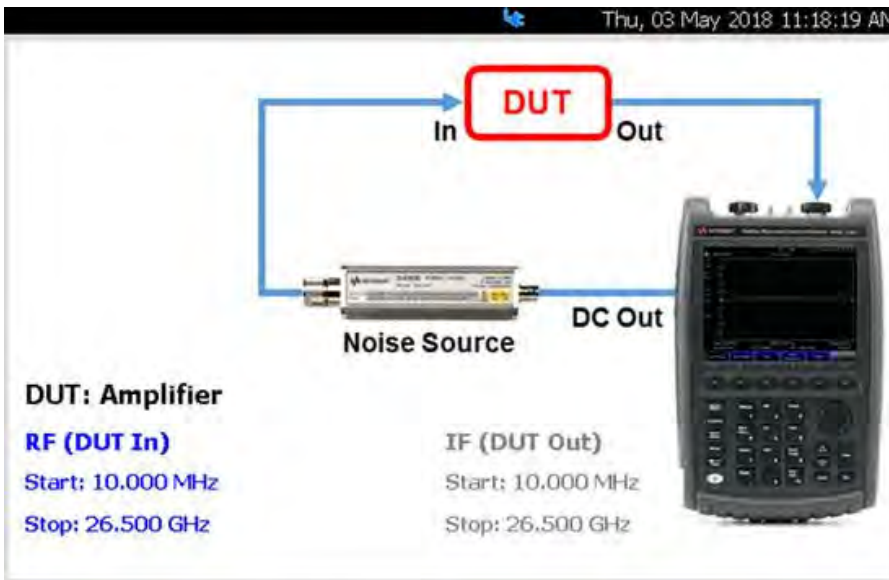

Used for setting up Start, Stop, Center, and Span frequency context for a DUT

– Type [Amplifier] and [Multi-Stage Converter]

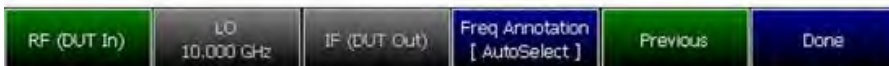

--Set the frequency context based on the DUT Type



--Enter the RF (DUT In) values for Start, Stop, Center, and Span frequencies

Frequency Context – IF (DUT Out) – Inactive for Type [Amplifier]

The IF (DUT Out) softkey can be used to define the DUT Type’s IF Start, Stop, Center, and Span frequencies. Refer to “[Frequency Range and Frequency Context](#)” on page 665.

Figure 30-6 DUT >Type [Downconverter], [Upconverter], and [Multi-Stage Converter] > IF (DUT Out)–Frequency Context (Inactive for Type [Amplifier])

DUT – Measurement Setup – Type [Downconverter], [Upconverter], and [Multi-Stage Converter]

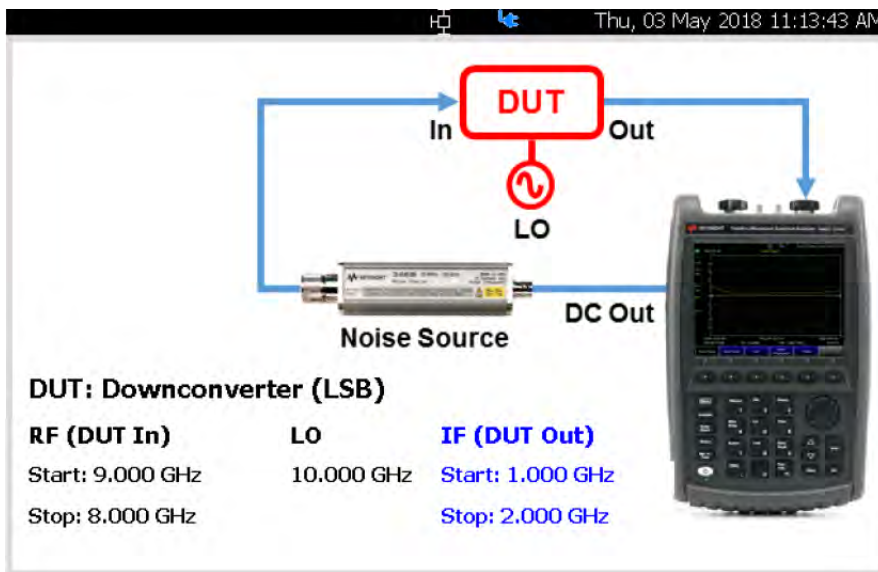

Used for setting up Start, Stop, Center, and Span frequency context for a DUT

– Type [Downconverter], [Upconverter], and [Multi-Stage Converter]

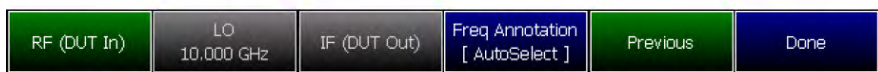

--Set the frequency context based on the DUT Type



--Enter the RF (DUT In) values for Start, Stop, Center, and Span frequencies

DUT Type–Freq Context (IF or RF)–(Inactive for DUT Type [Amplifier])

Frequency context can be used to define the DUT Type’s RF Context **IF** (default) and **RF** values. Refer to “Frequency Range and Frequency Context” on page 665.

Figure 30-7 DUT >Type [Downconverter], [Upconverter], and [Multi-Stage Converter] > Freq Context [IF] or [RF]–(Inactive for Type [Amplifier])

DUT – Measurement Setup – Type [Downconverter], [Upconverter], and [Multi-Stage Converter]

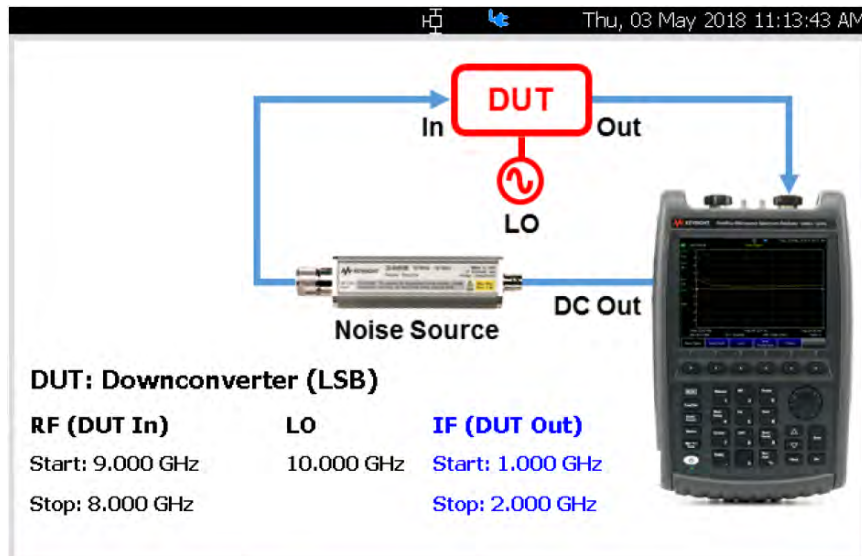

Used for setting up frequency context for a DUT

– Type [Downconverter], [Upconverter], and [Multi-Stage Converter]



--Set the frequency context based on the DUT Type



--Enter the frequency context IF (default) or RF

Frequency Range and Frequency Context

Set the range of frequencies over which you would like to make DUT type measurements and frequency context for noise measurements.

When the frequency range is changed after a calibration is performed, the cal becomes interpolated. Learn more in [“Interpolation *” on page 153](#).

How to set Frequency Range and Frequency Context

- Press **Freq/Dist** (Measurement) or
for Frequency Context:
 - Press **Meas Setup** > **DUT** > **RF (DUT In)** and **IF (DUT Out)**
 - Then choose from the following
 - **Start** and **Stop** frequencies - beginning and end of the sweep.
 - **Center** and **Span** frequencies – the center frequency and span of frequencies (half on either side of center).
 - **Freq Annotation** and one of the following:
 - AutoSelect** (Default) – The FieldFox selects a frequency annotation setting (CenterSpan or StartStop).
 - CenterSpan** – The center frequency and span are displayed.
 - StartStop** – The start and stop frequencies of the frequency span are displayed.
- Follow each setting by entering a value using the numeric keypad, **▲▼** arrows, or the rotary knob.
 - After using the keypad, select a multiplier key. Learn about multiplier abbreviations in [Chapter 1, “Overview.”](#)
 - After use the **▲▼** arrows or the rotary knob, press **Enter**.

Figure 30-8

1. Frequency warning
 1. Tells you the setup is illogical and how to fix it
 2. Does not stop measurement

2. Frequency error
 1. Tells you that the frequency values are out of range (RF < 0 or IF < FF Minimum Start Freq or IF > FF Maximum Stop Freq)
 2. Stops measurement until you fix it

3. Frequency warnings/errors also show up on main screen

DUT: Downconverter (LSB)
 RF (DUT In) LO IF (DUT Out)
 Start: 9.990 GHz 10.000 GHz Start: 10.000 MHz
 Stop: -16.500 GHz Stop: 26.500 GHz

Frequency out of range: RF (DUT In) RF Stop freq should be greater than IF Stop freq

Type [Downconverter] Sideband [LSB] Freq Context [IF] Loss Compensation Next

Start 10.00 MHz Freq: IF (DU)
 Res BW 5 MHz DUT: Downconv (LSB)

Noise Source DUT Integration

DUT Type Loss Compensation

For all of the DUT Types (Amplifier, Downconverter, Upconverter, and Multi-Stage Converter) the loss compensation, before the DUT (**BeforeDUT**) and after the DUT (**AfterDUT**) can be enabled or disabled for loss and for temperature.

Loss compensation can be used to compensate for double sidebands (DSB). Loss compensation can be used in the case of DSB measurements to compensate for the doubling of the measured noise level (i.e., 3.01 dB increase). For all sideband cases you can enable or disable **Loss** (device loss) and **Temperature** (device temperature). Refer to [Figure 30-9 on page 667](#).

This section contains the following:

- Setting **Meas Setup** > **DUT** > **Loss Compensation** > **Before DUT** and **After DUT**, see [Figure 30-9 on page 667](#).

Setting DUT Loss Compensation

Figure 30-9 DUT Loss Compensation

DUT – Measurement Setup – Type [Amplifier], [Downconverter], [Upconverter], and [Multi-Stage Converter]

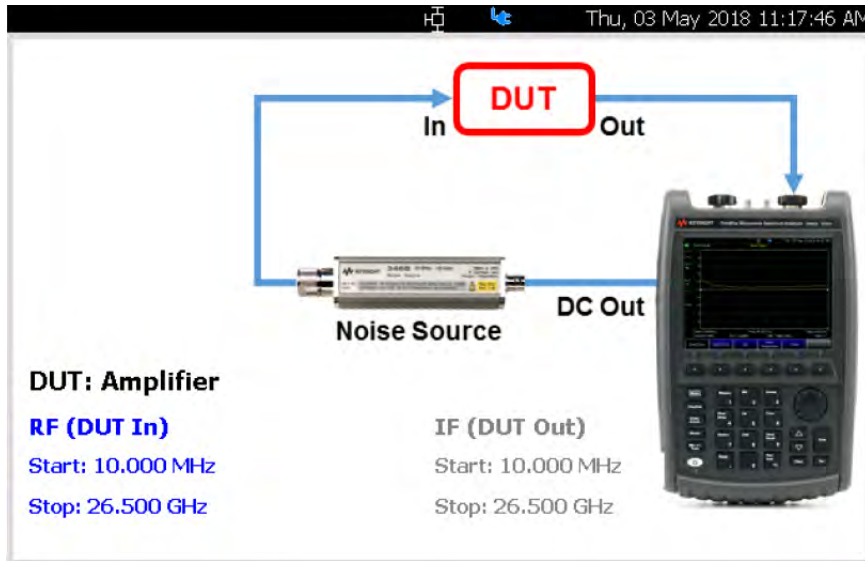

Used for setting up loss compensation for a DUT
 – Type [Amplifier], [Downconverter], [Upconverter], and [Multi-Stage Converter]



--Loss compensation can be set before and after the DUT

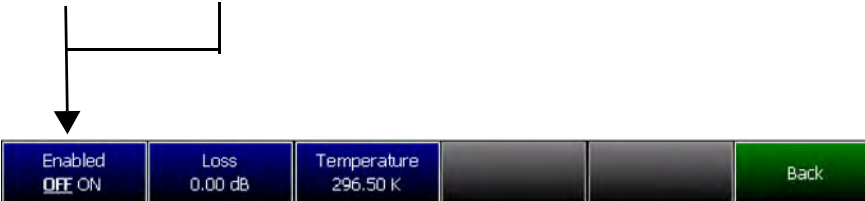

--Enable or disable the Loss (device loss) and the temperature (device temperature)

Single / Continuous / Restart

This setting determines whether the FieldFox measures continuously or only once each time the **Single** or **Run / Hold +/-** button is pressed. Use **Hold / Single** or to conserve battery power or to allow you to save or analyze a specific trace.

How to set Single or Continuous

- Press **Sweep 3**.
- Then choose one of the following:
 - **Continuous**
 - **ON** Causes noise figure (NF) to make continuous sweeps. This is the typical setting for making measurements. Each **Run / Hold +/-** press causes NF to toggle between continuous sweep and Hold.
 - **OFF** Causes NF to Hold. Each **Run / Hold +/-** or **Single** press causes NF to make ONE sweep, then Hold. The Hold annotation changes to an arrow --> while the sweep occurs.
 - **Single** Automatically sets Continuous OFF and causes NF to make ONE sweep, then Hold.
 - **Restart** Resets the sweep to the current defined start frequency point.

Points

Points is the number of measurements that are measured and displayed along the X-axis. The higher number of data points, the better the ability to resolve closely spaced signals and the slower the sweep speed.

How to set number of points

- Press **Sweep 3**
- Then **Points [current setting]**
- Then choose from: **03 | 05 | 11 | 21 | 51 | 101 | 201 | 401 | 601 | 801 | 1001**

Resolution Bandwidth (Res BW)

CAUTION

Avoid setting the resolution bandwidth (Res BW) greater than the bandwidth of the measured DUT.

In NF Mode, the Res BW settings increase the measurement speed and quality of a measured noise figure. The wider (higher) the Res BW, the faster and better the noise figure measurement. However, as the Res BW is narrowed, the sweep speed becomes slower and the measurement quality is degraded.

So: Wider Res BW = better noise measurement and faster measurement time

How to set Res BW

- Press **BW 2**.
- Then **Res BW**.
- Then choose from the following:
 - **300 KHz | 1 MHz | 3 MHz | 5 MHz** Press the desired resolution bandwidth.

The current Res BW setting is shown at the bottom of the screen.

This setting could impact the accuracy of the measurement. See Specifications in <https://www.keysight.com/us/en/assets/7018-03314/data-sheets/5990-9783.pdf>.

Alignments

The Noise Figure mode requires alignment types: amplitude. Refer to the SA chapter's **"Alignments" on page 211** for information on all alignments.

Calculating Noise Figure Measurement Uncertainty

The Noise Figure mode can calculate and display the uncertainty of the noise measurement, whether it is a Noise Figure, Noise Factor, or Noise Temperature measurement.

The uncertainty calculation accounts for the following sources of uncertainty, both in the measurement and in the user calibration (Run User Cal):

- Noise power uncertainty caused by finite sample size (Jitter)
- Noise power uncertainty caused by mismatch
- ENR uncertainty of the noise standard

The following are not included because they have been determined to be insignificant:

- Linearity (i.e., due to the linear wide dynamic range receiver, the automatic gain adjustment, and the small power excursions of the hot/cold measurement)
- Residual temperature drift of the FieldFox (i.e., due to the internal reference switch)

Other possible causes of uncertainty that are not included in the uncertainty analysis are temperature drift of the following:

- DUT,
- Noise source, or
- Preamplifier

CAUTION

Generally, the drift immunity of the Y-factor noise figure measurement is quite good. Nevertheless, caution is advised when temperature changes are significant between the user calibration and measurement.

NOTE

When any one of the four uncertainty values reads all “0.00” across the band, a yellow `UNC?` annotation is displayed on the left side of the FieldFox display.

Refer to ENR [“Using ENR Tables” on page 675](#).

Reverse noise wave generation by the DUT or preamplifier

All amplifiers, including the DUT and preamplifiers used in the noise figure measurement, are active devices which may generate noise power from both their input and output ports. The Noise Figure mode uncertainty calculation does not account for uncertainties caused when the input generated noise reflects back into the amplifier and adds to the total measured noise power. These types of uncertainties are minimized by using well matched noise

sources in the measurement and in the user calibration. And, in the case of very low power output DUTs (<15 dB gain + noise figure), by using an isolator on the input of the preamplifier.

Electromagnetic interference

DUTs, preamplifiers, noise sources, and connectors may all potentially be affected by radiated signals present in the test environment. Care should be taken to establish an appropriate test environment for the noise figure measurement.

DUT oscillations, microphonic behavior, etcetera

Any instability in the DUT will cause unaccounted noise measurement uncertainties.

Entering Uncertainty Information

In addition to information gathered during the measurement, the following information must be provided by the user in order to determine the noise measurement uncertainty:

- **DUT Reflection Coefficient**

For this section, see also [“Overview of Softkey Menus” on page 649](#) ([Uncertainty](#) > [DUT](#) on [page 653](#)).

DUT Reflection Coefficients values may be imported to a DUT table from *.snp or *.csv Files, entered by editing a DUT table, recalled as a previously saved DUT table (in a *.dut file), or set as a spot value to be applied across all frequencies.

NOTE

DUT and preamplifier *.snp files may be generated in the FieldFox VNA mode, and then imported into the Noise Figure mode.

Specified Style (Spec Style): Following the GUM method for Type B evaluation of standard uncertainty described in Reference[1]¹, the uncertainty calculation takes into account not only the entered value of the reflection coefficient, but also the nature of this value. This can either be a measured value for the DUT, or some form of specified value. This is indicated by the Spec Style setting. Specified Styles may be either a percentile value, maximum, fixed, median or mean. This value indicates the nature of the entered value relative to the population of values it represents. Refer to **Table 30-1 on page 672**.

Distribution: Distribution settings refer to the population distribution of the $|\Gamma|$ values for the device. Refer to **Table 30-2 on page 672**.

Table 30-1 **Specify Style – of the entered value relative to the represented population**

Style	Description
Maximum	Use this if this value represents the largest possible reflection coefficient for the population of devices to which the DUT belongs. This is true for “does not exceed” specifications.
Fixed	Use this if the value is a measured value for the DUT.
Median / Mean	Use this if this value represents the median / mean reflection coefficient for the population of devices to which the DUT belongs.
95th %ile	Use this if 95% of the population has a lower reflection coefficient than the value entered. This is the case for “2 standard deviation” (2σ) type specifications.
80th %ile	Use this if 80% of the population has a lower reflection coefficient than the value entered.

Table 30-2 **Distribution – of the population of the reflection coefficients**

Distribution	Description
Fixed	The reflection coefficient magnitude is always at the given level. This is often the case when measured values are used.
Rayleigh	The probability density function (pdf) of the magnitude of the reflection coefficient is a Rayleigh distribution. This is normally the case for specified values when the overall mismatch is due to several interacting impedance transitions within the device.
Uniform (within a Circle)	A distribution that was historically used in the industry, before the Rayleigh research, as documented in Keysight Application Note 1449-3, but is rarely accurate. Refer to https://www.keysight.com/us/en/assets/7018-01152/application-notes/5988-9215.pdf .

1. Reference [1]: GUM 1995 with minor corrections Evaluation of measurement data – Guide to the expression of uncertainty in measurement JCGM 100:2008 First Edition September 2008.

– **Noise Source Reflection Coefficient, ENR Uncertainties, and ENR values:**

For this section, see also [“Overview of Softkey Menus” on page 649](#) ([Noise Source](#) on [page 650](#)) and [“Using ENR Tables” on page 675](#).

Noise source reflection coefficients, ENR Uncertainties, and ENR values may be entered by Recalling a previously generated *.enr file, editing an ENR table, or set as a spot value to be applied across all frequencies. Note that any *.enr file which uses the standard *.enr file format may be recalled by the Noise Figure mode.

NOTE

Template *.enr files for several common models of noise sources may be found in the default ENR table directory of the FieldFox. In these files, the reflection coefficients have been set to the values specified for the respective model numbers, but the values for the ENR or ENR uncertainty will need to be entered at each frequency. Refer to [“ENR \(*.enr\) Files” on page 676](#).

As in the case of the DUT, in addition to entering the magnitude reflection coefficient values, the uncertainty calculation takes into account the distribution and specified style for the noise source reflection coefficient value. Additionally, the ENR table requires a value for the ENR uncertainty coverage (Uncert Coverage), which states how the entered ENR uncertainty (ENR Uncert) value is related to the population of possible ENR uncertainties. This is typically set to 2σ which means that 95% of the time, the actual ENR is within the range of ENR +/- ENR Uncertainty.

– **Preamplifier Reflection Coefficients (User Calibration Only):**

For this section, see also [“Overview of Softkey Menus” on page 649](#) ([Uncertainty](#) > [Preamp](#) on [page 655](#)).

When a user calibration is performed, the Preamplifier Reflection Coefficient values may be imported to a Preamp table from *.snp or *.csv files, entered by editing a preamplifier table (Preamp Table), recalled as a previously saved preamp table (in a *.amp file), or set as a spot value to be applied across all frequencies.

NOTE

Template preamplifier (*.amp) files for several common models of preamplifiers may be found in the default Preamp table directory of the FieldFox. In these files, the reflection coefficients have been set to the values specified for the respective model numbers.

NOTE

DUT and preamplifier *.snp files may be generated in the FieldFox VNA mode, and then imported into the Noise Figure mode.

As in the case of the DUT, In addition to entering the magnitude reflection coefficient values, the uncertainty calculation takes into account the distribution (Γ Distribution) and specified style (Spec Style) for the preamplifier reflection coefficient value.

– **User Calibration Noise Source Reflection Coefficient, ENR Uncertainties and ENR values (User Calibration Only):**

These are identical to the noise source values entered for the measurement, but are entered prior to performing the user calibration (Run User Cal).

– **Controlling the Uncertainty Calculation and Display**

For this section, see also [“Overview of Softkey Menus” on page 649](#) ([Uncertainty](#) > [Uncert Contributions](#) on [page 655](#)).

When enabled, uncertainty bars are displayed on the data trace, indicating the uncertainty range for the current Noise Figure, Noise Factor, or Noise Temperature measurement. By default, the displayed uncertainty range is the measured data +/- the default coverage factor of two times the calculated standard deviation (2σ), which is based on all included uncertainties. Optionally, the coverage factor may be changed to 1σ , 2σ or 3σ . Also, as an aid in determining the cause of measurement uncertainty, any of the individual contributors (user calibration (User Cal Uncert), mismatch uncertainty (Mismatch Uncert), ENR uncertainty (ENR Uncert), or jitter uncertainty (Jitter Uncert) may be excluded from the uncertainty analysis.

Using ENR Tables

ENR tables are used to define the noise source(s) used in DUT measurements, receiver, and user calibration(s). Additionally, ENR tables are used along with DUT tables, preamplifier tables, and information collected during the measurement to compute the measurement uncertainty. Refer to **Figure 30-10 on page 676**.

- Both gain and noise figure measurement accuracy will be enhanced by using a noise source with as low a reflection coefficient as possible for both the noise figure measurement and the user calibration.
- It is not necessary to use the same noise source in the user calibration as will be used in the measurement. In some cases, it might be better to use a different noise source in the user calibration than will be used in the measurement. If this is done, it is important to select the ENR table for the calibration noise source prior to the calibration. And, then to select the ENR table for the measurement noise source prior to measuring the DUT.

See also, **“Calibration Wizard” on page 679**.

How to Create an ENR Table

To create an ENR table:

This procedure assumes you have previously set your frequency, resolution bandwidth, and number of points. Refer to **“Example: Typical Noise Figure Measurement Procedure” on page 648**.

For this procedure, refer to **Figure 30-10 on page 676**.

1. Press **Measure** > **Noise Source** > **ENR Mode Table** (default)
2. Then **ENR Table Edit/Save/Recall**
3. Then choose:
 - Edit ENR Table** (to modify the currently loaded ENR table)
 - New ENR Table** (to create a new table)
 - Save ENR Table** (to save any changes to the currently loaded ENR table)
 - Recall ENR Table** (to recall a previously saved table)
 - Back** (to return to previous softkey menu)
4. Then edit the table as necessary for your devices and measurements by entering in Header, Auto-populate, ENR, ENR uncertainty, On $|\Gamma|$, and Off $|\Gamma|$. Refer to **Figure 30-10 on page 676**.

Figure 30-10 Editing ENR Tables

Use knob. Press [Edit] to make changes. Press [Done] to exit. Tue, 03 Apr 2018 10:53:24 AM Page 1/1

Setting	Value			
Header				
File Type	ENR			
Version	1.0			
Serial Number	MY44420707			
Model Number	346C			
Options				
Cal Date	20170801			
Cal Due Date	20180801			
Temperature (°C)	24			
Humidity (%)	40			
ENR Uncert Cov	2 σ			
Γ Spec Style	95th %ile			
Γ Distribution	Rayleigh			
Auto Populate				
ENR	0.000 dB	Off		
ENR Uncert	0.000 dB	Off		
On Γ	0.200	On		
Off Γ	0.100	Off		
Frequency				
10.000 MHz	13.640 dB	ENR Uncert	On Γ	Off Γ
		0.000 dB	0.200	0.000

1. Three additional header fields (used for uncertainty calculations)
 –ENR Uncert Cov
 – Γ Spec Style
 – Γ Distribution

2. Auto Populate fields are not part of the file. These fields are only used to assist in filling the table values.
 (when a given auto-populate value is turned on, its value fills in the associated values in the table).

Buttons: Edit, Next Page, Previous Page, Add Row, Delete/Clear, Done

About ENR (*.enr), Preamplifier (*.amp), and DUT (*.dut) Files

This section contains the following:

- “ENR (*.enr) Files” on page 676
- “Preamplifier (*.amp) Files” on page 677
- “DUT (*.dut) Files” on page 677

ENR (*.enr) Files

- ENR files are saved to, and recalled from, the **NoiseFigure\ENR** folder. If the folder does not already exist on a USB or SD card, it is created automatically before storing the file.
- ENR files are stored as *.enr files. Existing ENR files that are loaded into the FieldFox can be overwritten. Your edited file will NOT be overwritten when firmware is updated.
- To **DELETE** a *.enr file, use the Manage Files feature. Learn more in “Manage Files” on page 776.

Preamplifier (*.amp) Files

- Preamplifier (*.amp) files are saved to, and recalled from, the **NoiseFigure\Preamp** folder. If the folder does not already exist on a USB or SD card, it is created automatically before storing the file.
- Preamplifier files are stored as *.amp files. Existing *.amp files that are loaded into the FieldFox can be overwritten. Your edited file will NOT be overwritten when firmware is updated.
- To **DELETE** a *.amp file, use the Manage Files feature. Learn more in **“Manage Files” on page 776**.

DUT (*.dut) Files

- DUT (*.dut) files are saved to, and recalled from, the **NoiseFigure\DUT** folder. If the folder does not already exist on a USB or SD card, it is created automatically before storing the file.
- DUT files are stored as *.dut files. Existing *.dut files that are loaded into the FieldFox can be overwritten. Your edited file will NOT be overwritten when firmware is updated.
- To **DELETE** a *.dut file, use the Manage Files feature. Learn more in **“Manage Files” on page 776**.

Using Markers (Noise Figure)

In addition to the features shown here, noise figure has many of the same marker features as other FieldFox modes. See also **“All about Markers” on page 692.**

Figure 30-11 Marker Annotation

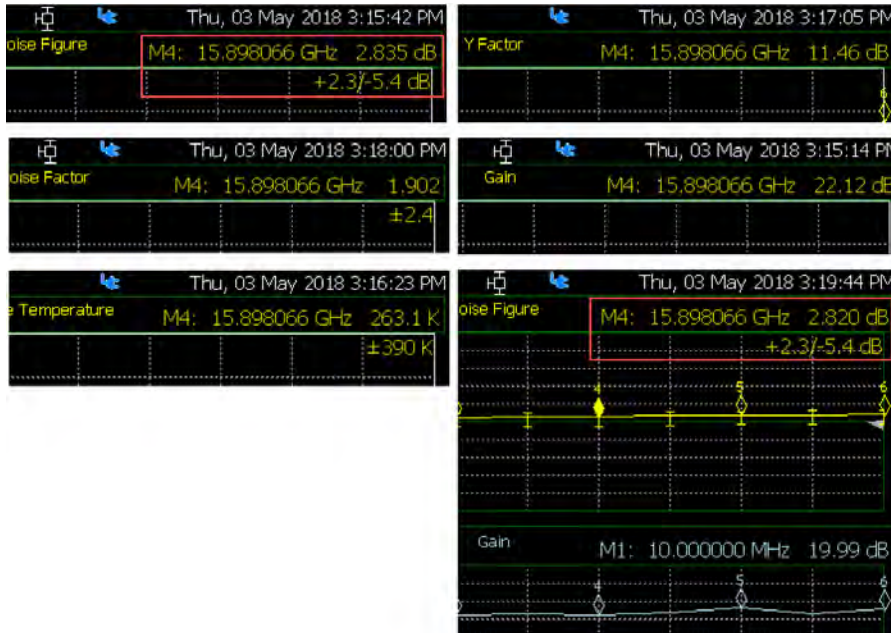

Marker annotation
 - Marker readout in top right corner of graticule.
 - Displays uncertainty values for select measurements.
IMPORTANT! Noise Figure has asymmetric uncertainty (see red box in figure). Noise Factor and Noise Temperature have symmetric uncertainty.

Figure 30-12 Marker Table Annotation



Marker table annotation
 under the graticule.
 - Marker table data under the graticule.
 - Displays uncertainty values for select measurements.

IMPORTANT! Noise Figure has asymmetric uncertainty (see red box in figure). Noise Factor and Noise Temperature have symmetric uncertainty.

Calibration Wizard

The Noise Figure mode has two types of calibration wizard softkeys: Receiver Cal and User Cal.

NOTE

A receiver calibration is required for a user calibration. On the Fieldfox, after you have completed a user calibration, the User Cal (USER CAL) annotation overwrites the displayed Receiver Cal (RCVR CAL) annotation.

To access the calibration wizards:

- Press **Cal** then
 - **Run Receiver Cal** or
 - **Run User Cal** and then
 - follow the prompts

When to Calibrate

Noise Figure has two different calibrations that are important to run, depending on the type of measurement you are using:

- Receiver calibrations (required for all measurements).
- User calibrations (required, if the setup uses an external preamplifier).

Understanding Receiver and User Calibrations

This section contains the following:

- “Receiver Calibration (Receiver Cal):”
- “User Calibration (User Cal):”
- “User Calibration (User Cal):”
- “Optimizing Measurement Accuracy:”

Receiver Calibration (Receiver Cal):

NOTE

When there is no preamplifier in the measurement, only a receiver calibration is required.

The receiver calibration's purpose is to establish the true measurement bandwidth of the receiver when making noise measurements. This bandwidth information is used to calculate the gain of the DUT when there is no user calibration. But, if there is a user calibration, the gain calculation is independent of the receiver bandwidth from the receiver calibration. The

receiver calibration has virtually no influence on the noise figure measurement, either with or without a user calibration. The receiver calibration only effects the gain measurement, and only when there is no user calibration.

As already stated, the receiver calibration measures the measurement bandwidth of the receiver. In most cases, this is set primarily by the digital processing of the receiver. The receiver calibration is needed, because it is influenced by the IF analog circuitry of the FieldFox. Additionally, the bandwidth is extremely stable, and does not vary significantly with time or temperature. So, once the receiver calibration has been successfully performed there is no need to repeat the receiver calibration.

Exceptions: Re-do the receiver calibration when the FieldFox receiver hardware is changed (factory repair) or in the rare case where a filter is added to the measurement system which has a narrower bandwidth than the receiver (i.e., the external bandwidth is less than the lowest resolution bandwidth (Res BW) setting of 300 kHz).

User Calibration (User Cal):

NOTE

Performing a user calibration is recommended only when the measurement setup includes a preamplifier. The user calibration is unnecessary for accurate measurements when no preamplifier is used.

In general, a user calibration should be performed whenever a preamplifier is used in the noise figure measurement. If there is no preamplifier, the user calibration is not necessary.

Although it will be interpolated if other frequencies are used, when a user calibration is performed, it should be made at the same frequencies as the measurement. The user calibration also needs to be performed with the same resolution bandwidth as is used in the measurement. The user calibration determines the noise contribution of the preamplifier, so that it can be removed from the measurement when computing the noise figure of the DUT. Also, the user calibration establishes the power gain of the receiver–preamplifier system so that the reported gain of the DUT will be the gain between input of the DUT (where the noise source is connected during the measurement) and the calibration plane (which is the point where the noise source is connected during the user calibration). Therefore, for the best gain accuracy, the noise source used in the calibration, should be connected at the same point as the DUT will be during the measurement.

Optimizing Measurement Accuracy:

- Both gain and noise figure measurement accuracy will be enhanced by using a noise source with as low a reflection coefficient as possible for the user calibration.

Noise Figure Mode (Option 356 – CPU2 Only)
Calibration Wizard

- When the DUT output noise power is relatively low (i.e., the gain plus noise figure of the DUT is less than 15 dB), measurement accuracy may also be improved by using a low loss isolator on the preamplifier input. Due to the output reflection coefficient of the DUT, reverse noise waves from the preamplifier, when present, will contribute a different amount of noise power during the measurement of the DUT than during the user calibration. And, this change in receiver noise power can impact the measurement accuracy.
- It is not necessary to use the same noise source in the user calibration as will be used in the measurement. In some cases, it might be better to use a different noise source in the user calibration than will be used in the measurement. If this is done, it is important to set the ENR table for the calibration noise source prior to the calibration, and to set the measurement noise source prior to measuring the DUT.
- Prior to starting a user calibration, it is a good practice to connect the preamplifier and noise source that will be used during the user calibration and perform a noise figure measurement of the preamplifier itself (without a user calibration). Use the same bandwidth and frequency settings that will be used in the user calibration. A successful noise figure measurement ensures that all of the connections (bias, control, and RF) have been made properly. The user calibration can be started immediately following the successful noise figure measurement of the preamplifier, with no change to the setup.

How to use Auto-Integration

CAUTION

For optimum speed and performance measurement results, it is recommended that auto-integration is used in all noise figure measurements.

This section provides an example procedure for measuring a device using noise figures' auto integration feature. This example does not use an external preamp and was performed over a long time duration. Auto-integration is recommended to achieve greater accuracy and speed for all of your device measurements. Refer to [Figure 30-14 on page 686](#) and [Figure 30-14 on page 686](#).

For the following example, these settings were used on the FieldFox with a Keysight 346C K01 noise source that had the following characteristics:

Keysight 346C K01 characteristics at 50 GHz

ENR of 11.8 dB

Noise figure 8.7 dB

Gain 9.5 dB

Total Noise = 18.2 dB above kTB.

FieldFox N9952A noise figure (as tested): 39.3 dB

NOTE

For this example, the cold noise generation of the 346C K01 is 21.1 dB below the FieldFox's noise power (i.e., $39.3 \text{ dB} - 18.2 \text{ dB} = 21.1 \text{ dB}$).

About Auto-Integration

With auto integration, the FieldFox Noise Figure application chooses the optimum integration time for each of the noise power measurements needed (i.e., noise source on, noise source off, and receiver reference) to compute the device's noise figure with the selected amount of measurement jitter in the shortest possible time. The auto integration feature calculates the time required to satisfy the jitter goal from the relative power levels as they are measured. One significant advantage of auto integration is that it ensures that the best possible instrument speed is used in achieving the necessary jitter requirement.

If, on the other hand, it is determined that the time required to meet the jitter goal exceeds the maximum allowed time set by the user, auto integration will divide the maximum allowed time between the power measurements in order to produce the smallest possible jitter in the noise figure measurement. In

these cases, since the jitter goal has not been reached, a jitter warning marker will appear on the data trace (unless disabled by the user), indicating that the jitter goal could not be achieved within the selected time constraint.

Due to the stability of the FieldFox receiver with its internal reference switch and the design of the auto integration feature, it is possible to achieve a stable, accurate, low jitter measurement results even under challenging measurement conditions, such as when measuring low noise power output devices at high frequencies with no pre-amplifier, by setting very long maximum integration times. For example, stable measurements with 0.1 dB jitter and no discernible drift have been demonstrated measuring a low gain, low noise amplifier at 50 GHz using maximum integration times of 5000 seconds per point, in spite of ambient temperature drift of several degrees Centigrade over the course of the measurement.

While auto integration can achieve very low jitter measurements, it is a good practice to consider the contribution of the jitter uncertainty to the total measurement uncertainty when selecting a jitter goal. If the measurement uncertainty from other contributors is known to be 0.5 dB, for example, it would make little sense to set a jitter goal of 0.1 dB. Setting a jitter goal of 0.3 dB in this case would only increase the RSS uncertainty to 0.58 dB, and would potentially speed up the measurement by a factor of 9 relative to a jitter goal of 0.1 dB. Auto integration makes it possible to select the jitter level with confidence, and is therefore a valuable tool in obtaining the required level of accuracy with the fastest possible measurement time.

Auto-Integration Procedure

No user cal was performed for this measurement, because no external preamp was used.

Set the equipment up in an area where it will remain undisturbed for the determined amount of measurement time. Refer to [Figure 30-13 on page 685](#) and [Figure 30-14 on page 686](#). See also, [Figure 29-1 on page 642](#) and [Figure 29-1 on page 642](#).

1. Enter the Measurement type:

Select **Measure** > **Noise Figure** (default)

2. Enter the Noise Source ENR information into a table:

NOTE

If you have previously saved your noise source's ENR information into a table, skip this step and proceed to step 4.

Select **Measure Setup**

Then choose:

- **Noise Source** then
- **ENR Mode Table** (default)

– **ENR Table Edit/Save/Recall**

– **Edit ENR Table**

- Enter the serial number and model number of your noise source. If desired, enter other information (e.g., Options, Cal Date, etcetera).

Enter a value using the numeric keypad, the **▲▼** arrows, or the rotary knob.

- **Done** to finish table and return to previous menu.

3. Save the ENR table:

If you are not familiar with saving and recalling files, refer to **Chapter 32, “File Management.”** and then to **“Saving and Recalling Files” on page 768.**

Choose:

– **Save ENR Table**

Enter the filename of your noise source.

Enter a value using the numeric keypad, the **▲▼** arrows, or the rotary knob.

- **Done** to finish table and return to previous menu.

4. Enter the noise figure measurement’s frequency, number of points, and span settings:

– **Freq/Dist** > **Center** > 50 GHz

– **Sweep 3** > **More** > **401 points**

– **BW 2** > **Span** > 0 Hz

5. Define the noise figure’s integration settings:

Meas Setup 4 > **Integration**

Then choose

– **Mode Auto** (default)

– **Jitter Goal** > 0.10 dB

– **Max. Time/Pt** > 300s

– **Jitter Warning ON** (default)

– **Back** to return to previous menu

Press **Uncertainty** then

– **Uncert. Bars ON**

6. Leave the setup to run for desired time.

Figure 30-13 Example of Jitter Uncertainty (401 points)–with Uncertainty Bars

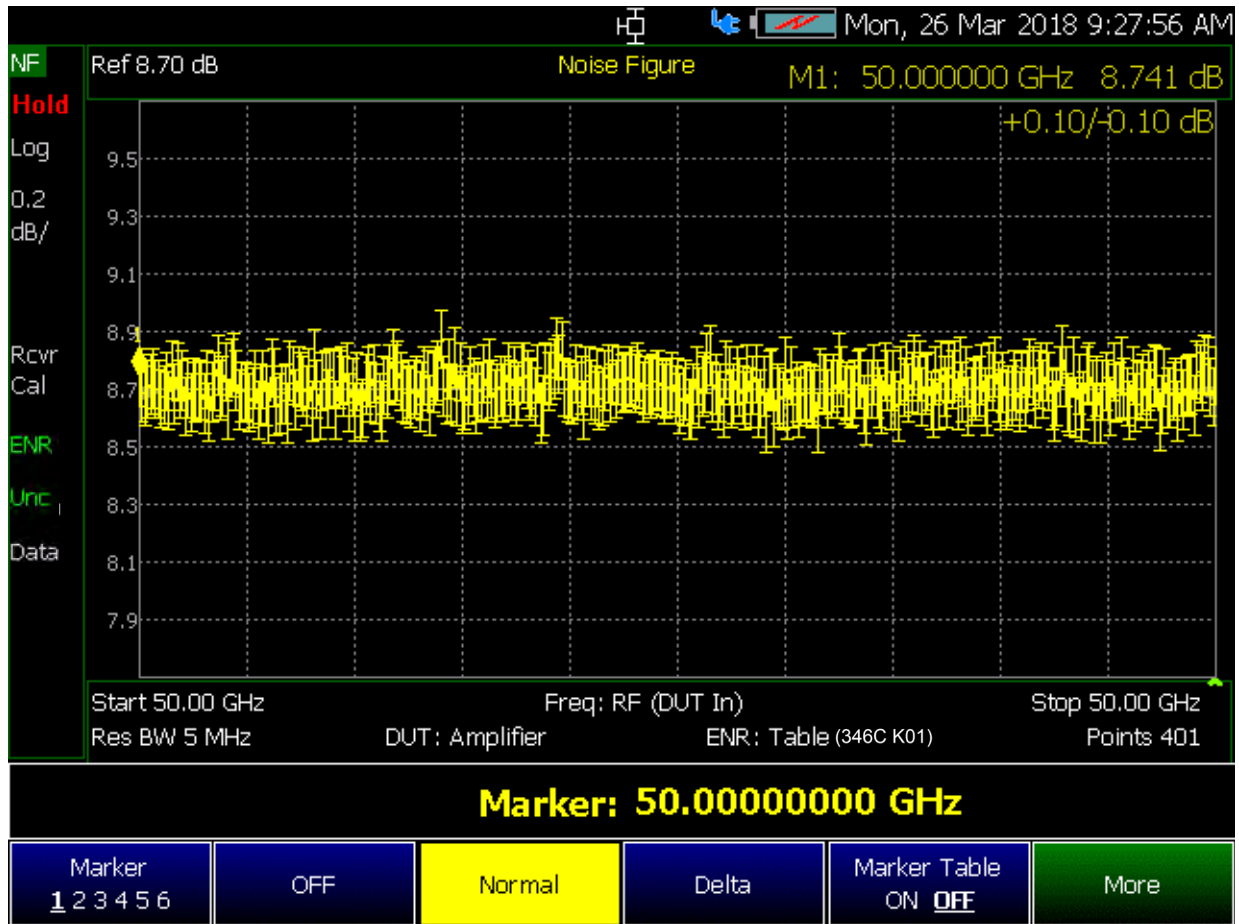
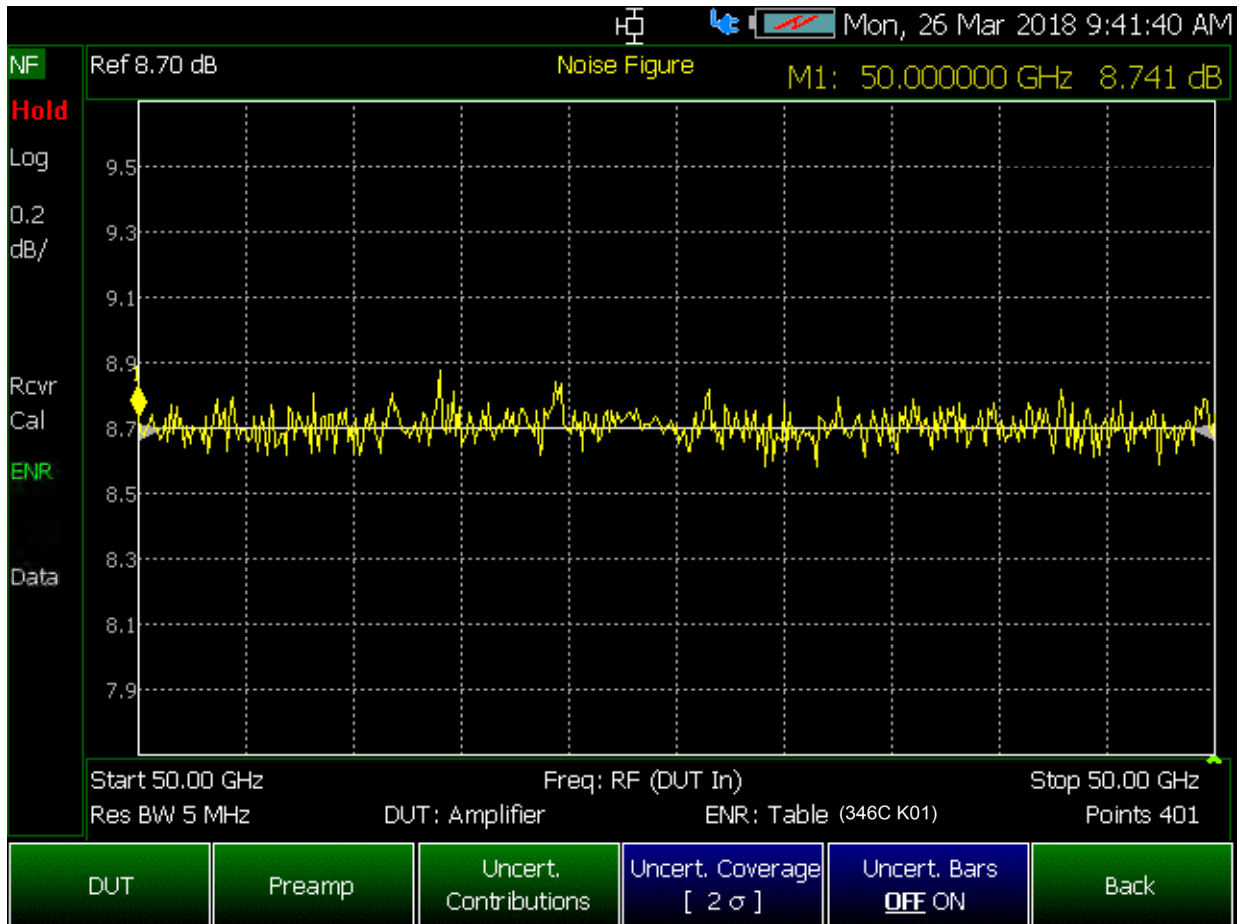

Figure 30-14 Example of Jitter Uncertainty (401 points)–without the Uncertainty Bars



Noise Figure Mode (Option 356 – CPU2 Only)
How to use Auto-Integration

Figure 30-15 shows an example of a noise figure visual Jitter Warning elements that can be enabled/disabled (i.e, blue circles around points where the jitter goal was exceeded).

- Press to toggle **Jitter Warning OFF ON** (default = ON)

Figure 30-15 Example of Jitter Uncertainty—with Jitter Uncertainty Trace

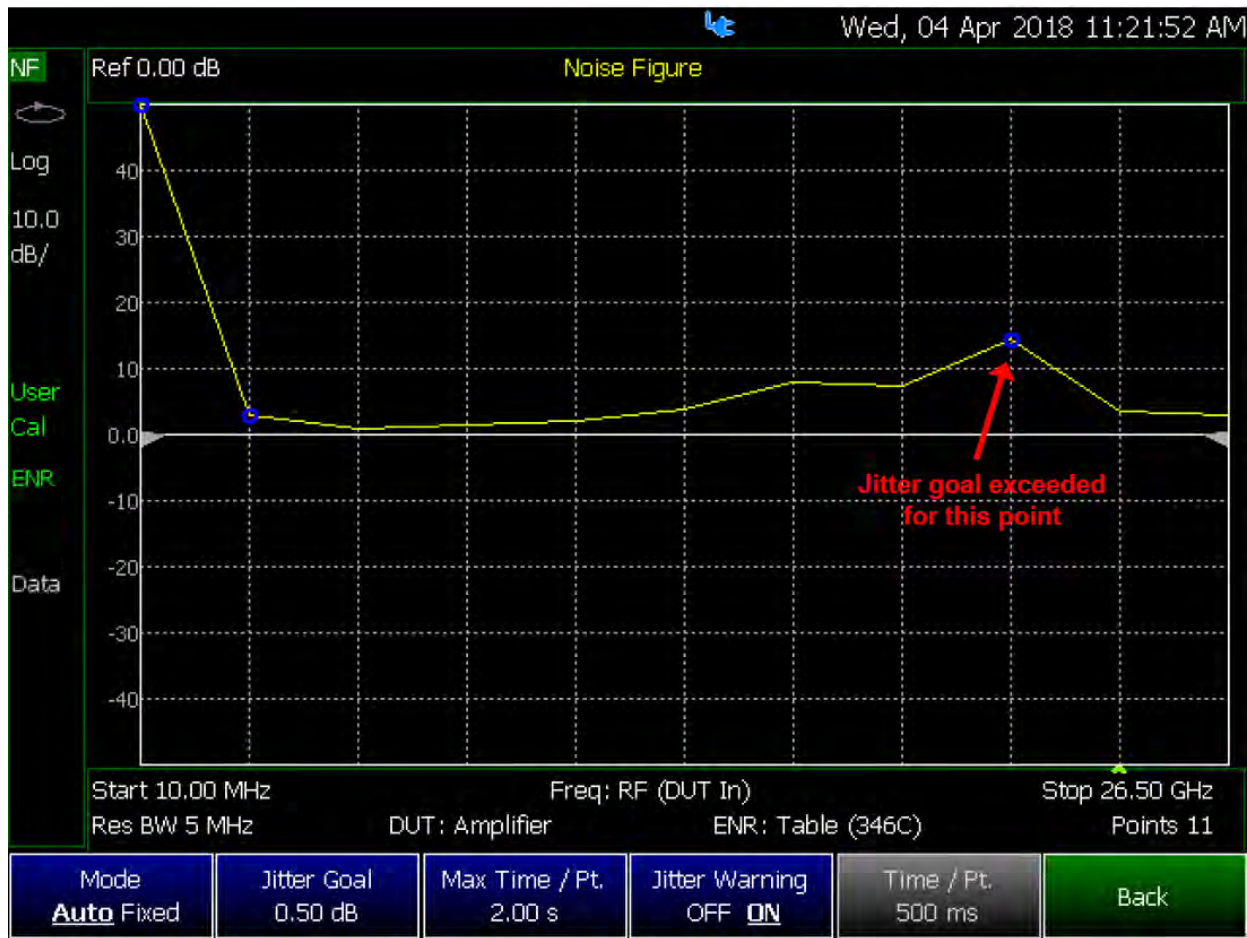

Other Features Available

- **Limit Lines** - For information on using Limit Lines, refer to [“All about Limit Lines” on page 707](#).
- **Display Lines** - For information on using Limit Lines, refer to the SA chapter’s section, [“Display Line” on page 220](#).
- **Scale Settings** – For information on using Autoscale, Autoscale All, and Scale settings, [“All about Scale Settings” on page 714](#).

Troubleshooting

Some measurements can result in invalid results (NaNs). In these cases the FieldFox's Noise Figure Option 356 displays the following:

- Red X on the NaN point
- Marker readout displays: “---”
- SCPI will return its NaN representation (i.e., 9.91E+37)

Figure 30-16 Example of an invalid measurement

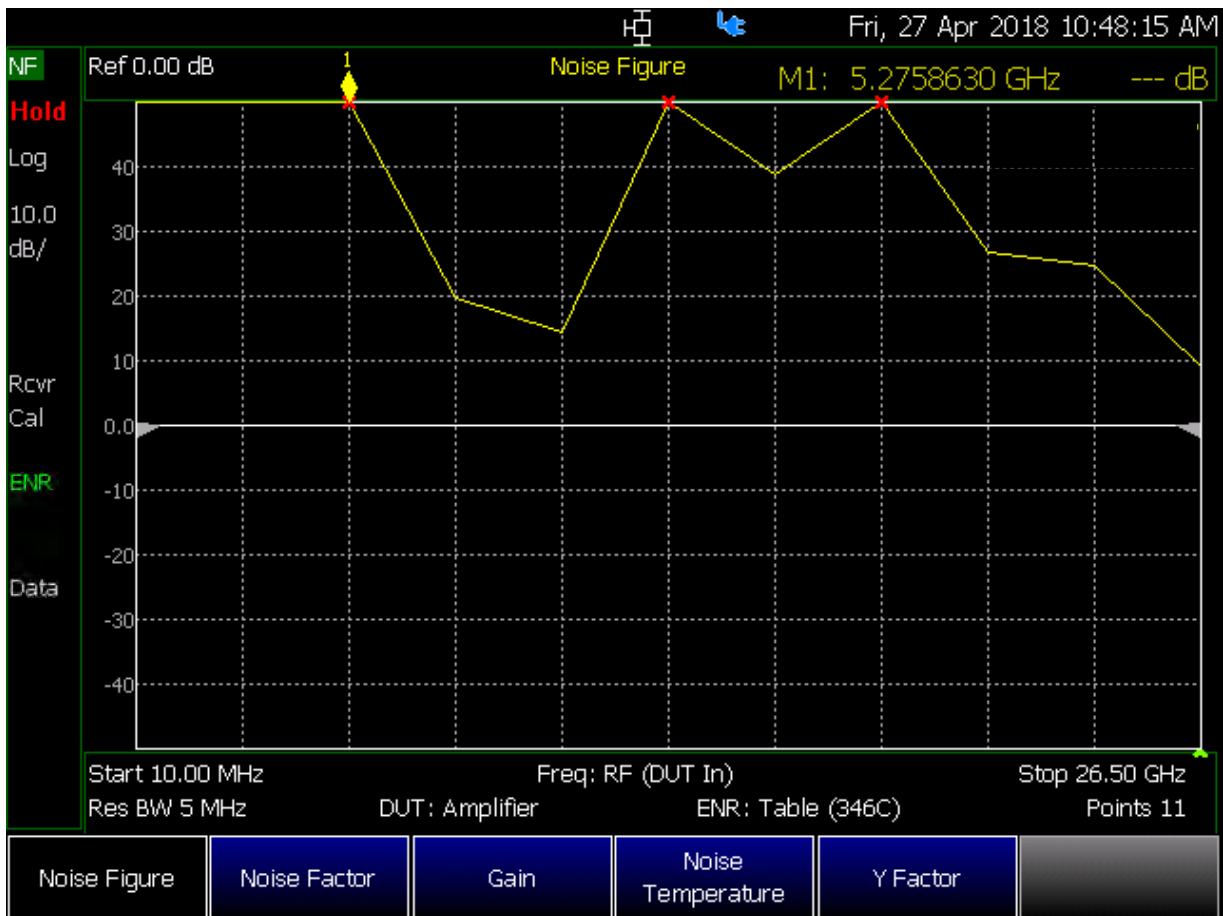

Noise Figure Mode (Option 356 – CPU2 Only)
Troubleshooting

29 Data Analysis Features

The following features can be used after a measurement to analyze the results.

In this Chapter

- “How to create Markers” on page 692
- “How to move a Marker after it is created” on page 692
- “About Delta Markers” on page 693
- “Marker Table” on page 694
- “Coupled Markers (NA Mode)” on page 695
- “Marker Trace (CAT, NA, NF Modes)” on page 696
- “Marker Trace (IQA and SA Mode)” on page 696
- “Marker Format” on page 697
- “Searching with Markers” on page 698
- “What Is a ‘Peak’” on page 703
- “Marker Functions” on page 705
- “SA Marker Functions” on page 706
- “How to Create Fixed Limit Lines” on page 707
- “Relative Limit Lines” on page 708
- “Build From Trace” on page 708
- “Limit Options” on page 709
- “How to Save and Recall Limits” on page 710
- “How to display data and memory traces” on page 712
- “How to perform Trace Math ” on page 712
- “About Math Operations” on page 713
- “How to Use Scale Settings” on page 714

All about Markers

Markers move along the X-axis range of the measurement trace to provide a numerical readout of each measured data point. Markers also allow you to search for specific Y-axis values.

A trace can contain up to six markers.

The marker readout on the FieldFox screen displays X and Y-axis information for the current active marker ONLY.

A Marker Table can be displayed that allows you to simultaneously view X and Y-axis information for all markers.

Markers can be used in **CAT, I/Q Analyzer, NA, NF, RTSA, SA**, and **Pulse Measurements** Modes.

How to create Markers

- Press **Marker**.
- Then **Markers 1...6** to select a marker to activate.
- Then **Normal** to activate that marker. A marker is created on the trace in the middle of the X-axis. That marker is now **active**.
- Then move the marker using the rotary knob, the **▲▼** arrows, or by entering an X-axis position with the number keys.
- Then press **Enter**.

How to move a Marker after it is created

- Press **Marker**.
- Then **Markers 1...6** repeatedly until the marker of interest is selected. The OFF, Normal, Peak, or Delta softkey is black to indicate the current setting of each marker.
- Then move the marker as when it was first created.
- Markers can also be moved using one of the marker search functions. Refer to **“Searching with Markers” on page 698**.

Figure 29-1 Marker 2 is Active, marker 1 is NOT active.

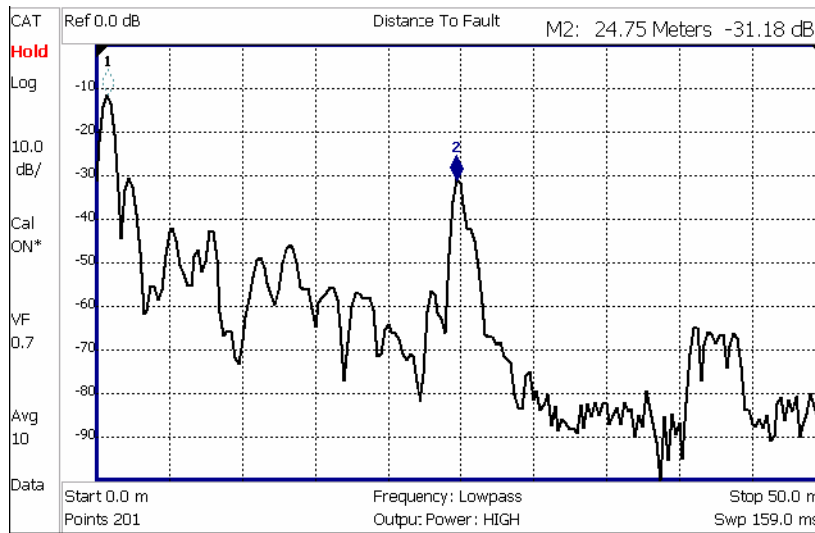

About Delta Markers

A Delta marker provides X-and Y-axis readout information that is **relative** to a 'reference' marker.

A Delta marker is created with a Δ (delta symbol) to distinguish it from the reference marker.

All six markers can be a Delta marker pair.

Peak search functions can be performed using delta markers.

Figure 29-2 A Delta marker and its associated reference marker.

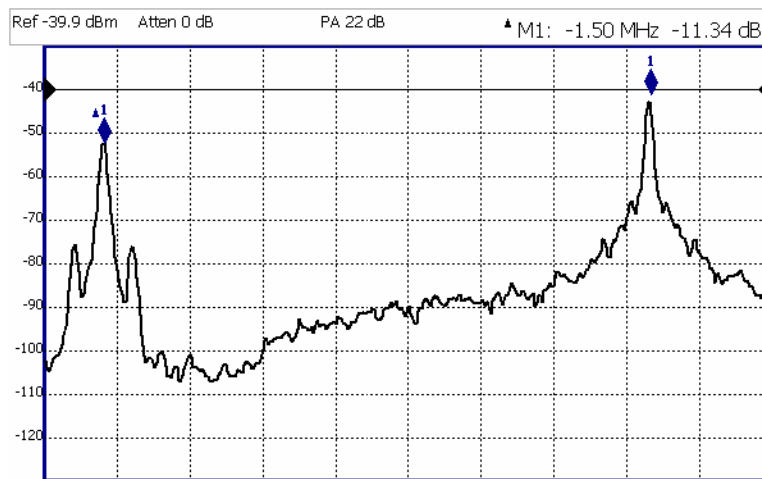

In the graphic above, the marker readout shows the difference between the two markers in frequency and amplitude.

How to Create a Delta Marker

- Create a **Normal** marker and move it to the reference position.
- Press **Delta**. The marker becomes the reference marker and fixed in its X-Axis position.
- Move the **Delta** marker using the numeric keypad, the **▲▼** arrows, or the rotary knob.
- Press **Enter** when finished.

How to move the Reference marker

- Press **Normal** to turn the Delta marker OFF.
- Move the marker to the new position.
- Then press **Delta** again, to turn the Delta marker back ON.

Fix the position of the Reference marker (I/Q Analyzer, RTSA, and SA Modes ONLY)

In SA mode, the reference marker can be fixed at the Y-axis position of the data trace when the marker was created, or it can 'float' with each sweep at the Y-axis position of the data trace. In CAT and NA mode, the reference marker always floats with the data trace.

- Create a Delta marker.
- From the **Mkr ->/Tools** menu, press **More** (SA mode only), then **Marker Properties**, then **Delta Ref Fixed**
 - **OFF** – The reference marker floats at the data trace Y-axis position.
 - **ON** – The reference marker is fixed at the Y-axis position of the data trace when the marker was created (default IQA and SA modes).

Signal Track Marker (NF and SA Mode ONLY)

In NF and SA mode, the marker can be peaked at the Y-axis position of the data trace and the marker is centered on the screen. This setting applies to all NF and SA markers.

- Create a Signal Track marker (peak).
- From the **Mkr ->/Tools** menu, press **More**, then **Marker Search**
 - **OFF** – The reference marker floats at the data trace Y-axis position.
 - **ON** – The reference marker is peaked at the Y-axis position of the data trace and the marker is centered on the screen.

Marker Table

The Marker Table can be displayed at the bottom of the FieldFox screen. It can display information for up to 6 markers in a full-width window, and up to 3 markers for a half-width window (NA mode). The marker table "squeezes" the graticule area when activated.

How to display the Marker table

- Press **Marker**.
- Then **More**
- Then **Marker Table On Off**.

Coupled Markers (NA Mode)

NOTE

I/Q Analyzer (IQA) mode has coupled markers. but the behavior is different than the NA mode Coupled Markers behavior. Refer to **“Coupled Markers (Waveform Only)”** on page 314.

Coupled Markers, available in NA mode only¹ and allows you to simultaneously create and move markers that have the same number for all traces. For example, when marker 2 is created on a trace, a marker 2 is created for ALL traces. When any marker 2 is moved, they all move together to the same X-axis position.

- Coupled markers are allowed only in NA mode and are relevant only in multi-trace configurations.
- You can have markers that are coupled and others that are uncoupled.
- Peak functions move the marker to the peak on the active trace, while all other markers move to the same X-axis position.

Figure 29-3 Coupled Markers move on ALL traces at the same time (NA shown).

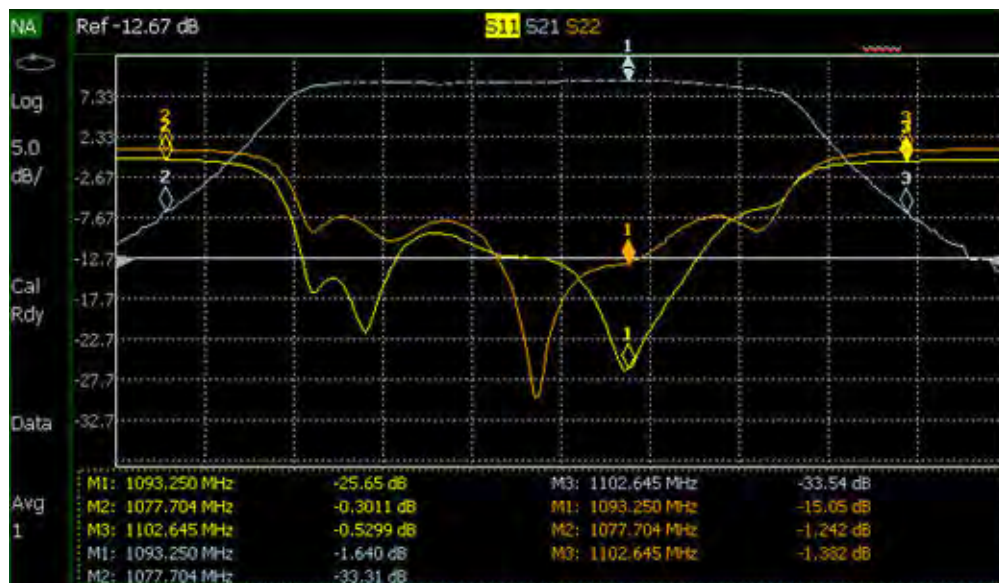

1. IQA mode has coupled markers, but the behavior is different than NA mode's coupled markers. Refer to **“Coupled Markers (Waveform Only)”** on page 314.

How to create Uncoupled Markers

NOTE

Markers are coupled by default.

To create markers that are NOT coupled (move independently on each trace):

- Press **Marker**
- Then **More**
- Then **Coupled Markers OFF**

Marker Colors

As shown in the above image, in NA and CAT Modes, markers are the same color as the trace to which they are assigned. In SA Mode, the marker color is NOT the same as the trace.

Marker colors can NOT be changed.

Marker Trace (CAT, NA, NF Modes)

The Marker Trace setting is used to move markers between the data trace and memory trace.

When Coupled Markers is ON, this setting applies to the active marker for ALL traces that are coupled. Otherwise, this setting applies to the active marker on only the active trace.

How to move a CAT, NA, and NF mode marker between traces

- With at least one marker present, press **Marker** then **More**.
- Then select the marker to move using **Marker 1,2,3,4,5,6**.
- Then toggle **Marker Trace Auto Data Mem**.
 - **Auto** - Marker resides on data trace when it is visible. Marker resides on memory trace when only IT is visible (Default setting).
 - **Data** - Marker resides on data trace, even when not visible.
 - **Mem** - Marker resides on memory trace, even when not visible.

Marker Trace (IQA and SA Mode)

Marker Trace determines the trace number on which a marker resides. A marker is created on, or can later be changed to, the trace number specified by the Marker Trace selection. When changed, a marker moves to the same X-axis location on the specified trace.

Learn more about IQA Traces in [“Trace Display States \(IQA Mode\)” on page 317](#).

Learn more about SA Traces in [“Trace Display States \(SA Mode\)” on page 208](#).

How to move an IQ and SA mode marker between traces

- With two or more traces present, press **Marker** and **Enter** to create a marker. The marker is created on the current Marker Trace selection (default setting is 1).
- Then **More**
- Then select the marker to move using **Marker 1,2,3,4,5,6**.
- Then toggle **Marker Trace 1,2,3,4**
 - The selected marker is moved to the specified trace.
 - When a marker is moved to a 'blank' trace (not visible) the marker moves to the same X-axis position at either the Y-axis position of the last data, or to the ZERO position.

Marker Format

The Marker Format setting allows you to choose the format of the marker readout that appears in the upper-right corner of the screen and in the marker table. The marker format can be independent of the trace format, and can be set independently for each trace. All markers on a trace have the same marker format.

How to choose marker format

- Press **Marker**
- Then **More**
- Then **Marker Format**
- For **NA Mode** measurements, choose from the following:

Selection	Example Y-axis value
Default Same as displayed format	
R + jX Complex impedance format (3rd number is distance for Time Domain)	22.8Ω -j61.4Ω 287.9fF
Z Magnitude Impedance Mag.	66.08Ω
Phase	73.8°
Real	0.2003
More	
Imaginary	-0.6727
Mag & Phase	0.705, -73.7°
dB Angle	-2.1 dB, -138.2°

There are more trace formats available than marker formats. To display marker readouts in more formats than are shown here, change the trace format, then select **Default**. Learn how to change format in **“Format” on page 106**.

- For **TDR (CAT) Mode**, choose from **Default** and **Z Mag**.

Searching with Markers

Marker Searches are used to move markers to locations on the trace which exhibits the characteristics of the search criteria. Learn ‘What is a Peak’ in **“What Is a ‘Peak’” on page 703**.

How to Search with Markers

The following menu structure applies to NA Mode. Keystrokes will be slightly different for CAT, Pulse Measurements, and SA Modes.

- Activate the marker to be used for the search (NOT necessary with Bandwidth search.)
- Then press **Mkr ->/Tools**.
- Then choose one of the following:
 - **Tracking ON OFF** (NA Mode ONLY)
 - **ON** causes the active marker to search for the specified criteria with each new sweep. Search criteria can include: Target, Bandwidth, Peak, Min. The searches begin with the first sweep after Tracking is turned ON, based on the current search type. **Trk** appears next to the marker number.
 - **OFF** causes a new marker search only when the search feature is re-executed.
 - **Peak** Moves the active marker to the HIGHEST amplitude data point of the trace. Peak Excursion and Peak Threshold value is ignored. In SA Mode, the LO feed-through signal (0 Hz) is also ignored.
 - **Next Peak** Moves the active marker to the next highest amplitude data point of the trace. Peak Excursion value is ignored.
 - **Mkr -> Center** Moves the current active selected marker to the center frequency for the current frequency range displayed.
 - **Mkr -> RefLev** Moves the current active marker to the acquisition.
 - **Minimum** (Not available in DTF, RTSA, SA, or I/Q Analyzer) Moves the active marker to the LOWEST amplitude data point of the trace.
 - **Min Search** (I/Q Analyzer, RTSA, and SA modes Only) Moves the active marker to the LOWEST amplitude data point of the trace. If a marker is turned off, it is turned on before the minimum search is performed.
 - **Target** (NA Mode and Pulse Measurements ONLY) Enter the Target value. The marker moves to the first occurrence of the Target value to the right of its current position. The FieldFox interpolates between measured data points to find the exact Target value to two decimal points. The interpolated X-axis value is displayed in the marker readout or marker table. Subsequent presses of the Target softkey cause the marker to move to the right to

find the next occurrence of the Target value. When the marker reaches the end of the stimulus range, it “wraps around” and continues the search from the beginning of the stimulus range.

- **Bandwidth ON OFF** (NA Mode ONLY) Use to quickly toggle BW Markers ON and OFF. When OFF, the marker table appears showing the X and Y-axis positions of all enabled markers.
- **Bandwidth** (NA Mode ONLY) Specify the level in dB from the peak or valley where bandwidth is measured.
 - **Negative** numbers search for a **Peak** bandpass, such as a filter S21 response.
 - Either of the following TWO methods can be used to search for a **Valley** or Notch filter, such as the S11 response of a bandpass filter.
 - **Negative** values search down from the TOP (MAX) of the response.
 - **Positive** values search up from the BOTTOM (MIN) of the notch.
 - If you first enter Negative, then Positive values, it may be necessary to press **Marker**, then **More**, then **Markers All Off**.

Figure 29-4 S21 of a filter with BW Markers and associated readout values. The search criteria is -3 dB.

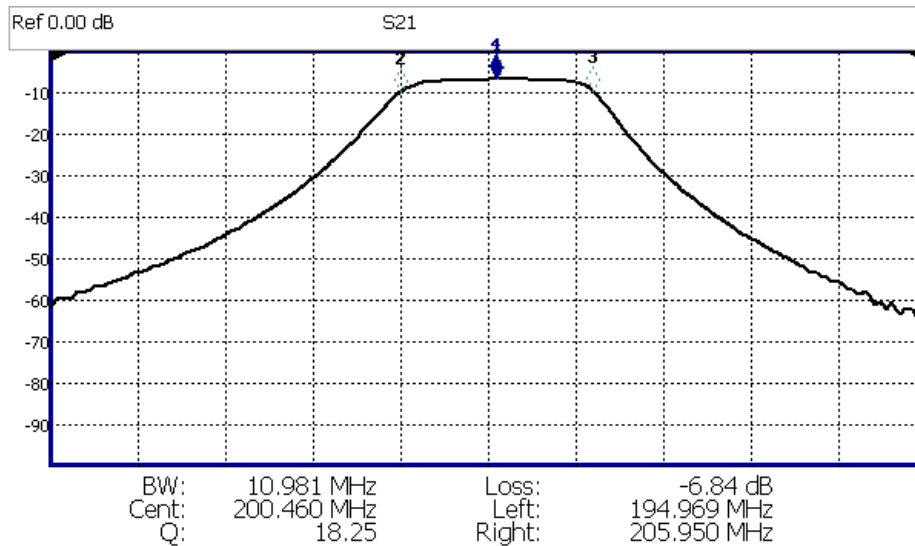
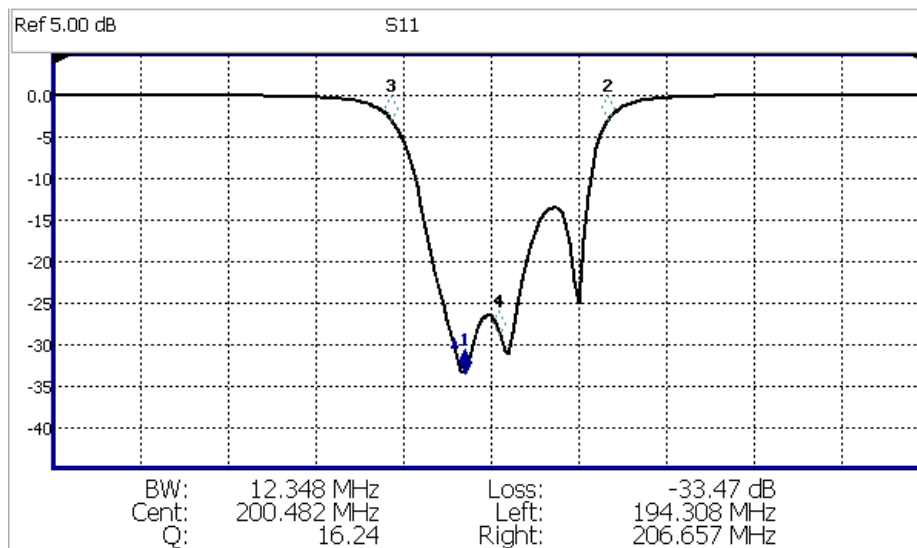

Figure 29-5

S11 of the same filter with same search criteria: -3 dB.
The same values would result from a search criteria of approximately +30.4 dB.



After pressing **Bandwidth**, four markers are automatically created to find the first negative or positive bandpass over the displayed frequency range.

Bandwidth Search can be used ONLY with Log Mag display format.

- The following six values are displayed for Bandwidth Search:
 - **BW**: Width of the filter. (marker 2 freq) **minus** (marker 3 freq).
 - **Center**: Marker 4 frequency. Mathematical midpoint between marker 2 and marker 3.
 - **Q**: Center Frequency / Bandwidth.
 - **Loss**: Marker 1 amplitude.
 - **Left**: Frequency of marker 2 or 3 (to left of marker 1).
 - **Right**: Frequency of marker 2 or 3 (to right of marker 1).
 - Press **Back** to return to the previous menu.

Press **Peak Search** then choose from the following:

- **Peak** Moves the active marker to the HIGHEST amplitude data point of the trace. Peak Excursion value is ignored. In SA Mode, the LO feed-through signal (0 Hz) is also ignored.
- **Next Peak** Moves the active marker to the next highest amplitude peak from where it currently resides.
- **Peak Left** (Not IQA) Moves the active marker to the next data point to the left that meets the 'Peak' criteria. When no data points to the left meet the 'Peak' criteria, the marker does not move.

- **Peak Right** (Not IQA) Moves the active marker to the next data point to the right that meets the 'Peak' criteria. When no data points to the right meet the 'Peak' criteria, the marker does not move.

The following applies to DTF Measurements ONLY:

- **More** then:
 - **Track Peaks ON OFF** When Track Peaks is ON, markers will find the new peak with every sweep. While in this Mode, the markers can NOT be turned OFF or moved.
 - **Find 3 Peaks** Three markers are created and find the highest peaks (faults) on the trace.

The following applies to IQA Measurements ONLY:

- **More** then:
- **Min Search** Moves the active marker to the minimum frequency (IQA displays time) currently displayed on the screen.
- **Mkr Properties** then:
 - **Peak Criteria** then refer to **“How to set Peak Criteria” on page 703:**
 - **Delta Ref Fixed** Enables or disables the delta reference fixed marker.
- **Peak Left** (IQA Spectrum Only) Moves the active marker to the next data point to the left that meets the 'Peak' criteria. When no data points to the left meet the 'Peak' criteria, the marker does not move.
- **Peak Right** (IQA Spectrum Only) Moves the active marker to the next data point to the right that meets the 'Peak' criteria. When no data points to the right meet the 'Peak' criteria, the marker does not move.

Using Mkr5/Mkr6 to find mins/maxs between Mkr1 and Mkr2 / Mkr3 and Mkr4 (CAT and NA Mode)

Use this feature to search minimum and maximum values within sub-spans defined by Mkr1 and Mkr2, and Mkr3 and Mkr4. This facilitates measuring minimum and maximum values on your uplink and downlink channels, or only in the passband of a DUT. Use in conjunction with marker table and limit lines to verify your DUT's signals and to adjust or tune as needed. See also, **“All about Limit Lines” on page 707.**

When markers are set to Normal, Mkr5 and Mkr6 can be used to find the minimum and or maximum values between Mkr1 and Mkr2 (using Mkr5) and Mkr3 and Mkr4 (using Mkr6). Refer to [Figure 29-6 on page 703](#).

NOTE

If your Markers are positioned and in Normal marker mode, no changes are made to the Mkr1 through Mkr4 settings.

If your Markers are not previously positioned and in Normal marker mode, when you select the Mkr5 and Mkr6 maximum and minimum setting, your markers are set as follows:

- Markers are all set to **Normal**
- Mkr1 and Mkr3 are set to 1/4 full span
- Mkr2 and Mkr4 are set to 3/4 full span

How to use the Mkr5 and Mkr6 markers to find maximums and minimums between your Normal markers (CAT and NA Mode):

This section assumes you understand the previous marker features. And, that you have previously positioned your markers (Mkr1 and Mkr2 or and Mkr3 and Mkr4) and set the markers up as **Normal** markers using [“How to create Markers” on page 692](#) and other previous marker sections. For example, if your markers are set to **Delta**, change to **Normal**, and verify the marker positions are correct. Refer to [Figure 29-6 on page 703](#).

- Then press **Mkr ->/Tools**.
- Then **More** (For DTF, TDR measurements, and NA Mode, skip this step and proceed to the next step.)
- Then **Mkr5 & Mkr6 Search**
- For Mkr1 & Mkr2 maximum or minimum value search:
 - Then **Mkr5 Peak** or
 - **Mkr5 Min**
- Or for Mkr3 & Mkr4 maximum or minimum value search:
 - Then **Mkr6 Peak** or
 - **Mkr6 Min**

Figure 29-6 CAT Mode Mkr5 and Mkr6 Search Example

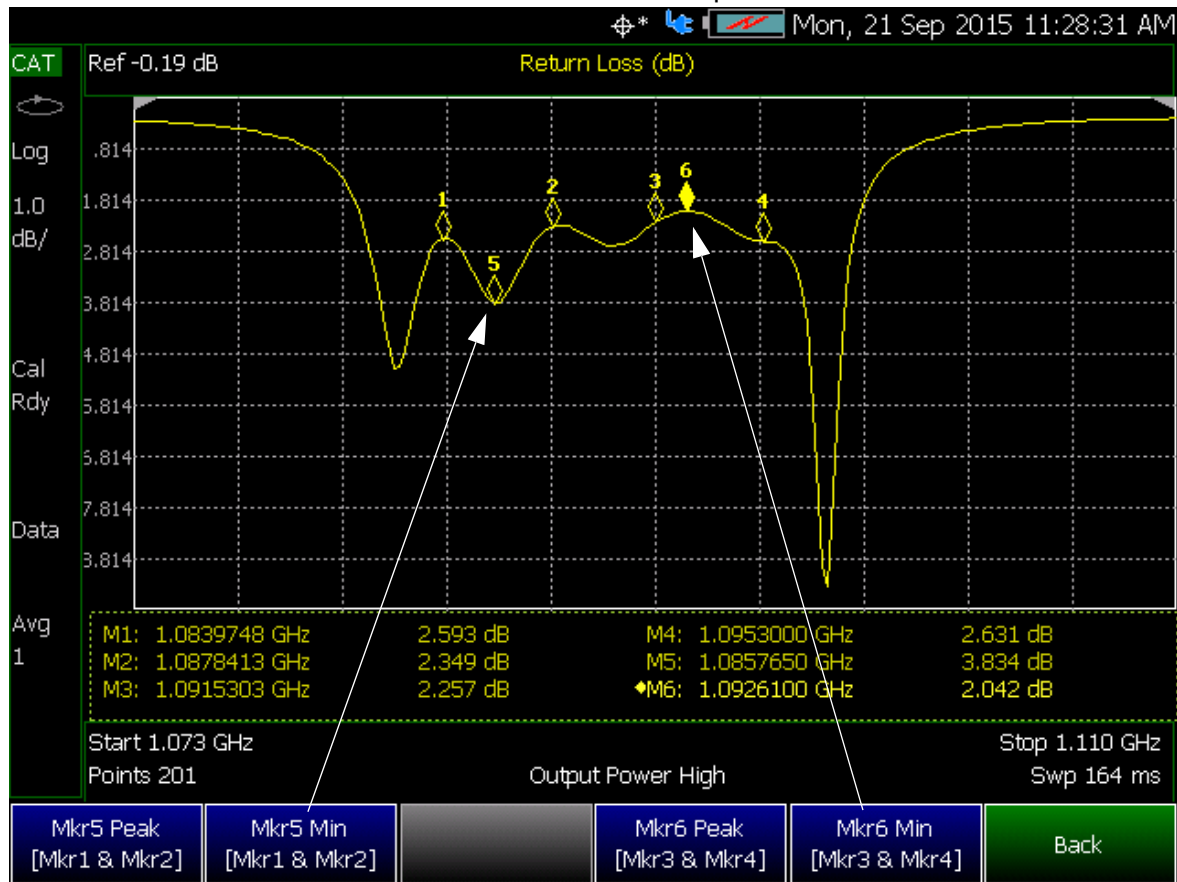

What Is a 'Peak'

You define what the FieldFox considers a "peak" by setting the Peak **Threshold** and Peak **Excursion** and for I/Q Analyzer Only **Cont Peak Search**.

These two peak criteria settings are set individually for each trace and for each mode (CAT, SA, or NA).

These settings do NOT survive a FieldFox or Mode Preset.

NOTE

The Peak Threshold and Excursion settings are NOT available in DTF measurements. To make these settings, create a non-DTF CAT mode measurement, then change the measurement back to DTF.

How to set Peak Criteria

- Press **Mkr ->/Tools**.
- In **CAT** and **NA** modes:
 - Then **Peak Search**.
 - Then **Peak Criteria**

- In **IQA** (Spectrum) and **SA** mode:
 - Then **More**
 - Then **Mkr Properties**
 - Then **Peak Criteria**
- In **IQA** (Waveform) mode:
 - Then **Mkr Properties**
 - Then **Peak Criteria**

After selecting Peak Criteria for CAT, IQA, NA, or SA mode:

- Then select the following:
 - Peak Threshold** Minimum amplitude (dB). To be considered valid, the peak must be above the threshold level. The valley on either side can be below the threshold level.
Default = -190 for CAT and NA Modes; -90 for SA Mode.

NOTE

CAT mode Loss measurements are displayed in positive values. In these cases, the Peak Threshold setting is inverted. For example, Peak Threshold = -20 will consider any peak that has less Loss than 20 dB to be valid.

- Peak Excursion** The vertical distance (dB) between the peak and the valleys on both sides. To be considered a peak, data values must “fall off” from the peak on both sides by the excursion value. Default = 0.5 dB for CAT and NA Modes; 6 dB for SA Mode.
- Cont Peak Search** (I/Q Analyzer Only) Enables or disables the Continuous Peak Search marker. When Continuous Peak Search is on, a peak search is automatically performed for the selected marker after each sweep. The rules for finding the peak are exactly the same as for Peak Search, including the use of peak criteria rules. See also, **“Using Markers (IQA)” on page 312.**
- Delta Ref Fixed** Enables or disables the delta reference fixed marker.

Peak Excursion and Peak Threshold example—the settings for the trace in the following image are:

- Threshold: -10 dB
- Excursion: 1 dB
- Scale = 1 dB / Division.

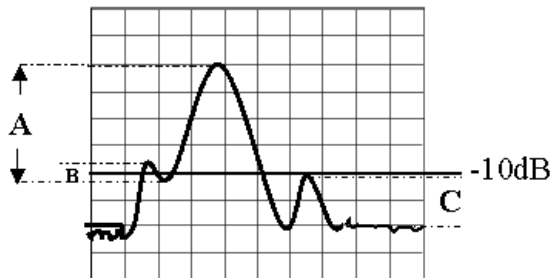

Peak A = **Valid Peak** (Above Threshold and Excursion Settings)

Peak B = Invalid Peak (Below 1 dB Excursion Setting)

Peak C = Invalid Peak (Below -10 dB Threshold Setting)

Marker Functions

Marker functions are used to change FieldFox frequency or distance settings to those of the active marker.

How to use Marker Functions

- Activate the marker to move.
- Then press **Mkr ->/Tools**
- Then **Mkr ->** (this step not required for I/Q Analyzer mode)

Then choose one of the following:

- **Mkr -> Center** (**Not** available in DTF, I/Q Analyzer (waveform), or SA mode with zero span) The center frequency of the measurement becomes the value of the active marker. The frequency span is adjusted accordingly.
- **Mkr -> Delay** (NA mode ONLY.) The group delay value of the active marker becomes the electrical delay setting of the trace. Learn how to set group delay format in **“Calibration Settings” on page 105e**. Learn more about electrical delay in **“Electrical Delay” on page 109**.
- **Mkr -> RefLev** (IQ Analyzer (NOT waveform) and SA mode ONLY) The acquisition becomes the magnitude of the active marker.
- **Mkr -> TuneFreq** (SA mode with Tune & Listen ONLY) The Tune & Listen Frequency becomes the frequency of the active marker.

The following applies to DTF Measurements ONLY:

- **More** then:
- **Mkr->Start Distance** The Start Distance of the measurement becomes the value of the active marker. Markers that would no longer appear on the screen are moved to the new Start Distance.
- **Mkr->Stop Distance** The Stop Distance of the measurement becomes the value of the active marker. Markers that would no longer appear on the screen are moved to the new Stop Distance.

I/Q Analyzer (IQA) Marker Functions

The following Marker Functions are available in I/Q Analyzer Mode ONLY (exceptions are noted):

- Noise Marker (Available in SA mode)
- Band/Interval Power Marker (Available in SA mode)
- Coupled Markers
- Band Span
- Interval Band Span
- Continuous Peak Search

Learn more about Noise and Band/Interval Power marker functions starting in the IQA chapter here: **“Noise Marker” on page 312.**

SA Marker Functions

The following Marker Functions are available in SA Mode ONLY (exceptions are noted):

- Noise Marker (Available in I/Q Analyzer mode)
- Band/Interval Power Marker (Available in I/Q Analyzer mode)
- Frequency Counter at Marker
- Audio Beep with Marker
- Time Zero Fixed Marker

Learn more about these marker functions starting in the SA chapter here: **“Noise Marker” on page 221.**

All about Limit Lines

Limit lines are visual representations, drawn on the FieldFox screen, of the specified limits for a measurement. With this capability, you can easily compare measured data versus specifications. Optionally, you can enable an audible beep and display **Pass or Fail** information for each measurement.

NOTE

IMPORTANT! For CAT and NA modes, limit lines do not apply where $F1 = F2$.

- You can have up to as many limit line segments as there are data points for each measurement trace allowing you to test all aspects of your measurements.
- Limit lines are available in CAT Mode, NA Mode, NF Mode, and SA Mode. Power Meter Mode uses different limit settings. Learn more in [“Limits” on page 542](#).
- Limit lines and limit testing are NOT allowed in NA Mode with **Smith Chart** or **Polar** display formats.
- A simple Display Line is also available in I/Q Analyzer, NF, and SA Modes ONLY. Learn more in [“Display Line \(I/Q, NF, and SA Modes Only\)” on page 711](#).
- Limit lines can be saved and recalled with an *.sta file. Learn more in [“How to Save and Recall Limits” on page 710](#). They can also be saved and recalled independently from the Limit softkeys. Learn more in [“How to Save and Recall Limits” on page 710](#).

How to Create Fixed Limit Lines

There are two ways to build a Fixed limit line:

1. **Build (limits) From a Trace.** Learn how in [“Build From Trace” on page 708](#).
2. **Enter X/Y data points into the on-screen editor.** The limit line is formed as the FieldFox ‘connects the dots’ on the screen. To create frequency gaps that are NOT tested, use separate limit lines. The X-axis values for two lines can overlap.
 - Press **Limit 8**.
 - Then **Edit Limits**. A limit line table appears.
 - Use the Up / Down arrows and rotary knob to navigate the cursor to the following editable cells.
 - **Description** – Press **Edit**, then enter a description for the limit line using the FieldFox labeler. Learn how in [“How to use the FieldFox labeler ” on page 770](#).
 - **Fixed/Relative** – Press **Edit** to toggle between the following:
 - **Fixed** – the limit line does not move. The X/Y coordinates are absolute locations on the screen.
 - **Relative** – the limit line moves relative to the center frequency and acquisition.
Note: It is easiest to first create Fixed Limits, then change this setting to Relative. Learn more [“Relative Limit Lines” on page 708](#).
 - **Upper/Lower** – Press **Edit** to toggle between the following:

- **Upper** - FAILS any measured data point **ABOVE** the line.
- **Lower** - FAILS any measured data point **BELOW** the line.
- **Off/On** – Press **Edit** to toggle between the following:
 - **On** - Limit line is drawn on the screen and PASS/FAIL testing occurs.
 - **Off** - Limit line is NOT drawn on the screen and testing does NOT occur.
- **Frequency** – Enter a numeric X-axis value of the data point.
- **Amplitude** – Enter a numeric Y-axis value of the data point.
- Press **Add** then choose from the following:
 - **Add Point** – Adds a blank X/Y data point below the cursor.
 - **Add Limit** – Adds a default limit line below the current limit.
- Press **Clear** then choose from the following:
 - **Clear Point** – Removes the X/Y data point on which the cursor resides.
 - **Clear Limit** – Removes the limit Line on which the cursor resides.
 - **Clear All** – Removes ALL limit lines.
- Press **<Back** to return to the Limit menu.

Relative Limit Lines

Relative limit lines are X/Y coordinates that are referenced to the center frequency (X-axis) and acquisition (Y-axis).

Use relative limits to test devices or signals that are identical except for the center frequency or amplitude. With relative limit lines in place, you change the center frequency of the measurement and the limits look as though they are in the same location.

The same is true for acquisition. When you expect to measure a different power level, instead of changing the Y-axis value of all of the fixed limits, simply change to relative limits. The limits will then remain a constant Y-axis distance from the acquisition.

Each limit line can be changed at any time from Fixed to Relative, and Relative to Fixed.

How to Create a Relative Limit Line

The easiest way to create a Relative limit line is to create a Fixed Limit at a specific center frequency and acquisition. Learn how **“Relative Limit Lines” on page 708**. Then change the limit line to Relative. The X/Y data points will be re-calculated relative to the center frequency and acquisition.

Build From Trace

A limit line can be built from an existing trace. One X/Y point is made from each measured data point. Then, using an offset value, you can shift the limit line UP for upper limits or DOWN for lower limits.

Once limit lines have been built from the trace, changes that you make to the trace, such as frequency range, do NOT change the limits. However, the limit line properties can be edited just like standard limit lines.

Figure 29-7 A lower limit line (red) built from the trace (yellow) shifted down 5 dB.

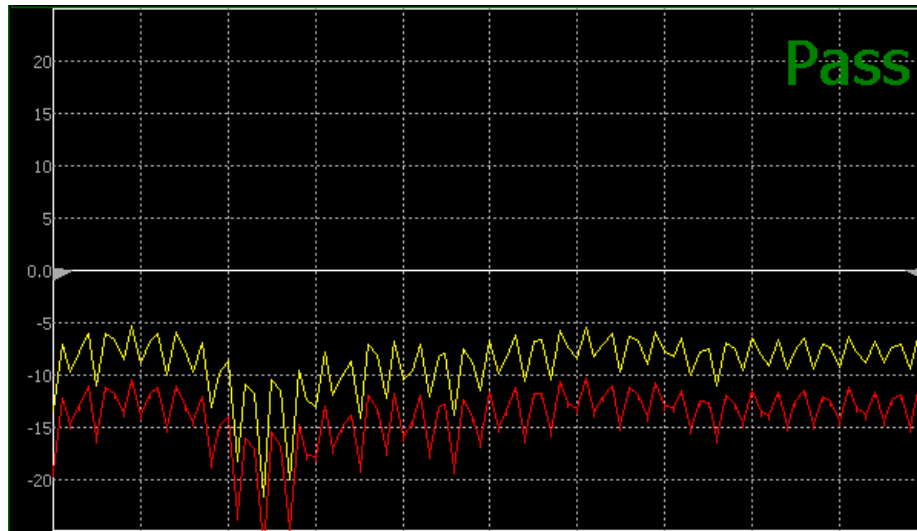

How to Build Limit Lines from a Trace

NOTE

Build from Trace is NOT allowed for traces with more than 1001 data points.

- Select the trace from which limits will be built.
- Press **Limit 8**.
- Then **Edit**.
- Then **Build From Trace**. A limit line table appears.
- Use the **▲▼** arrows to select ON.
- Use **Offset** to shift the limit line UP or DOWN. Learn how below.

Limit Options

How to set Limit Options

- Press **Exit** if the limit table is visible.
- Then **Options**.
- Then choose from the following:
 - **Beep**

- **On Pass** Audible beep sounds when a sweep passes.
- **On Fail** Audible beep sounds when a sweep fails.
- **Off** No audible beep sounds.
- **Warning On Off** Shows Pass or **Fail** indication on the display with each sweep. Data points that fail are highlighted.
- **Limit Type** Then Fixed or Relative.
- **Offset** Shifts the limit line up or down. Enter an offset value using the rotary knob, the **▲▼** arrows, or by entering a value with the number keys.
 - Enter a **positive** offset to shift the limit line UP, usually used with UPPER limits.
 - Enter a **negative** offset to shift the limit line DOWN, usually used with LOWER limits.
- **Margin** Shifts the limit line up or down like an offset, but only virtually. The limit line does NOT appear to move. Enter a Margin value using the rotary knob, the **▲▼** arrows, or by entering a value with the number keys.
 - Enter a **positive** margin to virtually shift the limit line UP.
 - Enter a **negative** margin to virtually shift the limit line DOWN.

How to Save and Recall Limits

- Press **Save/Recall** then **Device** to set the Device (Internal, SD card, or USB flash drive) to be used for the Save or Recall. Learn more in **“Set File Type and Select Device” on page 773**.
- Then press **Limit**.
- Then choose from the following:
 - **Save Limits** After limit lines have been defined, this saves the line definition to a file on the specified device.
 - **Recall Limits** Recalls a limit Line definition from the specified device.

Display Line (I/Q, NF, and SA Modes Only)

A display line is a simple, horizontal line that can be placed at any amplitude level on the SA screen or set to any level in IQA. Use a display line as mental guide for visual feedback. A display line is similar to a Limit Line, except that no PASS/FAIL testing occurs. A display line is easier to create than a Limit Line. Learn more in [“All about Limit Lines” on page 707](#).

Figure 29-8 Display Line with Annotations (SA mode shown, but others are similar)

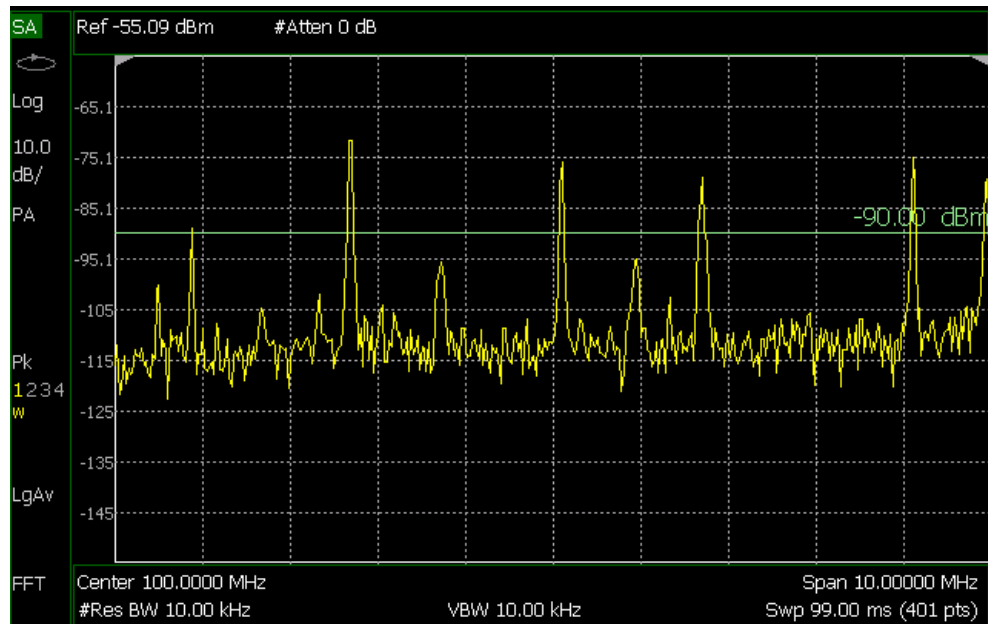

How to create and move a Display Line

- Press **Limit 8**
- Then **Display Line OFF ON**
- Then enter a Y-axis value using the **▲▼** arrows or the rotary knob, then press **Enter**. Or enter a value using the numeric keypad and press a suffix key or press **Enter**.

All about Trace Math

Trace Math is available in **CAT** (excluding DTF measurements), **NA** Mode, and FOPS (under USB Power Meter mode).

NOTE

Noise Figure (NF–Opt. 356) does not have trace math, but does have the ability to display data and memory traces. Refer to “**How to display data and memory traces**”.

A trace is a series of measurement data points that are connected to form a line. This ‘live’ data trace is updated as data points are measured.

A memory trace is a live trace that has been stored in the FieldFox volatile memory. It then becomes static, meaning it is not updated with measurements. It can be displayed on the screen by itself, or with a data trace for comparison purposes.

- In NA mode, memory traces are the same color as data).
- In CAT mode and FOPS, the data trace is displayed in **yellow** and the memory trace is displayed in **blue**.

How to display data and memory traces

- Press **Trace 6**.
- Press **Math and Memory** then **Data->Mem** to store the current live trace into memory. A ‘beep’ sounds to confirm the data trace has been saved to memory. There is no display annotation that indicates that the memory trace has been stored.
 - Press **Data** to view only the data trace.
 - Press **Memory** to view only the memory trace.
 - Press **Data & Memory** to view both the live trace and the stored memory trace.

How to perform Trace Math

Trace math is performed between a live trace and a memory trace. When one of the following math operations are selected, the yellow data trace displays the current measurement with the selected trace math applied. The math operation symbol indicated below in [brackets] is displayed on the lower left corner of the screen.

- Press **Trace 6**.
- If not already stored, press **Data->Mem** to store the current live trace into memory.
- Then **Data Math**.
- Then choose one of the following:
 - **Data + Mem** [D+M] Current measurement data is added to the data in memory.
 - **Data – Mem** [D-M] Current measurement data is subtracted from the data in memory.

- **Data / Mem** [D/M] Current measurement data is divided by the data in memory.
- **Math Off** [Data] Displays trace data with NO math applied.

About Math Operations

Data / Memory and **Data - Memory** math operations are performed on complex linear data before it is formatted. Because data is often viewed in log format, it is not always clear which of the two math operations should be used. Remember: dividing linear data is the same as subtracting logarithmic data. The following illustrates, in general, when to use each operation.

Use **Data / Memory** for normalization purposes, such as when comparing traces “before” and “after” a change is made or when measuring trace noise. In the following table, the Data/Mem values intuitively show the differences between traces. It is not obvious what Data-Mem is displaying.

Values to compare	Data/Mem	Data-Mem
0.5 dB and 0.6 dB	0.1 dB	-39 dB
0.5 dB and 0.7 dB	0.2 dB	-33 dB

Use **Data - Memory** to show the relative differences between two signals. Use for comparison of very small signals, such as the S11 match of two connectors.

In the following table, Data/Mem shows both pairs of connectors to have the same 2 dB difference. However, the second pair of connectors have much better S11 performance (-50 and -52). The relative significance is shown in **Data-Mem**.

Values to compare	Data/Mem	Data-Mem
-10 dB and -12 dB	2 dB	-24 dB
-50 dB and -52 dB	2 dB	-64 dB

All about Scale Settings

NOTE

IMPORTANT! Some of the scale settings do not apply to all of the modes.

How to Use Scale Settings

Adjust the Y-axis scale to see the relevant portions of the data trace. The Y-axis is divided into 10 graticules.

This setting can be changed at any time without affecting calibration accuracy.

How to set Scale

- Press **Scale / Amptd**.
- Then choose from the following three methods:
 1. **Autoscale** Automatically adjusts the Y-axis to comfortably fit the Minimum and Maximum amplitude of the trace on the screen.
 2. Set Scale, acquisition, and Reference Position:
 - **Scale** Manually enter a **scale per division** to view specific areas of the trace.
 - **Ref Level** Manually set the value of the reference line. Enter a negative value by pressing **Run/Hold (+/-)** either before or after typing a value.
 - **Ref Pos** Manually set the position of the reference line. Values must be between **0** (TOP line) and **10** (BOTTOM line).
 - **Range** Manually set the absolute power (dBm).
 3. Set Top and Bottom graticule values. The scale per division is calculated.
 - **Top** to set the value of the Top graticule.
 - **Bottom** to set the value of the Bottom graticule.
 - Enter a negative value by pressing **Run/Hold (+/-)** either before or after typing a value.

Scale annotation on the FieldFox screen

Reference Line = red arrow

Ref Level = -40 dB

Ref Position = 1

Scale = 2 dB per division

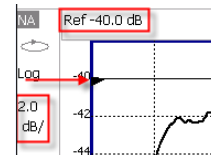

Averaging (CAT, NA, Power Meter, Channel Scanner, and Pulse Measurement Modes Only)

Trace Averaging helps to smooth a trace to reduce the effects of random noise on a measurement. The FieldFox computes each data point based on the average of the same data point over several consecutive sweeps.

Average Count determines the number of sweeps to average; the higher the average count, the greater the amount of noise reduction.

An average counter is shown in the left edge of the screen as **Avg N**. This shows the number of previous sweeps that have been averaged together to form the current trace. When the counter reaches the specified count, then a 'running average' of the last **N** sweeps is displayed. Average Count = 1 means there is NO averaging.

This setting can be changed at any time without affecting calibration accuracy.

NOTE

Averaging is often used to increase the dynamic range of a measurement. To achieve the highest dynamic range, select NA mode and reduce the IF Bandwidth setting. Learn more about dynamic range in [“Increase Dynamic Range” on page 120](#).

How to Enable/Disable Averaging

- Press **BW 2**.
- Then **Average OFF ON** change to ON to enable averaging (Default = OFF).
- Press **Enter**.
- Refer to [“How to set Trace Averaging” on page 715](#).

How to set Trace Averaging

- Press **BW 2**.
- Then **Average N** where **N** is the current count setting.
- Enter a value using the numeric keypad. Enter 1 for NO averaging.
- Press **Enter**.
- While Trace Averaging is in process, press **Sweep 3** then **Restart** to restart the averaging at 1.

Data Analysis Features
All about Scale Settings

30 System Settings

In this Chapter

- “Run/Hold” on page 718
- “Preset” on page 719
- “User Preset” on page 719
- “Audio (Volume) Control” on page 720
- “Display (Settings)” on page 721
 - “Display Brightness” on page 721
 - “Display Colors” on page 721
 - “Trace Width” on page 722
 - “Title” on page 722
 - “Edit Keywords” on page 723
 - “Full Screen Mode” on page 723
- “Utilities” on page 724
 - “How to view and change Utilities Settings” on page 724
 - “Utilities Softkey Choices” on page 724
 - “How to view and change the Frequency Extender (Freq Extnd) Settings” on page 725
- “Preferences” on page 733
 - “Quick Settings Table” on page 733
 - “Save and Reset Preferences” on page 735
 - “Global Settings (Overview)” on page 735
 - “Language” on page 736
 - “Battery Saver” on page 736
 - “Startup Mode” on page 737
 - “File folders” on page 741
 - “Alpha Numeric Editing” on page 742

- “File Saving Naming Options” on page 742
- “System Configuration” on page 747
 - “Options (Licensing)” on page 747
 - “GNSS (GPS+) and GPS” on page 749
 - “Frequency Reference Source” on page 754
 - “Variable Voltage Source (Opt. 309)” on page 755
 - “Security Level” on page 756
 - “Date and Time, Format, and Time Zone Settings” on page 757
 - “LAN Settings” on page 758
 - “Power ON” on page 760
 - “FieldFox Package Installer (N995xA, N996xA, and applies to: N991xA/2xA/3xA units with serial number prefixes \geq 5607)” on page 761
 - “Date and Time, Format, and Time Zone Settings” on page 757
- “Service Diagnostics” on page 763

See Also:



- “Install the Lithium-Ion Battery” on page 38
- “FieldFox High Temperature Protection” on page 40

Run/Hold

The **Run/Hold** key determines whether the FieldFox sweeps continuously or does NOT sweep, but holds the display results of the last sweep that was performed.

Use **Hold** to conserve battery power or to allow you to save or analyze the results of a specific measurement sweep.

The current sweep mode is shown on the screen as:

-  Continuous
- Hold
-  is displayed while a single sweep occurs.

How to perform a single sweep while in Hold

- Press **Sweep 3**.
- Then choose one of the following:

- **Single** Automatically sets Continuous OFF (Hold) and causes FieldFox to make ONE measurement sweep, then hold for the next Single key press.
- **SA Mode ONLY** – With **Continuous OFF** each successive **Run/Hold** press also causes a single sweep.
- **Continuous ON OFF** Makes continuous sweeps. This is the typical setting when battery power is not critical.

Preset

The Preset key restores the FieldFox measurement settings to a known condition. You can preset the entire instrument, or just the current Mode (CAT, SA, and so forth).

When Preset, the FieldFox CalReady calibration is recalled for use in CAT and NA Modes. Learn more in [“CalReady” on page 135](#).

In addition to all **Preference** settings, the following settings always survive Preset and Mode Preset:

- External Reference state (see [“Frequency Reference Source” on page 754](#))
- SA Scale and Units (see [“Scale and Units” on page 168](#))
- SA Correction states (see [“Field Strength Measurements” on page 172](#))
- VVM Display Resolution (see [“Display Resolution” on page 578](#))
- Marker Peak Excursion and Threshold (see [“What Is a ‘Peak’” on page 703](#))

How to Preset the FieldFox

- Press **Preset**.
- Then choose one of the following:
 - **Preset** Returns ALL Modes to the factory default settings.
 - **Mode Preset** Returns only the current Mode to the factory default settings. The current settings for all other Modes remain.

User Preset

User Preset allows you to store custom settings for each mode, then recall the settings when the Preset key is pressed. Your custom settings are saved to a standard State file (UserPreset.sta). However, unlike State files, calibration data is NOT saved. Learn more about State files in [“Set File Type and Select Device” on page 773](#).

How to set User Preset

- Make your custom settings for all modes.
- When finished, press **Preset**.
- Then **Save User Preset**, then select **Yes** to confirm.
- Then **User Preset ON**

How to recall User Preset

- Press **Preset**.
- Then choose from the following:
 - **Preset (User)** The entire UserPreset.sta file is recalled. ALL modes assume the settings that were in place when the User Preset was saved. The active mode is the mode that was visible when the file was saved.
 - **Mode Preset (User)** The settings for only the current mode are recalled from UserPreset.sta.

NOTE

- Only the instrument settings are saved to UserPreset.sta. No trace data or calibration data is saved.
- User Preset ON / OFF is saved as a Preference setting. Like all preferences, this setting survives a FieldFox shut down and power ON. Therefore, when User Preset is ON during shut down, the FieldFox will load UserPreset.sta when it is powered ON.
- To return to Factory Preset, select **User Preset OFF**. The contents of UserPreset.sta remain stored on the FieldFox. When User Preset is OFF, you can also set the Startup Mode preference that determines which mode will be visible after powering ON. Learn more in [“Startup Mode” on page 737](#).

Audio (Volume) Control

System volume control is a FieldFox global setting which sets speaker volume for ALL success beeps, key press clicks, and individual features that use the FieldFox speaker, such as SA Mode Tune and Listen.

The volume control setting remains through a FieldFox Preset. To cause your volume control setting to remain through a FieldFox shut down, save the setting as a Preference. Learn how in [“Save and Reset Preferences” on page 735](#).

How to set the FieldFox Volume Control

- Press **System 7**
- Then **Volume**
- Then use the  arrows, the rotary knob, or numeric keypad to enter a value between 0 (lowest volume) and 100 (highest volume).
- Press **Volume** again and select Mute to quickly turn OFF the speaker volume.
- Press **Volume** again to set volume ON to the previous volume control.

Display (Settings)

You can adjust the FieldFox for optimum viewing in a wide range of lighting conditions.

Display settings are persistent after a FieldFox shut down. Save the display settings as Preferences. Learn how in [“Save and Reset Preferences” on page 735](#).

NOTE

Clean the transfective screen with gentle and minimal wiping using Isopropyl alcohol applied to a lint-free cloth.

Display Brightness

Change the brightness of the background.

How to set Display Brightness

- Press **System 7**
- Then **Display**
- Then **Brightness**
- Use the  arrows, the rotary knob, or numeric keypad to enter a value between 0 and 100%.

Display Colors

Change Display Colors to alter the viewing scheme.

How to set Display Colors

- Press **System 7**
- Then **Display**

System Settings
Display (Settings)

- Then **Display Colors**
- Then choose one of the following:

Indoor



Outdoor Dusk



Outdoor Clouds



Outdoor Sun



Night Vision



Trace Width

You can set width of all displayed traces on the FieldFox. This may allow better viewing or enhance the look of screen images. This setting can be saved with Preferences.

How to set Trace Width

- Press **System 7**
- Then **Display**
- Then **Display Colors**
- Then **More**
- Then **Trace Width**
- Then choose one of the following:
 - **Normal** - Standard width.Wide
 - **Wide** - Enhanced width

Title

A custom title can be made to appear in the upper-left corner of the FieldFox screen. The title can contain up to approximately 65 alpha-numeric characters. To view the Title area, see the Screen Tour in **“Screen Tour” on page 51**.

How to add or edit a Title

- Press **System 7**
- Then **Display**
- Then **Title**
- Then enter or edit a title using the FieldFox labeler. This is the same labeler function that is used to name files. Learn how to use the labeler in [“How to use the FieldFox labeler ” on page 770.](#)
- Then **Title ON OFF** to make the title appear and disappear from the screen.

Edit Keywords

During a file save operation, keywords can be quickly appended to other text to create unique filenames. The Edit Keywords feature allows you to create custom keywords. Learn all about Edit Keywords in [“Edit Keywords” on page 779.](#)

Full Screen Mode

Full Screen Mode maximizes the display of trace. The screen annotations and the soft keys are removed.

- Press **System 7**
- Then **Full Screen**

To **Exit** full screen Mode, press any key.

Utilities

FieldFox utilities settings will not survive a shut down. When your FieldFox is turned OFF, then back ON, these settings default to their factory settings.

NOTE

For information on the **Phase Array Antenna** and **USB antennas** softkeys, refer to [Chapter 14, “5G Rapid Prototype Phased Array Antenna – Option 360.”](#) and “USB Antennas” in [Chapter 15](#).

How to view and change Utilities Settings

- Press **System 7**
- Then **Utilities** Opens the Utilities softkey menu.

Utilities Softkey Choices

Then choose one of the following:

- **Mapping** – (Requires Option 352) opens a menu of softkeys that enables the Indoor / Outdoor on-the-box mapping features. Refer to [Chapter 16, “Indoor and Outdoor Mapping – Option 352 \(Requires Spectrum Analyzer Mode \(Option 233 on N991xA\), and GPS Receiver \(Option 307\)\).”](#)
- **Phased Array Antenna** (PAA – Requires Option 360) – opens a menu of softkeys that enables the PAA measurements. Refer to [Chapter 14, “5G Rapid Prototype Phased Array Antenna – Option 360.”](#)
- **USB Antennas** – opens a menu of softkeys that enables the triaxial antenna feature, for use in EMF measurements. Refer to [Chapter 15, “USB Antennas – \(Full Capability Requires EMF Option 358, and SA mode \(Option 233 Mixed Analyzers\)\).”](#)

- **Freq Extnd** – opens a menu of softkeys that enables frequency extender feature, for use with OML heads. Refer to “**How to view and change the Frequency Extender (Freq Extnd) Settings**” on page 725.

NOTE

IMPORTANT! The Frequency Extender feature uses the Remote Server feature that requires the FieldFox to have CPU2 installed. Refer to the A-Series Configuration Guide, <https://www.keysight.com/us/en/assets/7018-03329/configuration-guides/5990-9836.pdf>.

The Frequency Extender (Freq Extnd) is only active (available) when one of the following modes are enabled: SA/RTSA/IQA/OTA/PAA/VSA (via the Remote Server feature – Requires CPU2).

When OML millimeterwave extenders are used, Cable and Antenna corrections, if On, are included in eCorr, or Extended Corrections.

How to view and change the Frequency Extender (Freq Extnd) Settings

The following are the only supported modes for the frequency extender feature: SA (Option 233, mixed analyzers, RTSA (Option 350), IQA (Option 351), OTA (Option 370/377/378), PAA (Option 360) modes, and VSA (via the Remote Server feature).

CAUTION

IMPORTANT!

When using a frequency extender with the FieldFox under certain conditions, the A-Series FieldFox has low-band sub-harmonics that can become visible and can affect some measurements. To minimize these unwanted sub-harmonics:

- When using the mixer, the LO power should be reduced to -12 dBm and
- Reduce frequency span to make measurements until the “unleveled power” message goes away (requires ≥A.12.40 firmware)

If you upgrade your FieldFox firmware to ≥A.12.40, but find you are unable to adjust the LO power level to -12 dBm, refer to “**Erase User Data**” on page 764.

CAUTION

IMPORTANT!

Due to limitations in the OML hardware, the heads have a 6 GHz frequency span.

Examples

Using a 24 to 40 GHz mixer, you can sweep:

- 24 to 30 GHz and 25 to 31 GHz, but not
- 24 to 31 GHz

Assuming the same 24 to 40 GHz mixer, using OTA mode, you can

- Set a CCO to 24 GHz and CC1 to 31 GHz, but not
 - CC0 to 4 GHz and CC1 to 32 GHz, because you have to remain within the mixer's band
-

CAUTION

PAA and 89600 VSA (via the Remote Server feature) is compatible with the frequency converter heads, but cannot apply or edit the frequency head corrections. Refer to [“Utilities” on page 724](#).

For this section, refer to [Figure 30-1 on page 730](#), [Figure 30-2 on page 731](#), and [Figure 30-3 on page 731](#), [Figure 30-4 on page 732](#), [Figure 30-6 on page 733](#), and [Figure 30-6 on page 733](#).

These settings are used to set up a frequency extender head (e.g., OML head). The frequency extender feature can be used in OTA FR2 measurements. See also, [Chapter 13, “Over-the-Air Measurements \(OTA\) – LTE FDD Option 370, LTE TDD Option 371, 5GTF Option 377 \(CPU2 Only\).”](#)

The frequency extender heads are an external down converter that extends the FieldFox's range. The frequency extender head makes use of the FieldFox's source and uses USB port for power. The FieldFox support for the frequency extender head includes:

- The frequency extender heads are compatible with to SA, IQA, OTA, PAA, RTSA, and 89600 VSA (via the Remote Server feature—with VSA license).

CAUTION

PAA and 89600 VSA (via the Remote Server feature) is compatible with the frequency converter heads, but cannot apply or edit the frequency head corrections. Refer to [“Utilities” on page 724](#).

CAUTION

The OML frequency extenders have approximately 4 to 10 dB of gain depending on the mixer and frequency.

- The USB ports are used to supply power to the head

System Settings
Utilities

- Port 1 is used to supply an LO signal to the head. The LO signal is automatically generated, using the internal source. Therefore the application disables normal Port 1 access to the internal source. But, automatic alignments of the SA Receiver still remain active using an internal path for the source.
- Port 2 is where the head delivers the downconverted signal to the SA receiver.
- High Sensitivity ON OFF selection: able to choose between showing largest span (wide) available (6 GHz) or best noise floor (narrow).

Frequency Extender Procedure

General Comment on Frequency Converter Usage:

OML heads are limited to 6 GHz span.

Example:



If you are using a 24–40 GHz OML head you can sweep:

24–30 GHz and 25–31 GHz, but not:

24–31 GHz

But, in OTA mode, because each frequency is set separately, you can set CC0 to 24 GHz and CC1 to 31 GHz.

But, you cannot set CC0 to 4 GHz and CC1 to 32 GHz. You have to stay within the band of the OML mixer (24-40 in this example), if you are enabling an external head.

1. Press **System** > **Utilities** > **Freq Extnd** > **Select Freq Extnd Head** then
2. To select the frequency extender head, use the numeric keypad,   arrows, or rotary knob to change the value.
3. Press **Recall File** to make the highlighted head the current selection.
4. Press **Freq Extnd ON OFF** to **ON** to enable the OML head. When a compatible mode is enabled, all supported modes annotate **Freq Extnd** at the bottom of the display. See also, step 8.
5. **Optional:** Press **High Sensitivity ON OFF** to **ON** OFF is selected for maximum span (up to 6 GHz). Narrow is selected for lowest noise floor for a given RF input (100 MHz). Default is OFF (maximum span – 6 GHz).
6. **Optional:** Press **Setup Corr Auto Edit SA** when Auto is selected the default corrections for a frequency converter head are automatically loaded ("**...Default.csv**"). These corrections are defaults for the specific head, to improve nominal accuracy of the amplitude readings, but this accuracy is not specified. Press **Edit SA**, when you want to view or edit the corrections using the SA mode corrections. This state stops all auto-loading of the default corrections. Refer to step 8.

The other non-SA supported modes do not allow viewing or editing of the corrections, but they all share the same corrections.

Therefore, any manual changes to the corrections (using SA via Edit SA) are then used by other supported modes (RTSA/IQA/OTA) as well.

7. **Optional:** Press **Apply Corr ON OFF** OFF is selected to not apply the default nominal file corrections. Press to apply corrections for the Converter, all supported modes will apply corrections and annotate "**eCorr**" in the left

panel. The corrections applied (regardless of mode) are either default/nominal (if Auto loading was used) or custom/specific (if manual editing Edit SA was used). Default is OFF.

8. Press **Mode** > and then your preferred mode for testing.

NOTE

IMPORTANT! The softkey menu for editing of the frequency converter correction files is only available when the FieldFox is in SA mode.

- Optional: If you pressed **Edit SA** in step 6 above and want to display and to edit a "*.csv" corrections file then:

- Press **Scale/Amptd** > **More** > **Corrections** > **OML Converter** then:

- a. **Converter** to enable/disable the frequency converter corrections.
- b. **Edit Converter** to opens a corrections table of the currently selected file (*.csv).

To select a setting/value to edit, use the numeric keypad, **▲▼** arrows, or rotary knob to change the value.

Refer to [Figure 30-4 on page 732](#).

CAUTION

It is important to save any changes that are made to the Settings table. If the Setup Corr softkey is reset to Auto, it will recall the last "...Default.csv" used, and any unsaved changes will be lost.

- c. **New** to opens a corrections table of the currently selected file (*.csv), but enables you to create a new converter corrections file. Displays "Overwrite existing Converter data?" Then choose:

- Yes** to clear all of the frequency converter correction table's values and enter your own.

- No** to leave the current correction table values and edit just some of the entries.

To select a setting/value to edit, use the numeric keypad, **▲▼** arrows, or rotary knob to change the value.

Refer to [Figure 30-4 on page 732](#).

- d. **Save Converter** opens a 'labeler' menu where you can name and save your frequency converter corrections file (*.csv) to the default [INTERNAL] : \Converter folder.
- e. **Recall Converter** opens a menu where you can recall a frequency converter corrections file (*.csv).

Storage Device opens a menu where you can change the storage location of your frequency converter correction files (*.csv). (Default = Internal. Else, SD Card or USB.)

See also, Chapter 13, "Over-the-Air Measurements (OTA) – LTE FDD Option 370, LTE TDD Option 371, 5GTF Option 377 (CPU2 Only)."

Figure 30-1 FieldFox with OML Downconverter



Figure 30-2 FieldFox Frequency Converter High Sensitivity (ON: Narrow—Lowest Noise Floor—Displayed)

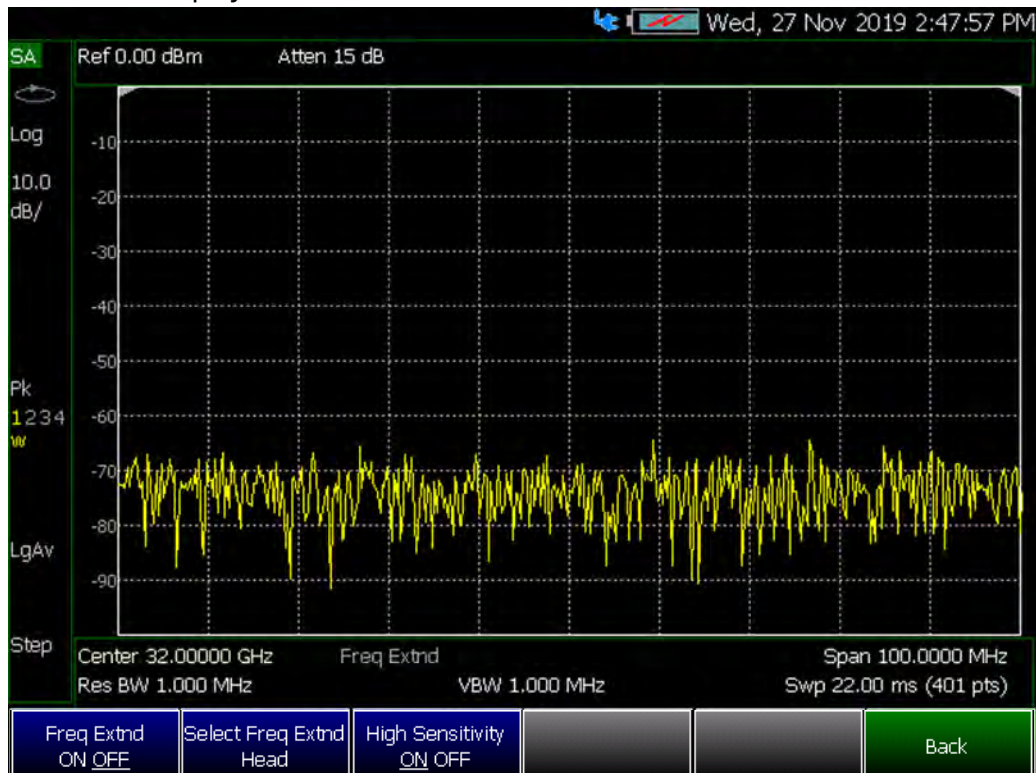

Figure 30-3 FieldFox Frequency Extender Select Frequency Extender Head

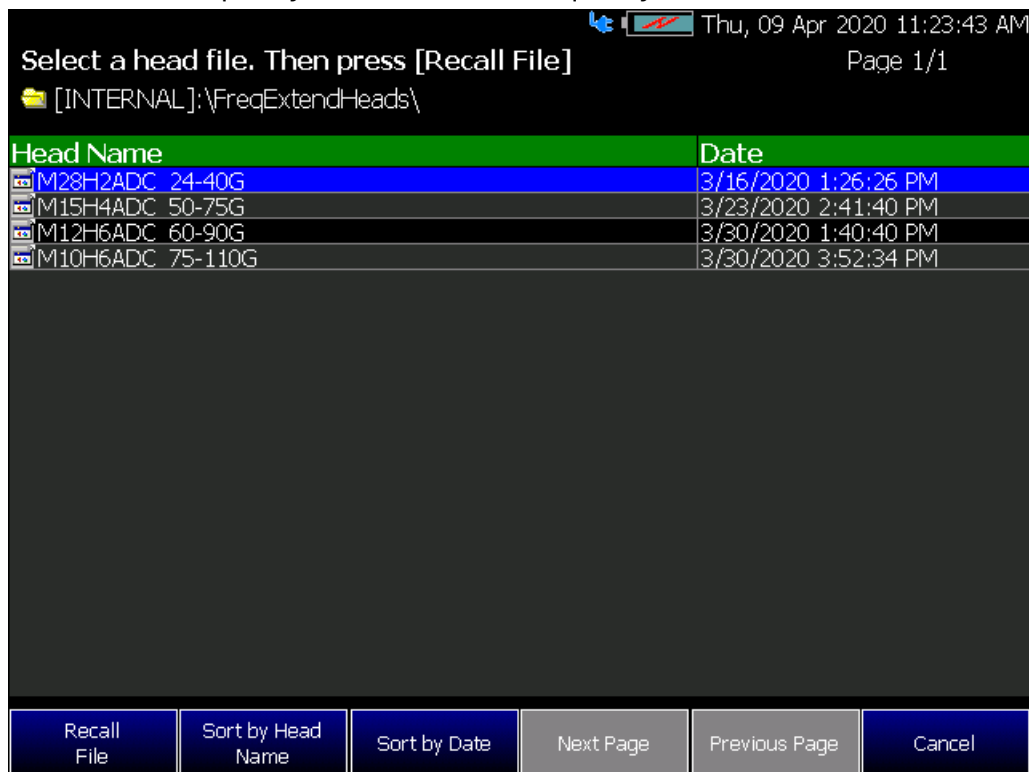

Figure 30-4 FieldFox Frequency Converter Corrections Table

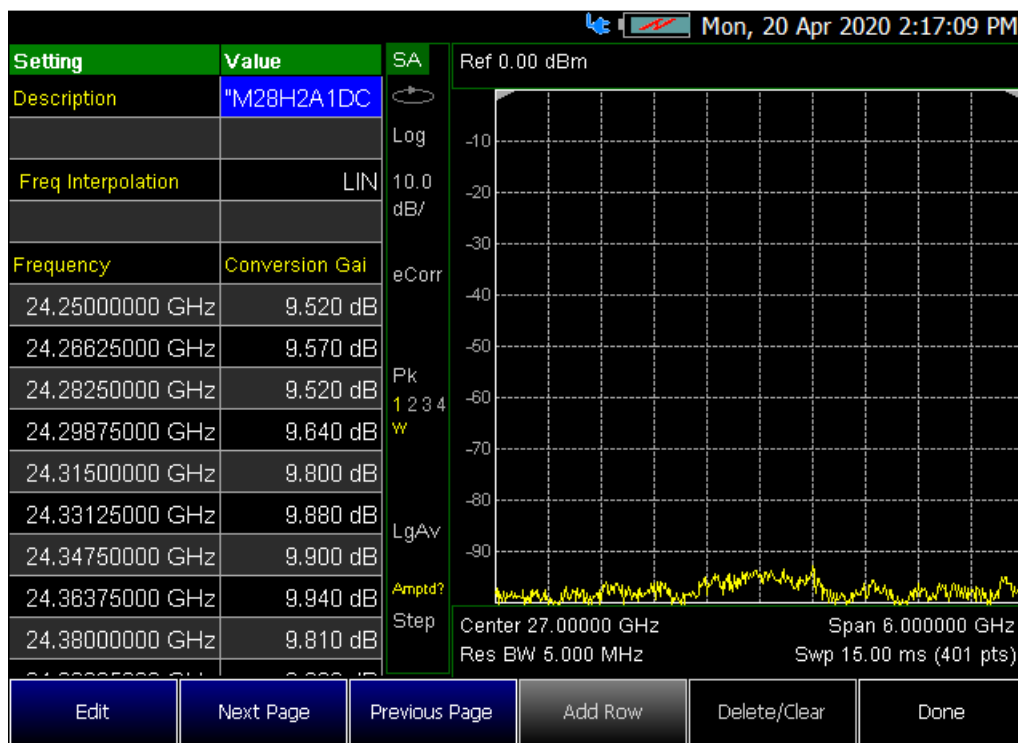

Figure 30-5 FieldFox Frequency Converter (Freq Extend) On And Corrections (eCorr) Enabled (SA mode shown; other compatible modes are similar.)

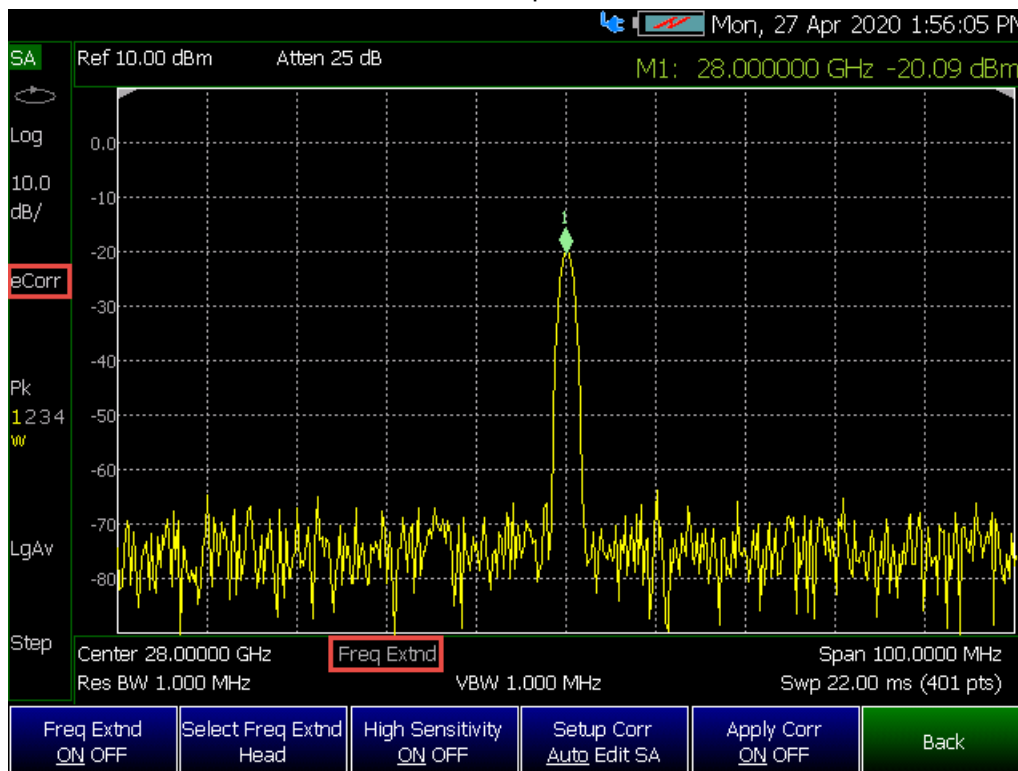
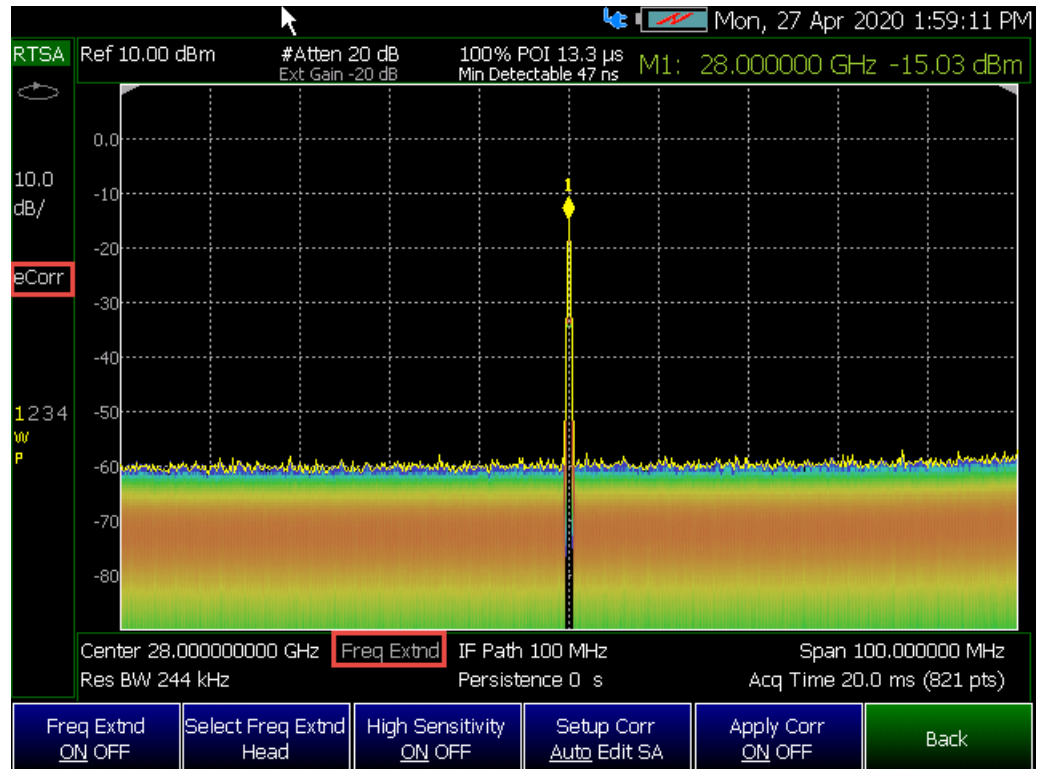

Figure 30-6

FieldFox Frequency Converter (Freq Extnd) On And Corrections (eCorr) Enabled (RTSA mode shown; other compatible modes are similar.)



Preferences

FieldFox preferences are settings that survive a shut down. When your FieldFox is turned OFF, then back ON, these settings remain. All preference settings can be restored to their factory defaults. Learn how in **“Save and Reset Preferences” on page 735**.

There are two ways to make FieldFox preference settings:

- From softkey selections throughout the FieldFox menu structure. Do this to temporarily try a setting, then press **Save Current Preferences**. Learn how in the next section.
- From the Quick Settings table.
- Also, refer to: **“Audio (Volume) Control” on page 720** and **“Display (Settings)” on page 721**.

Quick Settings Table

All preferences can be set from the Quick Settings table. They are immediately saved as Preferences when **Done** is pressed.

How to view and change Preference Quick Settings

- Press **System 7**
 - Then **Preferences**
 - Then **Preferences**
 - Press **Next Page** and **Previous Page** to view all settings.
 - To change a setting:
 - Use the **▲▼** arrows to highlight a setting.
 - Then press **Edit**. The current setting changes to **yellow**.
 - Some settings require you to press a softkey to change the value. Otherwise, use the numeric keypad, **▲▼** arrows, or rotary knob to change the value.
 - When finished changing a value, press **Done Edit**.
 - When finished changing ALL preferences, press **Done**. All changes are immediately saved as Preferences.
 - To exit the editing session without saving changes, press **Esc** at any time.
- Learn more about these preference settings:

Settings

“Global Settings (Overview)” on page 735

- **“Language” on page 736**
- **“Battery Saver” on page 736**
- **“Startup Mode” on page 737**

“Display (Settings)” on page 721

“Audio (Volume) Control” on page 720 and “Audio” on page 738

“Date and Time” on page 739

“GNSS (GPS+) and GPS” on page 749

“Frequency Reference Source” on page 754

“File folders” on page 741

“Alpha Numeric Editing” on page 742 (i.e., ABC/Qwerty keyboard styles)

“File Saving Naming Options” on page 742

“Quick Save Editing” on page 742

“Group Save File Types Editing” on page 743

Settings

[“CAT \(Distance Units\)” on page 744](#)

[“CAT/NA” on page 745](#)

[“SA” on page 746](#)

[“Discrete Colors Softkey Menu” on page 747](#) - Part of Preferences softkey menu.

Save and Reset Preferences

All preference settings can be made at one time from the Quick Settings table.

All settings that can be saved as preferences (except Battery Saver and Startup Mode) can also be made from individual softkey selections throughout the FieldFox menu structure. However, they remain through a FieldFox shut down ONLY when the current settings are saved as preferences.

The table above shows a list of all of these settings and where they are discussed in this User’s Guide.

How to save current settings as Preferences

- Using softkeys, configure the settings as you would like them to remain.
- Press **System 7**
- Then **Preferences**
- Then **Save Current Settings** There is a beep when your settings have been saved.
- Press **Reset Preferences** to restore the factory default settings.

Global Settings (Overview)

Choose the Global Settings values (Language, Batter Saver, and Startup Mode). See also [“Quick Settings Table” on page 733](#).

How to select Global Settings:

- Press **System 7**
- Then **Preferences**
- Then **Preferences**
- Then use arrow softkeys or the knob to select Global Settings
- Then **Edit** for each of the following:
 - Language (see)
 - Batter Save Mode (see)

System Settings
Preferences

- On
- Off (default)
- Startup Mode (see)
- Then **Done Edit** (for each change in setting)

Language

Choose the language in which to display FieldFox softkeys and other messages. Select Save Current Settings to set this language as a preference.

How to select a Language

- Press **System 7**
- Then **Preferences**
- Then **Language**
- Then choose from the following:
 - **English**
 - **Espanol – Spanish**
 - **Deutsch – German**
 - **Italiano – Italian**
 - **Francais – French**
 - **Russian**
 - **Japanese**
 - **Chinese**
 - **Turkish**

Battery Saver

When the battery saver is OFF, the RF source power is left ON at the end of the sweep which consumes more battery power. This feature is used in CAT, NA, VVM modes, and SA mode when the internal source is turned ON.

Battery Saver is the ONLY FieldFox setting that must be made as a Preference from the Quick Settings table. This setting remains until you change it again.

NOTE

The FieldFox internal temps will run 2°C – 5°C cooler with the Battery Saver on (the temperature range is dependent on the ambient temp).

How to set Battery Saver

- Press **System 7**

System Settings
Display

- Then **Preferences**
- Then **Preferences**
- Then scroll to **Global Settings > Battery Saver**
 - **ON** – To conserve battery power, the RF source power is turned OFF at the end of each CAT, NA, and VVM mode sweep. This behavior does not impact FieldFox measurements.
 - **OFF** – Source power is kept ON at all times, including during trigger Hold mode and between single sweep acquisitions. The RF source stays at the stop frequency until another sweep begins. This provides a constant, uninterrupted RF output from the RF OUT port. This behavior also provides the highest trace stability sweep-to-sweep which may only be evident while using either single sweep or Run/Hold. With Battery Saver OFF, the use of a full battery charge is reduced by approximately 45 minutes.

Startup Mode

The Startup Mode setting determines the mode that becomes active (visible) when User Preset is set to OFF (Factory Preset) and the FieldFox is powered ON. See **“User Preset” on page 719**.

How to setup Startup Mode

- Press **System 7**
- Then **Preferences**
- Then **Preferences**
- Then scroll to **Global Settings > Startup Mode** and press **Edit**.
- Then repeatedly press the **Startup Mode** to scroll through the available choices.
 - **<Default>** is the factory default mode for your FieldFox model.
 - Built-in Power Meter Mode is NOT allowed as a Startup Mode.

Display

Choose the Display values (Display Colors, Trace Width, Brightness, Title Enabled, Title). See **“Display (Settings)” on page 721**.

How to select Display values:

- Press **System 7**
- Then **Preferences**
- Then **Preferences**

System Settings
Audio

- Then use arrow softkeys or the knob to select **Display**
- Then **Edit** for each of the following:
 - Display Colors
 - Indoor (default)
 - Night Vision
 - Outdoor Sun
 - Outdoor Dusk
 - Outdoor Clouds
- Trace Width
 - Normal (default)
 - Wide

NOTE

Setting trace width to **Wide**, will result in slower trace refresh rates.

- Brightness
 - 0 to 100% (80% default)
- Title Enabled
 - On
 - Off (default)
- Title
 - User Title (default)
- Then **Done Edit** (for each change in setting)

Audio

Choose the Audio values (Mute, Volume). See also **“Audio (Volume) Control” on page 720**.

How to select Audio values:

- Press **System 7**
- Then **Preferences**
- Then **Preferences**
- Then use arrow softkeys or the knob to select **Audio**
- Then **Edit** for each of the following:

System Settings Date and Time

- Mute
 - On
 - Off (default)
- Volume
 - 0 to 100 (default is 50)
- Then **Done Edit** (for each change in setting)

Date and Time

Choose the Date and Time values (Date and Time, Time Format, Date Format, and Time Zone). See also **“Date and Time, Format, and Time Zone Settings” on page 757.**

How to select CAT distance units:

- Press **System 7**
- Then **Preferences**
- Then **Preferences**
- Then use arrow softkeys or the knob to select **Date and Time**
- Then **Edit** for each of the following:
 - Date and Time
 - Edit as needed (Refer to **“Date and Time, Format, and Time Zone Settings” on page 757**):
 - Time Format
 - Date Format
 - Time Zone
- Then **Done Edit** (for each change in setting)

GPS – Distance Settings

Choose the GPS values (GPS State, Elevation Unit, GPS Sync Clock, Display, Lat/Lon Format). See also **“GNSS (GPS+) and GPS” on page 749.**

How to select CAT distance units:

- Press System 7
- Then Preferences

System Settings
GPS – Distance Settings

- Then Preferences
- Then use arrow softkeys or the knob to select **GPS**
- Then Edit for each of the following:
 - GPS State
 - Off (default)
 - Internal
 - External
 - Elevation Unit
 - Meters (default)
 - Feet
 - Inches
 - GPS Sync Lock
 - Off (default)
 - Internal
 - External
 - Display
 - On
 - Off
 - Lat/Lon Format
 - ddd° mm' ss.sss"
 - ddd.ddddddd°
 - ddd° mm.mmmmm'
- Then Done Edit (for each change in setting)

Frequency Reference

When Internal or External is selected, a search is made for satellites overhead. GPS (default) works best when outdoors and in full view of the open sky.

See also, “GNSS (GPS+) and GPS” on page 749.

How to set the frequency reference settings:

This procedure saves your frequency reference settings using the Quick Settings Table in Preferences. Learn more in “Quick Settings Table” on page 733.

1. Press **System 7** > **Preferences** > **Preferences** then
2. Press **Next Page** until **Frequency Reference** is displayed.
3. Use arrow keys **▲▼** or knob to scroll down to until **Frequency Ref Source** is highlighted.
4. Press **Edit** > **Frequency Ref Sou [GPS]** then
5. Choose from the following:
 - **GPS** - (default setting).
 - **External** - Enable GPS using an external, customer-supplied, USB dongle device. A check is made to detect a USB GPS device at the USB connectors.
 - **Internal** - Enable GPS using Option 307 – Built-in GPS. Connect a GPS antenna to the top-panel GPS connector. Learn more about additional GPS antenna accessories at <http://www.keysight.com/find/fieldfox>. Internal is set automatically when Frequency Reference Source is set to GPS. Learn more in “Frequency Reference Source” on page 754.

File folders

When enabled, FieldFox uses the last selected Device and Folder location as the default device location after instrument power cycle.

NOTE

Before setting the preferences for the File Folders, you must select the Device and Folder locations. Refer to **Chapter 32, “File Management.”**

How to set File Folders

- Press **System 7**

- Then **Preferences**
- Then **Preferences**
- Then scroll to User Folder Persist:
 - **User Folder Persist (On/Off)** – Defaults to the current Device and folder location at power up. Toggle User Folder Persist On/Off when a new Device location is selected location.
 - **User Folder** – displays the default folder location.
 - **User Device** – displays the default device location.

See also: “Alpha Numeric Editing” and “File Saving Naming Options”.

Alpha Numeric Editing

- **Keyboard Style** – Toggles through Qwerty/ABC style keyboards that the Labeler displays. Refer to “How to use the FieldFox labeler ” on page 770.

File Saving Naming Options

- **Prefix** – Displays the current choice for Prefix. Choices are User, Last File (default), or Off. Refer to Prefixes and Suffixes for Filenames in “Prefixes and Suffixes for Filenames” on page 779.
- **Auto Append** – Displays the current choice for Auto Append to a filename (Suffix). Choices are Off (default), Number, Date. Refer to “Prefixes and Suffixes for Filenames” on page 779.

Quick Save Editing

Enables/disables the Quick Save feature. Quick Save saves any files you have set to On in the Group Save File Types preferences. Refer to “Group Save File Types Editing” on page 743.

To save the **User Device** storage location, refer to **Chapter 32, “File Management.”**

CAUTION

IMPORTANT!

To avoid losing data, before using the Quick Save feature, verify that you have all of the correct data file types enabled for saving.

1. Press **System 7** > **Preferences** > **Preferences** then
2. Press **Next Page** until **Quick Save** is displayed.

3. Use arrow keys **▲▼** or knob to scroll down to until your choice is highlighted then choose one or more of the following:
 - **Save/Recall Long Press** – Enables/Disables the Quick Save feature. When enabled (default = Off), when the **Save/Recall 9 hardkey** is held down for ~3 seconds, the specified files are saved to a file with the **FFoxData** prefix. See also, Prefixes and Suffixes in **“Prefixes and Suffixes for Filenames” on page 779**.
 - **Quick Save Prefix** – Chooses the name of the Quick Save data file’s prefix. Press the **Edit** softkey to edit the prefix name in the "Quick Save Prefix" menu (default = FFoxData). Refer to **“Prefixes and Suffixes for Filenames” on page 779**.
 - **Quick Save Suffix** – Chooses the name of the Quick Save data file’s suffix. Press the **Edit** softkey to edit the suffix type Number or Data (default = Number). Refer to **“Prefixes and Suffixes for Filenames” on page 779**.

Group Save File Types Editing

Enables/disables the selected file types to be saved as part of the Group Save File Types feature. (Default for all group save file types = Off.) Refer to **“Quick Save Editing” on page 742**.

Group Save File Types Procedure

1. Press **System 7** > **Preferences** > **Preferences** then
2. Press **Next Page** until **Group Save File Types** is displayed.
3. Use arrow keys **▲▼** or knob to scroll down to until your choice is highlighted then:
4. Press **Edit** then
5. Press **'file type' Data (.xxx)** to enable/disable the data file type (default = Off). (e.g., **Image (.png) ON OFF**, **CSV Data (.csv) ON OFF**, etcetera).
6. Repeat steps 3 through 5 as required.
7. Press **Done Edit** to exit the current data type softkey menu.
8. Press **Done** to exit the Preferences menu and save your Preferences.

Group Save File Types

- **State+Trace (.sta)** – Enables/Disables .sta as a group. file to be saved when the Quick Save (Save/Recall 9) hardkey is pressed for ~3 seconds.

System Settings
CAT (Distance Units)

- **State (.sta)** – Enables/disables .sta files as a group file to be saved when the Quick Save (Save/Recall 9) hardkey is pressed for ~3 seconds.
- **Image (.png)** – Enables/disables .png files as a group file to be saved when the Quick Save (Save/Recall 9) hardkey is pressed for ~3 seconds.
- **CSV Data (.png)** – Enables/disables .csv data files as a part of the group files to be saved when the Quick Save (Save/Recall 9) hardkey is pressed for ~3 seconds.
- **S1P Data (.s1p)** – Enables/disables .s1p data files as a part of the group files to be saved when the Quick Save (Save/Recall 9) hardkey is pressed for ~3 seconds.
- **S2P Data (.s2p)** – Enables/disables .s2p data files as a part of the group files to be saved when the Quick Save (Save/Recall 9) hardkey is pressed for ~3 seconds.
- **Matalab Data (.mat)** – Enables/disables .mat data files as a part of the group files to be saved when the Quick Save (Save/Recall 9) hardkey is pressed for ~3 seconds.
- **SDF Data (.sdf)** – Enables/disables .sdf data files as a part of the group files to be saved when the Quick Save (Save/Recall 9) hardkey is pressed for ~3 seconds.

CAT (Distance Units)

Choose the CAT distance units (i.e., Meters (default), Feet, Inches). See **“DTF Units” on page 81**.

How to select CAT distance units:

- Press **System 7**
- Then **Preferences**
- Then **Preferences**
- Then **Edit** for each of the following:
 - Distance Units:
 - Meters (default)
 - Feet
 - Inches
 - TDR Sweep:
 - Cable (default and the most accurate)
 - Auto
- Then **Done Edit** (after each change in setting)

CAT/NA

Choose the CAT/NA settings for SnP file save, default factory error corrections, extended cal default. See also “> **What Data Processing functions are included in saved SNP Data:**” on page 775.

How to select CAT/NA defaults:

- Press **System 7**
- Then **Preferences**
- Then **Preferences**
- Then use arrow softkeys or the knob to select CAT/NA
- Then **Edit** for each of the following:
 - SnP File Save
 - Default
 - Advanced
 - Default Factory Error Corr. (N995xA/6xA Only)
 - Enhanced Response
 - Full 2 Port
 - Extended Cal Default (N995xA/6xA Only)
 - On
 - Off (default on models >6 GHz)
- Then **Done Edit** (after each change in setting)

SA

Choose the SA setting for Individual ment Control default. See also [“Alignments” on page 211](#).

How to select SA defaults:

- Press **System 7**
- Then **Preferences**
- Then **Preferences**
- Then use arrow softkeys or the knob to select SA
- Then **Edit** for each of the following:
 - **Individual measurement Control**
 - On (Default - recommended)
 - Off
 - **ADC Over Range Large Warning**
 - On
 - Off (Default)
- Then **Done Edit** (after changing setting)

Discrete Colors Softkey Menu

The discrete colors softkey menu can be used to increase the choice of colors displayed from two to up to six colors, for easier measurement readings. Refer to [Figure 30-7](#).

Figure 30-7 Display Example: Color Coded Bar Scale (x6 Colors)

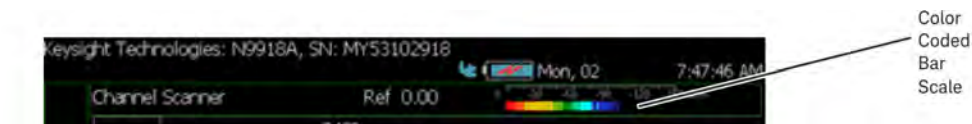

Using the Discrete Colors Softkey Menu

1. Press **System 7** > **Preferences** > **Discrete Colors**
2. Choose from the following:
 - **Discrete Colors ON OFF** – to enable/disable the discrete colors greater than 2.
 - **Number of Colors** – choose up to 6 discrete colors (Minimum (default) = 2, red and blue).
 - **High Power Red Blue** – choose red or blue to choose the color to indicate the highest power levels (default = Red).

System Configuration

Options (Licensing)

You can view and install options on your FieldFox. To see a comprehensive list of the options that are available, view the FieldFox Configuration Guide at: <https://www.keysight.com/us/en/assets/7018-03329/configuration-guides/5990-9836.pdf>.

How to view the Installed Options

- Press **System 7**
- Then **System Configuration**
- Then **Options (Licensing)**
- Then **Show Options**

The currently installed options are listed.

How to Install Options (License File)

A license file (*.lic file) must already be on a USB Flash Drive. To learn how to obtain a license file (*.lic file), visit:

<https://www.keysight.com/us/en/lib/resources/service-manuals/keysight-fieldfox-library-help-and-manuals-2153870.html>.

Insert the USB Flash Drive in the FieldFox.

- Press **System 7**
- Then **System Configuration**
- Then **Options (Licensing)**
- Then **Install Options** The FieldFox reads, validates, then installs the options.
- Press and hold the power button to shut down, then restart the FieldFox.

How to Delete ALL Options

Deleting individual options is NOT supported.

- Press **System 7**
- Then **System Configuration**
- Then **Options (Licensing)**
- Then **Advanced**
- Then **Delete All Options**

After a warning message, all options on the FieldFox are deleted.

NOTE

Delete All CFG Options is to be used by Service Personnel ONLY.

For more information about Licensing, see the FieldFox Service Manual at:
<https://edadocs.software.keysight.com/kkbopen/fieldfox-manuals-firmware-software-and-product-support-589310103.html>.

GNSS (GPS+) and GPS

NOTE

IMPORTANT! The FieldFox may display "Ant OPEN", even when a GPS antenna is connected to the FieldFox. If the GPS antenna is powered by another power supply **and** has a DC blocking capacitor where the feed is connected to FieldFox, then minimal amounts of current will be drawn from the FieldFox, so the instrument will display "Ant OPEN". The threshold to detect the presence of an antenna is approximately 1.6 mA.

GPS (Global Positioning System) allows you to 'stamp' each data trace with your physical position in latitude/longitude/elevation format. This can be useful when making measurements on cell towers or other antennas at remote locations.

- **With Option 307**, GPS is available with the built-in receiver accessed through the top-panel SMA (f) connector. This connector has a 3.3 VDC bias voltage which is switched ON when GPS is set to Internal. This system is designed for use with an active antenna such as the Keysight N9910X-825.
- **Without Option 307**, GPS is usable ONLY with an external GPS receiver that is shipped with Microsoft "Streets and Trips" and "AutoRoute". The GPS receiver is NOT available from Keysight. Only the GPS USB receiver is used with the FieldFox. Therefore, it is NOT necessary to purchase the very latest version of the map software.

How to make GPS settings

GPS settings are the same with, or without, Option 307.

- Your GPS settings can be saved with Preferences. Learn more in "[Quick Settings Table](#)" on page 733.
- Press **System 7**
- Then **System Configuration**
- Then **GPS**
- Then choose from the following:
 - **Display ON OFF** Enable and disable the GPS display on the FieldFox main window.
 - **GPS**
 - **OFF** - Disable GPS (default setting).
 - **External** - Enable GPS using an external, customer-supplied, USB dongle device. A check is made to detect a USB GPS device at the USB connectors.

- **Internal** - Enable GPS using Option 307 – Built-in GPS. Connect a GPS antenna to the top-panel GPS connector. Learn more about additional GPS antenna accessories at <http://www.keysight.com/find/fieldfox>. Internal is set automatically when Frequency Reference Source is set to GPS. Learn more in “Frequency Reference Source” on page 754.

When Internal or External is selected, a search is made for satellites overhead. GPS works best when outdoors and in full view of the open sky. When several satellites are found, the following screen appears (when Display is set to ON) and is updated frequently:

NOTE

As the bar graph count exceeds 9 bars, the “dB” text is dropped from the number displayed on the bar. Units for C/No are dBHz.

Figure 30-8

GPS Display

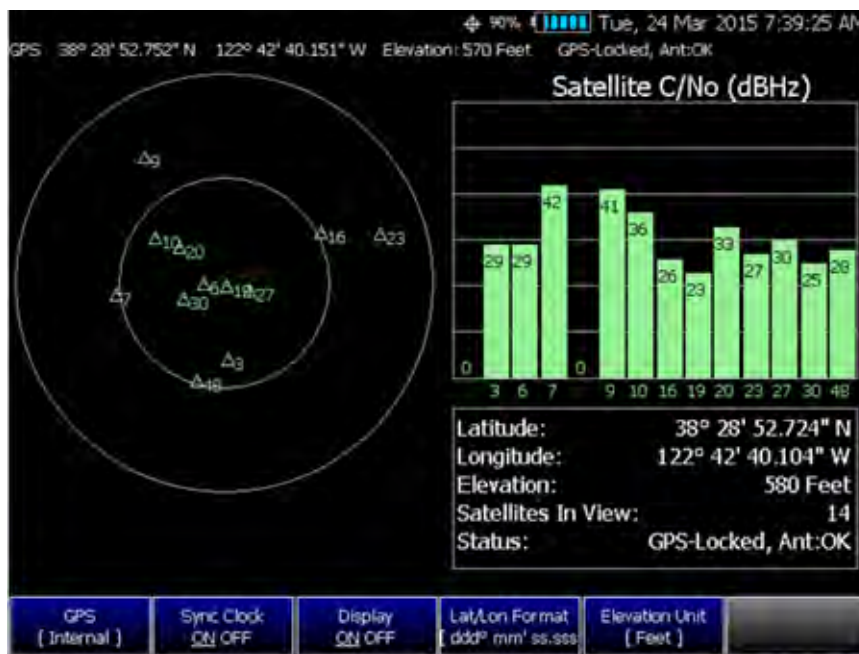

- The left portion of the screen displays satellites and the corresponding number on the adjacent Satellite Power chart.
- The right portion of the screen displays Satellite Power Carrier to Noise (C/No) dBHz values on the tops of the satellite power chart.

NOTE



The C/No values returned are not calibrated at the factory or warranted for accuracy. The numbers retrieved are passed unprocessed directly from the GPS receiver in use.

GPS Status

With GPS enabled the following is displayed at the top of the FieldFox screen:



The following icons (located in **RED** circle above) indicate the GPS lock status:

-  - GPS ON and locked on satellites.
-  - GPS ON, but NOT locked on satellites.
-  - GPS ON, but no GPS receiver is present or detected.

The following annotation (**BLUE** circle in above image) indicates the **INTERNAL**, top-panel antenna status:

- Ant: **INIT** – antenna status initializing.
- Ant: **OK** – antenna present and working.
- Ant: **OPEN** – antenna is not drawing DC bias current. This could occur when an active antenna is not connected properly or the antenna does not require DC bias current. Antennas that do not require bias current can still provide an accurate GPS reading.
- Ant: **SHORT** – antenna center pin has been shorted to ground. The internal bias circuitry is disabled for about one minute, then re-enabled. You can also press **GPS OFF**, then **GPS Internal** to quickly re-enable the antenna bias.

More GNSS and GPS settings

See also, “**GNSS and GPS Freq Ref Source Settings**” on page 753.

- Press **System 7**
- Then **System Configuration**
- Then **GNSS (GPS+)** or **GPS** (depending on options) > **GNSS Settings**
- Then choose from the following:
- Enable and disable the synchronization of the FieldFox internal clock to the GPS UTC time standard.

NOTE

The GPS Sync setting has the same restrictions as the Date and Time setting. Learn more in “**Date and Time**” on page 739.

- **ON** The FieldFox clock is synchronized and updated approximately once every hour to the time of the GPS clock.

- **OFF** The FieldFox clock is NOT synchronized with GPS. When set to OFF after Sync was ON, the date and time does NOT revert back to the settings before the clock was synchronized.
- **Lat/Lon Format** Change the format of the GPS display on the FieldFox screen. Choose from:
 - **ddd°mm' ss.sss"** degrees, minutes, seconds (default setting)
 - **ddd°mm.mmmmm'** degrees, minutes, fractional minutes
 - **ddd.dddddd°** decimal degrees
- **None** Lat/Lon is not displayed.
- **Elevation Unit** Choose from:
 - **m** (Meters)
 - **Feet**
 - **Inches**
- **Antenna Voltage** Choose from:
 - **3.3V 5V** – Settable to: 3.5 VDC or 5 VDC. When the bias voltage is set to ON and when the GPS is set to Internal. This system was designed for an active antenna such as the Keysight N9910X-825

Saving Data with GPS Enabled

GPS position and clock data are included when data is saved with the following file types: *.csv, *.SnP, State, State+Trace data save.

A warning is shown if the GPS is ON but unlocked at time of save, or if the GPS feature is ON but no GPS is physically present at time of save.

The following is a sample S1P file with GPS information:

```
!GPS Latitude: 38 28.87717 N
!GPS Longitude: 122 42.66625 W
!GPS TimeStamp: 06/25/2010 16:24:48
!GPS Seconds Since Last Read: 2s
```

Saving GPS Display Data

To save the current GPS data displayed:

- Press **Save/Recall 9**
- Then **Save File Picture (PNG)**
- A menu opens to enable naming the file you are saving (*.png).

More GNSS Settings

NOTE

These GNSS settings require that the A-Series FieldFox has been upgraded with a new system board N9927-63074. Verify your system board by pressing

System > **Service Diagnostics** > **System Information**

then verify in the Setting column the SB Part Number is N9927-63074.

FieldFoxes with serial number prefixes >MY60511001 / US60510101 / SG60517001 /SG60518501 already have this new system board installed.

-
- Press **System 7**
 - Then **System Configuration**
 - Then **GNSS Selection**
 - Then choose from the following:
 - **GPS** Refer to “How to make GPS settings” on page 749.
 - **GLONASS** Global navigation system, operating as part of a radio navigation-satellite system. Learn more “More GNSS and GPS settings” on page 751.
 - **BDS** - China’s BeiDou navigation system. Learn more “More GNSS and GPS settings” on page 751.
 - **GALILEO** - European navigation system. Learn more “More GNSS and GPS settings” on page 751.

GNSS and GPS Freq Ref Source Settings

For convenience, the GNSS Settings menu includes the **Freq Ref Source** softkey.

- Press **System** > **System Configuration** > **GNSS (GPS+)** > **Freq Ref Source**
GPS then
- Choose one of the following:
 - **Int**, **Ext**, or **GPS**

For more, on the **Freq Ref Source** softkey choices, refer to “Frequency Reference Source” on page 754.

Frequency Reference Source

The FieldFox internal frequency reference source is used to make accurate and stable measurements. To improve measurement accuracy and stability, you can use a highly-stable external 10 MHz reference source or a precision timing signal provided with Built-in GPS (Opt. 307).

The Frequency Reference setting will survive a Factory Preset or Mode Preset and is saved as part of the Instrument State. When resuming after Standby, the FieldFox will display an Unlock message while it acquires a lock to an external or GPS source.

How to select Frequency Reference Source

- Press **System 7** > **System Configuration** > **Frequency Ref** > **Freq Ref Source** then
- Choose from the following:
 - **Int** Internal frequency reference
 - **Ext** External frequency reference. Connect the 10 MHz External Reference to the **Ref In/Trig In** SMA (f) connector on the FieldFox top panel. The FieldFox may take up to 10 seconds to lock to a valid External Reference source
 - **GPS** Available ONLY with Built-in GPS (Opt. 307). When selected, the internal GPS is immediately enabled and a search for satellites begins. When satellites are found, the precision timing signal is NOT used directly, but is used to correct the absolute frequency of the internal reference many times per second.

Hold-over mode

When the GPS signal is lost, the last GPS reading is used as a hold-over correction value for the internal reference. The hold-over correction value is no longer used, but instead the factory-set correction value is used, when any of the following occur:

- when GPS is disabled.
- when Reference Source is set to Internal.
- when the FieldFox resumes from Standby mode or shut down.

Frequency Reference Status

When switched to Ext or GPS, one of the following annotations appears in the lower-left corner of the screen:

- **EXT R** – External reference is selected.
- **GPS R** – GPS reference is selected.
- **GPS H** – Internal Reference is used with last 'hold-over' correction reading.

If the FieldFox does NOT find an appropriate **Ext** or **GPS** reference signal, then **Ext Ref UNLOCKED** is displayed in the lower-left corner of the graticule area. This can occur when any of the following conditions exist:

- NO reference signal is present.
- A low or very high-level external reference signal is present. For best results, the signal should be between -5 dBm and $+5$ dBm.
- The external reference is off-frequency.

To learn the expected measurement accuracy when connected to a frequency reference source, see the FieldFox specifications in **“Specifications/Data Sheet” on page 819**.

Reference OUT

The internal 10 MHz frequency reference is available from the Ref/Trig output connector on the right-side panel. Use this signal as a common frequency reference when making measurements using external equipment. See this connector in **“Top Panel” on page 48**.

Variable Voltage Source (Opt. 309)

CAUTION

IMPORTANT! Noise Figure mode uses DC variable voltage source (VVS) – (Option 309) during the measurements. The voltage might be as high as 28V during the measurement. During the noise figure measurement, always make sure there are no voltage sensitive devices connected to the DC SMB output port. Refer to **Chapter 28, “Noise Figure Mode (Option 356 – CPU2 Only)”**, on page 641.

When you initially change the FieldFox mode to Noise Figure, the FieldFox displays the following message for ten seconds:

`"Ensure your Noise Source is connected to the VVS DC Output
It (VVS) will be driven up to +28V during the measurement".`

An internal DC source, available with Opt. 309, may be used to provide power for external devices. The maximum power available is 8 watts.

The voltage is output through an SMB (m) output connector located on the left-side panel. See the connector in **“Left Side Panel” on page 50**.

An optional SMB (f) to BNC (m) bias-tee power cable is available with Keysight part number: N9910X-713.

The following status line is provided near the top of the FieldFox screen.

Figure 30-9



Voltage Source Status Line

1. Voltage source state: ON, OFF, TRIPPED.
2. **Voltage** setting from 1.00 V to 32.00 V with.01 V resolution.
3. **Current**: The amount of current (in Amperes) being drawn from the source.
4. **Max Current**: A conservative estimate of maximum current possible given the present voltage setting. The actual 'trip' level may be slightly different.

How to make Voltage Source settings

- Press **System 7**
- Then **System Configuration**.
- Then **Voltage Source**.
- Then **Source ON OFF** to enable and disable the voltage source output.
- Then Voltage x.xx V Using  arrows, the rotary knob, or numeric keypad, enter a value between 0.001 and 32 volts.
- **Clear Overload** If the voltage source becomes 'TRIPPED' press to re-enable the voltage source output. Then set **Source ON**.
- **Status Line ON OFF** Turn ON and OFF the voltage source status line that appears near the top of the screen. The status line is always ON while making Voltage Source settings.
- **Hi Impd. Load ON OFF** Enables/Disables low current use (Step) and high current use (Ramp). Default = OFF (Low current (Step)).

Security Level

For security reasons, you can prevent frequency information from appearing on the FieldFox while in SA, NA, or CAT modes.

How to set Security Level

- Press **System 7**
- Then **System Configuration**
- Then **Security Level**
- Then choose from the following:
 - **None** All frequency settings are visible.

- **High** Frequency information is blanked from the following:
 - Display annotation
 - Softkeys
 - Marker display and marker table
 - Calibration properties
 - All settings tables
 - Limit line tables
 - All saved.png files
- Any of the following will re-display frequency information:
 - Set to **None**, Preset, Mode Preset, or FieldFox restart.

Date and Time, Format, and Time Zone Settings

Set the local date and time, Date and Time format, and Time Zone that is shown on the FieldFox screen. The Date and Time is also used to identify files that are saved.

The Date and Time can also be set by synchronizing with GPS satellites. Learn more in [“GPS – Distance Settings” on page 739](#).

How to Update Date and Time using Internet

This method of setting the Date and Time does NOT have the security restrictions of the other methods (listed below).

This method will NOT set the correct Time Zone. You must do that using the manual method. See below.

- Press **System 7**
- Then **System Configuration**.
- Then **More**
- Then **Update Time using Internet**
- Connect a LAN cable that is also connected to the Internet.
- Then press **Update Time using Internet**. When successful, a message is displayed indicating the amount of time correction that occurred.
- Optional: Set the following when a Proxy server is used to connect to the internet:
 - **Proxy Host** – Enter the name of the proxy host.
 - **Proxy Port** – Enter the port number of the proxy host.

How to MANUALLY set Date and Time, Format, and Time Zone

NOTE

Because of licensing security, the manual and GPS Sync methods to set Date and Time are restricted as follows:

Can be set backward no more than 5 hours at a time.

Can be set forward any amount of time.



Can be set backward or forward no more than once in a day. A new day begins at midnight.

There is no restriction for setting the Time Zone.

To change the Date and Time backward a significant amount, send an email to csq.servicedesk@keysight.com.

NOTE

BEFORE manually setting the Date and Time, be absolutely certain that the Time Zone setting is correct.

- Press **System 7**
- Then **System Configuration**.
- Then **More**.
- Then **Date and Time**.
- Press the  arrows to highlight the row to be edited.
- Then press **Edit**.
- Use the  arrows or rotary knob to select the field to be edited.
- Use the  arrows or numeric keypad to edit that field.
- Press **Cancel** or **Done** when the edits are complete.
- Press **Done** to exit the Date and Time settings. The readout in the upper-right corner of the FieldFox screen will update accordingly.

LAN Settings

Configure the LAN settings to be used to communicate with the Data Link Software and connect to the FieldFox for remote SCPI operation. Learn more about Data Link at: www.keysight.com/find/fieldfoxsupport.

Use knob. Press [Edit] to make changes. Press [Done] to exit.	
Setting	Value
Current IP Address	192.168.1.102
Current Subnet Mask	255.255.255.0
Current Gateway	192.168.1.1
Hostname	A-N9912A-00000
Obtain IP Address using:	DHCP
Static IP Address	123.456.789.123.123
Static Subnet Mask	0.0.0.0
Static Gateway	0.0.0.0
Apply Settings at:	PowerUp

Table 30-1 LAN LEDs (N995xA, N996xA, and applies to: N991xA/2xA/3xA units with serial number prefixes ≥ 5607)

LAN LEDs (N995xA, N996xA, and applies to: N991xA/2xA/3xA units with serial number prefixes ≥ 5607)

When FieldFox is connected to the LAN, the flashing LAN LEDs have the following definitions:

Green: Flashing indicates packets are being transferred.

Yellow:

- Flash, pause = 10 Mbit link speed
- Flash, flash, pause = 100 Mbit link speed
- Flash, flash, flash, pause = 1 GBit link speed

How to configure LAN settings

The first three ‘Current...’ settings can NOT be edited.

- Press System 7.
- Then System Configuration.
- Then More.
- Then LAN.
- Use the  arrows to select one of the following, then press Edit.
- **Hostname** Change the name that can be used to address the FieldFox if your server supports this feature. The default hostname is generated automatically.
- **Obtain IP** Choose from:
 - **DHCP** - IP Address is assigned dynamically. If your server supports this feature, the IP Address for the FieldFox is assigned each time it is started.

- **Static** - Set the IP Address manually. The Address remains until you change it.
- **Static IP Address** - Enter the IP Address – including periods - in the format nnn.nnn.nnn.nnn

NOTE

For all FieldFoxes with firmware \leq A.08.18 and \leq A.09.50 FW, when using Static IP addresses:

- Either a valid Static Gateway is required or 0.0.0.0.
 - Either a valid Static DNS is required or 0.0.0.0. (If entry is available.)
-
- **Static Subnet Mask** - Enter the Subnet Mask – including periods - in the format nnn.nnn.nnn.nnn
 - **Static Gateway** - Enter the Static Gateway – including periods - in the format nnn.nnn.nnn.nnn
 - **Static DNS** - Enter the Static DNS – including periods - in the format nnn.nnn.nnn.nnn
 - **Apply Settings** Choose from:
 - **Power Up** The above settings take effect when the FieldFox is started.
 - **Now** The above settings take effect immediately.

NOTE

To make the LAN settings persist after power up, toggle Apply Settings to Now then back to Power Up. You should see a message indicating that the LAN config file was saved.

-
- Press **Done Edit** when finished.

Power ON

When the FieldFox is without a power source, this setting allows the FieldFox to power ON when the DC Adapter is inserted without pressing the power button.

How to set Power ON

- Press **System 7**
- Then **System Configuration**
- Then **More**
- Then **Power ON**
- Then choose from the following:
 - **Auto** The FieldFox will power ON when the DC Adapter is inserted.

- **Manual** The FieldFox will power ON only when the power button is pressed.

FieldFox Package Installer (N995xA, N996xA, and applies to: N991xA/2xA/3xA units with serial number prefixes ≥ 5607)

The FieldFox Package Installer enables you to download new versions of firmware from either a USB memory or SD Card. Additionally, the Utility softkey enables you to backup user files or restore user files.

How to run the Installer

NOTE

Before running the Installer to update your firmware, you might want to back up your user data. Refer to [“How to restore files” on page 762](#).

- Press **System 7**.
- Then **System Configuration**.
- Then **More**.
- Then **Firmware Update**.
- Then **Start Installer**.
- The Installer software opens after a couple of seconds.

NOTE

If no files are displayed, verify that a USB memory or SD Card is installed and press **Refresh List**.

- Then the  arrows or the knob to scroll to the firmware you want to install.
- Press **Start Install**.
- “Current Step Progress:” bar and a “Total Progress:” bar are displayed along with this message: “Copying package. Do not remove install media.”
- When the installation is completed, the FieldFox reboots.

How to backup files

This procedure backs up your user data to a USB or SD card. See also [“How to restore files” on page 762](#).

NOTE

If you backup multiple versions of the user files, the FieldFox appends a “_#” to each subsequently stored file. During restore, the file with the highest appended number is loaded into the FieldFox.

From the initial Installer menu:

- Press **Utility**
- Then **Backup Data**
- A message is displayed: “Choose backup file location.”
- Then choose either **SD Card** or **USB**
- A progress bar and a message is displayed: “Saving user data...”
- Press **Cancel** to exit without backing up your files and returning to the initial Installer menu.

How to restore files

This procedure restores user files from a USB or SD card. See also [“How to backup files” on page 761](#).

CAUTION

Restoring files overwrites the existing user data on the FieldFox.

NOTE

If you backup multiple versions of the user files, the FieldFox appends a “_#” to each subsequently stored file. During restore, the file with the highest appended number is loaded into the FieldFox

If you stored any user files to a USB or SD card, this procedure restores those files.

From the initial Installer menu:

- Press **Utility**
- Then **Cancel** to exit without restoring your files and returning to the initial Installer menu.

Or

Press **Restore Data**

- A message is displayed: “This option will COMPLETELY ERASE existing user data. ARE YOU SURE?”
- Then **No** to return to the previous menu without restoring files.

Or

Press **Yes**

- Then choose either SD Card or USB

A progress bar and a message is displayed: “Restoring user data...”

Service Diagnostics

- The Service diagnostics menu is generally used to display service-related information. To access these menu items, press **System 7** then **Service Diagnostics**.

System Information

The System information table shows important information about your FieldFox. The following is the most useful information:

- **Model Number** – FieldFox model
- **Serial Number** – Identification number of your FieldFox
- **Firmware Release** – The currently installed version of software. Check to see if you have the latest firmware at:
www.keysight.com/find/fieldfoxsupport
- **Network Identity** – The network name and current IP address of your FieldFox.
- **Reflectometer Factory Cal** - The Factory (CalReady) Calibration shows the date and time that the factory cal was performed for each test port and the Thru connection. The format is P1 <date time>, P2 <date time>, P1-P2 <date time>. The factory calibration is updated when you send your FieldFox to Keysight for Instrument Calibration. Learn more in **“Instrument Calibration” on page 821**.

Event Log

The Event Log shows the information that has appeared on the FieldFox screen. The most recent information is at the top of the table.

Press **Clear Events** to erase this information.

Battery

Learn more in **Chapter 33, “Working with the Lithium-Ion Battery”, on page 783**.

Internal Temperatures

Learn about the importance of the internal FieldFox temperatures in **“FieldFox High Temperature Protection” on page 40**.

Erase User Data

CAUTION

IMPORTANT!

The process in this section erases all User Data from the FieldFox. Before proceeding, Keysight strongly recommends that you back up all of your User Data to an external storage device. refer to [“How to backup files” on page 761](#).

All data that you have written to the FieldFox can be erased with the press of a button. You would do this if your FieldFox is located in a secure environment and must be routinely erased of sensitive data.

All data is removed from the FieldFox internal “UserData” partition. This includes all State files and Trace + State files (*.sta), all Data files (*.csv, *.snp), all Picture files (*.png), all Cal Kit files, and all Cable files.

External media that is inserted (mini-SD card or USB flash drive) is NOT erased.

The “Lost Clusters” folder and files are NOT erased because they are part of the file system housekeeping.

How to Erase User Data

- Press **System 7**.
- Then **Service Diagnostics**.
- Then **Advanced**.
- Then **Erase User Data**.
- Then **Confirm Erase**.
- Then the following occurs:
 - All data files and folders are deleted from the “UserData” partition.
 - The FieldFox is rebooted, which manages the newly-freed data and re-writes the factory cal kits and cable files.

NOTE

Rebooting is not required on the N995xA, N996xA, and applies to: N991xA/2xA/3xA units with serial number prefixes ≥ 5607 .

31 Using the Mini-USB Port to send SCPI Commands and Queries (N995xA/6xA and applies to: N991xA/2xA/3xA units with serial number prefixes ≥ 5607)

NOTE

IMPORTANT! It is recommended that only USB certified cables are used with the FieldFox.

In this Chapter

[“Mini-USB Connection to PC with IO Libraries” on page 765](#)

Mini-USB Connection to PC with IO Libraries

The FieldFox comes with a mini-USB port that can be used to connect to your PC's standard USB 2.0 port. Using Keysight IO Libraries, Connection Expert and connecting via a VISA connection, you can send SCPI commands via the **Keysight Interactive IO** window to the FieldFox. Refer to your IO Libraries online help for the details on connecting to your instrument. Refer to keysight.com to download the IO Libraries.

NOTE

The FieldFox may be communicated with via the VISA libraries. This makes it available to VEE, LabView, and other software tools that can communicate with VISA instruments.

You can connect to USB ports that are not type 2.0 USB. But, the mini-USB port is optimized for a type 2.0 USB ports.

Overview of mini-USB to PC setup for sending SCPI commands and queries:

- Connect a mini-USB (FieldFox device-side) to standard USB (host-PC)
- **On the FieldFox:** Power on the instrument.
- Click **System 7** > **System Diagnostics** > **System Information** and find the FieldFox serial number.
- **On your PC:** Open the **Keysight IO Libraries** software, **Connection Expert** and connect to the FieldFox using the VISA connection. Refer to the Keysight Connection Expert Help.

Using the Mini-USB Port to send SCPI Commands and Queries (N995xA/6xA and applies to: N991xA/2xA/3xA units with serial number prefixes ≥ 5607)
Mini-USB Connection to PC with IO Libraries

- In the **Keysight Interactive IO** window: Type in your SCPIs on the Command line and click **Send Command**, **Read Response**, or **Send & Read**. Refer to the Keysight Connection Expert Help and [Figure 31-1 on page 766](#).

Figure 31-1 Keysight Interactive IO Window

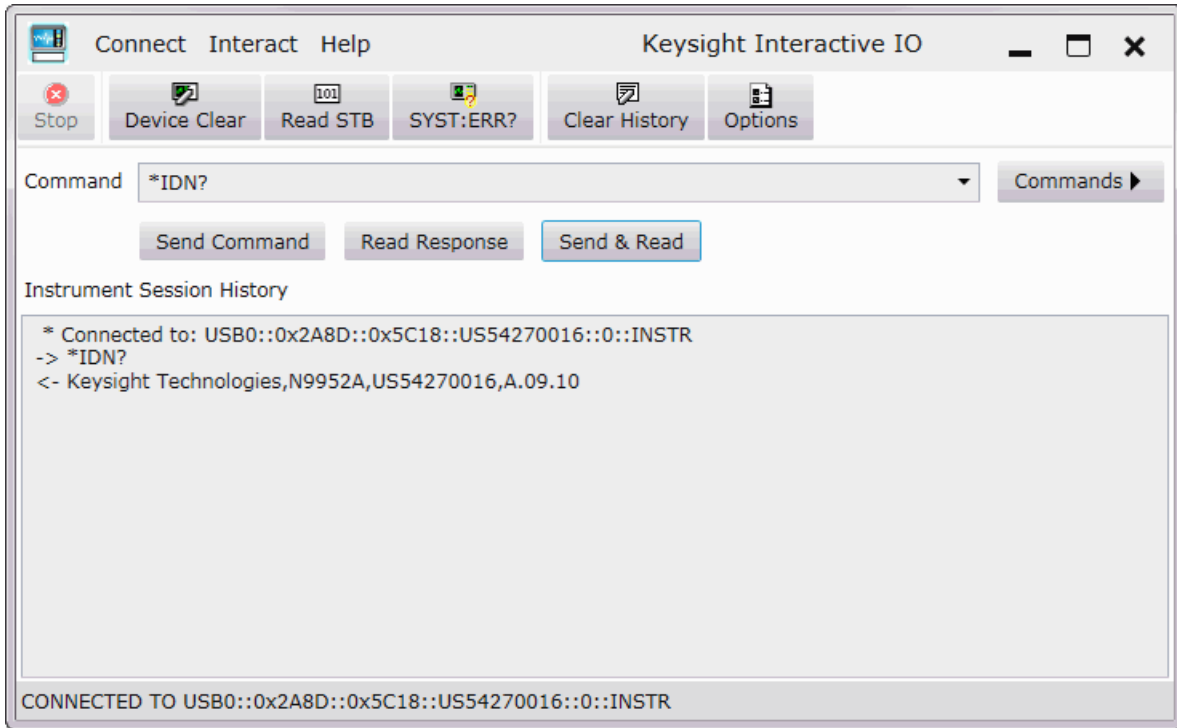

32 File Management

The FieldFox can save any of the following types of files:

- Current settings and calibration
- Trace data (*.csv, *.S1P, *.S2P)
- Picture of the FieldFox screen

In addition, files can be saved to the internal memory, a USB Flash drive, or a standard SD card.

In this Chapter

[“Save Files” on page 768](#)

[“Recall Files” on page 772](#)

[“Move \(Copy\) Files” on page 772](#)

[“Set File Type and Select Device” on page 773](#)

[“Manage Files” on page 776](#)

[“Manage Folders” on page 778](#)

[“Edit Keywords” on page 779](#)

[“Prefixes and Suffixes for Filenames” on page 779](#)

See Also:

[“Erase User Data” on page 764](#)

Saving and Recalling Files

NOTE

FieldFox State files are intended to be recalled on the same instrument model on which they were saved. Sometimes you may be able to recall them within model families. An error will result when trying to recall a state file that was saved on a different model family.

The FieldFox model families are:

- N991x (VNA/SA) model family
- N992x (VNA) model family
- N993x (SA) model family
- N995x (VNA/SA) model family
- N996x (SA) model family

Save Files

How to Save a File

- Press **Save/Recall 9**
- Then **Save**
- At the top of the current 'labeler' screen (see following image) check the **File Type** to save and **Device** (Internal, USB, Storage Card) to which the file is saved. Learn how to change these settings in **“Set File Type and Select Device” on page 773**.
- Then use the labeler to specify a filename.

CAUTION

If you are having difficulty saving to a USB flash drive, it may be a timing issue. The turn-around time for “file open, write data, file close” to a USB drive is much longer than to FieldFox’s internal memory. Alternative methods are:

1. Save your content to the FieldFox’s internal memory; and then move your files off to a USB flash drive using FTP SCPI programming. Refer to **Using FTP with FieldFox** and to the **FieldFox Programming Guide**.
 2. Save your data to the FieldFox’s internal memory, then move the data to a PC using a binary block transfer, and delete the data from the FieldFox’s internal memory. An example for transferring an image:
http://na.support.keysight.com/fieldfox/help/Programming/webhelp/Examples/Transfer_Image_to_PC.htm. Please note that the receiving computer program needs to be able to handle the binary block transfer. See also **FieldFox Programming Guide**.
-

NOTE

Insert only ONE USB flash drive in the FieldFox when saving or copying files.

Saving MATLAB files

NOTE

If you have Option 351 I/Q Analyzer option, you can directly save your data as MATLAB files (*.mat). Refer to [Chapter 11, “IQ Analyzer \(IQA\) – Option 351 \(CPU2 Only\)”](#), on page 293 and to [Chapter 32, “File Management”](#), on page 767.

If you have the FieldFox’s Remote Server mode (89600 VSA software connectivity), you can use the VSA software to capture and record your data as MATLAB files (*.mat). Learn more about FieldFox and 89600 VSA software, refer to [Chapter 17, “Remote Server Mode \(Requires CPU2 and SA Hardware/SA Option 233\)”](#) and to <http://rfmw.em.keysight.com/wireless/helpfiles/89600B/WebHelp/89600.htm>.

Figure 32-1

I/Q Analyzer Mode (IQA) MATLAB File Save

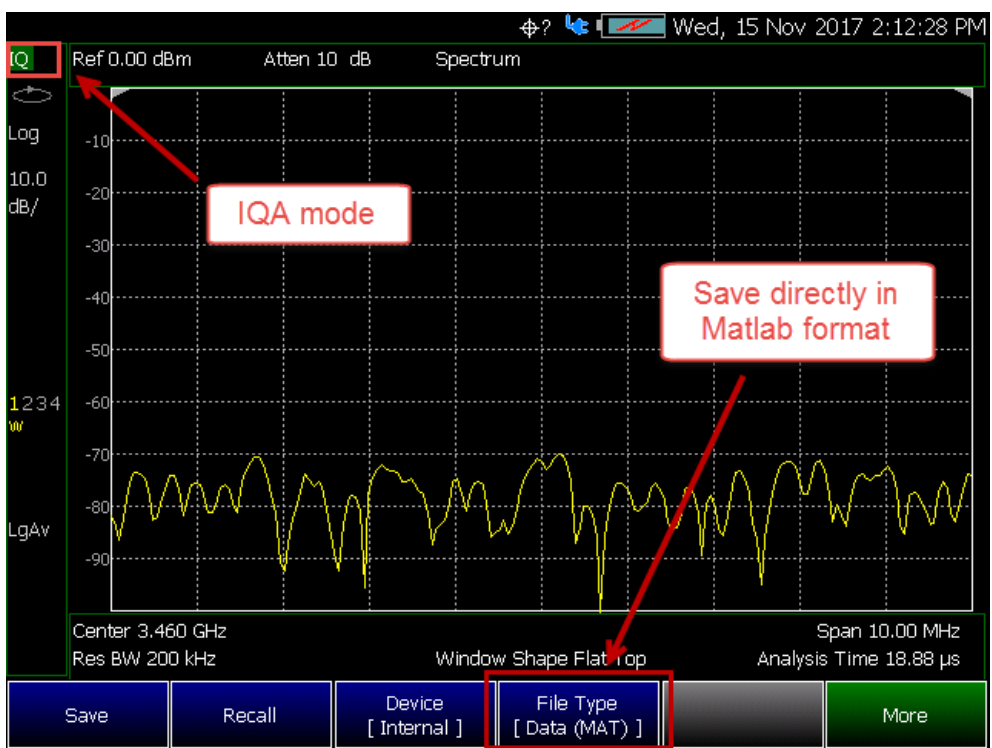
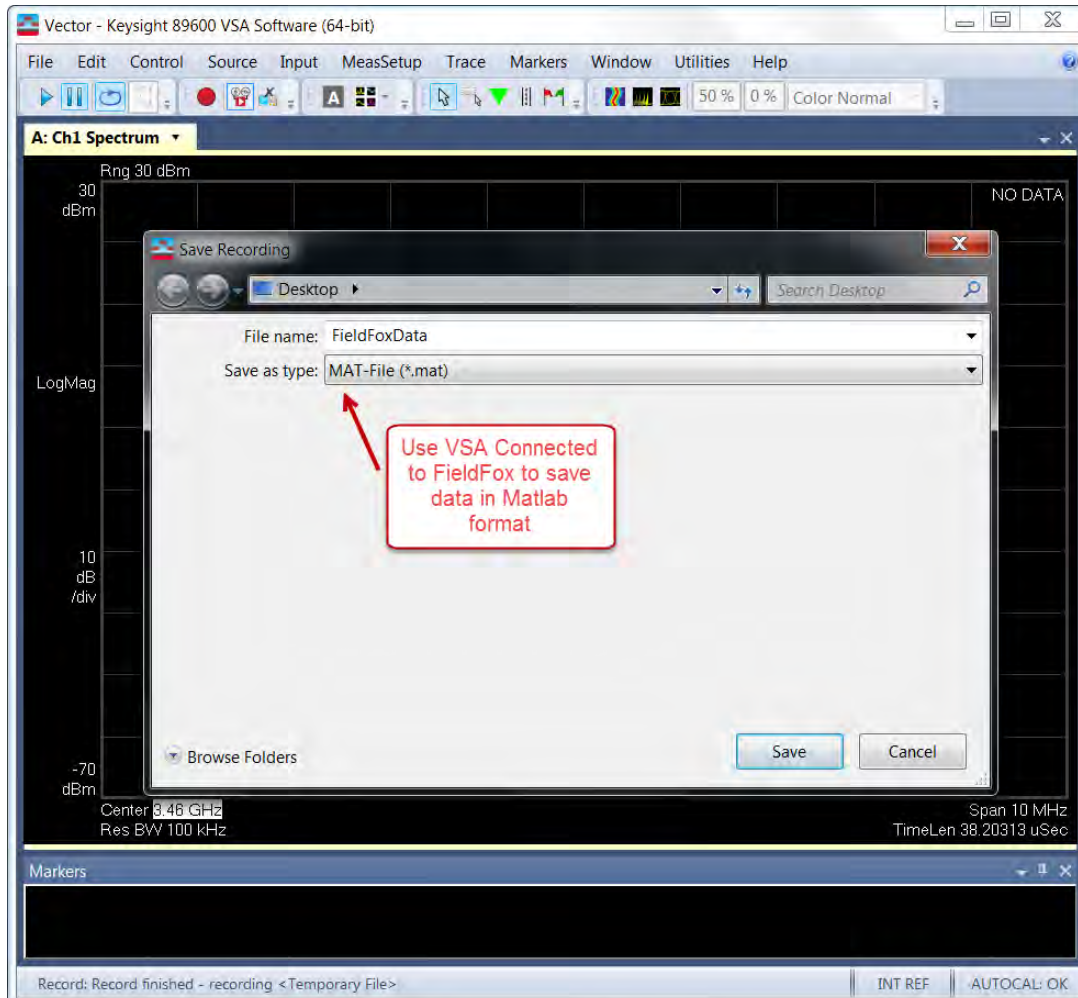

Figure 32-2 VSA Software MATLAB File Save



How to use the FieldFox labeler

The FieldFox labeler is used to edit or change the current filename. It is also used for many other labeling functions, such as creating a title, prefix, and keyword to display on the FieldFox screen. Learn about Titles in [“How to Manage files” on page 776](#).

- Move the cursor (see section below, How to move the cursor), then press **Select** to add the cursor character to the end of the existing filename.
- **Back Space** to erase the last character(s) from the end of a filename.
- Press **Shift** to toggle keyboard between lower case and upper case characters.
- Press **Alt Keyboards** to display the different keyword choices.

NOTE

You can select either an ABC or Qwerty style keyboard. Refer to [“Alpha Numeric Editing” on page 742](#).

The preselected keywords (File, Site, and so forth) can be selected just like a single character. These keywords can also be edited. Learn more in [“Edit Keywords” on page 779](#).

Figure 32-3 The FieldFox labeler

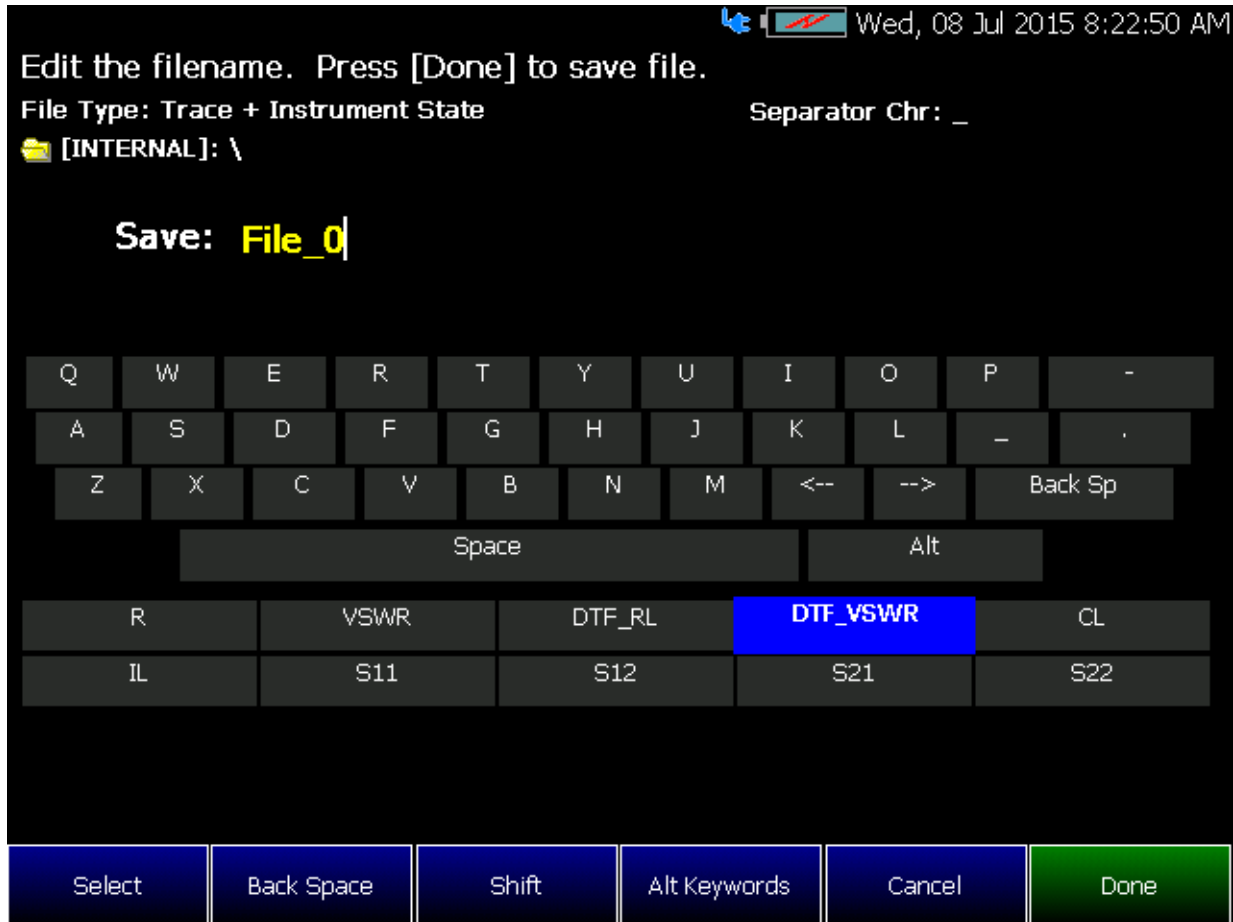

In the graphic above, the current filename is **File_0**. The cursor is on the custom **DTF_VSWR** keyword. The file will be saved to USB (flash drive). File Type is “Trace + State” (Instrument State).

How to move the cursor

- Use the rotary knob to move cursor on the same row. The cursor will change rows when it comes to a row end.
- Use the  arrows to move the cursor up and down the rows.

When the current filename is complete

- Press **Done** to save the file to the specified filename.
- Press **Cancel** to close the labeler without saving a file.

- If the filename already exists, you are prompted to choose from the following:
 - Press **Yes** to overwrite the existing file.
 - Press **Cancel** to return to edit the filename.

Recall Files

The FieldFox can recall **State** files, **Trace + State** files, and image files.

State Files

ALL FieldFox instrument settings for ALL Modes are saved and recalled in a *.sta file. If error correction is ON in CAT or NA Mode, then calibration data is also saved and recalled.

If error correction is OFF (CalRdy is active), calibration data is NOT saved in the *.sta file. When a Trace + State file is recalled on a FieldFox other than the one it was saved on, differences in the CalRdy calibration data may result in differences between the displayed traces.

Image Files

The FieldFox can open and display *.png, *.jpg, and *.jpeg images.

How to Recall a File

NOTE

Before recalling a file, first Select the Device and Location from which the file will be recalled. See the following section for more information.

- Press **Save/Recall 9**
- Then **Recall File** or **Enter**
- Navigate to the file to be recalled using the Up/Down arrow keys.
- Optional: **Sort by Name** to list the current files by name.
- Optional: **Sort by Date** to list the current files by date.
- Optional: **Next Page** if available, to go to the next page of filenames.
- Optional: **Previous Page** if available, to go to the previous page of filenames.
- Then **Recall File** or **Enter**.
- **Cancel** to cancel recall file and return to the previous menu.

Move (Copy) Files

The FieldFox can **Move** files (i.e., including **Trace + State** files, and image files).

How to move a file

- Press **Save/Recall 9**
- Then **Device** to be copied from (i.e., Internal, SD, or USB). Refer to **“Set File Type and Select Device” on page 773**.
- Then **More**
- Then **Manage Files**
- Then **Select Files**
- Navigate to the file(s) to be copied using the Up/Down arrow keys or the knob.
- Then **Copy**
 - Select the destination device using the softkeys:
 - **Copy to Internal** Copies to FieldFox’s internal memory.
 - **Copy to USB** Copies to a USB memory device.
 - **Copy to SD Card** Copies to a SD/SDHC memory card.
 - **Cancel** to cancel copy file and return to the previous menu
 - Use the close folder icon or the open folder icon to locate the target folder for your files.
 - Then **Do Copy** copies files to selected location and FieldFox displays a confirmation message of a successful file copy.
 - **Cancel** to cancel copy file and return to the previous menu.

Set File Type and Select Device

The following File TYPE and DEVICE settings are used to determine the type of file to save, and the location to be used for all file operations.

These two settings remain through an instrument preset, but are reset to the default values when the FieldFox power is shutdown.

Select Device (location of File Save/Recall)

- Press **Save/Recall 9**
- Then **Device** to set the LOCATION where the file is to be saved, recalled, or moved. Choose from the following:
 - **Internal** Saves/Recalls/Moves (Copies) files to/from the FieldFox internal memory. To specify a folder, first select Manage Folders (learn how in **“Manage Folders” on page 778**). The Data Link software will read data ONLY from the \UserData folder.

- **SD Card** Saves/Recalls/Moves (Copies) files to/from the SD card (not included), inserted in the card slot. See **“Take the FieldFox Tour” on page 45**. Only the root folder is available.
- **USB** Saves/Recalls/Moves (Copies) files to or from a USB Flash drive (not included) that is inserted in one of the USB connectors. Only the root folder is available.

NOTE

Insert only ONE USB Flash Drive in the FieldFox when saving or copying files.

How to set File Type

- Press **Save/Recall 9**
- Then **File Type**. Choose one of the following:
 - **State** Saves ALL FieldFox instrument settings for ALL Modes to a *.sta file. If a calibration is ON in CAT or NA Mode, calibration data is also saved. This file can be opened ONLY by a FieldFox. State files can be saved between compatible FieldFox models. See note in: **“Saving and Recalling Files” on page 768**.
 - **Trace+State** Saves the current trace and instrument settings to a *.sta file. In SA Mode, all traces are saved. This file can be opened ONLY by a FieldFox. When recalled, the FieldFox sweep is set to Hold.

CAUTION

When using RTSA, the Density Spectrum information is not saved using Trace+State. Only the last displayed trace settings is saved.

- **Picture (PNG)** Saves a 640 x 453 pixel image of the FieldFox screen to a *.png file. The picture does NOT include the softkeys.
- **Data (csv)** Saves trace data from the current Mode to a *.csv file. This format can be imported into spreadsheet software such as Microsoft Excel. Column A is always the frequency at which the data is measured.
 - In **SA Mode**, all visible data traces are saved. Each trace is saved to a separate column that is labeled with the Trace State.
 - In **CAT** and **NA** Modes, only the data trace is saved – not the memory trace.
 - In **Power Meter** (with Option 208 Frequency Offset Power Sensor (FOPS)), all visible traces are saved. Each trace is saved to a separate column labeled **Output Power** or **Memory**.
 - In **VVM** Mode, NO data is saved.

- **Data (S1P) / (S2P)** Saves **CAT** and **NA** Mode trace data to an *.S1P or *.S2P file, depending on the active measurement. This file format is used by CAE programs such as Keysight's Microwave Design System (MDS) and Advanced Design System (ADS). It can also be imported into spreadsheet software such as Microsoft Excel.

About SNP Files

The SNP file includes header information, and the following data:

- S1P - saves 1-port (receiver) data for the active data trace. *.s1p Files contain 1 stimulus value and 1 S-parameter (total of 3 scalar values) **Stim Real(Sxx) Imag(Sxx)**
- S2P (NA Mode ONLY) - saves 2-port data for the active trace. *.s2p Files contain 1 stimulus value and 4 S-parameters (total of 9 scalar values) **Stim Real(S11) Imag(S11) Real(S21) Imag(S21) Real(S12) Imag(S12) Real(S22) Imag(S22)**
- Only data traces are saved – not memory traces.

Corrections

- When parameters are corrected, data is returned even when not displayed. Data is returned with the correction type that is applied for each S-parameter. The correction type for each S-parameter is annotated in the header.
- When parameters are NOT corrected or displayed:
 - With Smith chart and Polar formats, Real/Imag zero-filled data appears as (1.0, 0.0).
 - With all other formats, LogMag/Phase zero-filled data appears as (0.0, 0.0).

> Display formats

In CAT Mode, S1P files are always Magnitude (dB) / Phase (angle) format.

In NA Mode:

- Smith chart and Polar display formats are ALWAYS saved in Real/Imag data pairs.
- All other display formats are saved in LogMag/Phase (dbAngle).

> What Data Processing functions are included in saved SNP Data:

In NA Mode, the data processing functions (such as trace math) that are included in the SNP data depends on a Preference setting. Click **System**, then **Preferences**, then **Preferences**, then scroll to **NA, SNP File Save**, then select from the following:

- **Default** – SNP data does NOT include smoothing. SNP data saves are taken AFTER data processing (location 2) on the processing chain.
- **Advanced** – SNP data includes the following:
 - With Smith or Polar display format, SNP data saves are taken BEFORE most processing (location 1 on the data processing chain).
 - With any other display format, SNP data saves are taken just AFTER Formatting and Smoothing is applied (location 3 on the data processing chain). For each non-active trace, SNP trace data is reprocessed using the data processing chain of the active trace.

See the FieldFox data processing chain at the **Supplemental Online Help:** <http://na.support.keysight.com/fieldfox/help/SupHelp/FieldFox.htm> Learn more about System Preferences in “**Preferences**” on page 733.

Manage Files

Files that are stored in the FieldFox internal memory, standard SD card, and USB Flash drive, can be copied to another device or deleted.

How to Manage files

- Press **Save/Recall 9**
- Then **Device** to select the location (Internal, USB, or standard SD Card) of the file to copy or delete.

NOTE

When selecting Internal, it may also be necessary to first select Manage Folders to specify an active folder which contains the files to copy or delete. Refer to “**Manage Folders**” on page 778.

- Then **More**
- Then **Manage Files**
- Then choose from the following:
 - **Select Files** Selects a file or files to sort, copy, or delete.
 - **Sort**
 - **Sort by Name** Sorts the displayed list of files by name.
 - **Sort by Date** Sorts the displayed list of files by date.
 - **Copy** Select a file or files to copy.
- Then select a device to copy the file to. Choose from **Copy to Internal**, **Copy to USB** (must be inserted), or **Copy to SD Card** (must be inserted).

- **Do Copy** to complete the file copy to the media/folder selected.

NOTE

Copy can be done to any FieldFox internal folder, standard SD folder, or USB storage device.

- **Delete**
 - **Yes** The selected file is deleted.
 - **Cancel** To cancel Delete and return to previous menu.
- **More**
 - **Select Files** Selects a file or files to sort, copy, or delete.
 - **Select All** selects all of the displayed files. All files that are displayed are to be copied. Then select a device and a folder to copy the file to. Choose from Internal, USB (must be inserted), or SD Card (must be inserted).
 - **Clear All** Deselects all of the displayed files.
 - **Rename Files**

NOTE

For more on renaming folders/files, refer to **“How to use the FieldFox labeler ” on page 770** and **“Prefixes and Suffixes for Filenames” on page 779**.

- Enter the string in the filename or filenames that are to be replaced.

NOTE

String to Replace is case sensitive.

- **Replace With** Enter the string that is to be replaced by the characters entered with the String to Replace softkey.
- **Prefix** Enter a prefix (one time) that the current filename or filenames are to be renamed. To add a prefix to subsequent filenames (persistent), refer to How to edit the Prefix and Suffix (Auto Append) in **“How to edit the Prefix and Suffix (Auto Append)” on page 780**.
- **Suffix** Enter a suffix that the current filename or filenames are to be renamed.
- **Do Rename** Enable renaming of the current file or files.

NOTE

Insert only ONE USB Flash Drive in the FieldFox when saving or copying files.

Manage Folders

You can create new folders, delete old folders, and select the active folder to which files can be saved. The Parent folder [...] is listed when not in the root directory.

Press Save/Recall 9

- Press **Save/Recall 9**
- Then **More**
- Then **Manage Folders**
- Then choose from the following:
 - **Change Folder** Changes the active folder to which files can be saved. The active device and current folder is displayed at the top of the screen, and below, a list of files in that folder. Use the **▲▼** arrows to highlight a folder within the current folder. Each time the **Change Folder** softkey is pressed, the highlighted folder becomes the active folder.
 - **Create Folder** A new folder is created in the current folder. Select a name for the new folder from one of the displayed keywords: You can change these keywords using the following **Edit Keywords** function. Refer to Edit Keywords in **“Edit Keywords” on page 779**.
 - **Delete Folder** The **selected** folder and its contents are deleted after a warning prompt is displayed. A “Parent” folder or system folder can NOT be deleted.
 - **Copy Folder** The **selected** folder and its contents are copied and a message is displayed telling you that the copy was successful.
 - Then select a device to copy the folder to. Choose from **Copy to Internal**, **Copy to USB** (must be inserted), or **Copy to SD Card** (must be inserted).
 - Do Copy** to complete the file copy to the media/folder selected.
 - **Rename** The rename folder menu opens and the selected folder’s title is displayed and available for editing.

NOTE

For more on renaming folders/files, refer to **“How to use the FieldFox labeler” on page 770**, and **“Prefixes and Suffixes for Filenames” on page 779**.

-
- Press **Exit** when finished.

Edit Keywords

The preselected keywords (FILE, SITE, and so forth) can be edited to meet your specific needs. Your keywords will remain in the FieldFox until you change them. Keywords are limited to 30 characters.

How to edit keywords

- Press **Save/Recall 9**
- Then **More**
- Then **Edit Keywords**
- Then **Next Page** and **Previous Page** to view all keywords.
- Use the **▲▼** arrows to select a keyword to edit.
- When a keyword is selected, then press **Edit**.
- Then choose from the following:
 - Press **Select** to add the cursor character to the end of the selected keyword.
 - Press **Backspace** to erase the last character from the end of the selected keyword.
 - Press **Shift** to change from upper-case to lower-case and vice versa.
 - Press **Alt Keywords** to toggle through different keyword choices.

How to move the cursor:

- Use the rotary knob to move the cursor along the same row. The cursor will change rows when it comes to a row end.
- Use the **▲▼** arrows to move the cursor up and down between rows.

When the selected keyword is complete:

- Press **Done** to save all keywords and close the Edit Keywords labeler. These keywords will exist on the FieldFox until changed.
- Press **Cancel** to close the labeler without saving changes.

Prefixes and Suffixes for Filenames

The prefix and suffix (Auto Append) can be used together to organize files. Once set and enabled, they are automatically entered as the beginning (Prefix) and end (Suffix - using Auto Append) of a filename when performing a Save

operation. These settings are persistent, until disabled. Refer to [“How to edit the Prefix and Suffix \(Auto Append\)” on page 780](#) and [“How to enable/disable Auto Append \(Suffix\)” on page 781](#).

NOTE

If you are only interested in adding a prefix or a suffix to a new file or files one time, refer to [“Manage Files” on page 776](#).

This section contains the following sections:

- [“How to edit the Prefix and Suffix \(Auto Append\)” on page 780](#).
- [“How to move the cursor” on page 771](#).
- [“When the Prefix is complete” on page 781](#).
- [“How to enable/disable Auto Append \(Suffix\)” on page 781](#).

How to edit the Prefix and Suffix (Auto Append)

If you want to edit a prefix on a finite set of files one time, refer to [“Manage Files” on page 776](#).

- Press **Save/Recall 9**
- Then **More**
- Then **Prefix Suffix**
- Then choose from the following:
 - **Edit Prefix** to edit the prefix using the labeler. For more, refer to [“How to edit the Prefix and Suffix \(Auto Append\)” on page 780](#).
 - **Select** to add the cursor character to the end of the Prefix.
 - **Back Space** to delete the last character(s) from the end of the prefix.
 - **Shift** to toggle between capital letters and lower case letters.
 - **Alt Keywords** to display the different preselected keywords (File, Site, and so forth) can be selected just like a single character. These keywords can also be edited. See Edit Keywords.
 - **Cancel** to cancel edits and return to the previous menu.
 - **Auto Append** (Suffix)
 - **OFF** to turn off Auto Append.
 - **Number** to auto-append a number using format “_nnn” sequentially to all saved files.
 - **Date** to auto-append a date and time using format “_YYYY-MM-DD.HH.MM.SS” sequentially to all saved files.

- **Number Suffix Reset** to reset Auto Append number to “_001”.
- **Prefix**
 - **OFF** to disable the prefix. The Prefix softkeys are grayed out (inactive). Refer to How to enable/disable the Prefix (persistent) in **“How to enable/disable the Prefix (persistent)” on page 781.**
 - **Last File** to use the last filename saved, as your filename for subsequent saved filenames.
 - **User** to use the user-selected prefix.
- **Back** to return to the previous menu.

NOTE

When Last File is selected, the Edit Prefix and Auto Append softkeys are unavailable (grayed out). Refer to **“Prefixes and Suffixes for Filenames” on page 779.**

How to move the cursor

- Use the rotary knob to move cursor on the same row.
- Use the  arrows to move the cursor up and down the rows.

When the Prefix is complete

- Press **Done** to save the Prefix and close the labeler. This Prefix will exist on the FieldFox until it is changed.
- Press **Cancel** to close the labeler without saving changes.

How to enable/disable the Prefix (persistent)

- Press **Save/Recall 9**
- Then **More**
- Then **Prefix Suffix**
- Then **Prefix**
 - **OFF** to disable the prefix on subsequently saved files. Edit Prefix, Auto Append, and Number Suffix Reset softkeys are grayed out (inactive).

How to enable/disable Auto Append (Suffix)

- Press **Save/Recall 9**
- Then **More**
- Then **Prefix Suffix**
- Then **Auto Append**
- **OFF** to disable the Auto Append (Suffix) on subsequently saved files. Auto, and Number Suffix Reset softkeys are grayed out (inactive).

Press Printing

The current screen or selected files can be printed using a PCL-compatible printer (like older HP Deskjet printer) connected to one of the FieldFox USB ports. Newer PCL3GUI photo and all-in-one printers are NOT supported.

Measurements can also be printed using the FieldFox Data Link software.

How to print the current screen or a saved file

To save ink, first select an outdoor (white background) display color. Learn how in **“Display Colors” on page 721**.

- Connect the printer to a FieldFox USB port. **The print softkey will appear ONLY when a compatible printer is connected.**
- Then press **Save/Recall 9**
- Then **Print** and choose from the following:
 - **Printer & Page\nSetup** – Confirm that the printer is connected and configured properly. The Status line should read “Ready’.
 - Make other print settings as desired.
 - **Select Files\nfor Printing** – Print up to 16 *.PNG images on one page that are stored on the Internal drive. Images can NOT be printed from the USB and SD card.
 - Edit the Quick Settings table to select up to FOUR Rows and FOUR Columns for up to 16 total images to be printed on a single page.
 - If necessary, edit the filenames to be printed.
 - Select **Done**. Then **Print Selected\nFiles** to begin printing.
 - **Print Current Screen** – Immediately prints the FieldFox screen using the selected Printer and Page Setup settings.

33 Working with the Lithium-Ion Battery

In this Chapter

[“Viewing the Battery Charge Status” on page 783](#)

[“Charging the Battery” on page 785](#)

[“Reconditioning Battery” on page 788](#)

[“Battery Care” on page 788](#)

[“Maximizing Battery Life” on page 788](#)

[“Lithium-Ion Battery Disposal” on page 789](#)

See Also:

[“Install the Lithium-Ion Battery” on page 38](#)

[“To conserve battery power:” on page 39](#)

[“For the Battery” on page 795](#)

Viewing the Battery Charge Status

You can view the battery charge status in the following ways:

- Icons in the upper right of the front panel screen.
- Battery screen - select System then Service Diagnostics then Battery.
- Built-in battery gauge. Learn more in the following section.

Table 33-1

Front Panel Icons



Icon	Status
	Connected to external power through the AC/DC adapter. Battery installed and charging. The amount of charge is indicated by the number of bars shown.

Table 33-1

Front Panel Icons

Icon	Status
	Battery not charging with 84% battery life remaining.
	Battery fully charged. A fully charged battery MAY NOT read 100%.

Service Diagnostics–Battery Screen

The Battery screen displays the following information. To access the screen, select System then Service Diagnostics then Battery.

Additional battery information is available using SCPI commands.

1. **Status** – Fully charged, No battery, Charging, Empty, or Discharging.
2. **External DC Supply** – ON or OFF indicates if an external DC supply is connected.
3. **Battery Present** – ON or OFF indicates if a battery is installed.

NOTE

Items 4 through 8 are read directly from the battery. The information is based on the battery’s internal sensors and memory.

1. **Voltage** – measured by the battery’s sensor.
2. **Current** – amount of current being consumed when operating from internal battery. If battery is charging, indicates amount of charging current.
3. **Battery Temperature** – internal temperature of the battery as measured by a sensor embedded in the battery.
4. **Present Run Time to Empty** – minutes of power remaining based on amount of current being used now.
5. **Charge Cycles** – number of charge cycles the battery has experienced. Charge cycle defined as $\geq 80\%$ change in relative state of charge.

Built-In Battery Gauge

Each lithium ion battery has an LED gauge that displays its charge status. The gauge is active unless the battery is in shut down mode.

To view the LED gauge, open the FieldFox battery compartment door, remove the battery, then press the button on the battery.

The battery in your FieldFox will have either 4 or 5 LED segments.

5-segment Gauge	Charge Remaining	4-segment Gauge	Charge Remaining
5 segments	≥80%	4 segments	≥75%
4 segments	60% to 79%	3 segments	50%,to 74%
3 segments	40% to 59%	2 segments	25% to 49%
2 segments	20% to 39%	1 segment	< 25%
1 segment	< 20%		

Charging the Battery

When you receive your FieldFox, the lithium-ion battery is partially charged to approximately 30% to 40% to preserve battery life. Allow four hours to fully charge the battery internally, or three and a half hours () by using the external battery charger (N9910X-872). A fully charged battery will power your FieldFox for about four hours. Upon receiving your FieldFox, it is NOT necessary to charge your FieldFox's battery before using your instrument.

The FieldFox circuitry ALWAYS prevents the battery from discharging to a level that is damaging. However, if the battery is completely discharged, the FieldFox may not turn ON. If this occurs, the battery can still be charged either internally or externally.

Because a lithium-ion battery has no memory effect, you can charge a battery at any time regardless of the current charge status.

Internal Charging with the AC/DC Adapter

NOTE

Read the safety information in **“For the AC/DC Adapter” on page 794.**

Internal charging time for a fully depleted battery is approximately 4 hours with the FieldFox either ON or OFF.

Figure 33-1 AC/DC Adapter



To charge a battery inside the FieldFox, insert the AC/DC adapter plug into the Power connector on the FieldFox side panel, then plug the adapter into an AC outlet.

- FieldFox ON: Charging is indicated by a battery icon in the upper right of the front panel screen.
- FieldFox OFF: Charging is indicated by the FieldFox power LED glowing amber, with its intensity increasing from dim to bright every few seconds. This pattern repeats until the LED turns off when charging is done. Learn more on **“Front Panel” on page 45.**

Using the External Battery Charger (N9910X-872)

NOTE

Read the safety information in **“For the External Battery Charger (N9910X-872)”** on page 795.

Figure 33-2 External Battery Charger (N9910X-872)



The external battery charger (N9910X-872), lets you charge a fully depleted battery in approximately three hours. It is a two bay, level-3 stand-alone battery charger that is compliant with the standard Smart Battery System. The two bays are charged sequentially on a first-come, first-served basis, though a discharge can be performed in the left bay while the right bay is charging.

External Battery Charger LED	Charging Status
Green	Fully charged
Green flashing	Fast charging
Yellow flashing	Reconditioning – the accuracy of the battery’s internal LED charge gauge is being renewed. See “Reconditioning Battery” on page 788
Yellow/green	Battery is reconditioned
Red flashing	Error
Yellow	Standby

For more information, refer to the Instruction Manual included with the external battery charger.

Reconditioning Battery

Reconditioning a battery can be performed ONLY with the External Battery Charger (N9910X-872).

1. Insert a battery into the left bay of the external charger.
2. Press the button labeled Push to Recalibrate Left Battery Bay
3. The charger will charge the battery fully, discharge it completely, then recharge it fully again. The entire process can take up to 12 hours.
4. Install the battery into the FieldFox.
5. On the System, Battery screen, verify that the battery is fully charged.

Battery Care

Visually inspect the battery periodically for signs of degradation, such as swelling, cracking of the battery shell, or leakage of fluid. If degradation occurs, replace the battery and dispose of it properly. Refer to **“Lithium-Ion Battery Disposal” on page 789**. Operation with a degraded battery could result in damage to the FieldFox.

Maximizing Battery Life

- If AC power is not continuously available (Ex: in a field environment), use the battery and recharge it when it holds a 20% to 50% charge, as shown on the screen’s battery charge icon. At this charge level, 2 or 3 segments show on the battery gauge.
- If the FieldFox is not going to be used for more than a week, remove the battery. Best practice is to store the battery with a charge of about 50%. At this charge level, 3 segments show on the battery gauge.
- Allow a battery to warm to room temperature before charging it. Temperature shock can damage the battery chemistry and in some cases cause a short circuit.
- Store batteries in a cool, dry location, away from metal objects and corrosive gases.
Storage temperature limits (20% to 50% relative charge is recommended):
 - Transportation: –20°C to 50°C
 - Within 1 month: –20°C to 45°C
 - Within 6 months: –20°C to 40°C
 - Within 1 year: –20°C to 35°C

Working with the Lithium-Ion Battery

Lithium-Ion Battery Disposal

- Battery charging limits:
Charge temperature: 0°C to 45°C (<10°C slows charge on some batteries)
Discharge temperature: –10°C to 60°C
- Operate the FieldFox on battery power between the ambient temperatures of –10 and +50°C (–14 to +122°F). Using the battery at lower or higher temperatures can damage it and reduce operating life. Cold temperatures affect battery chemistry, reducing charge capacity, especially below 0°C (32°F).

Lithium-Ion Battery Disposal

When you notice a large decrease in charge capacity after proper recharging, it's probably time to replace the battery.

Lithium-Ion batteries need to be disposed of properly. Contact your local waste management facility for information regarding environmentally sound collection, recycling, and disposal of the batteries. Regulations vary for different countries. Dispose of the battery in accordance with local regulations.

Keysight Technologies, through Rechargeable Battery Recycling Corporation (RBRC), offers free and convenient battery recycling options in the U.S. and Canada. Contact RBRC at 877-2-RECYCLE (877.273.2925) or online at: <http://www.call2recycle.org/> for the nearest recycling location.

Working with the Lithium-Ion Battery
Lithium-Ion Battery Disposal

34 Safety Considerations

Keysight has designed and tested the FieldFox in accordance with IEC Publication 61010-1 Safety Requirements for Electrical Equipment for Measurement, Control and Laboratory Use, and the FieldFox is supplied in a safe condition. The FieldFox is also designed for use in Installation Category II and pollution Degree 2 per IEC 61010-1. Read the following safety notices carefully before you start to use this FieldFox to ensure safe operation and to maintain the product in a safe condition.

NOTE

The input terminals for this product are classified as Measurement Category None.

For the FieldFox

WARNING

No operator serviceable parts inside except for the lithium-ion battery. Refer servicing to qualified personnel. To prevent electrical shock do not remove covers.

WARNING

If this product is not used as specified, the protection provided by the equipment could be impaired. This product must be used in a normal condition (in which all means for protection are intact) when attached to the AC-DC adapter.

WARNING

The unit may be used only in the operating conditions and positions specified by the manufacturer.

WARNING

Do not install substitute parts or perform any unauthorized modification to the product. Return the product to Keysight Technologies or a designated repair center for service to ensure that safety features are maintained.

WARNING

Applicable local or national safety regulations and rules for the prevention of accidents must be observed in all work performed.

WARNING

Ensure that the connections with information technology equipment comply with IEC950 / EN60950.

WARNING

Observe all ratings and markings of the instrument before connecting the instrument.

Maximum Input Voltages and Power:

RF Output Connector: 50V DC, +23 dBm RF

Ext Trig/Ref Connector: 5.5 V DC

RF Input:

+27 dBm RF, ± 50 VDC Max. (N991xA/B, N9925B, N9926A, N9928A, N993xA/B)

+23 dBm RF, ± 50 VDC Max. (N9923A, N9923AN)

+25 dBm RF, ± 40 VDC Max. (N995xA/B, N996xA/B)

DC Input: 19VDC, 4ADC

WARNING

When performing a measurement, ensure that the right safety and performance ratings of the instrument and accessories are used.

Do not expose the circuit or operate the instrument without its cover or while power is being supplied.

Do not operate the instrument in any environment at risk of explosion.

WARNING

Only Keysight approved accessories shall be used.

WARNING

Cleaning connectors with alcohol shall only be done with the instruments power cord removed, and in a well-ventilated area. Allow all residual alcohol moisture to evaporate and the fumes to dissipate prior to energizing the instrument.

CAUTION

The power cord and connectors shall be compatible with the connector used in the premise electrical system. Failure to ensure adequate earth grounding by not using the correct components may cause product damage and serious injury.

CAUTION

The measuring terminals on this instrument are designed to be used with external signals described in Measurement Category NONE, but NOT with external signals described in Categories II, III, and IV. The input of this instrument cannot be connected to the mains.

CAUTION

It is not recommended to operate the FieldFox when it is laying on its back on a table top or other flat surface, with the kickstand folded in. The cooling is less effective when the FieldFox is placed lying down flat on back of the instrument.

CAUTION

Use original packaging or comparable for shipping or transporting the instrument.

For the AC/DC Adapter

WARNING

Use only the designated AC/DC adapter supplied with the instrument.

WARNING

Use only the designated power cord supplied with the AC/DC adapter.

WARNING

Operated at an ambient temperature: 0 to 40°C; full power rating; derate linearly at a rate of 3 watts per degree C, from 90W at 40°C to 45W at 55°C, 30W at -20°C.

Input: 100-240 VAC, 1.5-0.75A, 50-60 Hz

Output: 15 VDC, 6A

WARNING

To prevent electrical shock, disconnect the AC to DC adapter from the mains before cleaning. Use a dry cloth or one slightly dampened with water to clean the external case parts. Do not attempt to clean internally.

WARNING

When the FieldFox is connected to the AC/DC adapter, position the adapter so the power cord is readily accessible. The power cord is the disconnecting device. It removes main power to the AC/DC adapter. The FieldFox front panel switch is only for the DC power within the instrument, and not for the AC/DC adapter. Alternately, an AC switch or circuit breaker (which is readily identifiable and is easily reached by the operator) may be installed and used as a disconnecting device to remove mains power from the AC/DC adapter.

WARNING

To avoid overheating, always disconnect the FieldFox from the AC/DC adapter before storing the FieldFox in the backpack.

If you prefer to leave the FieldFox connected to the AC/DC adapter while inside the backpack, you can disconnect the AC/DC adapter from its AC power source to prevent overheating.

WARNING

Safety of any system incorporating the equipment is the responsibility of the assembler of the system.

WARNING

This is a Safety Protection Class I Product (provided with a protective earthing ground incorporated in the power cord). The mains plug shall only be inserted in a socket outlet provided with a protective earth contact. Any interruption of the protective conductor inside or outside of the product is likely to make the product dangerous. Intentional interruption is prohibited.

CAUTION

The AC/DC adapter has an auto-ranging line voltage input – be sure the supply voltage is within the specified range.

CAUTION

The AC/DC adapter is for indoor use only.

CAUTION

Never use a modified or damaged charger. Use the original AC-DC adapter ONLY.

CAUTION

The AC/DC adapter is designed for use in Installation Category II and Pollution Degree 2 per IEC 61010-1.

CAUTION

The instrument can operate with mains supply voltage fluctuations up to $\pm 10\%$ of the nominal voltage.

For the External Battery Charger (N9910X-872)

CAUTION

If charging batteries externally, use the optional external charger available from Keysight, or another SMBus charger of level II or higher.

Never use a non-SMBus charger because the battery issues commands over the SMBus to the charger to control the charge rate and voltage.

Never use a modified or damaged charger.

External AC/DC power supply, U.S. FCC compliance

Meets the required verification equipment authorization rules.

This device complies with part 15 of the FCC Rules. Operation is subject to the following two conditions: (1) This device may not cause harmful interference, and (2) this device must accept any interference received, including interference that may cause undesired operation.

For the Battery

Lithium battery packs may get hot, explode, or ignite and cause serious injury if exposed to abuse conditions.

This section contains the following:

- “High Capacity Lithium Battery (N9910X-876)”
- “Standard Capacity Battery (N9910X-870)”

High Capacity Lithium Battery (N9910X-876)

Lithium battery (High Capacity): N9910X-876 (battery Keysight part number: 1420-0937) is used to provide power to a family of portable microwave test instruments produced by Keysight Technologies. Be sure to follow these safety warnings:

External battery, U.S.
FCC compliance

Battery storage:

The only instructions related to storage have to do with temperature and are listed below

- "Temperature (1 month): -20°C to +45°C
- "Temperature (6 month): -20°C to +40°C
- "Temperature (12 month): -20°C to +35°C

Rating:

10.8V 6400mAh 70Wh

WARNING

Lithium-ion batteries:

- Must not be exposed to high temperatures (>70°C) or fire.
- Must be kept away from children.
- Must not be short circuited.
- Must be replaced only with Keysight qualified Li-ion batteries.
- If replaced or charged improperly, there is a danger of explosion.

WARNING

Do not connect the positive terminal and negative terminal of the battery to each other with any metal object (such as wire).

WARNING

Do not carry or store the battery with necklaces, hairpins, or other metal objects.

WARNING

Do not pierce the battery with nails, strike the battery with a hammer, step on the battery, or otherwise subject it to strong impacts or shocks.

WARNING

Do not solder directly onto the battery.

WARNING

Do not expose the battery to water or salt water, or allow the battery to get wet.

WARNING

Do not disassemble or modify the battery. The battery contains safety and protection devices, which if damaged, may cause the battery to generate heat, explode, or ignite.

WARNING

Do not place the battery in direct sunlight, or use or store the battery inside cars in hot weather. Doing so may cause the battery to generate heat, explode, or ignite. Using the battery in this manner may also result in a loss of performance and a shortened life expectancy.

WARNING

There is a danger of explosion if the battery is incorrectly replaced. Replace only with the same or equivalent type of battery recommended. Discard used batteries according to manufacturer's instructions.

WARNING

If you are charging the batteries internally, even while the FieldFox is powered off, the FieldFox may become warm. Allow for proper ventilation.

Do NOT run the FieldFox with the vents blocked or in the carrying case.

WARNING

Do not discharge the battery using any device except the FieldFox or the external battery charger (N9910X-872). When the battery is used in a device other than those specified, it may damage the battery or reduce its life expectancy. If the device causes an abnormal current to flow, it may cause the battery to become hot, explode, or ignite and cause serious injury.

The external battery charger discharges during recalibration.

WARNING

For a Korean battery safety consideration translation, refer to [Appendix D: "Korean Battery Safety Translation."](#)

WARNING

For a Russian battery safety consideration translation, refer to [Appendix E: "Russian Battery Safety Translation."](#)

WARNING

The external battery is not rated for use in a wet location. Do not use the external battery in a wet location.

Standard Capacity Battery (N9910X-870)

WARNING

Lithium-ion batteries:

- Must not be exposed to high temperatures (>70°C) or fire.
- Must be kept away from children.
- Must not be short circuited.
- Must be replaced only with Keysight qualified Li-ion batteries.
- If replaced or charged improperly, there is a danger of explosion.

WARNING

Do not connect the positive terminal and negative terminal of the battery to each other with any metal object (such as wire).

WARNING

Do not carry or store the battery with necklaces, hairpins, or other metal objects.

WARNING

Do not pierce the battery with nails, strike the battery with a hammer, step on the battery, or otherwise subject it to strong impacts or shocks.

WARNING

Do not solder directly onto the battery.

WARNING

Do not expose the battery to water or salt water, or allow the battery to get wet.

WARNING

Do not disassemble or modify the battery. The battery contains safety and protection devices, which if damaged, may cause the battery to generate heat, explode, or ignite.

WARNING

Do not place the battery in direct sunlight, or use or store the battery inside cars in hot weather. Doing so may cause the battery to generate heat, explode, or ignite. Using the battery in this manner may also result in a loss of performance and a shortened life expectancy.

WARNING

There is a danger of explosion if the battery is incorrectly replaced. Replace only with the same or equivalent type of battery recommended. Discard used batteries according to manufacturer's instructions.

WARNING

If you are charging the batteries internally, even while the FieldFox is powered off, the FieldFox may become warm. Allow for proper ventilation.

WARNING

Do not discharge the battery using any device except the FieldFox or the external battery charger (N9910X-872). When the battery is used in a device other than those specified, it may damage the battery or reduce its life expectancy. If the device causes an abnormal current to flow, it may cause the battery to become hot, explode, or ignite and cause serious injury.

WARNING

For a Korean battery safety consideration translation, refer to [Appendix D: “Korean Battery Safety Translation.”](#)

WARNING

For a Russian battery safety consideration translation, refer to [Appendix E: “Russian Battery Safety Translation.”](#)

Battery Protective Functions

This section contains the following:

- “**Battery Protective Functions (N9910X-876)**”
- “**Battery Protective Functions (N9910X-870)**” on page 802

Battery Protective Functions (N9910X-876)

The following protective functions are designed into the lithium-ion rechargeable battery system used in FieldFox.

The protective functions can be divided between two categories: active and passive. Active protection refers to the type of protection that depends on at least two or more protection devices working together to enable the protection. Passive protection refers to the type of protection that is always enabled independent of any other protection device.

Active Protection

Primary Overcharge Voltage: This prevents the battery from being charged if the voltage across any cell exceeds approximately 4.25 V per cell. Once the overcharge protection is tripped, the voltage across each cell must drop below approximately 4.10 V to reset the protection and permit charging.

Secondary Overcharge Voltage: This is a one-time, permanent protection that is triggered when the voltage across any cell exceeds approximately 4.30 V. Once this protection is tripped, the battery can no longer be used and must be replaced.

Overdischarge Voltage: This prevents the battery from discharging if the voltage across any cell drops below approximately 2.5 V. Once the overdischarge voltage protection is tripped, the voltage across each cell must be charged to approximately 3 V to reset the protection and permit discharging.

Primary Overcharge Current: This prevents the battery from being charged if the average charging current reaches or exceeds 3.3A for a time period of 5 seconds or more.

Secondary Overcharge Current: This prevents the battery from being charged if the charging current reaches or exceeds 4A+/-20% for a time period of 20 milliseconds or more.

Primary Overdischarge Current: This prevents the battery from being discharged if the average current out of the battery reaches or exceeds 7A for a time period of 5 seconds or more. This protection can be reset by removing the load.

Secondary Overdischarge Current: This prevents the battery from being discharged if the current out of the battery reaches or exceeds 6A for a time period of 20 milliseconds or more. This protection can be reset by removing the load.

Short Circuit Protection: This prevents the battery from being charged or discharged and protects against damage or lost data if the current ins or out of the battery reaches or exceeds 33.3A for a time period of 274.5 microseconds or more. This protection can be reset by removing the load.

Overtemperature Charging: The system microcontroller prevents the battery from being charged if the cell temperature exceeds 48C. Once the overtemperature charging protection is tripped, the cell temperature has to drop to or below 43C to reset the protection and permit charging.

Overtemperature Discharging: The system microcontroller prevents the battery from being discharged if the cell temperature exceeds 67C. Once the overtemperature discharging protection is tripped, the battery is automatically shut off which results in turning off the instrument as well.

Passive Protection

Reverse Charging: A reverse protection diode prevents against damage or lost data due to a reverse charge polarity applied to the battery terminals.

Primary Overtemperature: The maximum operating temperature of this fuse is 85C. An overtemperature cutout permanently opens at 85C with no recovery.

Secondary Overtemperature: A second PTC polyfuse built into each Li-ion cell will open up and limit current flow as a function of very high temperatures.

Tertiary Overtemperature: A current interrupt device (CID) within each Li-ion cell will permanently open up when the temperature reaches 95C. As each cell fuse is permanently interrupted, overall battery performance will become severely degraded, up to and including disabling the battery.

Battery Protective Functions (N9910X-870)

The following protective functions are designed into the lithium-ion rechargeable battery system used in FieldFox.

The protective functions can be divided between two categories: active and passive. Active protection refers to the type of protection that depends on at least two or more protection devices working together to enable the protection. Passive protection refers to the type of protection that is always enabled independent of any other protection device.

Active Protection

Primary Overcharge Voltage: This prevents the battery from being charged if the voltage across any cell exceeds approximately 4.35 V per cell. Once the overcharge protection is tripped, the voltage across each cell must drop below approximately 4.15 V to reset the protection and permit charging.

Secondary Overcharge Voltage: This is a one-time, permanent protection that is triggered when the voltage across any cell exceeds approximately 4.45 V. Once this protection is tripped, the battery can no longer be used and must be replaced.

Overdischarge Voltage: This prevents the battery from discharging if the voltage across any cell drops below approximately 2.6 V. Once the overdischarge voltage protection is tripped, the voltage across each cell must be charged to approximately 3 V to reset the protection and permit discharging.

Primary Overcharge Current: This prevents the battery from being charged if the average charging current reaches or exceeds 3.5A for a time period of 120 seconds or more.

Secondary Overcharge Current: This prevents the battery from being charged if the charging current reaches or exceeds $4A \pm 20\%$ for a time period of 20 milliseconds or more.

Primary Overdischarge Current: This prevents the battery from being discharged if the average current out of the battery reaches or exceeds 5A for a time period of 120 seconds or more. This protection can be reset by removing the load.

Secondary Overdischarge Current: This prevents the battery from being discharged if the current out of the battery reaches or exceeds 6A for a time period of 20 milliseconds or more. This protection can be reset by removing the load.

Short Circuit Protection: This prevents the battery from being charged or discharged and protects against damage or lost data if the current in or out of the battery reaches or exceeds 12.5A for a time period of 183 microseconds or more. This protection can be reset by removing the load.

Overtemperature Charging: The system microcontroller prevents the battery from being charged if the cell temperature exceeds 46C. Once the overtemperature charging protection is tripped, the cell temperature has to drop to or below 45C to reset the protection and permit charging.

Overtemperature Discharging: The system microcontroller prevents the battery from being discharged if the cell temperature exceeds 65C. Once the overtemperature discharging protection is tripped, the battery is automatically shut off which results in turning off the instrument as well.

Passive Protection

Reverse Charging: A reverse protection diode prevents against damage or lost data due to a reverse charge polarity applied to the battery terminals.

Primary Overtemperature: A PTC (positive temperature coefficient) polyfuse in series between the Li-ion cells and the charging and discharging transistors will open up and limit current flow to the battery terminals as a function of very high temperatures. This protection is resettable once the overstress condition is removed.

The maximum operating temperature of this fuse is 85C.

Secondary Overtemperature: A second PTC polyfuse built into each Li-ion cell will open up and limit current flow as a function of very high temperatures.

Tertiary Overtemperature: A current interrupt device (CID) within each Li-ion cell will permanently open up when the temperature reaches 95C. As each cell fuse is permanently interrupted, overall battery performance will become severely degraded, up to and including disabling the battery.

Overcurrent Fuse: This is a one-time blow fuse with a rated current of 12A.

Batteries: Safe Handling and Disposal

Refer to battery manufacture Safety Data Sheet (SDS) for safe handling and disposal information. Battery SDS's are located at:

<https://regulations.about.keysight.com/msds/default.htm>

Battery Transportation

Batteries are generally subject to transportation regulations, refer to the battery Safety Data Sheet (SDS) and contact your shipping department for transportation requirements.

Environmental Requirements

Refer to the FieldFox Specifications in **“Specifications/Data Sheet” on page 819.**

Electrical Requirements

The FieldFox allows you to use either the lithium-ion battery or the AC/DC adapter - both are included.

Electrostatic Discharge (ESD) Precautions

The FieldFox was constructed in an ESD protected environment. This is because most of the semiconductor devices used in this instrument are susceptible to damage by static discharge.

Static charges are generated in numerous ways, such as simple contact, separation of materials, and normal motions of persons working with the FieldFox. To prevent instrument damage, practice industry accepted techniques for handling static sensitive devices when using the FieldFox.

Very often, coaxial cables and antennas also build up a static charge, which, if allowed to discharge by connecting to the FieldFox, may damage the instrument input circuitry. To avoid such damage, it is recommended to dissipate any static charges by temporarily attaching a short to the cable or antenna prior to attaching to the instrument.

FieldFox Markings

The table below lists the definitions of markings that may be on or with the product. Familiarize yourself with each marking and its meaning before operating the instrument.

NOTE

All labels and symbols may not apply to the instrument.

























This symbol marks the standby position of the power line switch.



This symbol marks the ON position of the power line switch.

Safety Considerations
FieldFox Markings

	This symbol marks the OFF position of the power line switch.
	This symbol indicates that the input power required is AC.
	This symbol indicates DC voltage
	This symbol indicates a three-phase alternating current.
	This symbol indicates Frame or chassis Terminal.
	The instruction documentation symbol. The product is marked with this symbol when it is necessary for the user to refer to the instruction in the documentation.
	This symbol indicate the presence of a Laser device.
	This symbol indicates the surface can be hot.
	This symbol indicated the product is sensitive to electrostatic discharge.
	This symbol identifies the Protective Conductor terminal.
	This symbol indicates the equipment is protected throughout by double or reinforced insulation.
	The CE mark is a registered trademark of the European Community (if accompanied by a year, it is the year when the design was proven). It indicates that the product complies with all the relevant directives.
	The UK conformity mark is a UK government owned mark. Products showing this mark comply with all applicable UK regulations.
	The Keysight email address is required by EU directives applicable to our product.
	The CSA mark is a registered trademark of the CSA International.

	Two person lift required.
CAN ICES/NMB-001(A)	Canada EMC label. Interference-Causing Equipment Standard for industrial, scientific and medical (ISM) equipment. Matériel industriel, scientifique et médical (ISM).
	CE/ICES/ISM label. (Old mark for reference only.) This is a space saver label that combines three markings - CE with CAN ICES and ISM (see above) and ISM (see below).
	This is a space saver label that combines three markings - CE with CAN ICES and ISM (see above) and ISM (see below).
	The RCM mark is a registered trademark of the Australian Communications and Media Authority.
	This is a space saver label that combines two markings - CAN ICES and ISM.
ISM 1-A	This is a symbol of an Industrial Scientific and Medical Group 1 Class A product (CISPR 11, Clause 5).
	South Korean Certification (KC) mark. It includes the marking's identifier code.
	The crossed-out wheeled bin symbol indicates that separate collection for waste electric and electronic equipment (WEEE) is required, as obligated by the EU DIRECTIVE and other National legislation. Please refer to www.keysight.com/go/takeback to understand your trade-in options with Keysight, in addition to product takeback instructions.
	China Restricted Substance Product Label. The EPUP (environmental protection use period) number in the center indicates the time period during which no hazardous or toxic substances or elements are expected to leak or deteriorate during normal use and generally reflects the expected useful life of the product.
	Universal recycling symbol. This symbol indicates compliance with the China standard GB 18455-2001 as required by the China RoHS regulations for paper/fiberboard packaging.
IP x y	This mark indicates product has been designed to meet the requirements of “IP x y”, where “x” is the solid particle protection and “y” is the liquid ingress protection.

Battery Markings

The table below lists the definitions of markings that may be on or with the product. Familiarize yourself with each marking and its meaning before operating the instrument.

NOTE

All labels and symbols may not apply to the instrument.



The CE marking is a registered trademark of the European Community (if accompanied by a year, it is the year when the design was proven). It indicates that the product complies with all relevant directives.



Eurasian Conformity Mark indicating conformance to all technical regulations of the Eurasian Customs Union.



Dispose of properly. Do not throw batteries away—collect as small chemical waste.



Recycle the old battery properly. Consult local or country regulations related to disposal.



Keep battery away from excessive heat. Do not dispose of by burning.



Taiwan recycling symbol.



The RCM Mark is a registered trademark of the Australian Communications and Media Authority.



Korean Certification (KC) mark.



India mark from the Bureau of Indian standards. IS 13252 is the equivalent India standard to IEC 60950-1.

Safety Considerations
Battery Markings



GOST, Russia's safety and EMC mark.



The UL Marks are registered certification marks of Underwriters Laboratories Inc. (UL). It means that UL has tested and evaluated representative samples of that product and determined that it meets UL's safety requirements. When accompanied by a 'C' and 'US', it indicates compliance to both Canadian and US requirements.



Taiwan's safety and EMC compliance mark.



Indicates the time period which no hazardous or toxic substance elements are expected to leak or deteriorate during normal use. Ten years is the expected useful life of the product.

This symbol indicates the Environmental Protection Use Period (EPUP) for the product's toxic substances and for the China RoHS requirements.



The UK conformity mark is a UK government owned mark. Products showing this mark comply with all applicable UK regulations.



The CSA mark is a registered trademark of the CSA international.

CAN ICES/NMB-001(A)

Canada EMC label. Interference-Causing Equipment Standard for industrial, scientific and medical (ISM) equipment. Matériel industriel, scientifique et médical (ISM).



CE/ICES/ISM label. This is a space-saver label that combines three markings – CE with CAN ICES (see above) and ISM (see below).



The RCM mark is a registered trademark of the Australian Communications and Media Authority.



This is a combined marking to indicate product compliance with the Industry Canadian Interference-Causing Equipment Standard (ICES/NMB-001). This is also a symbol of an Industrial Scientific and Medical Group 1 Class A product (CISPR 11, Clause 5).











ISM 1-A

This is a symbol of an Industrial Scientific and Medical Group 1 Class A product (CISPR 11, Clause 5).



South Korean Certification (KC) mark. It includes the marking's identifier code.

Safety Considerations
Battery Markings

	Universal recycling symbol. This symbol indicates compliance with the China standard GB 18455-2001 as required by the China RoHS regulations for paper/fiberboard packaging.
	This symbol marks the standby position of the power line switch.
	This symbol marks the ON position of the power line switch.
	This symbol marks the OFF position of the power line switch.
	This symbol indicates the input power required is AC.
	This symbol indicates DC voltage.
	This symbol indicates a three-phase alternating current.
	This symbol indicates frame or chassis terminal.
	This symbol indicates the presence of a laser device.
	This symbol identifies the Protective Conductor Terminal.
	This symbol indicates the equipment is protected throughout by double or reinforced insulation.

Packaging Markings



Universal recycling symbol. This symbol indicates compliance with the China standard GB 18455-2001 as required by the China RoHS regulations for paper/fiberboard packaging.

AC/DC Adapter Markings

The table below lists the definitions of markings that may be on or with the product. Familiarize yourself with each marking and its meaning before operating the instrument.

NOTE

All labels and symbols may not apply to the instrument.



The UL Marks are registered certification marks of Underwriters Laboratories Inc. (UL). It means that UL has tested and evaluated representative samples of that product and determined that it meets UL's safety requirements. When accompanied by a 'C' and 'US', it indicates compliance to both Canadian and US requirements.



NOM Mark (Normality of Mexico) indicates that the product was tested by an accredited laboratory in Mexico and meets Mexico's safety requirements.



Japan's safety and EMC compliance mark.



China's safety and EMC compliance mark.



Taiwan's safety and EMC compliance mark.



Singapore's safety mark.

Safety Considerations
AC/DC Adapter Markings



Korean Certification (KC) mark. It includes the marking's identifier code.



GOST, Russia's safety and EMC mark.



AC (Alternating Current).



Direct current (DC) equipment



CAUTION, risk of danger, refer to safety information in manual.



DC connector polarity



Ingress Protection Code



Operating instructions should be considered when operating the device.



U.S. Energy efficiency rating



Eurasian Conformity Mark indicating conformance to all technical regulations of the Eurasian Customs Union.



UL component mark. Recognized in Canada and the United States.



Operation for indoors only.

Safety Considerations
AC/DC Adapter Markings



India mark from the Bureau of Indian standards. IS 13252 is the equivalent India standard to IEC 60950-1.



IRAM/S-mark is the safety mark for Argentina.



The crossed out wheeled bin symbol indicates that separate collection for waste electric and electronic equipment (WEEE) is required, as obligated by the EU DIRECTIVE and other National legislation.

Please refer to [keysight.com/go/takeback](https://www.keysight.com/go/takeback) to understand your Trade in options with Keysight in addition to product takeback instructions.



Dispose of properly



The UK conformity mark is a UK government owned mark. Products showing this mark comply with all applicable UK regulations.



The CSA mark is a registered trademark of the CSA international.

CAN ICES/NMB-001(A)

Canada EMC label. Interference-Causing Equipment Standard for industrial, scientific and medical (ISM) equipment. Matériel industriel, scientifique et médical (ISM).



CE/ICES/ISM label. This is a space-saver label that combines three markings – CE with CAN ICES (see above) and ISM (see below).



The RCM mark is a registered trademark of the Australian Communications and Media Authority.



This is a combined marking to indicate product compliance with the Industry Canadian Interference-Causing Equipment Standard (ICES/NMB-001). This is also a symbol of an Industrial Scientific and Medical Group 1 Class A product (CISPR 11, Clause 5).











ISM 1-A

This is a symbol of an Industrial Scientific and Medical Group 1 Class A product (CISPR 11, Clause 5).



South Korean Certification (KC) mark. It includes the marking's identifier code.

Safety Considerations
Certification and Compliance Statements

	Universal recycling symbol. This symbol indicates compliance with the China standard GB 18455-2001 as required by the China RoHS regulations for paper/fiberboard packaging.
	This symbol marks the standby position of the power line switch.
	This symbol marks the ON position of the power line switch.
	This symbol marks the OFF position of the power line switch.
	This symbol indicates the input power required is AC.
	This symbol indicates DC voltage.
	This symbol indicates a three-phase alternating current.
	This symbol indicates frame or chassis terminal.
	This symbol indicates the presence of a laser device.
	This symbol identifies the Protective Conductor Terminal.
	This symbol indicates the equipment is protected throughout by double or reinforced insulation.

Certification and Compliance Statements

Certification

Keysight Technologies, Inc. certifies that this product met its published specifications at the time of shipment from the factory. Keysight Technologies, Inc. further certifies that its calibration measurements are traceable to the United States National Institute of Standards and Technology, to the extent allowed by the Institute's calibration facility, and to the calibration facilities of other International Standards Organization members.

Manufacturer's Declaration

This product has been designed and tested in accordance with accepted industry standards, and has been supplied in a safe condition. The documentation contains information and warnings that must be followed by the user to ensure safe operation and to maintain the product in a safe condition.

Declaration of Conformity

Should the Declaration of Conformity be required, visit:

<http://www.keysight.com/go/conformity>.

For more information, see **"Where to Find the Latest Information" on page 3.**

EMC

Complies with the essential requirements of the European EMC Directive as well as current editions of the following standards (dates and editions are cited in the Declaration of Conformity):

- IEC/EN 61326-1
- CISPR Pub 11 Group 1, class B
- AS/NZS CISPR 11
- ICES/NMB-001

This ISM device complies with the Industry Canada Interference-Causing Equipment Standard (ICES-001);
Cet appareil ISM est conforme a la norme NMB-001 du Canada.

Safety

Complies with the European Low Voltage Directive

- IEC/EN 61010-1
- Canada: CSA C22.2 No. 61010-1
- U.S.A.: UL std no. 61010-1

South Korean Class B EMC Declaration

This equipment is Class B suitable for home electromagnetic environment and is suitable for use in all areas.

B급 기기
(가정용 방송통신기자재)
이 기기는 가정용(B급) 전자파적합기기로서 주
로 가정에서 사용하는 것을 목적으로 하며, 모든
지역에서 사용할 수 있습니다.

Acoustic Statement (European Machinery Directive)

Acoustic Noise Emission

LpA <70 dB

Operator position

Normal operation position per ISO 7779

Safety Considerations
Certification and Compliance Statements

A: Connector Care Review

Proper connector care and connection techniques are critical for accurate and repeatable measurements. The following table contains for tips on connector care.

Prior to making connections to your analyzer, carefully review the information about inspecting, cleaning, and gauging connectors. For course numbers about additional connector care instruction, contact Keysight Technologies.

Handling and Storage

Do

- Keep connections clean
- Extend sleeve or connector nut
- Use plastic end-caps during storage

Do Not

- Touch mating-plane surfaces
- Set connectors contact-end down
- Store connectors or adapters loose

Visual Inspection

Do

- Inspect all connectors carefully
- Look for metal particles, scratches, and dents

Do Not

- Use a damaged connector—ever

Connector Cleaning

Do

- Try compressed air first
- use isopropyl alcohol^a
- Clean connector threads

Do Not

- Use any abrasives
- Get liquid into plastic support beads

Gaging Connectors

Do

- Clean and zero the gage before use
- Use the correct gage type
- Use correct end of calibration block
- Gage all connectors before first use

Do Not

- Use an out-of-specification connector

Gaging Connectors

Do

- connectors carefully
- Make preliminary connection contact lightly
- Turn only the connector nut
- Use a torque wrench for final connection

Do Not

- Apply bending force to connection
- Over Tighten preliminary connection
- Twist or screw any connection
- tighten past torque wrench "break" point

- a. Cleaning connectors with alcohol shall only be done with the DC power cord removed, in a well-ventilated area, and with the power to the FieldFox turned OFF. Allow all residual alcohol moisture to evaporate, and the fumes to dissipate prior to energizing the instrument.

B: Specifications/Data Sheet

To ensure the highest accuracy and consistency, the FieldFox Specifications are now stored ONLY at:

<https://www.keysight.com/us/en/assets/7018-03314/data-sheets/5990-9783.pdf>.

C: Instrument Calibration

Over time, the active components in the FieldFox age and the performance may degrade or drift. To ensure that the FieldFox is performing to the published specifications, you should have an instrument calibration performed periodically.

How Often Should Calibrate My Instrument?

You determine the calibration period which best meets your requirements. However, a 12 month calibration cycle is appropriate for most users.

There are two things to consider: performance drift and connector wear.

The instrument specifications are set to consider the performance drift that may occur over a 12 month period. Therefore, getting the instrument calibrated at 12 month intervals ensures that the analyzer maintains performance within the operating specifications. If you need the analyzer to maintain more consistent operation, you may want to have the instrument calibrated more often.

Connector wear is a bigger factor and depends on the number of connections that are made. The test ports become noticeably worn after 500 to 700 connections. This could represent about 12 months with average use. With more frequent connections, the calibration cycle should be sooner. You can extend the time between calibrations and thereby save money by using connector savers and by performing proper Connector Care. Learn more in **“Connector Care Review” on page 817.**

How do I Get an Instrument Calibration?

To get your Keysight instrument calibrated, send it to one of the Keysight Technologies service centers. Please visit this website to learn how:

www.keysight.com/find/calibration.

What Are My Choices of Instrument Calibration?

The following types of instrument calibration are available from Keysight Technologies service center:

Keysight Calibration	Includes the test data from the calibration and the certificate of calibration, stating the instrument has been calibrated and is operating within the published specifications.
ANSI Z540 Calibration	Includes the test data from the calibration and the certificate of calibration, stating the instrument has been calibrated using a process in compliance with ANSI Z540.1 and is operating within the published specifications
ISO 17025 Calibration	Includes the test data from the calibration and the certificate of calibration, stating the instrument has been calibrated using a process in compliance with ISO 17025 and is operating within the published specifications. Chapter 3, "CAT (Cable and Antenna Test) Mode."

D: Korean Battery Safety Translation

안전 고려 사항
외부 배터리 충전기(N9910X-872)용

배터리 정보

리튬 배터리 팩은 잘못된 조건에서 사용하면 뜨거워지거나 폭발하거나
정화될 수 있으며 심각한 부상을 초래할 수 있습니다.

이 섹션에는 다음과 같은 내용이 포함됩니다.

- "대용량 리튬 배터리(N9910X-876)"
- "표준 용량 배터리(N9910X-870)"

대용량 리튬 배터리(N9910X-876)

리튬 배터리(대용량): N9910X-876(배터리 키사이트 품목 번호: 1420-0937)은
키사이트테크놀로지스가 생산한 휴대용 마이크로파 계측기 제품군에 전원을
공급하는 데 사용됩니다. 다음 안전 경고를 따르십시오.

외부 배터리, 미국
FCC 규정 준수

배터리 보관:

보관과 관련된 유일한 지침은 아래의 온도 기준입니다.

- "온도(1개월): -20°C ~+45°C
- "온도(6개월): -20°C ~+40°C
- "온도(12개월): -20°C ~ +35°C

Rating:

10.8V 6400mAh 70Wh

배터리 안전 고려
사항

경고	<p>리튬-이온 배터리:</p> <ul style="list-style-type: none"> - 고온(>70°C)이나 화기에 노출시키면 안 됩니다. - 어린이의 손이 닿지 않는 곳에 두어야 합니다. - 합선되면 안 됩니다. - 키사이트에서 인증한 리튬-이온 배터리로만 교체해야 합니다. - 부적절하게 교체하거나 충전하면 폭발의 위험이 있습니다.
경고	<p>배터리의 양극 단자와 음극 단자를 금속 물체(예: 와이어)를 사용하여 서로 연결하지 마십시오.</p>
경고	<p>목걸이, 머리핀 또는 기타 금속 물체와 함께 배터리를 보관하거나 가지고 다니지 마십시오.</p>
경고	<p>배터리를 손톱으로 긁거나 망치로 두드리거나 배터리 위에 올라가지 마십시오. 또한 배터리가 강한 충동 또는 충격을 받지 않도록 주의하십시오.</p>
경고	<p>배터리에 직접 납땜기를 사용하지 마십시오.</p>
경고	<p>배터리가 물 또는 소금물에 노출되어서는 안 되며 배터리가 젖지 않도록 주의하십시오.</p>
경고	<p>배터리를 분해 또는 개조하지 마십시오. 배터리에는 손상 시 과열, 폭발 또는 절화가 유발될 수 있는 안전 및 보호 장치가 포함되어 있습니다.</p>
경고	<p>배터리를 직사광선에 노출시켜서는 안 되며 더운 날씨에 배터리를 자동차 안에서 사용하거나 자동차 안에 보관하지 마십시오. 이 점에 주의하지 않으면 배터리가 과열 또는 폭발하거나 절화될 수 있습니다. 또한 배터리 성능이 저하되고 기대 수명이 짧아질 수 있습니다.</p>
경고	<p>배터리를 잘못 교체하면 폭발의 위험이 있습니다. 동일하거나 유사한 유형의 배터리로만 교체할 것을 권장합니다. 다 쓴 배터리는 제조업체의 지침에 따라 폐기하십시오.</p>
경고	<p>실내에서 배터리를 충전할 경우에는 FieldFox 전원이 꺼졌더라도 FieldFox가 뜨거워질 수 있습니다. 적절하게 환기되도록 하십시오. 환기구가 막힌 채로 또는 운반 케이스에 닫힌 상태에서 FieldFox를 작동하면 안 됩니다.</p>

안전 고려 사항
배터리 정보

경고	<p>FieldFox 또는 외부 배터리 충전기(N9910X-872)를 제외한 다른 장치를 사용하여 배터리를 방전시키지 마십시오. 지정된 것 이외의 장치에서 배터리를 사용하면 배터리가 손상되거나 배터리 수명이 줄어들 수 있습니다. 장치가 비정상적인 전류 흐름을 유발할 경우, 배터리가 뜨거워지거나 폭발하거나 절화될 수 있으며 심각한 부상을 초래할 수 있습니다.</p> <p>외부 배터리 충전기는 경고정 도중 방전됩니다.</p>
경고	<p>한국어 배터리 안전 고려 사항 번역본은 부록 D; "한국어 배터리 안전 번역본"을 참조하십시오.</p>
경고	<p>러시아어 배터리 안전 고려 사항 번역본은 부록 E; "러시아어 배터리 안전 번역본"을 참조하십시오.</p>
경고	<p>외부 배터리는 물기가 있는 곳에서 사용할 수 있도록 설계되지 않았습니다. 물기가 있는 곳에서는 외부 배터리를 사용하지 마십시오.</p>

표준 용량 배터리(N9910X-870)

경고	<p>리튬-이온 배터리:</p> <ul style="list-style-type: none"> - 고온(>70°C)이나 화기에 노출시키면 안 됩니다. - 어린이의 손이 닿지 않는 곳에 두어야 합니다. - 합선되면 안 됩니다. - 키사이트에서 인증한 리튬-이온 배터리로만 교체해야 합니다. - 부적절하게 교체하거나 충전하면 폭발의 위험이 있습니다.
경고	<p>배터리의 양극 단자와 음극 단자를 금속 물체(예: 와이어)를 사용하여 서로 연결하지 마십시오.</p>
경고	<p>목걸이, 머리핀 또는 기타 금속 물체와 함께 배터리를 보관하거나 가지고 다니지 마십시오.</p>
경고	<p>배터리를 손톱으로 긁거나 망치로 두드리거나 배터리 위에 올라가지 마십시오. 또한 배터리가 강한 충돌 또는 충격을 받지 않도록 주의하십시오.</p>
경고	<p>배터리에 직접 납땜기를 사용하지 마십시오.</p>
경고	<p>배터리가 물 또는 소금물에 노출되어서는 안 되며 배터리가 젖지 않도록 주의하십시오.</p>

배터리 안전 고려 사항

경고	배터리를 분해 또는 개조하지 마십시오. 배터리에는 손상 시 과열, 폭발 또는 절화가 유발될 수 있는 안전 및 보호 장치가 포함되어 있습니다.
경고	배터리를 직사광선에 노출시켜서는 안 되며 더운 날씨에 배터리를 자동차 안에서 사용하거나 자동차 안에 보관하지 마십시오. 이 절에 주의하지 않으면 배터리가 과열 또는 폭발하거나 절화될 수 있습니다. 또한 배터리 성능이 저하되고 기대 수명이 짧아질 수 있습니다.
경고	배터리를 잘못 교체하면 폭발의 위험이 있습니다. 동일하거나 유사한 유형의 배터리로만 교체할 것을 권장합니다. 다 쓴 배터리는 제조업체의 지침에 따라 폐기하십시오.
경고	실내에서 배터리를 충전할 경우에는 FieldFox 전원이 꺼졌더라도 FieldFox가 뜨거워질 수 있습니다. 적절하게 환기되도록 하십시오.
경고	FieldFox 또는 외부 배터리 충전기(N9910X-872)를 제외한 다른 장치를 사용하여 배터리를 방전시키지 마십시오. 지정된 것 이외의 장치에서 배터리를 사용하면 배터리가 손상되거나 배터리 수명이 줄어들 수 있습니다. 장치가 비정상적인 전류 흐름을 유발할 경우, 배터리가 뜨거워지거나 폭발하거나 절화될 수 있으며 심각한 부상을 초래할 수 있습니다.
경고	한국어 배터리 안전 고려 사항 번역본은 부록 D: “한국어 배터리 안전 번역본”을 참조하십시오.
경고	러시아어 배터리 안전 고려 사항 번역본은 부록 E: “러시아어 배터리 안전 번역본”을 참조하십시오.

안전 고려 사항
배터리 보호 기능

배터리 보호 기능

이 섹션에는 다음과 같은 내용이 포함됩니다.

- “배터리 보호 기능 (N9910X-876)”
- “배터리 보호 기능(N9910X-870)”, 페이지 533.

배터리 보호 기능(N9910X-876)

FieldFox에 사용된 리튬-이온 충전식 배터리 시스템에는 다음과 같은 보호 기능이 내장되어 있습니다.

보호 기능은 능동과 수동의 두 범주로 나눌 수 있습니다. 능동 보호는 적어도 2개의 보호 장치가 함께 동작하는 유형의 보호를 의미하며, 수동 보호는 다른 보호 장치와 별개로 항상 활성화되는 보호 유형을 의미합니다.

능동 보호

기본 과충전 전압: 이 기능은 셀의 전압이 셀당 약 4.35 V를 초과할 경우 배터리의 충전을 방지합니다. 과전압 보호 기능이 작동하면 각 셀의 전압이 약 4.10 V 미만으로 떨어져야 하며, 이때 보호 기능이 리셋되고 충전이 가능해집니다.

과방전 전압: 셀의 전압이 약 2.5 V 미만으로 떨어지면 배터리가 방전되지 않도록 방지합니다. 과방전 전압 보호가 작동하면 각 셀의 전압이 약 3 V로 충전되어야 하며, 이때 보호 기능이 리셋되고 방전이 가능해집니다.

기본 과충전 전류: 이 기능은 평균 충전 전류가 3.3A에 도달하거나 이 값을 초과할 경우 5초 이상 배터리의 충전을 중지시킵니다.

기본 과방전 전류: 이 기능은 배터리의 평균 전류가 7A에 도달하거나 이 값을 초과할 경우 5초 이상 배터리의 방전을 중지시킵니다. 이 보호 기능은 부하를 제거하여 리셋할 수 있습니다.

단락 회로 보호: 이 기능은 배터리 전류가 33.3A에 도달하거나 이 값을 초과할 경우 274.5마이크로초 동안 배터리의 충전 또는 방전을 중지시켜 데이터가 손상되거나 손실되지 않도록 보호합니다. 이 보호 기능은 부하를 제거하여 리셋할 수 있습니다.

과온 충전: 셀 온도가 섭씨 48도를 초과할 경우 시스템 마이크로컨트롤러가 배터리의 충전을 중지시킵니다. 과온 충전 보호 기능이 작동하면 셀 온도가 섭씨 43도 미만으로 떨어져야 하며, 이때 보호 기능이 리셋되고 충전이 가능해집니다.

안전 고려 사항
배터리 보호 기능

과온 방전: 셀 온도가 섭씨 67도를 초과할 경우 시스템 마이크로컨트롤러가 배터리 방전을 중지시킵니다. 과온 방전 보호 기능이 작동하면 배터리가 자동으로 차단되며 계속기 또한 꺼지게 됩니다.

수동 보호

리버스 충전: 리버스 보호 다이오드가 배터리 단자에 적용되는 리버스 충전 극성으로 인한 손상 또는 데이터 손실을 방지합니다.

기본 과온: 이 퓨즈의 최대 작동 온도는 섭씨 85도입니다. 과온 컷아웃은 복구 없이 섭씨 85도에서 영구적으로 열립니다.

보조 과온: 고전류가 되면 각 리튬-이온 셀에 내장된 보조 PTC 폴리퓨즈가 개방되어 전류 흐름이 제한됩니다.

3차 과온: 개별 셀의 내부 압력이 너무 높으면 각 리튬-이온 셀 내의 CID(current interrupt device)가 영구적으로 개방됩니다. 각 셀 퓨즈가 영구적으로 중단되므로 전반적인 배터리 성능이 심각하게 저하되어 배터리를 못쓰게 될 수도 있습니다.

안전 고려 사항
배터리 보호 기능

배터리 보호 기능(N9910X-870)

FieldFox에 사용된 리튬-이온 충전식 배터리 시스템에는 다음과 같은 보호 기능이 내장되어 있습니다.

보호 기능은 능동과 수동의 두 범주로 나뉠 수 있습니다. 능동 보호는 적어도 2개의 보호 장치가 함께 동작하는 유형의 보호를 의미하며, 수동 보호는 다른 보호 장치와 별개로 항상 활성화되는 보호 유형을 의미합니다.

능동 보호

기본 과충전 전압: 이 기능은 셀의 전압이 셀당 약 4.35 V를 초과할 경우 배터리가 충전되지 않도록 방지합니다. 과전압 보호 기능이 작동하면 각 셀의 전압이 약 4.15 V 미만으로 떨어져야 하며, 이때 보호 기능이 리셋되고 충전이 가능해집니다.

보조 과충전 전압: 이 기능은 셀의 전압이 약 4.45 V를 초과할 때 작동하는 1회용 영구 보호 조치입니다. 이 보호 기능이 작동하면 배터리를 더 이상 사용할 수 없으며 교체가 필요합니다.

과방전 전압: 셀의 전압이 약 2.6 V 미만으로 떨어지면 배터리가 방전되지 않도록 방지합니다. 과방전 전압 보호가 작동하면 각 셀의 전압이 약 3 V로 충전되어야 하며, 이때 보호 기능이 리셋되고 방전이 가능해집니다.

기본 과충전 전류: 이 기능은 평균 충전 전류가 3.5A에 도달하거나 이 값을 초과할 경우 120초 이상 배터리의 충전을 중지시킵니다.

보조 과충전 전류: 이 기능은 충전 전류가 4A+/-20%에 도달하거나 이 값을 초과할 경우 20밀리초 이상 배터리의 충전을 중지시킵니다.

기본 과방전 전류: 이 기능은 배터리의 평균 전류가 5 A에 도달하거나 이 값을 초과할 경우 120초 이상 배터리의 방전을 중지시킵니다. 이 보호 기능은 부하를 제거하여 리셋할 수 있습니다.

보조 과충전 전류: 이 기능은 배터리 전류가 6A에 도달하거나 이 값을 초과할 경우 20밀리초 이상 배터리의 방전을 중지시킵니다. 이 보호 기능은 부하를 제거하여 리셋할 수 있습니다.

단락 회로 보호: 이 기능은 배터리 전류가 12.5A에 도달하거나 이 값을 초과하면 183마이크로초 동안 배터리의 충전 또는 방전을 중지시켜 데이터가 손상되거나 손실되지 않도록 보호합니다. 이 보호 기능은 부하를 제거하여 리셋할 수 있습니다.

안전 고려 사항
배터리: 안전한 취급과 폐기

과온 충전: 셀 온도가 섭씨 46도를 초과할 경우 시스템 마이크로컨트롤러가 배터리 충전을 중지시킵니다. 과온 충전 보호 기능이 작동하면 셀 온도가 섭씨 45도 미만으로 떨어져야 하며, 이때 보호 기능이 리셋되고 충전이 가능해집니다.

과온 방전: 셀 온도가 섭씨 65도를 초과할 경우 시스템 마이크로컨트롤러가 배터리 방전을 중지시킵니다. 과온 방전 보호 기능이 작동하면 배터리가 자동으로 차단되며 계측기 또한 꺼지게 됩니다.

수동 보호

리버스 충전: 리버스 보호 다이오드가 배터리 단자에 적용되는 리버스 충전 극성으로 인한 손상 또는 데이터 손실을 방지합니다.

기본 과온: 고전류가 되면 리튬-이온 셀들과 충전 및 방전 트랜지스터 간에 직렬로 연결된 PTC(positive temperature coefficient) 폴리퓨즈가 개방되며 배터리 단자로의 전류 흐름이 제한됩니다. 이 보호 기능은 과도한 스트레스 조건이 사라지면 리셋 가능합니다.

보조 과온: 고전류가 되면 각 리튬-이온 셀에 내장된 보조 PTC 폴리퓨즈가 개방되어 전류 흐름이 제한됩니다.

3차 과온: 개별 셀의 내부 압력이 너무 높으면 각 리튬-이온 셀 내의 CID(current interrupt device)가 영구적으로 개방됩니다. 각 셀 퓨즈가 영구적으로 중단되므로 전반적인 배터리 성능이 심각하게 저하되어 배터리를 뺏쓰게 될 수도 있습니다.

과전류 퓨즈: 정격 전류가 12A인 일회용 파열 퓨즈입니다.

배터리: 안전한 취급과 폐기

안전한 취급 및 폐기 방법은 배터리 제조업체의 안전 데이터 시트(SDS)를 참조하십시오. 배터리 SDS는 <https://regulations.about.keysight.com/msds/default.htm>에서 확인할 수 있습니다.

배터리 운반

배터리에는 일반적으로 운반 규제가 적용됩니다. 운반에 필요한 요건은 배터리 안전 데이터 시트(SDS)를 참조하고 배송 부서에 문의하십시오.

안전 고려 사항
배터리 표시

배터리 표시



CE 마크는 제품이 유럽의 모든 관련 법적 지시문을 준수한다는 것을 보여줍니다(연도가 표시된 경우 설계가 인증된 시기를 의미함).



배터리 부품은 재활용이 가능합니다. 현지 규제를 확인하십시오.



올바른 방법으로 폐기하십시오. 배터리를 함부로 버리면 안 되며 소형 화학 폐기물로 수거해야 합니다.



다 쓴 배터리는 적절히 재활용하십시오. 현지의 폐기 관련 규제를 확인하시기 바랍니다.



배터리가 과도한 열에 노출되지 않도록 하십시오. 태워서 폐기하면 안 됩니다.



캐나다와 미국에서 UL 인증.

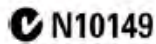

C-Tick Mark는 Australian Spectrum Management Agency의 등록 상표입니다.



RCM Mark는 Australian Communications and Media Authority의 등록 상표입니다.



한국 인증(KC) 마크; 다음 형식을 따르는 마크 식별자 코드를 포함합니다: KCC-REM-YYY-XXXXXXXXXXXX 또는 MSIP-REM-YYY-XXXXXXXXXXXX

안전 고려 사항
배터리 표시



등록을 위한 BIS(Bureau of Indian Standards) 표준 마크.



정상적인 사용 중 위험 물질 성분이나 독성 물질 성분이 누출되거나
악화될 것으로 예상되는 기간을 나타냅니다. 제품의 예상 유효
수명은 10년입니다.

이 기호는 제품의 독성 물질 및 중국 RoHS 요건에 대한 환경 보호
사용 기간(EPUP)을 나타냅니다.

E: Russian Battery Safety Translation

Меры безопасности для внешнего
зарядного устройства батареи (N9910X-872)

Для аккумуляторной батареи

При неправильном использовании литий-ионные аккумуляторные батареи могут нагреться, воспламениться или взорваться, что может привести к серьезным травмам.

Данный раздел включает следующую информацию:

- «Литий-ионная аккумуляторная батарея большой емкости (N9910X-876)»
- «Аккумуляторная батарея стандартной емкости (N9910X-870)»

Литий-ионная аккумуляторная батарея большой емкости (N9910X-876)

Литий-ионная аккумуляторная батарея (большой емкости): N9910X-876 (номер батареи по каталогу Keysight: 1420-0937) используется для питания портативных измерительных приборов СВЧ-диапазона, выпускаемых компанией Keysight Technologies. Обязательно соблюдайте следующие требования техники безопасности:

Внешняя батарея,
соответствующая
требованиям
Федеральной
комиссии
по связи
(FCC) США

Хранение аккумуляторной батареи:

Единственным регламентируемым параметром, связанным с хранением изделия, является температура.

- Среднемесячная температура: от -20°C до $+45^{\circ}\text{C}$
- Средняя температура за полгода: от -20°C до $+40^{\circ}\text{C}$
- Среднегодовая температура: от -20°C до $+35^{\circ}\text{C}$

Rating:

10,8 В; 6400 мА·ч; 70 Вт·ч

Меры безопасности при использовании аккумуляторной батареи

- ОСТОРОЖНО** Литий-ионные аккумуляторные батареи:
- запрещается подвергать воздействию высокой температуры (более +70°C) или открытого огня;
 - следует хранить в недоступном для детей месте;
 - запрещается замыкать накоротко полюса батареи;
 - следует заменять только литий-ионными батареями, рекомендованными компанией Keysight;
 - в случае неправильной замены или зарядки батареи существует опасность взрыва аккумулятора.
-
- ОСТОРОЖНО** Запрещается замыкать положительный и отрицательный контакты батареи какими-либо металлическими предметами (например, проводами).
-
- ОСТОРОЖНО** Запрещается носить или хранить батарею рядом с цепочками, заколками для волос и другими металлическими предметами.
-
- ОСТОРОЖНО** Запрещается пробивать батарею острыми предметами (например, гвоздями), бить по ней молотком, наступать на батарею или подвергать ее каким-либо другим сильным механическим воздействиям.
-
- ОСТОРОЖНО** Запрещается припаивать что-либо непосредственно к батарее.
-
- ОСТОРОЖНО** Запрещается погружать батарею в пресную или соленую воду, а также допускать попадание влаги на батарею.
-
- ОСТОРОЖНО** Запрещается разбирать батарею или изменять ее конструкцию. Батарея оснащена предохранительными устройствами и схемой защиты, повреждение которых может привести к нагреву, воспламенению или взрыву батареи.
-
- ОСТОРОЖНО** Запрещается подвергать батарею воздействию прямых солнечных лучей или хранить ее внутри автомобиля в жаркую погоду. Это может привести к нагреву, воспламенению или взрыву батареи. Использование батареи подобным образом также может повлечь за собой ухудшение ее характеристик и сокращение срока службы.
-
- ОСТОРОЖНО** В случае неправильной замены существует опасность взрыва батареи. Для замены используйте батарею того же типа или совместимую батарею, рекомендованную производителем прибора. Утилизация батареи должна осуществляться в соответствии с инструкциями изготовителя.
-
- ОСТОРОЖНО** При зарядке аккумуляторной батареи внутри анализатора FieldFox, прибор может нагреться, даже если перед этим выключить его питание. Рекомендуется обеспечить надлежащую вентиляцию.
- Запрещается работать с анализатором FieldFox, если он находится в сумке для переноски или его вентиляционные отверстия перекрыты.

Меры безопасности
Для батарей

ОСТОРОЖНО

Запрещается разряжать батарею с помощью любого устройства, кроме анализатора FieldFox или внешнего зарядного устройства N9910X-872. Использование батареи в других устройствах может привести к ее повреждению или сокращению срока ее службы. Протекание через устройство аномально высокого тока может вызвать нагрев, воспламенение или взрыв аккумулятора и стать причиной серьезной травмы.

Внешнее зарядное устройство разряжает батарею во время перекалибровки.

ОСТОРОЖНО

Перевод правил техники безопасности при обращении с батареей на корейский язык приведен в [Приложении D «Правила техники безопасности при обращении с батареей \(перевод на корейский язык\)»](#).

ОСТОРОЖНО

Перевод правил техники безопасности при обращении с батареей на русский язык приведен в [Приложении E «Правила техники безопасности при обращении с батареей \(перевод на русский язык\)»](#).

ОСТОРОЖНО

Внешняя аккумуляторная батарея не предназначена для эксплуатации в местах с повышенной влажностью. Запрещается использовать внешнюю батарею в местах с повышенной влажностью.

Аккумуляторная батарея стандартной емкости (N9910X-870)

ОСТОРОЖНО

- Литий-ионные аккумуляторные батареи:
- запрещается подвергать воздействию высокой температуры (более +70°C) или открытого огня;
 - следует хранить в недоступном для детей месте;
 - запрещается замыкать накоротко полюса батареи;
 - следует заменять только литий-ионными батареями, рекомендованными компанией Keysight;
 - в случае неправильной замены или зарядки батареи существует опасность взрыва аккумулятора.

ОСТОРОЖНО

Запрещается замыкать положительный и отрицательный контакты батареи какими-либо металлическими предметами (например, проводами).

ОСТОРОЖНО

Запрещается носить или хранить батарею рядом с цепочками, заколками для волос и другими металлическими предметами.

ОСТОРОЖНО

Запрещается пробивать батарею острыми предметами (например, гвоздями), бить по ней молотком, наступать на батарею или подвергать ее каким-либо другим сильным механическим воздействиям.

ОСТОРОЖНО

Запрещается припаивать что-либо непосредственно к батарее.

ОСТОРОЖНО

Запрещается погружать батарею в пресную или соленую воду, а также допускать попадание влаги на батарею.

Меры безопасности при использовании аккумуляторной батареи

- | | |
|------------------|--|
| ОСТОРОЖНО | Запрещается разбирать батарею или изменять ее конструкцию. Батарея оснащена предохранительными устройствами и схемой защиты, повреждение которых может привести к нагреву, воспламенению или взрыву батареи. |
| ОСТОРОЖНО | Запрещается подвергать батарею воздействию прямых солнечных лучей или хранить ее внутри автомобиля в жаркую погоду. Это может привести к нагреву, воспламенению или взрыву батареи. Использование батареи подобным образом также может повлечь за собой ухудшение ее характеристик и сокращение срока службы. |
| ОСТОРОЖНО | В случае неправильной замены существует опасность взрыва батареи. Для замены используйте батарею того же типа или совместимую батарею, рекомендованную производителем прибора. Утилизация батареи должна осуществляться в соответствии с инструкциями изготовителя. |
| ОСТОРОЖНО | При зарядке аккумуляторной батареи внутри анализатора FieldFox, прибор может нагреться, даже если перед этим выключить его питание. Рекомендуется обеспечить надлежащую вентиляцию. |
| ОСТОРОЖНО | Запрещается разряжать батарею с помощью любого устройства, кроме анализатора FieldFox или внешнего зарядного устройства N9910X-872. Использование батареи в других устройствах может привести к ее повреждению или сокращению срока ее службы. Протекание через устройство аномально высокого тока может вызвать нагрев, воспламенение или взрыв аккумулятора и стать причиной серьезной травмы. |
| ОСТОРОЖНО | Перевод правил техники безопасности при обращении с батареями на корейский язык приведен в Приложении D «Правила техники безопасности при обращении с батареей (перевод на корейский язык)» . |
| ОСТОРОЖНО | Перевод правил техники безопасности при обращении с батареями на русский язык приведен в Приложении E «Правила техники безопасности при обращении с батареей (перевод на русский язык)» . |

Меры безопасности
Защитные функции аккумуляторной батареи

Защитные функции аккумуляторной батареи

Данный раздел включает следующую информацию:

- «Защитные функции аккумуляторной батареи (N9910X-876)»
- «Защитные функции аккумуляторной батареи (N9910X-870)» на стр. 533

Защитные функции батареи (N9910X-876)

Литий-ионная аккумуляторная батарея анализатора FieldFox оснащена следующими встроенными защитными функциями.

Защитные функции могут быть разделены на два вида: активные и пассивные. Функции активной защиты зависят от двух или более защитных устройств, работающих вместе для обеспечения защиты. Функции пассивной защиты всегда работают независимо от любых других защитных устройств.

Функции активной защиты

Первичная защита от чрезмерного заряда по напряжению. Прекращает дальнейший заряд батареи, если напряжение на любом из элементов аккумуляторной батареи превышает приблизительно 4,25 В. После срабатывания защиты от чрезмерного заряда напряжение на каждом элементе аккумулятора должно снизиться примерно до 4,10 В, чтобы схема защиты вернулась в исходное состояние и вновь разрешила заряд аккумулятора.

Защита от чрезмерного разряда по напряжению. Прекращает дальнейший разряд батареи, если напряжение на любом из элементов аккумуляторной батареи падает ниже примерно 2,5 В. После срабатывания защиты от чрезмерного разряда напряжение на каждом элементе аккумулятора должно увеличиться примерно до 3 В, чтобы схема защиты вернулась в исходное состояние и вновь разрешила разряд аккумулятора.

Первичная защита от чрезмерного заряда по току. Прекращает дальнейший заряд батареи, если среднее значение тока заряда достигает или превышает 3,3 А в течение 5 с или более.

Первичная защита от чрезмерного тока разряда. Прекращает дальнейший разряд батареи, если среднее значение тока разряда достигает или превышает 7 А в течение 5 с или более. Схема защиты может быть возвращена в исходное состояние путем отключения нагрузки.

Защита от короткого замыкания. Прекращает дальнейший заряд или разряд батареи и не допускает повреждения оборудования и потери данных, если ток батареи (входной или выходной) достигает или превышает 33,3 А в течение 274,5 мкс или более. Схема защиты может быть возвращена в исходное состояние путем отключения нагрузки.

Защита от перегрева при заряде. Системный микроконтроллер останавливает заряд батареи, если температура элементов аккумулятора превышает +48°C. После срабатывания защиты от перегрева температура элементов аккумулятора должна снизиться до +43°C и ниже, чтобы схема защиты вернулась в исходное состояние и вновь разрешила заряд аккумулятора.

Меры безопасности

Защитные функции аккумуляторной батареи

Защита от перегрева при разряде. Системный микроконтроллер останавливает разряд батареи, если температура элементов аккумулятора превышает +67°C. После срабатывания защиты от перегрева батарея автоматически отключается, что, в свою очередь, приводит к выключению прибора.

Функции пассивной защиты

Защита от включения с обратной полярностью при заряде. Защитный диод предотвращает повреждение прибора и потерю данных при подаче на клеммы аккумуляторной батареи напряжения заряда с обратной полярностью.

Первичная защита от перегрева. Максимальная рабочая температура этого предохранителя составляет +85°C. При температуре свыше +85°C происходит необратимое срабатывание предохранителя.

Вторичная защита от перегрева. Второй самовосстанавливающийся предохранитель с положительным температурным коэффициентом, встроенный в каждый элемент литий-ионной аккумуляторной батареи, разрывает цепь и ограничивает протекание тока при очень высоких значениях температуры.

Третичная защита от перегрева. Устройство прерывания тока (CID) в каждом элементе литий-ионной аккумуляторной батареи необратимо разрывает цепь при чрезмерно высоком давлении внутри элемента. Поскольку при срабатывании защиты предохранитель в каждом элементе аккумулятора разомкнут необратимо, характеристики батареи значительно ухудшаются, вплоть до полной потери работоспособности аккумулятора.

Меры безопасности
Защитные функции аккумуляторной батареи

Защитные функции аккумуляторной батареи (N9910X-870)

Литий-ионная аккумуляторная батарея анализатора FieldFox оснащена следующими встроенными защитными функциями.

Защитные функции могут быть разделены на два вида: активные и пассивные. Функции активной защиты зависят от двух или более защитных устройств, работающих вместе для обеспечения защиты. Функции пассивной защиты всегда работают независимо от любых других защитных устройств.

Функции активной защиты

Первичная защита от чрезмерного заряда по напряжению. Прекращает дальнейший заряд батареи, если напряжение на любом из элементов аккумуляторной батареи превышает приблизительно 4,35 В. После срабатывания защиты от чрезмерного заряда напряжение на каждом элементе аккумулятора должно снизиться примерно до 4,15 В, чтобы схема защиты вернулась в исходное состояние и вновь разрешила заряд аккумулятора.

Вторичная защита от чрезмерного заряда по напряжению. Эта функция защиты срабатывает однократно, когда напряжение на любом из элементов аккумуляторной батареи превысит примерно 4,45 В. После срабатывания этой функции защиты пользоваться батареей запрещается и ее следует заменить.

Защита от чрезмерного разряда по напряжению. Предотвращает дальнейший разряд батареи, если напряжение на любом из элементов аккумуляторной батареи падает ниже примерно 2,6 В. После срабатывания защиты от чрезмерного разряда напряжение на каждом элементе аккумулятора должно увеличиться примерно до 3 В, чтобы схема защиты вернулась в исходное состояние и вновь разрешила разряд аккумулятора.

Первичная защита от чрезмерного заряда по току. Прекращает дальнейший заряд батареи, если среднее значение тока заряда достигает или превышает 3,5 А в течение 120 с или более.

Вторичная защита от чрезмерного заряда по току. Прекращает дальнейший заряд батареи, если значение тока заряда достигает или превышает $4 \text{ A} \pm 20\%$ в течение 20 мс или более.

Первичная защита от чрезмерного тока разряда. Прекращает дальнейший разряд батареи, если среднее значение тока разряда достигает или превышает 5 А в течение 120 с или более. Схема защиты может быть возвращена в исходное состояние путем отключения нагрузки.

Вторичная защита от чрезмерного тока разряда. Прекращает дальнейший разряд батареи, если значение тока разряда достигает или превышает 6 А в течение 20 мс или более. Схема защиты может быть возвращена в исходное состояние путем отключения нагрузки.

Защита от короткого замыкания. Прекращает дальнейший заряд или разряд батареи и не допускает повреждения оборудования и потери данных, если ток батареи (входной или выходной) достигает или превышает 12,5 А в течение 183 мкс или более. Схема защиты может быть возвращена в исходное состояние путем отключения нагрузки.

Меры безопасности

Правила безопасного обращения с аккумуляторными батареями и их утилизации

Защита от перегрева при заряде. Системный микроконтроллер останавливает заряд батареи, если температура элементов аккумулятора превышает +46°C. После срабатывания защиты от перегрева температура элементов аккумулятора должна снизиться до +45°C и ниже, чтобы схема защиты вернулась в исходное состояние и вновь разрешила заряд аккумулятора.

Защита от перегрева при разряде. Системный микроконтроллер останавливает разряд батареи, если температура элементов аккумулятора превышает +65°C. После срабатывания защиты от перегрева батарея автоматически отключается, что, в свою очередь, приводит к выключению прибора.

Функции пассивной защиты

Защита от включения с обратной полярностью при заряде. Защитный диод предотвращает повреждение прибора и потерю данных при подаче на клеммы аккумуляторной батареи напряжения заряда с обратной полярностью.

Первичная защита от перегрева. Самовосстанавливающийся предохранитель с положительным температурным коэффициентом, включенный последовательно между элементами литий-ионной аккумуляторной батареи и транзисторами цепей заряда и разряда, разрывает цепь и ограничивает протекание тока к полюсам батареи при очень высоких значениях температуры. Схема защиты может быть возвращена в исходное состояние только при устранении условий, вызвавших ее срабатывание.

Вторичная защита от перегрева. Второй самовосстанавливающийся предохранитель с положительным температурным коэффициентом, встроенный в каждый элемент литий-ионной аккумуляторной батареи, разрывает цепь и ограничивает протекание тока при очень высоких значениях температуры.

Третичная защита от перегрева. Устройство прерывания тока (CID) в каждом элементе литий-ионной аккумуляторной батареи навсегда необратимо без возможности восстановления разрывает цепь, когда температура достигает +95°C. Поскольку при срабатывании защиты предохранитель в каждом элементе аккумулятора разомкнут необратимо, характеристики батареи значительно ухудшаются, вплоть до полной потери работоспособности аккумулятора.

Предохранитель для защиты от перегрузки по току. Одноразовый плавкий предохранитель с номинальным током 12 А.

Правила безопасного обращения с аккумуляторными батареями и их утилизации

Информация о безопасном обращении с аккумуляторными батареями и их утилизации приведена в паспорте безопасности производителя батареи (SDS). С паспортами безопасности аккумуляторных батарей можно ознакомиться по адресу: <https://regulations.about.keysight.com/msds/default.htm>

Транспортировка аккумуляторных батарей

На аккумуляторные батареи обычно распространяются особые правила транспортировки, указанные в паспорте безопасности (SDS). Кроме того, получить информацию о требованиях к транспортировке аккумуляторных батарей можно в транспортном отделе.

Меры безопасности
Маркировка аккумуляторных батарей

Маркировка аккумуляторных батарей



Знак CE указывает на то, что изделие отвечает требованиям всех применимых директив ЕС (если рядом со знаком приведен год, то это означает год, в который изделие прошло соответствующие испытания).



Детали аккумуляторных батарей могут подлежать вторичной переработке. Ознакомьтесь с региональным и национальным законодательством по этому вопросу.



Утилизируйте их надлежащим образом. Выбрасывать аккумуляторные батареи запрещается. Они подлежат сбору как незначительные химические отходы.



Утилизируйте отслужившие аккумуляторные батареи надлежащим образом. Ознакомьтесь с региональным и национальным законодательством по этому вопросу.



Храните аккумуляторные батареи вдали от источников чрезмерного нагрева. Запрещается утилизировать отслужившие аккумуляторные батареи путем сжигания.



Сертификаты UL действительны в США и Канаде.

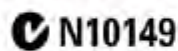

Знак C-Tick является зарегистрированной торговой маркой Australian Spectrum Management Agency.



Знак RCM является зарегистрированной торговой маркой Australian Communications and Media Authority.



Знак корейской сертификации KC включает в себя идентификационный код следующего формата:
KCC-REM-YYY-XXXXXXXXXXXX или
MSIP-REM-YYY-XXXXXXXXXXXX

Меры безопасности
Маркировка аккумуляторных батарей



Стандартный регистрационный знак Индийского бюро стандартов (Bureau of Indian Standards, BIS).



В этом символе указывается период времени, в течение которого при условии нормальной эксплуатации прибор не станет источником опасных или токсических веществ. Ожидаемый срок службы изделия составляет 10 лет.

Этот символ обозначает срок экологически безопасного использования (EUPP) содержащего токсичные вещества изделия в соответствии с требованиями нормативных документов КНР по ограничению использования опасных веществ (RoHS).

F: Keysight Software End-User Licensing Agreement (EULA)

KEYSIGHT SOFTWARE END-USER LICENSE AGREEMENT

ATTENTION: THIS SOFTWARE IS SUBJECT TO THE END-USER LICENSE AGREEMENT (“EULA”) SET FORTH BELOW. TO INSTALL OR USE THE SOFTWARE, YOU MUST FIRST AGREE TO THE EULA BELOW. IF THE EULA IS PRESENTED TO YOU ELECTRONICALLY AND IF YOU HAVE READ, UNDERSTAND AND AGREE TO BE BOUND BY THE TERMS OF THE EULA, CLICK “AGREE”. IF THE EULA IS PRESENTED TO YOU IN A HARD COPY FORMAT, BY POWERING ON AND USING THE INSTRUMENT OR MACHINE, YOU AGREE THAT YOU HAVE READ, UNDERSTAND AND AGREE TO BE BOUND BY THE TERMS OF THE EULA.

1. Translations. Translations of this EULA are found at: www.keysight.com/find/sweula.

2. Software. “Software” means a single copy of one or more computer programs, whether stand-alone or bundled with other products, and related documentation, including any online or electronic documentation, data and license files.

3. License Grant. Keysight Technologies, Inc. (“Keysight”) grants you a limited, non-exclusive license to use, in accordance with one of the license types listed below, the Software, for the Term (as defined below), subject to the terms and conditions herein:

3.1 Node Locked (“fixed”) license. If you have obtained a Node Locked license, you may install one copy of the Software on one instrument or machine and use the Software only on that instrument or machine for your internal business use.

3.2 Transportable license. If you have obtained a Transportable license, you may use one copy of the Software on any single instrument or machine at one time for your internal business use. You may move such Software to a different instrument or machine for your internal business use provided only one copy is in use at any one time.

3.3 Floating (“concurrent use”) license. If you have obtained a Floating license, you may install one or more copies of the Software on any instrument or machine within your internal computer network for your internal business use provided the total number of users who are accessing and/or using any of the Software at the same time does not exceed the maximum number of licensed users.

You may find the type of license you obtained, the Term of your license, and the licensed number of users (if applicable) in documentation associated with the Software. “Term” means either a set amount of time (an expiring license) or a Perpetual license. “Perpetual” means the lifetime of the instrument or machine. In the absence of documentation specifying the applicable license, you have a fixed license with a Perpetual Term.

4. License Restrictions.

4.1 No Copies. You may not make copies or adaptations of the Software except for backup and archival purposes or when copying or adaptation is an essential step in the licensed use of the Software including correction of errors. You must reproduce all copyright and other legal notices in the original Software on all permitted copies or adaptations. You may not copy the Software onto any public or distributed network.

4.2 No Reverse Engineering. You may not decompile, reverse engineer, disassemble, attempt to derive the source code of, decrypt, modify, or create derivative works of the Software (except to the extent any foregoing restriction is prohibited by applicable mandatory law or by licensing terms governing the use of open source components that may be included with the Software).

4.3 No Circumvention. The Software may include technological measures, whether in the Software or in bundled hardware or both, that are designed to prevent or detect unlicensed use of the Software. Circumvention of these technological measures is prohibited, except as expressly permitted by applicable law. Any attempt to circumvent technological measures may render the Software or certain features unusable or unstable, and may prevent you from updating or upgrading the Software.

4.4 Limited Use. Notwithstanding anything to the contrary herein, you may not use Software to make or distribute your own or a third party’s application, a principal purpose of which, as reasonably determined by Keysight, is to perform the same or similar functions as the Software or which replaces any component of the Software.

5. Third Party Software.

5.1 General. The Software may contain third party software subject to third party notices and/or additional terms and conditions. Such required third party software notices and/or additional terms and conditions can be found in the documentation associated with the Software. You have all rights necessary to use the Software as permitted in Sections 3 and 4. To the extent your use exceeds the grants and restrictions in Sections 3 and 4, third party license terms take precedence and will apply.

5.2 Separation of Components. Except as required by included open source software licenses, the Software is licensed as a single product and its component parts may not be separated for any other use except to the extent expressly otherwise licensed.

5.3 Additional Terms for Microsoft Windows Embedded Software. Microsoft Windows for Embedded Systems may be included with the instrument or machine. If so, your grant under this license prohibits accessing or using any Desktop Functions other than through, in support of and operating as part of the software and/or functions that provide the primary functionality of the instrument or machine.

“Desktop Functions” means consumer or business tasks or processes, including word processing, spreadsheets, database, scheduling and personal finance.

6. Upgrades. This EULA does not entitle you to receive upgrades, updates or technical support. Upgrades, updates and technical support services may be purchased separately. The terms of this EULA govern any software updates or upgrades provided by Keysight unless replaced and/or supplement Software is accompanied by a separate license agreement in which case the terms of that license agreement will govern. Any comments, suggestions, improvements or other communications from you to Keysight regarding the Software (“Feedback”) may be used by Keysight without compensation or attribution.

7. Ownership. The Software and all copies thereof are licensed and not sold to you. The Software and all copies thereof are owned and copyrighted by Keysight or its third party suppliers and protected by copyright laws and other intellectual property laws and treaties. Keysight and its third party suppliers retain all right, title and interest in the Software. Keysight and its third party suppliers may protect their respective rights in the Software in the event of any violation of this EULA.

8. High Risk Activities. The Software is not specifically written, designed, manufactured or intended for use in the planning, construction, maintenance or direct operation of a nuclear facility, nor for use in on line control or fail safe operation of aircraft navigation, control or communication systems, weapon systems or direct life support systems.

This information is subject to change without notice. © Keysight Technologies, 2013 – 2015 Published in USA, February 1, 2017 www.keysight.com

Keysight Software End-User Licensing Agreement (EULA)

5991-3402 (supersedes 5991-3402-14Dec2015)

9. Transfer. You may not sell or otherwise transfer the Software except as expressly specified below. Licensed users are Licensee's employees, authorized agents, representatives, and subcontractors acting on behalf of Licensee for Licensee's internal business use. You may not rent, lease, lend, allow for commercial time sharing, or otherwise permit access to the Software to any unlicensed third party or entity. You may not transfer the license granted to you here unless you obtain Keysight's prior written authorization, deliver all copies of the Software to the transferee along with this EULA, and pay any applicable fees. For all transfers, the transferee must accept this EULA as a condition to any transfer and your license to use the Software will terminate upon transfer. Entitlement to receive technical support services for the Software may be transferred provided that you obtain Keysight's prior written consent and pay any applicable fees. This section regarding transfer applies only to the extent permissible under applicable mandatory laws.

10. Term and Termination. This EULA shall continue for the Term unless terminated by Keysight as provided herein. Keysight may terminate this license upon notice for breach of this EULA. Upon expiration or termination, you must immediately destroy all copies of the Software.

11. Export Requirements. If you export, re-export or import Software, technology or technical data licensed hereunder, you assume responsibility for complying with applicable laws and regulations and for obtaining required export and import authorizations. Keysight may terminate this license immediately if you are in violation of any applicable laws or regulations.

12. Audit and Security Mechanisms. You agree that Keysight may restrict the number of copies you are using by security servers, security keys/modules, a hardware lock device, license administration software, a license authorization key to control access to the Software or other security mechanism and you consent to such use. You may not take any steps to avoid or defeat the purpose of any such measures. Use of the Software without the lock device or authorization key provided by Keysight is prohibited. Keysight may take all legal steps to eliminate unlicensed use and piracy of their Software. In this context, the Software may include a security mechanism to detect installation or use of unlicensed copies of the Software, and collect and transmit data about suspected unlicensed copies. Data collected does not include any customer data created with the Software. By using the Software, you consent to such detection and collection of data, as well as its transmission and use if suspected unlicensed copies are detected. Upon reasonable notice and reasonable suspicion of unlicensed use, Keysight may conduct during normal business hours (with the auditor's costs being at Keysight's expense) an audit of your compliance with this EULA. If an audit reveals underpayments then you will pay to Keysight such underpayments. If underpayments discovered exceed five (5) percent of the contract price, you will reimburse Keysight for the auditor costs.

13. U.S. Government Rights. The Software is "commercial computer software," as defined by Federal Acquisition Regulation ("FAR") 2.101. Pursuant to FAR 12.212 and 27.405-3 and Department of Defense FAR Supplement ("DFARS") 227.7202, the U.S. government acquires commercial computer software under the same terms by which the software is customarily provided to the public. Accordingly, Keysight provides the Software to U.S. government customers under its standard commercial license, which is embodied in this EULA. The license set forth in this EULA represents the exclusive authority by which the U.S. government may use, modify, distribute, or disclose the Software. This EULA and the license set forth herein, does not require or permit, among other things, that Keysight: (1) Furnish technical information related to commercial computer software or commercial computer software documentation that is not customarily provided to the public; or (2) Relinquish to, or otherwise provide, the government rights in excess of these rights customarily provided to the public to use, modify, reproduce, release, perform, display, or disclose commercial computer software or commercial computer software documentation. If you are a U.S. government customer, you acknowledge that you have reviewed the Software and the terms of this EULA and agree that the license provided for herein is consistent with Federal law and otherwise satisfies the U.S. government needs. In addition, if you are a U.S. government customer you agree that this EULA reflects the entirety of the terms of Keysight's customary commercial license applicable to U.S. government customers. No additional government requirements beyond those set forth in this EULA shall apply, except to the extent that those terms, rights, or licenses are explicitly required from all providers of commercial computer software pursuant to the FAR and the DFARS and are set forth specifically in writing elsewhere in this EULA. Keysight shall be under no obligation to update, revise or otherwise modify the Software.

14. WARRANTY. TO THE EXTENT ALLOWED BY APPLICABLE MANDATORY LAW, AND EXCEPT TO THE EXTENT KEYSIGHT HAS PROVIDED A SPECIFIC WRITTEN WARRANTY APPLICABLE TO THIS SOFTWARE, THIS SOFTWARE IS PROVIDED TO YOU "AS IS" WITHOUT WARRANTIES OR CONDITIONS OF ANY KIND, WHETHER ORAL OR WRITTEN, EXPRESS OR IMPLIED. KEYSIGHT, ON BEHALF OF ITSELF ITS SUBSIDIARIES, AFFILIATES AND SUPPLIERS SPECIFICALLY DISCLAIMS ANY IMPLIED WARRANTIES OR CONDITIONS OF MERCHANTABILITY, SATISFACTORY QUALITY, NON-INFRINGEMENT AND FITNESS FOR A PARTICULAR PURPOSE. SHOULD THE SOFTWARE PROVE DEFECTIVE, YOU ASSUME THE ENTIRE RISK AND COST RESULTING FROM OR RELATING TO THE DEFECT. SOME JURISDICTIONS DO NOT ALLOW EXCLUSIONS OF IMPLIED WARRANTIES OR CONDITIONS, SO THE ABOVE EXCLUSION MAY NOT APPLY TO YOU. YOU MAY HAVE OTHER RIGHTS THAT VARY ACCORDING TO APPLICABLE MANDATORY LAW.

15. LIMITATION OF LIABILITY. TO THE EXTENT ALLOWED BY APPLICABLE MANDATORY LAW, IN NO EVENT WILL KEYSIGHT OR ITS SUBSIDIARIES, AFFILIATES OR SUPPLIERS BE LIABLE FOR ANY SPECIAL, INCIDENTAL, CONSEQUENTIAL OR OTHER DAMAGES (INCLUDING DOWNTIME COSTS, LOSS OF DATA, RESTORATION COSTS OR LOST PROFITS) REGARDLESS OF WHETHER SUCH CLAIMS ARE BASED ON CONTRACT, TORT, WARRANTY OR ANY OTHER LEGAL THEORY, EVEN IF ADVISED OF THE POSSIBILITY OF SUCH DAMAGES. YOUR USE OF THE SOFTWARE IS ENTIRELY AT YOUR OWN RISK. NOTWITHSTANDING THE FOREGOING, IN THE EVENT THE SOFTWARE IS PROVIDED TO YOU AT NO CHARGE, KEYSIGHT OR ITS SUBSIDIARIES, AFFILIATES OR SUPPLIERS SHALL HAVE NO LIABILITY FOR DIRECT DAMAGES. SOME JURISDICTIONS DO NOT ALLOW THE EXCLUSION OR LIMITATION OF LIABILITY FOR DAMAGES, SO THE ABOVE LIMITATION MAY NOT APPLY TO YOU.

16. Applicable Law. Disputes arising in connection with this EULA will be governed by the laws of the United States and of the State of California, without regard to choice of law provisions. The United Nations Convention for Contracts for the International Sale of Goods will not apply to this EULA.

17. Unenforceability. To the extent that any provision of this EULA is determined to be illegal or unenforceable, the remainder of this EULA will remain in full force and effect.

18. Entire Agreement. Certain program, data and license files in the Software may be subject to supplemental license terms found in the documentation associated with the Software or directly in the files to which the supplemental terms apply. This EULA constitutes the entire

Keysight Software End-User Licensing Agreement (EULA)

agreements between the parties, whether oral or written, except if you have a separate written, valid agreement that is executed by both parties and the terms of such agreement conflict with the terms contained herein, in which case the terms of such agreement apply. This EULA may not be changed except by an amendment signed by an authorized representative of each party.

This information is subject to change without notice. © Keysight Technologies, 2013 – 2015 Published in USA, February 1, 2017 www.keysight.com
5991-3402 (supersedes 5991-3402-14Dec2015)

This information is subject to change without notice. © Keysight Technologies, 2013 – 2015 Published in USA, February 1, 2017 www.keysight.com

Index

Symbols

, 810

Numerics

1-port cable loss measurements
CAT mode, 66
1-port cable loss, CAT mode, 67
1-Port Cable Trimming VVM Measurements, 583
1-Port Cable Trimming, VVM measurements, 575
2-port insertion loss measurements, 583
CAT mode, 68
2-port insertion loss measurements, CAT mode, 68
2-port transmission measurements
VVM mode, 585
2-port transmission measurements, VVM mode, 585
89600 VSA software, 497

A

ABC keyboard, 742
AC/DC adapter, 791
, 810
power requirements, 37
using, 785
accessories, 34
Adjacent Channel Power (ACPR), 230
Alias Faults, 81, 94
align all now,alignments, 213
alignments,align all now, 213
alignments,individual, 211
alignments,overview, 211
all about markers, 692
AM FM Tune & Listen, 177

AM/FM Metrics, error messages, 609
AM/FM Metrics, Option 355, 599
AM/FM Metrics,error messages, 609
Amplitude Alignment, 216
InstAlign, 280
EMI, 337
IQA, 317, 669
RF Burst, 216
Analyzer
IQ, 293
Antenna Corrections, 172, 174, 632, 638
Antenna, Option 360, 395
appendix B, 817, 819
attenuation, 170, 266, 310, 329
Audio Beep, 223
Average Type, 209, 279, 337
Averaging
VVM, 580
averaging, 60, 110, 715
VVM, 580
avoid overpowering, 44

B

Band Power Marker IQA, 313
Band Power Marker SA mode, 221, 313, 314, 316, 706
Band Span Marker IQA, 314
bandpass mode, 75, 76
battery
care, 788
charge status, viewing, 783
charge status,viewing, 718, 783
charging, 39
external, 787
internal, 785
disposal, 789
gauge, 784
icons, 783
installing, 38

LED, 787
markings, 807
maximizing life, 788
protective functions, 800, 802
safe handling, 803
saver, 736
service diagnostics, 784
viewing charge status, 38
Big Marker IStates, 118
big marker states, 118
bridge cancellation measurements, VVM mode, 585
brightness display, 721
Built-in Power Meter, 527

C

Cable (Correction) Specifications
DTF, 77, 89
cable and antenna test See CAT
cable loss measurements, 66, 67
cable specifications, DTF, 78
Cal On ?, 153
Calculated DTF values, 81, 93
calibration
Cal On ?, 153
CAT and NA modes, 133
noise figure, 679
type, 147
verifying integrity, 155
Calibration Type, 147
Calibration Wizard
Wizard,calibration, 679
CalReady, 135
properties, 154
CalReady Properties, 154
Capture Data IQA, 298
care of the battery, 788
CAT mode
1-port cable loss measurements, 66

2-port insertion loss
 measurements, 68
 calibration, 133
 DTF settings, 74, 86, 99, 123, 297, 354
 return loss measurements, 66
 settings, 57, 523, 524
 CAT mode measurements, 521
 certification statements, 813
 Channel Power (CHP), 226
 channel scanner, option
 312, 613
 Channel Selection, 166
 charge status, viewing, 718, 783
 charging the battery
 externally, 787
 internally, 785
 cleaning the screen, 47
 colors, display, 721
 compliance statements, 813
 compressed measurement, 171, 267
 Compressed SA
 Measurements, 171, 267
 connector care review, 817
 considerations, safety, 791
 Contacting Keysight, 5
 Continuous Peak Search
 Marker IQA, 316
 control, temperature, 41
 Couple Markers IQA, 314
 Coupled Frequency, 64, 76
 Coupled Markers, 695
 cursor moving, 779
 cursor, moving, 771, 779, 781

D

data analysis features, 691, 767
 data indicator (*), old, 224
 data indicator, old (*), 224
 Data Logging, 387
 Date and Time Setting, 757
 Date and Time setting, 739
 date/time setting, 739, 756
 declaration of conformity, 814
 delta marker, 693, 694
 delta markers, 693
 Detection Method, 218, 278, 338
 detection method, 218, 278, 338
 display
 brightness, 721

colors, 721
 front panel, 51
 preferences, 735
 settings, 721
 display "live" and memory
 traces, 574
 Display Resolution
 VVM, 578
 disposal of battery, 789
 dissipate static charge, 44
 DTF
 measurements, 71, 72
 settings, 74, 86, 99, 123, 297, 354
 start and stop distance, 72
 DTF Measurement, 74, 86
 DTF settings, 74
 DTF Start and Stop
 Distance, 75, 87
 Dynamic Range, 120
 dynamic range, 120

E

ECal, 142
 Edit a Cable File, 78
 DTF, 78, 90
 edit keywords, 779
 edit, enable and disable the
 current prefix, 779, 781
 edit, enable and disable the
 current suffix, 779, 780
 Electrical Delay, 109
 Electromagnetic
 Interference, 321
 EMF
 measurements, how to
 make, 383
 set up, 380
 settings, 236, 380, 724
 EMF Settings, 236, 380
 EMI
 measurements, about, 340
 EMI Glossary, 344
 EMI mode
 settings, 343
 units, 328
 EMI Mode Units, 328
 Enhanced Response
 Optimization, 152
 Erase User Data, 764
 error
 meas UNCAL, 195, 196, 224

red flashing LED, external
 battery charger, 787
 red red flashing LED, external
 battery
 charger, 787
 systematic, 134
 error messages, AM/FM
 Metrics, 609
 ERTA, 589
 ESD, 804
 Event Log, 763
 external frequency
 reference, 754
 External Gain, 169, 265, 328
 External triggering, 113, 202, 272
 external triggering, 202, 272
 external zeroing, 537

F

features, overview, 33
 FFT Gating, 206
 Field Strength
 Measurements, 172, 632
 File Management, 767
 file management, 767
 file, license, 748
 files
 managing, 776
 prefixes, 779, 781
 suffixes, 779
 FM Tune & Listen, 177
 FM tune and listen, 50
 folders, 778
 Format
 NA Mode, 106
 format, NA mode, 106
 FoxTrot, 589
 FreqMaskTrigger, 516
 frequency
 context, setting, 665
 external reference, 754
 mode, DTF, 75
 range, NA mode, 107
 range, setting, 59, 665
 range, step size, 164
 step size, 164
 Frequency Counter at SA
 Marker, 222, 706
 frequency extender
 settings, 724
 viewing and changing, 725

- Frequency Offset Using Power Sensor, 547
- Frequency Range
 - NA Mode, 107
- front panel, 45
- Full Screen Mode, 723
- G
- Gating, 130
- gating, 130
- Gating, FFT, 206
- gauge, battery, 784
- getting started information, 37
- glossary,EMI, 344
- glossary,OTA, 393
- GPS, 739,749
- group delay, 106, 107
- H
- high-temperature protection, 40
- hold, 718
- how to
 - change
 - frequency step size, 163, 164, 263, 326
 - units to feet, 81, 93
 - check for a compressed measurement, 171, 267
 - control the preamp, 171, 267, 310, 331, 334
 - create
 - delta marker, 694
 - markers, 692
 - edit keywords, 779
 - edit, enable and disable the current prefix, 781
 - enter
 - numeric values, 53
 - make
 - 1-port cable loss measurement, 6, 6, 67
 - 2-port insertion loss measurement, 6, 8
 - DTF measurements, 72, 84
 - manage files, 776
 - measure return loss, 66
 - monitor the internal FieldFox temperature, 40
 - move
 - cursor, 771, 781
 - reference marker, 694
 - name files, 770
 - perform
 - O, S, L cal, 140
 - O,S, L cal, 140
 - single sweep while in Hold, 718
 - preset, 719
 - recall an *.sta file, 772
 - save
 - display settings as preferences, 735
 - file, 768
 - select
 - CAT mode, 57, 524
 - CAT mode measurements, 57, 524
 - EMI mode, 326
 - NA formats, 106
 - RTSA mode, 263
 - SA mode, 163, 263
 - set
 - attenuation, 170, 266, 310, 329
 - bandpass mode ON, 76
 - date and time, 756
 - frequency context, 665
 - frequency range, 59, 163, 263, 264, 326, 327, 665
 - output power, 63, 115, 580
 - power meter display units, 540
 - res BW, 194, 271, 334, 669
 - resolution, 62, 112
 - scale, 59, 714
 - sweep time, 62
 - sweep type, 61, 112
 - trace averaging, 60, 61, 715
 - video BW, 195, 196
 - use
 - external reference, 754
 - view and change Quick Settings, 105
 - view and change quick settings, 104
- How to set a Band CISPR, 331
- How to set a Traces EMI, 336
- https
 - [//www.keysight.com/us/en/assets/7018-04493/application-notes/5991-4913.pdf](https://www.keysight.com/us/en/assets/7018-04493/application-notes/5991-4913.pdf), 606
- I
- icons, battery, 783
- IF Bandwidth
 - NA Mode, 111
 - VVM, 579
- IF bandwidth
 - NA Mode, 111
- IF Output, 197
- IF output, 197
- indicator (*), old data, 224
- individual,alignments, 211
- initial use, preparing for, 37
- input voltages and power, maximum, 44
- insertion loss
 - measurements, 68
- InstAlign, 216, 280, 317, 337, 669
- installing battery, 38
- Interference Analyzer, 505
- interference rejection, 64
- Interpolation, 153
- Interval Power Marker, 221, 313, 314, 316
- Interval Power Marker IQA, 313
- Interval Span Marker IQA, 314
- IQ
 - Analyzer, 293
 - Streaming, 255
- IQA
 - markers,using, 312
 - measurement,parameters, 30, 1
 - measurements,about, 296
 - measurements,how to make, 297
 - trace display states, 317

- IQA mode
 - settings, 297
- IQA, Capture Data, 298
- Isolation, 150
- K
- Keyboard,ABC, 742
- Keyboard,Qwerty, 742
- keywords, 779
- L
- LAN Settings, 758
- language, settings, 736
- latest information, where to find, 35
- LED
 - battery, 787
 - on/off settings, 40
- license
 - file, 748
 - option, 748
- Licensing, 747
- Limit Lines, 707
- Limit lines, 707
 - saving and recalling, 710
- lithium-ion battery, installing, 38
- logging, data, 387
- M
- Magnitude Offset, 108
- magnitude offset, 108
- Manage Files, 776
- Manage Folders, 778
- managing
 - files, 776
 - folders, 778
- manuals, 35
- mapping
 - settings, 724
- Mapping mode
 - settings, 460, 463
- Mapping, Option 352, 447
- Mapping,Record/Playback, 483
- marker
 - table, 694
- markers, 692
 - Coupled (NA Mode), 695
 - creating, 692
 - delta, 693
 - moving, 692
 - search function, 696, 698
 - table, 694
 - trace, 696
 - trace (CAT & NA Mode), 696
 - trace (SA Mode), 696
- markers,using
 - IQA, 312
- markings
 - battery, 807
 - FieldFox, 804
 - packaging, 810
- math
 - operations, 713
- maximizing battery life, 788
- maximum input voltage and power, 44
- maximum input voltages and power, 44
- Meas UNCAL error, 224
- meas UNCAL error, 195, 196
- measurement selection, EMI Mode, 321
- measurement selection, IQA Mode, 293
- measurement selection, Mapping Mode, 447
- measurement selection, NA Mode, 97
- measurement selection, OTA Mode, 345
- measurement selection, Phased Array Antenna Mode, 395
- measurement selection, USB antenna Mode, 435
- measurement,parameters
 - IQA, 301
- Measurements
 - EMI, 340
 - IQA, 296, 348
 - PAA, 398
 - Phased Array Antenna, 398
 - USB antenna, 439
- measurements
 - 1-port cable loss
 - measurements, CAT mode, 66
 - 1-port cable loss, CAT mode, 66
 - 2-port insertion loss, CAT mode, 68
 - bridge cancellation, VVM mode, 585
 - compressed, 171, 267
 - return loss, 66
 - selection, 57, 524
 - selection, reflection, 524
- measurements,about
 - EMI, 340
 - IQA, 296
 - OTA, 348
 - Phased Array Antenna, 398
 - USB antenna, 439
- measrements,how to make
 - EMF, 383
 - IQA, 297
 - Mapping, 460
 - OTA, 354
 - PAA, 407
 - USB antenna, 239, 441
- mini-USB port, sending SCPI commands, 765
- Mixed-Mode S-Parameters, 100
- mixed-mode S-parameters, 100
- mode, 497
 - EMI, 321
 - IQA, 293
 - Mapping, 447
 - NA, 97
 - OTA, 345
 - Phased Array Antenna, 395
 - power meter, 527
 - RTSA, 263
 - SA, 159, 163, 261, 505, 521, 531, 547
 - temperature control, 41
 - USB antenna, 435
 - VVM, 575
- move
 - cursor, 771, 779, 781
 - reference marker, 694
- moving the cursor, 771, 779, 781
- multiplier abbreviations, 53
- multipliers, 53
- Multi-Trace Configurations, 103
- multi-trace configurations, 103
- N
- NA Factory Cal, 763
- NA mode

- calibration, 133
- settings, 99, 102, 104
- name files, 770
- network analyzer, 97
- noise figure, calibration, 679
- noise figure, option 356, 641
- Noise Marker IQA, 312
- normalization, 146
- normalize, 146
- numeric values, 53
- numeric values, entering, 53

O

- O, S, L cal, 140
- O, S, L calibration, 140
- Occupied Bandwidth, 228
- old data indicator (*), 224
- Opt 010, 121
- option
 - 010, 121
 - 215, 83
- option 312 , channel scanner, 613
- Option 352, Mapping, 447
- Option 355 AM/FM Metrics, 599
- option 356, noise figure, 641
- Option 360, Antenna, 395
- option,license, 748
- options
 - installing, 747
- OTA
 - measurements,about, 348
 - measurements,how to make, 354
- OTA Glossary, 393
- OTA mode
 - settings, 354
- OTA troubleshooting, 392
- Output Power
 - NA Mode, 115, 579
- output power, 63, 115, 580
- overpowering, avoid, 44
- Over-The-Air, 345
- overview, 33
- overview,alignments, 211

P

- PAA
 - settings, 407, 724
- PAA mode

- settings, 407
- packaging markings, 810
- panel, front, 45
- panel, left side, 50
- panel, right side, 49
- panel, top, 48
- Parameter Conversion, 101
- peak
 - criteria, 703
 - excursion, 703, 704
 - threshold, 703
- perform
 - single sweep while in Hold, 718
- Phase Offset, 109
- Phased Array Antenna
 - measurements,about, 398
- phased array antenna
 - settings, 724
- Phased Array Antenna mode
 - settings, 407
- Phased Array
 - Antenna,Record/Playback, 428
- Playback Configuration, 288, 291, 390, 431, 489, 514, 518
- Points EMI mode, 336
- Points SA mode, 208, 276, 668
- points, EMI mode, 336
- points, RTSA mode, 276
- points, SA mode, 208, 668
- Port Extensions, 116
- power meter mode, 527
- power requirements, 37
- power requirements for the AC/DC adapter, 37
- power sensor input, 44, 49
- Power Spectral Density, 227, 249
- power, maximum, 44
- Preferences, 733
- preferences, 733
- prefixes for file names, 779, 781
- preparing for initial use, 37
- preset, 719
- preset settings, 719
- Printing, 782
- printing, 782
- protection, high
 - temperature, 40
- protective functions of the battery, 784

- Pulse Measurements, 557

Q

- Quick Settings, 105
- quick settings, 58
- QuickCal, 137
- Qwerty keyboard, 742

R

- Radio Standard, 165
- real-time spectrum analyzer
 - mode, 261
- recall an *.sta file, 772
- recalling files, 772
- Receiver Measurements, 102
- Record Source, 290, 517
- Record/Playback, 284, 510
- Record/Playback,Mapping, 483
- Record/Playback,Phased Array Antenna, 428
- Record/Playback,RTSA, 284, 387
- Record/Playback,SA, 510
- Recording Configuration, 289, 388, 430, 489, 515
- reference marker, 694, 705
- reference, external
 - frequency, 754
- Reflection Mode, 521
- remote server, 497
- resolution, 51, 62
 - NA Mode, 112
- Resolution Bandwidth EMI mode, 334
- Resolution Bandwidth SA mode, 194, 271, 669
- resolution bandwidth, EMI mode, 334
- resolution bandwidth, NF mode, 669
- resolution bandwidth, RTSA mode, 271
- resolution bandwidth, SA mode, 194
- Resolution, NA mode, 112
- Response Cals, 145
- response calcs, 145
- Restart, 208, 275, 335, 668
- restart, 208, 275, 335, 668
- return loss measurements, CAT mode, 66

review connector care, 54
 reviewconnector care, 817
 RRC Weighting, 234
 RTSA, 261
 RTSA mode
 settings, 263
 units, 264
 RTSA, Spectrogram
 Display, 282
 RTSA,Record/Playback, 284,
 387
 RTSA,Spectrogram
 Display, 282
 RTSA,spectrogram display, 282

S
 S11 measurements, NA
 mode, 99, 102
 SA mode
 settings, 163, 263, 282, 506
 units, 168
 SA Mode Units, 168, 264
 SA,Record/Playback, 510
 SA,spectrogram display, 506
 Safety Considerations, 791
 save
 display setting as
 preferences, 735
 file, 768
 save and recalling files, 768
 Save Preferences, 735
 Scale Settings
 NA Mode, 107
 scale settings, NA mode, 107
 scale, setting, 59, 714
 screen cleaning, 47
 screen front panel, 51
 Security Level, 756
 select
 language, 736
 sending SCPI commands,
 mini-USB port, 765
 sensors,LAN
 Troubleshooting, 544
 service diagnostics, 763
 Sessions, 284, 510
 set
 date and time, 739
 display colors, 721
 display units, 540
 output power, 579

settings
 CAT mode, 57, 523, 524
 CISPR, 329
 DTF, 74, 86, 99, 123, 297, 354
 DTF mode, 74
 EMF, 236, 380, 724
 EMI, 343
 frequency extender, 724
 language, 736
 Mapping, 460
 mapping, 724
 PAA, 407, 724
 phased array antenna, 724
 preset, 719
 RTSA mode, 263
 SA mode, 163, 263, 282, 506
 spectral emission mask, 724
 USB antenna, 441
 USB antennas, 724
 VVM mode, 578
 Settings, EMF, 380
 settings,EMF, 236
 settings,how to set up
 Mapping, 463
 smoothing, 61
 Source Control with USB
 Power Meter, 538
 S-parameters, 99
 spectral emission mask
 settings, 724
 Spectrogram Display, 282, 506
 Spectrogram Display,
 RTSA, 282
 Spectrogram Display,RTSA, 282
 spectrogram display,RTSA, 282
 spectrogram display,SA, 506
 spectrum analyzer mode, 159,
 261, 505, 521, 531, 547
 Spectrum Emission Mask
 (SEM) - (SA Mode Only), 248
 stand-by mode, 39
 Startup Mode, 737
 static charge, dissipate, 44
 Step Detection Mode, 542
 Streaming
 IQ, 255
 suffixes for file names, 779
 sweep
 acquisition parameter, 196,
 197, 199
 time, 62
 time, NA mode, 113

 type, 61, 112
 type, EMI mode, 197
 type, SA mode, 196
 Sweep Acquisition, 199
 sweep acquisition, 199
 Sweep Time
 NA Mode, 113
 Sweep Type
 EMI Mode, 197
 SA Mode, 196
 system configuration
 settings, 747
 System Impedance (Z0), 116
 System Settings, 717
 systematic, 134

T
 TDR, 83
 temperature control mode, 41
 Time Domain, 121
 time domain, 83
 Time Zone, 739, 757
 time zone, 739
 time/date setting, 739, 756
 title, editing, 722, 723, 770
 top panel, 48
 trace averaging, setting, 61, 715
 Trace Display States, 208, 277,
 317, 336
 trace display states
 IQA, 317
 Trace Math, 555, 712
 Trace Width, 722, 735
 Tracking Generator, 193
 Transform, 121
 transform, 124
 Transform Window, 126
 transform window, 126
 triggering - RTSA mode, 272
 Triggering - SA Mode, 202, 272
 triggering - SA mode, 113, 202
 TRL, 149
 troubleshooting
 sensors,LAN, 544
 troubleshooting,OTA, 392
 Tune & Listen (AM/FM), 177

U
 units, changing, 81, 93
 units, DTF, changing, 81

USB antenna, 435
 measurements,about, 439
 measurements,how to
 make, 239, 441
 settings, 441
USB antenna mode
 settings, 236, 441
USB antennas
 settings, 724
USB keyboard, 34
use
 external reference, 754
User Preset, 719
User Tags, 286, 512
utilities, 724

V

values
 multipliers, 53
 numeric, 53
values, multipliers, 53
VBW, 195, 196
vector voltmeter, 575
vector voltmeterSeeVVM, 575
Velocity Factor, 77, 117
verifying integrity of
 calibration, 155
 jumper cables, 155
verifying integrity of calibration
 & jumper cables, 155
video bandwidth, 195, 196
Video Bandwidth SA mode, 195
Video triggering, 113, 202, 272
video triggering, 202, 207, 272
viewing
 charge status, battery, 718,
 783
 installed options, 735, 747
viewing and changing
 frequency extender, 725
Volume Control, 720
volume control, 720
VSA, 497
vsa, 497
VVM Calibration, 581
VVM mode, 575

bridge cancellation
 measurements, 585
 settings, 578
VVM mode, settings, 578

W

Waterfall Display, 506, 509
Waveguide Calibrations, 150
where to find the latest
 information, 35
Window Settings
 DTF, 80, 92
window settings, DTF, 80

Z

zero span, 200, 201
Zeroing VVM mode, 581
zeroing, external, 537
zeroing, VVM mode, 581



This information is subject to change without notice.

© Keysight Technologies 2014-2022

Edition 1, February 2022



N9927-90020

www.keysight.com