

# Keysight U1190A Series Handheld Clamp Meter

## Notices

### Copyright Notice

© Keysight Technologies 2012–2017

No part of this manual may be reproduced in any form or by any means (including electronic storage and retrieval or translation into a foreign language) without prior agreement and written consent from Keysight Technologies as governed by United States and international copyright laws.

### Manual Part Number

U1191-90014

### Edition

Edition 9, June 3, 2020

### Printed in:

Printed in Malaysia

### Published by:

Keysight Technologies  
Bayan Lepas Free Industrial Zone,  
11900 Penang, Malaysia

### Technology Licenses

The hardware and/or software described in this document are furnished under a license and may be used or copied only in accordance with the terms of such license.

### Declaration of Conformity

Declarations of Conformity for this product and for other Keysight products may be downloaded from the Web. Go to <http://www.keysight.com/go/conformity>. You can then search by product number to find the latest Declaration of Conformity.

### U.S. Government Rights

The Software is “commercial computer software,” as defined by Federal Acquisition Regulation (“FAR”) 2.101. Pursuant to FAR 12.212 and 27.405-3 and Department of Defense FAR Supplement (“DFARS”) 227.7202, the U.S. government acquires commercial computer software under the same terms by which the software is customarily provided to the public. Accordingly, Keysight provides the Software to U.S. government customers under its standard commercial license, which is embodied in its End User License Agreement (EULA), a copy of which can be found at <http://www.keysight.com/find/sweula>. The license set forth in the EULA represents the exclusive authority by which the U.S. government may use, modify, distribute, or disclose the Software. The EULA and the license set forth therein, does not require or permit, among other things, that Keysight: (1) Furnish technical information related to commercial computer software or commercial computer software documentation that is not customarily provided to the public; or (2) Relinquish to, or otherwise provide, the government rights in excess of these rights customarily provided to the public to use, modify, reproduce, release, perform, display, or disclose commercial computer software or commercial computer software documentation. No additional government requirements beyond those set forth in the EULA shall apply, except to the extent that those terms, rights, or licenses are explicitly required from all providers of commercial computer software pursuant to the FAR and the DFARS and are set forth specifically in writing elsewhere in the EULA. Keysight shall be under no obligation to update, revise or otherwise modify the Software. With respect to any technical data as defined by FAR 2.101, pursuant to FAR 12.211 and 27.404.2 and DFARS 227.7102, the U.S. government acquires no greater than Limited Rights as defined in FAR 27.401 or DFAR 227.7103-5 (c), as applicable in any technical data.

### Warranty

THE MATERIAL CONTAINED IN THIS DOCUMENT IS PROVIDED “AS IS,” AND IS SUBJECT TO BEING CHANGED, WITHOUT NOTICE, IN FUTURE EDITIONS. FURTHER, TO THE MAXIMUM EXTENT PERMITTED BY APPLICABLE LAW, KEYSIGHT DISCLAIMS ALL WARRANTIES, EITHER EXPRESS OR IMPLIED, WITH REGARD TO THIS MANUAL AND ANY INFORMATION CONTAINED HEREIN, INCLUDING BUT NOT LIMITED TO THE IMPLIED WARRANTIES OF MERCHANTABILITY AND FITNESS FOR A PARTICULAR PURPOSE. KEYSIGHT SHALL NOT BE LIABLE FOR ERRORS OR FOR INCIDENTAL OR CONSEQUENTIAL DAMAGES IN CONNECTION WITH THE FURNISHING, USE, OR PERFORMANCE OF THIS DOCUMENT OR OF ANY INFORMATION CONTAINED HEREIN. SHOULD KEYSIGHT AND THE USER HAVE A SEPARATE WRITTEN AGREEMENT WITH WARRANTY TERMS COVERING THE MATERIAL IN THIS DOCUMENT THAT CONFLICT WITH THESE TERMS, THE WARRANTY TERMS IN THE SEPARATE AGREEMENT SHALL CONTROL.

### Safety Information

#### CAUTION









A CAUTION notice denotes a hazard. It calls attention to an operating procedure, practice, or the like that, if not correctly performed or adhered to, could result in damage to the product or loss of important data. Do not proceed beyond a CAUTION notice until the indicated conditions are fully understood and met.

#### WARNING

A WARNING notice denotes a hazard. It calls attention to an operating procedure, practice, or the like that, if not correctly performed or adhered to, could result in personal injury or death. Do not proceed beyond a WARNING notice until the indicated conditions are fully understood and met.

## Safety Symbols

The following symbols on the instrument and in the documentation indicate precautions that must be taken to maintain safe operation of the instrument.

	DC (Direct current or voltage)		Caution, risk of danger (refer to this manual for specific Warning or Caution information)
	AC (Alternating current or voltage)		Application around and removal from HAZARDOUS LIVE conductors is permitted
	Both direct and alternating current	<b>400 A MAX</b>	<b>U1191A/U1192A:</b> Maximum allowable current measurement is 400 A
	Earth (ground) terminal	<b>600 A MAX</b>	<b>U1193A/U1194A:</b> Maximum allowable current measurement is 600 A
	Equipment protected throughout by double insulation or reinforced insulation	<b>CAT III 600 V</b>	Category III 600 V overvoltage protection
	Caution, risk of electric shock	<b>CAT IV 300 V</b>	Category IV 300 V overvoltage protection

## Safety Considerations

Read the information below before using this instrument.

The following general safety precautions must be observed during all phases of operation, service, and repair of this instrument. Failure to comply with these precautions or with specific warnings elsewhere in this manual violates safety standards for design, manufacture, and intended use of the instrument. Keysight Technologies assumes no liability for the customer's failure to comply with these requirements.

### CAUTION

- Disconnect circuit power and discharge all high-voltage capacitors before testing resistance, continuity, diodes, or capacitance.
- Use the proper terminals, function, and range for your measurements.
- This device is for use at altitudes of up to 2,000 m.
- Never measure voltage when current measurement is selected.
- Always use the specified battery type. The power for the meter is supplied with two standard AAA 1.5 V batteries. Observe the correct polarity markings before you insert the batteries to ensure proper insertion of the batteries in the meter.
- You are advised to use low leakage batteries when changing to new batteries. Please remember to remove the batteries when the meter is not in use for a long period of time. Warning on the risk of battery leakage.

### WARNING

- Do not use the meter if it is damaged. Before you use the meter, inspect the case. Look for cracks or missing plastic. Pay particular attention to the insulation surrounding the connectors.
- Inspect the test leads for damaged insulation or exposed metal. Check the test leads for continuity. Replace damaged test leads before you use the meter.
- Do not operate the meter around explosive gas, vapor, or wet environments.
- Do not apply more than the rated voltage and current (as marked on the meter) between the terminals or between the terminal and the earth ground.

**WARNING**

- Never use the meter in wet conditions or when there is water on the surface. If the meter is wet, ensure that the meter is dried only by trained personnel.
  - Before use, verify the meter's operation by measuring a known voltage. Use caution when working above 60 V DC, 30 V AC RMS, or 42.4 V peak. Such voltages pose a shock hazard.
  - When measuring current, turn off the circuit power before connecting the meter in the circuit. Remember to place the meter in series with the circuit.
  - When measuring temperature, keep the thermocouple probe as close to the meter as possible, and avoid contact with surfaces above 60 V DC, 30 V AC RMS, or 42.4 V peak. Such voltages pose a shock hazard.
  - When servicing the meter, use only the specified replacement parts.
  - When using the probes, keep your fingers behind the finger guards on the probes.
  - Connect the common test lead before you connect the live test lead. When you disconnect the leads, disconnect the live test lead first.
  - Remove the test leads from the meter before you open the battery cover. Do not operate the meter with the battery cover or portions of the cover removed or loosened.
  - To avoid false readings, which may lead to possible electric shock or personal injury, replace the battery as soon as the low-battery indicator appears and flashes.
  - Use the meter only as specified in this guide. Otherwise, the protection provided by the meter may be impaired.
  - Individual protective equipment must be used if hazardous live parts in the installation are accessible where measurement is to be carried out.
  - The tactile indicator, or barrier, indicates the limit of safe access of the handheld part.
-

## Measurement Category

The U1190A Series has a safety rating of CAT III, 600 V and CAT IV, 300 V.

**Measurement CAT I** Measurements performed on circuits not directly connected to the AC mains. Examples are measurements on circuits not derived from the AC mains and specially protected (internal) mains-derived circuits.

**Measurement CAT II** Measurements performed on circuits directly connected to a low-voltage installation. Examples are measurements on household appliances, portable tools, and similar equipment.

**Measurement CAT III** Measurements performed in the building installation. Examples are measurements on distribution boards, circuit-breakers, wiring, including cables, bus-bars, junction boxes, switches, socket outlets in the fixed installation, and equipment for industrial use, and some other equipment including stationary motors with permanent connection to the fixed installation.

**Measurement CAT IV** Measurements performed at the source of the low-voltage installation. Examples are electricity meters and measurements on primary overcurrent protection devices and ripple control units.

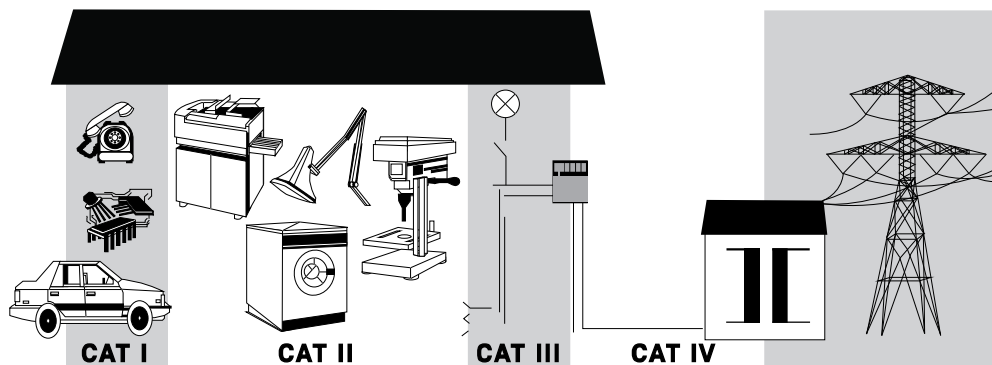

## Environmental Conditions

This instrument is designed for indoor use and in an area with low condensation. The table below shows the general environmental requirements for this instrument.





Environmental condition	Requirement
Operating temperature	-10 °C to 50 °C
Operating humidity	Up to 80% RH (relative humidity) for temperature up to 30 °C, decreasing linearly to 50% RH at 50 °C
Storage temperature	-40 °C to 60 °C, 40% to 80% RH (without batteries)
Altitude	Up to 2000 meters
Pollution degree	Pollution Degree 2

### NOTE

The U1190A Series Handheld Clamp Meter complies with the following safety and EMC requirements:

- IEC 61010-1:2001/EN 61010-1:2001
- IEC 61010-2-032:2002/EN 61010-2-032:2002
- CAN/CSA-C22.2 No. 61010-1-04
- CAN/CSA-C22.2 No. 61010-2-032-04
- ANSI/UL Std. No. 61010-1:2004
- IEC61326-1:2005/EN61326-1:2006
- Canada: ICES/NMB-001: Issue 4, June 2006
- Australia/New Zealand: AS/NZS CISPR 11:2004

## Regulatory Markings

	<p>The CE mark is a registered trademark of the European Community. This CE mark shows that the product complies with all the relevant European Legal Directives.</p>		<p>The RCM mark is a registered trademark of the Australian Communications and Media Authority.</p>
<p><b>ICES/NMB-001</b></p>	<p>ICES/NMB-001 indicates that this ISM device complies with the Canadian ICES-001. Cet appareil ISM est conforme a la norme NMB-001 du Canada.</p>		<p>This instrument complies with the WEEE Directive (2002/96/EC) marking requirement. This affixed product label indicates that you must not discard this electrical or electronic product in domestic household waste.</p>
	<p>The CSA mark is a registered trademark of the Canadian Standards Association.</p>		<p>This symbol indicates the time period during which no hazardous or toxic substance elements are expected to leak or deteriorate during normal use. Forty years is the expected useful life of the product.</p>



## Waste Electrical and Electronic Equipment (WEEE) Directive 2002/96/EC

This instrument complies with the WEEE Directive (2002/96/EC) marking requirement. This affixed product label indicates that you must not discard this electrical or electronic product in domestic household waste.

### Product category:

With reference to the equipment types in the WEEE directive Annex 1, this instrument is classified as a “Monitoring and Control Instrument” product.

The affixed product label is as shown below.



Do not dispose in domestic household waste.

To return this unwanted instrument, contact your nearest Keysight Service Center, or visit <http://about.keysight.com/en/companyinfo/environment/takeback.shtml> for more information.

## Sales and Technical Support

To contact Keysight for sales and technical support, refer to the support links on the following Keysight websites:

- [www.keysight.com/find/handheldmm](http://www.keysight.com/find/handheldmm)  
(product-specific information and support, software and documentation updates)
- [www.keysight.com/find/assist](http://www.keysight.com/find/assist)  
(worldwide contact information for repair and service)

THIS PAGE HAS BEEN INTENTIONALLY LEFT BLANK.

# Table of Contents

Safety Symbols	3
Safety Considerations	4
Measurement Category	6
Environmental Conditions	7
Regulatory Markings	8
Waste Electrical and Electronic Equipment (WEEE) Directive	
2002/96/EC	9
Product category:	9
Sales and Technical Support	9
<b>1 Calibration Procedures</b>	
Keysight Calibration Services	18
Closed-case calibration	18
Calibration interval	19
Other recommendations for calibration	19
Recommended Test Equipment	20
Basic Operating Test	21
LCD backlight test	21
LED flashlight test	21
Display test	22
Calibration Process	23
Test Considerations	24
Functional Tests	25
Performance Verification Tests	31
Using the Front Panel for Adjustments	34
Adjustment considerations	34
Adjustment procedure	35
Valid adjustment input values	37
Exiting the adjustment mode	40

## 2 Service and Maintenance

Troubleshooting .....	42
Returning the Instrument for Service .....	43
Replaceable Parts .....	44
To order replaceable parts .....	44
Types of Service Available .....	45
Extended service contracts .....	45
Obtaining Repair Service (Worldwide) .....	46

## List of Figures

Figure 1-1	LCD display screen	22
Figure 1-2	Vsense test	26
Figure 1-3	Current performance verification test setup	30
Figure 1-4	Location of VR101 and VR102, and VR103 adjustment points	38

THIS PAGE HAS BEEN INTENTIONALLY LEFT BLANK.

## List of Tables

Table 1-1	Recommended test equipment	20
Table 1-2	Vsense test	26
Table 1-3	DC current offset test	27
Table 1-4	AC current balancing test	30
Table 1-5	Performance verification tests	31
Table 1-6	Performance verification tests (continued)	32
Table 1-7	Open-case adjustment points	37
Table 1-8	Close-case adjustment inputs	39
Table 2-1	Operating checklist	42

THIS PAGE HAS BEEN INTENTIONALLY LEFT BLANK.



## Keysight U1190A Series Handheld Clamp Meter Service Guide

# 1 Calibration Procedures

Keysight Calibration Services	18
Recommended Test Equipment	20
Basic Operating Test	21
Calibration Process	23
Test Considerations	24
Functional Tests	25
Performance Verification Tests	31
Using the Front Panel for Adjustments	34

This chapter contains procedures for verifying the instrument performance, as well as procedures for making adjustments (calibration) where necessary.

## Keysight Calibration Services

When your instrument is due for calibration, contact your local Keysight Service Center for recalibration. See “Types of Service Available” on page 45 for more information on the various calibration services offered.

### Closed-case calibration

The U1191A, U1192A, and U1193A handheld clamp meter features a closed-case electronic calibration. In other words, no internal electro-mechanical adjustment is required. This instrument calculates correction factors based on the input reference signals you feed into it during the calibration process. The new correction factors are stored in nonvolatile EEPROM memory until the next calibration (adjustment) is performed.

The contents of this nonvolatile EEPROM memory will not change even when the power is switched off.

#### NOTE

**The U1194A handheld clamp meter requires a an open-case electronic calibration.**

The U1194A handheld clamp meter requires additional electro-mechanical adjustment. See [Table 1-7, “Open-case adjustment points,”](#) on page 37 for more information.

---

## Calibration interval

The instrument should be calibrated on a regular interval determined by the measurement accuracy requirements of your application.

A one-year interval is adequate for most applications.

Accuracy specifications are warranted only if calibration is performed at regular intervals. Accuracy specifications are not warranted beyond the one-year calibration interval.

Keysight does not recommend extending calibration intervals beyond two years for any application.

## Other recommendations for calibration

Specifications are only guaranteed within the specified period from the last calibration. Keysight recommends that readjustment should always be performed at whatever calibration interval you select. This will ensure that the instrument remains within its specifications until the next calibration. This calibration criterion provides the best long-term stability.

During performance verification tests, only the performance data is collected; these tests do not guarantee that the instrument will remain within the specified limits. The tests are only for identifying which functions need adjustment.

## Recommended Test Equipment

The test equipment recommended for the performance verification and adjustment procedures is listed below in [Table 1-1](#). If the exact instrument is not available, substitute with another calibration standard of equivalent accuracy.

**Table 1-1** Recommended test equipment





Application	Recommended equipment	Recommended accuracy requirement
DC voltage	Fluke 5520A	<20% of the instrument accuracy specification
DC current	Fluke 5520A and Fluke 5500A/COIL	<20% of the instrument accuracy specification
Resistance	Fluke 5520A	<20% of the instrument accuracy specification
AC voltage	Fluke 5520A	<20% of the instrument accuracy specification
AC current	Fluke 5520A and Fluke 5500A/COIL	<20% of the instrument accuracy specification
Frequency	Fluke 5520A	<20% of the instrument accuracy specification
Capacitance	Fluke 5520A	<20% of the instrument accuracy specification
Diode	Fluke 5520A	<20% of the instrument accuracy specification
Temperature	Fluke 5520A TM Electronics KMPC1MP TC-to-TC	<20% of the instrument accuracy specification -
Short	Shorting plug – a dual banana plug with a copper wire shorting the two terminals	

## Basic Operating Test

The tests listed below are used to test the basic operations of the instrument. Repair is required if the instrument fails any of the tests.



- “LCD backlight test”
- “LED flashlight test”
- “Display test”

### LCD backlight test

Power-on the clamp meter and press  (on the U1192A/U1193A/U1194A models) or  (on the U1191A model). Check that the LCD backlight is turned on. Press the / key again to turn the LCD backlight off.

### LED flashlight test

For U1192A, U1193A, and U1194A models only:

Press and hold the  key for more than 1 second. Check that the LED flashlight is turned on. Press and hold the  key for more than 1 second again to turn the LED flashlight off.

## Display test

Press and hold the **Hold** key while turning the rotary switch from the **OFF** position to any other position (**ON**). Check that all the annunciators are displayed in the LCD. Compare the display with the example shown in **Figure 1-1**. All annunciators are displayed in the LCD for 10 seconds.

To exit this mode, please wait 10 seconds for the clamp meter to return to normal operation. Alternatively, you may cycle the clamp meter's power. The clamp meter will return to normal operation when it is turned on again.

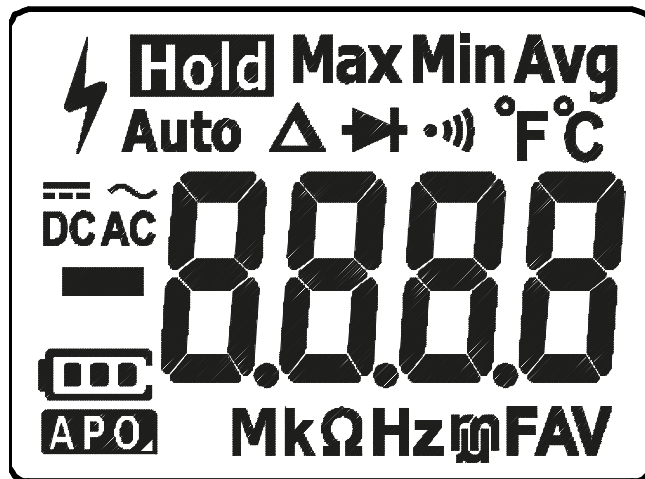

**Figure 1-1** LCD display screen

## Calibration Process

- 1 Prior to performing the verification tests, see “[Test Considerations](#)” on page 24.
- 2 Perform the functional tests to verify the following measurement functionality of the clamp meter; see “[Functional Tests](#)” on page 25.
- 3 Perform the verification tests to characterize the clamp meter; see “[Performance Verification Tests](#)” on page 31.
- 4 Prior to performing the adjustments, see “[Adjustment considerations](#)” on page 34.
- 5 Perform the adjustment procedure; see “[Adjustment procedure](#)” on page 35.
- 6 Ensure that the clamp meter is not in the adjustment mode and is turned off; see “[Exiting the adjustment mode](#)” on page 40.

## Test Considerations

For optimum performance, all procedures should comply with the following recommendations:

- The performance verification test or adjustment should be performed under a laboratory condition, where the ambient temperature can be controlled.
- Ensure that the calibration ambient temperature is stable and is between 18 °C and 28 °C. Ideally the calibration should be performed at 23 °C ± 1 °C.
- Ensure that the ambient relative humidity is less than 80%.
- The instrument should be in the laboratory environment for at least 1 hour prior.
- Allow a warm-up period of 3 minutes.
- Use shielded twisted-pair PTFE-insulated cables to reduce settling and noise errors. Keep the input cables as short as possible.



## Functional Tests

Use the functional tests to verify the following measurement functionality of the instrument.

- “Vsense test” on page 25
- “DC current offset test” on page 27
- “AC current balancing test” on page 28

### Vsense test

This test is for U1192A, U1193A, and U1194A models only. Use the following procedure to verify that Vsense is functional.

#### NOTE

- Keep the clamp meter away from electrical noise sources (that include fluorescent lights, dimmable lights, motors, and so on) during the tests. These sources can trigger the Vsense alert and invalidate the test.
  - It may be necessary to slightly adjust the clamp meter’s position for maximum signal strength, in order to get the clamp meter’s beeper to sound continuously.
- 

#### CAUTION

Do not touch the dual banana plug with your hand while the calibrator output is turned on.

---

1 Calibration Procedures

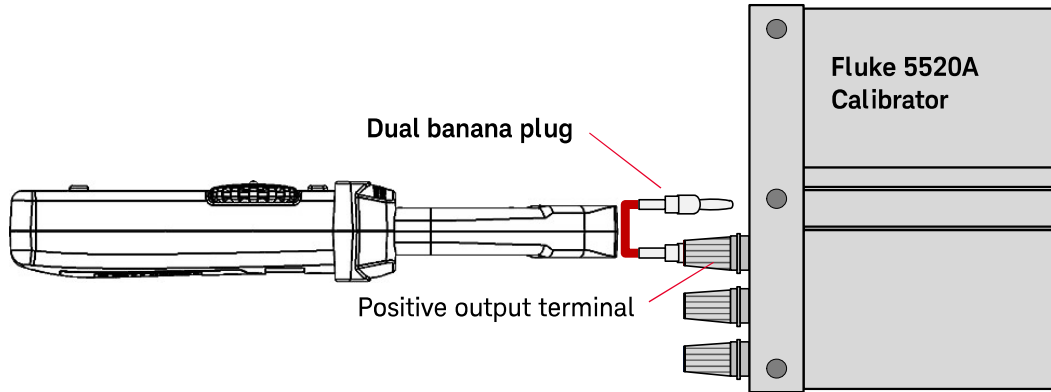

**Figure 1-2** Vsense test



- 1 Connect a dual banana plug to the output voltage terminals of the calibrator.

**NOTE**

Ensure that the Fluke 5520A calibrator output is disabled when connecting the dual banana plug.

- 2 Set the Fluke 5520A calibrator output to the values shown in [Table 1-2](#) on page 26, and enable the Fluke 5520A calibrator output.
- 3 Hold the clamp meter so that the top of the clamp meter is vertically and horizontally centered and in contact with the banana plug's Hi terminal.

**Table 1-2** Vsense test

Step	Test function	Range	Fluke 5520A output	Vsense alert status
1	Vsense Turn the rotary switch to the  position.	Hi.SE	5 V, 60 Hz	No alert
			8 V, 60 Hz	Alert on
	Press  to switch to Lo.SE.	Lo.SE	18 V, 60 Hz	No alert
			24 V, 60 Hz	Alert on

- 4 Adjustment or repair is required if the clamp meter fails any of the Vsense functional tests. See [“Close-case adjustment”](#) on page 39.

### DC current offset test

This test is for U1194A models only.

- 1 Place the clamp meter at a stationary position. Keep the clamp jaw closed without any conductor inside the jaw.
- 2 Turn the rotary switch of the clamp meter to the DC current function.
- 3 Verify that the measured readings fall within the specified error limits from the reference value as stated in [Table 1-3](#). Repair is required if the clamp meter fails this test. See [“Open-case adjustment \(U1194A only\)”](#) on page 37.

**Table 1-3** DC current offset test

Step	Test function	Range	Reference input value	Error limit <sup>[a]</sup>
1	DC current	40 A	0.00 A	±0.10 A

[a] Specified after the Null function is turned on.

### AC current balancing test

This test is for U1194A models only.

- 1 Place the clamp meter on to a Fluke 5500A/COIL 50-turn current coil as shown in [Figure 1-3, “Current performance verification test setup,”](#) on page 30.
- 2 Set the Fluke 5520A calibrator output to the values shown in [Table 1-4](#) on page 30, and enable the Fluke 5520A calibrator output.
- 3 Check that the position of the conductor relative to the clamp meter is in position 0 as shown in the figure below.

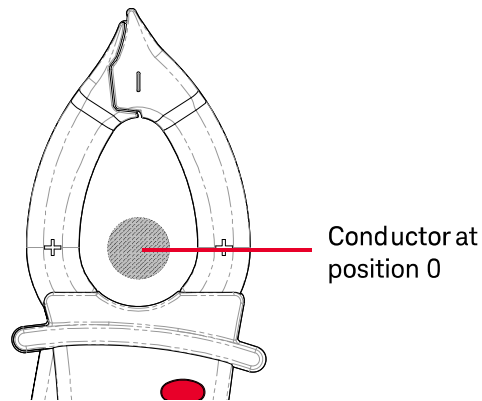

- 4 Record the current reading at position 0.
- 5 Slowly move the clamp meter so that the conductor is in position 1 as shown in the figure on the next page. Ensure that the conductor position is close to the top of the jaw.

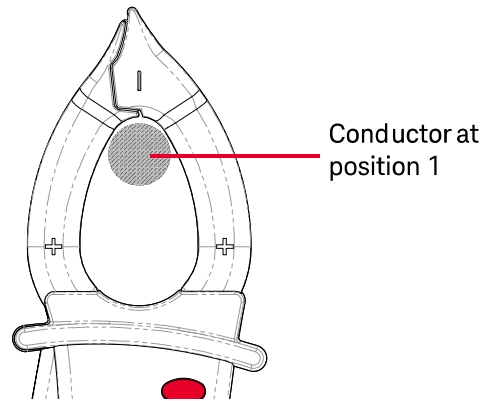

- 6 Record the current reading at position 1.
- 7 Slowly move the clamp meter so that the conductor is in position 2 as shown in the figure below. Ensure that the conductor position is close to the bottom of the jaw.

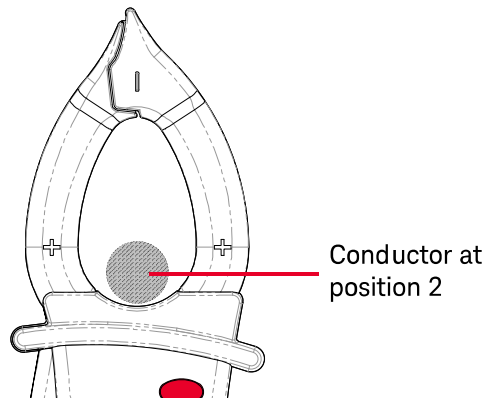

- 8 Record the current reading at position 2.
- 9 Calculate the difference between the readings at position 0 and position 1, and the difference between the readings at position 0 and position 2. Check if the difference falls within the specified error limits in [Table 1-4](#). Adjustment is required if the clamp meter fails this test.

1 Calibration Procedures

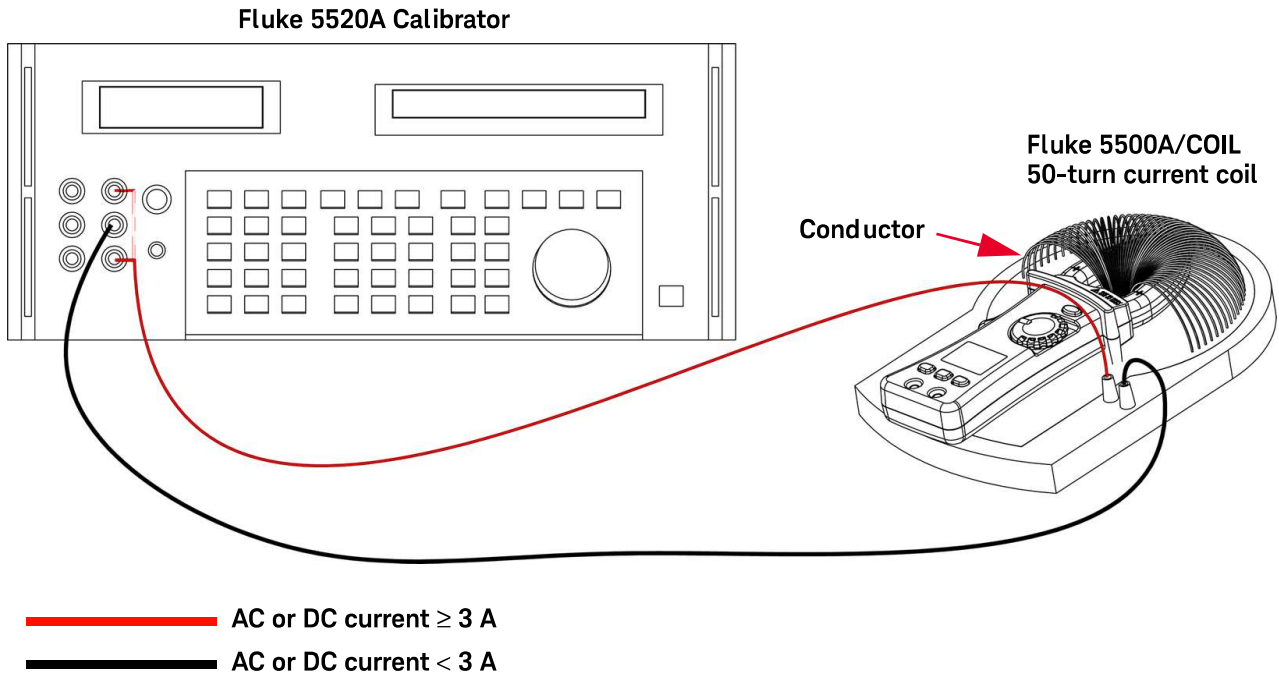

**Figure 1-3** Current performance verification test setup

**Table 1-4** AC current balancing test

Step	Test function	Fluke 5520A output used with Fluke 5500A/COIL	Reference input value	Error limit
1	AC current	2 A, 60 Hz	100.0 A, 60 Hz	$\pm 1.0$ A

## Performance Verification Tests

Use the performance verification tests to verify the measurement performance of the instrument. The performance verification tests use the instrument's specifications listed in the *U1190A Series User's Guide* (available for download at [www.keysight.com/find/hhTechLib](http://www.keysight.com/find/hhTechLib)).



The performance verification tests are recommended as acceptance tests when you first receive the instrument. The acceptance test results should be compared against the one-year test limits. After acceptance, you should repeat the performance verification tests at every calibration interval.

If the clamp meter fails the performance verification tests, adjustment or repair is required.

**NOTE**

Ensure that you have read the **“Test Considerations”** on page 24 before running the performance verification tests.

**Table 1-5** Performance verification tests

Step	Test function	Range	Fluke 5520 output	Reference values	Error from nominal 1 year			
					U1191A	U1192A	U1193A	U1194A
1	ACA Turn the rotary switch to the  position.	60 A	1.2 A, 45 Hz	60 A, 45 Hz	-	±1.25 A	±1.25 A	±1.25 A
			1.2 A, 400 Hz	60 A, 400 Hz	-	±1.85 A	±1.85 A	±1.85 A
		400 A	8 A, 45 Hz	400 A, 45 Hz	±8.5 A	±8.5 A	-	-
			8 A, 400 Hz	400 A, 400 Hz	±12.5 A	±12.5 A	-	-
		600 A	12 A, 45 Hz	600 A, 45 Hz	-	-	±12.5 A	±12.5 A
			12 A, 100 Hz	600 A, 100 Hz	-	-	±18.5 A	±18.5 A
2	DCA Turn the rotary switch to the  position, and press the  key until <b>DC</b> is shown on the display.	60 A	1.2 A	60 A	-	-	-	±1.25 A
		600 A	12 A	600 A	-	-	-	±12.5 A









**Table 1-6** Performance verification tests (continued)

Step	Test function	Range	Fluke 5520 output	Error from nominal 1 year			
				U1191A	U1192A	U1193A	U1194A
3	ACV Turn the rotary switch to the <b>Hz ~v</b> position.	60 V	60 V, 45 Hz	-	±0.77 V	±0.77 V	±0.77 V
			60 V, 500 Hz	-	±0.77 V	±0.77 V	±0.77 V
		600 V	600 V, 45 Hz	±7.7 V	±7.7 V	±7.7 V	±7.7 V
			600 V, 500 Hz	±7.7 V	±7.7 V	±7.7 V	±7.7 V
4	Frequency Turn the rotary switch to the <b>Hz ~v</b> position, and press the <b>Null</b> key once.	9.999 kHz	1 kHz, 6 V	±0.008 kHz	±0.008 kHz	±0.008 kHz	±0.008 kHz
5	DCV Turn the rotary switch to the <b>=v</b> position.	60 V	60 V	-	±0.33 V	±0.33 V	±0.33 V
		600 V	600 V	±3.3 V	±3.3 V	±3.3 V	±3.3 V
6	Resistance Turn the rotary switch to the <b>Ω</b> position.	600 Ω <sup>[a]</sup>	600 Ω	±5.3 Ω	±5.3 Ω	±5.3 Ω	±5.3 Ω
		6 kΩ <sup>[a]</sup>	6 kΩ	±0.051 kΩ	±0.051 kΩ	±0.051 kΩ	±0.051 kΩ
		60 kΩ	60 kΩ	-	±0.51 kΩ	±0.51 kΩ	±0.51 kΩ
7	Diode Turn the rotary switch to the <b>→ ←</b> position.	1.5 V	1.5 V	±0.018 V	±0.018 V	±0.018 V	±0.018 V
8	Capacitance Turn the rotary switch to the <b>→ ←</b> position, and press the <b>Null</b> key once.	600 μF	600 μF	-	±12.4 μF	±12.4 μF	±12.4 μF
		6 mF	6 mF	-	±0.124 mF	±0.124 mF	±0.124 mF

[a] The accuracy is specified after the Null function is used to subtract the test lead resistance and thermal effect (by shorting the test leads). Apply a 0 Ω calibrator output, and allow the clamp meter to settle before pressing the **Null** key.



**Table 1-6** Performance verification tests (continued)

Step	Test function	Range	Fluke 5520 output	Error from nominal 1 year			
				U1191A	U1192A	U1193A	U1194A
9	<b>Temperature</b> <sup>[b]</sup> Turn the rotary switch to the  <b>Temperature</b> position, and press the  key until  is shown on the display.	-40 °C to 400 °C	0 °C	-	-	-	±2.0 °C
		-400 °C to 1200 °C	400 °C	-	-	-	±6 °C
[b] Ensure that the ambient temperature is stable within ±1 °C. Ensure that the clamp meter is placed in a controlled environment for at least 1 hour before you proceed to ensure that the clamp meter's internal reference junction sensor and input terminal are stabilized at the same environment. Keep the clamp meter away from any ventilation exit.							
Differences in ambient compensation between the calibrator and clamp meter may cause some deviations shown between the readings of the calibrator and clamp meter. Placing the clamp meter close to the output terminal of the calibrator will help reduce this deviation.							
Keep the thermocouple test lead as close to the clamp meter as possible.							
Do not touch the thermocouple test lead after connecting it to the calibrator. Allow the connection to stabilize for at least another 15 minutes before performing the measurement.							
10	<b>DCµA</b> Turn the rotary switch to the  <b>DCµA</b> position, and press the  key until  is shown on the display.	60 µA	60 µA	-	-	-	±0.65 µA
		600 µA	600 µA	-	-	-	±6.5 µA
11	<b>ACµA</b> Turn the rotary switch to the  <b>ACµA</b> position, and press the  key until  is shown on the display.	60 µA	60 µA, 45 Hz	-	-	-	±0.65 µA
			60 µA, 500 Hz	-	-	-	±0.65 µA
		600 µA	600 µA, 45 Hz	-	-	-	±6.5 µA
			600 µA, 500 Hz	-	-	-	±6.5 µA

## Using the Front Panel for Adjustments

This section describes the procedures to perform adjustments from the front panel.

### Adjustment considerations

- 1** Allow the instrument to warm up and stabilize for 3 minutes before performing the adjustments.
- 2** Check that the battery level is at least at two bars before performing any adjustments. This ensures that during the adjustments, the low-battery indicator does not appear.
- 3** If the low-battery indicator appears, replace the batteries as soon as possible to avoid false readings.
- 4** Consider the thermal effects as you are connecting the test leads to the calibrator and handheld clamp meter. Keysight recommends you to wait for 1 minute before you begin the calibration after connecting the test leads.
- 5** Before proceeding with the ambient temperature adjustment, be sure to turn on the clamp meter for at least 1 hour with the K-type thermocouple connected.

#### CAUTION



Never turn off the clamp meter during an adjustment. This may delete the calibration memory for the present function.

---

## Adjustment procedure

**NOTE**

Review the “**Test Considerations**” and “**Adjustment considerations**” before beginning the adjustment procedures.

- 1 Press and hold the  and  keys while turning the rotary switch from the **OFF** position to any other position (**ON**) to enter the adjustment mode.

The **Auto** annunciator will flash continuously to indicate that the clamp meter is now in the adjustment mode.



**NOTE**



If the **Auto** annunciator is not flashing, repeat **step 1**. If the error persists, please contact your nearest Keysight Service Center.

- 2 Turn the rotary switch to the respective test function position as shown in the adjustment input values table (Table 1-8). Press  to switch between the **primary** and the **shift** (icons printed in **orange**) functions.
- 3 Apply the input signal shown in the Reference Value column of Table 1-8. Determine if the signal is within the valid reference input range.

**NOTE**

You are highly recommended to complete the adjustments in the same order as shown in the appropriate table.

- 4 Press the / key to save the calibration reference value when a stable reading is achieved on the display.

If the adjustment fails, **Err** will be shown on the display. Press the / key again to return to the current calibration item.

**NOTE**

If the adjustment fails, check the input value and function before repeating the adjustment steps.

## 1 Calibration Procedures

- 5 Turn the rotary switch to the next function according to the Test Function column shown in [Table 1-8](#). Repeat [step 2](#) to [step 4](#) for each adjustment point shown in the adjustment table.
- 6 Verify the adjustments using the “[Performance Verification Tests](#)” on page 31.

### NOTE

While in the adjustment mode, turn the rotary switch to the **OFF** position to exit the adjustment mode.

---

## Valid adjustment input values

**NOTE**

The steps below should only be carried out if it fails the “AC current balancing test” on page 28:

- Connect a DC power source in series to the battery pins. The DC power source may also be replaced with two AA batteries connected in series.
- Set the power supply output to 3 V DC and the over current limitation to 0.1 A. Ensure that the polarity of the connection is correct. The battery pin marked with + is the positive terminal.

Adjustment can be accomplished using the following input values below.

**Open-case adjustment (U1194A only)****Table 1-7** Open-case adjustment points

Test function	Step	Reference value	Limit	Adjustment point
DC current offset test <sup>[a]</sup>	40 A	0.00 A	0.10 A	VR101, VR102
[a] Adjust the VR101 and VR102 adjustment points (see Figure 1-4) until the error is within the limit.				
AC current balancing test <sup>[b]</sup>	400 A	100.0 A, 60 Hz	0.2 A	VR103
[b] Adjust the VR103 adjustment point (see Figure 1-4) until the error is within the limit.				

1 Calibration Procedures

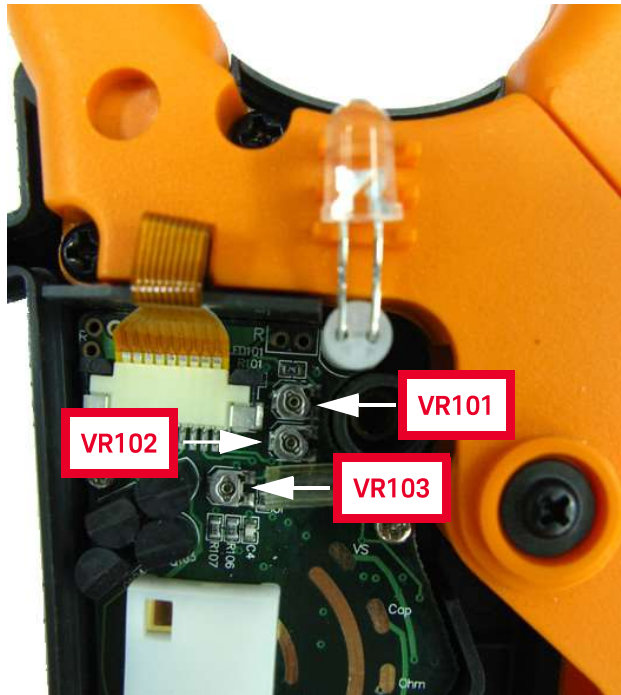



Figure 1-4 Location of VR101 and VR102, and VR103 adjustment points

Close-case adjustment

**Table 1-8** Close-case adjustment inputs

Test function	Reference value	U1191A	U1192A	U1193A	U1194A	Valid reference input
DCV	50.00 V	-	✓	✓	✓	0.9 to 1.1 × Reference value
	500.0 V	✓	✓	✓	✓	0.9 to 1.1 × Reference value
ACV	50.00 V, 60 Hz	-	✓	✓	✓	0.9 to 1.1 × Reference value
	500.0 V, 60 Hz	✓	✓	✓	✓	0.9 to 1.1 × Reference value
ACA	50.00 A, 50 Hz	-	✓	✓	✓	0.75 to 1.25 × Reference value
	240.0 A, 50 Hz	✓	✓	✓	✓	0.75 to 1.25 × Reference value
DCA	50.00 A <sup>[a]</sup>	-	-	-	✓	0.75 to 1.25 × Reference value
	240.0 A <sup>[a]</sup>	-	-	-	✓	0.75 to 1.25 × Reference value
[a] Move the clamp meter away from the signal, and press the  key to zero the offset.						
AC $\mu$ A	50.00 $\mu$ A, 60 Hz	-	-	-	✓	0.9 to 1.1 × Reference value
	500.0 $\mu$ A, 60 Hz	-	-	-	✓	0.9 to 1.1 × Reference value
DC $\mu$ A	50.00 $\mu$ A	-	-	-	✓	0.9 to 1.1 × Reference value
	500.0 $\mu$ A	-	-	-	✓	0.9 to 1.1 × Reference value
Resistance	500.0 $\Omega$ <sup>[b]</sup>	✓	✓	✓	✓	0.9 to 1.1 × Reference value
	5.000 k $\Omega$ <sup>[b]</sup>	✓	✓	✓	✓	0.9 to 1.1 × Reference value
	50.00 k $\Omega$	-	✓	✓	✓	0.9 to 1.1 × Reference value
[b] Short the input terminals, and press the  key to zero the offset.						
Continuity	500.0 $\Omega$	✓	✓	✓	✓	0.9 to 1.1 × Reference value
Diode	1.000 V	✓	✓	✓	✓	0.9 to 1.1 × Reference value
Capacitance	1.000 mF	-	✓	✓	✓	0.9 to 1.1 × Reference value

**Table 1-8** Close-case adjustment inputs (continued)

Test function	Reference value	U1191A	U1192A	U1193A	U1194A	Valid reference input
Temperature	12.209 mV	-	-	-	✓	0.9 to 1.1 × Reference value
	45.119 mV	-	-	-	✓	0.9 to 1.1 × Reference value
	0 °C <sup>[c]</sup>	-	-	-	✓	0.9 to 1.1 × Reference value
[c] Ensure the clamp meter is turned on and stabilized for at least 1 hour with the thermocouple connected between the clamp meter and the calibrator output terminal.						
Vsense (Hi.SE)	9 V, 60 Hz	-	✓	✓	✓	N/A
Vsense (Lo.SE)	27 V, 60 Hz	-	✓	✓	✓	N/A

### Exiting the adjustment mode

- 1 Remove all the shorting plugs and connectors from the instrument.
- 2 Power off and on again.



## 2 Service and Maintenance

Troubleshooting	42
Returning the Instrument for Service	43
Replaceable Parts	44
Types of Service Available	45
Obtaining Repair Service (Worldwide)	46

This chapter will help you troubleshoot a failing instrument. It also describes how to obtain repair services and lists the replaceable assemblies.

## Troubleshooting



**WARNING**

To avoid electrical shock, do not perform any service unless you are qualified to do so.

If the instrument fails to operate, check the batteries and the test leads. Replace them if necessary. And if the instrument still does not function, check the operating procedures in this manual. When servicing, use only the specified replacement parts.

The table below will assist you in identifying some basic malfunctions.

**Table 2-1** Operating checklist

Mal function	Identification
No display when powered ON using the rotary switch	✓ Verify the batteries health and replace batteries as necessary.
Auto powered OFF after powered ON for a while	✓ Verify the auto power-off (APO) function is enabled in the clamp meter's Setup mode.
No backlight when the  /  key is pressed.	✓ Verify that the backlight function is enabled in the clamp meter's Setup mode.
No flashlight when the  is pressed for more than 1 second.	✓ Verify that the flashlight function is enabled in the clamp meter's Setup mode.
No continuity visual alert (flashing backlight when measuring less than the threshold resistance)	✓ Verify that the continuity visual alert is enabled in the clamp meter's Setup mode.

## Returning the Instrument for Service

Before shipping your instrument for repair or replacement, Keysight recommends that you acquire the shipping instructions from the Keysight Technologies Service Center. A clear understanding of the shipping instructions is necessary to secure your product for shipment.

- 1** Attach a tag to the instrument with the following information:
  - Name and address of owner
  - Instrument model number
  - Instrument serial number
  - Description of the service required or failure indications
- 2** Remove all accessories from the instrument. Do not include accessories unless they are associated with the failure symptoms.
- 3** Place the instrument in its original container with appropriate packaging material for shipping.

If the original shipping container is not available, place your unit in a container that will ensure at least 4 inches of compressible packaging material around all sides for the instrument. Use static-free packaging materials to avoid additional damage to your unit.

**NOTE**

Keysight suggests that you always insure your shipments.

---

## Replaceable Parts

This section contains information for ordering replacement parts for your instrument. You can find the instrument support parts list in the *Keysight's Test & Measurement Parts Catalog* at <http://www.keysight.com/find/parts>

The parts lists include a brief description of each part with the applicable Keysight part number.

### To order replaceable parts

You can order replaceable parts from Keysight using the Keysight part number. Note that not all parts listed are available as field-replaceable parts.

To order replaceable parts from Keysight, do the following:

- 1** Contact your nearest Keysight Sales Office or Service Center.
- 2** Identify the parts by the Keysight part number shown in the support parts list.
- 3** Provide the instrument model number and serial number.

## Types of Service Available

If your instrument fails during the warranty period, Keysight Technologies will repair or replace it under the terms of your warranty.

### Extended service contracts

Many Keysight products are available with optional service contracts that extend the covered period after the standard warranty expires. If you have such a service contract and your instrument fails during the covered period, Keysight Technologies will repair or replace it in accordance with the contract.

## Obtaining Repair Service (Worldwide)

To obtain service for your instrument (in-warranty or under service contract), contact your nearest Keysight Technologies Service Center. They will arrange to have your unit repaired or replaced, and can provide warranty information where applicable.

To obtain warranty, service, or technical support information, you can contact Keysight Technologies at one of the following telephone numbers:

- In the United States: (800) 829-4444
- In Europe: 31 20 547 2111
- In Japan: 0120-421-345

Or use our web link for information on contacting Keysight worldwide:  
[www.keysight.com/find/assist](http://www.keysight.com/find/assist)

Or contact your Keysight Technologies Representative.

Before shipping your instrument, ask the Keysight Technologies Service Center to provide shipping instructions, including what components to ship. Keysight recommends that you retain the original shipping carton for use in such shipments.



This information is subject to change without notice. Always refer to the Keysight website for the latest revision.

© Keysight Technologies 2012-2020  
Edition 8, June 3, 2020

Printed in Malaysia



U1191-90014

[www.keysight.com](http://www.keysight.com)