

# Keysight U1281A/U1282A Handheld Digital Multimeter

# Notices

## Copyright Notice

© Keysight Technologies 2016-2021  
No part of this manual may be reproduced in any form or by any means (including electronic storage and retrieval or translation into a foreign language) without prior agreement and written consent from Keysight Technologies as governed by United States and international copyright laws.

## Manual Part Number

U1281-90002

## Edition

Edition 7, July 2021

## Printed in:

Printed in Malaysia

## Published by:

Keysight Technologies  
Bayan Lepas Free Industrial Zone,  
11900 Penang, Malaysia

## Technology Licenses

The hardware and/or software described in this document are furnished under a license and may be used or copied only in accordance with the terms of such license.

## Declaration of Conformity

Declarations of Conformity for this product and for other Keysight products may be downloaded from the Web. Go to <http://www.keysight.com/go/conformity>. You can then search by product number to find the latest Declaration of Conformity.

## U.S. Government Rights

The Software is “commercial computer software,” as defined by Federal Acquisition Regulation (“FAR”) 2.101. Pursuant to FAR 12.212 and 27.405-3 and Department of Defense FAR Supplement (“DFARS”) 227.7202, the U.S. government acquires commercial computer software under the same terms by which the software is customarily provided to the public. Accordingly, Keysight provides the Software to U.S. government customers under its standard commercial license, which is embodied in its End User License Agreement (EULA), a copy of which can be found at <http://www.keysight.com/find/sweula>. The license set forth in the EULA represents the exclusive authority by which the U.S. government may use, modify, distribute, or disclose the Software. The EULA and the license set forth therein, does not require or permit, among other things, that Keysight: (1) Furnish technical information related to commercial computer software or commercial computer software documentation that is not customarily provided to the public; or (2) Relinquish to, or otherwise provide, the government rights in excess of these rights customarily provided to the public to use, modify, reproduce, release, perform, display, or disclose commercial computer software or commercial computer software documentation. No additional government requirements beyond those set forth in the EULA shall apply, except to the extent that those terms, rights, or licenses are explicitly required from all providers of commercial computer software pursuant to the FAR and the DFARS and are set forth specifically in writing elsewhere in the EULA. Keysight shall be under no obligation to update, revise or otherwise modify the Software. With respect to any technical data as defined by FAR 2.101, pursuant to FAR 12.211 and 27.404.2 and DFARS 227.7102, the U.S. government acquires no greater than Limited Rights as defined in FAR 27.401 or DFAR 227.7103-5 (c), as applicable in any technical data.

## Warranty

THE MATERIAL CONTAINED IN THIS DOCUMENT IS PROVIDED “AS IS,” AND IS SUBJECT TO BEING CHANGED, WITHOUT NOTICE, IN FUTURE EDITIONS. FURTHER, TO THE MAXIMUM EXTENT PERMITTED BY APPLICABLE LAW, KEYSIGHT DISCLAIMS ALL WARRANTIES, EITHER EXPRESS OR IMPLIED, WITH REGARD TO THIS MANUAL AND ANY INFORMATION CONTAINED HEREIN, INCLUDING BUT NOT LIMITED TO THE IMPLIED WARRANTIES OF MERCHANTABILITY AND FITNESS FOR A PARTICULAR PURPOSE. KEYSIGHT SHALL NOT BE LIABLE FOR ERRORS OR FOR INCIDENTAL OR CONSEQUENTIAL DAMAGES IN CONNECTION WITH THE FURNISHING, USE, OR PERFORMANCE OF THIS DOCUMENT OR OF ANY INFORMATION CONTAINED HEREIN. SHOULD KEYSIGHT AND THE USER HAVE A SEPARATE WRITTEN AGREEMENT WITH WARRANTY TERMS COVERING THE MATERIAL IN THIS DOCUMENT THAT CONFLICT WITH THESE TERMS, THE WARRANTY TERMS IN THE SEPARATE AGREEMENT SHALL CONTROL.

## Safety Information

### CAUTION





A CAUTION notice denotes a hazard. It calls attention to an operating procedure, practice, or the like that, if not correctly performed or adhered to, could result in damage to the product or loss of important data. Do not proceed beyond a CAUTION notice until the indicated conditions are fully understood and met.

### WARNING

A WARNING notice denotes a hazard. It calls attention to an operating procedure, practice, or the like that, if not correctly performed or adhered to, could result in personal injury or death. Do not proceed beyond a WARNING notice until the indicated conditions are fully understood and met.

## Safety Symbols

The following symbols on the instrument and in the documentation indicate precautions that must be taken to maintain safe operation of the instrument.

	Direct current (DC)		Alternating current (AC)
	Earth (ground) terminal		Caution, risk of danger (refer to this manual for specific Warning or Caution information)
<b>CAT III 1000 V</b>	Category III 1000 V overvoltage protection		Equipment protected throughout by double insulation or reinforced insulation
<b>CAT IV 600 V</b>	Category IV 600 V overvoltage protection		

## Safety Considerations

Read the information below before using this instrument.

The following general safety precautions must be observed during all phases of operation, service, and repair of this instrument. Failure to comply with these precautions or with specific warnings elsewhere in this manual violates safety standards for design, manufacture, and intended use of the instrument. Keysight Technologies assumes no liability for the customer's failure to comply with these requirements.

### WARNING

- Do not exceed any of the measurement limits defined in the specifications to avoid instrument damage and the risk of electric shock.
- Do not use the multimeter if it is damaged. Before you use the multimeter, inspect the case. Look for cracks or missing plastic. Pay particular attention to the insulation surrounding the connectors.
- Inspect the test leads for damaged insulation or exposed metal. Check the test leads for continuity. Replace damaged test leads before you use the multimeter.
- Do not operate the multimeter around explosive gas, vapor, or wet environments.
- Do not apply more than the rated voltage (as marked on the multimeter) between terminals, or between terminal and earth ground.
- Never use the multimeter in wet conditions or when there is water on the surface. If the multimeter is wet, ensure that the multimeter is dried only by trained personnel.
- Before use, verify the multimeter's operation by measuring a known voltage.
- When measuring current, turn off the circuit power before connecting the multimeter in the circuit. Remember to place the multimeter in series with the circuit.
- When servicing the multimeter, use only the specified replacement parts.
- Use caution when working above 60 V DC, 30 V AC rms, or 42.4 V peak. Such voltages pose a shock hazard.

**WARNING**

- When using the probes, keep your fingers behind the finger guards on the probes.
  - Connect the common test lead before you connect the live test lead. When you disconnect the leads, disconnect the live test lead first.
  - Remove the test leads from the multimeter before you open the battery cover.
  - Do not operate the multimeter with the battery cover or portions of the cover removed or loosened.
  - To avoid false readings, which may lead to possible electric shock or personal injury, replace the battery as soon as the low battery indicator appears and flashes.
  - Only probe assemblies with Measurement Category III or IV ratings should be used for mains measurements.
- 

**CAUTION**

- Disconnect circuit power and discharge all high-voltage capacitors before testing resistance, continuity, diodes, or capacitance.
  - Use the proper terminals, function, and range for your measurements.
  - This multimeter is for use at altitudes of up to 3000 m.
  - Never measure voltage when the current measurement is selected.
  - Always use the specified battery type. The power for the multimeter is supplied with four standard 1.5 V AA batteries. Observe the correct polarity markings before you insert the batteries to ensure proper insertion of the batteries in the multimeter.
-

## Measurement Category

The U1281A/U1282A has a safety rating of CAT III, 1000 V and CAT IV, 600 V.

**Measurement CAT I** Measurements performed on circuits not directly connected to the AC mains. Examples are measurements on circuits not derived from the AC mains and specially protected (internal) mains-derived circuits.

**Measurement CAT II** Measurements performed on circuits directly connected to a low-voltage installation. Examples are measurements on household appliances, portable tools, and similar equipment.

**Measurement CAT III** Measurements performed in the building installation. Examples are measurements on distribution boards, circuit-breakers, wiring, including cables, bus-bars, junction boxes, switches, socket outlets in the fixed installation, and equipment for industrial use, and some other equipment including stationary motors with permanent connection to the fixed installation.

**Measurement CAT IV** Measurements performed at the source of the low-voltage installation. Examples are electricity meters and measurements on primary overcurrent protection devices and ripple control units.

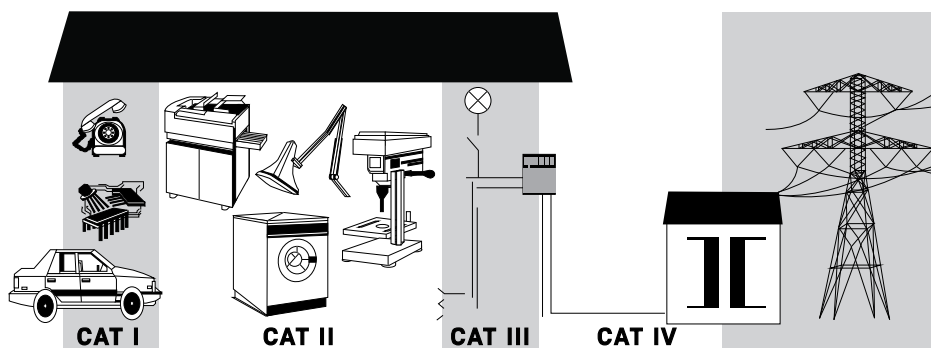

## Environmental Conditions

The U1281A/U1282A is designed for indoor use and in an area with low condensation. The table below shows the general environmental requirements for this instrument.

Environmental condition	Requirement
Temperature	Operating condition
	- -20 °C to 55 °C, 0% to 80% RH (non-condensing)
	Storage condition
	- -40 °C to 70 °C, 0% to 80% RH (without batteries)
Humidity	Full accuracy up to 80% RH (relative humidity) for temperature up to 30 °C, decreasing linearly to 50% RH at 55 °C
Altitude	Up to 3000 meters
Pollution degree	2







## Product Regulatory and Compliance

This U1281A/U1282A complies with safety and EMC requirements.

Refer to Declaration of Conformity at <http://www.keysight.com/go/conformity> for the latest revision.



## Regulatory Markings

 <p>The CE mark is a registered trademark of the European Community. This CE mark shows that the product complies with all the relevant European Legal Directives.</p> <p>ICES/NMB-001 indicates that this ISM device complies with the Canadian ICES-001.</p> <p>Cet appareil ISM est conforme a la norme NMB-001 du Canada.</p> <p>ISM GRP.1 Class A indicates that this is an Industrial Scientific and Medical Group 1 Class A product.</p>	 <p>The CSA mark is a registered trademark of the Canadian Standards Association.</p>
 <p>This instrument complies with the WEEE Directive (2002/96/EC) marking requirement. This affixed product label indicates that you must not discard this electrical or electronic product in domestic household waste.</p>	 <p>The RCM mark is a registered trademark of the Spectrum Management Agency of Australia. This signifies compliance with the Australia EMC Framework regulations under the terms of the Radio Communication Act of 1992.</p>
 <p>This symbol indicates the time period during which no hazardous or toxic substance elements are expected to leak or deteriorate during normal use. Forty years is the expected useful life of the product.</p>	 <p>This symbol is a South Korean Class A EMC Declaration. This is a Class A instrument suitable for professional use and in electromagnetic environment outside of the home.</p>

## Waste Electrical and Electronic Equipment (WEEE) Directive 2002/96/EC

This instrument complies with the WEEE Directive (2002/96/EC) marking requirement. This affixed product label indicates that you must not discard this electrical or electronic product in domestic household waste.

### Product category

With reference to the equipment types in the WEEE directive Annex 1, this instrument is classified as a “Monitoring and Control Instrument” product.

The affixed product label is as shown below.



Do not dispose in domestic household waste.

To return this unwanted instrument, contact your nearest Keysight Service Center, or visit <http://about.keysight.com/en/companyinfo/environment/takeback.shtml> for more information.

## Sales and Technical Support

To contact Keysight for sales and technical support, refer to the support links on the following Keysight websites:

- [www.keysight.com/find/U1281A](http://www.keysight.com/find/U1281A)  
[www.keysight.com/find/U1282A](http://www.keysight.com/find/U1282A)  
(product-specific information and support, software and documentation updates)
- [www.keysight.com/find/assist](http://www.keysight.com/find/assist)  
(worldwide contact information for repair and service)

# Table of Contents

Safety Symbols	3
Safety Considerations	4
Measurement Category	6
Environmental Conditions	7
Regulatory Information	8
Safety compliance	8
EMC compliance	8
Regulatory Markings	9
Waste Electrical and Electronic Equipment (WEEE) Directive	
2002/96/EC	10
Product category	10
Sales and Technical Support	10
<b>1 Calibration Procedures</b>	
Calibration Overview	18
Closed-case calibration	18
Keysight calibration services	18
Calibration interval	18
Recommended adjustment	19
Recommended Test Equipment	20
Basic Operating Tests	21
Backlight test	21
Display test	21
Input warning test (A terminal)	22
Input warning test ( $\mu$ .mA terminal)	24
Calibration Process	26
Test Considerations	26
Performance Verification Tests	27
Calibration Security	37
Unsecuring the Multimeter for Calibration	38

To unsecure the multimeter .....	38
To change the calibration security code .....	41
To reset the calibration security code to its factory default .....	43
Using the Front Panel for Adjustments .....	45
Adjustment considerations .....	45
Valid adjustment input values .....	46
Vsense (non-contact voltage) calibration .....	51
Adjustment procedure .....	53
Exiting the adjustment mode .....	54
Calibration Count .....	55
Calibration Error Codes .....	57

## 2 Service and Maintenance

Troubleshooting .....	60
Fuse Replacement .....	61
Returning the Multimeter for Service .....	64
Replaceable Parts .....	65
To order replaceable parts .....	65
Types of Service Available .....	66
Extended service contracts .....	66
Obtaining Repair Service (Worldwide) .....	67

## List of Figures

Figure 1-1	Display screen	21
Figure 1-2	Example of A-Err for wrong terminal input	23
Figure 1-3	Example of $\mu$ AErr for wrong terminal input	25
Figure 1-4	Calibration security code entry display	38
Figure 1-5	Multimeter display when unsecuring the multimeter	40
Figure 1-6	Multimeter display when changing the calibration security code	42
Figure 1-7	Multimeter display when resetting the calibration security code to its factory default	44
Figure 1-8	Multimeter display for Vsense (non-contact voltage) calibration	52
Figure 1-9	Multimeter display for calibration count	56

THIS PAGE HAS BEEN INTENTIONALLY LEFT BLANK.

## List of Tables

Table 1-1	Recommended test equipment	20
Table 1-2	DC V (V) performance verification tests	27
Table 1-3	DC mV (mV) performance verification tests	28
Table 1-4	AC V (V) performance verification tests	29
Table 1-5	AC mV (mV) performance verification tests	30
Table 1-6	LPF performance verification test	30
Table 1-7	DC current ( $\mu$ A.mA) performance verification tests	31
Table 1-8	DC current (A) performance verification tests	31
Table 1-9	AC current (A) performance verification tests	32
Table 1-10	AC current ( $\mu$ A.mA) performance verification tests	33
Table 1-11	Diode performance verification test	33
Table 1-12	Capacitance performance verification tests	34
Table 1-13	Resistance performance verification tests	34
Table 1-14	Conductance performance verification test	35
Table 1-15	Frequency sensitivity performance verification test	35
Table 1-16	Duty cycle performance verification test	35
Table 1-17	Temperature performance verification test	36
Table 1-18	Frequency counter performance verification test	36
Table 1-19	Adjustment input values	46
Table 1-20	Calibration error codes	57
Table 2-1	Operating checklist	60

THIS PAGE HAS BEEN INTENTIONALLY LEFT BLANK.



# 1 Calibration Procedures

Calibration Overview	18
Recommended Test Equipment	20
Basic Operating Tests	21
Calibration Process	26
Test Considerations	26
Performance Verification Tests	27
Calibration Security	37
Unsecuring the Multimeter for Calibration	38
Using the Front Panel for Adjustments	45
Calibration Count	55
Calibration Error Codes	57

This chapter helps you to verify the multimeter performance and to make adjustments where necessary.

## Calibration Overview

This manual contains procedures to verify the U1281A/U1282A handheld digital multimeter performance and to perform adjustments (calibration). The performance test procedures allow you to verify that the multimeter is operating within its published specifications. The adjustment procedures ensure that the multimeter remains within its specifications until the next calibration.

### NOTE

Ensure that you have read the **“Test Considerations”** on page 26 before calibrating the multimeter.

---

### Closed-case calibration

The multimeter features closed-case electronic calibration. In other words, no internal mechanical adjustments are required. The multimeter calculates correction factors based upon the input reference value you set. The new correction factors are stored in the nonvolatile memory until the next calibration adjustment is performed. The nonvolatile EEPROM calibration memory is retained even when the power is switched off.

### Keysight calibration services

When your multimeter is due for calibration, contact your local Keysight Service Center to enquire about recalibration services.

### Calibration interval

A 1-year interval is adequate for most applications. Accuracy specifications are warranted only if adjustment is made at regular calibration intervals. A 1-year calibration cycle is suggested for operation at room temperature. The calibration cycle is 1.5 times of accuracy for 2 years except for capacitance, frequency, duty cycle and pulse width measurements, and square-wave output. Keysight does not recommend extending calibration intervals beyond 2 years for any application.

## Recommended adjustment

Specifications are only guaranteed within the period stated from the last adjustment. Keysight recommends that re-adjustment should be performed during the calibration process for best performance. This will ensure that the multimeter will remain within the specifications for the next calibration interval.

This criterion for the re-adjustment provides the best long-term stability. Performance data are measured during the “[Performance Verification Tests](#)” on page 27, but the multimeter is not guaranteed to remain within these limits unless the adjustments are performed.

See “[Calibration Count](#)” on page 55, and verify that all the adjustments have been performed.

## Recommended Test Equipment

The test equipment recommended for the performance verification and adjustment procedures are listed below (Table 1-1). If the exact instrument is not available, substitute with another calibration standard of equivalent accuracy.

A suggested alternative method is to use the Keysight 3458A 8½-Digit Digital Multimeter to measure less accurate but stable sources. The output value measured from the source can be entered into the multimeter as the target calibration value.

**Table 1-1** Recommended test equipment

Application	Recommended equipment	Recommended accuracy requirement
DC voltage	Fluke 5520A/5522A	<20% of the multimeter's 1-year specifications
AC voltage	Fluke 5520A/5522A	<20% of the multimeter's 1-year specifications
DC current	Fluke 5520A/5522A	<20% of the multimeter's 1-year specifications
AC current	Fluke 5520A/5522A	<20% of the multimeter's 1-year specifications
Capacitance	Fluke 5520A/5522A	<20% of the multimeter's 1-year specifications
Conductance	Fluke 5520A/5522A	<20% of the multimeter's 1-year specifications
Frequency	Fluke 5520A/5522A	<20% of the multimeter's 1-year specifications
Diode	Fluke 5520A/5522A	<20% of the multimeter's 1-year specifications
Resistance	Fluke 5520A/5522A	<20% of the multimeter's 1-year specifications
Frequency counter	Keysight 33522A	<20% of the multimeter's 1-year specifications
Duty cycle out	Fluke 5520A/5522A	<20% of the multimeter's 1-year specifications
Temperature	Fluke 5520A/5522A	<20% of the multimeter's 1-year specifications
	TM Electronics KMPC1MP (K-Type thermocouple extension)	—
Short	Pomona MDP-S	<20% of the multimeter's 1-year specifications

## Basic Operating Tests

The basic operating tests are used to test the basic operability of the multimeter. Repair is required if the multimeter fails the basic operating tests.

### Backlight test

Press  to test the backlight. It will momentarily turn the backlight on and off.

### Display test

Press  and turn on the multimeter by turning the rotary switch from **OFF** to any other position to view all annunciators of the display. Compare the display with the example in [Figure 1-1](#).

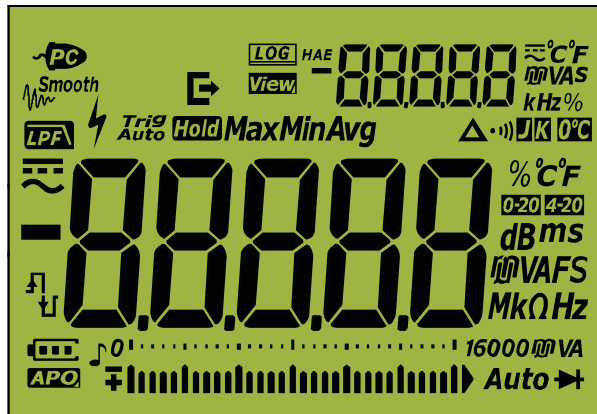

Figure 1-1 Display screen

## Input warning test (**A** terminal)

### NOTE

Before conducting this test, make sure the beep alert function is enabled in the setup mode.

---

This test determines if the input warning of the **A** current terminal test is functioning properly. The multimeter sounds an alerting beep when the test lead is inserted to the **A** input terminal but the rotary switch is not set to the corresponding **A** location. The display indicates a flashing **A-Err** annunciator until the test lead is removed from the **A** input terminal or until the rotary switch is set to the  $\overline{\text{A}}$  function.

Perform the following steps to replicate the **A** input terminal warning test:

- 1 Turn the rotary switch to the  $\overline{\text{V}}$  position.
- 2 Insert the red test lead to the **A** input terminal.
- 3 Insert the black test lead to the **COM** input terminal.



Figure 1-2 Example of A-Err for wrong terminal input

## Input warning test ( $\mu\cdot\text{mA}$ terminal)

### NOTE

Before conducting this test, make sure the beep alert function is enabled in the setup mode.

The multimeter sounds a continuous alert beep when the test lead is inserted into the  $\mu\cdot\text{mA}$  terminal but the rotary switch is not set to the  $\mu\cdot\text{mA}$  function. The multimeter displays an input warning error (Figure 1-3).

The alert beep tone will continue to beep until the test lead is removed from the  $\mu\cdot\text{mA}$  terminal or until the rotary switch is set to the  $\mu\cdot\text{mA}$  function.

Perform the following steps to replicate the  $\mu\cdot\text{mA}$  terminal input warning test:

- 1 Turn the rotary switch to the  $\sim\overline{\text{V}}$  position.
- 2 Insert the red test lead to the  $\mu\cdot\text{mA}$  input terminal.
- 3 Insert the black test lead to the **COM** input terminal.





Figure 1-3 Example of  $\mu\text{AErr}$  for wrong terminal input

## Calibration Process

- 1 Prior to performing the verification tests, see the “[Test Considerations](#)” on page 26.
- 2 Perform the verification tests to characterize the multimeter; see “[Performance Verification Tests](#)” on page 27.
- 3 Unsecure the multimeter for calibration; see “[Calibration Security](#)” on page 37.
- 4 Prior to performing the adjustments, see the “[Adjustment considerations](#)” on page 45.
- 5 Perform the adjustment procedure; see “[Adjustment procedure](#)” on page 53.
- 6 Secure the multimeter against unauthorized calibration; see “[Exiting the adjustment mode](#)” on page 54. Ensure that the multimeter has quit the adjustment mode and is turned off.
- 7 Record the new security code and calibration.

## Test Considerations

For optimum performance, all procedures should comply with the following recommendations:

- The performance verification test or adjustment should be performed under laboratory conditions where the ambient temperature can be controlled.
- The multimeter should be put under the laboratory environment for at least 1 hour.
- Ensure that the calibration ambient temperature is stable and is between 18 °C and 28 °C. Ideally the calibration should be performed at 23 °C ± 1 °C.
- Ensure that the ambient relative humidity is less than 80%.
- Allow a warm-up period of 5 minutes.
- Use a shielded twisted pair of PTFE-insulated cables to reduce settling and noise errors. Keep the input cables as short as possible. Long test leads can also act as antennas which may pick up AC signals.
- Connect the input cable shields to earth ground.

## Performance Verification Tests

Use the performance verification tests to verify the measurement performance of the multimeter. The performance verification tests use the multimeter's specifications listed in the *U1281A/U1282A Data Sheet* (available for download at <http://literature.cdn.keysight.com/litweb/pdf/5992-0847EN.pdf>).

The performance verification tests are recommended as acceptance tests when you first receive the multimeter. The acceptance test results should be compared against the 1-year test limits. After acceptance, you should repeat the performance verification tests at every calibration interval.

If the multimeter fails the performance verification tests, adjustment or repair is required.

### NOTE

Ensure that you have read the “**Test Considerations**” on page 26 before running the performance verification tests.

**Table 1-2** DC V (V) performance verification tests

Test function	Range	5520A/5522A output	Error from nominal 1 year	
			U1281A	U1282A
<b>DC V (V)</b> Turn the rotary switch to the  position.	6 V	6 V	±0.0020 V	±0.0020 V
	60 V	60 V	±0.020 V	±0.020 V
	600 V	600 V	±0.20 V	±0.20 V
	1000 V	1000 V	±0.75 V	±0.75 V

**Table 1-3** DC mV (mV) performance verification tests

Test function	Range	5520A/5522A output	Error from nominal 1 year	
			U1281A	U1282A
<b>DC mV (mV)</b>	60 mV <sup>[a]</sup>	60 mV	±0.040 mV	±0.040 mV
Turn the rotary switch to the  position.	600 mV <sup>[a]</sup>	600 mV	±0.20 mV	±0.20 mV

[a] The accuracy is specified after the Null function is used to subtract the thermal effect (by shorting the test leads) before measuring the signal.



**Table 1-4** AC V (V) performance verification tests

Test function	Range	5520A/5522A output	Error from nominal 1 year	
			U1281A	U1282A
	6 V	6 V, 20 Hz	±0.0660 V	±0.0660 V
		6 V, 45 Hz	±0.0205 V	±0.0205 V
		6 V, 1 kHz	±0.0205 V	±0.0205 V
		6 V, 3 kHz	±0.0445 V	±0.0445 V
		6 V, 10 kHz	±0.0445 V	±0.0445 V
		6 V, 20 kHz	±0.0960 V	±0.0960 V
	60 V	6 V, 100 kHz	N/A	±0.3160 V
		30 V, 20 Hz	±0.360 V	±0.360 V
		60 V, 45 Hz	±0.205 V	±0.205 V
		60 V, 1 kHz	±0.205 V	±0.205 V
		60 V, 3 kHz	±0.445 V	±0.445 V
		60 V, 10 kHz	±0.445 V	±0.445 V
	600 V	60 V, 20 kHz	±0.960 V	±0.960 V
		60 V, 100 kHz	N/A	±3.160 V
		30 V, 20 Hz	±0.90 V	±0.90 V
		600 V, 45 Hz	±2.05 V	±2.05 V
		600 V, 1 kHz	±2.05 V	±2.05 V
		600 V, 3 kHz	±4.45 V	±4.45 V
	1000 V	600 V, 10 kHz	±4.45 V	±4.45 V
		300 V, 20 kHz	±5.10 V	±5.10 V
		320 V, 30 kHz	±12.70 V	±12.70 V
		1000 V, 45 Hz	±5.5 V	±5.5 V
		1000 V, 1 kHz	±5.5 V	±5.5 V
		1000 V, 3 kHz	±9.5 V	±9.5 V
		1000 V, 10 kHz	±9.5 V	±9.5 V
		300 V, 20 kHz	±10.5 V	±10.5 V



**AC V (V)**

 Turn the rotary switch to the  position and press



**Table 1-5** AC mV (mV) performance verification tests

Test function	Range	5520A/5522A output	Error from nominal 1 year	
			U1281A	U1282A
<b>AC mV (mV)</b> Turn the rotary switch to the  position and press 	60 mV	60 mV, 20 Hz	±0.660 mV	±0.660 mV
		60 mV, 45 Hz	±0.205 mV	±0.205 mV
		60 mV, 1 kHz	±0.205 mV	±0.205 mV
		60 mV, 10 kHz	±0.445 mV	±0.445 mV
		60 mV, 20 kHz	±0.960 mV	±0.960 mV
	60 mV, 100 kHz	N/A	±3.160 mV	
	600 mV	600 mV, 20 Hz	±6.60 mV	±6.60 mV
		600 mV, 45 Hz	±2.05 mV	±2.05 mV
		600 mV, 1 kHz	±2.05 mV	±2.05 mV
		600 mV, 10 kHz	±4.45 mV	±4.45 mV
600 mV, 20 kHz		±9.60 mV	±9.60 mV	
600 mV, 100 kHz	N/A	±31.60 mV		

**Table 1-6** LPF performance verification test

Test function	Range	5520A/5522A output	Error from nominal 1 year	
			U1281A	U1282A
<b>LPF</b> While the rotary switch is in the  position, press 	6 V	3 V, 20 Hz	N/A	±0.0660 V

**Table 1-7** DC current ( $\mu\text{A}$ .mA) performance verification tests

Test function	Range	5520A/5522A output	Error from nominal 1 year	
			U1281A	U1282A
<b>DC current (<math>\mu\text{A}</math>.mA)</b> Turn the rotary switch to the  position.	600 $\mu\text{A}$	600 $\mu\text{A}$	$\pm 0.82 \mu\text{A}$	$\pm 0.82 \mu\text{A}$
	6 mA	6 mA	$\pm 0.0035 \text{ mA}$	$\pm 0.0035 \text{ mA}$
	60 mA <sup>[a]</sup>	60 mA	$\pm 0.080 \text{ mA}$	$\pm 0.080 \text{ mA}$
	600 mA <sup>[a]</sup>	440 mA	$\pm 0.71 \text{ mA}$	$\pm 0.71 \text{ mA}$

[a] Current can be measured from 30 mA to 440 mA continuously, and > 440 mA to 600 mA for 20 hours maximum. DC ranging from 60 mA to 440 mA have a thermal effect of 0.35  $\mu\text{A}/\text{mA}$ . Cool down the multimeter for 6 seconds if 100 mA is applied and at least 3 minutes if 600 mA is applied. Alternatively, use the Null () function to zero the thermal effect before proceeding with a low current measurement or checking the current offset.

**CAUTION**



Connect the calibrator outputs to the multimeter's A and COM terminals before applying 6 A and 10 A.

**Table 1-8** DC current (A) performance verification tests

Test function	Range	5520A/5522A output	Error from nominal 1 year	
			U1281A	U1282A
<b>DC current (A)</b> Turn the rotary switch to the  position.	6 A	6 A	$\pm 0.0100 \text{ A}$	$\pm 0.0100 \text{ A}$
	10 A <sup>[a]</sup>	10 A	$\pm 0.020 \text{ A}$	$\pm 0.020 \text{ A}$

[a] Current can be measured from 1 A to 10 A continuously, with an additional buffer of 0.3%. If the measurement of the signal is between 10 A to 20 A, current can be measured for 30 seconds maximum. After measuring > 10 A current, cool down the multimeter for twice the measuring time taken and use the Null () function to zero the thermal effect before proceeding for low current measurement.

**Table 1-9** AC current (A) performance verification tests



Test function	Range	5520A/5522A output	Error from nominal 1 year	
			U1281A	U1282A
<b>AC current (A)</b>  Turn the rotary switch to the  position and press  .  	6 A	0.3 A, 20 Hz <sup>[a]</sup>	±0.0070 A	±0.0070 A
		6 A, 45 Hz	±0.0385 A	±0.0385 A
		6 A, 1 kHz	±0.0385 A	±0.0385 A
		2.9 A, 5 kHz	±0.0465 A	±0.0465 A
	10 A <sup>[b]</sup>	1 A, 20 Hz <sup>[a]</sup>	±0.050 A	±0.050 A
		10 A, 45 Hz	±0.085 A	±0.085 A
		10 A, 1 kHz	±0.085 A	±0.085 A
		2.9 A, 5 kHz	±0.074 A	±0.074 A

[a] Input current is < 3A rms due to verification source.

[b] Current can be measured from 1 A to 10 A continuously, with an additional buffer of 0.3%. If the measurement of the signal is between 10 A to 20 A, current can be measured for 30 seconds maximum. After measuring > 10 A current, cool down the multimeter for twice the measuring time taken and use the Null () function to zero the thermal effect before proceeding for low current measurement.



**Table 1-10 AC current ( $\mu\text{A}$ .mA) performance verification tests**

Test function	Range	5520A/5522A output	Error from nominal 1 year	
			U1281A	U1282A
<b>AC current (<math>\mu\text{A}</math>.mA)</b> Turn the rotary switch to the  position and press  ." data-bbox="105 360 445 425"/>	600 $\mu\text{A}$	600 $\mu\text{A}$ , 20 Hz	$\pm 6.40 \mu\text{A}$	$\pm 6.40 \mu\text{A}$
		600 $\mu\text{A}$ , 45 Hz	$\pm 3.85 \mu\text{A}$	$\pm 3.85 \mu\text{A}$
		600 $\mu\text{A}$ , 1 kHz	$\pm 3.85 \mu\text{A}$	$\pm 3.85 \mu\text{A}$
	6 mA	6 mA, 20 Hz	$\pm 0.0640 \text{ mA}$	$\pm 0.0640 \text{ mA}$
		6 mA, 45 Hz	$\pm 0.0385 \text{ mA}$	$\pm 0.0385 \text{ mA}$
		6 mA, 1 kHz	$\pm 0.0385 \text{ mA}$	$\pm 0.0385 \text{ mA}$
	60 mA	60 mA, 20 Hz	$\pm 0.640 \text{ mA}$	$\pm 0.640 \text{ mA}$
		60 mA, 45 Hz	$\pm 0.385 \text{ mA}$	$\pm 0.385 \text{ mA}$
		60 mA, 1 kHz	$\pm 0.385 \text{ mA}$	$\pm 0.385 \text{ mA}$
	600 mA <sup>[a]</sup>	440 mA, 20 Hz	$\pm 4.80 \text{ mA}$	$\pm 4.80 \text{ mA}$
		440 mA, 45 Hz	$\pm 2.89 \text{ mA}$	$\pm 2.89 \text{ mA}$
		440 mA, 1 kHz	$\pm 2.89 \text{ mA}$	$\pm 2.89 \text{ mA}$

[a] Current can be measured from 30 mA to 440 mA continuously, and > 440 mA to 600 mA for 20 hours maximum. DC ranging from 60 mA to 440 mA have a thermal effect of  $0.35 \mu\text{A}/\text{mA}$ . Cool down the multimeter for 6 seconds if 100 mA is applied and at least 3 minutes if 600 mA is applied. Alternatively, use the Null () function to zero the thermal effect before proceeding with a low current measurement or checking the current offset.

**Table 1-11 Diode performance verification test**

Test function	Range	5520A/5522A output	Error from nominal 1 year	
			U1281A	U1282A
<b>Diode</b> Turn the rotary switch to the  <b>MHz</b> position.	3 V	1 V	$\pm 0.006 \text{ V}$	$\pm 0.006 \text{ V}$

**Table 1-12** Capacitance performance verification tests

Test function	Range	5520A/5522A output	Error from nominal 1 year	
			U1281A	U1282A
<b>Capacitance</b> Turn the rotary switch to the  position.	10 nF	10 nF	±0.105 nF	±0.105 nF
	100 nF	100 nF	±1.05 nF	±1.05 nF
	1 μF	1 μF	±0.0105 μF	±0.0105 μF
	10 μF	10 μF	±0.105 μF	±0.105 μF
	100 μF	100 μF	±1.05 μF	±1.05 μF
	1 mF	1 mF	±0.0105 mF	±0.0105 mF
	10 mF	10 mF	±0.105 mF	±0.105 mF
	100 mF	100 mF	±2.60 mF	±2.60 mF



**Table 1-13** Resistance performance verification tests

Test function	Range	5520A/5522A output	Error from nominal 1 year	
			U1281A	U1282A
<b>Resistance</b> Turn the rotary switch to the  position.	60 Ω <sup>[a][b]</sup>	60 Ω	N/A	±0.110 Ω
	600 Ω <sup>[a][b]</sup>	600 Ω	±0.40 Ω	±0.40 Ω
	6 kΩ <sup>[b]</sup>	6 kΩ	±0.0032 kΩ	±0.0032 kΩ
	60 kΩ <sup>[b]</sup>	60 kΩ	±0.032 kΩ	±0.032 kΩ
	600 kΩ	600 kΩ	±0.32 kΩ	±0.32 kΩ
	6 MΩ	6 MΩ	±0.0092 MΩ	±0.0092 MΩ
	60 MΩ	60 MΩ	±0.903 MΩ	±0.903 MΩ

[a] The accuracy is specified after the Null function is used to subtract the test lead resistance and thermal effect. Keep the multimeter away from heat and ensure it is well ventilated.



[b] With a 2-wire connection and compensation enabled at calibrator.

**Table 1-14** Conductance performance verification test



Test function	Range	5520A/5522A output	Error from nominal 1 year	
			U1281A	U1282A
<b>Conductance</b>				
Turn the rotary switch to the $\Omega$  position, then press  until the conductance measurement appears.	600 nS [a]	50 nS	±0.70 nS	±0.70 nS

[a] The accuracy is specified for < 60 nS after the Null function is used on an open test lead.



**Table 1-15** Frequency sensitivity performance verification test

Test function	Range	5520A/5522A output	Error from nominal 1 year	
			U1281A	U1282A
<b>Frequency sensitivity</b>				
While the rotary switch is in the  , press  .	99.999 Hz	90 Hz, 0.25 V	±0.021 Hz	±0.021 Hz



**Table 1-16** Duty cycle performance verification test

Test function	Range	5520A/5522A output	Error from nominal 1 year	
			U1281A	U1282A
<b>Duty cycle</b>				
While the rotary switch is in the  , press  until the measurements are displayed as percentages (%).	1 to 99 %	50 Hz at 50%, 6 Vpp	±0.315%	±0.315%

**Table 1-17** Temperature performance verification test

Test function	Range	5520A/5522A output	Error from nominal 1 year	
			U1281A	U1282A
<b>Temperature</b> <sup>[a]</sup>				
While the rotary is in the  position, press 	-200 °C to 1372 °C	0 °C	± 1°C	± 1°C
<p>[a] Set both calibrator and multimeter to internal reference.</p> <p>To perform the measurement, connect the K-type thermocouple extension (with miniature thermocouple connector on both ends) between the calibrator's TC output and multimeter via a TC-to-banana adapter.</p> <p>Allow at least 1 hour for the multimeter to stabilize before measurements are taken.</p> <p>The error limit does not include the error contributed by the thermocouple extension. To eliminate the thermocouple error, compensation of the calibrator output through a reference thermometer is recommended.</p> <p>Ensure that the ambient temperature is stable within ± 1°C. Make sure that the multimeter is placed in a controlled environment for at least 1 hour. Keep the multimeter away from any ventilation exit. Do not touch the thermocouple test lead after connecting it to the calibrator. Allow the connection to stabilize for at least another 15 minutes before performing the measurement.</p>				

**Table 1-18** Frequency counter performance verification test

Test function	Range	33522B output	Error from nominal 1 year	
			U1281A	U1282A
<b>Frequency counter</b>	9.9999 MHz	1 MHz, 200 mV	N/A	±0.0005 MHz
While the rotary switch is in the  <b>MHz</b> position, press 	99.999 MHz	20 MHz, 330 mV	N/A	±0.0054 MHz

## Calibration Security

The calibration security code prevents accidental or unauthorized adjustments to the multimeter. When you first receive your multimeter, it is secured.

Before you can adjust the multimeter, you must unsecure it by entering the correct security code. See [“Unsecuring the Multimeter for Calibration”](#) on page 38.

**NOTE**

**The security code can only be changed after the multimeter has been unsecured. You can unsecure the multimeter from its front panel.**

---

The security code is set to **1234** when the multimeter is shipped from the factory. The security code is stored in nonvolatile memory, and does not change when power has been turned off. The security code may contain up to four numeric characters.

## Unsecuring the Multimeter for Calibration



Before you can adjust the multimeter, you must unsecure it by entering the correct security code.

The default security code is set to **1234**.

**NOTE**





If you forget your security code, see **“To reset the calibration security code to its factory default”** on page 43.

To unsecure the multimeter

- 1 Press  and  together for more than 1 second during normal operation mode to enter unsecured mode.  
The calibration security code entry is shown on the display.





**Figure 1-4** Calibration security code entry display

- 2 Key in your security code.
  - Press  or  on  to move the cursor to the left or to the right.
  - Press  or  to increment or decrement the digit.

**NOTE**

Key in the default factory security code if you have reset the security code or if you are unsecuring your multimeter for the first time.

---

- 3 When completed, press  .
- If the correct security code is entered, **PASS** will appear briefly on the secondary display, after which the multimeter will enter the adjustment mode.
  - If the incorrect security code is entered, an error code will appear briefly on the secondary display, after which the multimeter will prompt you for the security code again.
- 4 Exit the unsecured mode by pressing  and  together to secure the multimeter again.

See [Figure 1-5](#) for the multimeter display.

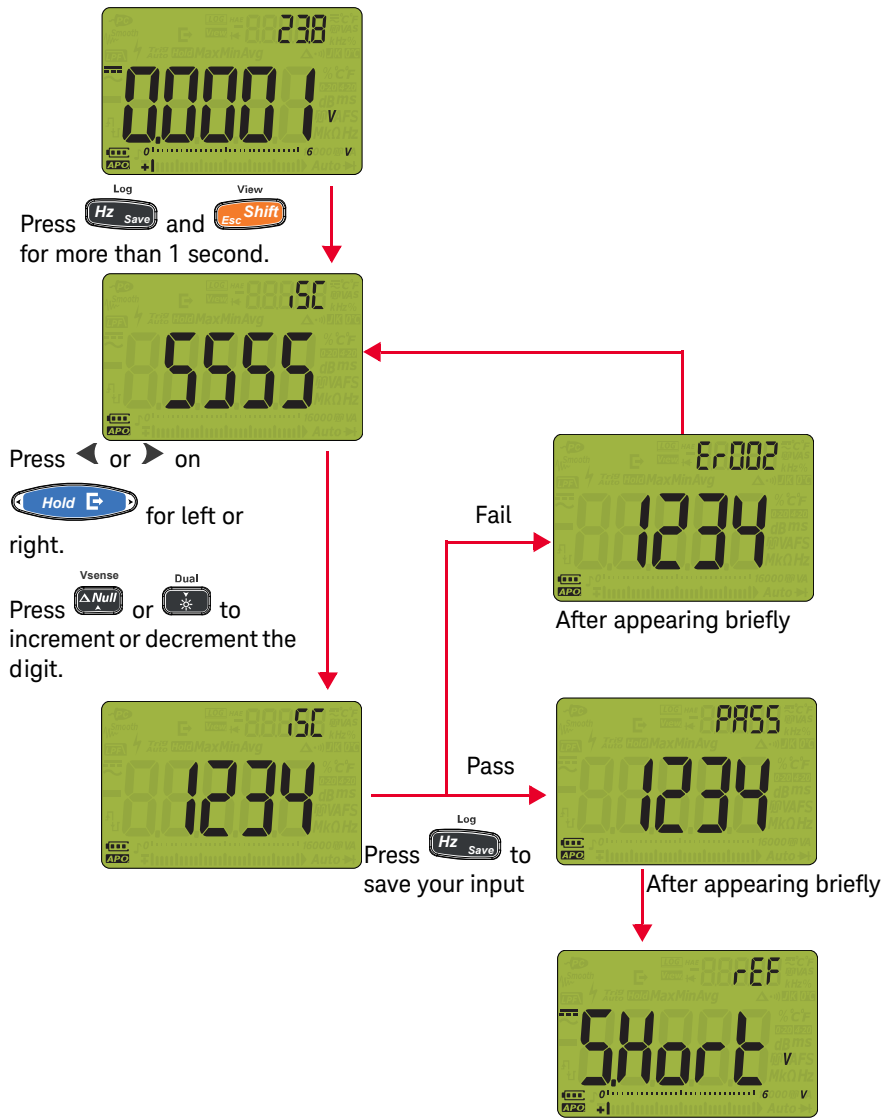







**Figure 1-5** Multimeter display when unsecuring the multimeter



## To change the calibration security code

This feature allows you to enter a security code to prevent accidental or unauthorized calibration of the meter. The meter will be secured automatically after power off. Ensure you unsecure the meter by entering the correct security code before you adjust or calibrate the multimeter.

- 1 Press  for more than 1 second after unsecuring the multimeter. The previously saved security code is shown on the display. If you are changing the calibration security code for the first time or if you have reset the security code to its factory default, **1234** is shown on the display
- 2 Set your new calibration security code by entering any four digits ranging from **0000** to **9999**.
  - Press  or  on  to move the cursor to the left or to the right.
  - Press  or  to increment or decrement the digit.
- 3 Press  to save the new calibration security code. If the new calibration security code has been successfully stored, the display will show **PASS**.
- 4 Record down your new calibration security code, and store it in a safe location. See [Figure 1-6](#) for the multimeter display.

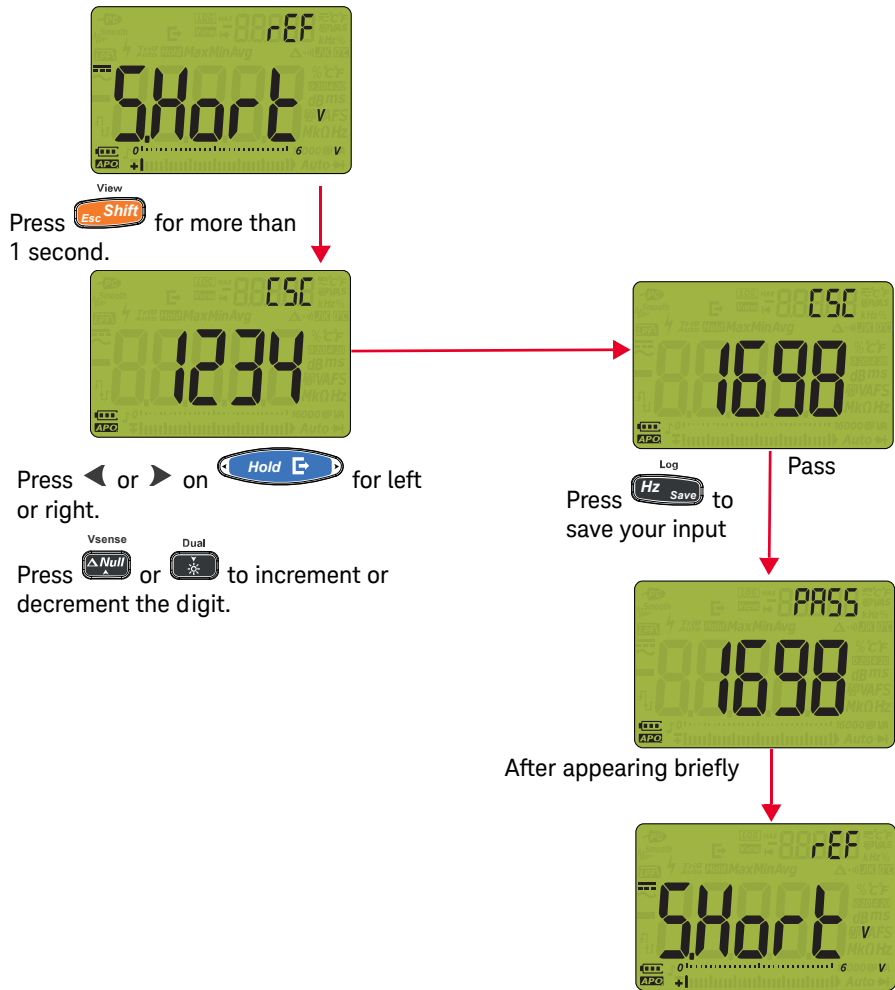

Figure 1-6 Multimeter display when changing the calibration security code









## To reset the calibration security code to its factory default

If you have forgotten the correct calibration security code, you may follow the steps below to reset the calibration security code to the factory default code

**1234.**

### NOTE

If you do not have a record (or have lost the record) of the security code, first try the factory default code, **1234**.

- 1 Note down the last four digits of the multimeter's serial number (located at the bottom of the rear panel) before you begin.
- 2 Press  and  together for more than 1 second during normal operation mode to enter unsecured mode. **dSC** and **5555** will be shown on the secondary and primary display.
- 3 Press  for more than 1 second to enter the Default Security Code (DSC) mode. **dSC** and **5555** will be shown on the secondary and primary display.
- 4 Enter the last four digits of the multimeter's serial number.
  - Press  or  on  to move the cursor to the left or to the right.
  - Press  or  to increment or decrement the digit.
- 5 Press  to confirm your entry.
  - If the four digits entered are correct, the display will show **PASS**. The calibration security code is now set to its factory default code, **1234**.
  - If the incorrect security code is entered, an error code will appear briefly, after which the multimeter will prompt you for the security code again.
  - To enter a new security code, see ["To change the calibration security code"](#) on page 41. Ensure that you record down the new security code.

See Figure 1-7 for the multimeter display.

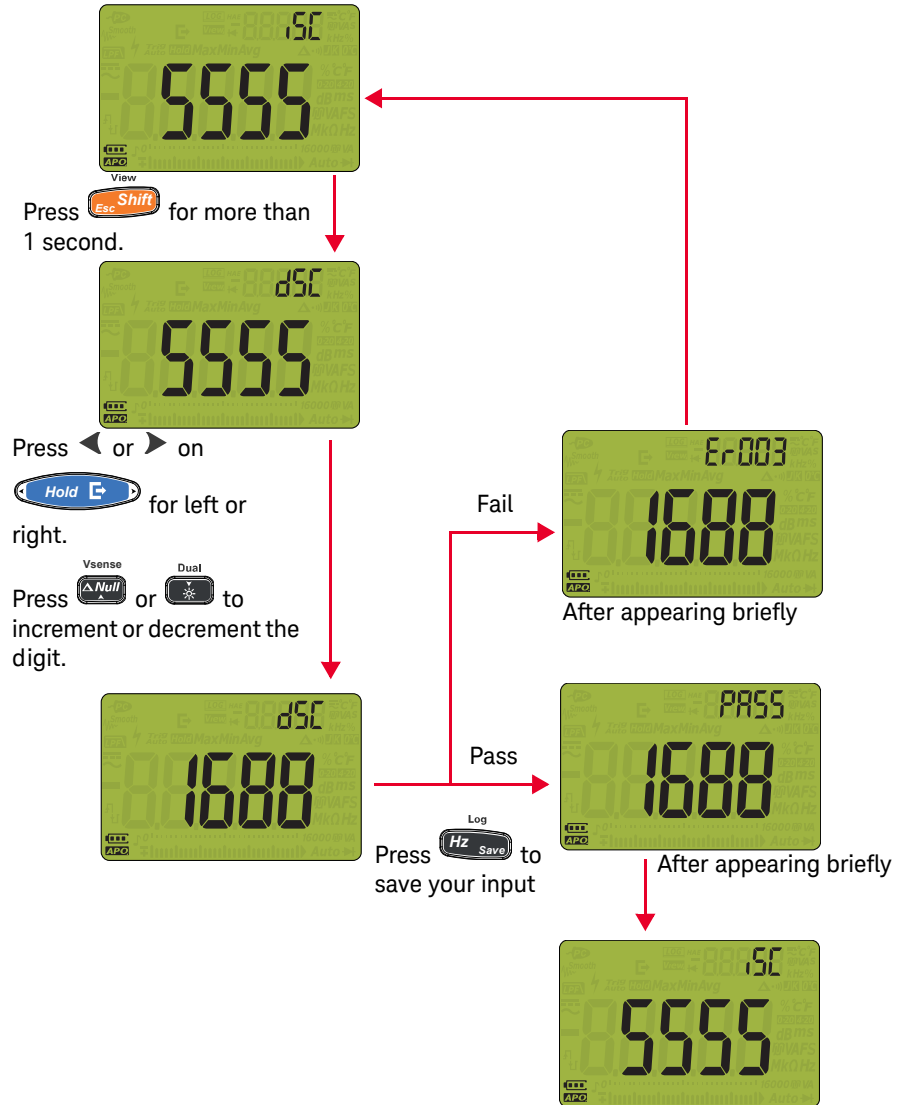

**Figure 1-7** Multimeter display when resetting the calibration security code to its factory default

## Using the Front Panel for Adjustments

This section describes the procedures to perform adjustments from the front panel.

To unsecure the multimeter, see “[To unsecure the multimeter](#)” on page 38. Once unsecured, the reference value will be indicated on the display.

### Adjustment considerations

- Use Fluke 5520A or an equivalent calibrator for the adjustment procedure.
- Ensure the battery capacity is greater than the indicated 60%.
- Ensure that the environmental temperature is  $23\text{ }^{\circ}\text{C} \pm 2\text{ }^{\circ}\text{C}$  and the relative humidity is  $< 50\%$ .
- Consider the thermal effects as you are connecting the test leads to the calibrator and multimeter. It is recommended to wait for 3 to 5 seconds before you begin the calibration after connecting the test leads.
- Calibrate the DC mV prior to ambient temperature calibration. Do not calibrate the DC mV immediately after a high current measurement or calibration.
- Turn on the multimeter for at least 1 hour with the Type-K thermocouple connected before proceeding with the ambient temperature adjustment.
- **Short** by connecting specified terminals of the multimeter with copper wires on banana plugs as short as possible.
- **oPEn** by removing all test leads from the terminals of the multimeter.

#### NOTE

After each adjustment, the display will show **PASS**. If the calibration fails, the multimeter will emit a beep, and an error number will be displayed. Calibration error messages are described in “[Calibration Error Codes](#)” on page 57.

#### CAUTION

Never turn off the multimeter during an adjustment. This may delete the calibration memory for the present function.

## Valid adjustment input values

Adjustment can be accomplished using the following input values.

**Table 1-19** Adjustment input values

Test function	Step	Reference value	Valid reference input
AC V	6.00 V	3.00 V (55 Hz)	0.9 to 1.1 x Reference value
		3.00 V (1 kHz)	0.9 to 1.1 x Reference value
		0.30 V (55 Hz)	Reference Value
		3.00 V (55 Hz)	0.9 to 1.1 x Reference value
		3.00 V (10 kHz)	0.9 to 1.1 x Reference value
	60.00 V	3.00 V (55 Hz)	Reference value
		30.00 V (55 Hz)	0.9 to 1.1 x Reference value
		30.00 V (1 kHz)	0.9 to 1.1 x Reference value
		30.00 V (10 kHz)	0.9 to 1.1 x Reference value
	600.00 V	30.00 V (55 Hz)	Reference value
		300.00 V (55 Hz)	0.9 to 1.1 x Reference value
		300.00 V (1 kHz)	0.9 to 1.1 x Reference value
		300.00 V (10 kHz)	0.9 to 1.1 x Reference value
	1000.00 V	30.00 V (55 Hz)	Reference value
		300.00 V (55 Hz)	0.9 to 1.1 x Reference value
		300.00 V (1 kHz)	0.9 to 1.1 x Reference value
		300.00 V (10 kHz)	0.9 to 1.1 x Reference value
	V <sub>sense</sub> <sup>[a]</sup>	Hi.10 V	10.00 V (55 Hz)
Lo.30 V		30.00 V (55 Hz)	Low Sense

**Table 1-19** Adjustment input values (continued)

Test function	Step	Reference value	Valid reference input
DC V	Short	SShort	Zero reference point
	6.00 V	3.00 V	0.9 to 1.1 x Reference value
	60.00 V	30.00 V	0.9 to 1.1 x Reference value
	600.00 V	300.00 V	0.9 to 1.1 x Reference value
	1000.00 V	300.00 V	0.9 to 1.1 x Reference value
	Short	SShort	Short V $\Omega$ / COM terminals
DC mV	Short	SShort	Zero reference point
	60.00 mV	30.00 mV	0.9 to 1.1 x Reference value
	600.00 mV	300.00 mV	0.9 to 1.1 x Reference value
	Short	SShort	Short V $\Omega$ / COM terminals
AC mV	60.00 mV	3.00 mV (55 Hz)	Reference value
		30.00 mV (55 Hz)	0.9 to 1.1 x Reference value
		60.00 mV (55 Hz)	0.9 to 1.1 x Reference value
		30.00 mV (1 kHz)	0.9 to 1.1 x Reference value
		30.00 mV (10 kHz)	0.9 to 1.1 x Reference value
	600.00 mV	30.00 mV (55 Hz)	Reference value
		300.00 mV (55 Hz)	0.9 to 1.1 x Reference value
		600.00 mV (55 Hz)	0.9 to 1.1 x Reference value
		300.00 mV (1 kHz)	0.9 to 1.1 x Reference value
		300.00 mV (10 kHz)	0.9 to 1.1 x Reference value
Temperature <sup>[b]</sup>	Type-K	0.0 °C	0.0 °C with ambient compensation

**Table 1-19** Adjustment input values (continued)

Test function	Step	Reference value	Valid reference input
Resistance	Short	SHort	Zero reference point
	60.00 M $\Omega$	oPEn	Open terminals
		10.00 M $\Omega$	0.9 to 1.1 x Reference value
	6.00 M $\Omega$	3.00 M $\Omega$	0.9 to 1.1 x Reference value
	600.00 k $\Omega$	300.00 k $\Omega$	0.9 to 1.1 x Reference value
	60.00 k $\Omega$	30.00 k $\Omega$	0.9 to 1.1 x Reference value
	6.00 k $\Omega$	3.00 k $\Omega$	0.9 to 1.1 x Reference value
	600.00 $\Omega$	300.00 $\Omega$	0.9 to 1.1 x Reference value
	60.00 $\Omega$	30.00 $\Omega$	0.9 to 1.1 x Reference value
	Short	SHort	Short V $\Omega$ / COM terminals



**Table 1-19** Adjustment input values (continued)

Test function	Step	Reference value	Valid reference input
Capacitance	Open	oPEn	Open terminals
	10.00 nF	3.00 nF	0.9 to 1.1 x Reference value
		10.00 nF	0.9 to 1.1 x Reference value
	100.00 nF	10.00 nF	0.9 to 1.1 x Reference value
		100.00 nF	0.9 to 1.1 x Reference value
	1.00 $\mu$ F	0.10 $\mu$ F	0.9 to 1.1 x Reference value
		1.00 $\mu$ F	0.9 to 1.1 x Reference value
	10.00 $\mu$ F	1.00 $\mu$ F	0.9 to 1.1 x Reference value
		10.00 $\mu$ F	0.9 to 1.1 x Reference value
	100.00 $\mu$ F	10.00 $\mu$ F	0.9 to 1.1 x Reference value
		100.00 $\mu$ F	0.9 to 1.1 x Reference value
	1.00 mF	0.10 mF	0.9 to 1.1 x Reference value
		1.00 mF	0.9 to 1.1 x Reference value
	10.00 mF	1.00 mF	0.9 to 1.1 x Reference value
10.00 mF		0.9 to 1.1 x Reference value	
100.00mF	1.00 mF	0.9 to 1.1 x Reference value	
	10.00 mF	0.9 to 1.1 x Reference value	
Diode	Short	SShort	Zero reference point
	3.10 V	2.00 V	0.9 to 1.1 x Reference value
	Short	SShort	Short V $\Omega$ / COM terminals
DC $\mu$ A/mA	Open	oPEn	Open terminals
	60.00 $\mu$ A	30.00 $\mu$ A	0.9 to 1.1 x Reference value
	600.00 $\mu$ A	300.00 $\mu$ A	0.9 to 1.1 x Reference value
	6.00 mA	3.00 mA	0.9 to 1.1 x Reference value
	60.00 mA	30.00 mA	0.9 to 1.1 x Reference value
	600.00 mA	300.00 mA	0.9 to 1.1 x Reference value

**Table 1-19** Adjustment input values (continued)

Test function	Step	Reference value	Valid reference input	
AC $\mu$ A/mA	60.00 $\mu$ A	30.00 $\mu$ A (55 Hz)	Reference value	
		60.00 $\mu$ A (55 Hz)	0.9 to 1.1 x Reference value	
	600.00 $\mu$ A	30.00 $\mu$ A (55 Hz)	Reference value	
		300.00 $\mu$ A (55 Hz)	0.9 to 1.1 x Reference value	
	6.00 mA	0.30 mA (55 Hz)	Reference value	
		3.00 mA (55 Hz)	0.9 to 1.1 x Reference value	
	60.00 mA	3.00 mA (55 Hz)	Reference value	
		30.00 mA (55 Hz)	0.9 to 1.1 x Reference value	
	600.00 mA	30.00 mA (55 Hz)	Reference value	
		300.00 mA (55 Hz)	0.9 to 1.1 x Reference value	
	DC A	Open	oPEn	Open terminals
		6.00 A	3.00 A	0.8 to 1.2 x Reference value
20.00 A		10.00 A	0.8 to 1.2 x Reference value	
AC A	6.00 A	0.30 A (55 Hz)	Reference value	
		3.00 A (55 Hz)	0.8 to 1.2 x Reference value	
	20.00 A	3.00 A (55 Hz)	Reference value	
		10.00 A (55 Hz)	0.8 to 1.2 x Reference value	

[a] The sensor for the Vsense (non-contact voltage) calibration is located on the top center of multimeter. Place the top area as close as possible to the standard signal source without any loads.

[b] – Set the 5520A to internal reference.



– Prior to performing adjustment, connect one end of the K-type thermocouple (with miniature TC connector on both ends) to the 5520A TC output, and the other end to a precision thermometer to verify that the source outputs the desired value. Adjust the source accordingly if necessary.

– To perform the adjustment, connect one end of the K-type thermocouple (with miniature TC connector on both ends) to the 5520A TC output, and the other end to the multimeter via a TC-to-banana adapter. Allow at least 1 hour for the multimeter to stabilize.

## Vsense (non-contact voltage) calibration

**NOTE**

- Ensure the multimeter is REMOVED from the holster prior to performing this calibration.
- Keep the multimeter away from fluorescent lights, dimmable lights, motors, and other electrical noise sources when running the tests. These electrical noise sources can invalidate the calibration.
- It may be necessary in **step 4** and **step 8** below to slightly adjust the position of the multimeter for maximum signal strength.

- 1 Turn rotary switch to  position with the **Hi . 10** shown on the display.
  - 2 Connect a dual open type banana plug into the output voltage terminals of the calibrator.
  - 3 Ensure the **EARTH** button of calibrator is on.
  - 4 Hold the multimeter so that the top of the multimeter is vertically and horizontally centered and in contact with the banana plug's Hi terminal.
  - 5 Set the source output to 10 V/55 Hz.
  - 6 Press  to start the calibration. If the calibration is successful, **Lo30** will be displayed.
  - 7 Set the source output to 30 V/55 Hz.
  - 8 Press  to start the calibration process.
  - 9 Set the calibrator to standby mode when the calibration is done.
- See **Figure 1-8** for the multimeter display.

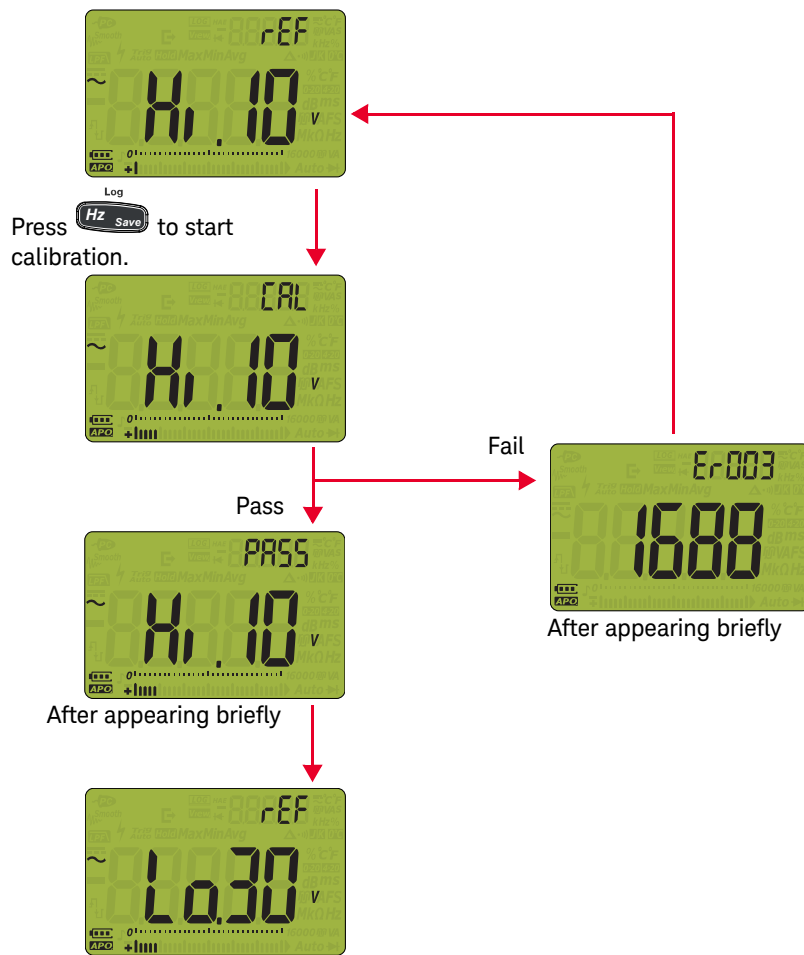



Figure 1-8 Multimeter display for Vsense (non-contact voltage) calibration

## Adjustment procedure

**NOTE**



Review the “**Test Considerations**” on page 26 and “**Adjustment considerations**” on page 45 before beginning the adjustment procedures.

- 1 Turn the rotary switch to the respective test function position as shown in [Table 1-19](#) detailing the adjustment input values.
- 2 Unsecure the multimeter to enter the adjustment mode. See “**Unsecuring the Multimeter for Calibration**” on page 38
- 3 Verify that the security code you entered is correct. If the security code you entered is correct, the multimeter will display the reference input value of the next calibration item. **PASS** will appear briefly on the secondary display. See [Table 1-19](#) for the list and sequence of all the calibration items.
- 4 Input the same value as reference value on primary display to the correct terminals. Then press  to start calibration.



**NOTE**

During the calibration period, the uncalibrated value is indicated on the primary display and bar graph with **CAL** indicated on the secondary display. The multimeter will automatically check whether or not to save the calibration value. If the calibration value passes the check, **PASS** will appear briefly on the secondary display and saved before moving on to the next step. If the value is out of the acceptable range, it will continue to display the current calibration value after an error code is indicated briefly.

- 5 Check whether the right standard value has been applied, or see “**Calibration Error Codes**” on page 57.
- 6 Repeat [step 4](#) and [step 5](#) until calibration is complete for all calibration values.
- 7 Press  or rotate the rotary switch to select other values to be calibrated. Repeat [step 6](#) and [step 8](#).

- 8 Press  and  together to exit calibration mode when all calibrations are completed. Alternatively, you can also power off and on the multimeter again. The multimeter will return to normal measurement mode and is secured.
- 9 Verify the adjustments using the [“Performance Verification Tests”](#) on page 27.

### Exiting the adjustment mode

- 1 Remove all the shorting plugs and connectors from the multimeter.
- 2 Record the new calibration count.
- 3 Press  and  together to exit calibration mode.
- 4 Cycle the multimeter's power. The multimeter will then be secured.

## Calibration Count

You can query the multimeter to determine how many adjustments have been performed.



### NOTE

The multimeter has been calibrated before it left the factory. You are recommended to record the initial value of the calibration count once you receive the multimeter.

The calibration count feature provides independent serial numbers of your calibrations. You can determine the number of times that your multimeter has been calibrated. By monitoring the calibration count, you can determine if an unauthorized calibration has been performed. The value is increased by one for each calibration.

The calibration count is stored in nonvolatile memory, and does not change on power on/off or after a remote interface reset. Your multimeter was calibrated before it left the factory. When you receive your multimeter, take note of the calibration counts as a record for maintenance.

The calibration count increases by one for each calibration point, from **0000** up to the maximum **65535**. Once the calibration count reaches **65535**, the calibration count will reset to **0000**. The calibration count can be read after the multimeter has been unsecured. The calibration count cannot be programmed or reset. It is an independent electronic calibration serial value.

- 1 Press  for more than 1 second in adjustment mode to view the calibration count.
- 2 Take note of the calibration count to keep track of the number of calibrations that have been performed.
- 3 Press  for more than 1 second to exit the calibration count mode.

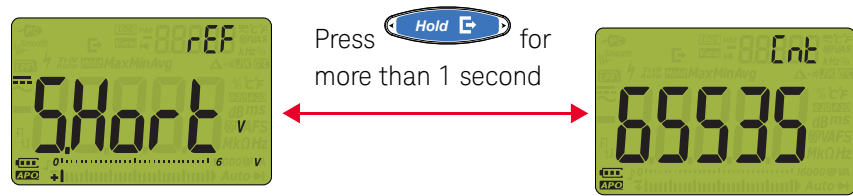

**Figure 1-9** Multimeter display for calibration count



## Calibration Error Codes

The following errors indicate failures that may occur during a calibration.

**Table 1-20** Calibration error codes

Error code	Description
200/E200	Calibration error: calibration mode is secured
002/E002	Calibration error: secure code invalid
003/E003	Calibration error: serial number code invalid
004/E004	Calibration error: calibration aborted
005/E005	Calibration error: value out of range
006/E006	Calibration error: signal measurement out of range
007/E007	Calibration error: frequency out of range
008/E008	EEPROM write failure

THIS PAGE HAS BEEN INTENTIONALLY LEFT BLANK.

## 2 Service and Maintenance

Troubleshooting	60
Fuse Replacement	61
Returning the Multimeter for Service	64
Replaceable Parts	65
Types of Service Available	66
Obtaining Repair Service (Worldwide)	67

This chapter will help you troubleshoot a failing multimeter. It also describes how to obtain repair services and lists the replaceable assemblies.

## Troubleshooting

### WARNING

To avoid electrical shock, do not perform any servicing unless you are qualified to do so.

### CAUTION

Any repair or service which is not covered in this manual should only be performed by qualified personnel.

If the multimeter fails to operate, check the batteries and the test leads. Replace them if necessary. If the multimeter still does not function, check the operating procedures in this manual. When servicing, use only the specified replacement parts.

The table below will assist you in identifying some basic malfunctions.

**Table 2-1** Operating checklist

Mal function	Identification
No display when powered ON using the rotary switch	– Verify the condition of the batteries and replace batteries as necessary.
No beeper tone	– Verify that the beeper is enabled in the multimeter's setup mode.
Failed on current measurement	– Verify the condition of the fuses and replace the fuses as necessary.
Failed on remote control	<ul style="list-style-type: none"> <li>– Verify the optical side of the IR-USB cable connected to the multimeter – the Keysight logo should be facing up.</li> <li>– Verify the baud rate, data bit, and parity settings in the multimeter's setup mode. (Default values are 9600, 8, and none.)</li> <li>– Verify the driver for the IR-USB interface.</li> </ul>

## Fuse Replacement

**NOTE**

No recalibration is required after replacing the fuse.

---

The current input terminals of your multimeter are fuse protected. The fuses are located next to the battery compartment.

- The  **$\mu\text{mA}$**  terminal is protected by a 10 x 35 mm 440 mA/1000 V 30 kA fast-acting fuse (Fuse 1).
- The **A** terminal is protected by a 10 x 38 mm 11 A/1000 V 30 kA fast-acting fuse (Fuse 2).

If you are certain that the fuse is faulty, replace it with one of the same size and rating.

**CAUTION**

Before you proceed with the fuse replacement, remove all cable connections to the terminals and ensure that the rotary switch is at the OFF position.

---

- 1 Remove the orange rubber holster. Pull a top corner to stretch the orange rubber holster off the multimeter.
- 2 Loosen and remove the two screws with a suitable Phillips screwdriver as shown on the right.

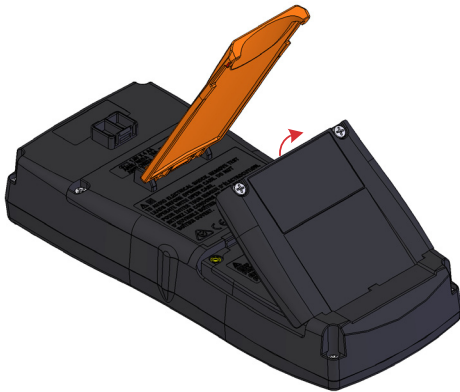
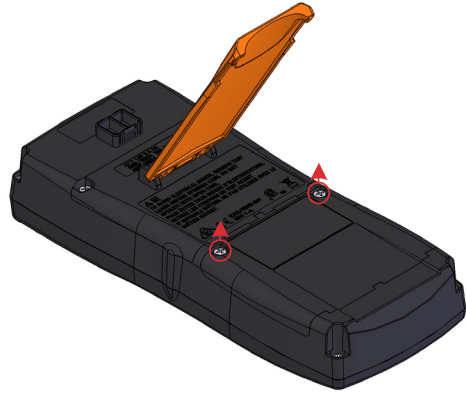

- 3 Lift and remove the fuse cover as shown on the left.

- 4 Lift the inner rubber cover to access the fuse compartment.
- 5 Remove the defective fuse gently by prying one end of the fuse with a flathead screwdriver and removing it out of the fuse bracket.
- 6 Replace a new fuse of the same size and rating at the center of the fuse holder.

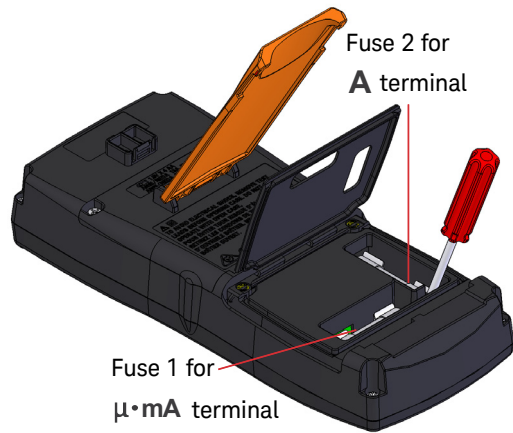

- 7 Ensure that the inner rubber cover is positioned properly.
- 8 Close the inner rubber cover of the fuse compartment.
- 9 Place the fuse cover back in its original position and tighten the screws.
- 10 Finally fit the orange rubber holster back on the multimeter.

## Returning the Multimeter for Service

Before shipping your multimeter for repair or replacement, Keysight recommends that you acquire the shipping instructions from the Keysight Service Center. A clear understanding of the shipping instructions is necessary to secure your product for shipment.

- 1** Attach a tag to the multimeter with the following information:
  - Name and address of owner
  - Multimeter model number
  - Multimeter serial number
  - Description of the service required or failure indications
- 2** Remove all accessories from the multimeter. Do not include accessories unless they are associated with the failure symptoms.
- 3** Place the multimeter in its original container with appropriate packaging material for shipping.

If the original shipping container is not available, place your unit in a container which will ensure at least 4 inches of compressible packaging material around all sides for the multimeter. Use static-free packaging materials to avoid additional damage to your unit.

**NOTE**

Keysight suggests that you always insure your shipments.

---



## Replaceable Parts

This section contains information for ordering replacement parts for your multimeter. You can find the multimeter support parts list at Keysight's Test & Measurement Parts Catalog: <http://www.keysight.com/find/parts>

The parts lists include a brief description of each part with its corresponding Keysight part number.

### To order replaceable parts

You can order replaceable parts from Keysight using the Keysight part number. Note that not all parts listed are available as field-replaceable parts.

To order replaceable parts from Keysight, do the following:

- 1** Contact your nearest Keysight Sales Office or Service Center.
- 2** Identify the parts by the Keysight part number shown in the support parts list.
- 3** Provide the multimeter model number and serial number.

## Types of Service Available

If your multimeter fails during the warranty period, Keysight will repair or replace it under the terms of your warranty. After your warranty expires, Keysight offers repair services at competitive prices.

### Extended service contracts

Many Keysight products are available with optional service contracts that extend the covered period after the standard warranty expires. If you have such a service contract and your multimeter fails during the covered period, Keysight will repair or replace it in accordance with the contract.

## Obtaining Repair Service (Worldwide)

To obtain service for your multimeter (in-warranty, under service contract, or post-warranty), contact your nearest Keysight Service Center. They will arrange to have your unit repaired or replaced, and can provide warranty or repair-cost information where applicable.

To obtain warranty, service, or technical support information you can contact Keysight using our Web link: [www.keysight.com/find/assist](http://www.keysight.com/find/assist)

Or contact your Keysight representative.

Before shipping your multimeter, request the Keysight Service Center to provide shipping instructions, including what components to ship. Keysight recommends that you retain the original shipping carton for use in such shipments.

THIS PAGE HAS BEEN INTENTIONALLY LEFT BLANK.



This information is subject to change without notice. Always refer to the English version at the Keysight website for the latest revision.

© Keysight Technologies 2016-2021  
Edition 7, July 2021

Printed in Malaysia



U1281-90002

[www.keysight.com](http://www.keysight.com)