

Test & Measurement

Crafted for optimum durability, reliability and functionality, our line of test and measurement equipment is engineered with the user in mind. Designed for, and by electricians, our electrical testers provide the latest in innovative, time-saving features that professionals require.

For Professionals...
Since 1857™



Clamp Meters

NEW!



TOUGH METER

True RMS Measurement Technology



Included:

- Carrying case
- Test leads with CAT III/CAT IV safety caps
- Thermocouple with adapter (temperature-measuring models only)
- Batteries

- CAT IV 600V, CAT III 1000V, Class 2, Double insulation safety rating.
- Built to withstand a 6.6' (2 m) drop.
- Meets requirements for use in basic and controlled electromagnetic environments like residential, office and light-industrial locations.

- The **CL600** is an auto-ranging TRMS digital clamp meter that measures AC current via the clamp, and measures AC/DC voltage, resistance, continuity, and tests diodes via test leads.
- The **CL700** is an auto-ranging TRMS digital clamp meter that measures AC current via the clamp, and measures AC/DC voltage, resistance, continuity, frequency, capacitance, and tests diodes via test leads, and temperature via a thermocouple probe. It also features a Low Impedance (LoZ) mode for identifying and eliminating ghost or stray voltages.
- The **CL800** is an auto-ranging TRMS digital clamp meter that measures AC/DC current via the clamp, and measures AC/DC voltage, resistance, continuity, frequency, capacitance, and tests diodes via test leads, and temperature via a thermocouple probe. It also features a Low Impedance (LoZ) mode for identifying and eliminating ghost or stray voltages.



Features	CL600	CL700	CL800
Durability			
Drop Protection	6.6 ft. (2 m)	6.6 ft. (2 m)	6.6 ft. (2 m)
Ingress Protection	IP40	IP40	IP40
Safety	CAT IV 600V	CAT IV 600V	CAT IV 600V
AC Voltage (Volts)	1000V	1000V	1000V
DC Voltage (Volts)	1000V	1000V	1000V
AC Current (Amps)	600A	600A	600A
DC Current (Amps)	—	—	600A
Ohms (Resistance)	60MΩ	60MΩ	60MΩ
AC Millivolts	—	—	—
DC Millivolts	•	•	•
True RMS	•	•	•
Audible Continuity	•	•	•
Backlight	•	•	•
Temperature	—	-14° – 1000°F (-26° – 538°C)	-14° – 1000°F (-26° – 538°C)
Low Impedance	—	•	•
Non-Contact Voltage Testing	•	•	•
Auto Ranging	•	•	•
Range Hold	•	•	•
Data Hold	•	•	•
Diode Test	•	•	•
Capacitance Test	—	6000 μF	6000 μF
Frequency / Duty Cycle	—	1Hz – 500 KHz	1Hz – 500 KHz
Max / Min	•	•	•
Magnetic Mount	Available As Accessory	Available As Accessory	Available As Accessory
Worklight	—	—	•
Auto-Power Off	•	•	•
LCD Display Count	6000	6000	6000

Specifications are subject to change.



See warning section for important safety information regarding clamp meters on page 201.

www.kleintools.com

See page 296 for additional information on warnings.



Clamp Meters

NEW!

Digital Clamp Meters



Included:

- Carrying case
- Test leads with CAT III/CAT IV safety caps
- Thermocouple (temperature-measuring models only)
- Batteries



- CAT III 600V, Class 2, Double insulation safety rating.
- Backlit display for clear readings.
- Low battery indicator and easily accessible battery compartment.
- Meets requirements for use in basic and controlled electromagnetic environments like residential, office and light-industrial locations.
- Built to withstand a 3.3 ft. (1 m) drop.

- The **CL110** is an auto-ranging digital clamp meter that measures AC current via the clamp, and AC/DC voltage, resistance and continuity via test leads.
- The **CL210** is an auto-ranging digital clamp meter that measures AC current via the clamp, AC/DC voltage, resistance and continuity via test leads, and temperature via a thermocouple probe.
- The **CL310** is an auto-ranging True Root-Mean-Squared (TRMS) digital clamp meter that measures AC current via the clamp, AC/DC voltage, resistance, continuity, frequency, capacitance, and tests diodes via test leads, and temperature via a thermocouple probe.



Features	CL110	CL210	CL310
Durability			
Drop Protection	3.3 ft. (1 m)	3.3 ft. (1 m)	3.3 ft. (1 m)
Ingress Protection	—	—	—
Safety	CAT III 600V	CAT III 600V	CAT III 600V
AC Voltage (Volts)	600V	600V	600V
DC Voltage (Volts)	600V	600V	600V
AC Current (Amps)	400A	400A	400A
DC Current (Amps)	—	—	—
Ohms (Resistance)	20MΩ	20MΩ	40MΩ
AC Millivolts	•	•	—
DC Millivolts	•	•	•
True RMS	—	—	•
Audible Continuity	•	•	•
Backlight	•	•	•
Temperature	—	-40° – 1832°F (-40° – 1000°C)	-40° – 1832°F (-40° – 1000°C)
Low Impedance	—	—	—
Non-Contact Voltage Testing	—	—	—
Auto Ranging	•	•	•
Range Hold	•	•	•
Data Hold	•	•	•
Diode Test	—	—	•
Capacitance Test	—	—	4000 μF
Frequency / Duty Cycle	—	—	10Hz – 1MHz
Max / Min	MAX only	MAX only	•
Magnetic Mount	—	—	—
Worklight	—	—	—
Auto-Power Off	•	•	•
LCD Display Count	2000	2000	4000

Specifications are subject to change.



See warning section for important safety information regarding clamp meters on page 201.

www.kleintools.com

See page 296 for additional information on warnings.

Clamp Meters

Electrical Maintenance & Test Kit

- Cat. No RT210 detects the most common wiring problems in standard and GFCI receptacles including open ground, reverse polarity, open hot, open neutral, and hot/ground reversed.
- Cat. No. 69409 Line splitter 10x allows the measuring of current draw up to 15A without splitting the load's power cord.
- CAT III 600V, Class 2, Double insulation safety rating.
- Cat. Nos. CL110 clamp meter and 69409 line splitter built to withstand a 3.3' (1 m) drop.
- Cat. No. CL110 features a backlit display for clear readings.
- RT210 withstands a 6.6' (2 m).
- Includes a carrying case, test leads and batteries.

NEW!



CL110KIT

Cat. No.	Kit Contains	Weight			
CL110KIT		15.1 oz. (428 g)			
Cat. No.	Batteries	Height	Width	Depth	Weight
CL110	3 x AAA	8.7" (221 mm)	3.02" (77 mm)	1.61" (41 mm)	10.1 oz. (285 grams)
RT210	N/A	2.875 (73 mm)	1.625 (41 mm)	1.875 (73 mm)	1.3 oz. (37 grams)
69409	N/A	4.67" (119 mm)	2.28" (58 mm)	1.0" (25.4 mm)	3.2 oz. (90.7 grams)
test leads	N/A	41" (1,041 mm)	N/A	N/A	3.2 oz. (90.7 grams)
carry case	N/A	9.5" (241 mm)	3.0" (76 mm)	2.0" (25 mm)	15.1 oz. (428 g)

See information about the CL110 clamp meter on previous page 200.

Clamp Meter Specifications

Cat. No.	CAT Rating	Batteries	Jaw Size	Height	Width	Depth	Weight	Included Accessories
CL110	CAT III 600 V	3 x AAA	1.125" (29 mm)	8.7" (221 mm)	3.02" (77 mm)	1.61" (41 mm)	10.1 oz. (285 grams)	Carrying case, test leads and batteries
CL210	CAT III 600 V	3 x AAA	1.125" (29 mm)	8.7" (221 mm)	3.02" (77 mm)	1.61" (41 mm)	10.1 oz. (285 grams)	Carrying pouch, test leads, thermocouple with adapter, and batteries
CL310	CAT III 600 V	3 x AAA	1.125" (29 mm)	8.7" (221 mm)	3.02" (77 mm)	1.61" (41 mm)	10.1 oz. (285 grams)	Carrying case, test leads, thermocouple with adapter, and batteries
CL600	CAT IV 600V	2 x AAA	1.375" (35 mm)	9.09" (231 mm)	3.82" (97 mm)	1.54" (39 mm)	11.8 oz. (335 grams)	Carrying case, test leads and batteries
CL700	CAT IV 600V	2 x AAA	1.375" (35 mm)	9.09" (231 mm)	3.82" (97 mm)	1.54" (39 mm)	11.8 oz. (335 grams)	Carrying case, test leads, thermocouple with adapter, and batteries
CL800	CAT IV 600V	2 x AAA	1.375" (35 mm)	9.09" (231 mm)	3.82" (97 mm)	1.54" (39 mm)	12.5 oz. (354 grams)	Carrying case, test leads, thermocouple with adapter, and batteries

⚠️ WARNINGS:

To ensure safe operation and service of the tester, follow these instructions. Failure to observe these warnings can result in severe injury or death.

- Before each use, verify meter operation by measuring a known voltage or current.
- Never use the meter on a circuit with voltages that exceed the category based rating of this meter.
- Do not use the meter during electrical storms or in wet weather.
- Do not use the meter or test leads if they appear to be damaged.
- Ensure meter leads are fully seated, and keep fingers away from the metal probe contacts when making measurements.
- Do not open the meter to replace batteries while the probes are connected.
- Use caution when working with voltages above 60V DC, or 25V AC RMS. Such voltages pose a shock hazard.
- To avoid false readings that can lead to electrical shock, replace batteries if a low battery indicator appears.
- Unless measuring voltage or current, shut off and lock out power before measuring resistance or capacitance.
- Always adhere to local and national safety codes. Use individual protective equipment to prevent shock and arc blast injury where hazardous live conductors are exposed.

All dimensions are in inches and (millimeters).



www.kleintools.com

See page 296 for additional information on warnings.



Specialty Clamp Meters

1000A AC/DC TRMS Clamp Meter (CL2500/CL2500N*)

- Extra wide jaw opening accommodates a greater measuring area.
- True RMS accurate readings for all signals.
- Worklight in jaw area.



200A AC Fork Meter (CL3200/CL3200N*)

- Extra large jaw opening accepts 3/0 wire.
- Short jaw depth for increased access in tight spaces.
- Worklight by jaw illuminates work space.



*A NIST certified product is guaranteed to have been specially tested to ensure its accuracy. NIST certified meters are special order (lead time: 7 business days). NIST certifications are good for one year from the date of calibration.



Features	CL2500/CL2500N* 1000A AC/DC	CL3200/ CL3200N* 200A AC Fork Meter
Durability		
Drop Protection	3.3 ft. (1 m)	3.3 ft. (1 m)
Ingress Protection	IP42	IP30
Safety	CAT IV 600V	CAT IV 600V
AC Voltage (Volts)	750A	750A
DC Voltage (Volts)	1000V	1000V
AC Current (Amps)	1000A	200A
DC Current (Amps)	1000A	—
Ohms (Resistance)	60MΩ	40MΩ
True RMS	•	—
Audible Continuity	•	•
Backlight	•	•
Low Impedance	—	•
Non-Contact Voltage Testing	•	•
Auto Ranging	—	•
Range Hold	•	•
Data Hold	•	•
Diode Test	•	—
Capacitance Test	6000μF	—
Frequency / Duty Cycle	•	—
Max / Min	•	—
Magnetic Mount	•	•
Worklight	•	•
Auto-Power Off	•	•
Bar Graph	•	•
LCD Display Count	6000	4000

Cat. No.	NIST certified	CAT Rating	Batteries	Jaw Size	Height	Width	Depth	Weight	Included Accessories
CL2500	—	CAT IV 600V	2 x AAA	1.97" (50 mm)	8.09" (205 mm)	2.56" (65 mm)	1.38" (35 mm)	13.6 oz. (386 g)	test leads, case and batteries
CL2500N*	yes	CAT IV 600V	2 x AAA	1.97" (50 mm)	8.09" (205 mm)	2.56" (65 mm)	1.38" (35 mm)	13.6 oz. (386 g)	test leads, case and batteries
CL3200	—	CAT IV 600V	2 x AAA	0.63" (16 mm)	7.06" (179 mm)	2.56" (65 mm)	1.34" (34 mm)	7.9 oz. (224 g)	test leads, case and batteries
CL3200N*	yes	CAT IV 600V	2 x AAA	0.63" (16 mm)	7.06" (179 mm)	2.56" (65 mm)	1.34" (34 mm)	7.9 oz. (224 g)	test leads, case and batteries

All dimensions are in inches and (millimeters).



See warning section for important safety information regarding clamp meters on page 201.

www.kleintools.com

See page 296 for additional information on warnings.



Multimeters

NEW!



TOUGH METER



Included:

- Carrying case
- Test leads with CAT III/CAT IV safety caps
- Alligator clips
- Thermocouple with adapter
- Batteries



- Backlit LCD display screen.
- CAT IV 600V safety rating.
- Built to withstand a 6.6' (2 m) drop.
- For use in basic and controlled electromagnetic environments like residential, office and light-industrial locations.
- Low battery indicator and easily accessible battery and fuse replacement compartment.

- The **MM600** is an auto-ranging digital multimeter that measures AC/DC voltage, AC/DC current, and resistance. It also measures temperature, capacitance, frequency, duty-cycle, tests diodes and continuity.
- The **MM700** is an auto-ranging True Root-Mean-Squared (TRMS) digital multimeter that measures AC/DC voltage, AC/DC current, and resistance. It also measures temperature, capacitance, frequency, duty-cycle, and tests diodes and continuity.



Features	MM600	MM700
Durability		
Drop Protection	6.6 ft. (2 m)	6.6 ft. (2 m)
Ingress Protection	IP42	IP42
Safety	CAT IV 600V	CAT IV 600V
AC Voltage (Volts)	1000V	1000V
DC Voltage (Volts)	1000V	1000V
AC Current (Amps)	10A	10A
DC Current (Amps)	10A	10A
Ohms (Resistance)	40MΩ	40MΩ
DC Millivolts	•	•
AC Milliamps	•	•
DC Milliamps	•	•
AC Microamps	•	•
DC Microamps	•	•
True RMS	—	•
Audible Continuity	•	•
Backlight	•	•
Temperature	0° – 1000°F (-18° – 538°C)	0° – 1500°F (-18° – 816°C)
Low Impedance	—	•
Auto Ranging	•	•
Range Hold	•	•
Data Hold	•	•
Diode Test	•	•
Capacitance Test	1000 μF	4000 μF
Frequency / Duty Cycle	1Hz – 500 KHz	1Hz – 500 KHz
Max / Min	•	•
Lead Warning	•	•
Bar Graph	—	•
Magnetic Mount	Available As Accessory	Available As Accessory
Auto-Power Off	•	•
Battery Test	—	—
LCD Display Count	4000	4000



Specifications are subject to change.



See warning section for important safety information regarding multimeters on page 205.

www.kleintools.com

See page 296 for additional information on warnings.

Multimeters

NEW!

Included:

- Test leads with CAT III/CAT IV safety caps
- Thermocouple with adapter (temperature-measuring models only)
- Batteries



- CAT III 600V safety rating.
 - Built to withstand a 3.3' (1 m) drop.
 - For use in basic and controlled electromagnetic environments like residential, business and light-industrial locations.
 - Low battery indicator and easily accessible battery compartment.
- The **MM300** is a manual-ranging digital multimeter that measures AC/DC voltage, DC current, and resistance. It also tests diodes and continuity, and has a battery test mode.
 - The **MM400** is an auto-ranging digital multimeter that measures AC/DC voltage, AC/DC current, and resistance. It also measures temperature, capacitance, frequency, duty-cycle, and tests diodes and continuity.



Features	MM300 Manual Ranging	MM400 Auto Ranging
Durability		
Drop Protection	3.3 ft. (1 m)	3.3 ft. (1 m)
Ingress Protection	—	—
Safety	CAT III 600V	CAT III 600V
AC Voltage (Volts)	600V	600V
DC Voltage (Volts)	600V	600V
AC Current (Amps)	—	10A
DC Current (Amps)	10A	10A
Ohms (Resistance)	20MΩ	40MΩ
DC Millivolts	•	•
AC Milliamps	—	•
DC Milliamps	•	•
AC Microamps	—	•
DC Microamps	•	•
True RMS	—	—
Audible Continuity	•	•
Backlight	—	•
Temperature	—	0° - 1000°F (-18° - 538°C)
Low Impedance	—	—
Auto Ranging	—	•
Range Hold	—	•
Data Hold	•	•
Diode Test	•	•
Capacitance Test	—	200 μF
Frequency / Duty Cycle	—	1Hz - 50 KHz
Max / Min	—	•
Lead Warning	—	—
Bar Graph	—	—
Magnetic Mount	Available As Accessory	Available As Accessory
Auto-Power Off	—	•
Battery Test	•	—
LCD Display Count	2000	4000

Specifications are subject to change.



See warning section for important safety information regarding multimeters on page 205.

www.kleintools.com

See page 296 for additional information on warnings.

Multimeters

Electrical Test Kit

- The MM300 multimeter was developed to withstand daily wear and tear on the job site, and has a safety rating of CAT III 600V, Class 2, Double insulation.
- The NCVT-1 has a bright green LED to indicate the tester is working; it changes to red and warning tones sound when voltage is detected.
- NCVT-1 has a digitally-controlled ON/OFF power button and auto power-off feature to conserve and extend battery life.
- Receptacle tester detects wiring configurations and indicates correct wiring, open ground, open hot, open neutral, hot/ground reversed; it does not indicate quality of ground, multiple hot wires, or a combination of defects.
- Includes visual and audible continuity indicators up to 25Ω.
- Includes test leads and batteries.



NEW!



Cat. No.	Kit Contains	Weight
69149		15.1 oz. (428 g)

Cat. No.	Batteries	Height	Width	Depth	Weight
MM300	2 x AAA	6" (152 mm)	3.07" (78 mm)	1.78" (45 mm)	8.1 oz. (230 grams)
NCVT-1	2 x AAA	5.5" (140 mm)	.72" (16 mm)	N/A	1.6 oz. (46 g)
receptacle tester	N/A	2.75 (70 mm)	1.5 (38 mm)	1" (25 mm)	1.3 oz. (37 grams)
test leads	N/A	41" (1,041 mm)	N/A	N/A	3.2 oz. (90.7 grams)

See information about the MM300 multimeter on page 204 and for the non-contact voltage tester on page 207.

Multimeter Replacement Fuses

NEW!



69033



69192

Cat. No.	For Use With	Fuse Type
69191	MM1000, MM1300, MM2000, MM2300, MM6000	F 11A / 1000V
69192	MM1000, MM1300, MM2000, MM2300, MM6000	F 440mA / 1000V
69193	MM100 Fuse Kit	F10A / 500V, F250mA / 250V
69194	MM200 Fuse Kit	F10A / 500V, F400mA / 250V

New Test and Measurement Instruments

69031	MM300	5x20 200MA 600V NEW!
69032	MM300, MM400	6x32 10A 600V NEW!
69033	MM400	5x20 500MA 600V NEW!
69034	MM600, MM700	10x38 10A 1000V NEW!
69035	MM600, MM700	6x32 500MA 1000V NEW!

Multimeter Specifications

Cat. No.	CAT Rating	Batteries	Height	Width	Depth	Weight	Included Accessories
MM300	CAT III 600V	2 x AAA	6" (152 mm)	3.07" (78 mm)	1.78" (45 mm)	8.1 oz. (230 grams)	Test leads and batteries NEW!
MM400	CAT III 600V	2 x AAA	6" (152 mm)	3.07" (78 mm)	1.78" (45 mm)	8.1 oz. (230 grams)	Test leads, batteries and thermocouple NEW!
MM600	CAT IV 600V	2 x AAA	7" (178 mm)	3.54" (90 mm)	2.1" (53 mm)	14.6 oz. (414 grams)	Carrying case, test leads, thermocouple, and batteries NEW!
MM700	CAT IV 600V	2 x AAA	7" (178 mm)	3.54" (90 mm)	2.1" (53 mm)	14.6 oz. (414 grams)	Carrying case, test leads, thermocouple, batteries, and alligator clips NEW!

⚠️ WARNINGS:

To ensure safe operation and service of the tester, follow these instructions. Failure to observe these warnings can result in severe injury or death.

- Before each use, verify meter operation by measuring a known voltage or current.
- Never use the meter on a circuit with voltages that exceed the category based rating of this meter.
- Do not use the meter during electrical storms or in wet weather.
- Do not use the meter or test leads if they appear to be damaged.
- Ensure meter leads are fully seated, and keep fingers away from the metal probe contacts when making measurements.
- Do not open the meter to replace batteries while the probes are connected.
- Use caution when working with voltages above 60V DC, or 25V AC RMS. Such voltages pose a shock hazard.
- To avoid false readings that can lead to electrical shock, replace batteries if a low battery indicator appears.
- Unless measuring voltage or current, shut off and lock out power before measuring resistance or capacitance.
- Always adhere to local and national safety codes. Use individual protective equipment to prevent shock and arc blast injury where hazardous live conductors are exposed.

All dimensions are in inches and (millimeters).



www.kleintools.com

See page 296 for additional information on warnings.



Electrical Testers

Electronic Voltage Testers

- Measures AC and DC voltage at nine common levels up to 600V.
- Bright LEDs indicate voltage reading without batteries installed.
- Low impedance input reduces possibility of ghost voltages.
- Permanently secured test leads are always there when they are needed.
- Molded lead holders are perfect for easy measurements of tamper-proof outlets.
- Probe wires with wear indicators built in.
- Vibration and sound alerts for dangerous voltage levels.
- Modern solid-state construction provides CAT IV 600V safety rating.
- Bright light illuminates work area.
- Audible continuity alerts at less than 270kΩ



ET200



Cat. No.	CAT Rating	Batteries	Height	Width	Depth	Weight
ET200	CAT IV 600V	3 x AAA	7.375" (187 mm)	2.375" (60 mm)	1.25" (32 mm)	8.1 oz. (230 g)

Digital Circuit Breaker Finder

- Quickly, accurately, and automatically find the corresponding circuit breaker of any standard 120V outlet.
- For use on powered circuits only.
- Does not require interruption of service.
- Bright green arrow and loud beep provide clear indication of correct breaker.
- Strong transmitter reaches distances up to 1000 ft. (305 m).
- Optional Circuit Breaker Finder Accessory Kit (Cat. No. 69411) refer to page 211: Find breakers of light fixtures and bare wires with light socket and alligator clip adapters.



ET300



Cat. No.	Batteries	Height	Width	Depth	Weight	
ET300	receiver	1 x 9V	6.00" (152 mm)	2.00" (50.8 mm)	0.90" (22.9 mm)	3.2 oz. (90.7 g)
	transmitter	N/A	2.80" (71.1 mm)	1.90" (48.3 mm)	1.20" (30.5 mm)	1.6 oz. (45.4 g)

All dimensions are in inches and (millimeters).



Electrical Testers

Non-Contact Voltage Testers (NCVT-1/NCVT-2)

- Non-contact detection of standard voltage (48-1000V AC) in cables, cords, circuit breakers, lighting fixtures, switches, outlets, and wires.
- High intensity, bright green LED indicates the tester is operational and aids in illuminating the workspace.
- Microprocessor controlled low-battery indicator.
- Digitally controlled ON/OFF power button.
- Auto Power-Off feature conserves and extends battery life.
- Lightweight, durable polycarbonate plastic resin construction with a convenient pocket-clip.
- 9.8 ft. (3 m) drop protection.
- CAT IV 1000V safety rating provides expanded operation and protection.
- Does NOT detect DC voltage.



NCVT-1



Additional Features for Dual Range NCVT-2

- Automatically detects and indicates low voltage (12 - 48 Volts AC) and standard voltage (48 - 1000 Volts AC), allowing broad applications.
- Non-contact detection of low-voltage in security, entertainment, communications, environmental control, and irrigation systems.



NCVT-2

Voltage Range	12 - 48 VOLTS AC (Low) NCVT-2 only	50 - 1000 VOLTS AC (Standard)
Audible	low-pitched pulsing beeping sound	high-pitched continuous beeping sound
Visual	blue LED turns off and red LED blinks (approximately 2x per second).	green LED turns off and red LED illuminates continuously.



Cat. No.	Voltage Range	Frequency Range	Pollution Degree	Batteries	Overall Length	Width	Height	Weight	Weight w/ Batteries
NCVT-1	50-1000 volts AC	50-500 Hz	2	2 x AAA	5.50" (140 mm)	0.72" (18 mm)	1.0" (25 mm)	0.8 oz. (23 g)	1.6 oz. (46 g)
NCVT-2	12-1000 volts AC	50-500 Hz	2	2 x AAA	5.50" (140 mm)	0.72" (18 mm)	1.0" (25 mm)	0.8 oz. (23 g)	1.6 oz. (46 g)

Non-Contact Voltage Tester with Flashlight (NCVT-3)

- Non-contact detection of voltage (12 – 1000V AC) in cables, cords, circuit breakers, light fixtures, switches, outlets and wires as well as voltage in security, entertainment, communications, environmental control and irrigation systems.
- The visual indicator of the presence of voltage is an LED bar graph – the higher the voltage sensed, or the closer to the voltage source, the more LEDs light up.
- Bright flashlight illuminates work area and may be used independent of NCVT.
- Auto Power-Off feature conserves and extends battery life.
- Lightweight, compact tool with pocket clip provides easy storage and quick access.
- IP67: Dustproof and waterproof.
- 6.6 ft. (2 m) drop protection.
- CAT IV 1000V safety rating.
- Does NOT detect DC voltage.



NCVT-3

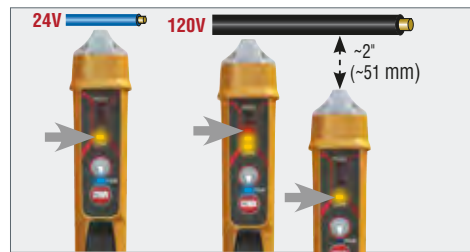

Cat. No.	Voltage Range	Frequency Range	Pollution Degree	Batteries	Overall Length	Width	Height	Weight	Weight w/ Batteries
NCVT-3	12-1000 Volts AC	50-500 Hz	2	2 x AAA	5.83" (148 mm)	0.72" (18 mm)	.96" (24 mm)	1.16 oz. (29 g)	2.5 oz. (72 g)

All dimensions are in inches and (millimeters).



Specialty Testers

12:1 Infrared Thermometer

- 12:1 spot ratio allows quick checks of all types of environments, hazardous extreme temperature ranges, or remote areas.
- Temperature range of -58 to 1000°F (-50 to 538°C).
- MAX, MIN, AVG, Differential calculations.
- Fahrenheit or Celsius.
- Backlit display.

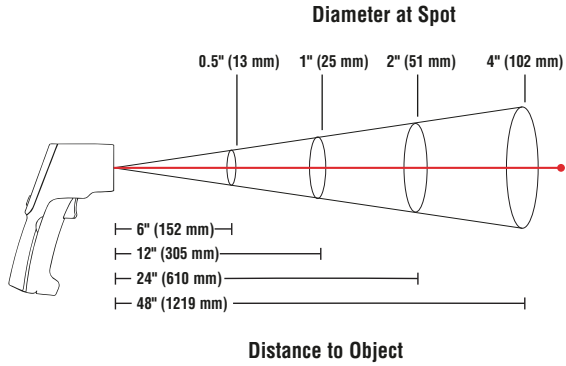

IR1000

Cat. No.	Batteries	Height	Width	Depth	Weight
IR1000	2 x AAA	7" (178 mm)	3.25" (83 mm)	1.74" (44 mm)	8.1 oz. (230 g)

12:1 Dual Laser Infrared Thermometer

- Dual lasers for specific measurement areas.
- Tight (12:1) distance-to-spot ratio for accurate target area temperature measurements.
- Features a wide temperature measurement range: -76° to 1022°F (-60° to 550°C).
- K-type thermocouple range: -83.2° to 2552°F (-64° to 1400°C).
- Auto-scan and Max / Min / Average / Differential calculations.
- Includes a temperature °F/°C button.
- Has both a backlit display and worklight.
- 6.6 feet (2 m) drop protection.
- Accessories included: case, K-type thermocouple and batteries

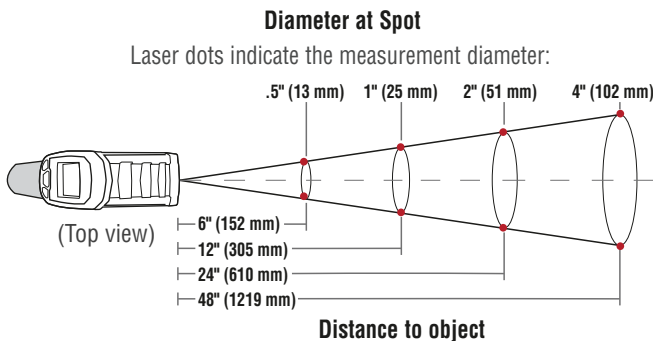
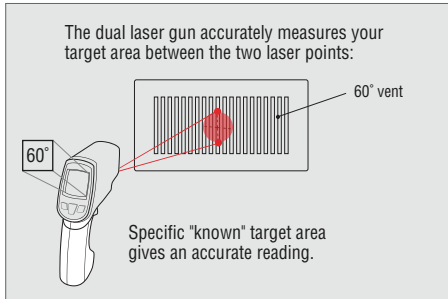

IR2000A

Cat. No.	Batteries	Height	Width	Depth	Weight
IR2000A	2 x AAA	6.76" (172 mm)	1.87" (48 mm)	4.7" (119 mm)	9.0 oz. (255 g)

All dimensions are in inches and (millimeters).



CAUTION: Reflective materials may be hotter than indicated. Laser radiation-Do NOT stare into beam. Class 2 laser product.

www.kleintools.com

See page 296 for additional information on warnings.

Specialty Testers

Video Borescope

- Use the Video Borescope to view inaccessible areas.
- It features video, audio, photo recording, file playback, a durable camera snake with an adjustable work light, and video output capabilities.
- Other features include screen rotation, adjustable LED worklight, TV-out and SD card.
- IP67: Dustproof and waterproof camera.

Package contents:

- Video Borescope • 17 mm gooseneck camera • Rechargeable lithium ion battery
- Mirror camera attachment • Hook camera attachment • Magnet camera attachment
- USB data & power adapter/charger • RCA composite to 3.5 mm mini A/V cable • Quick start guide
- Software/instruction manual CD-ROM • Carrying case



Multiple Applications!

- Electrical
 - HVAC
 - Plumbing
 - Automotive
 - Aircraft
- Use to view inaccessible areas:
 - Inside a wall
 - Down the drain
 - In furnace or vent

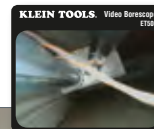

ET500

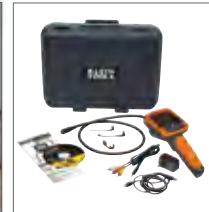

Cat. No.	Batteries	Height	Width	Depth	Weight
ET500	2 x AAA	7" (178 mm)	3.25" (83 mm)	1.74" (44 mm)	8.1 oz. (230 g)

Borescope

- Use the borescope to view inaccessible areas.
- It features a durable camera snake, a high resolution screen, mirror image and an adjustable LED work light.
- IP67: Dustproof and waterproof camera.



Multiple Applications!

- Electrical
 - HVAC
 - Plumbing
 - Automotive
 - Aircraft
- Use to view inaccessible areas:
 - Inside a wall
 - Down the drain
 - In furnace or vent

ET510

Package contents:

- Borescope • 17 mm gooseneck camera • Rechargeable lithium ion battery
- Mirror camera attachment • Hook camera attachment • Magnet camera attachment
- USB data adapter/charger • USB power adapter/charger • Instruction manual

Cat. No.	Batteries	Height	Width	Depth	Weight
ET510	lithium ion	6.53" (166 mm)	2.84" (72 mm)	1.55" (39 mm)	8.08 oz. (229 g)

All dimensions are in inches and (millimeters).



www.kleintools.com

See page 296 for additional information on warnings.



Electrical Testers

Receptacle Testers

- Light sequence indicates correct/incorrect wiring.
- Conforms to UL Std 1436, Certified to CSA Std C22.2 #160.
- Operating temp: 32°F to 140°F (0°C to 40°C).
- Built to withstand a 6.6 ft. (2m) drop.
- Nominal Voltage: 110/125V AC at 50/60Hz in 3-wire outlet.
- Designed to detect the most common wiring problems in standard receptacles.
- Cat. No. RT210 works on GFCI outlets and confirms operation of the ground fault.



Cat. No.	GFCI	Height	Width	Depth	Weight
RT110	no	2.875 (73 mm)	1.875 (73 mm)	1.625 (41 mm)	1.95 oz. (55 g)
RT210	yes	2.875 (73 mm)	1.875 (73 mm)	1.625 (41 mm)	1.97 oz. (56 g)

Continuity Tester



- Quickly reveals shorts or broken circuits in all types of electrical devices and controls.
- Tests for continuity of circuit with power off.
- Bulb in handle glows when circuit is complete (bulb included).
- Pointed 3-3/4" (95 mm) probe gets right to the problem.
- Deluxe 4" (102 mm) long handle with removable nylon cap holds replaceable bulb and battery.
- 36" (915 mm) test lead with alligator clip.
- Uses one AAA battery (not included).



Cat. No.	Overall Length	Weight (lbs.)
69133	probe to clip, 43-3/4" (1099 mm)	0.20 oz. (6 g)
Replacement Part		
69131	replacement bulb for Cat. No. 69133	0.04 oz. (1 g)

Low-Voltage Tester



- Device for checking live 6-24V, AC or DC circuits.
- Tests for shorts in automotive and truck electrical systems, motor field coils, radio and low-voltage circuits, ground circuits of all lamps, wiring, fuses, etc.
- Bulb in handle glows when circuit is complete (bulb included).
- Pointed 3-3/4" (95 mm) probe makes checking easier.
- Deluxe 3-1/2" (89 mm) long handle with nylon top holds replaceable bulb.
- 36" (915 mm) test lead with alligator clip.

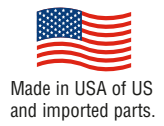

Cat. No.	Overall Length	Weight (lbs.)
69127	probe to clip, 43-1/4" (1099 mm)	0.20 oz. (6 g)
Replacement Part		
69130	replacement bulb for Cat. No. 69127	0.01 oz. (.3 g)

Circuit Tester

- Tests circuits rated from 80 to 600 Volts AC/DC.
- High-visibility neon lamp indicator.
- High-impact, sealed 5-11/16" (144 mm) probe on long 24" (610 mm) leads for convenience in testing motors, fuses, relays, switches, etc.
- Resistor between each probe and lead.

Cat. No.	Overall Length with Probes	Weight
69105	35" (889 mm)	2.4 oz. (68 g)

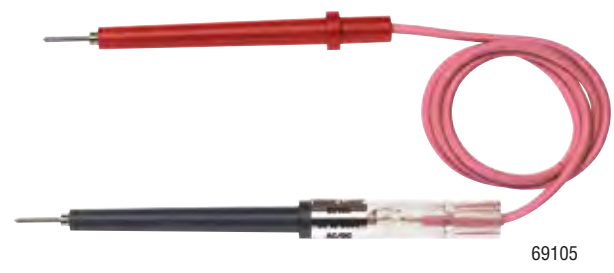

Low-Voltage Twin-Lead Tester

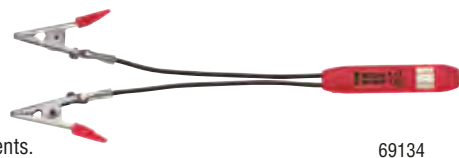

- Tests 5-50 Volts, AC or DC circuits and components.
- Built-in lamp glows if circuit is live.
- Each of the 4-1/2" (114 mm) test leads has an alligator clip on the end.
- Handy pocket clip.

Cat. No.	Overall Length	Weight
69134	8" (203 mm)	0.08 oz. (2g)

Test Lead Set



- Each lead has alligator clips attached to both ends.
- Multi-purpose tooth pattern for better gripping of wires and test points.

Cat. No.	Overall Length	Weight
69128	32" (813 mm)	6.4 oz. (181.4 g)

All dimensions are in inches and (millimeters).



WARNING: Do NOT use continuity tester for checking continuity on live circuits.

www.kleintools.com

See page 296 for additional information on warnings.

Electrical Testers

Circuit Breaker Finder Accessory Kit

- For use with ET300 Digital Circuit Breaker Finder refer to page 206.
- Light socket adapter for finding the corresponding circuit of a lighting fixture
- Alligator clip adapter enables use of Digital Circuit Breaker Finder on bare wires.



69411



Cat. No.	Description	Weight
69411	ET300 digital circuit breaker finder accessory kit	2.1 oz. (59.5 g)

Test & Measurement Line Accessories

Replacement Test Lead Sets

- Safety Rating: Category IV 600V and CAT III 1000V.
- Screw-on alligator clips attach to wires and other conductors.
- Intended for use as replacement test leads for meters that have standard, banana-type input jacks.
- Leads are 41" (1,041 mm) long.
- Cat. No. 69410 replacement test-lead set for MM300, MM400, MM600 and MM700.
- Cat. No. 69418 replacement test-lead set for CL110, CL210, CL310, CL600, CL700 and CL800.
- The leads perform accurately with Klein Tools' meters and other manufacture's meters.

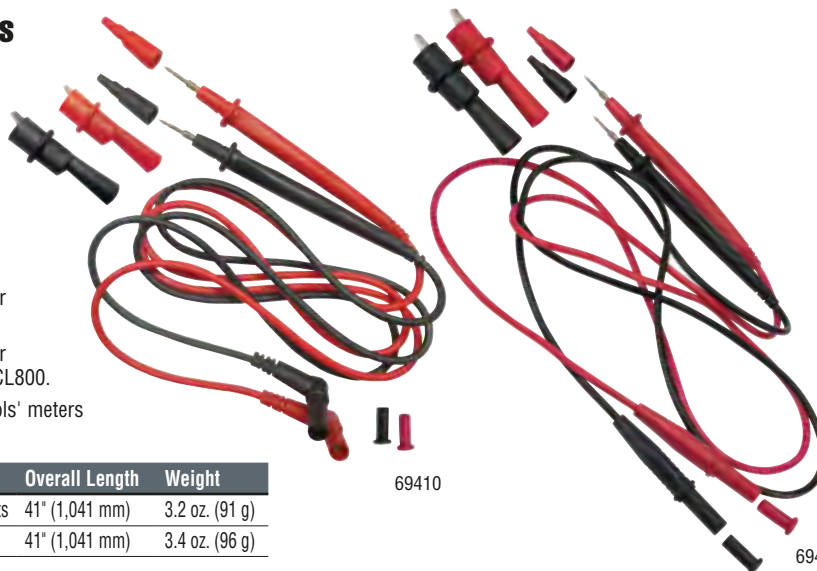

69410

69418

Cat. No.	Description	Overall Length	Weight
69410	replacement test lead set - right angle inputs	41" (1,041 mm)	3.2 oz. (91 g)
69418	replacement test lead set - straight inputs	41" (1,041 mm)	3.4 oz. (96 g)

Replacement K-Type Thermocouples

Features for 69028

- This UL® listed replacement thermocouple is for use Klein Tools multimeters and clamp meters list below.
- Temperature measurement range is 0-250° Celsius.
- Leads compatible with and fit lead storage compartments on most Klein meters.



69028

69413

69414

Cat. No.	Description	Multimeter	Clamp Meter	IR Gun	DTL	Weight
69028	K-type banana thermocouple	MM200, MM400, MM600, MM700, MM1000, MM1300, MM2000, MM2300, MM6000	CL200, CL210, CL310, CL700, CL800 CL1300, CL2300	—	—	0.7 oz. (20 g) NEW!
69413	K-type thermocouple	—	CL1100, CL2100	IR2000, IR2000A, IR3000	—	0.2 oz. (6 g)
69414	DTL K-type thermocouple	—	—	—	DTL302, DTL304	0.2 oz. (6 g)

All dimensions are in inches and (millimeters).



www.kleintools.com

See page 296 for additional information on warnings.

Test & Measurement Line Accessories

6 mm Borescope Camera

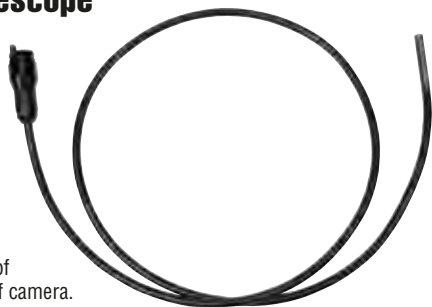

- IP67: Dustproof and waterproof camera.
- Bright LED worklight.
- Gooseneck design for greater control and positioning.
- Smaller footprint when penetrating walls and panels.

69450

Cat. No.	Dimensions	Weight
69450	6 mm x 1 m (0.24" x 3.3')	3.5 oz. (99 g)
69451	6 mm x 2 m (0.24" x 6.6')	5.5 oz. (156 g)

17 mm Borescope Camera



- IP67: Dustproof and waterproof camera.
- Bright LED worklight.
- Gooseneck design for greater control and positioning.

69454

Cat. No.	Dimensions	Weight
69454	17 mm x 1 m (0.67" x 3.3')	9.5 oz. (269 g)

1 Meter Borescope Camera Extension



69455

- Extends the reach of 17 mm and 6 mm borescope cameras.
- Up to two extensions may be used with 17 mm camera without loss of video quality 9.9 ft. (3 m).
- Maximum of four extensions plus camera.

Cat. No.	Dimensions	Weight
69455	17 mm x 1 m (0.67" x 3.3')	9.3 oz. (264 g)

Borescope Attachment Tools

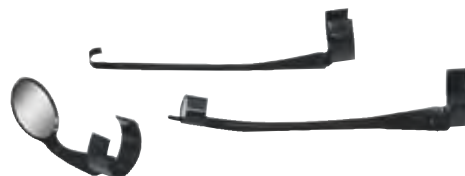

69457

- Compatible with 17 mm diameter camera.

Cat. No.	Set Contains	Weight
69457		0.4 oz. (11 g)
Descriptor	Overall Length	
mirror camera attachment	1.625" (44 mm)	
hook camera attachment	3.00" (76 mm)	
magnet camera attachment	3.25" (83 mm)	

Line Splitter 10x

- Allows the measuring of current draw up to 15A without splitting the load's power cord.
- For use with all Klein Tools clamp meters and other manufacture clamp meters.
- Can be used to perform voltage checks with standard multimeter probes.
- Provides 10X measurement mode.
- For North American-style outlets only.

⚠ WARNINGS:

- Do NOT use with loads greater than 15A.
- Risk of electric shock and burn. Contact with live circuits could result in death or serious injury.
- Do not use if line splitter appears damaged. If in doubt, replace line splitter. Do NOT use line splitter if wet. For indoors use only.

Cat. No.	Overall Length	Width	Weight
69409	4.67" (119 mm)	2.28" (58 mm)	3.9 oz.



NEW!



69409

All dimensions are in inches and (millimeters).



www.kleintools.com

See page 296 for additional information on warnings.

Test & Measurement Line Accessories

Magnetic Hangers

- Durable nylon weave resists wear and tear.
- Cat. No. 69147 for use with MM300, MM400, MM600, and MM700 multimeters, and CL600, CL700 and CL800 clamp meters.
- Constructed with powerful rare earth magnets.
- Has a secure loop & hook.
- Hanger allows the user to safely work hands-free.
- Cat. No. 69190 clips securely into back of rubber boot.

Cat. No.	Description	Weight
69147	magnetic hanger for electrician's multimeters and select clamps	1.1 oz. (31 g) NEW!
69190	magnetic hanger for electrician's previous generation multimeters	1.1 oz. (31 g)



Tradesman Pro™ Hard Cases

- Hard shell protects tools, meters, small parts and tech devices.
- Soft interior lining.
- Durable zipper closure.

Cat. No.	Width	Height	Depth	Weight
5184	6.5" (165 mm)	8.75" (222 mm)	2.25" (57 mm)	11 oz. (286 g)
5189	5.5" (140 mm)	10.25" (260 mm)	2.25" (57 mm)	11 oz (286 g)



Tradesman Pro™ Carrying Cases

- Two layers of padding protect even delicate instruments.
- Heavy-duty zipper and rugged PVC coated polyester for durability.
- Pockets for quick access and organization.
- Cat. No. 69406 has loop with snap closure to attach to belts, bags and backpacks.
- Cat. Nos. 69407 and 69408 have sturdy handle with box stitching for secure transportation and convenient hanging.
- Cat. Nos. 69406 and 69407 recommended for meters, testers, infrared guns, and small tools.
- Cat. No. 69408 recommended for meters, testers, infrared guns, tools, and borescopes.



Made in USA of US and imported parts.



Cat. No.	Pockets	Width	Height	Depth	Weight
69406	1	4.50" (114 mm)	9.25" (235 mm)	2.25" (57 mm)	6.24 oz. (177 g)
69407	2	6.00" (152 mm)	10.25" (260 mm)	2.25" (57 mm)	8.48 oz. (240 g)
69408	2	7.00" (178 mm)	10.25" (260 mm)	2.25" (57 mm)	10.56 oz. (299 g)

Carrying Case

- Constructed of black 600 Denier Nylon.
- Has a heavy-duty PVC zipper and zinc alloy zipper tag.
- The case has exceptional resistance to abrasions, punctures and tears.
- Easily fits the following Klein Tools test and measurement meters: MM300, MM400, MM600, MM700, CL110, CL210, CL310, CL600, CL700 and CL800.
- Convenient storage for CL100, CL200, CL1000, CL2000, CL3000, MM100, MM200, MM1000, MM2000, ET50, ET100 and ET200 test and measurement products.

Cat. No.	Width	Height	Depth	Weight
69401	4" (102 mm)	9-1/4" (235 mm)	2-1/4" (57 mm)	3.2 oz. (91 g)



All dimensions are in inches and (millimeters).



www.kleintools.com

See page 296 for additional information on warnings.



High Voltage Testers

NEW!



Detect a wide range of AC voltage in overhead conductors and cables.

Dual-Range High Voltage Non-Contact Tester

- Use to check for the presence of voltage in overhead conductors or find faults in cables.
- LOW range for 50V AC to 1.5kV AC.
- HIGH range for 1.5kV AC to 132kV AC.
- Includes durable carrying case.



HVNCVT-1

Visual signal indicates presence of voltage.



Cat. No.	Voltage Range	Length	Weight w/ batteries
HVNCVT-1	low: 50V AC – 1.5kV AC high: 1.5kV AC – 132kV AC	13.0" (330 mm)	0.66 lbs. (0.3 kg)

Broad-Range Non-Contact Tester

- Use to check for the presence of voltage in overhead conductors or to find faults in cables.
- 7 sensitivity ranges up to 230kV AC (240V, 4.2kV, 15kV, 25kV, 35kV, 69kV, 115kV, 230kV).
- Includes durable carrying case and universal/shotgun adapter.

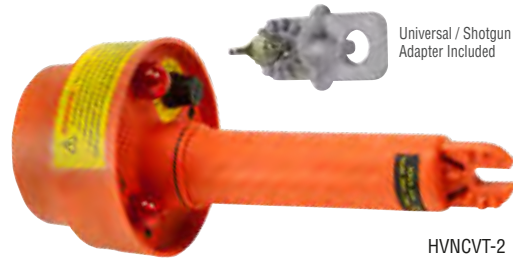

Universal / Shotgun Adapter Included

HVNCVT-2

Cat. No.	Voltage Range	Length	Weight w/ batteries
HVNCVT-2	up to 230kV AC	10.4" (264 mm)	1.37 lbs. (0.62 kg)

Broad-Range Contact Tester

- Contact tester indicates the presence of voltage in overhead conductors 5kV AC to 36kV AC.
- Includes durable carrying case.



HVCT-1

Cat. No.	Voltage Range	Length	Weight w/ batteries
HVCT-1	5kV AC – 36kV AC	9.7" (246 mm)	0.68 lbs. (0.31 kg)

Fiberglass Telescoping Handle

- Used for checking voltage up to 1,000V AC.
- Connects to the hot stick end of the High-Voltage Contact Tester (Cat. No. HVCT-1).
- Dielectric pole type-tested & rated for 10kV AC.
- Comes in a convenient zippered case.



HV-43

Cat. No.	Voltage Range	Length	Weight w/ batteries
HV-43	up to 1,000V AC	12.5" – 44.5" (318 – 1130 mm)	0.73 lbs. (.33 kg)

All dimensions are in inches and (millimeters).



www.kleintools.com

See page 296 for additional information on warnings.

