

# DPM 970

## Digital AC Voltmeter Module

A 3 1/2 digit LCD panel meter, featuring 19mm (0.75") digit height and LED backlighting, the DPM 970 is a true RMS voltage and current meter with 500V a.c. (2kV<sup>2</sup>) and 2mA full scale readings as standard. By changing the value of scaling resistors or adding a shunt, this module will measure most a.c. voltages and currents. The DPM 970 features digital hold function which freezes the last displayed reading. Calibration is achieved via two multi-turn potentiometers for offset and scale. Connection to the meter is via screw terminals. The module is housed in a robust carrier which can be bolted in place or panel mounted using the bezel, window and clips provided.

- 🔌 19mm (0.75") Digit Height
- 🔌 Screw Terminal Connections
- 🔌 Digital Hold
- 🔌 500V a.c. (2kV<sup>2</sup>) Full Scale Reading
- 🔌 Measures Voltage and Current
- 🔌 LED Backlighting



### SCALING

To change the full scale reading (F.S.R) of the meter, use the resistor values and PL10 configuration as detailed in the table below. To ensure that the meter reads "000" with zero input voltage/current, short circuit ACV and COM and adjust the ZERO potentiometer. The meter will need recalibration by adjusting the CAL potentiometer.

- Option 1 = Make PL10 pins 2 & 3
- Option 2 = Make PL10 pins 1 & 2

Required F.S.R	RA1	RA2	RB1	PL10	
200mV	①	0R	0R	Not Fitted	Option 1
2V	①	390k	220k	330k	Option 2
20V	①	680k	390k	39k	Option 2
200V	①	560k	560k	3k9	Option 2
2kV (factory default)	① ②	560k	560k	390R	Option 2
2mA	③	-	-	100R	Option 1
20mA	③	-	-	10R	Option 1
200mA	③	-	-	1R	Option 1
2A	③ ④	-	-	0R1	Option 1
20A	③ ④	-	-	0R01	Option 1

- NOTES
- ① Use inputs ACV and COM for measuring voltage.
  - ② For measuring voltages above 500V<sub>RMS</sub> external scaling resistor must be used.
  - ③ Use inputs ACI and COM for measuring current.
  - ④ When measuring in excess of 200mA use an external scaling resistor fitted between the terminals of ACI and COM. We recommend the use of a current transformer when measuring in excess of 10 Amps.

Consult the current transformer manufacturer's data for connections and recommendations. Other scaling factors can be achieved via the correct selection of scaling resistor values.

Standard Meter	Stock Number DPM 970			
Specification	Min.	Typ.	Max.	Unit
Accuracy (overall error) *		0.5	1.5	% (±2 count)
Full scale reading **	0		1999	V <sub>RMS</sub>
Resolution		1		V <sub>RMS</sub>
Sample rate		3		samples/sec
Operating temperature range	0		50	°C
Temperature stability		200		ppm/°C
Frequency range (input voltage)	15		15k	Hz
Input impedance (2kV range)		1		MΩ
DC Supply voltage	7.5	9	14	V d.c.
Supply current (Backlighting off)		1.5		mA d.c.
Supply current (Backlighting on) @ 5Vd.c.		50		mA d.c.

- \* To ensure maximum accuracy, re-calibrate periodically.
- \*\* Maximum safe input voltage across the ACV and COM terminals is 500V<sub>RMS</sub>. If voltages to be measured exceed 500V<sub>RMS</sub>, then fit scaling resistors externally to the module.

### DIMENSIONS All dimensions in mm (inches)

Panel cut-out 72 x 40 (2.83 x 1.57)  
Maximum panel thickness 3mm (0.12).

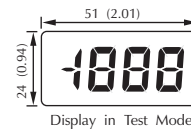
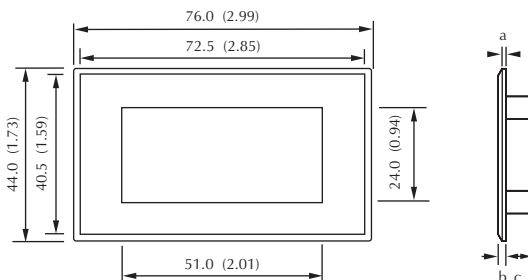

- a. 1.0 (0.04)
- b. 2.0 (0.08)
- c. 6.5 (0.26)
- d. 11.5 (0.45)
- e. 12.5 (0.49)\*

\*typical depth of tallest component behind PCB, this dimension is for guidance only.

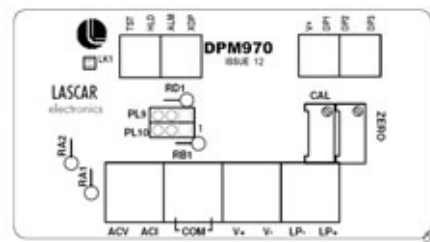
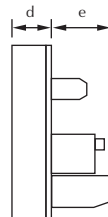
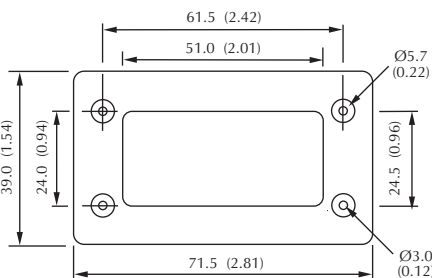

## SCREW TERMINAL FUNCTIONS

- ACV Alternating voltage measurement input, accepts up to 500V a.c. By changing the values of scaling resistors RA1, RA2 and RB1, other voltage and current ranges can be achieved. To measure in excess of 500V a.c., remove RA1, RA2 and RB1 from the meter and fit an external divider that will output 700mV for a 2kV input, e.g. series resistor 1.12 MΩ shunt resistor 390R, link RA1 and RA2 on the meter. See scaling table for suitable values for RA1, RA2 and RB1.
- ACI Alternating current measurement input.  
See Scaling table for suitable values for shunt resistor RB1.
- COM Return line for voltage measurement input (ACV) or current measurement (ACI) input.
- COM Return line for voltage measurement input (ACV) or current measurement (ACI) input.
- V+ Positive power supply input.
- V- Negative power supply input.
- LP- Negative supply for LED backlighting.
- LP+ Positive supply for LED backlighting.
  
- TST Connect to V+ to display all segments except decimal points and annunciators.  
It should not be operated for more than a few seconds as the DC voltage applied to the LCD may "burn" the display. This connection is normally at 5V below V+ and is the ground for the digital section of the meter.
- HLD Digital Hold option. Connect to V+ to hold last displayed reading indefinitely.
- ALM Alarm "!" annunciator. Connect to XDP to display.
- XDP Annunciator drive waveform. Used to drive alarm annunciator (ALM) if required.
  
- V+ Auxilliary V+ for connections to decimal points DP1, DP2 or DP3.
- DP1 199.9 Connect to V+ to display required decimal point.
- DP2 19.99 Connect to V+ to display required decimal point.
- DP3 1.999 Connect to V+ to display required decimal point.

## ⚠ SAFETY WARNING ⚠

To comply with the Low Voltage Directive (LVD 93/68/EEC), input voltages to the module's connectors must not exceed 500VRMS. If voltages to be measured exceed 500VRMS, then fit scaling resistors externally to the module. If the mains power supply is connected to the module, then all the module's connectors must be considered to be floating at mains potential. Consequently due caution must be exercised when connecting to the module's connector functions under these conditions. The user must ensure that the incorporation of the DPM into the user's equipment conforms to the relevant sections of BS EN 61010 (Safety Requirements for Electrical Equipment for Measuring, Control and Laboratory Use).

### APPLICATIONS

**WARNING : Do not apply in excess of 500V a.c. to the meter.**

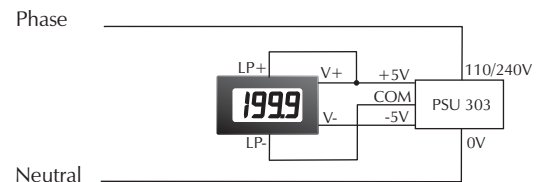
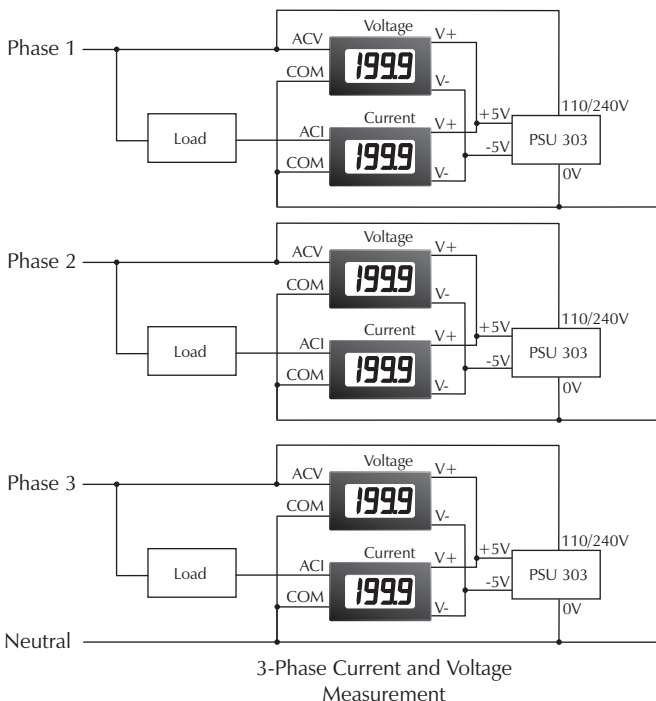

Powering the LED backlighting on a DPM 970 from the PSU 303's +5V and COM outputs.

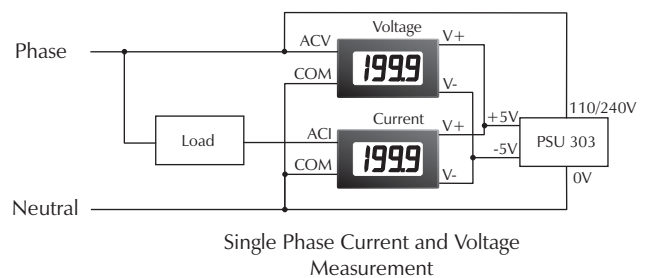

Single Phase Current and Voltage Measurement

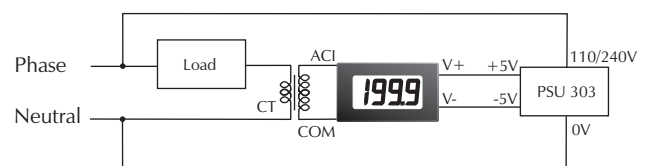

Using a current transformer (CT) to measure currents in excess of 10A a.c.