

T3AFG200/T3AFG350/T3AFG500 Data Sheet

Function/Arbitrary Waveform Generators

Debug with Confidence

200 MHz – 500 MHz

Teledyne Test Tools T3AFG200 / T3AFG350 / T3AFG500 range of function/arbitrary generators are a series of dual-channel waveform generators with specifications of up to 500 MHz maximum bandwidth, 2.4 GSa/s maximum sampling rate and 16-bit vertical resolution. The proprietary Arbitrary & Pulse techniques used in the T3AFG200 / T3AFG350 / T3AFG500 models helps to solve the weaknesses inherent in traditional DDS generators when generating arbitrary, square and pulse waveforms. With the above advantages the T3AFG200 / T3AFG350 / T3AFG500 generators can provide users with a variety of high fidelity and low jitter signals, which can meet the growing requirements of a wide range of complex applications.



Tools for Improved Debugging

- | | |
|---|---|
| ● Deep Memory – 20 Mpts/Ch. | ✓ Generate complex arbitrary waveforms. |
| ● Wide Range of Modulation Types – AM, DSB-AM, FM, PM, FSK, ASK, PWM, Sweep, Burst, and PSK. | ✓ Quickly set up modulated waveforms. |
| ● High Resolution – 16 bit resolution. | ✓ Generate waveforms with low noise, low spurious signal content and high dynamic range. |
| ● Bandwidth Models up to 500 MHz. | ✓ Wide choice of bandwidths. |
| ● Built In Arbitrary Waveforms. | ✓ Load and replay built in Arbitrary Waveforms. |
| ● PRBS, I/Q and user Defined Waveform capability. | ✓ Support for complex applications. |
| ● Single and dual channel models also available, starting from 5 MHz. | ✓ Enquire about the T3AFG5, T3AFG10, T3AFG40, T3AFG80 and T3AFG3120. |

Key Specifications

Bandwidth	200 MHz, 350 MHz, 500 MHz
Channels	2 Independent Channels
Memory	20 Mpts/Ch
Sample Rate	2.4 GS/s (2x Interpolation)
Display	4.3 inch Touch Screen TFT LCD
Connectivity	USB Host, USB Device, LAN
Warranty	3 Years

PRODUCT OVERVIEW

Ordering Information

Model	Bandwidth	Channel	Memory per Ch	Sample Rate per Ch
T3AFG200	200 MHz	2	20 Mpts	2.4 GS/s (2x Interpolation)
T3AFG350	350 MHz	2	20 Mpts	2.4 GS/s (2x Interpolation)
T3AFG500	500 MHz	2	20 Mpts	2.4 GS/s (2x Interpolation)

Function	T3AFG200, T3AFG350, T3AFG500
Built-in Waveforms	7 Standard (Sine, Square, Pulse, Ramp, DC, Noise, PRBS), 196 Arbitrary, optional IQ (option T3AFG-IQ)
Input/Output	2 Waveform Outputs, Frequency Counter Input, Aux In/Out, 10 MHz Reference Clock In/Out
Modulation Functions	AM, DSB-AM, FM, PM, FSK, ASK, PSK, PWM, Sweep, Burst, Harmonic
Vertical D/A Resolution	16 Bits
Additional Functions	Sweep, Burst, Waveform Combining, Channel Coupling, Channel Copying, Channel Tracking
Frequency Counter	Built-in high precision Frequency Counter (up to 8 digit resolution)
TrueArb and EasyPulse	Yes
Display Size	4.3" Touch Screen

Excellent Performance

- Bandwidths from 200 MHz to 500 MHz
- All Models have 2 Channels
- 20 Mpts/Channel memory

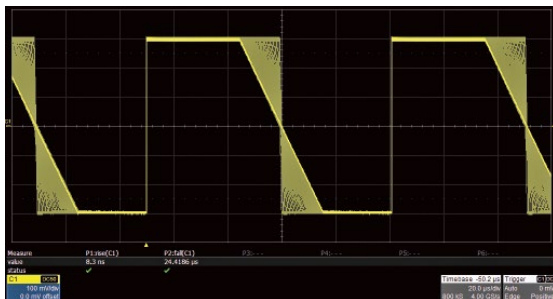

The rise/fall times can be set independently to a minimum of 1 ns (2 ns on T3AFG200) at any frequency and to a maximum of 75 s.

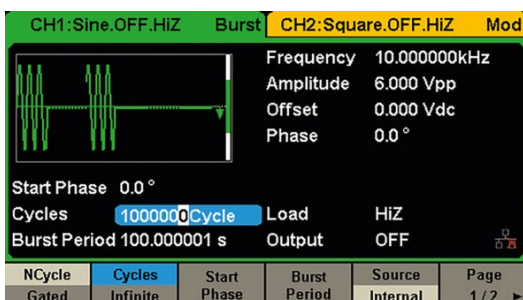

Burst mode supports 'N Cycle' and 'Gated' modes with the Burst source being configured as 'Internal', 'External' or 'Manual'.

Great Connectivity

- USB host port for mass storage
- USB device port (USBTMC)
- LAN port on 2 channel models

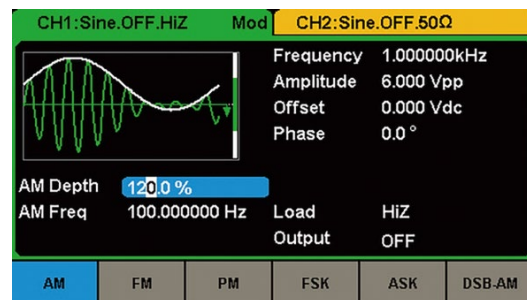

The T3AFG range of Function/Arbitrary Waveform Generators support a wide range of modulation types including AM, FM, PM, FSK, ASK, PSK, PWM and DSB-AM.



Output amplitude into a high impedance load can be as high 20 Vpp depending on frequency and waveform type.

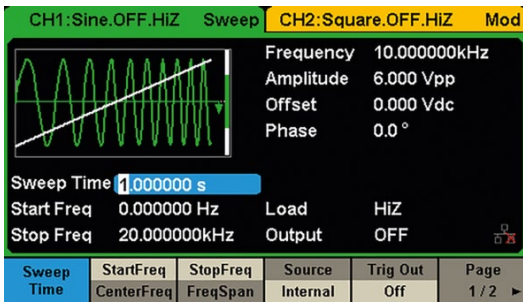

Sweep mode supports 'Linear' and 'Log' sweep, with 'Up' and 'Down' direction, and Sweep source can be configured as 'Internal', 'External' or 'Manual'.

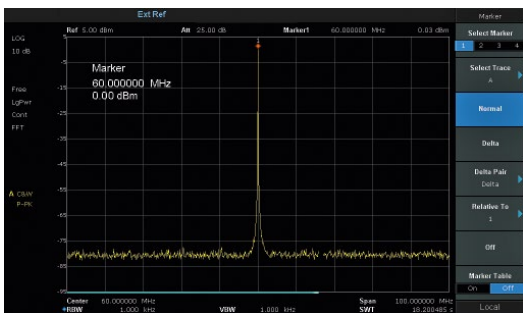

High Fidelity output with 80 dB dynamic range. Sine wave non-harmonic spurious artefacts are $-60 \text{ dBc} \leq 350 \text{ MHz}$ and $-55 \text{ dBc} > 350 \text{ MHz}$.

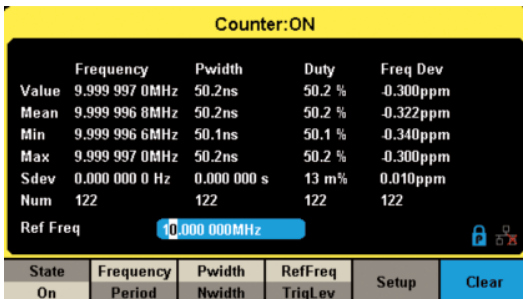

The counter functionality, accessed via the rear panel BNC, gives a DC or AC coupled counter capability from 100 mHz to 400 MHz.

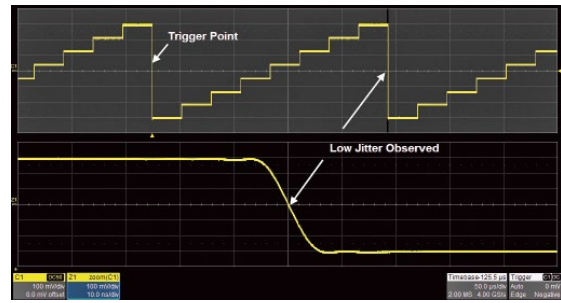
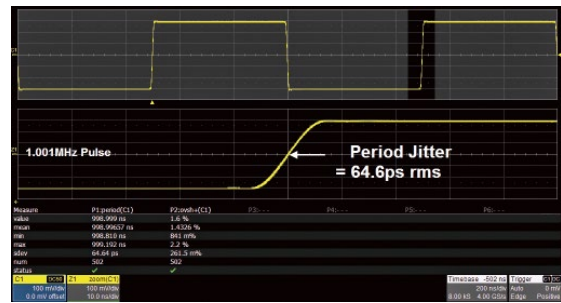

The Teledyne Test Tools T3AFG200, T3AFG350 and T3AFG500, with its low jitter design, can generate waveforms with exceptional edge stability. With better jitter performance comes better edge stability, and higher confidence in your circuit design.

Smart Capabilities

- Sweep output carrier can be Sine, Square, Ramp and Arbitrary waveforms. Linear or Log sweep.
- Burst output under internal or external signal control
- Waveforms types include PRBS (PRBS3 – PRBS32)
- Frequency Resolution 1 μHz
- DSB-AM: Double Sideband AM modulation Function
- 10 Order Harmonic Function
- Optional IQ Modulation (T3AFG-IQ)
- Multi-Language User Interface



PRODUCT OVERVIEW

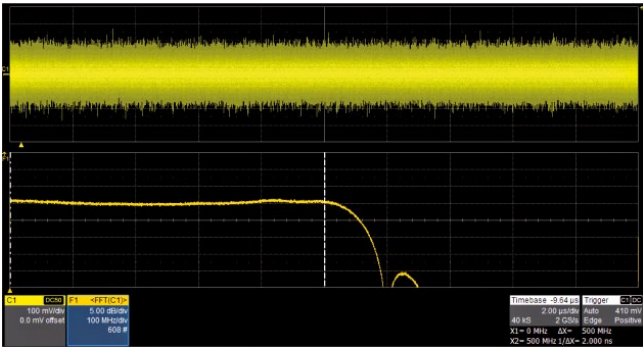

Gaussian noise with adjustable bandwidth up to 500 MHz, depending on model. Wide bandwidth Gaussian noise can be added to other waveforms to simulate real-world scenarios in which the signal contains a large degree of noise.

T3AFG-IQ, Optional IQ Signal Generation

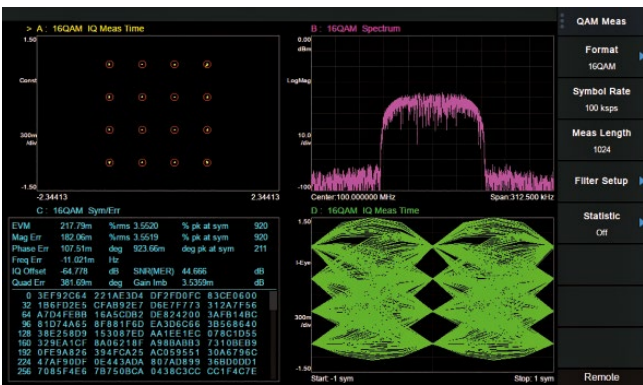

The T3AFG200, T3AFG350 and T3AFG500 optionally supports IQ signal generation with symbol rates between 250 Symbols/s to 37.5 MSymbols/s, providing ASK, PSK, QAM, FSK, MSK and multi-tone signals.

The built-in quadrature modulator provides the possibility to generate IQ signals from baseband to 500 MHz intermediate frequency (depending on T3AFG model).

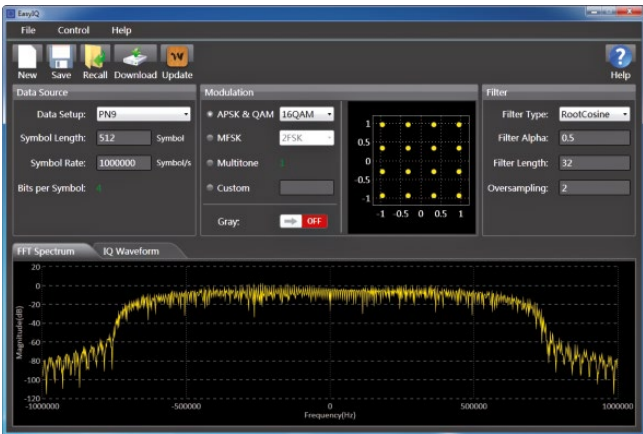

The EasyIQ software is necessary to generate an IQ waveform when using the T3AFG-IQ option.

The EasyIQ software is a PC program used to download IQ baseband waveform data to the T3AFG200, T3AFG350 or T3AFG500 through a USB or LAN device interface.

Phase Locked Operation Mode

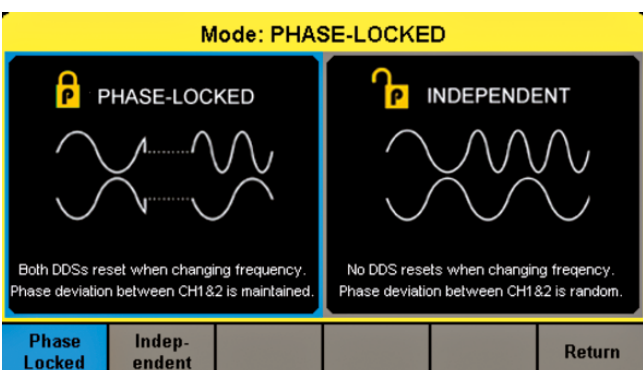

The 'Phase-Locked' mode automatically aligns the phases of each output. While 'Independent' mode permits the two output channels to be used as two independent waveform generators.

Waveform Combining

The T3AFG200, T3AFG350 and T3AFG500 have waveform combining capability whereby Channel 1 and Channel 2 can be combined to a user selected output. The combined waveform can be output on both Ch 1 and Ch 2 simultaneously, or just on a single output,

Ch 1 or Ch 2, whilst the other channel outputs the uncombined waveform for that channel. Easily combine basic waveforms (sine, square, ramp, pulse, etc), random noise, modulation signals, burst signals and Arb waveforms.

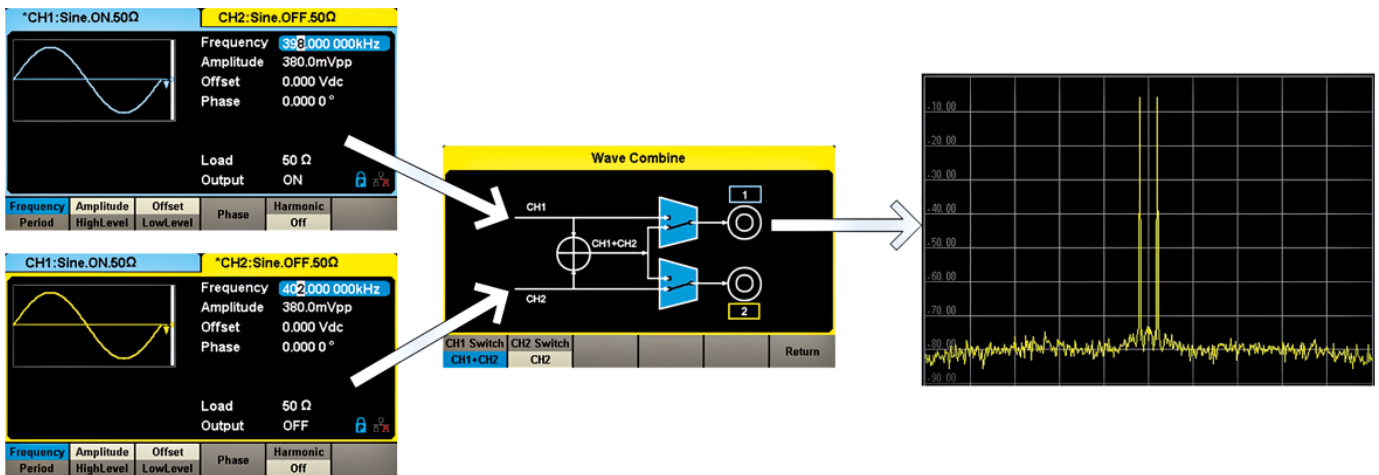

Harmonic Function

The harmonics function gives the user the ability to add higher-order elements to the signal being generated.

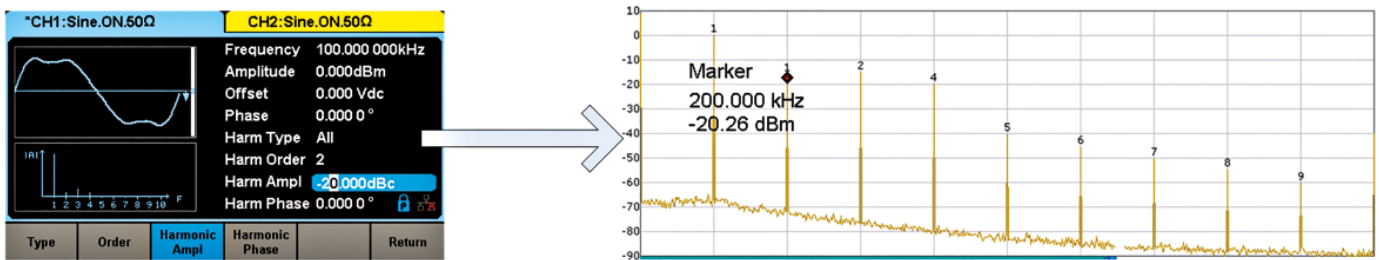

PRBS

The PRBS capability gives the flexibility to generate PRBS waveforms from PRBS3 to PRBS32 at up to 300 Mbps with edge rates from 1 ns to 1 μs. An added differential mode provides an easy way to generate

differential PRBS signals using both output channels. Easily set outputs to common logic levels such as TTL, ECL, LVCMOS, LVPECL and LVDS using built-in presets.

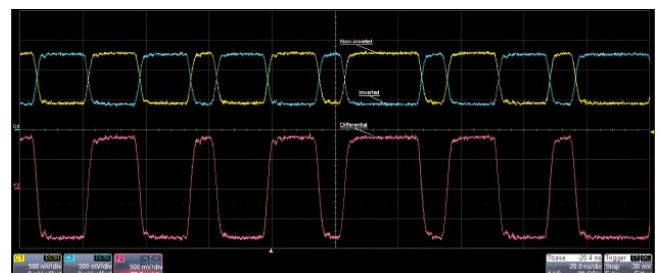
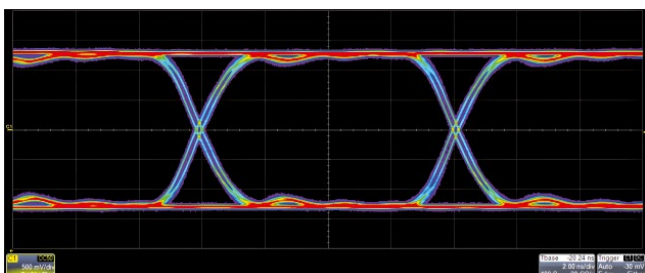

PRODUCT OVERVIEW

14 Bit Resolution



14 Bit Resolution

Less accurate waveform generation

16 Bit Resolution

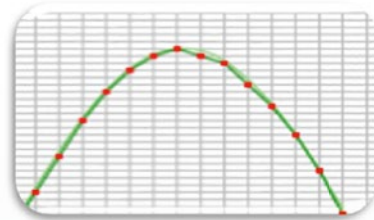

16 Bit Resolution

- T3AFG200 / T3AFG350 / T3AFG500 are all 16 bit resolution
- 4 x higher resolution than 14 bit systems
- Lower levels of Harmonic Distortion
- Lower levels of non-harmonic spurious signals
- Improved dynamic range
- Enhanced signal fidelity



I/O Connectivity

- LAN and USB connection
- 10 MHz Reference Input and Output
- The Aux Input/Output BNC Connector supports the Trigger Input, Trigger/Sync Output, external modulation input, external sweep/burst trigger input and external gate input
- External Counter input

SPECIFICATIONS

Frequency Specification

Model	T3AFG200	T3AFG350	T3AFG500
Waveform	Sine, Square, Ramp, Pulse, Noise, Arbitrary		
Sine	1 μ Hz – 200 MHz	1 μ Hz – 350 MHz	1 μ Hz – 500 MHz
Square	1 μ Hz – 80 MHz	1 μ Hz – 120 MHz	1 μ Hz – 120 MHz
Pulse	1 μ Hz – 80 MHz	1 μ Hz – 150 MHz	1 μ Hz – 150 MHz
Ramp/Triangular	1 μ Hz – 5 MHz		
Gaussian white noise	200 MHz (-3 dB)	350 MHz (-3 dB)	500 MHz (-3 dB)
Arbitrary	1 μ Hz – 50 MHz		
Resolution	1 μ Hz		
Accuracy	10-year aging +/- 3.5 ppm at 25 Degrees C		

Sine Wave

Harmonic Distortion (0 dBm)	DC – 1 MHz \leq -65 dBc 1 MHz – 60 MHz \leq -60 dBc 60 MHz – 100 MHz \leq -50 dBc 100 MHz – 200 MHz \leq -40 dBc 200 MHz – 300 MHz \leq -30 dBc > 300 MHz \leq -28 dBc		
Total harmonic distortion.	0.075 %, 0 dBm, 10 Hz – 20 kHz		
Spurious signal (non-harmonic)	DC \leq 350 MHz \leq -60 dBc > 350 MHz \leq -55 dBc		
Maximum Amplitude Output	\leq 40 MHz: 10 Vpp at 50 Ω , 20 Vpp at HiZ 40 MHz – 120 MHz: 5 Vpp at 50 Ω , 10 Vpp at HiZ 120 MHz – 160 MHz: 2.5 Vpp at 50 Ω , 5 Vpp at HiZ 160 MHz – 350 MHz: 1.5 Vpp at 50 Ω , 3 Vpp at HiZ > 350 MHz: 640 mVpp at 50 Ω , 1.28 Vpp at HiZ	(Minimum amplitude output 1 mVpp at 50 Ω , 2 mVpp at HiZ, all ranges)	

Square Wave

Rise/Fall Time (10 % – 90 %)	2.4 ns (1 Vpp, 50 Ω Load)		
Overshoot	3 % (typical, 100 kHz, 1 Vpp, 50 Ω Load)		
Duty Cycle	10 % – 90 %, Limited by frequency setting		
Jitter (rms) cycle to cycle	100 ps, 1 Vpp, 50 Ω Load		
Maximum Amplitude Output	\leq 20 MHz: 10 Vpp at 50 Ω , 20 Vpp at HiZ > 20 MHz: 5 Vpp at 50 Ω , 10 Vpp at HiZ	(Minimum amplitude output 1 mVpp at 50 Ω , 2 mVpp at HiZ, all ranges)	

Pulse

Pulse width (Accuracy +/- (0.01 % + 0.3 ns))	3.4 ns	3.3 ns	3.3 ns
Rise/Fall Time (10% ~ 90%, typical)	2 ns – 75 s	1 ns – 75 s	1 ns – 75 s
Pulse Width Adjustment Resolution	100 ps		
Duty Cycle	0.001 % ~ 99.999 %, 0.001 % Resolution, Limited by frequency setting		
Overshoot	3 % (typical, 100 kHz, 1 Vpp, 50 Ω Load, 2 ns edge)		
Jitter (rms, cycle to cycle)	100 ps, 1 Vpp, 50 Ω Load		
Maximum Amplitude Output, \geq 10 ns width, 2 ns edge	\leq 20 MHz: 10 Vpp at 50 Ω , 20 Vpp at HiZ 20 MHz – 120 MHz: 5 Vpp at 50 Ω , 10 Vpp at HiZ > 120 MHz: 2.5 Vpp at 50 Ω , 5 Vpp at HiZ	(Minimum amplitude output 1 mVpp at 50 Ω , 2 mVpp at HiZ, all ranges)	

Ramp/Triangle Wave

Linearity	\leq 1 % of Vpp (typical, 1 kHz, 1 Vpp, 50 % symmetry)		
Symmetry	0 % – 100 %		
Maximum Amplitude Output	10 Vpp at 50 Ω , 20 Vpp at HiZ		(Minimum amplitude output 1 mVpp at 50 Ω , 2 mVpp at HiZ, all ranges)

Harmonic Output

Order	10 Maximum		
Type	Even, Odd, All		

SPECIFICATIONS

Model	T3AFG200	T3AFG350	T3AFG500
-------	----------	----------	----------

Arbitrary Wave

Waveform length	8 – 20 M points		
Vertical resolution	16 bits		
Sample rate	300 MSa/s Arb Mode, 1.2 GSa/s DDS Mode		
Min. Rise/Fall Time	2.6 ns, 10 % – 90 %, 1 Vpp step signal, DDS mode		
Jitter (rms), cycle to cycle	100 ps, 1 Vpp, 50 Ω Load, TrueArb Mode		
Frequency Setting Range	1 μHz – 50 MHz		
Maximum Amplitude Output	≤ 20 MHz: 10 Vpp at 50 Ω, 20 Vpp at HiZ > 20 MHz: 5 Vpp at 50 Ω, 10 Vpp at HiZ		(Minimum amplitude output 1 mVpp at 50 Ω, 2 mVpp at HiZ, all ranges)

PRBS

Bit Rate	1 μbps – 160 Mbps	1 μbps – 300 Mbps	1 μbps – 300 Mbps
Rise/Fall Time	2 ns – 1 μs	1 ns – 1 μs	1 ns – 1 μs
Sequence Length	2^{m-1} , m = 3, 4, 5, ..., 32		
Maximum Amplitude Output	≤ 40 Mbps: 10 Vpp at 50 Ω, 20 Vpp at HiZ 40 Mbps – 240 Mbps: 5 Vpp at 50 Ω, 10 Vpp at HiZ > 240 Mbps: 2.5 Vpp at 50 Ω, 5 Vpp at HiZ		(Minimum amplitude output 1 mVpp at 50 Ω, 2 mVpp at HiZ, all ranges)

Noise Characteristics

-3 dB bandwidth	Bandwidth of the waveform generator		
Bandwidth Setting Range	1 mHz – Bandwidth of the waveform generator		
Amplitude Output Range	1 mVrms – 542 mVrms at 50 Ω, 2 mVrms – 1.084 Vrms at HiZ (Mean = 0, BW Limit = Off)		

DC Characteristics

Range	-10 V to +10 V HiZ Load -5 V to + 5 V 50 Ω Load		
Accuracy	+/- (1% + 2 mV) HiZ Load		

IQ Signal Generator (Option T3AFG-IQ)

Maximum Carrier Frequency	200 MHz	350 MHz	500 MHz
Symbol Rate	250 Symbols/s – 37.5 MSymbols/s		
Vertical Resolution	16 Bits		
Output Range	1 mVrms – 0.5 Vrms, 50 Ω Load ($\sqrt{I^2 + Q^2}$)		
Modulation Type	2ASK, 4ASK, 8ASK, BPSK, QPSK, 8PSK, DBPSK, DQPSK, D8PSK, 8QAM, 16QAM, 32QAM, 64QAM, 128QAM, 256QAM, 2FSK, 4FSK, 8FSK, 16FSK, MSK, MultiTone, Custom		Supported by EasyIQ software
Pattern	PN7, PN9, PN15, PN23, User file, Custom		Supported by EasyIQ software

General Output Characteristics

Accuracy	+/- (1% + 1 mVpp) 10 kHz sine wave, 0 V offset		
Amplitude Flatness	+/- 0.3 dB, 50 Ω load, 0.5 Vpp (reference 1 MHz Sine wave)		
Output impedance	50 Ω +/- 0.5 Ω at 100 kHz Sine wave		
Output current	+/- 200 mA		
Channel to channel Crosstalk	-60 dBc, Sine, 50 Ω load		
Current Limit Threshold	+/- 200 mA		
Over-Voltage protection threshold	+/- 3.5 V: For generator amplitude output < 3.2 Vpp and DC offset < 2 VDC +/- 10.5 V: For generator amplitude output ≥ 3.2 Vpp and DC offset ≥ 2 VDC		

Modulation Characteristics – AM

Carrier	Sine, Square, Ramp, Arb		
Modulation Source	Internal/External		
Modulation Wave	Sine, Square, Ramp, Noise, Arb		
Modulation Depth	0 – 120 %		
Modulation Frequency	1 mHz – 1 MHz, Modulation source “internal”		

Model	T3AFG200	T3AFG350	T3AFG500
-------	----------	----------	----------

Modulation Characteristics – FM

Carrier	Sine, Square, Ramp, Arb
Modulation Source	Internal/External
Modulation Wave	Sine, Square, Ramp, Noise, Arb
Modulation Depth	0 – 0.5 * BW (BW is the max output frequency limited by the frequency settings)
Modulation Frequency	1 mHz – 1 MHz, Modulation source "internal"

Modulation Characteristics – PM

Carrier	Sine, Square, Ramp, Arb
Modulation Source	Internal/External
Modulating Waveform	Sine, Square, Ramp, Arb, Noise
Phase Deviation	0 Deg – 360 Deg
Modulation Frequency	1 mHz – 1 MHz, Modulation source "internal"

Modulation Characteristics – ASK

Carrier	Sine, Square, Ramp, Arb
Modulation Source	Internal/External
Modulating Waveform	Square with 50 % duty cycle
Keying Frequency	1 mHz – 1 MHz, Modulation source "internal"

Modulation Characteristics – FSK

Carrier	Sine, Square, Ramp, Arb
Modulation Source	Internal/External
Modulating Waveform	Square with 50 % duty cycle
Modulation Frequency	1 mHz – 1 MHz, Modulation source "internal"

Modulation Characteristics – PSK

Carrier	Sine, Square, Ramp, Arb
Modulation Source	Internal/External
Modulating Waveform	Square with 50 % duty cycle
Modulation Frequency	1 mHz – 1 MHz, Modulation source "internal"

Modulation Characteristics – PWM

Carrier	Pulse
Modulation Source	Internal/External
Modulating Waveform	Sine, Square, Ramp, Noise, Arb
Modulation Frequency	1 mHz – 1 MHz, Modulation source "internal"

Burst Characteristics

Carrier	Sine, Square, Ramp, Noise, Pulse, Arb
Type	Count (1–1 M cycles), Infinite, Gated
Carrier Frequency	2 mHz – Maximum output frequency
Stop/Start phase	0 Deg to 360 Deg
Internal Period	1 μ s – 1000 seconds
Trigger Source	Internal, External, Manual
Gated Source	Internal, External
Trigger Delay	Maximum of 100 seconds

Sweep Characteristics

Carrier	Sine, Square, Ramp, Arb
Type	Linear, Log
Direction	Linear: Up, Down, Up and Down. Logarithmic: Up, Down
Carrier Frequency	1 μ Hz – Maximum output frequency
Sweep Time	1 ms – 500 seconds
Trigger Source	Internal, External, Manual

SPECIFICATIONS

Model	T3AFG200	T3AFG350	T3AFG500
-------	----------	----------	----------

Frequency Counter Characteristics

Function	Frequency, Period, Positive / Negative Pulse Width, Duty Cycle
Coupling	DC, AC, HF REJ
Frequency Range	DC: 100 mHz – 400 MHz, AC: 1 Hz – 400 MHz
DC Input Amplitude	100 mV rms – +/- 2.5 V < 100 MHz 200 mV rms – +/- 2.5 V 100 MHz – 200 MHz 500 mV rms – +/- 2.5 V > 200 MHz
AC Input Amplitude	100 mV rms – 5Vpp < 100 MHz 200 mV rms – 5Vpp 100 MHz – 200 MHz 500 mV rms – 5Vpp > 200 MHz
Input Impedance	1 M Ω

Reference Clock Input

Frequency	9.999 MHz – 10.001 MHz
Amplitude	Minimum 1.4 Vp-p into high impedance load
Input Impedance	5 k Ω

Reference Clock Output

Frequency	10 MHz Synchronised to the internal reference clock
Amplitude	Minimum 2 Vp-p into high impedance load
Output Impedance	50 Ω

External Trigger Input (Auxiliary In/Out)

V in Low	-0.5 V to +0.8 V
V in High	2 V to 5.5 V
Input Impedance	100 k Ω
Minimum Pulse Width	100 ns
Maximum Response Time	100 ns – Sweep, 600 ns – Burst

Trigger Output (Auxiliary In/Out)

V out Low	Maximum 0.44 V at 8 mA
V out High	Minimum 3.8 V at -8 mA
Output Impedance	100 Ω
Maximum Frequency	1 MHz

Sync Output (Auxiliary In/Out)

V out Low	Maximum 0.44 V at 8 mA
V out High	Minimum 3.8 V at -8 mA
Output Impedance	100 Ω
Maximum Frequency	10 MHz
Pulse Width	26.7 ns
Jitter	3.3 ns Peak to peak

Modulation Input (Auxiliary In/Out)

Frequency	0 Hz to 50 kHz
Input Impedance	10 k Ω
Amplitude at 100 % Modulation Depth	Min 11 Vp-p, Typ 12 Vp-p, Max 13 Vp-p

General Characteristics

Power	
Voltage	100 V to 240 V (+/-10 %) at 50 Hz / 60Hz 100 V to 120 V (+/-10 %) at 400 Hz
Power Consumption	Typical 32.5 W, Maximum 50 W, Dual channel, Sine, 1kHz, 10 Vpp, 50 Ω load
Display	
Color Depth	24 bit
Contrast Ratio	350:1
Luminance	300 cd/m ²
Touch panel type	Resistive
Environment	
Operating Temperature	0 Deg C to 40 Deg C
Storage Temperature	-20 Deg C to 60 Deg C
Operating Humidity	5 % to 90 % ≤ 30 Deg C 5 % to 50 % > 30 Deg C
Non-Operating Humidity	5 % to 95 %
Maximum Operating Altitude	3048 m ≤ 30 Deg C
Maximum Non-Operating Altitude	15000 m
Calibration	
Calibration Interval	Annually
Mechanical	
Dimensions	W x D x H = 260.3 mm x 107.2 mm x 295.7 mm
Net Weight	3.5 kg
Gross Weight	4.6 kg
Compliance	
LVD	IEC 61010-2:2010
EMC	EN61326-1:2013

Ordering information

Models	T3AFG200 200 MHz
	T3AFG350 350 MHz
	T3AFG500 500 MHz
Standard Accessories	Quick Start Guide
	USB Cable
	BNC Cable
	Calibration Certificate
	Power Cord
Optional Accessories	T3AFG-IQ IQ Signal Generator Function

ABOUT TELEDYNE TEST TOOLS



Company Profile

Teledyne LeCroy is a leading provider of oscilloscopes, protocol analyzers and related test and measurement solutions that enable companies across a wide range of industries to design and test electronic devices of all types. Since our founding in 1964, we have focused on creating products that improve productivity by helping engineers resolve design issues faster and more effectively. Oscilloscopes are tools used by designers and engineers to measure and analyze complex electronic signals in order to develop high-performance systems and to validate electronic designs in order to improve time to market.

The Teledyne Test Tools brand extends the Teledyne LeCroy product portfolio with a comprehensive range of test equipment solutions. This new range of products delivers a broad range of quality test solutions that enable engineers to rapidly validate product and design and reduce time-to-market. Designers, engineers and educators rely on Teledyne Test Tools solutions to meet their most challenging needs for testing, education and electronics validation.

Location and Facilities

Headquartered in Chestnut Ridge, New York, Teledyne Test Tools and Teledyne LeCroy has sales, service and development subsidiaries in the US and throughout Europe and Asia. Teledyne Test Tools and Teledyne LeCroy products are employed across a wide variety of industries, including semiconductor, computer, consumer electronics, education, military/aerospace, automotive/industrial, and telecommunications.

Distributed by:

Teledyne LeCroy (US Headquarters)

700 Chestnut Ridge Road
Chestnut Ridge, NY. USA 10977-6499

Phone: 800-553-2769 or 845-425-2000
Fax Sales: 845-578-5985
Phone Support: 1-800-553-2769
Email Sales: contact.corp@teledynelecroy.com
Email Support: support@teledynelecroy.com
Web Site: <http://teledynelecroy.com/>

Teledyne LeCroy (European Headquarters)

Teledyne LeCroy GmbH

Im Breitspiel 11c
D-69126 Heidelberg, Germany

Phone: +49 6221 82700
Fax: +49 6221 834655
Phone Service: +49 6221 8270 85
Phone Support: +49 6221 8270 28
Email Sales: contact.gmbh@teledynelecroy.com
Email Service: service.gmbh@teledynelecroy.com
Email Support: tlc.t3.appsupport.eu@teledyne.com
Web Site: <http://teledynelecroy.com/germany>

World wide support contacts can be found at:
<https://teledynelecroy.com/support/contact/#>

teledynelecroy.com



© 2020 Teledyne Test Tools is a brand and trademark of Teledyne LeCroy Inc. All rights reserved. Specifications, prices, availability and delivery subject to change without notice. Product brand or brand names are trademarks or requested trademarks of their respective holders.

T3 stands for Teledyne Test Tools.

24jun20