

Leader

Ver. 1.1

LV5300/LV5350/LV7300 Quick Manual



TABLE OF CONTENTS

Main unit			
Front Panel	2	
Rear Panel	3	
Basic Setup			
Measurement Screen	5	
INPUT Setting	6	
Basic Setting (No.1)	7	
Basic Setting (No.2)	8	
Function operation	9	
Settings for Quick Manual	10	
Measurement Mode			
Waveform Display (No.1)	11	
Waveform Display (No.2)	12	
Vector Display (No.1)	13	
Vector Display (No.2)	14	
Vector Display (No.3)	15	
(for UHDTV / HLG color bar)			
CIE chromaticity diagram display.	16	
5BAR Gamut display	17	
Picture display	18	
CINELITE (% display)	19	
CINEZONE	20	
Focus assist	21	
HDR display (No.1)	22	
HDR display (No.2)	23	
AUDIO	24	
			STATUS
			Payload ID/SRLive Metadata display
			Event log
			Phase difference measurement
			AV PHASE (Lip Sync)
			EYE
			Multi display
			Call the Layout (Single setting)
			Call the Layout (Simul setting)
			Others
			Screen capture
			Signal output settings
			Initialize
			Preset Register / Delete
			Call the Preset
			Layout Settings
			Change Layout—basic—
			Change Layout (general) —example—
			Change Layout (process) —example—
			Change layout (general) —example1—
			Change layout (process) —example1—
			Change layout (general) —example2—
			Change layout (Process) —example2—
			Operation Key

This Quick Manual requires firmware version 4.0 or higher.
If you have a lower version, please download and install the latest firmware from the web download.

Leader

LV5300/LV5350/LV7300 Quick Manual

LV5300/LV5350 Front Panel

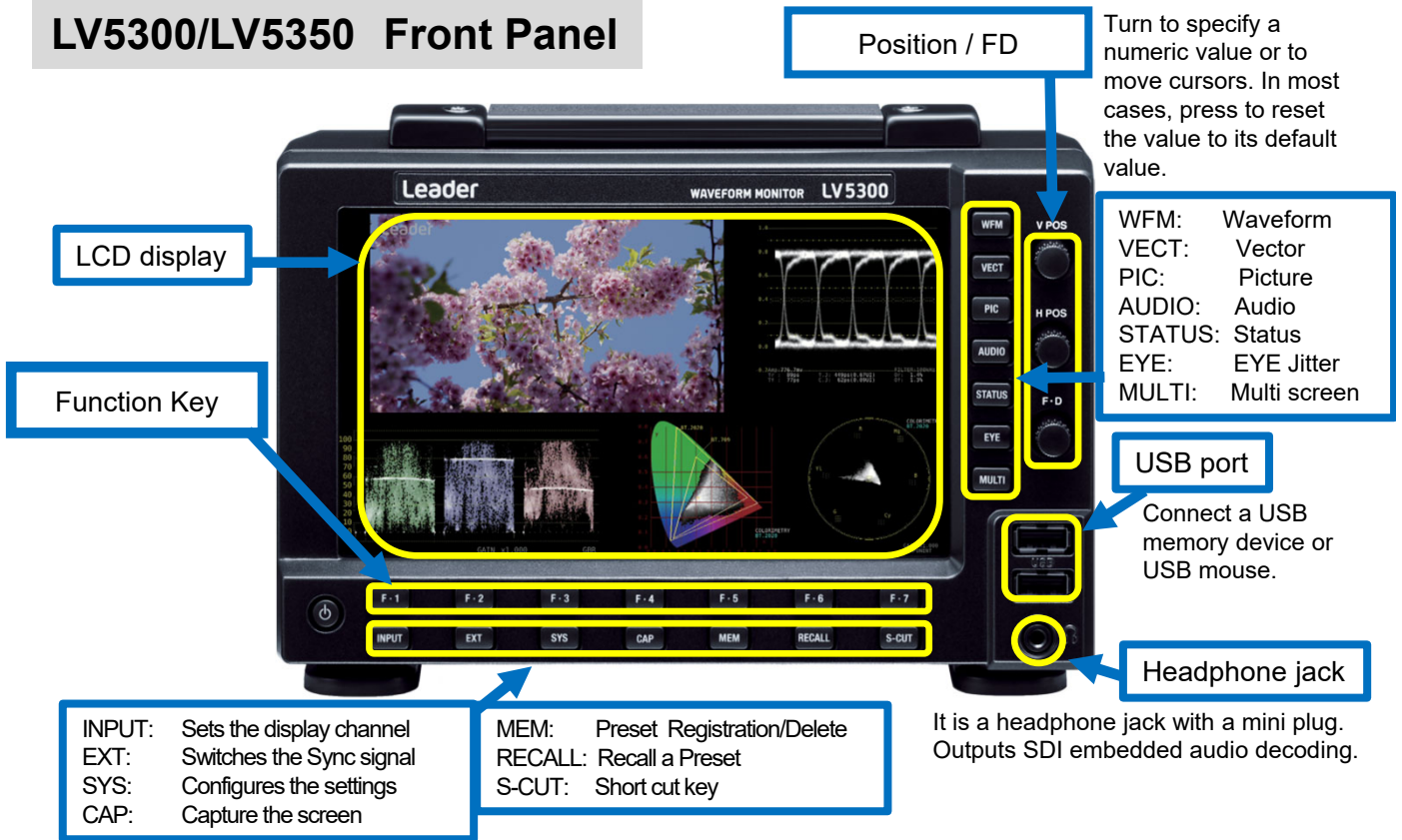

LV7300 Front Panel

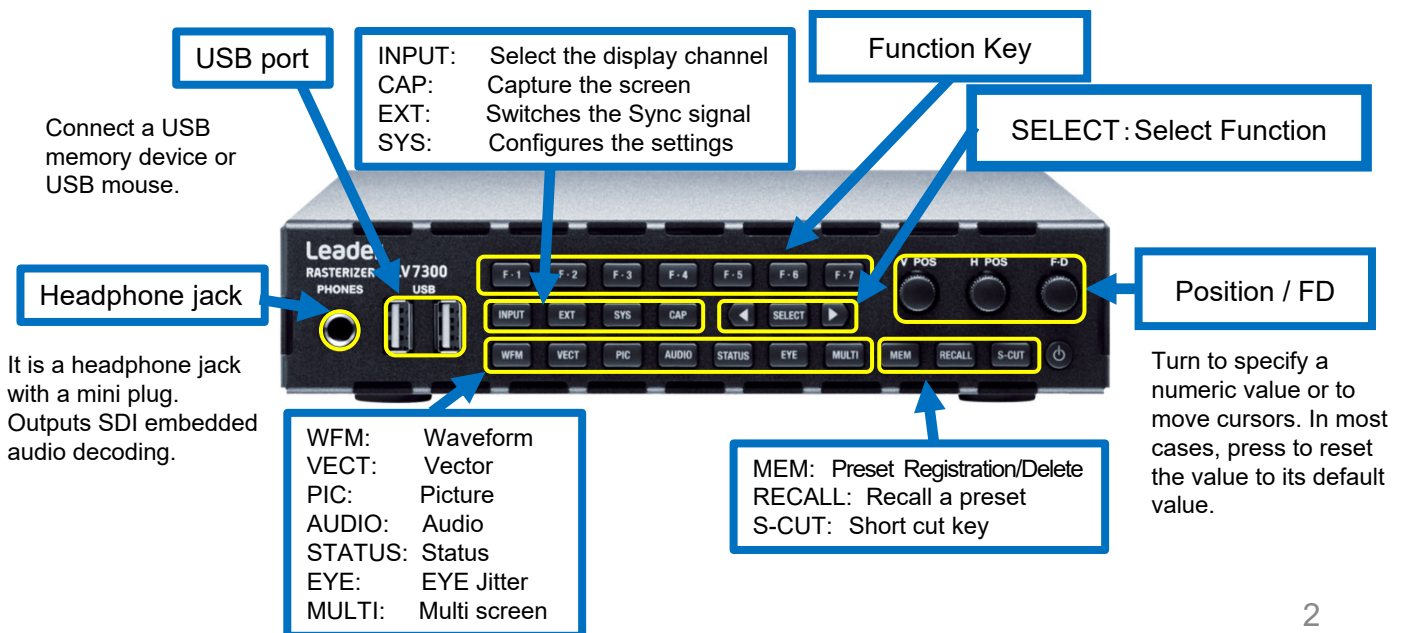

Leader

LV5300/LV5350/LV7300 Quick Manual

LV5300/LV5350 Rear Panel

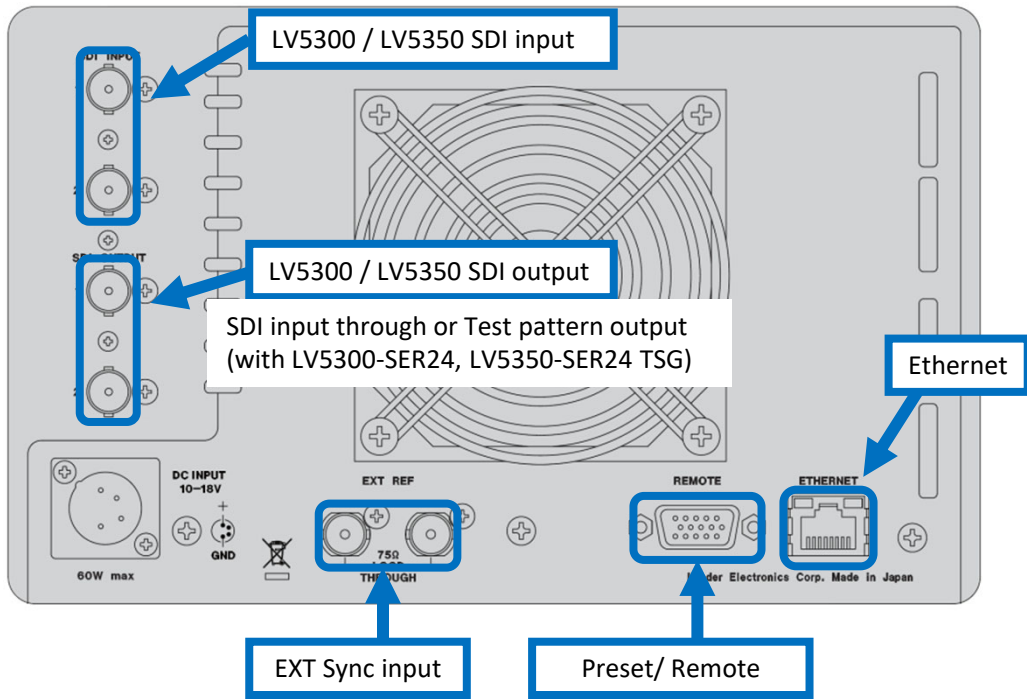

Standard
Option

LV7300 Rear Panel

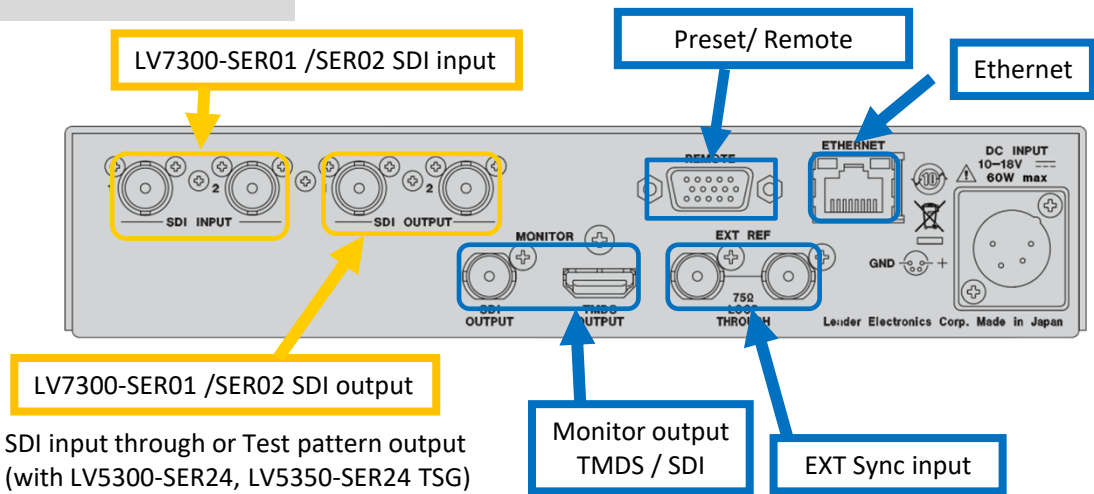

Leader

LV5300/LV5350/LV7300 Quick Manual

Screen Keys

The following Screen key operations can be performed with a mouse connection or touch panel. Appears with left mouse click or panel touch.

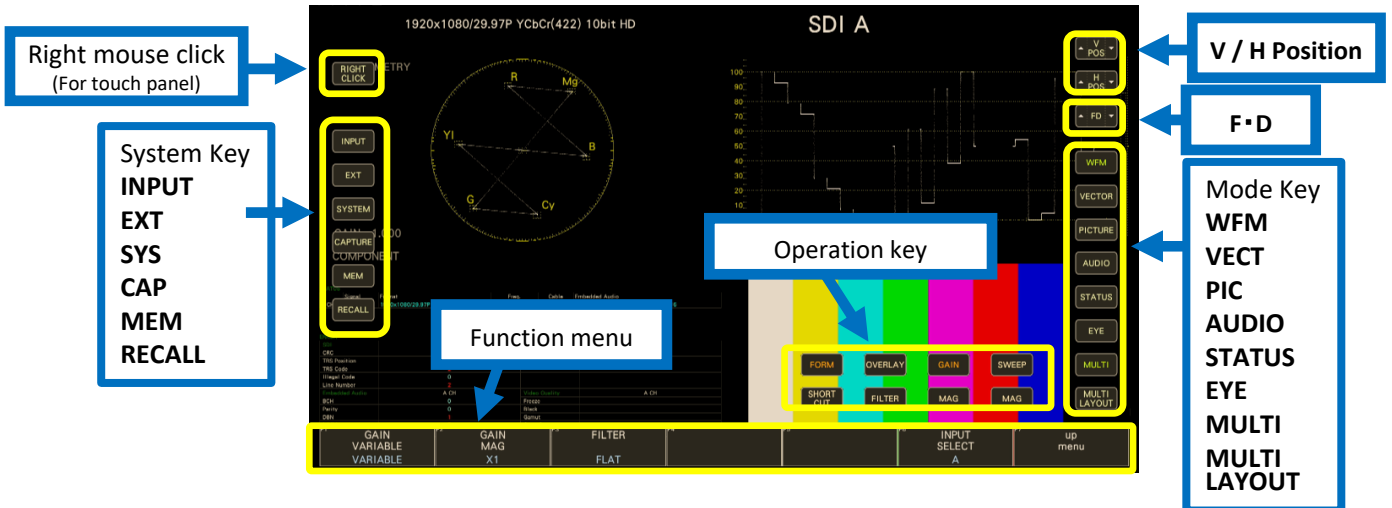

Options

- LV5300/LV5350 factory hardware option unit (Sold separately)
 - LV5300-SER11/LV5350-SER11 V mount type battery adapter
 - LV5300-SER12/LV5350-SER12 QR gold type battery adapter
- LV5300/LV5350 License option (Sold separately)
 - LV5300-SER20/LV5350-SER20 Embedded audio analysis
 - LV5300-SER21/LV5350-SER21 Closed captioning EIA-608,708/TELETEXT
 - LV5300-SER22/LV5350-SER22 CIE display
 - LV5300-SER23/LV5350-SER23 HDR analysis
 - LV5300-SER24/LV5350-SER24 SDI signal generation
 - LV5300-SER25/LV5350-SER25 Focus assist
 - LV5300-SER26/LV5350-SER26 User customizable layout
 - LV5300-SER27/LV5350-SER27 Tally display
 - LV5300-SER28/LV5350-SER28 4K format support (12G-SDI/6G-SDI/3G-SDI Dual)
- LV7300 factory hardware option unit (Sold separately)
 - LV7300-SER01 SD, HD, 3G SDI Input
 - LV7300-SER02 SDI input with EYE jitter measurement
 - ※Each unit must be configured with at least one of SER01, SER02.
- LV7300 License option (Sold separately)
 - LV7300-SER20 Embedded audio analysis
 - LV7300-SER21 Closed captioning EIA-608,708/TELETEXT
 - LV7300-SER22 CIE display
 - LV7300-SER23 HDR analysis
 - LV7300-SER24 SDI signal generation
 - LV7300-SER25 Focus assist
 - LV7300-SER26 User customizable layout
 - LV7300-SER27 Tally display
 - LV7300-SER28 4K format support(12G-SDI/6G-SDI/3G-SDI Dual)

Leader

LV5300/LV5350/LV7300 Quick Manual

Measurement screen

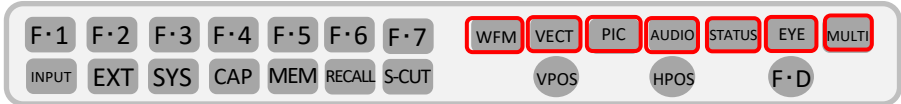

WFM VIDEO WAVEFORM

The display of video waveform. It displays the waveform of the selected line using Line select display, YCbCr display, RGB display, composite display.

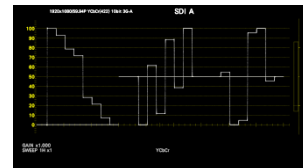

VECT VECTOR

The display of vector.

It can show Line select, vector maker display, composite and CIE chromaticity diagram display (LV5300-SER22,LV5350-SER22,LV7300-SER22)

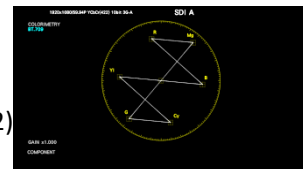

PIC PICTURE

The display of picture.

It can show Monochrome display, marker display, line select display, CINE LITE II, and focus assist (LV5300-SER25,LV5350-SER25,LV7300-SER25).

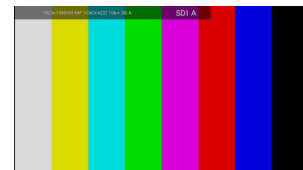

AUDIO Audio (LV5300-SER20,LV5350-SER20,LV7300-SER20)

The display of audio.

It can show Lissajous, Surround, meter and status for the signal which is chosen.

(When LV5300-SER20, LV5350-SER20, LV7300-SER20 is not installed, only the meter display is enabled, and other functions are disabled.)

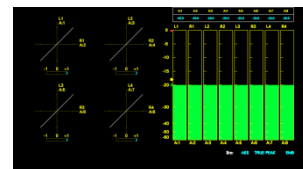

STATUS STATUS

The SDI status is displayed.

Event log display, data dump display, phase difference display, etc. can be displayed



EYE EYE PATTERN (LV5300, LV7300-SER02)

The eye pattern is displayed.

(LV5350 and LV7300 without LV7300-SER02 doesn't support Eye Pattern)

Jitter can be displayed in addition to the eye pattern by mode switching.

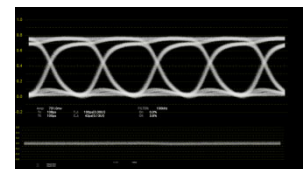

MULTI MULTI display

Multi screen that combines each measurement screen is displayed.

There are 6 types of model layouts which can be use chosen.

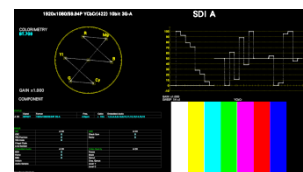

Leader

LV5300/LV5350/LV7300 Quick Manual

INPUT setting

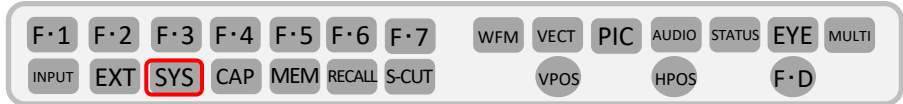

SYS (SYSTEM) > **F.1** (SIGNAL IN OUT)

Select **F.2** (PREV TAB) or **F.3** (NEXT TAB) tag, open the **SDI IN SETUP1** or **SDI IN SETUP2** screen.

Set each item according to the input signal. Press **F.D** to put a check mark or turn the dial to select an item of choice and press **F.D** to check mark the settings.

Press **F.1** (COMPLETE) at the end of the setting to confirm and save the system.

For the format selection of the SDI System, refer to 6.2 Setting of Measurement Signal in the manual.

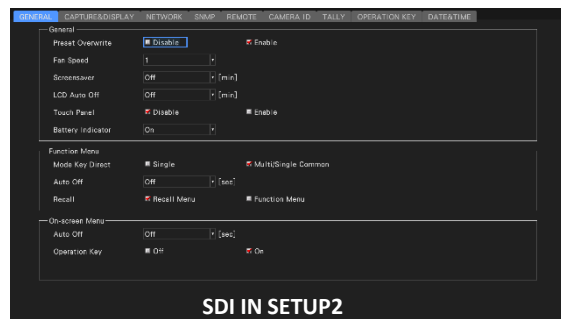
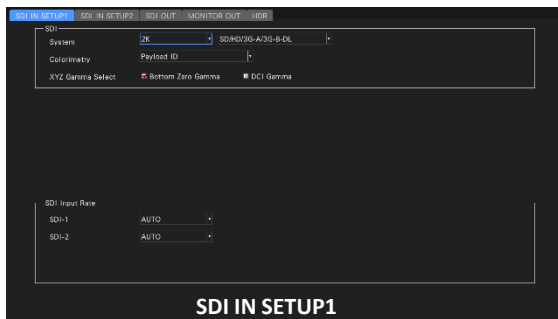

Input Format Alarm/Error

If the format of the received signal is not compliant as per the setting specified on the **SDI IN SETUP1** tab of the SYS menu, the instrument displays the format in red or an INPUT FORMAT window in the center of the screen. If this occurs, check the settings on the **SDI IN SETUP1** tab, the input signal, and payload ID.

Formats are displayed in red in the following cases.

- SDI input: When 4K 12G setting and input signal is 3G, HD, SD format
- When the payload ID is not appropriate.

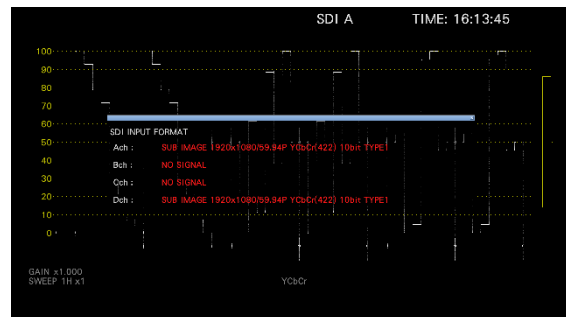

About Payload ID

The LV5300 / LV5350 / LV7300 analyzes the SYNC etc. TRS of the input signal to judge the format information etc., but the items that cannot be judged by the input signal are judged by the payload ID.

It is possible to specify either the payload ID of the input signal or the payload ID set in **SDI IN SETUP2**.

(Set by USE / Not USE in Payload ID item of **SDI IN SETUP2**)

Payload ID that can be set in LV5300 / LV5350 / LV7300 is the following items.

Division	: Square / 2 Sample Interleave
i/PsF Slect	: Interlace / Segmented Frame (PsF)
Color System	: YCbCr422 / YCbCr444 / RGB444 / XYZ444
Pixel Depth	: 10bit / 12bit

Note: Some items may not be able to be set depending on the SDI System settings.

Leader

LV5300/LV5350/LV7300 Quick Manual

Basic setting (No.1)

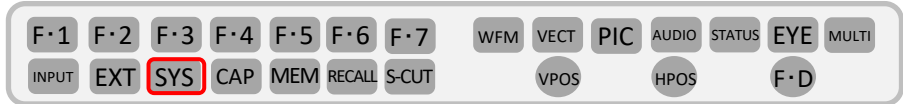

SYS > **F-2** (SYSTEM SETUP) > **GENERAL** (**F-2** (PREV TAB) or **F-3** (NEXT TAB) can change the tab display)
Rotating **F-D** > blue frame to match the item > press **F-D** and check maker or item can be chosen >
After setting > **F-1** (COMPLETE)

GENERAL

- Preset Overwrite
When registering presets, select whether to enable overwriting or not. You can prevent presets from being overwritten by disabling them.
[Overwrite Disable / Enable](#)
- Fan Speed
Fan speed can be chosen
When LV5300, LV7300-SER02 is installed : 4 / 5 / 6 / 7 / 8
When LV5300, LV7300-SER01 is installed : 1 / 2 / 3 / 4 / 5 / 6 / 7 / 8
- Screensaver
Select the time from the last key operation until the screen saver starts up.
Off / 1 / 5 / 10 / 20 / 30 / 60 [min]
- LCD Auto Off
Select the time from the last key operation to automatically turning off the backlight. Off / 5 / 30 / 60 [min]
- Touch Panel
Touch panel use or not
[Disable / Enable](#)
- Battery Indicator (LV5300-SER11/SER12、LV5350-SER11/SER12)
Displays the battery level when SER11 or SER12 is installed.
Off / On

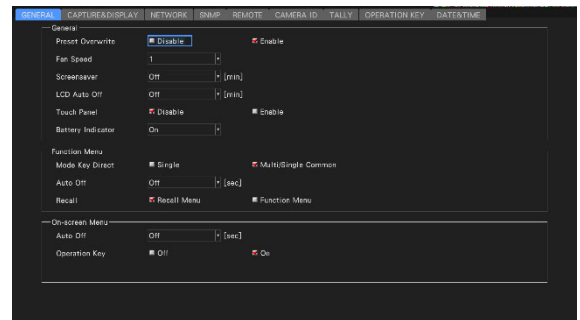

Function Menu

- Mode Key Direct
Multi display, mode key (WFM, VECT, PIC, AUDIO, STATUS, EYE) Select whether or not to change the measurement screen by operation.
(This is effective when INPUT item or Input option is placed in the layout.)
Single: With mode key, function menu and measure screen can be switch
Multi/Single Common: With mode key, only function menu can switch. Measure screen is still multi display.
To display the function menu with multi display, press and hold the MULTI key for about 2 seconds.
- Auto Off
Set the time from the last key operation to the automatic disappearance of the function menu.
Off / 1 / 2 / 3 / 4 / 5 / 10 / 20 / 30 / 60 [sec]
- Recall
When you want to pick up the recall record
Recall Menu: Recall menu display
Function Menu: measurement menu display

On-screen Menu

- Auto Off
Mouse / Set the time from the last key operation until the key display disappears automatically with the key display on the screen used by the touch panel operation.
Off / 1 / 2 / 3 / 4 / 5 / 10 / 20 / 30 / 60 [sec]
- Operation Key
Set whether or not to display the operation key on the key display on the screen used for mouse / touch panel operation.
OFF / ON

Leader

LV5300/LV5350/LV7300 Quick Manual

Basic setting (No.2)

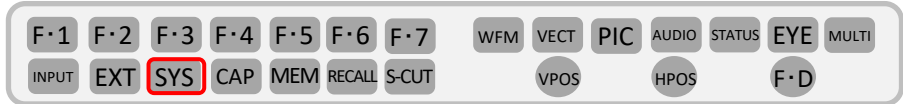

The following settings can be made on the **CAPTURE&DISPLAY** of **SYS** (SYSTEM)> **F·2** (SYSTEM SEUP).

(Display tab is changed by **F·2** (PREV TAB) or **F·3** (NEXT TAB))

Use **F·D** to set the blue frame to the item you want to set, then press **F·D** to add a check mark. After completing the settings, press **F·1** (COMPLETE) to confirm the settings.

CAPTURE

Screen capture: Capture the display screen as a still image

- Signal Color
Display color setting of captured waveform
White/Yellow/Cyan/Green/Magenta/Red/Blue

Information Display

- Format
ON / OFF of format display (1920x1080 / 59.94i YCbCr (422) 10bit HD etc.)
Off / On
- Input
Turn on / off the input signal display (SDI A, etc.)
Off / On
- Icon
Turning on / off the mouse icon, key lock icon, and USB memory icon
Off / On
- Error
Error display on / off (upper right of measurement screen)
Off / On
- Temperature Warning
Turns the alarm display (TEMPERATURE) on and off when the internal temperature of the main unit rises.
Off / On
- Date
Select date display format
Off / [y/m/d] / [m/d/y] / [d/m/y]
- Time
Select the time display format
Off / Real Time / LTC / VITC / D-VITC

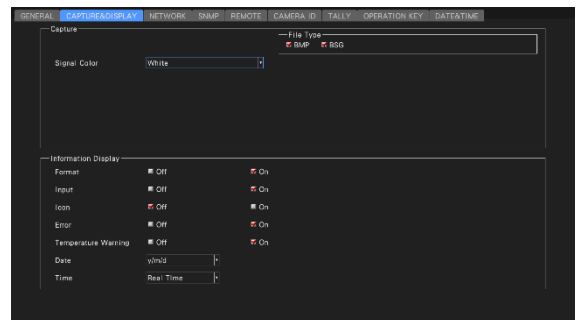

Leader

LV5300/LV5350/LV7300 Quick Manual

Function Operation

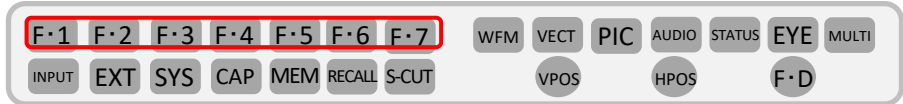

Normally, the function menu is displayed, but disappears when the key of the currently selected mode is pressed. In addition, it can be set to automatic OFF in the GENERAL tab of the SYS menu.

Selection function

If there are multiple items, press the function key while the pull-up menu is displayed to switch the items. It is also possible to select directly using a mouse or touch panel.

Example of changing the waveform color from WHITE to CYAN

- ① Press F.4.
- ② A pull-up menu appears.
- ③ Press F.4 while the pull-up menu is displayed.
- ④ It changes from WHITE to YELLOW.
- ⑤ Press F.4 while the pull-up menu is displayed.
- ⑥ It changes from YELLOW to CYAN.
- ⑦ If you do not press F.4, the pull-up menu disappears and is fixed to CYAN.



2. Switching function

- In case of switching only 2 such as ON and OFF, press the function key to switch. The mouse and touch panel are switched by clicking or touching.

Example of changing the waveform Y display from ON to OFF and OFF to ON.

- ① Press F.2.
- ② Y changes from ON to OFF.
- ③ Press F.2.
- ④ Y changes from OFF to ON.



3. Numeric value change function

- Press the function key and turn the FD to change the value. Press FD to return to the default value. The value can be changed by operating the mouse wheel or touching the ▲ or ▼ icon on the touch panel during the value change function.

Example of changing the waveform brightness.

- ① Press F.3.
- ② WFM INTENSITY changes to a value change function.
- ③ Turn the F.D clockwise.
- ④ WFM INTENSITY gradually changes from 0 to 80.
- ⑤ Press F.D.
- ⑥ WFM INTENSITY changes from 80 to 0 at once.

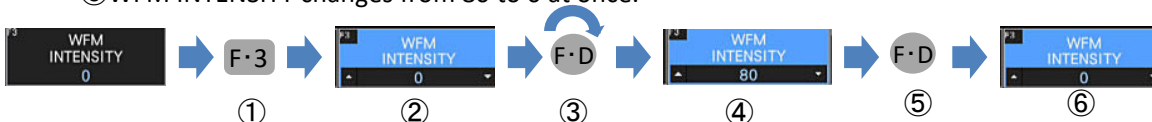

Leader

LV5300/LV5350/LV7300 Quick Manual

Settings for Quick Manual

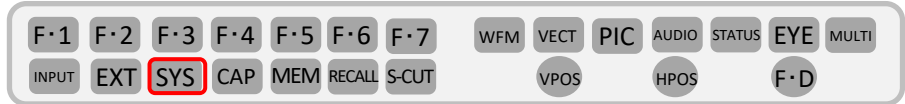

The explanations after this page follow the settings below.

Make the following settings in **GENERAL** of **SYS** < **F-2**.

Function Menu

● Mode Key Direct **Single** Multi/Single Common

● Auto Off

Set the time from the last key operation until the function menu disappears automatically.

Off / 1 / 2 / 3 / 4 / 5 / 10 / 20 / 30 / 60 [sec]

On-screen Menu

● Auto Off

Set the time from the last key operation until the menu display on the screen used for mouse / touch panel operation disappears automatically.

Off / 1 / 2 / 3 / 4 / **5** / 10 / 20 / 30 / 60 [sec]

● Operation Key

Set On / Off of the operation menu key used for mouse / touch panel operation displayed on the screen.

OFF / **ON**

Confirm the settings with **F-1** (COMPLETE).

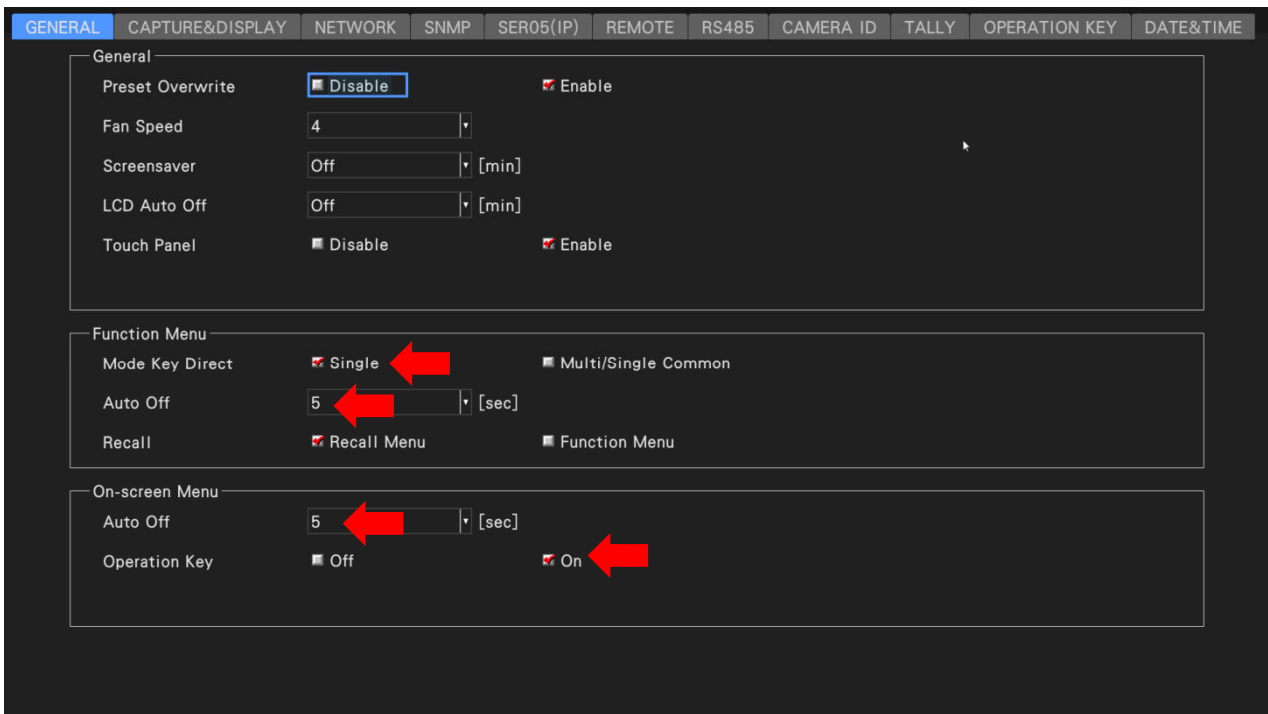

Leader

LV5300/LV5350/LV7300 Quick Manual

Waveform display(No.1)

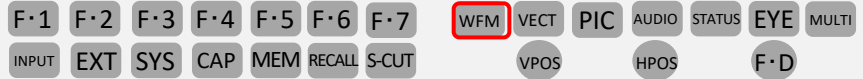

Waveform display color setting (e.g. change to Multi-color)

- Press **WFM** (WAVEFORM) to display the waveform.

F.1 (WFM INTEN/CONFIG)>**F.4** (WFM COLOR) - Select **MULTI**.

Note: If **F.1** is other than (WFM INTEN / CONFIG), press **WFM** (WAVEFORM) key twice

Waveform display matrix setting (e.g. Set waveform mode to RGB)

- **F.7** (up menu)>**F.7** (COLOR SYSTEM)>**F.1** (COLOR MATRIX)-Select **RGB**.

In COLOR MATRIX, you can select YCbCr / GBR / RGB / COMPOSITE.

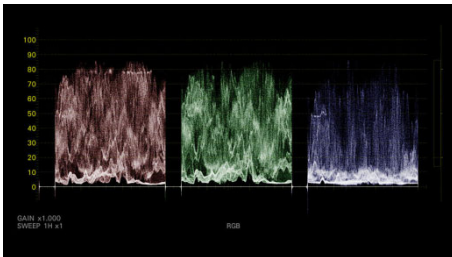

RGB display

Waveform display ON-OFF setting (e.g. Change the waveform to R only)

- **F.7** (up menu)> **F.1** (WFM INTEN / CONFIG)> **F.2** (WFM MODE) - Set G and B to OFF.

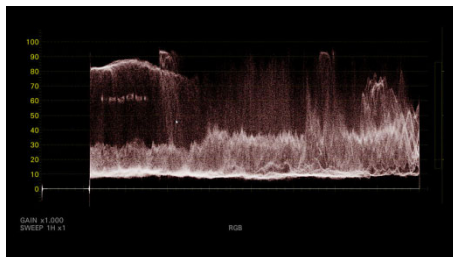

R waveform only

Leader

LV5300/LV5350/LV7300 Quick Manual

Waveform display(No.2)

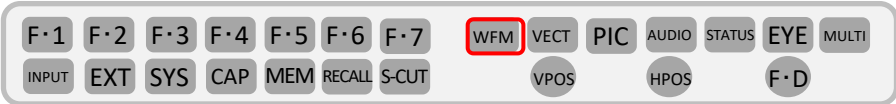

Display size variable setting

• Press **WFM** (WAVEFORM) to display the video waveform.

Note: If the EXTERNAL SYNC waveform is displayed, press **F·1** (WFM INTEN / CONFIG)>**F·1** = OFF> **F·7** (up menu) to return to the normal video waveform display.

Set **F·2** (GAIN / FILTER)> **F·2** (GAIN MAG) to X1. Set **F·1** (GAIN VARIABLE) to VARIABLE.

Note: When **F·2** is other than (GAIN / FILTER), press **WFM** (WAVEFORM) twice.

The waveform is scaled by turning **F·D** (FUNCTION DIAL) or the flywheel of the mouse.

Press **F·D** (FUNCTION DIAL) to return to X1.

On the right side, the enlarged part for full scale is displayed as a square frame.

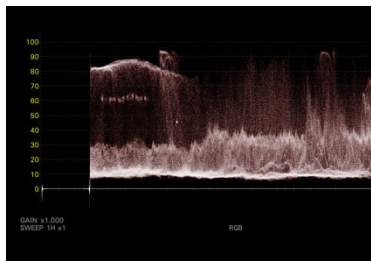

X1 display

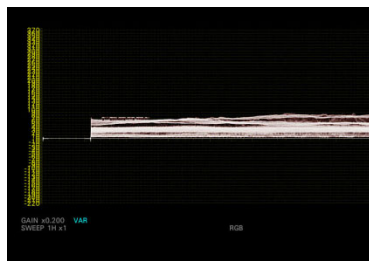

Zoom Out

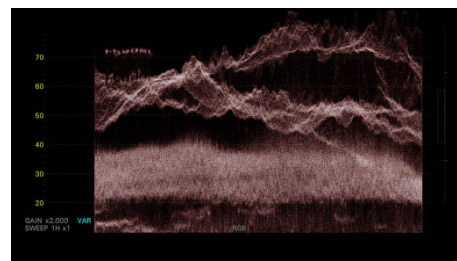

Zoom In

The display area for full scale is a square frame.

Scale jump display setting (e.g., changed to 80% of X5)

Set the base point for enlarged display.

• Set **F·2** (GAIN MAG) to X5. Change **F·5** (SCALE JUMP) to 80%.

Normally, it is displayed from 0%, but in "scale jump" it is displayed from the set base point.

(SCALE JUMP can select 0%, 10%, 20%, 30%, 40%, 50%, 60%, 70%, 80%, 90%, 100% when setting X5 or X10.

CURSOR is set based on the Y measurement cursor.)

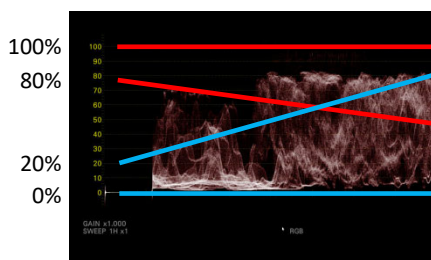

X1 display

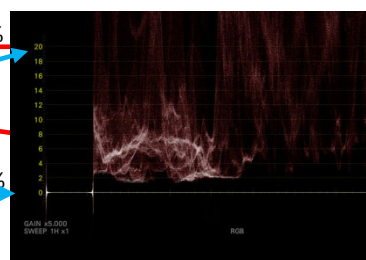

X5 display
0% to 20%

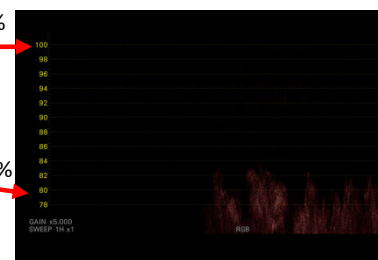

X5 display
SCALE JUMP 80%
80% to 100%

Leader

LV5300/LV5350/LV7300 Quick Manual

Vector Display(no.1)

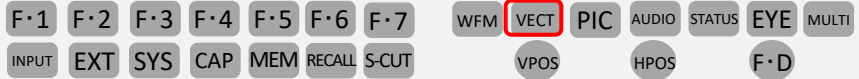

COLOR BAR 100% 75% setting

• Press **VECT** (VECTOR SCOPE) to display the vector scope.

Change **F-7** (COLOR SYSTEM) > **F-2** (COLOR BAR) to 100% or 75%

Note: If **F-7** is not (COLOR SYSTEM), press, **VECT** (VECTOR SCOPE) twice.



Input 75% COLOR BAR

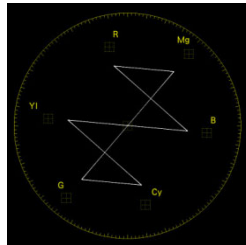

Set COLOR BAR 100%
(Off target)

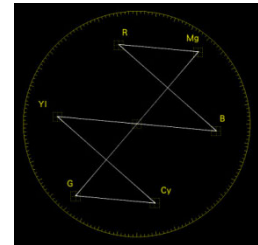

Set COLOR BAR 75%

VECTOR SCALE Setting

• Press **VECT** (VECTOR SCOPE) to display the vector scope.

Change **F-2** (VECTOR SCALE) > **F-2** (VECTOR SCALE) to AUTO / BT.601 / BT.709 / DCI / BT.2020.

Note: If **F-2** is not (VECTOR SCALE), press **VECT** (VECTOR SCOPE) twice.

When AUTO is selected, the Colorimetry setting of SDI setting signal is used.

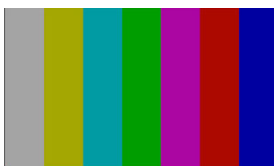

Input BT.2020 COLOR BAR

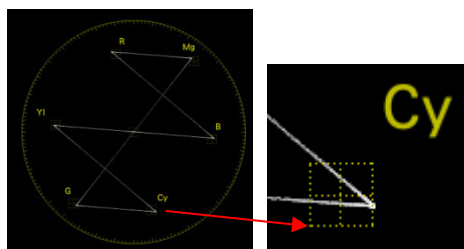

Set VECTOR SCALE BT.709
(Off target)

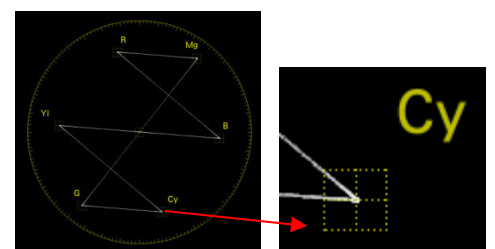

Set VECTOR SCALE BT.2020

Leader

LV5300/LV5350/LV7300 Quick Manual

Vector Display(no.1)



Variable scale display setting

Press **VECT** (VECTOR SCOPE) to display the vector scope.

Set **F.2** (VECTOR SCALE) > **F.5** (VARIABLE SCALE) to ON.

Note: If **F.2** is not (VECTOR SCALE), press **VECT** (VECTOR SCOPE) twice.

Set **F.7** (up menu) > **F.3** (VECTOR GAIN) > **F.1** (GAIN VARIABLE) to VARIABLE.

If you need more than 2 times magnification, change **F.2** (GAIN MAG) to X5 and **F.3** (GUIDE DISPLAY) to ON.

The center position can be moved with **VPOS**(VPOS) / **HPOS**(HPOS).

Use **F.D** (FUNCTION DIAL) or flywheel of mouse to enlarge / reduce the vector display.

Press **F.D** (FUNCTION DIAL) to return to X1.

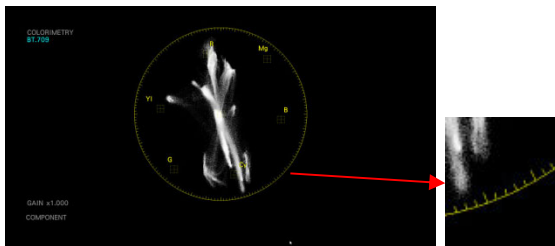

VARIABLE SCALE OFF

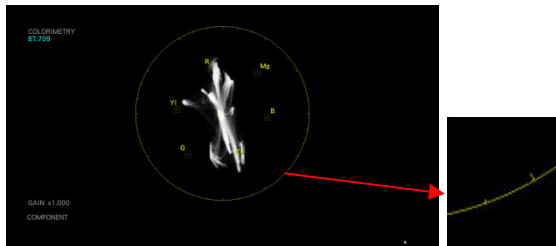

VARIABLE SCALE OFF

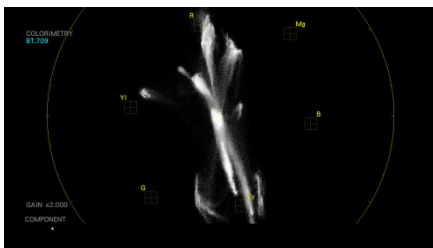

VARIABLE SCALE ON: x2 setting

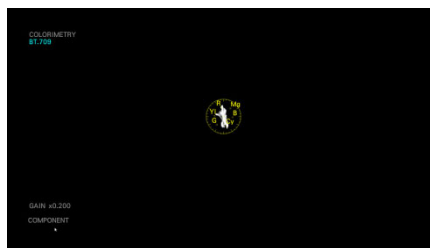

VARIABLE SCALE ON: Zoom out

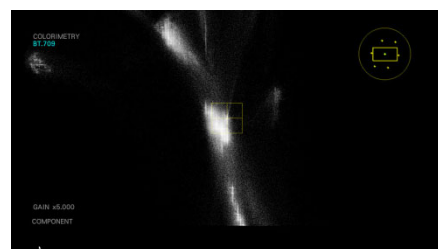

VARIABLE SCALE ON: x5 setting

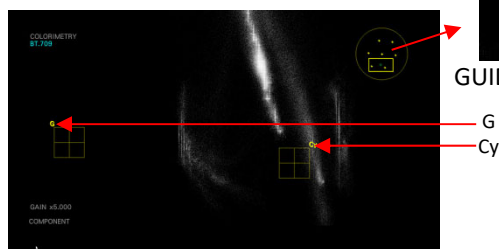

VARIABLE SCALE ON: x5,
Change V-POS / H-POS and
Show G / Cy.

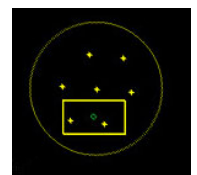

GUIDE DISPLAY表示

Leader

LV5300/LV5350/LV7300 Quick Manual

Vector Display^(no.3)
For UHDTV / HLG color bar

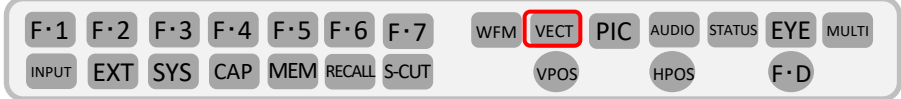

1. Input the UHDTV color bar (ARIB STD-B66).

2. Set the vector scope to 75%.

- Press **VECT** (VECTOR SCOPE) to display the Vector scope.
- Switch **FF-7** (COLOR SYSTEM) > **FF-2** (AR) to 75%.

Note: If **F-2** is not (COLOR SYSTEM), press **VECT** (VECTOR SCOPE) twice.

3. Variable scale display ON and ARIB CHECK MARCKER setting

- Press **F-7** (up menu).
- Set **F-2** (VECTOR SCALE) > **F-5** (VARIABLE SCALE) to ON.
- Set **F-3** (ARIB CHECK MARKER) to STD-B66. ※COLORIMTRY must be BT2020.

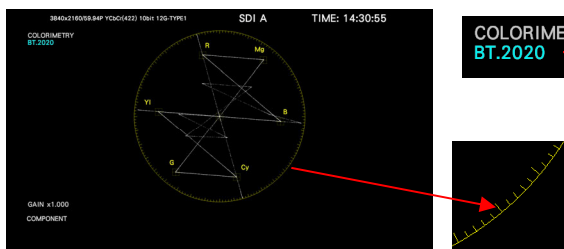

VARIABLE SCALE OFF

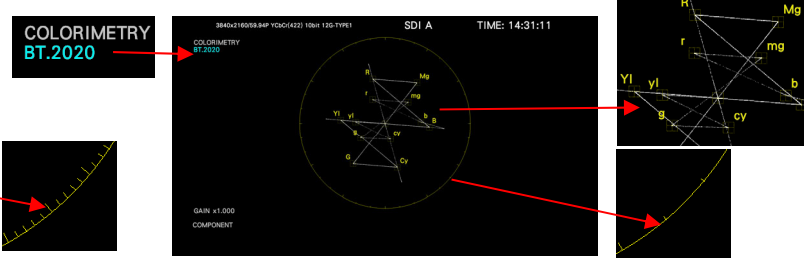

VARIABLE SCALE ON
Set STD-B66

4. Variable scale display ON

- Press **F-7** (up menu).
- Set **F-3** (VECTOR GAIN) > **F-1** (GAIN VARIABLE) to VARIABLE.
- Turning **F-D** (FUNCTION DIAL) scales the vector.
- Press **F-D** (FUNCTION DIAL) to return to X1.

The center position can be moved with **VPOS** (V POS) / **HPOS** (H POS).

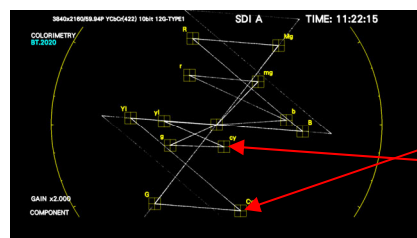
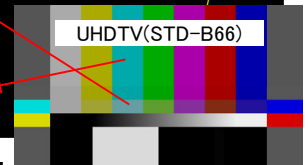
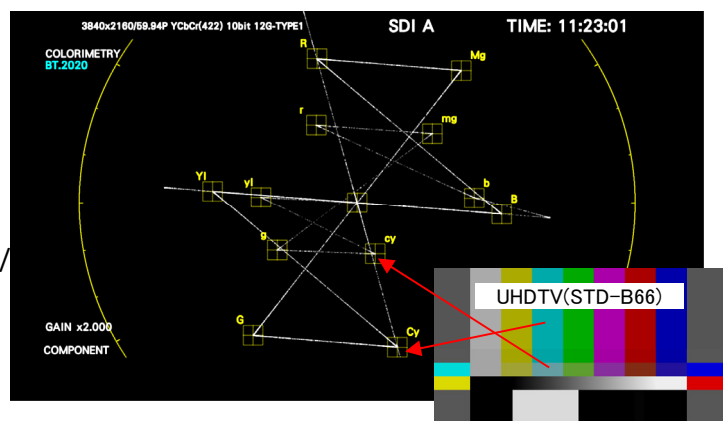

5. For HLG color bar (ARIB STD-B72)

- Input ARIB STD-B72 pattern.
- Switch the **F-3** (ARIB CHECK MARKER) in step 3 above to STD-B72.

Leader

LV5300/LV5350/LV7300 Quick Manual

CIE DIAGRAM display



VECT > F.1 (VECT INTEN/CONFIG) > F.1 (VECTOR DISPLAY) > CIE DIAGRAM

Color triangle setting

F.2 (CIE DIAGRAM SCALE) > F.1 (TRIANGLE1), F.2 (TRIANGLE2) > Yellow standard scaler can be displayed

Triangle standard name display

F.2 (CIE DIAGRAM SCALE) > F.5 (SUB SCALE) > F.4 (TRIANGLE CAPTION) > ON setting

The figure below shows the color triangle setting, F.1 (TRIANGLE1) BT.2020, F.2 (TRIANGLE2) BT.709 > Triangle standard name display > ON

Payload ID setting and colorimetric setting

SYS > F.1 (SIGNAL IN OUT) > SDI IN SETUP1

- COLORIMETRY items can choose from:
Payload ID, BT-709, BT-2020, DCI

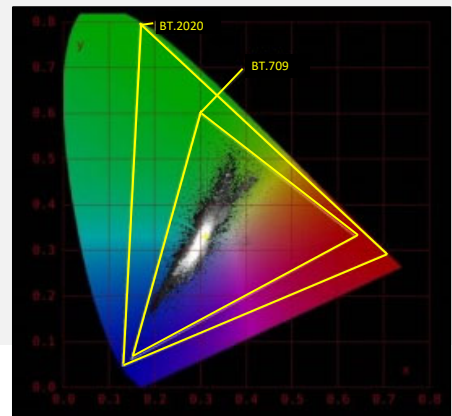

Color scale setting

F.2 (CIE DIAGRAM SCALE) > F.1 (COLOR)

B.G. COLOR: Displays the color scale. Background is black, the waveform is displayed according to the brightness

B.G. WHITE: Color scale is not displayed. Background is white, waveform is displayed according to the color of the picture.

B.G. BLACK: Color scale is not displayed. Background is black, waveform is displayed according to the color of the picture.

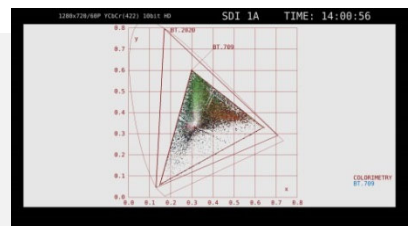

B.G. WHITE

Display mode setting (Chroma Diagram / Color Temperature Display Switch)

F.3 (CIE DIAGRAM SETTING) > F.1 (DISPLAY MODE)

DIAGRAM: Chroma Diagram Display

TEMP: Color Temperature Display

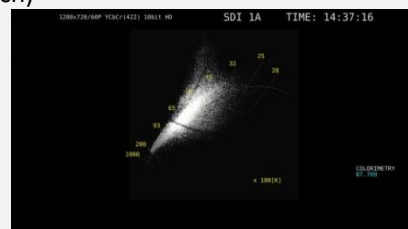

TEMP

Leader

LV5300/LV5350/LV7300 Quick Manual

5BAR Gamut display



The 5BAR gamut display can display RGB and composite gamut errors separately.

5BAR Display

Change **VECT** (VECTOR) > **F·1** (VECT INTEN / CONFIG) > **F·1** (VECTOR DISPLAY) to 5BAR.

Note: If you press **VECT** (VECTOR) and **F·1** is not (VECT INTEN / CONFIG), press **VECT** (VECTOR) twice.

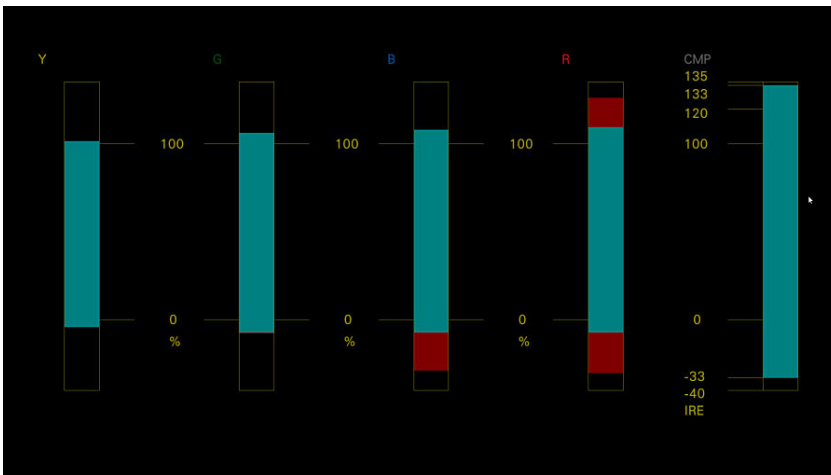

5BAR Display

5BAR setting

In **STATUS** (STATUS) > **F·5** (STATUS SETUP), change the tab to **ERROR SETUP3** and set as below.

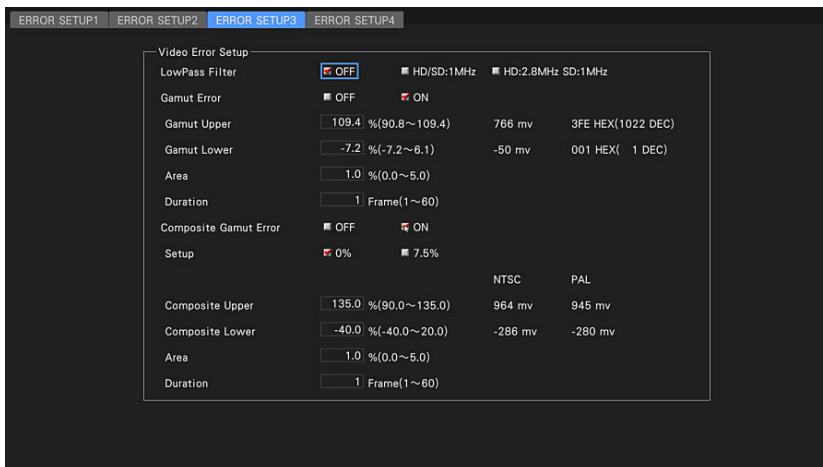

5BAR setting

Leader

LV5300/LV5350/LV7300 Quick Manual

Picture display



Japanese subtitle display function (LV5300/5350/7300-SER21)

Japanese subtitles can be simply displayed on the picture.

Set **PIC** (PICTURE)> **F·1** (PIC CONFIG)> **F·5** (SUPER IMPOSE)> **F·1** to ARIB.

Note: ● If you press **PIC** (PICTURE) and **F·1** is not (PIC CONFIG), press **PIC** (PICTURE) twice.

● When the input format is 3G-B, **F·5** (SUPER IMPOSE) is not displayed.

HD / SD / ANALOG / CELLULAR can be selected with **F·2** (FORMAT).

You can select 1/2 with **F·2** (LANGUAGE).

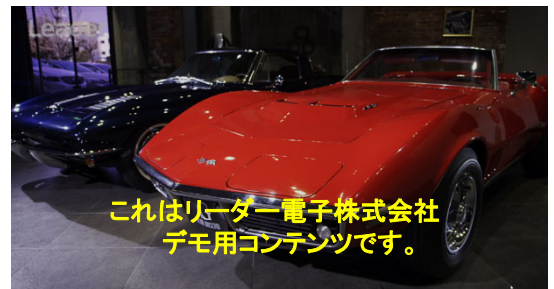

Japanese subtitle display

Picture mode

The picture can be displayed in real size or doubled.

You can select FIT / REAL / X2 / FULL FRM in **PIC** (PICTURE)> **F·1** (PIC CONFIG)> **F·1** (PICTURE MODE).

Note: ● If you press **PIC** (PICTURE) and **F·1** is not (PIC CONFIG), press **PIC** (PICTURE) twice.

For HD, FIT / REAL / X2 / FULL FRM can be selected.

For 4K, FIT / REAL can be selected.

In HD X2 or 4K REAL, the display position can be changed by **VPOS** (V-POS) / **HPOS** (H-POS).



HD : FIT display

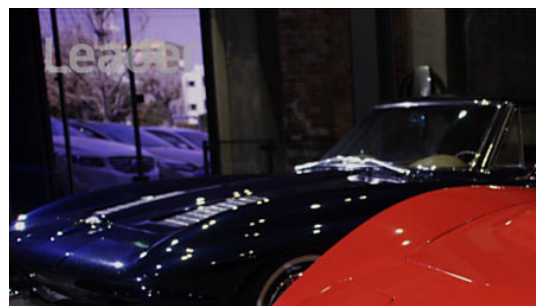

HD : x2 display

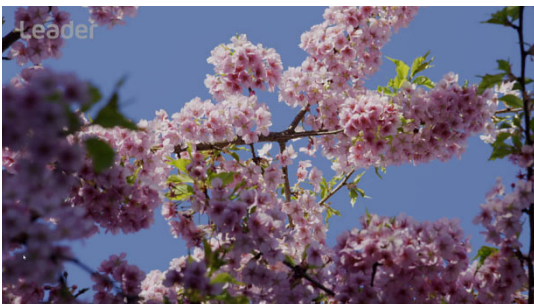

4K : FIT Display

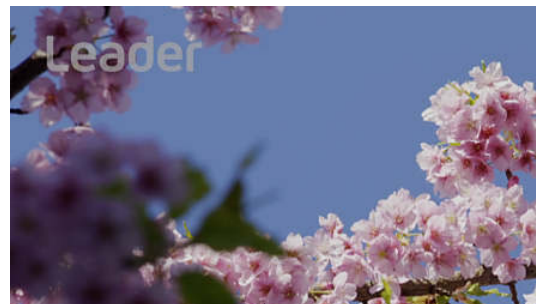

4K : REAL display

Leader

LV5300/LV5350/LV7300 Quick Manual

CINELITE (% display)

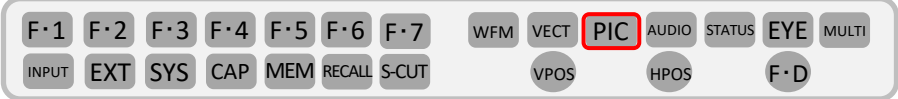

Max 3 points (P1~P3) level check is possible

PIC > **F-2** (CINELITE or CINELITE/HDR) > **F-1** (CINELITE DISPLAY) > % DISPLAY setting

PIC > **F-2** (CINELITE or CINELITE/HDR) > **F-2** (%DISPLAY SETUP)

- **F-1** (MEASURE NUMBERS): Measurement point setting to display, P1, P1+P2, P1+P2+P3
- **F-2** (MEASURE POSITION): Select the measurement point to move the cursor, use **VPOS** **HPOS** to move cursor
- **F-3** (MEASURE SIZE): measurement size choose, 1x1(1 Pixel), 3x3 (3x3 Pixel averaging, 9x9 (9x9 Pixel averaging)
- **F-4** (UNIT SELECT): Brightness level value display setting, Y%, RGB%, RGB255, CV, CV(DEC), HDR
(*HDR→With option for LV5600-SER23(HDR), HDR setting for ON is available.)
- **F-6** (SELECT CH): display channel switch

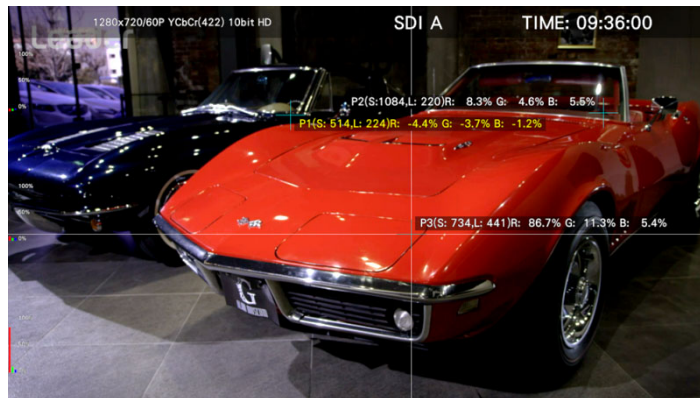

CINELITE ADVANCE FUNTION

PIC > **F-4** (CINELITE/HDR) > **F-2** (CINELITE ADVANCE)

> ON > Measurement points set on CineLite screen > P1 to P3 and REF as vector waveform screen and video signal markers can be displayed in conjunction with the waveform screen.



Leader

LV5300/LV5350/LV7300 Quick Manual

Cine Zone

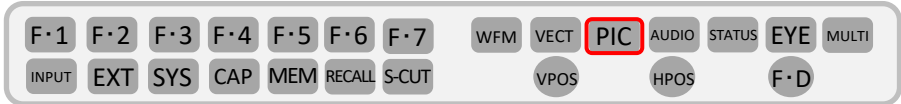

The cine zone has three functions.

1. The gradation display function, which replaces the brightness level of the picture with the color and displays it, shows the brightness distribution.
2. Saturation is understood by the function that sets a threshold for the brightness level and displays the part above or below it.
3. The search function displays the set brightness level in green and you can see the set brightness from the picture.

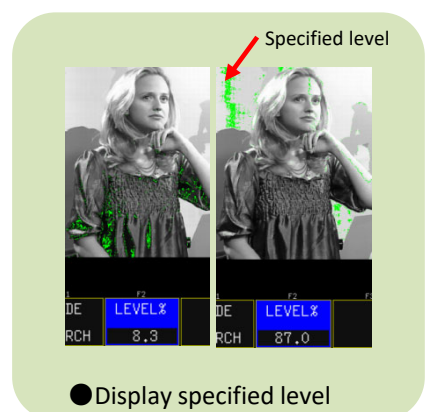
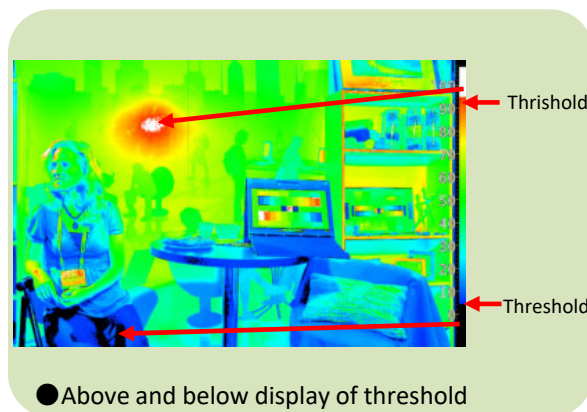
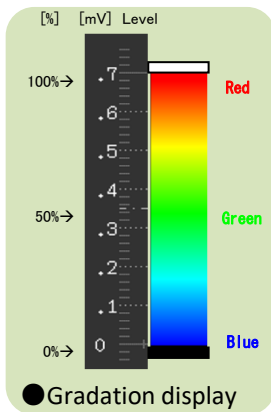

1. Gradation Display

Set **PIC** (PICTURE)> **F.2** (CINELITE or CINELITE / HDR)> **F.1** (CINELITE DISPLAY) to CINEZONE

Note: ● If you press **PIC** (PICTURE) and **F.2** is not (CINELITE or CINELITE / HDR), press **PIC** (PICTURE) twice.

2. Threshold setting

After setting the gradation display, press **F.2** (CINEZONE SETUP) and then **F.2** (UPPER) or **F.3** (LOWER) to set with **F.D** (FUNCTION DIAL).

F.2 UPPER: It can be set in the range of -6.3 to -109.4.

F.3 LOWER: It can be set in the range of -7.3 to -108.4.

3. Search level setting

After setting the threshold level, set **F.1** (CINEZONE FORM) to SEARCH.

Press **F.4** (LEVEL%) and set with **F.D** (FUNCTION DIAL).

Leader

LV5300/LV5350/LV7300 Quick Manual

Focus Assist

(LV5300-SER25, LV5350-SER25, LV7300-SER25)

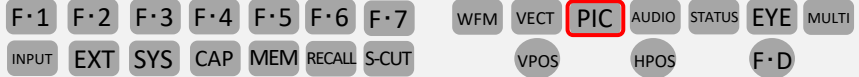

The focus assist display highlights the amount of detected edges to make it easier to check the focus.

(Note: This is not displayed when PICTURE MODE is FULL FRM.)

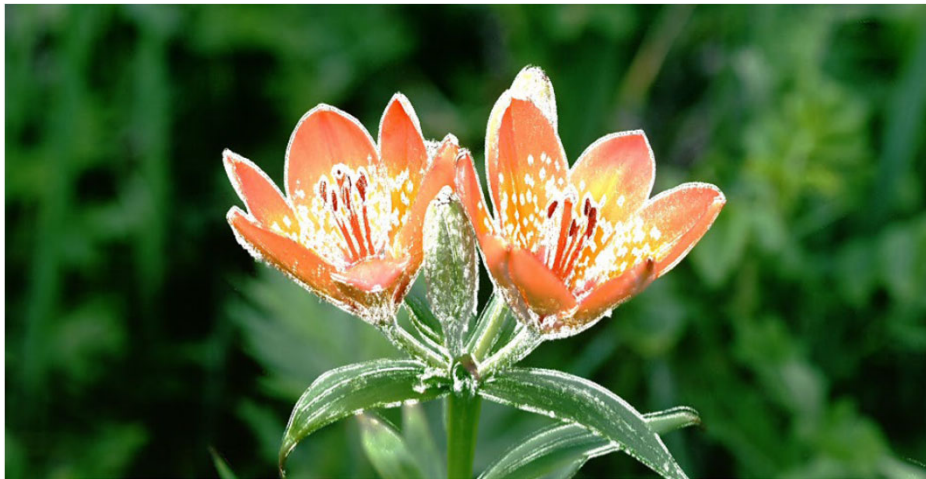

Focus assist display

Focus assist setting

Press **PIC** (PICTURE) > **F·4** (FOCUS)

1. Display mode selection **F·1** (SIZE) (Display size is selected.)
FIT/REAL/x2
2. Focus Assist ON / OFF **F·2** (FOCUS ASSIST) (Set the focus assist display on and off.)
ON/OFF
3. Detection sensitivity selection **F·3** (SENSITIVE) (Sets the detection edge sensitivity.)
LOW / MIDDLE / HIGH / V-HIGH / U-HIGH
4. Brightness level selection **F·4** (PICTURE LEVEL) (The brightness level of the picture display is adjusted.)
(Select OFF to hide the picture. Select EMBOSS to emboss the edges.)
5. Highlight color selection **F·5** (EDGE COLOR) (Select the display color of the detection edge.)
WHITE / RED / GREEN / BLUE

Leader

LV5300/LV5350/LV7300 Quick Manual

HDR display (No.1)

(LV5300-SER23, LV5350-SER23, LV7300-SER23)

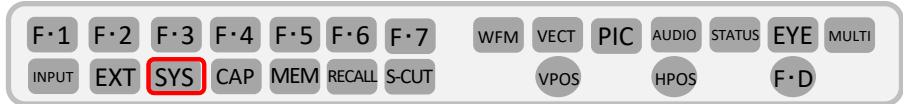

HDR system setting

- Select **SYS** (SYSTEM)> **F-1** (SIGNAL IN OUT)> **HDR** and set HDR MODE to HLG, PQ, S-Log3, C-Log, or Log-C according to the input signal.
- Ref.Level is the level setting at the boundary between HDR and SDR. Select a fixed value or put a check mark in VARIABLE to enable variable [range](#).

(The variable value can be changed by **PIC** > **F-2** (CINELITE / HDR)> **F-2** (CINEZONE SETUP)> **F-4** (REF [%]).)

- Range can be selected from Narrow and Full.
- The system gamma can be turned off / on.
- HLG Scale can be selected from 1200% or 100%.
- Use **F-D** (FUNCTION DIAL) or mouse to select / change.
- At the end of setting, press **F-1** (COMPLETE) to confirm.

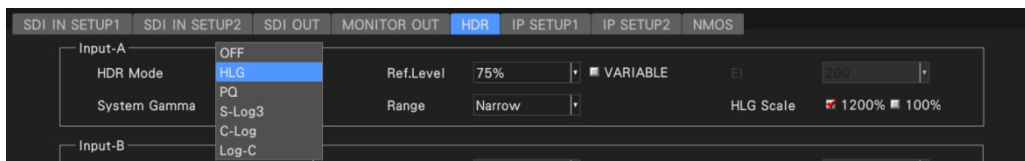

HDR Waveform display

- When **WFM** (WAVEFORM) is pressed after setting the HDR system, the waveform is displayed and the HDR scale appears on the right side.
 - Press **F-1** (WFM INTEN / CONFIG).
- Note: If **F-1** is not (WFM INTEN / CONFIG), press **WFM** (WAVEFORM) twice.
- Press **F-5** (WFM SCALE).
 - The following scale lines can be selected with **F-3** (SCALE SETTING)> **F-3** (SCALE DISPLAY).

- MAIN: Display SDI scale line and HDR reference scale line
- HDR : Display HDR scale line and HDR reference scale line
- BOTH: Displays SDI scale lines and HDR scale lines and HDR reference lines
- OFF : Only display HDR reference scale line

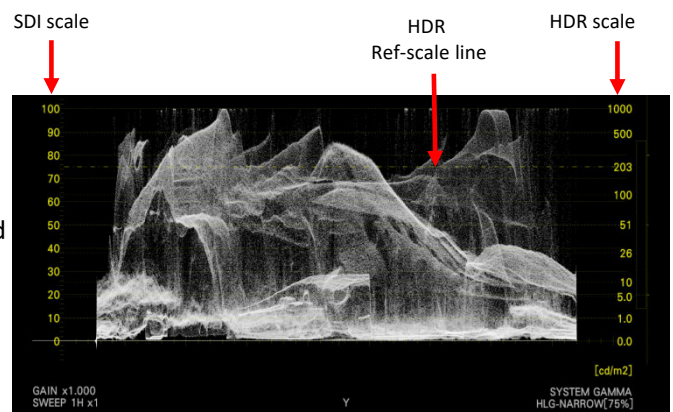

Leader

LV5300/LV5350/LV7300 Quick Manual

HDR display (No.2)

(LV5300-SER23, LV5350-SER23, LV7300-SER23)

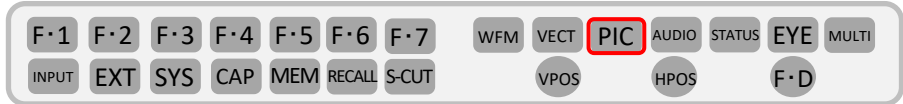

HDR ZONE display

• After setting HDR System, set **PIC** (PICTURE) > **F-2** (CINELITE / HDR) > **F-1** (CINEZONE DISPLAY) to CINEZONE.

Note: If you press **PIC** (PICTURE) and **F-2** is not (CINELITE / HDR), press **PIC** (PICTURE) twice.

- Turn on **F-4** (HDR ZONE).
- When **F-2** (CINEZONE SETUP) is pressed, UPPER, REF, and LOWER values are displayed in the upper left.
- The threshold of UPPER can be changed by changing **F-2** (UPPER). Areas that exceed the threshold are displayed in magenta on the picture.
- If you put a check mark in VARIABLE of Ref.Level in the System setting of HDR, **F-4** (REF LEVEL [%]) can be set.
- **F-7** (up menu) > **F-3** (MAX FALL / CLL) > **F-1** (MAX FALL / CLL DISPLAY) can be set to ON / OF of the display.
- START / STOP is possible with **F-2** (MEASURE).
- Press **F-3** (CLEAR) to clear the measured value.

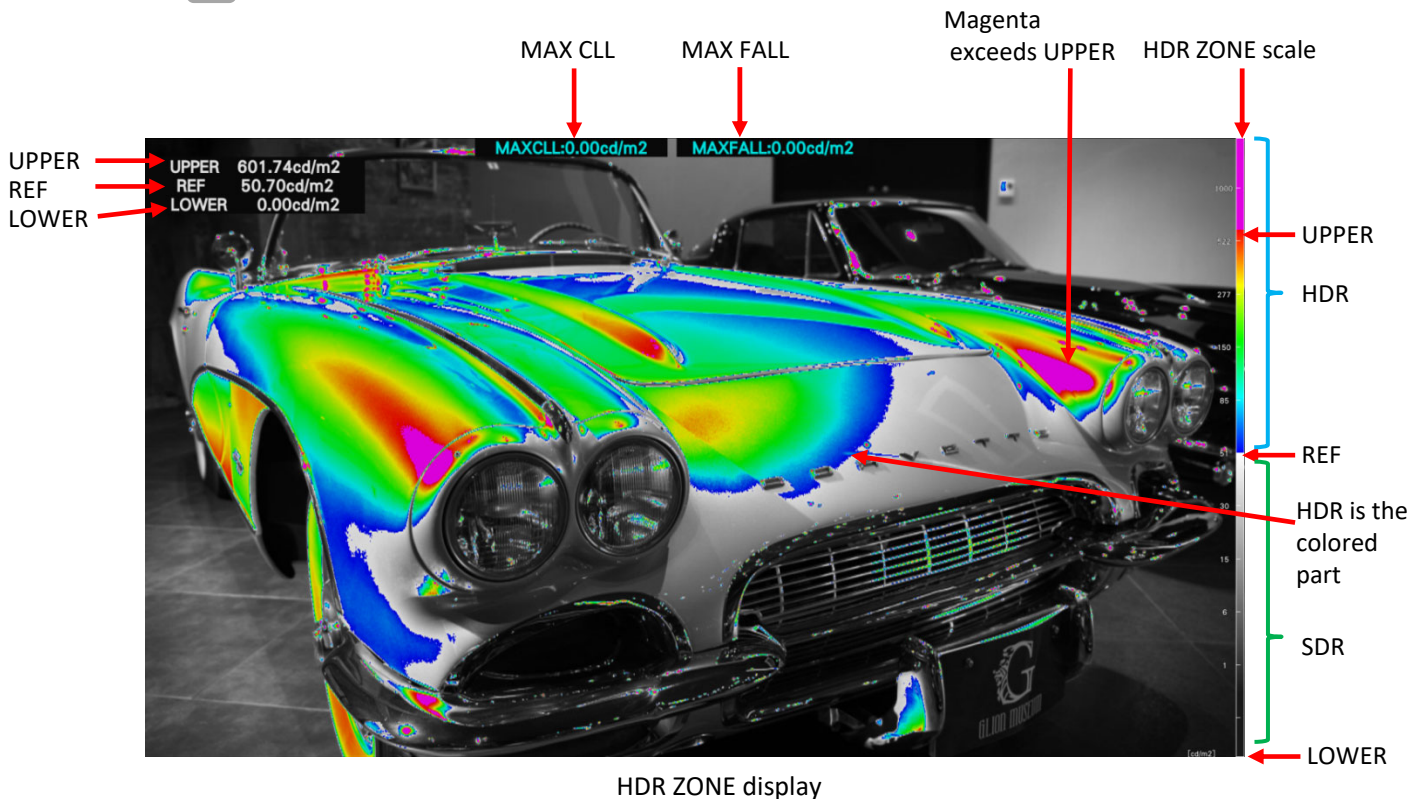

I can't distinguish between HDR and SDR even if I see the HDR content on the HDR monitor.
HDR ZONE displays HDR area, SDR area and areas that exceed the threshold in different colors.

Leader

LV5300/LV5350/LV7300 Quick Manual

AUDIO

(LV5300-SER20, LV5350-SER20, LV7300-SER20)

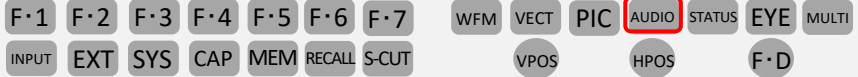

Press **AUDIO** (**AUDIO**)

AUDIO mapping setting

Note: If **F.7** is not (MAPPING), press **AUDIO** (**AUDIO**) twice.

Set **TARGET** in Au (**AUDIO**)> **F.7** (MAPPING).

- **INPUT**: EMB AUDIO: Measurement of embedded audio input to SDI INPUT
- **CH Mode**: Setting the number of measurement channels (8ch)
- **GROUP SELECT**: Audio group settings (G1/G2/G3/G4)
If the INPUT setting is SIMUL, you can also select the input channel.

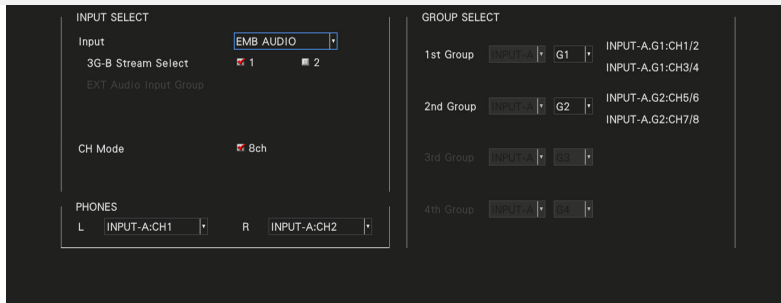

AUDIO display mode setting

F.7 (up menu) or **AUDIO** (**AUDIO**)> **F.1** (DISPLAY MODE)

Note: If **F.1** is not (DISPLAY MODE), press **AUDIO** (**AUDIO**) twice.

- **LISSAJOU**: View the Lissajous. An audio meter is also displayed.
- **SURROUND**: Surround is displayed on the left half and an audio meter is displayed on the right half. This cannot be selected during Simul mode.
- **STATUS**: Show status. An audio meter is also displayed.

LISSAJOU

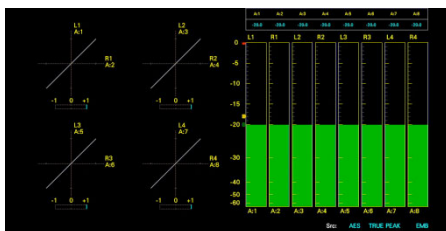

SURROUND

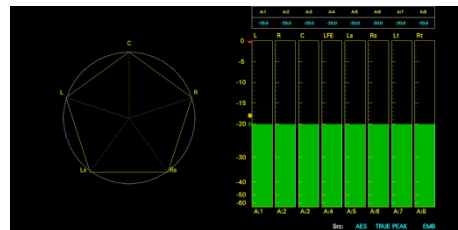

Leader

LV5300/LV5350/LV7300 Quick Manual

STATUS

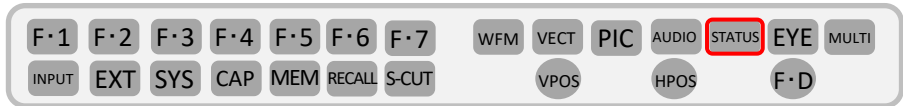

Press **STATUS** (STATUS).

Note: • If the display is different from the below even if you press **STATUS** (STATUS), press **STATUS** (STATUS) twice.

• For 2 screens, change the DISPLAY setting. Set **INPUT** (INPUT) > **F-7** (DISPLAY) to SINGLE.

● SIGNAL

Displays as "DETECT" or "NO SIGNAL" to check whether the SDI signal is **input connected** or not. In the case of "NO SIGNAL", the following items are not displayed.

● FORMAT/SUB IMAGE FORMAT

It shows the signal format. Usually, it is the blue one. If you put the incorrect signal format, it will be **shown in red**. Also SDI input **cannot be processed**.

● Freq (Frequency deviation)

Display **interface** sampling frequency deviation

Normally it is displayed in light blue, but by turning on Frequency Error on the ERROR SETUP 1 tab, it turns red when it exceeds ± 10 ppm.

● Cable (Cable length unit)

Converts the attenuation of the input signal into the length of the selected cable and displays it.

12 G: < 10m, 10~100m, > 100m (5m step)

3G: < 10m, 10~100m, > 100m (5m step)

HD: < 10m, 10~130m, > 130m (5m step)

SD: < 50m, 50~200m, > 200m (5m step)

● Embedded Audio

Displays the embedded audio channel superimposed on the input signal.

When the input signal is 3G-B-DL, only stream 1 is displayed.

3840x2160/59.94P YCbCr(422) 10bit 12G-TYPE1		SDI A				TIME: 09:46:35				
STATUS										
Signal	Sub Image Format	Freq.		Cable	Embedded Audio					
SUB 1	DETECT	1920x1080/59.94P TYPE1		-2.2ppm	60m	1,2,3,4,5,6,7,8,9,10,11,12,13,14,15,16				
SUB 2	DETECT	1920x1080/59.94P TYPE1				1,2,3,4,5,6,7,8,9,10,11,12,13,14,15,16				
SUB 3	DETECT	1920x1080/59.94P TYPE1				1,2,3,4,5,6,7,8,9,10,11,12,13,14,15,16				
SUB 4	DETECT	1920x1080/59.94P TYPE1				1,2,3,4,5,6,7,8,9,10,11,12,13,14,15,16				
ERROR										
SDI	SUB 1	SUB 2	SUB 3	SUB 4	ANC	SUB 1	SUB 2	SUB 3	SUB 4	
CRC	0	0	0	0	Check Sum	0	0	0	0	
TRS Position	0	0	0	0	Parity	0	0	0	0	
TRS Code	0	0	0	0						
Illegal Code	0	0	0	0						
Line Number	0	0	0	0						
Embedded Audio	SUB 1	SUB 2	SUB 3	SUB 4	Video Quality	SUB 1	SUB 2	SUB 3	SUB 4	
BCH	0	0	0	0	Freeze					
Parity	0	0	0	0	Black					
DBN	0	0	0	0	Gamut					
Inhibit	0	0	0	0	Cmp. Gamut					
Audio Sample	0	0	0	0	Level Y					
					Level C					
SinceReset 00:02:21										
¹ EVENT LOG	² SDI / IP ANALYSIS	³ ANC DATA VIEWER	⁴ ANC PACKET	⁵ STATUS SETUP	⁶ INPUT SELECT A	⁷ ERROR CLEAR				

ON / OFF of STATUS error **can be set by** by **F-5** (STATUS SETUP).

Leader

LV5300/LV5350/LV7300 Quick Manual

Payload ID display
SRLive Metadata display

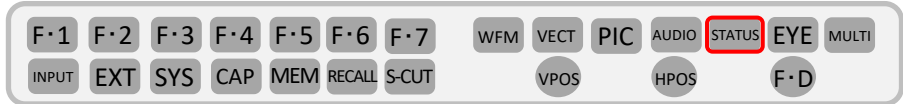

PAYLOAD display setting

PAYLOAD can be displayed by **STATUS** (STATUS)> **F.4** (ANC PACKET)> **F.1** (PACKET ANALYSYE)> **F.2** (PAYLOAD ID).

※Note: If you press **STATUS** (STATUS) and the STATUS screen is not displayed, or if (ANC PACKET) is not displayed on **F.4**, press **STATUS** (STATUS) twice.

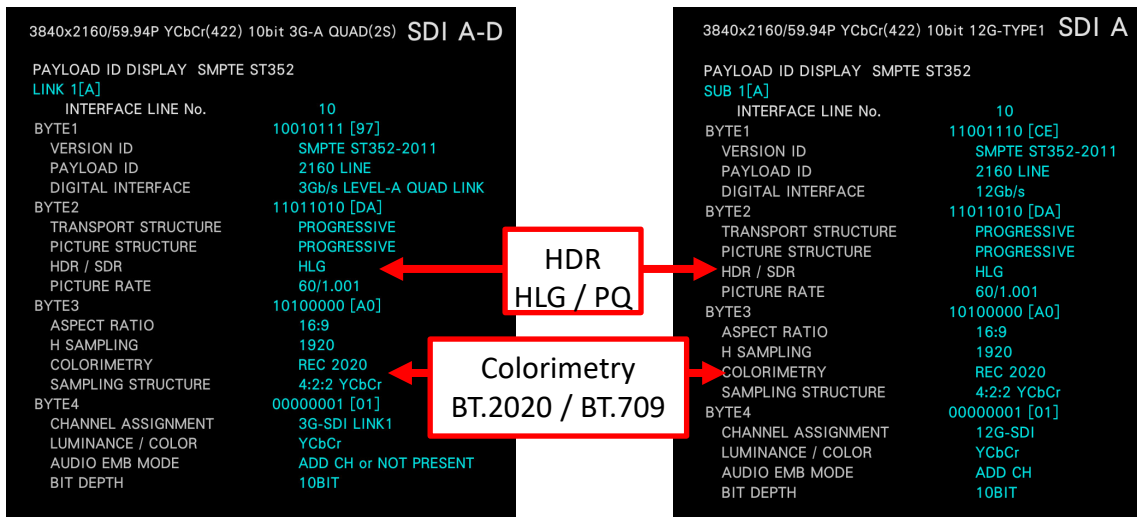

3G-SDI Quad Link: Link 1

12G-SDI: Sub image 1

SRLive Metadata display setting

SR Live Metadata can be displayed by **STATUS** (STATUS)> **F.4** (ANC PACKET)> **F.1** (PACKET ANALYSYE)> **F.4** (V-ANC)> **F.2** (SMPTE)> **F.6** (SR Live).

※Note: If you press **STATUS** (STATUS) and the STATUS screen is not displayed, or if (ANC PACKET) is not displayed on **F.4**, press **STATUS** (STATUS) twice.

No.	ITEM	VALUE	CTRL[Abs]	No.	ITEM	VALUE	CTRL[Abs]
1	Table Version	V 1.00	++	14	Knee	OFF	OFF
2	OETF	HLG	++	15	Knee Point	98%	[-15]
3	Transfer Matrix	BT.2020	++	16	Knee Slope	0.19	[+37]
4	Color Gamut	WIDE-BC	++	17	Knee Saturation	OFF	OFF
5	Conversion Mode	SR AIR ON	++	18	Knee Saturation Level	0.50	[+0]
6	HDR Look	Live	Live	19	Soft Knee	--	--
7	HDR Black Compression	ON	ON	20	Knee Radius	--	--
8	SDR Gain	-5.2dB	[-5.2dB]	21	SDR White Clip	ON	ON
9	Master Black	1.03%	[+4.7]	22	SDR White Clip Level	109%	[-94]
10	HDR Black Offset	Δ-0.99%	[-4.5]	23	HDR Knee	OFF	OFF
11	Gamma Table	STD 5	STD 5	24	HDR Knee Point	349%	[+0]
12	Gamma Step	0.45	0.45	25	HDR Knee Slope	0.65	[+0]
13	Gamma Level	0.95	[-12]				

Leader

LV5300/LV5350/LV7300 Quick Manual

EVENT LOG

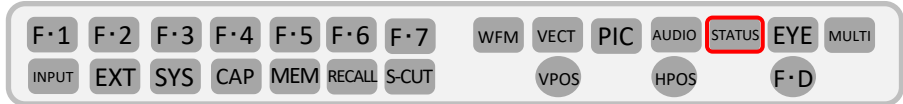

This can be displayed by **STATUS** (STATUS) > **F-1** (EVENT LOG).

In the event log, the events that have occurred are displayed in a list.

Note: • If the STATUS screen is not displayed by pressing **STATUS** (STATUS), press **STATUS** twice and then **F-1** (EVENT LOG).

- The event detection target is **for** all the channels **of** **from** currently selected A to D.
However, when measuring 3G-B-DS, 3G (DL) -4K, 12G, only events currently detected will be detected.
- **F-1** (LOG) Setting for START • STOP
- **F-2** (CLEAR) Delete the event log
Events can **log and** display up to 1000 items.
The operation when 1001 or more events occur is set in **F-3** (LOG MODE).
OVER WR: Overwrite and record from the old event.
STOP: After 1001 items, **no logging and display of events**.
- Turn the **F-D** to select the displayed event.

1920x1080/59.94P YCbCr(422) 10bit 3G-A SDI A TIME: 10:24:32

EVENT LOG LIST SAMPLE No.1000 << NOW LOGGING >>

CRC	EDH	TRS Position	TRS Code	Illegal Code	Line Number
1000: 2018/08/20 10:23:27	A	1920x1080/59.94P	CRC		
999: 2018/08/20 10:22:17	-	EMB-AUDIO			
998: 2018/08/20 10:22:17	A	1920x1080/59.94P			
997: 2018/08/20 10:22:17	A	1920x1080/59.94P	Black,		
996: 2018/08/20 10:22:16	A	1920x1080/59.94P	Freeze,Black,		
995: 2018/08/20 10:22:16	A	1920x1080/59.94P			
994: 2018/08/20 10:22:16	-	NO SIGNAL			
993: 2018/08/20 10:22:16	-	NO SIGNAL			
992: 2018/08/20 10:22:11	-	NO SIGNAL			
991: 2018/08/20 10:22:11	A	NO SIGNAL			

You can check all the Event log.
Color-coded error "not detected (white) / detection (red) / return (green)"

Event log example

Leader

LV5300/LV5350/LV7300 Quick Manual

Phase difference measurement

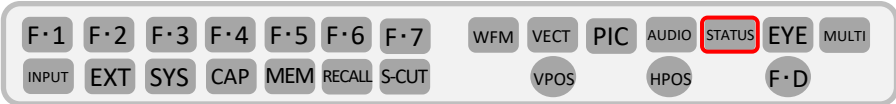

Phase difference measurement Setting (Not including 12G-SDI)

STATUS > F·2 (SDI ANALYSIS) > F·2 (EXT REF PHASE)

As a **The** reference signal for phase difference measurement, fr **F·1** (REF SELECT) to choose EXT, SDI or EXT, EXT REF Input signal, SDI is SDI A input signal. When the System setting is SD / HD / 3G-A / 3G-B **INPUT** **F·7** (DISPLAY) > **F·6** (SELECT CH) > Choose

(To use the EXT REF signal, when using EXT, press **F·6**)

F·1 (REF SELECT) -EXT > Press **F·2** (REF SET USER) > Phase difference can be zero

Return phase difference to initial setting, press **F·3** (REF SET DEFAULT)

F·4 (OH TIMING) Setting

LEGACY : When an external synchronization signal without timing offset and SDI signal output from our company's signal generator are received, set the phase difference to 0.

(This is the normal setting mode, such as in case of a third party product or a product that can not set SERIAL)

SERIAL : When the received external synchronization signal and the SDI signal have the timing defined by the signal standard, set the phase difference to 0.

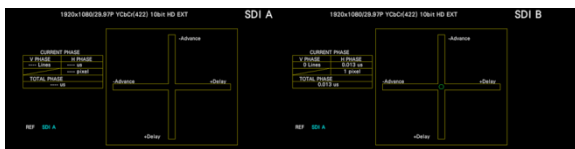

As the SDI A input becomes the reference, the phase difference measurement value is not displayed on the upper left.

2 input when REF SELECT:SDI

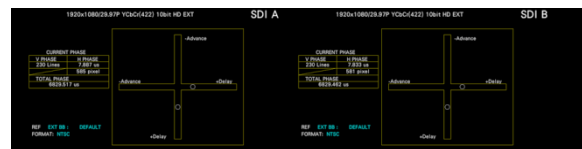

EXT Displays the phase difference of each SDI input to the REF input.

2 input when REF SELECT:EXT

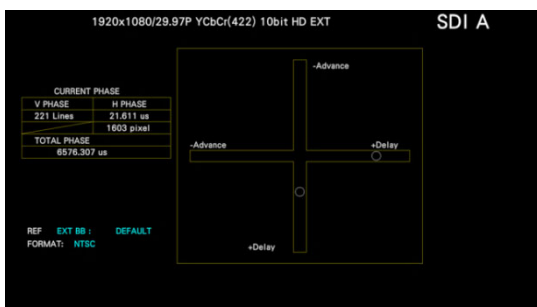

When the System setting is SD / HD / 3G-A / 3G-B-DL, measure the phase difference with the channel set with SELECT CH

HD input (SDI A input) when REF SELECT:EXT

Leader

LV5300/LV5350/LV7300 Quick Manual

AV PHASE(Lip Sync)
(LV5300/5350/7300-SER20)

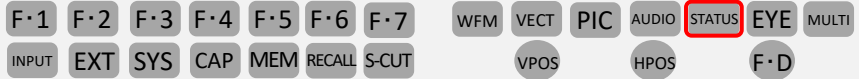

AV PHASE setting

AV PHASE (Lip Sync: Video and Audio delay) can be confirmed by inputting a lip sync pattern and measuring it.

The test pattern can be output from the LV5600-SER24, LV7600-SER24 TSG option or our sync generator LT4600A / LT4610 / LT4611 (with LT4611SER22).

A delay occurs when the test pattern is transmitted via a microwave or IP line.

AV phase measurement can be performed by **STATUS** (STATUS)> **F.2** (SDI ANALYSIS or SDI / IP ANALYSIS)> **F.3** (AV PHASE).

Note: If you press **STATUS** (STATUS) and the STATUS screen does not appear, press **STATUS** twice, then **F.2** (SDI ANALYSIS or SDI / IP ANALYSIS) and then **F.3** (AV PHASE).

You can change the scale max value setting with **F.1** (SCALE MAX).

Measurement can be performed in 3 to 4 cycles. It is refreshed by **F.2** (REFRESH).

To use another lip sync pattern, set it with **F.3** (AV PHASE SETUP).

It can be set while checking the timing of the test pattern with **PIC** (PICTURE)> **F.5** (LINE SELECT)> **F.4** (AV PHASE).

This setting is not necessary when using our lip sync pattern.



Lip Sync test pattern

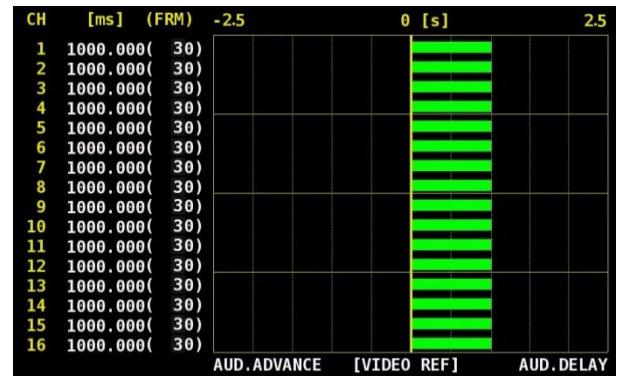

AV PHASE measurement screen

Leader

LV5300/LV5350/LV7300 Quick Manual

EYE

(LV5300, LV7300-SER02)

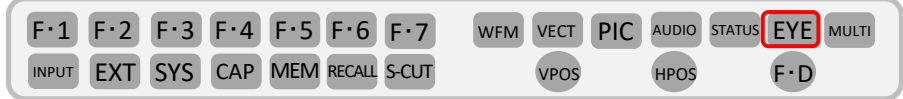

Switching between EYE and JITTER

EYE > **F.1** (EYE/JITTER INTEN/CONFIG) > **F.1** (EYE/JITTER) select EYE or JITTER display

Note: If **F.1** is not (EYE / JITTER INTEN / CONFIG), press **EYE** (EYE) twice.

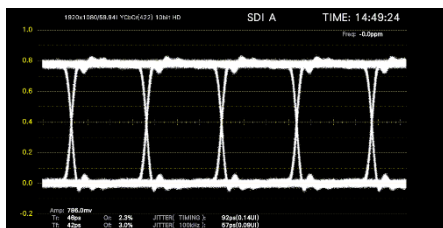

EYE display

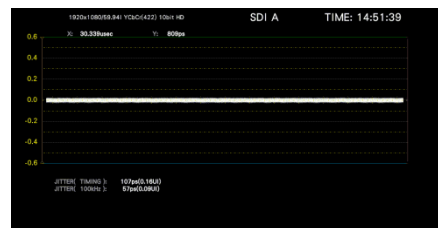

JITTER display

(Note: The EYE function display of LV5300 and LV7300-SER02 is only compatible with SDI INPUT1. SDI INPUT2 is not supported.)

Filter setting

EYE (EYE) > **F.2** (GAIN/FILTER/SWEEP) > **F.3** (FILTER)

Note: If **F.2** is not (GAIN / FILTER / SWEEP), press **EYE** (EYE) twice.

- 100kHz: Jitter at 100 kHz or higher is measured.
- 1kHz: Jitter at 1 kHz or higher is measured.
- 100Hz: Jitter at 100 Hz or higher is measured.
- 10Hz: Jitter at 10 Hz or higher is measured.
- TIMING: Timing jitter is measured. Jitter at 10 Hz or higher is measured.
- ALIGNMENT: Alignment jitter is measured. When the input signal is not SD, jitter at 100kHz and higher is measured. When the input signal is SD, jitter at 1 kHz and higher is measured.

The selected filter is applied to the upper value of the automatic jitter measurement and the EYE and JITTER display.
(For the simultaneous display of EYE and JITTER, refer to "Change layout (general) — example2 —".)

SINGLE display and DUAL display

EYE (EYE) > **F.7** (DISPLAY MODE) can switch the display between DUAL and SINGLE.

Note: If **F.7** is not (DISPLAY MODE), press **EYE** (EYE) twice



DUAL display

The upper part shows the applied filter, and the lower part shows the TIMING jitter.

Leader

LV5300/LV5350/LV7300 Quick Manual

Layout Settings (single)

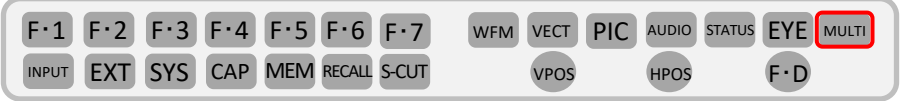

Layout system settings

• DISPLAY setting: Set **INPUT** (INPUT) > **F.7** (DISPLAY) to SINGLE.

* The user layout can be freely changed with the mouse by adding layout options (LV5300/5350/6300-SER26). Please refer to P33 and after for layout changes.

Note: The layout called with this setting is the factory setting. If the layout settings have been changed individually, the corresponding layout will be called.

How to use the registered layout settings

Press **MULTI** and **F.1** to select LAYOUT USER 1-6.

USER 1

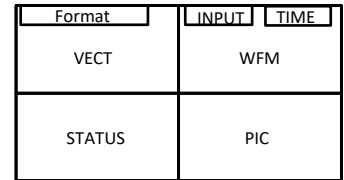

USER 2

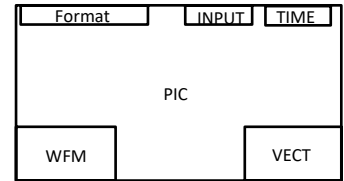

USER 3

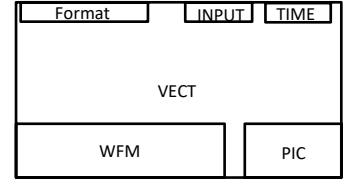
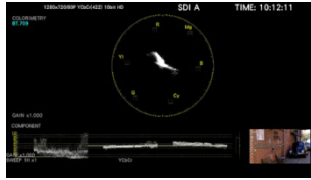

USER 4

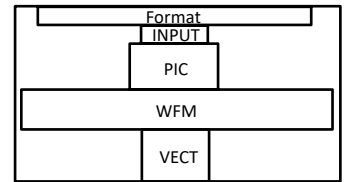
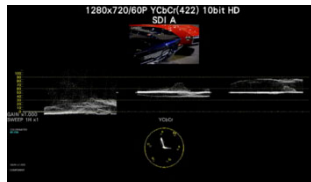

USER 5

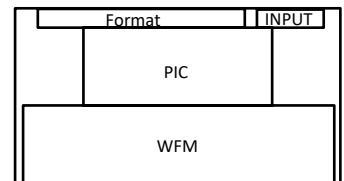
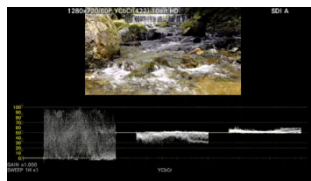

USER 6

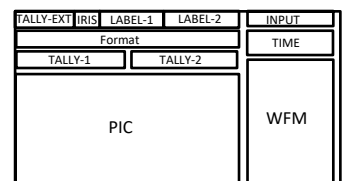

Leader

LV5300/LV5350/LV7300 Quick Manual

Layout Settings (SIMUL)

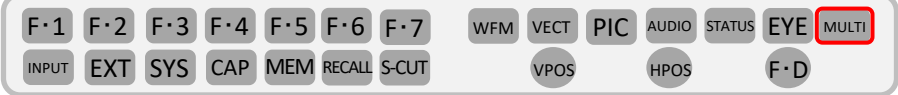

Layout system settings

• DISPLAY setting: Set **INPUT** (INPUT)> **F-7** (DISPLAY) to SIMUL.

• When the System setting is SD / HD / 3G-A / 3G-B-DL and **INPUT** > **F-7** (DISPLAY) is SIMUL setting, The layout changes depending on ON / OFF of **INPUT** > **F-1** to **F-2** (A, B).

How to use the registered layout settings

Press **MULTI** and **F-1** to select LAYOUT USER 1-6.

Example	1 INPUT(A)	2 INPUT(A,B)
USER 1		
USER 2		
USER 3		
USER 4		
USER 5		
USER 6		

Leader

LV5300/LV5350/LV7300 Quick Manual

Screen Capture

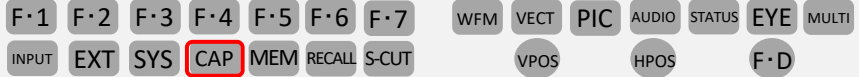

1. Screen capture settings

Change the display tab to **CAPTURE&DISPLAY** with **SYS** (SYSTEM)> **F-2** (SYSTEM SETUP)> **F-3** (NEXT TAB).

Use **F-D** (FUNCTION DIAL) to set Capture Mode to "Screen" and select the file type to save to USB memory from FILE TYPE "BMP", "BSG". At the end of the setting, press **F-1** (COMPLETE) to confirm.

BMP : The saved data can be confirmed on the PC.

BSG : The saved data can be read and displayed on the LV5300/5350 and LV7300 main units.

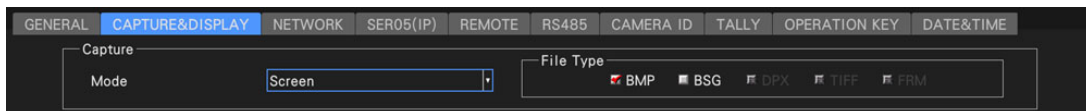

(PCAP is a mode to capture IP packet when LV5600SER05 is installed.)

2. Perform screen capture

- Display the screen to be captured.
- Press **CAP** (CAPTURE). (When you press **CAP**, the display screen is captured in the internal memory.)
- Select the following with **F-3** (DISPLAY).
 - REAL: Displays the current input signal
 - HOLD: View the captured data. Video waveforms, vectors and eye patterns are displayed in cyan.
 - BOTH: The brightness of the current input signal and the capture data is halved, and they are displayed in layers.

3. Save to USB memory

- Insert the USB memory. The USB memory is recognized and  is displayed in the upper right of the screen.
- Press **F-6** (USB MEMORY)> **F-3** (STORE) to save to a USB memory.

Screen capture data is saved to the following locations.

- ↳ USB memory device
 - ↳ LV5300_USER, LV5350_USER or LV7300_USER
 - ↳ BMP
 - ↳ yyyyymmddhhmmss.bmp
 - ↳ yyyyymmddhhmmss.bsg

4. Capture data display of USB memory

- Captured data saved in USB memory in BSG format can be returned to the main unit for display, and can be overlaid with the current input signal.
- Connect a USB memory to the main unit, and press **CAP** (CAPTURE) > **F-6** (USB MEMORY)> **F-5** (RECALL).
- Select a BSG format file with **F-D** (FUNCTION DIAL) from the displayed file list and press **F-1** (RECALL) to display the captured screen.

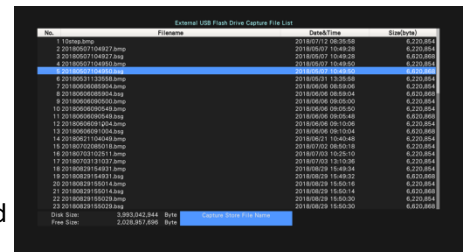

Leader

LV5300/LV5350/LV7300 Quick Manual

Signal Out-put

(LV5600-SER24,LV7600-SER24)

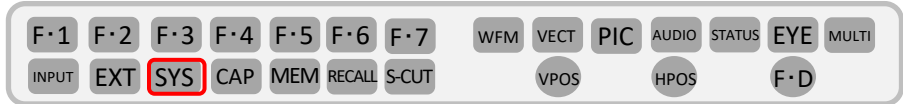

SYS > **F·1** (SIGNAL IN OUT)

F·2 (PREV TAB), **F·3** (NEXT TAB) > Choose **SDI OUT**

Use **F·D** > Output Mode > Mode: Test Signal

Set the Test Signal item using **F·D** according to the output signal.

At the end of the setting, press **F·1** (COMPLETE) to confirm.



Initialize Setting

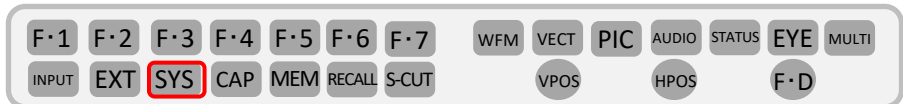

SYS > **F·7** (INITIALIZE)

- **F·1** (PARAM INIT YES): Other than the setting below are initialized
 - the setting of network (NETWORK type)
 - the setting of remote(REMOTE type)
 - the setting of RS-422/485(RS485 type)
 - the setting of camera ID (Local ID Setting is not including) (CAMERA ID type)
 - the setting of date & time (DATE&TIME type)
 - the content of pre-set
 - Layout setting of measurement screen
- **F·2** (LAYOUT INIT YES): Only the layout setting will be initialized
- **F·3** (OPETATE INIT YES): Only the operation key will be initialized
- **F·4** (ALL INIT YES): PARAM INIT and LAYOUT INIT will be initialized at the same time

Factory setting : Performs initialization including PARAM INIT (excluding date and time settings).

Turn on the power while pressing **VPOS** and **HPOS** , and execute with **F·3** (SRAM / FLASH INIT YES).

How to check the version?

SYS > **F·3** (SYSTEM INFO)

Leader

LV5300/LV5350/LV7300 Quick Manual

Preset Register / Delete

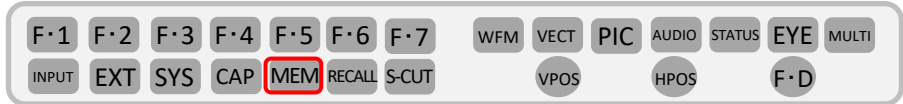

This is a function to register up to 60 panel settings.

All items except Ethernet, remote, RS-422/485, camera ID, date setting are registered.

To register / delete settings, press **MEM**. Use **F.D** to select the preset number to register / delete.

To register, press **F.2** (STORE) on the registration screen. (Delete with **F.3** (DELETE).)

Enter the registered file name by pressing **F.1** (COMMENT INPUT).

The input method is as follows, use function key **F.D** and or mouse to control.

- F.1** (CLEAR ALL) : Delete all the word
- F.2** (DELETE) : Delete the character on the cursor
- F.3** (INSERT) : Insert the selected character at the cursor position
- F.4** (<=) : Move the cursor to the left
- F.5** (=>) : Move the cursor to the right
- F.6** (CHAR SET) : Typing
- F.D** : Turn and select characters, press and enter letters.

In the case of the USB mouse, enter the pointer by left clicking in accordance with the character you want to input.

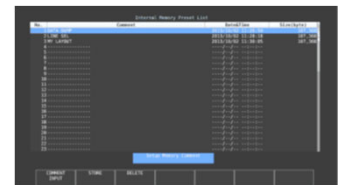

Pre-set registration screen



Pre-set comment input screen

Next, press **F.7** (up menu) > **F.D** to choose pre-set number > **F.2** (STORE) > finish

Pre set recall



The preset call is called from the preset registered preset number.

Press **RECALL**, you can check the pre-set number from function menu.

Use **F.7** or **F.D** > check more pre set

No.1 DATA DUM P	No.2 LINE SEL	No.3 MY LAYOU T	No.4	No.5	No.6	more
F.1	F.2	F.3	F.4	F.5	F.6	F.7

Leader

LV5300/LV5350/LV7300 Quick Manual

Change Layout — basic — (LV5300/5350/7300-SER26)

You can change the layout from each of the measurement screen (WFM, VECT, PIC, AUDIO, STATUS, EYE) (only one), and MULTI measurement screen (USER1 ~ 6)

Use mouse from the front panel to set up > Display the screen you want to change the layout. From WFM, VECT, PIC, MULTI (USER1) > Right-click the mouse on the screen > Layout

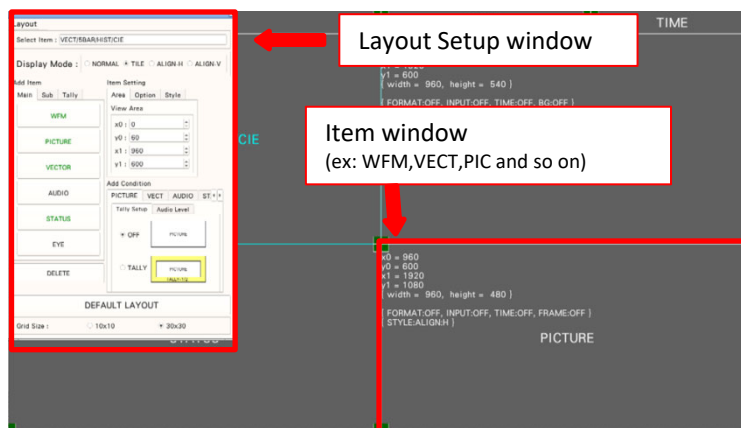

Layout procedure

Here, three basic examples and application examples are introduced.

Basic example P.37

Procedure for changing the layout of MULTI (USER1) (adding audio items, etc.)

- ① Display of layout screen
- ② Item change from TIME to DATE in the upper right of the screen
- ③ Overlay the vector waveform on the picture
- ④ Add audio item
- ⑤ Add TIME to STATUS item
- ⑥ Confirm changes

Application example P.39

Procedure to change the layout of MULTI (USER1) (simultaneous display of VECT and CIE charts)

- ① Display of layout screen
- ② Delete all items on the screen
- ③ Add VECT item
- ④ Add CIE item
- ⑤ Confirm changes

Application example P.41

Procedure for changing the EYE layout (simultaneous display of EYE measurement and Jitter measurement)

- ① Display of layout screen
- ② Delete EYE / JITTER display
- ③ Select / add EYE and Jitter items
- ④ Format, Input, Time item display
- ⑤ Confirm changes

Leader

LV5300/LV5350/LV7300 Quick Manual

Change Layout (General) — example — (LV5300/5350/7300-SER26)

(example) change the layout from MULTI(USER1) (add audio item)

- ① Show the layout screen
- ② Item change from TIME to DATE in the upper right of the screen
- ③ Place vector display on picture display
- ④ Add audio measurements display
- ⑤ Add TIME to STATUS item display
- ⑥ Complete

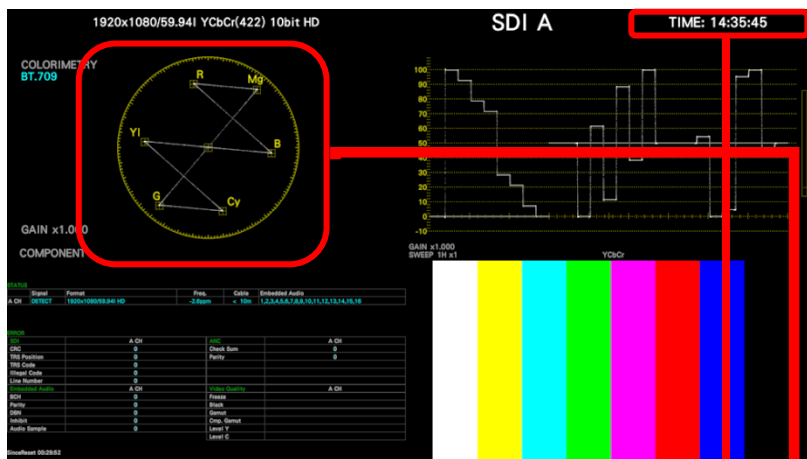

Before

② TIME → DATE

③ move VECTOR

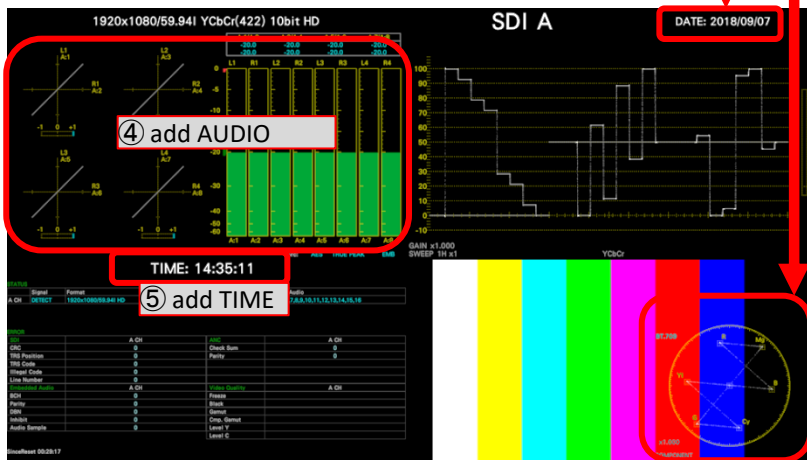

After

Leader

LV5300/LV5350/LV7300 Quick Manual

Change Layout (process) — example — (LV5300/5350/7300-SER26)

① Display of layout

- Long press **MULTI** > Press **F-1** (LAYOUT user1)
(There are six layouts of USER 1 to USER 6 for multi display)
- Select LAYOUT of the window displayed by right click on the measurement screen and display the layout screen

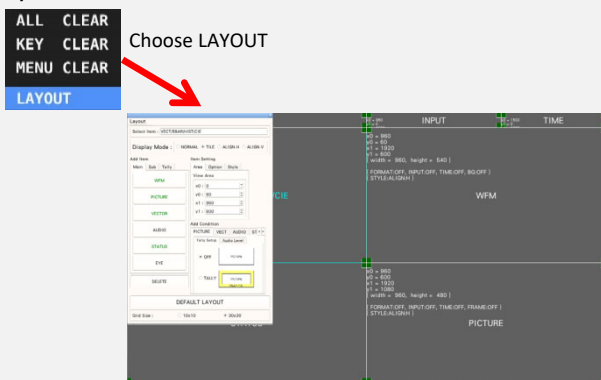

② Change TIME at the upper right of the screen to DATE

- Click the TIME item in the upper right of the screen and select it.
(The color and letters of the TIME item frame change to light blue, Select item in Layout Setup window to TIME.)
- Layout Setup window > DELETE key > delete TIME
- Add Item > Click on the DATE item in the tab.
- Change the size of DATE > Use the mouse to decide the place.

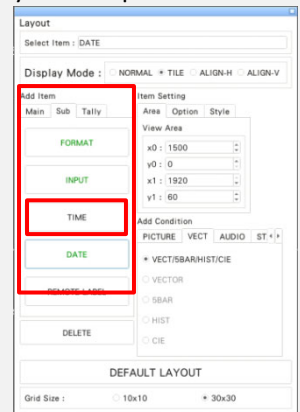

③ Place vector waveform on picture

- Select the VECT item in the Main Item tab of the Add Item and click the Click Background Transparent.
- Place the VECT item on the picture and resize it.

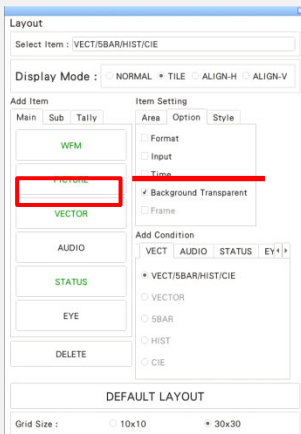

④ Add AUDIO

- Click the AUDIO from Main tab, change the place

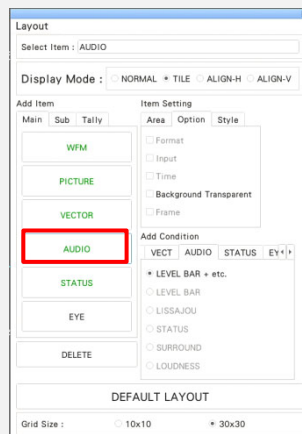

⑤ Add TIME into status

- Click STATUS, click Time from Option (Option tab Time cannot change the display place ,size)



⑥ Check

Right-click on the layout screen and click SAVE.

Leader

LV5300/LV5350/LV7300 Quick Manual

Change layout (general) — example1 — (LV5300/5350/7300-SER26,-SER22)

(example) MULTI(USER1)How to change the layout? (Show VECT and CIE chart at the same time)

- ① Show the display
- ② Delete all the items
- ③ Add VECT item
- ④ Add CIE item
- ⑤ Finish

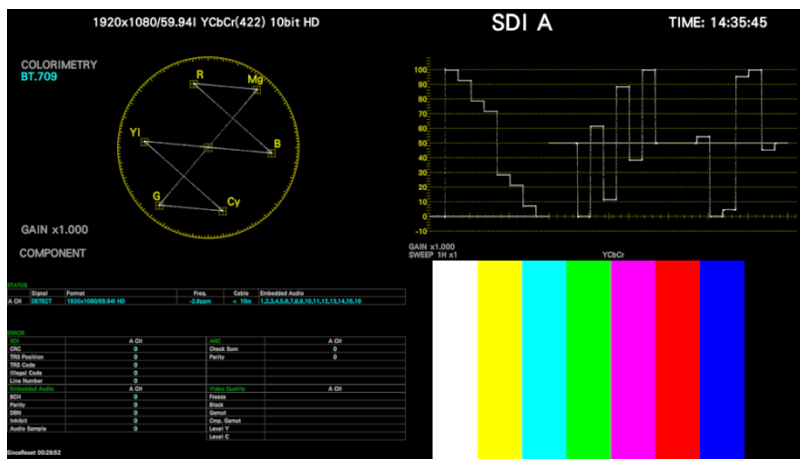

Before

MULUTI (USER1) Delete all the items, then add VECT and CIE Chart.

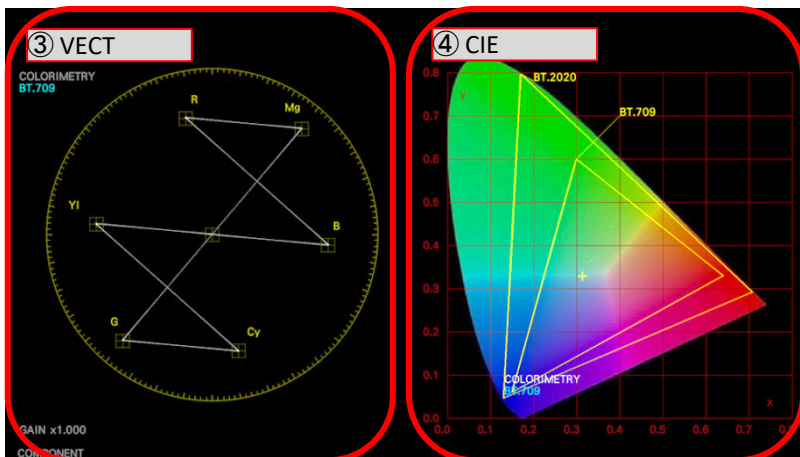

After

Leader

LV5300/LV5350/LV7300 Quick Manual

Change layout(process) — example 1 — (LV5300/5350/7300-SER26,-SER22)

① Show the layout screen

- a. Press **MULTI** > Choose **USER 1 F·1** (LAYOUT SELECT)
(There are six multi displays from USER 1~USER 6)
- B. Right click on the measurement screen to display the window, select **LAYOUT** and display the layout screen.

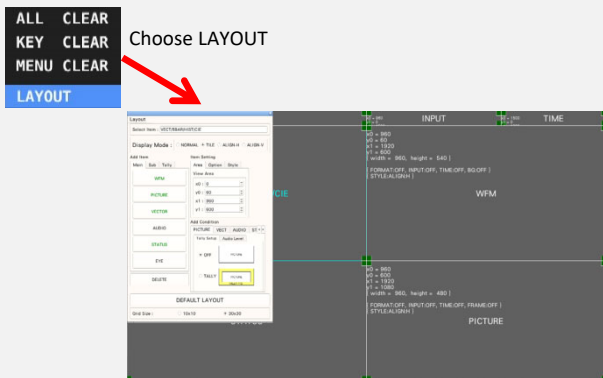

② Delete all items

- a. Click the **DELETE** item at the bottom left of the screen. The item displayed will disappear each time you click it. Click a few times to delete all displayed items.

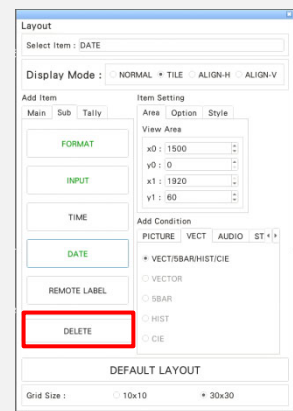

③ Add VECT

- a. Add Condition > **VECT** tab > choose **VECT**
- b. Add Item > **Main** tab > click **VECT** item
- c. Move **VECT** item to picture > change size

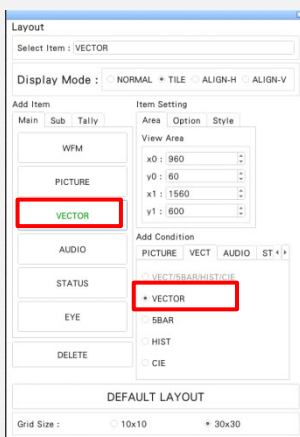

④ Add CIE chart

- a. Add Condition > **VECT** tab > choose **CIE**
- b. Add Item > **Main** tab > click **VECT** item
- c. Move **CIE** item to picture > change size



⑤ Finish

- a. Right-click on the layout screen > **SAVE**

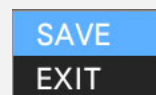

PS: Color Triangle setting

- a. Press **VECT**
- b. Press **F1]VECT INTEN/CONFIG**
- c. "F1" **VECT** DISPLAY to **CIE DIAGRAM** to set up
- d. Press **F7]up** menu, then press **F2]CIE DIAGRAM SCALE**
- e. **F2]TRIANGLE1**·**F3]TRIANGLE2** to **OFF/ON**

Leader

LV5300/LV5350/LV7300 Quick Manual

Change layout (general) — example2 — (LV5300-SER26,LV7300-SER02/26)

(example) How to change EYE layout display? (EYE display and Jitter at the same time)

- ① Layout screen display
- ② Delete EYE/JITTER
- ③ EYE or Jitter item choose / add
- ④ Show Format, Input, Time item
- ⑤ Finish

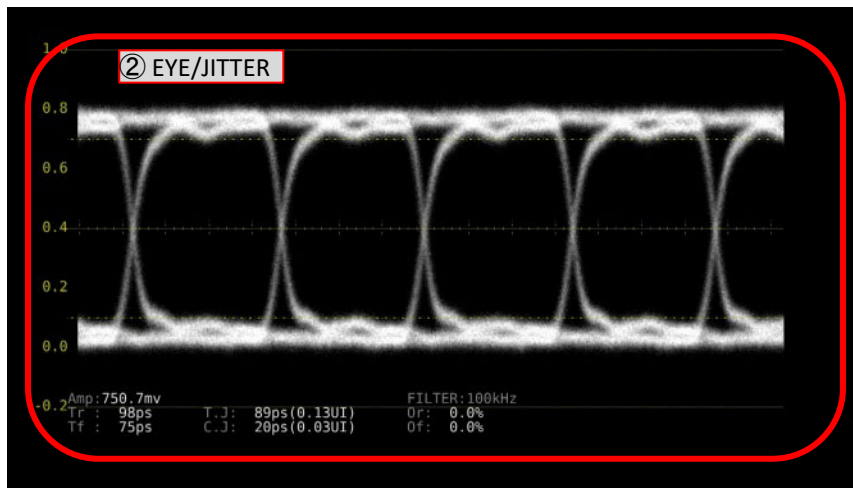

Before

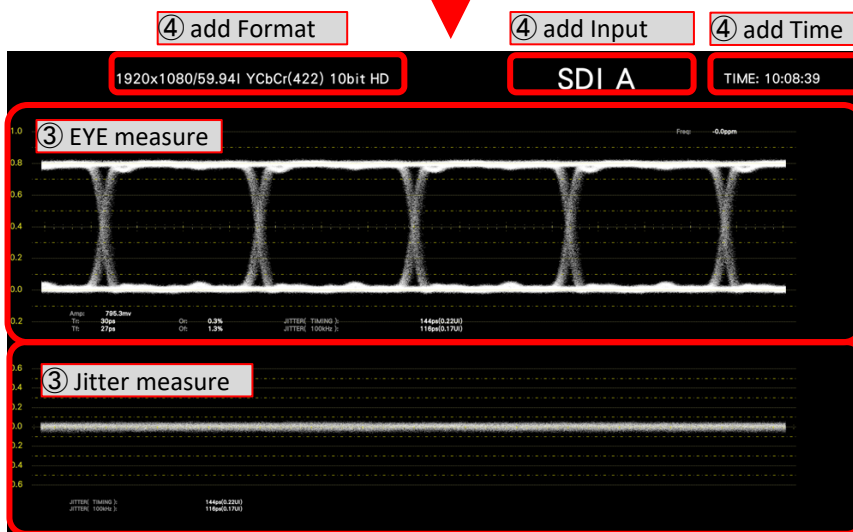

After

Leader

LV5300/LV5350/LV7300 Quick Manual

Change layout(Process) — example 2 — (LV5300-SER26, LV7300-SER02/26)

① Layout screen display

- Press **EYE** to show the screen
- Select LAYOUT of the window displayed by right click on the measurement screen and display the layout screen

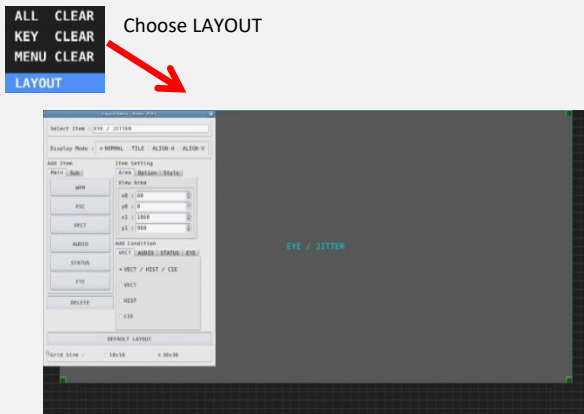

② Delete EYE/JITTER item

- Click the TIME item in the upper right of the screen and select it. (The color and letters of the TIME item frame change to light blue, Select item in Layout Setup window to TIME.)
- Layout Setup window > Use DELETE key to delete EYE/JITTER



③ choose/add EYE and JITTER item

- Add Condition > EYE tab > EYE > Main > Press EYE > Add EYE item
- You can change item and size.



④ Format, Input, Time item display

- Add Item > Sub > add FORMAT, INPUT, TIME
- Every items can change the place.



⑤ Finish

- Right click on the layout screen, SAVE.

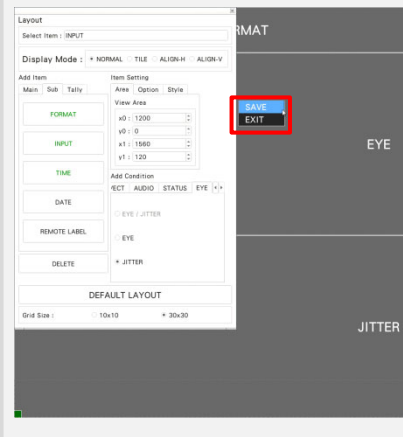

PS: Default setting

By pressing DEFAULT LAYOUT at the bottom of the setting in the Layout Setup window, you will return to the default setting .

Leader

LV5300/LV5350/LV7300 Quick Manual

Operation Key

With the operation keys, frequently used items (waveform format, gain and vector gain, etc.) can be easily changed with the soft keys (icons) using the mouse or touch panel.

• Operation key setting

- It is set on **GENERAL** of **SYS** > **F·2** (SYSTEM SETUP)
- Set the Auto Off function of the On-screen Menu to Off.
- Turn on the Operation Key.
- When using the touch panel, select Enable of Touch Panel.
- Confirm the setting with **F·1** (COMPLETE).

• Operation key operation

- Press **WFM** (WAVEFORM) to display the waveform.
- The operation key is displayed at the bottom right of the screen. Click it with the mouse or touch panel.



- FORM:** Waveform and vector format changes
- OVLAY:** Change waveform overlay settings
- FILTER:** Change waveform filter settings
- GAIN:** Waveform and vector gain change
- GAIN-MAG:** Waveform and vector scaling
- SWEEP:** Change waveform sweep
- SWEEP-MAG:** Set the horizontal magnification
- SHORT CUT:** Various function assignments such as cursor and capture.

• Operation key setting

- Change the display tab to **OPERATION KEY** with **SYS** > **F·2** (SYSTEM SETUP) > **F·3** (NEXT TAB).
- Change each item and press **F·1** (COMPLETE).
- Select SKIP to skip an item.

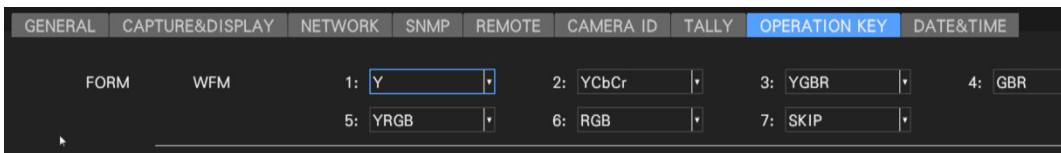

Example of using operation keys

- Ex: FROM WFM
- No.1: Y
- No.2: GBR
- No.3: YPbPr
- No.4~7 setup: SKIP

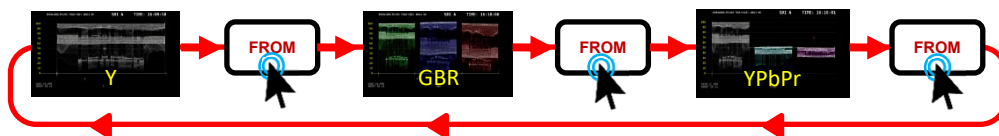

Leader

LV5300/LV5350/LV7300 Quick Manual

URL : <https://www.leader.co.jp> email: sales@leader.co.jp

※Product specifications are subject to change without notice.