



LV5300 WAVEFORM MONITOR

4K 12GSDI 3GSDI HDSDI
SDSDI EYE

LV5350 WAVEFORM MONITOR

4K 12GSDI 3GSDI HDSDI
SDSDI

LV7300 RASTERIZER

4K 12GSDI 3GSDI HDSDI
SDSDI EYE

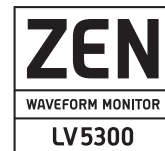

/ General

The LV5300/LV5350/LV7300 are a space-saving, compact WAVEFORM MONITOR specialized for 4K/HD/SD-SDI video signals. The LV5300/LV5350 are a waveform monitor with a 7-inch touch screen display in a compact 3 U enclosure operative with battery power supply. LV7300 is a 1U half rack size rasterizer. It is compact but supports eye pattern measurement up to 12 G-SDI.

/ Features

Supports various signal inputs
Various SDI signals up to 12 G-SDI can be observed/monitored.
Audio signals can correspond to SDI embedded voice.

Excellent operability
With the front panel equipped with key buttons and knobs that follow the operability of conventional models, operation with a USB mouse is also possible. In addition, the LV5300/LV5350 adopt a 7-inch full HD panel with a touch panel function, and the LV7300 can be operated and set intuitively by touch operation by connecting an external LCD adopted touch panel with a USB cable.
* It does not guarantee operation with external LCD monitors
+++adopted by all touch panels.

SDI input format
SD-SDI, HD-SDI, 3G-SDI, 12G-SDI Single Link is supported.

Transmission quality analysis function
In addition to monitoring of various transmission errors, external synchronization phase difference display, lip sync measurement, SDI signal frequency deviation measurement function, an ancillary data analysis function with increased importance as a 4K video signal is also realized.

Video analysis function

Various video signals include video signal waveform display, vector display, picture display 5 BAR display, CIE chromaticity diagram display, CINELITE, etc.

In addition to the various displays, freeze error, Black error, gamut error detection Function etc. Quality control (QoE) of video signals Functions Features are equipped.

xy chromaticity coordinate display

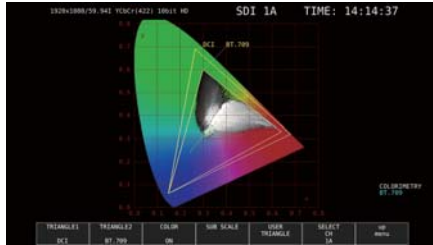

Voice analysis function

For audio signals, SDI signals and audio signals superimposed on SDI signals can be displayed on a level meter. Furthermore, Lissajous display, mute, clip error detection, loudness measurement, etc. are available. Audio format is compatible with L-PCM.

Eye pattern display

From SD-SDI to 12G-SDI

In the physical layer measurement of the SDI signal Some eye pattern display, and jitter display is possible.

Eye pattern

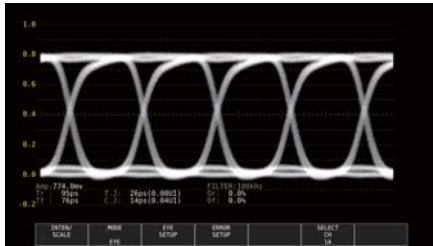

Subtitles/closed caption decode display function

Japanese subtitles and CEA-608, CEA-708 closed caption, Teletext, OP47 subtitle superimposed on SDI signal can be decode displayed.

External synchronization signal input

The phase difference and synchronization status of each SDI video signal graphically based on the external synchronization signal (black burst, tri-level sync) can be confirmed.

Customizable layout

Various items such as video signal waveforms, vector waveforms, and pictures of input signals can be laid out in any position with your preferred size.

SDI signal generation function

SDI signal generation function supports SD-SDI, HD-SDI, 3G-SDI, 12G-SDI single link. Simplified UHDTV multi-format color bar and pattern corresponds to the multiple overlays of moving boxes and embedded audio, flat field pattern can be specified at any level, multiformat color bar 4K can be selected.

* For 4K format only 12G-SDI is possible.

External monitor output

Since the measurement screen can be output as SDI and TMDS from the monitor output terminal, it can be displayed on an external SDI monitor or HDMI monitor with full HD resolution.

* Does not guarantee the operation with all HDMI monitors.

* The LV 5300 / LV 5350 do not support external monitor output.

Capture function

It is equipped with a screen capture function to capture the display screen as still image data and a frame capture function.

Time code display

The time code superimposed on SDI signals can be displayed. The time code can also be used as the timestamp of the event log.

External remote terminal

The presets can be recalled by contact terminals, and switching input signals and tally displays and outputting alarms can be conducted.

Ethernet terminal

By connecting to the PC, remote operation by TELNET, file transfer by FTP, remote operation by SNMP and alarm notification, remote operation and monitoring from the browser via HTTP can be done.

HDR

The level management is possible at the assumed luminance (cd/m²) in a display considering HDR signal level monitoring and OOTF. The video signal waveform display corresponds to the HDR scale added to the IRE scale. In the cine zone display, the luminance distribution of the HDR area can be easily confirmed at the state where the SDR area is monochrome, the HDR is colored according to the brightness.

HDR zone display

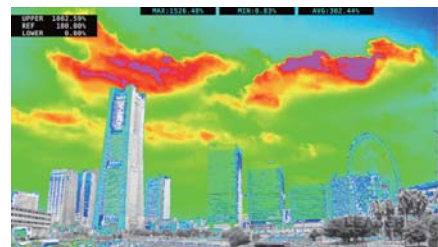

Focus Assist

We developed a new focus detection algorithm based on nonlinear super-resolution technology, and accordingly the focus with high sensitivity can be detected even with low-contrast images, which were conventionally difficult to detect.

Tally display

Fast switching of tally display by remote terminal is also possible.

List of hardware options

Model Name	Type Number			Description
	LV5300	LV5350	LV7300	
SDI INPUT	—	LV5350 standard	LV7300-SER01	SD, HD, 3G SDI input
SDI INPUT/EYE	LV5300 standard	—	LV7300-SER02	SD, HD, 3G SDI input and eye pattern display *
BATTERY ADAPTER V MOUNT	LV5300-SER11	LV5350-SER11	—	Battery adapter: V-Mount
BATTERY ADAPTER QR GOLD	LV5300-SER12	LV5350-SER12	—	Battery adapter: QR-Gold

* For LV7300, either LV7300-SER01 and LV7300-SER02 are selected, but one of them is necessary.

Software option list

Model Name	Type Number			Description
	LV5300	LV5350	LV7300	
AUDIO	LV5300-SER20	LV5350-SER20	LV7300-SER20	Embedded audio analysis
CLOSED CAPTION	LV5300-SER21	LV5350-SER21	LV7300-SER21	Closed captioning
CIE	LV5300-SER22	LV5350-SER22	LV7300-SER22	CIE display
HDR	LV5300-SER23	LV5350-SER23	LV7300-SER23	HDR analysis
TSG	LV5300-SER24	LV5350-SER24	LV7300-SER24	SDI signal generation
FOCUS ASSIST	LV5300-SER25	LV5350-SER25	LV7300-SER25	Focus assist
LAYOUT	LV5300-SER26	LV5350-SER26	LV7300-SER26	Customizable layout
TALLY	LV5300-SER27	LV5350-SER27	LV7300-SER27	ID, Iris, Tally displays
4K	LV5300-SER28	LV5350-SER28	LV7300-SER28	4K 12G SDI format support

LV5350 standard / LV7300-SER01, SDI Input

LV5300 standard / LV7300-SER02, SDI input with eye pattern

It is a unit that can display various SDI signals.

• Video analysis function

Various types of video signals, in addition to a variety of displays such as video signal waveform displays, vector display, picture display, 5 BAR display, video signal quality (QoE) freezes error, error black, gamut error detection, etc. are equipped as standard equipment.

• Voice analysis function

The audio signals superimposed on SDI signals can be displayed on a level meter.

* Lissajous, surround and status can be displayed by adding LV5300- SER20/LV5350- SER20/LV7300- SER20

• SDI signal data analysis function

The status display has an error detection function of CRC and embedded sound. It also has an event log, data dump, phase difference measurement functions, and can analyze SDI signals.

• Screen capture function

A screen capture function to capture the display screen as still image data and a frame capture function to capture 16 frames of data are equipped. The captured data can be saved in BMP format in comparison with the input signal, as well as the display on the main body, and thus confirmation with the personal computer is possible.

• Time code display

The time code superimposed on SDI signals and IP signals can be displayed. The time code can also be used as the timestamp of the event log.

• Input/output terminal

SDI input terminal BNC connector 2 terminal

SDI output terminal BNC connector 2 terminal

Output reclock signal

The SDI signals of the input terminals are reclock output to the output terminals, respectively.

Select reclock signal

The signals of the input terminals can be switched/reclock output

• Audio level meter (8ch)

Embedded audio SMPTE ST 299, SMPTE ST 272

48 kHz/24 bit/L-PCM

Synchronization condition

All are synchronized with the video clock.

All input SDI signals are synchronized.

• Eye pattern display (LV5300 standard/LV7300-SER02)

The eye pattern waveform, jitter waveform of SDI signal, and the measurement result of each parameter can be displayed.

Only input terminal 1 corresponds to eye pattern display.

LV5300-SER11 / LV5350-SER11, Battery adapter: V-Mount

V mount adapter for battery compatible with IDX battery.

LV5300-SER12 / LV5350-SER12, Battery adapter: QR-Gold

QR Golden Mount Adapter for Battery Compatible with Anton Bauer Battery.

LV5350-SER11 V Mount



LV5350-SER12 Antonbauer



LV5300-SER20 / LV5350-SER20 / LV7300-SER20, Embedded audio analysis

Lissajous display, surround display, mute, clip error detection, etc.

are now available. Various analysis display is also possible, and simultaneously display of 8 channels from one SDI signal and 4 channels from 2 SDI signals is possible. Embedded audio playback system complies with SMPTE ST 299, 272.

Audio display

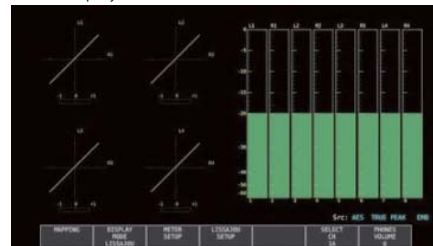

LV5300-SER21 / LV5350-SER21 / LV7300-SER21, Closed captioning

• Closed captioning

CEA-608, CEA-708 closed caption, Teletext, OP47 subtitle superimposed on SDI signal can be decode displayed.

• Japanese subtitle simplified display function

Japanese subtitles are simply displayed on the picture screen (HD, SD, analog, portable subtitles) are selected/displayed.

Language 1 and 2 are selected/displayed.

Approved standard.

ARIB STD-B37 short form data.

Japanese subtitle simplified display



LV5300-SER22 / LV5350-SER22 / LV7300-SER22, CIE chart display function

- CIE display function

This is a chromaticity diagram display function corresponding to colorimetry ITU-R BT. 601, ITU-R BT. 709, ITU-R BT. 2020. The display mode corresponds to CIE 1931 (xy display) and CIE 1976 (u'v' display). Since the CIE chart display function can display two color gamuts, the function can be used to suppress the color gamut of BT.709 using the equipment compatible with BT.2020, and to confirm the content that exceeds the color gamut of BT.709. In color display, the chromaticity point is displayed using the color (on the picture) in the video signal. The chromaticity point can be measured at the point with the cursor.

xy chromaticity coordinate display

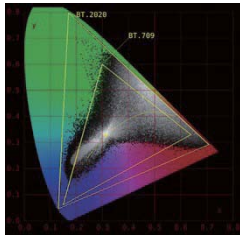

u' v' chromaticity coordinate display

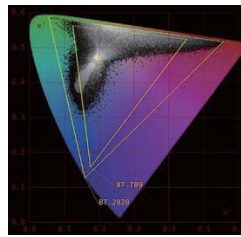

xy coordinate color indication

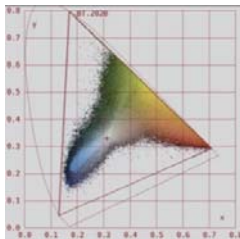

A light blue is a measurement function cursor

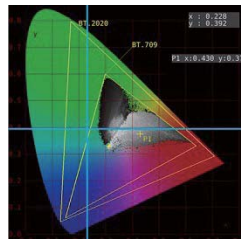

LV5300-SER23 / LV5350-SER23 / LV7300-SER23, HDR analysis
 In addition to HLG and PQ provided by ITU-R BT.2100, the level monitoring of the HDR signal corresponding to S-log3 and the level management at the assumed luminance (cd/m²) in a display considering OOTF are possible. The video signal waveform display corresponds to the HDR scale added to the IRE scale. In the cine zone display, the luminance distribution of the HDR area can be easily confirmed by displaying the SDR area with monochrome, and the HDR with a color according to the brightness.

- HDR zone display

The luminance distribution of the HDR area can be easily confirmed by coloring the SDR area with monochrome and the HDR with a color according to the brightness.

Upper limit setting value
 Reference setting value
 Lower limit setting values

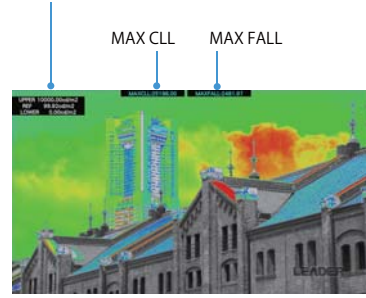

- The SDR part is monochrome, the HDR region is colored according to luminance.
- Above the upper limit value is colored with magenta.
- The upper limit value, the reference value, the lower limit value can be varied
- HDR Scale
 By associating WFM and histogram with HDR scale, management of the video with brightness at the time of scene linearity is possible.
- HDR waveform display.

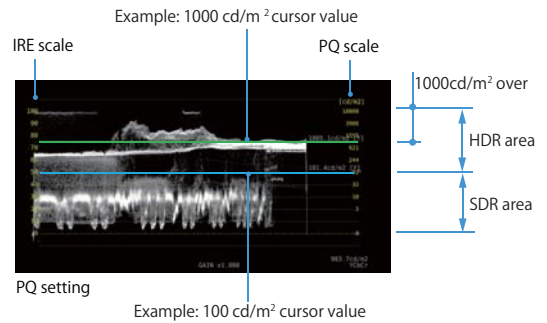

- HDR point measurement
- The crosshairs can be freely moved.
- Up to 3 points can be measured simultaneously.



P1(S: 884, L: 261) 3243.6cd/m2

HLG setting SYSTEM GAMMA OFF
 P1(S: 884, L: 261) 623.9%

HLG setting System Gamma On
 P1(S: 884, L: 261) 456.1cd/m2

S-Log3 setting System Gamma Off
 P1(S: 884, L: 261) 809.1%

- Approved standard
 ITU-R BT. 2100 (HLG, PQ), S-Log 3
- Supported format
 It corresponds to all except SD and XYZ input of SDI.

LV5300-SER24 / LV5350-SER24 / LV7300-SER24,
SDI signal generation function

SDI signal generation function can handle from HD-SDI to 12G-SDI. HD multiformat color bar and pattern correspond to the multiple overlays of moving boxes and embedded audio, flat field pattern can be specified at any level, and multiformat color bar 4K can be selected.

The SDI signal generation function of 12G-SDI requires LV5300-SER28/LV7300-SER28options.

* The LV5300/LV5350/LV7300 are output from the SDI output terminal 2 according to the output setting.

Standard

• Output pattern

100% color bar, 75% color bar, HD multi format color bar, color raster, cross hatch, 10 steps, limit lamp, Check field, lip sync pattern.

• Scroll

Direction 8 directions (up and down, left and right, and combinations thereof)

Speed range and unit 4 to 124 dots per frame (field), 4 dot units.

Moving Box ON/OFF

Color WHITE, YELLOW, CYAN, GREEN, MAGENTA, RED, BLUE, BLACK

Speed 1 to 3

• Embedded voice

1Number of superimposed channels maximum 16 ch

ON/OFF of superimposition ON/OFF in audio group unit

Voice level- 20 dBFS, -18 dBFS, 0 dBFS, Mute

*Flame rate For horizontal 4096/2048 pixel format at frame.

LV5300-SER25 / LV5350-SER25 / LV7300-SER25, Focus assist function

This is a focus detection function realizing a new algorithm based on nonlinear super resolution technology. The focus can be detected with high sensitivity even with low-contrast images, which were conventionally difficult to detect. In addition, sensitivity can be selected from 5 levels according to the video scene.

Focus assist display



After focus adjustment
(The green part is the focus adjustment point)

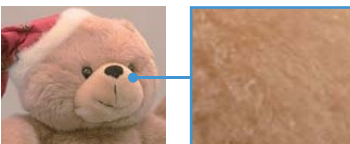

Enlarged view
(After focus adjustment)

LV5300-SER26 / LV5350-SER26 / LV7300-SER26, Customizable layout function

Various items such as video signal waveforms, vector waveforms, and pictures of input signals can be laid out in any position with your preferred size. Two input signals can be displayed simultaneously, or one input signal can be displayed on multiple

Customizable layout setting screen

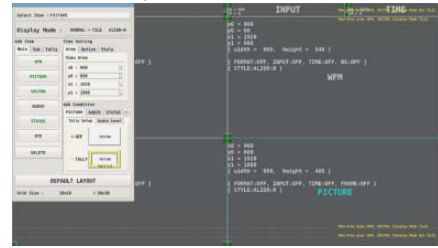

Layout Set measurement screen

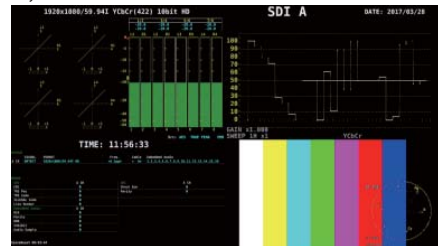

LV5300-SER27 / LV5350-SER27 / LV7300-SER27, ID/tally display function

Fast switching of tally display by remote terminal is also possible. As for the camera ID, a fixed name can be assigned to each channel in the setting of this unit.

LV5300-SER28 / LV5350-SER28 / LV7300-SER28,

4K video signal compatible function

It supports 4K video format signal of 12G- SDI single link.

* 12G-SDI signal is input terminal 1 only.

LV7290, Remote Controller

The LV7290 remote controller connects to the Ethernet port on the rear panel of the LV5300/LV5350/LV7300 and can be used to remotely control the LV5300/LV5350/LV7300. A single unit can connect and control up to eight LV5300/LV5350/LV7300s.

Dimensions and weight: ≤ 482 (W) X 44 (H) X 110 (D) mm (excluding protrusions), 1.2 kg



SDI video signal format and standard

SD video signal format and standard

Color System	Quantization	Image	Field Frequency / Scanning	Compliant Standard
YCbCr 4:2:2	10bit	720×487	59.94 /I	SMPTE ST 259
		720×576	50 /I	

HD video signal format and standard

Color System	Quantization	Image	Frame (Field) Frequency / Scanning	Compliant Standard
YCbCr 4:2:2	10bit	1280×720	60/59.94/50/	SMPTE ST 292-1
			30/29.97/25/24/23.98 /P	SMPTE ST 296
		1920×1080	60/59.94/50 /I	SMPTE ST 274
			30/29.97/25/24/23.98 /P	SMPTE ST 292-1
			30/29.97/25/24/23.98 /P	
			30/29.97/25/24/23.98 /PsF	

3G-A video signal format and standard

Color System	Quantization	Image	Frame (Field) Frequency / Scanning	Compliant Standard	
YCbCr 4:2:2	10bit	1920×1080	60/59.94/50 /P	SMPTE ST 274	
			48/47.95 /P	SMPTE ST 425-1	
		2048×1080	60/59.94/50/48/47.95 /P	SMPTE ST 425-1	
				SMPTE ST 2048-2	
		12bit	1920×1080	60/59.94/50 /I	SMPTE ST 274
				30/29.97/25/24/23.98 /P	SMPTE ST 425-1
	2048×1080		30/29.97/25/24/23.98 /P	SMPTE ST 425-1	
			30/29.97/25/24/23.98 /PsF	SMPTE ST 2048-2	
	YCbCr 4:4:4	10bit	1280×720	60/59.94/50/	SMPTE ST 296
				30/29.97/25/24/23.98 /P	SMPTE ST 425-1
			1920×1080	60/59.94/50 /I	SMPTE ST 274
				30/29.97/25/24/23.98 /P	SMPTE ST 425-1
30/29.97/25/24/23.98 /P				SMPTE ST 425-1	
30/29.97/25/24/23.98 /PsF					
2048×1080		30/29.97/25/24/23.98 /P	SMPTE ST 425-1		
		30/29.97/25/24/23.98 /PsF	SMPTE ST 2048-2		
		12bit	1920×1080	60/59.94/50 /I	SMPTE ST 274
				30/29.97/25/24/23.98 /P	SMPTE ST 425-1
2048×1080		30/29.97/25/24/23.98 /P	SMPTE ST 425-1		
		30/29.97/25/24/23.98 /PsF	SMPTE ST 2048-2		
RGB 4:4:4	10bit	1280×720	60/59.94/50/	SMPTE ST 296	
			30/29.97/25/24/23.98 /P	SMPTE ST 425-1	
		1920×1080	60/59.94/50 /I	SMPTE ST 274	
			30/29.97/25/24/23.98 /P	SMPTE ST 425-1	
			30/29.97/25/24/23.98 /P	SMPTE ST 425-1	
			30/29.97/25/24/23.98 /PsF		
	2048×1080	30/29.97/25/24/23.98 /P	SMPTE ST 425-1		
		30/29.97/25/24/23.98 /PsF	SMPTE ST 2048-2		
		12bit	1920×1080	60/59.94/50 /I	SMPTE ST 274
				30/29.97/25/24/23.98 /P	SMPTE ST 425-1
	2048×1080	30/29.97/25/24/23.98 /P	SMPTE ST 425-1		
		30/29.97/25/24/23.98 /PsF	SMPTE ST 2048-2		
XYZ 4:4:4	12bit	2048×1080	30/25/24 /P	SMPTE ST 425-1	
			30/25/24 /PsF	SMPTE ST 428	

3G-B-DL video signal format and standard

Color System	Quantization	Image	Frame (Field) Frequency / Scanning	Compliant Standard	
YCbCr 4:2:2	10bit	1920×1080	60/59.94/50 /P	SMPTE ST 274	
			48/47.95 /P	SMPTE ST 372	
		2048×1080	60/59.94/50/48/47.95 /P	SMPTE ST 425-1	
				SMPTE ST 2048-2	
		12bit	1920×1080	60/59.94/50 /I	SMPTE ST 274
				30/29.97/25/24/23.98 /P	SMPTE ST 372
	2048×1080		30/29.97/25/24/23.98 /PsF	SMPTE ST 425-1	
			30/29.97/25/24/23.98 /P	SMPTE ST 372	
	YCbCr 4:4:4	10bit	1920×1080	60/59.94/50 /I	SMPTE ST 274
				30/29.97/25/24/23.98 /P	SMPTE ST 372
			2048×1080	30/29.97/25/24/23.98 /PsF	SMPTE ST 425-1
				30/29.97/25/24/23.98 /P	SMPTE ST 372
12bit			1920×1080	60/59.94/50 /I	SMPTE ST 274
				30/29.97/25/24/23.98 /P	SMPTE ST 372
		2048×1080	30/29.97/25/24/23.98 /PsF	SMPTE ST 425-1	
			30/29.97/25/24/23.98 /P	SMPTE ST 372	
RGB 4:4:4		10bit	1920×1080	60/59.94/50 /I	SMPTE ST 274
				30/29.97/25/24/23.98 /P	SMPTE ST 372
			30/29.97/25/24/23.98 /PsF	SMPTE ST 425-1	
		2048×1080	30/29.97/25/24/23.98 /P	SMPTE ST 372	
	30/29.97/25/24/23.98 /PsF		SMPTE ST 425-1		
	30/29.97/25/24/23.98 /P		SMPTE ST 2048-2		
12bit	1920×1080	60/59.94/50 /I	SMPTE ST 274		
		30/29.97/25/24/23.98 /P	SMPTE ST 372		
2048×1080	30/29.97/25/24/23.98 /PsF	SMPTE ST 425-1			
	30/29.97/25/24/23.98 /P	SMPTE ST 425-1			
XYZ 4:4:4	12bit	2048×1080	30/25/24 /P	SMPTE ST 372	
			30/25/24 /PsF	SMPTE ST 425-1	

3G-B-DS video signal format and standard

Color System	Quantization	Image	Frame (Field) Frequency / Scanning	Compliant Standard
YCbCr 4:2:2	10bit	1920×1080	60/59.94/50 /I	SMPTE ST 274
			30/29.97/25/24/23.98 /P	SMPTE ST 425-1
			30/29.97/25/24/23.98 /PsF	
		1280×720	60/59.94/50/	SMPTE ST 296
			30/29.97/25/24/23.98 /P	SMPTE ST 425-1

12G video signal format and standard (2 sample interleave)

Color System	Quantization	Image	Frame Frequency / Scanning	Compliant Standard
YCbCr 4:2:2	10bit	3840×2160	60/59.94/50 /P	SMPTE ST 2036-1
			48/47.95/P	SMPTE ST 2082-10
		4096×2160	60/59.94/50/48/47.95 /P	SMPTE ST 2036-1
	12bit	3840×2160	30/29.97/25/24/23.98 /P	SMPTE ST 2036-1
			4096×2160	30/29.97/25/24/23.98 /P
		4096×2160	30/29.97/25/24/23.98 /P	SMPTE ST 2036-1
YCbCr 4:4:4	10bit	3840×2160	30/29.97/25/24/23.98 /P	SMPTE ST 2036-1
			4096×2160	30/29.97/25/24/23.98 /P
		4096×2160	30/29.97/25/24/23.98 /P	SMPTE ST 2036-1
	12bit	3840×2160	30/29.97/25/24/23.98 /P	SMPTE ST 2036-1
			4096×2160	30/29.97/25/24/23.98 /P
		4096×2160	30/29.97/25/24/23.98 /P	SMPTE ST 2036-1
RGB 4:4:4	10bit	3840×2160	30/29.97/25/24/23.98 /P	SMPTE ST 2036-1
			4096×2160	30/29.97/25/24/23.98 /P
		4096×2160	30/29.97/25/24/23.98 /P	SMPTE ST 2036-1
	12bit	3840×2160	30/29.97/25/24/23.98 /P	SMPTE ST 2036-1
			4096×2160	30/29.97/25/24/23.98 /P
		4096×2160	30/29.97/25/24/23.98 /P	SMPTE ST 2036-1

* It corresponds to TYPE 1 of 12G-SDI.

External synchronize input terminal		For Ethernet terminal control	
Input terminal	BNC terminal	Approved standard	
Number of input terminals	1 line 2 terminals		IEEE802.3
Input impedance	15 k Ω Passive loop through	Supported protocols	TELNET, FTP, SNMP, HTTP, SNTP
Input return loss	30 dB or more (50 kHz to 30 MHz, 75 Ω termination)	Input/output terminals	RJ-45
Maximum input voltage	\pm 5 V (DC + peak AC)	Function Remote operation with an external PC or remote controller, File transfer, get status information	
Input signal	Ternary synchronization signal or NTSC/PAL black burst signal 10 Field ID correspondence	Types	10Base-T, 100Base-TX, 1000Base-T
Function	SDI reference signal input for video signal waveform display and phase difference display	Remote terminal	
		Terminal shape	D Sub 15 pins (female)
		Number of terminals	1
		Control signal	LV- TTL level (LOW active)
Headphone output terminal		Function Preset recall, input signal switching, alarm output, tally	
Output terminal	LV5300/LV5350 3.5 mm Mini jack 1 terminal (stereo) LV7300 Standard jack 1 terminal (stereo)	Alarm output	When a format alarm, various errors, fan abnormality, or internal temperature occurs
Output signal	On the screen of the displayed audio signal, arbitrary 2 ch (Downmixed Lt, Rt is also acceptable)	Display (LV5300/LV5350)	
		Liquid crystal display	7 type TFT color liquid crystal
		Resolution	1920x1080
		Refresh rate	60 Hz, 59.94 Hz, 50 Hz (Free run or frequency synchronization to external synchronization signal)
Monitor output terminal (LV7300)		Touch panel	Electrostatic capacity type touch panel
SDI output terminal		General specifications	
Function	Output screen for SDI monitor	Environmental conditions	
Output terminal	BNC terminal	Operating temperature range	0 to 40 $^{\circ}$ C
Number of output terminals	1	Operating humidity range	85% RH or less (with no condensation)
Output signal	Output liquid crystal display screen is output with HD, 3G-A, 3G-B-DL. 1920x1080 60, 59.94, 50 I/P, YC _B C _R 4:2:2 (10 bits)	Performance guarantee temperature range	10 to 30 $^{\circ}$ C
TMDS output terminal		Usage environment	
Function	The displayed screen is output for HDMI monitor.	Indoors	
Output terminal	HDMI terminal	Usable altitude	up to 2,000 m
Number of output terminals	1	Overvoltage category	I
Signal format	Single Link T.M.D.S	Pollution degree	2
DDC function	Not supported	Power supply	
HOT PLUG detection function	Not supported	Voltage	DC 10 to 18 V
Output signal	Output liquid crystal display screen is output. 1920x1080 60 P, 59.94 P, 50 P	Power consumption	TBD W max.
Control terminal		Dimensions	
USB terminal		LV5300	215 (W)x132 (H)x120 (D) mm (No protruding part included)
Terminal shape	Standard A	LV5350	215 (W)x132 (H)x85 (D) mm (No protruding part included)
Number of terminals	2	LV7300	213 (W)x44 (H)x300 (D) mm (No protruding part included)
Standard	USB 2.0	Weight	
Compatible device	USB memory, USB mouse, touch panel type monitor	LV5300	TBD kg max. (Including options, accessories not included)
		LV5350	TBD kg max. (Including options, accessories not included)
		LV7300	TBD kg max. (Including options, accessories not included)

Accessories

D sub 15 pin connector	x1
D sub 15 pin connector cover	x1
Manual (CR-ROM)	x1

Options

Remote controller	LV7290 (Ethernet connection)
Rack mount adapter (for LV5350)	LR2530
Rack mount adapter (for LV7300)	LR2731/LR2732
AC adapter (LV7300 is included)	SPU61A-105

Accessories

LR2530, RACKMOUNT ADAPTER

The LR2530 is a dual rack mount adapter used to install LV5350 waveform monitors in a 19-inch EIA standard rack. It allows two LV5350s to be installed side by side.



LC2535, BLANK PANEL

The LC2535 is a blank panel for the LR2530 rack mount adapter. Use it when installing a single LV5350 waveform monitor in the LR2530.



LR2731, RACKMOUNT ADAPTER

The LR2731 is a rack mount adapter used to install a LV7300 rasterizer in a 19-inch EIA standard rack. Because one side is a blank panel, use it to install a single LV7300.

LR2732, RACKMOUNT ADAPTER

The LR2732 is a dual rack mount adapter used to install LV7300 rasterizers in a 19-inch EIA standard rack. It allows two LV7300s to be installed side by side.

AC Adapter

An AC adapter exclusive to Leader products. An AC cord is included.

* An AC adapter is attached to the LV7300.



LV5350

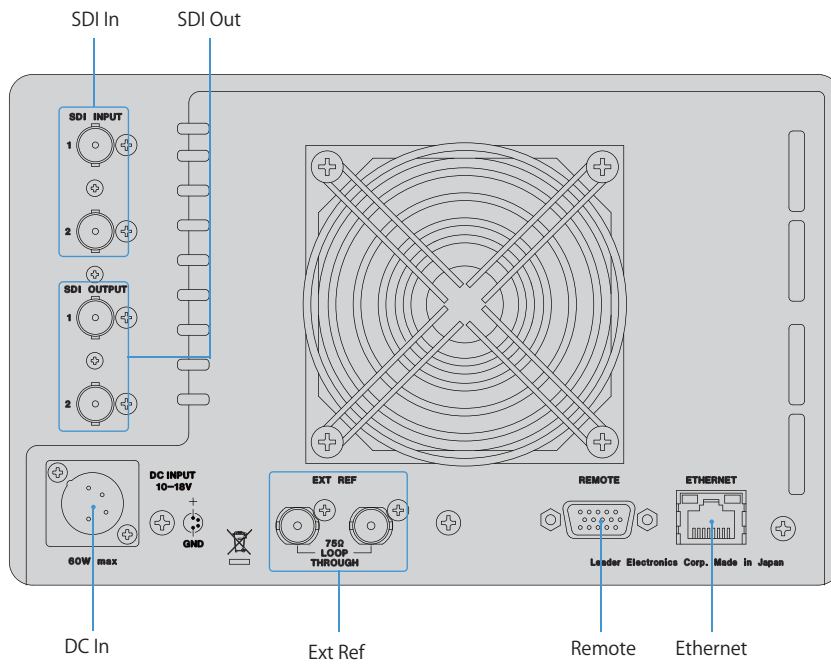

LV7300

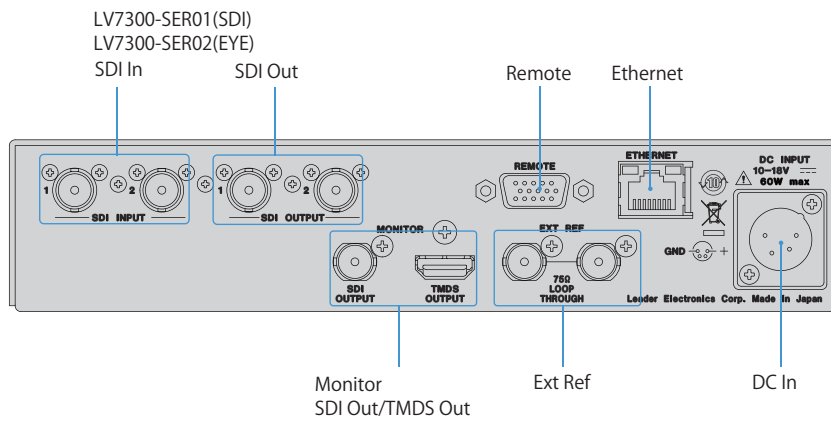

LV5350

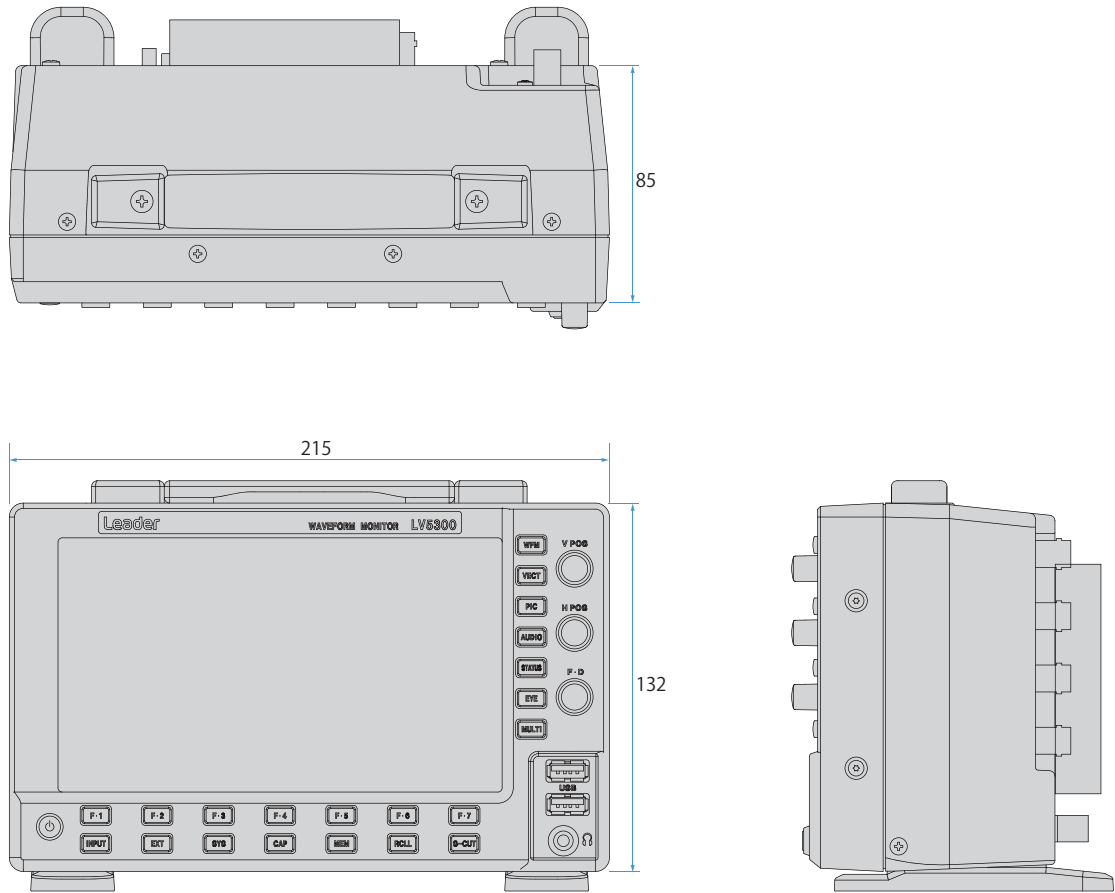

LV7300

