

# Leica Ultra

## User Manual



Version 1.0.1  
English

- when it has to be **right**

**Leica**  
Geosystems

# Introduction

---

## Purchase

Congratulations on your purchase of a Ultra instrument.

---



## Product identification

This manual contains important safety directions as well as instructions for setting up the product and operating it. Refer to "1 Safety Directions" for further information. Read carefully through the User Manual before you switch on the product.

---

The type and the serial number of your product are indicated on the type plate. Always refer to this information when you need to contact your agency or Leica Geosystems authorised service workshop.





---

## Trademarks

- *Bluetooth*<sup>®</sup> is a registered trademark of Bluetooth SIG, Inc. All other trademarks are the property of their respective owners.
-

## Symbols

The symbols used in this manual have the following meanings:

Type	Description
 <b>Danger</b>	Indicates an imminently hazardous situation which, if not avoided, will result in death or serious injury.
 <b>Warning</b>	Indicates a potentially hazardous situation or an unintended use which, if not avoided, could result in death or serious injury.
 <b>Caution</b>	Indicates a potentially hazardous situation or an unintended use which, if not avoided, may result in minor or moderate injury.
	Important paragraphs which must be adhered to in practice as they enable the product to be used in a technically correct and efficient manner.

## Validity of this manual

This manual applies to all Ultra instruments, which are the Ultra and Ultra Advanced locators, the Ultra 5 Watt, Ultra 12 Watt and Ultra 12 Watt advanced transmitters and accessories. Differences between the various instruments and models are marked and described.

# Table of Contents

<b>In this manual</b>	<b>1</b>	<b>Safety Directions</b>	<b>8</b>
	1.1	General Introduction	8
	1.2	Intended Use	9
	1.3	Limits of Use	10
	1.4	Responsibilities	10
	1.5	Hazards of Use	11
	1.6	Electromagnetic Compatibility EMC	16
	1.7	FCC Statement, Applicable in U.S.	18
	1.8	ICES-003 Statement, Applicable in Canada	20
	<b>2</b>	<b>General Information</b>	<b>21</b>
	2.1	How to Use this Manual	21
	2.2	General Information	22
	<b>3</b>	<b>How to Use the Locator</b>	<b>23</b>
	3.1	Locator Overview	23
	3.2	Locator Menu	29
	3.3	Select Location Mode	31
	3.4	Select Frequency	33
	3.5	Select Antenna Configuration	35
	3.6	Adjust Locator Gain	36
	3.7	Locate Passive Signal	37
		3.7.1 Setup	37
		3.7.2 Technique	37
		3.7.3 Special Situations	40

<b>4</b>	<b>How to Use the Transmitter</b>	<b>41</b>
4.1	Transmitter Overview	41
4.2	Transmitter Menu	46
4.3	Select Frequency	48
4.4	Induction	49
4.5	Direct Connectios	50
4.6	High Power Output	51
4.7	Signal Clamp	52
4.8	Connect with Live Power Adapte	53
<b>5</b>	<b>Locate Active Signals</b>	<b>54</b>
5.1	Setup	54
5.2	Technique	55
5.3	Mark the Cable	58
5.4	Special Situations	59
5.5	Direction Enable	60
<b>6</b>	<b>Ultra Advanced - Features</b>	<b>62</b>
6.1	Measure Ambient Interference	62
6.2	Link Locator to Transmitter	64
6.3	Offset Depth	65
<b>7</b>	<b>Locator Receiver Clamp</b>	<b>67</b>
7.1	General Information	67
7.2	Locator Buttons Used with Clamp	67
7.3	Locate with Locator Clamp	68

<b>8</b>	<b>Locator with Stethoscope</b>	<b>69</b>
8.1	General Information	69
8.2	Locator Buttons Used with Stethoscope	69
8.3	Locate with Stethoscope	70
<b>9</b>	<b>Locate Sonde Signal</b>	<b>72</b>
9.1	General Information	72
9.2	Setup	72
9.3	Technique	73
<b>10</b>	<b>Electronic Marker Location (EML) Accessory</b>	<b>77</b>
10.1	General Information	77
10.2	Locator Buttons Used with EML Accessory	77
10.3	Locator Display	78
10.4	Setup	81
10.5	Technique	84
<b>11</b>	<b>Fault Finder on Ultra Advanced</b>	<b>86</b>
11.1	General Information	86
11.2	Locator	88
11.3	Transmitter	92
11.4	Locate Faults	95
<b>12</b>	<b>GPS Capability on Ultra Advanced</b>	<b>97</b>
12.1	General Information	97
12.2	Locator Buttons Used with GPS	97
12.3	Locator Display	98
12.4	Locate Using GPS	100
	12.4.1 External Logging - Mapping Grade GPS	100
	12.4.2 Internal Logging - Document Grade GPS	102

<b>13</b>	<b>Care and Transport</b>	<b>106</b>
13.1	Transport	106
13.2	Storage	106
13.3	Cleaning and Drying	107
<b>14</b>	<b>Technical Data</b>	<b>108</b>
14.1	Conformity to National Regulations	108
14.2	Locator Technical Data	109
14.3	Transmitter Technical Data	112
14.4	System Operation Technical Data	114
14.5	Fault Finder Technical Data	115
14.6	EML Accessory Technical Data	117
14.7	Live Power Adapter Accessory Technical Data	119
14.8	Clamps	120
14.9	Sondes	122
14.10	Stethoscope	125
<b>15</b>	<b>International Limited Warranty</b>	<b>127</b>
<b>Appendix A</b>	<b>World Frequency Zones</b>	<b>128</b>

# 1

## 1.1

### Description

## Safety Directions

### General Introduction

---

The following directions enable the person responsible for the product, and the person who actually uses the equipment, to anticipate and avoid operational hazards.

The person responsible for the product must ensure that all users understand these directions and adhere to them.

---



## 1.2

## Intended Use

---

### Permitted use

The products are intended to be used for the following applications:

- Detection and localization of underground services: cables and metallic pipes.
  - Locator: Detection and localisation of utilities with the use of approved accessories.
  - Locator: Estimation of the depth of an underground service, or accessory
  - Locator with Bluetooth: Data communication with external appliances.
- 

### Adverse use

- Use of the product without instruction.
- Use outside of the intended use and limits.
- Disabling safety systems.
- Removal of hazard notices.
- Opening the product using tools, for example screwdriver, unless this is specifically permitted for certain functions.
- Modification or conversion of the product.
- Use after misappropriation.
- Use of products with recognizable damages or defects.
- Use with accessories from other manufacturers without the prior explicit approval of Leica Geosystems.
- Inadequate safeguards at the surveying site.



Adverse use can lead to injury, malfunction and damage. It is the task of the person responsible for the equipment to inform the user about hazards and how to counteract them. The product is not to be operated until the user has been instructed on how to work with it.

---

## 1.3

### Limits of Use

---

#### Environment

Suitable for use in an atmosphere appropriate for permanent human habitation: not suitable for use in aggressive or explosive environments.



Local safety authorities and safety experts must be contacted before working in hazardous areas, or in close proximity to electrical installations or similar situations by the person responsible for the product.

---

## 1.4

### Responsibilities

---

#### Manufacturer of the product

Leica Geosystems AG, CH-9435 Heerbrugg, hereinafter referred to as Leica Geosystems, is responsible for supplying the product, including the user manual and original accessories, in a completely safe condition.

---

#### Person responsible for the product

The person responsible for the product has the following duties:

- To understand the safety instructions on the product and the instructions in the user manual.
  - To ensure that it is used in accordance with the instructions.
  - To be familiar with local regulations relating to safety and accident prevention.
  - To inform Leica Geosystems immediately if the product and the application becomes unsafe.
  - To ensure that the national laws, regulations and conditions for the operation of e.g. radio transmitters, lasers are respected.
-

## 1.5

### Caution

## Hazards of Use

---

Watch out for erroneous measurement results if the product has been dropped or has been misused, modified, stored for long periods or transported.

### **Precautions:**

Periodically carry out test measurements and perform tests indicated in the user manual, particularly after the product has been subjected to abnormal use and before and after important measurements.

---

### Danger

Because of the risk of electrocution, it is very dangerous to use the product in the vicinity of electrical installations such as power cables or electrical railways.

### **Precautions:**

Keep at a safe distance from electrical installations. If it is essential to work in this environment, first contact the safety authorities responsible for the electrical installations and follow their instructions.

---

### Danger

Working on or near live electrical utilities may cause you to receive an electric shock or result in equipment damage.

### **Precautions:**

- Do not operate equipment unless you are properly qualified and familiar with its use.
  - Do not exceed equipment's recommended ratings and instructions of use.
  - Inspect equipment's cables and accessories for damage, do not use if faulty.
  - Do not work on electrically live power utilities unless you are properly qualified.
  - Use personal protective equipment rated for the utilities voltage and current.
  - Familiarise yourself with National and Work regulations governing safety and accident prevention.
-

 **Warning**

During dynamic applications, for example stakeout procedures there is a danger of accidents occurring if the user does not pay attention to the environmental conditions around, for example obstacles, excavations or traffic.

**Precautions:**

The person responsible for the product must make all users fully aware of the existing dangers.

---

 **Caution**

The absence of a positive indication does not guarantee the non-existence of a service. Services without a detectable signal may be present.

The locators can only locate non-metallic services such as plastic pipes, typically used by the water and gas utilities, with the use of appropriate accessories.

**Precautions:**

Always excavate with care.

---

 **Warning**

**Only with a locator with depth:**

The depth reading might not reflect the real depth if your locator picks up the signal induced into the service by the transmitter. This signal is radiated from the centre of the service. This is even more important when the signal is produced by a sonde, lying in a large diameter conduit!

**Precautions:**

Always compensate depth reading for service size.

---

 **Danger**

The locator will fail to detect electrical services in Power mode if an incorrect power setting is used.

**Precautions:**

Before use, verify the locator is setup to be compatible with mains frequency supply in your country. Options are 50 or 60 Hz. Refer to "Appendix A World Frequency Zones" (User Manual) for more information.

Contact your agency or Leica Geosystems authorised service workshop if your unit is incorrectly configured for your region.

---



**Danger**

**Only with transmitter:**

A hazardous signal may be present on the connection plug of the signal clamp when clipped over a live service.

**Precautions:**

Connect the clamp to the transmitter before clamping around a live service.

---



**Danger**

Connecting the cable set to a live service can result in receiving an electric shock.

**Precautions:**

Never connect the cable set directly to an electrical live service.

---



**Danger**

Connecting live power adapter to a live service can result in an electric shock.

**Precautions:**

Do not operate equipment unless you are properly qualified to work on live power conductors.

---



**Danger**

When using a signal clamp, a hazardous signal may be present on the service causing personal harm.

**Precautions:**

Do not use on electrical services which have impaired, or no insulation. If in doubt do not use.

---



**Warning**

Inadequate securing of the working site can lead to dangerous situations, for example in traffic, on building sites, and at industrial installations.

**Precautions:**

Always ensure that the working site is adequately secured. Adhere to the regulations governing safety and accident prevention and road traffic.

---



**Warning**

The transmitter is capable of outputting potentially lethal voltages.

**Precautions:**

Take care when handling exposed or non-insulated connections including the connection cables sets, the earth pin and the connection to the service.  
Notify others who may be working on or around the service.

---

 **Warning**

The transmitter is capable of outputting potentially lethal voltages.

**Precautions:**

Take care when using the maximum power output level.

---

 **Warning**

Risk of electric shock when removing the transmitter's battery pack.

**Precautions:**

Before removing the battery pack switch the transmitter off and remove any cable set or accessories from the connection socket.

---

 **Caution**

The transmitter's battery pack may get hot after prolonged use.

**Precautions:**

Allow the battery pack to cool down before removing.

---

 **Warning**

If the product is improperly disposed of, the following can happen:

- If polymer parts are burnt, poisonous gases are produced which may impair health.
- If batteries are damaged or are heated strongly, they can explode and cause poisoning, burning, corrosion or environmental contamination.
- By disposing of the product irresponsibly you may enable unauthorised persons to use it in contravention of the regulations, exposing themselves and third parties to the risk of severe injury and rendering the environment liable to contamination.
- Improper disposal of silicone oil may cause environmental contamination.

**Precautions:**



The product must not be disposed with household waste. Dispose of the product appropriately in accordance with the national regulations in force in your country. Always prevent access to the product by unauthorised personnel.

Product specific treatment and waste management information can be downloaded from the Leica Geosystems home page at <http://www.leica-geosystems.com/treatment> or received from your Leica Geosystems distributor.

---

 **Caution**

During the transport, shipping or disposal of batteries it is possible for inappropriate mechanical influences to constitute a fire hazard.

**Precautions:**

Before shipping the product or disposing of it, remove the batteries.

When transporting or shipping batteries, the person responsible for the product must ensure that the applicable national and international rules and regulations are observed. Before transportation or shipping contact your local passenger or freight transport company.

---

 **Warning**

High mechanical stress, high ambient temperatures or immersion into fluids can cause leakage, fire or explosions of the batteries.

**Precautions:**

Protect the batteries from mechanical influences and high ambient temperatures. Do not drop or immerse batteries into fluids.

---

 **Warning**

If battery terminals come in contact with jewellery, keys, metallised paper or other metals, short circuited battery terminals can overheat and cause injury or fire, for example by storing or transporting in pockets.

**Precautions:**

Make sure that the battery terminals do not come into contact with metallic objects.

---

 **Warning**

Only Leica Geosystems authorised service workshops are entitled to repair these products.

---

## 1.6

## Electromagnetic Compatibility EMC

---

### Description

The term Electromagnetic Compatibility is taken to mean the capability of the product to function smoothly in an environment where electromagnetic radiation and electrostatic discharges are present, and without causing electromagnetic disturbances to other equipment.

---

### Warning

Electromagnetic radiation can cause disturbances in other equipment.

Although the product meets the strict regulations and standards which are in force in this respect, Leica Geosystems cannot completely exclude the possibility that other equipment may be disturbed.

---

### Caution

There is a risk that disturbances may be caused in other equipment if the product is used in conjunction with accessories from other manufacturers, for example field computers, personal computers, two-way radios, non-standard cables or external batteries.

#### **Precautions:**

Use only the equipment and accessories recommended by Leica Geosystems. When combined with the product, they meet the strict requirements stipulated by the guidelines and standards. When using computers or other electronic equipment, pay attention to the information about electromagnetic compatibility provided by the manufacturer.

---

### Caution

Disturbances caused by electromagnetic radiation can result in erroneous measurements. Although the product meets the strict regulations and standards which are in force in this respect, Leica Geosystems cannot completely exclude the possibility that the product may be disturbed by very intense electromagnetic radiation, for example, near radio transmitters, two-way radios or diesel generators.

#### **Precautions:**

Check the plausibility of results obtained under these conditions.

---



 **Warning**

If the product is operated with connecting cables attached at only one of their two ends, for example external supply cables, interface cables, the permitted level of electromagnetic radiation may be exceeded and the correct functioning of other products may be impaired.

**Precautions:**

While the product is in use, connecting cables, for example product to external battery, product to computer, must be connected at both ends.

---

 **Warning**

Electromagnetic fields can cause disturbances in other equipment, in installations, in medical devices, for example pacemakers or hearing aids and in aircraft. It can also affect humans and animals.

**Precautions:**

Although the product meets in combination with radio or digital cellular phone devices recommended by Leica Geosystems the strict regulations and standards which are in force in this respect, Leica Geosystems cannot completely exclude the possibility that other equipment may be disturbed or that humans or animals may be affected.

- Do not operate the product with radio or digital cellular phone devices in the vicinity of filling stations or chemical installations, or in other areas where an explosion hazard exists.
  - Do not operate the product with radio or digital cellular phone devices near to medical equipment.
  - Do not operate the product with radio or digital cellular phone devices in aircraft.
  - Do not operate the product with radio or digital cellular phone devices for long periods with it immediately next to your body.
-

## 1.7



### Warning

## FCC Statement, Applicable in U.S.

---

The greyed paragraph below is only applicable for products without radio.

---

This equipment has been tested and found to comply with the limits for a Class B digital device, pursuant to part 15 of the FCC rules.

These limits are designed to provide reasonable protection against harmful interference in a residential installation.

This equipment generates, uses and can radiate radio frequency energy and, if not installed and used in accordance with the instructions, may cause harmful interference to radio communications. However, there is no guarantee that interference will not occur in a particular installation.

If this equipment does cause harmful interference to radio or television reception, which can be determined by turning the equipment off and on, the user is encouraged to try to correct the interference by one or more of the following measures:

- Reorient or relocate the receiving antenna.
- Increase the separation between the equipment and the locator.
- Connect the equipment into an outlet on a circuit different from that to which the locator is connected.
- Consult the dealer or an experienced radio/TV technician for help.

### Warning

---

Changes or modifications not expressly approved by Leica Geosystems for compliance could void the user's authority to operate the equipment.

---

## Labelling locator

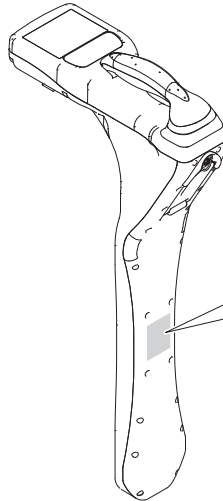

Type: Ultra Locator - Advanced  
S.No.: 836974

Art No.: 818698

Power:

2 x LR20(D) Alkaline

3V $\frac{2}{3}$  Nominal / 500mA max

This device contains a transmitter:

FCC ID: QOQWT41

IC: 5123-BGBGTW41

This device complies with part 15 of the FCC rules  
and Industry Canada Licence exempt RSS-310

Operation is subject to the following two conditions:

(1) This device may not cause harmful interference,  
and (2) this device must accept any interference  
received, including interference that may cause  
undesired operation.

Leica Geosystems AG





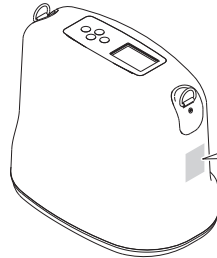

CH - 9435 Heerbrugg

Made in the USA



## Labelling transmitter



Type: Ultra Tx - Advanced  
S.No.: 836974  
Art No.: 818700  
Power:   
10 x LR20(D) Alkaline  
15V  Nominal / 5A max  
This device contains a transmitter:  
FCC ID: QQQWT41  
IC: 5123-BGBGTW41  
This device complies with part 15 of the FCC rules  
and Industry Canada Licence exempt RSS-310  
Operation is subject to the following two conditions:  
(1) This device may not cause harmful interference,  
and (2) this device must accept any interference  
received, including interference that may cause  
undesired operation.  
Leica Geosystems AG  
CH - 9435 Heerbrugg  
Made in the USA  
    

### 1.8



### ICES-003 Statement, Applicable in Canada

This Class (B) digital apparatus complies with Canadian ICES-003.  
Cet appareil numérique de la classe (B) est conforme à la norme NMB-003 du Canada.

## 2

### 2.1



#### Naming convention

## General Information

### How to Use this Manual

---

It is recommended to set up the product while reading through this manual.

---

**Ultra** and **Ultra Advanced** are hereinafter referred to as locator. Differences between the models are marked and described.

**Ultra 5 Watt**, **Ultra 12 Watt** and **Ultra 12 Watt Advanced Transmitters** are hereinafter referred to as transmitter.

**Sonde** is also known as beacon.

---

#### Instrument label

On the locator and transmitter you will find a label that shows some important information by means of illustrations. You will find some of these illustrations in this manual, too. This helps to get a clear connection between the instrument label and the information in this manual.

---

## 2.2

## General Information

---

### Description

**Locators** are used to detect buried conductive services emitting an electromagnetic signal which is generated by a current passing through the service.

**Transmitters** are used to apply a distinct signal to conductive services, which may not radiate electromagnetic signals or may need to be traced for a specific purpose. The transmitter is required to make a depth or current measurement.

The locators and transmitters described within this manual will greatly increase the detection process and help to reduce the dangers and costs associated with service strikes. But the very nature of electromagnetic location is dependent on the services being conductive (metallic) and radiating a signal as current flows through them.

It is important to remember that a locator on its own will not detect all services. Take care when excavating. It is generally accepted that a safe system of work should be adopted which would include planning the work in advance, the use of utility maps, the use of locators and transmitters, and the use of safe digging practices.

---

# 3

## How to Use the Locator

### 3.1

#### Locator Overview

---

##### Locator

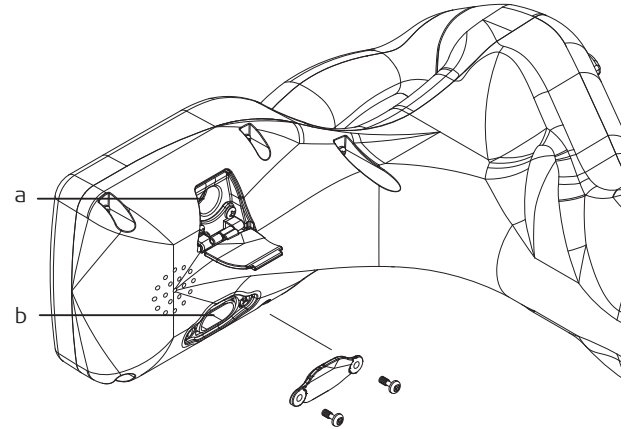
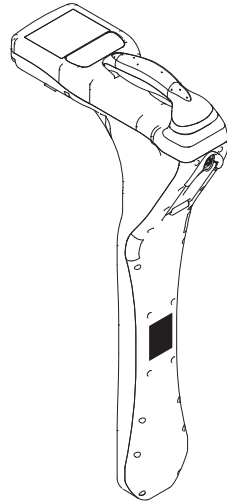

a) **Accessory Port**

This port is intended to be used with only Leica Geosystems approved accessories such as the fault finding probe.

b) **Mini-USB Port**



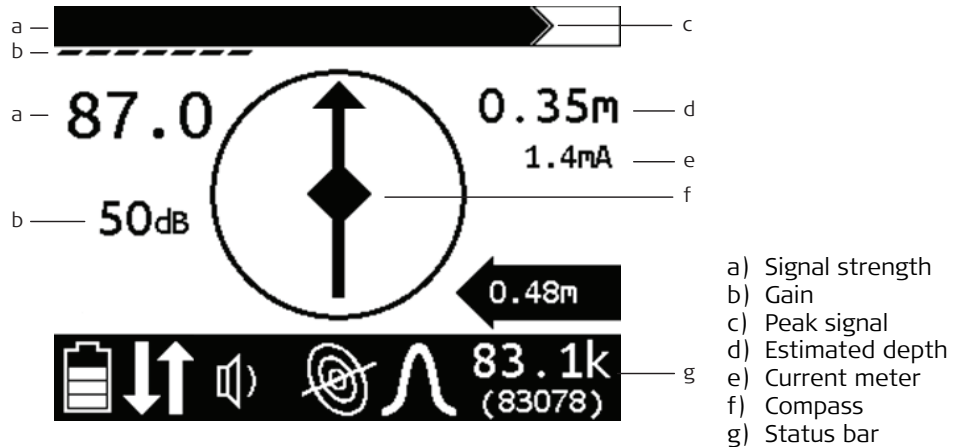

This port is intended to be used for connecting to a PC to update software and change the user configuration of the locator using the PC software.

---











## Display panel overview







## Status bar icons

Type	Icon	Description
Battery		Battery level
		Battery exhausted, locator will shut off
Direction		Direction enable, feature active
Volume		Volume level

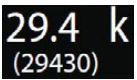

Type	Icon	Description
Transmitter		No communication from transmitter
		Frequency not available from transmitter
Mode		Transmitter
		Sonde
		Radio
		Power
		Fault Find*
		Electronic Marker Location (EML)*
		Locator clamp*
		Stethoscope*

Type	Icon	Description
Antenna		Twin peak
		Null
		Single peak
		Total field
Frequency setting		Selected frequency setting





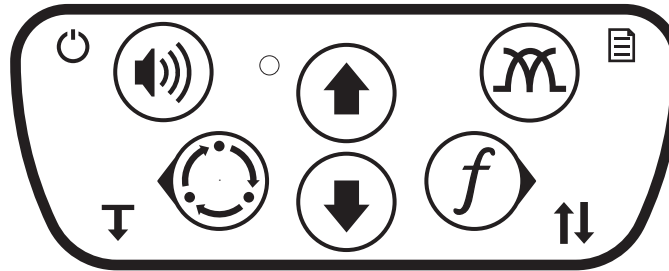







\* Shown when accessory is connected

## Locator keypad



Keypad buttons perform several functions depending on operating mode. To activate most functions, press and release the button. For other functions, press and hold the button until the function activates.

### Locator keypad buttons

	Power ON/OFF, press and hold		Up		Antenna configuration
	Volume Exit menu				Menu press and hold
	Location mode		Down		Frequency
	Back				Select / Next
	Depth, press and hold				Set or reset direction enable press and hold

## Changing the battery

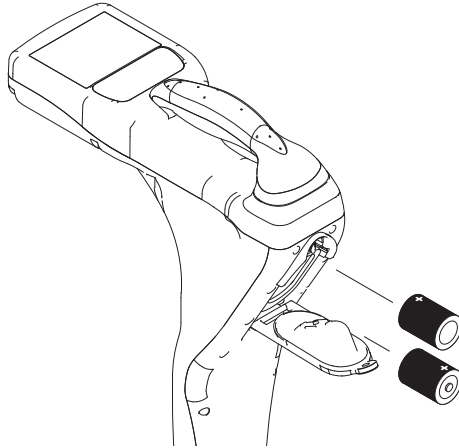

Use 2 D-cell alkaline batteries in locator.

1. Remove battery cover.
2. Insert batteries as shown.
3. Install and tighten battery cover.
4. Check operation.

## 3.2











## Locator Menu











### Description

Menus allow the operator to set user interface preferences.

Use the up, down, select/next, and back buttons on the keypad to navigate the menu.

### Icons

Main Menu	Sub Menus	
 Frequency	Select frequencies to activate.	Icons show which mode is suited for each frequency:  Power  Sonde  Transmitter
 Settings	 Language	Select user interface language
	 Units	Select measurement units for distance and depth
	 Backlight	Select backlight setting
	 Shutdown timer	Set amount of time before unit shuts off
	 Communications	Select communication preference Only available on Ultra Advanced.

Main Menu	Sub Menus	
 Options	 Audio	 Audio mode Select audio mode setting
		 Auto style Select audio style setting
		 Center beep Select center beep options
		 Gain Select gain option
		 L/R arrows Select left or right
		 Autodepth Select automatic or manual depth
 System Information	 System info	Displays the locator model configuration, model number, serial number, software version, hour count, configuration date, and calibration date.
 AIM <sup>®</sup>	Ambient Interference Measurement; measures and displays interference (noise) at all frequencies in the selected mode. Only available on Ultra Advanced.	

### 3.3

## Select Location Mode









### Icons

Select the mode best suited for the locating jobsite and user preference. Depending on the locator model, all modes might not be available.



#### Active signals

Signal placed on a target line with a transmitter

Signal Mode	Description	Notes
 Transmitter mode	 Direct connection	Preferred method Requires a connection directly to the target line
	 Dual output	
	 Clamp induction	Requires placing an optional signal clamp around the target line
	 Broadcast induction	Sends current into lines near the transmitter
 Sonde	Signal transmitted from a sonde inside a pipe or conduit	

### Passive signals

Signal that a utility line picks up from the environment

Signal Mode	Description	Notes
 Power mode	Allows locator to trace live 50 Hz or 60 Hz power cables	Current must be flowing through the cable.
 Radio mode	Allows locator to trace cables that pick up and radiate very low frequency (VLF) radio waves	



## 3.4

*f*

### Select Frequency

Ultra system gives the user the ability to choose from up to 100 different transmitter frequencies.

Optimal frequencies for your area can be configured for each unit using appropriate software.

Use Ultra Advanced systems AIM® (Ambient Interference Measurement) application to determine suitable frequencies. Then, use the transmitter and locator frequency menus to activate only the frequencies most suited for a particular jobsite.

Be aware of these points:

- Lower frequencies travel farther than higher frequencies
- Higher frequencies couple onto lines more easily
- Higher frequencies also couple onto lines other than the target line more easily

Enabling frequencies on transmitter and locator

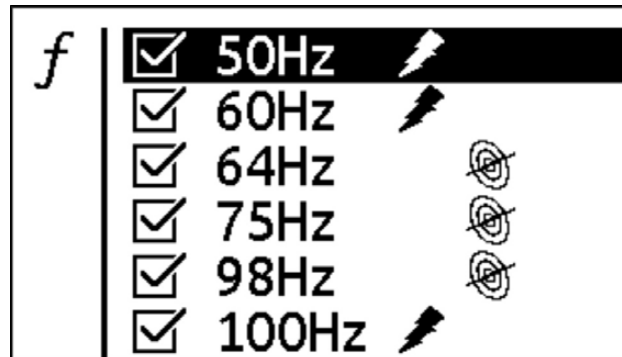

1. Navigate to the **Frequency** menu.
2. Select the frequencies best suited for the jobsite conditions. When the box is checked, the frequency is enabled.  
 Power, transmitter, and sonde icons indicate which mode a frequency will be available in.
3. While locating, press the Frequency button to select the next enabled frequency.

 **Danger**

The locator will fail to detect electrical services in power mode if an incorrect power setting is used.

**Precautions:**

Before use, verify the locator is setup to be compatible with mains frequency supply in your country. Options are 50 or 60 Hz. Refer to "Appendix A World Frequency Zones" for more information.

---





## 3.5

## Select Antenna Configuration



Select the antenna configuration best suited for the locating jobsite.

### Icons

Configuration	Description	Advantage / Disadvantage
 Single peak	Uses one horizontal antenna to detect signal. Response is highest at strongest signal.	More range Less precise
 Twin peak	Uses two horizontal antenna to detect signal. Response is highest at strongest signal.	Noise canceling Most precise Less range
 Null	Uses a vertical antenna to detect signal. Search width is narrower than single peak. Response is lowest when locator is over the line.	Sharp response Easily distorted in congested areas
 Total field	Uses a combined signal measured in all three axes to locate signal.	Easy to use when sweeping and eliminates ghost signals Less precise in congested areas



## 3.6



### Adjustment

## Adjust Locator Gain

The gain setting controls the locators sensitivity.

Action	Result	Effect
 Increasing gain	More sensitive to signal	Allows location farther away from signal source
 Decreasing gain	Less sensitive to signal	Stabilises signal

## 3.7

## Locate Passive Signal

---

### 3.7.1

#### Setup

---



Follow setup procedures for the type of locating you will be doing.



Always check locator battery level at start up.



Cables with no A/C current flowing through them are hard to detect and may be hazardous because they may still have voltage potential. To locate, turn on an appliance to cause current to flow and use active search methods.

---

### 3.7.2

#### Technique

---

#### Surveying the site

Make a visual check of the site for signs of buried cables such as:

- Recent trenching
  - Buried cable markers
  - Overhead lines that run down pole and underground
  - Gas meters
  - Valve sights
  - Drains or manhole covers
-

## Sweep search

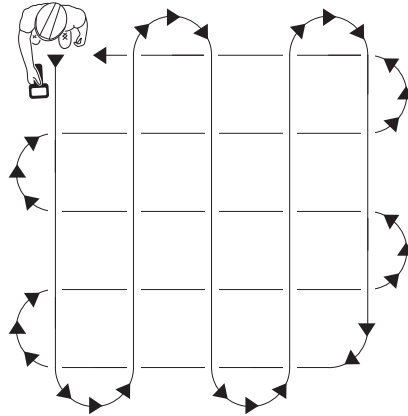

Search the site by walking a grid pattern while holding locator close to the ground.

 Keep locator vertical.

## Focus the signal

---

Move locator over detected signal to find best signal response. If using a peak antenna mode, rotate locator until signal is best. Best signal indicates cable direction.

---

## Trace the cable



Walk along the suspected path while moving the locator from side to side across the area.

 Keep locator handle parallel to the suspected cable path.

## Mark the cable

---

Sweep, focus, and trace all detected signals in the area.  
Mark cable paths with colored paint or flags.

---

### 3.7.3

### Special Situations

#### Overview

---

Situation	What to try
Signal is lost.	Walk in a circle to detect a tee or bend in the cable.
Signal varies from low to high and is unstable.	Mark as a hand-dig area.
locator does not function properly.	locator gain could be set too high or low. Lower or raise gain to locate the cable.

---



## 4

# How to Use the Transmitter

## 4.1

### Transmitter Overview

#### Ports

The transmitter has three auxiliary ports.

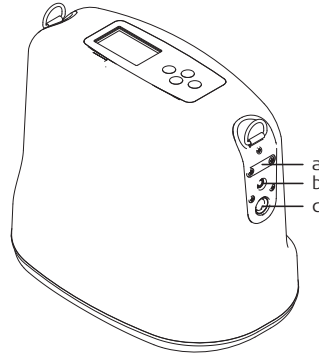





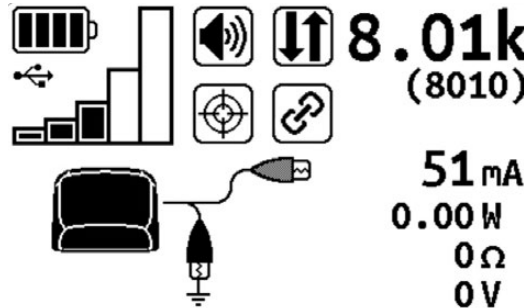





- a) Mini-USB port
- b) External power connector port
- c) Active location device port





#### Display panel overview



The transmitter display shows the status of selected options as well as the active frequency and meter reading.

## Display icons

Type	Icon	Description
Battery/power		Battery level
		External power connected
USB		Connected
Output power		Level
		High power output enabled
Volume		On
		Off
Direction		Enable active
Output		Regulation reached
		Interrupted
Link		Linked to locator





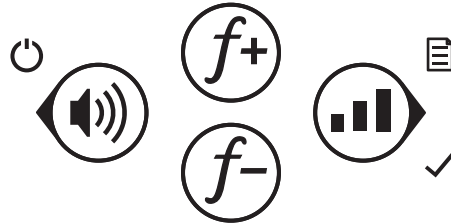



Type	Icon	Description
Induction		Induction active
Connection		Signal clamp connected
		Direct-connect leads connected
		Dual-connect leads connected
Units	mA	Milli ampere. Displays the current flow.
	W	Watt. Displays the wattage output.
	$\Omega$	Ohm. Displays the impedance level used for fault finding
	V	Volt. Displays the voltage level.

## Transmitter keypad



Keypad buttons perform several functions depending on operating mode. To activate most functions, press and release the button. For other functions, press and hold the button until the function activates.

## Transmitter keypad buttons

	Power ON/OFF, press and hold		Frequency up		Power output
	Volume		Frequency down		Select / Next
	Back				Menu press and hold

## Changing the battery

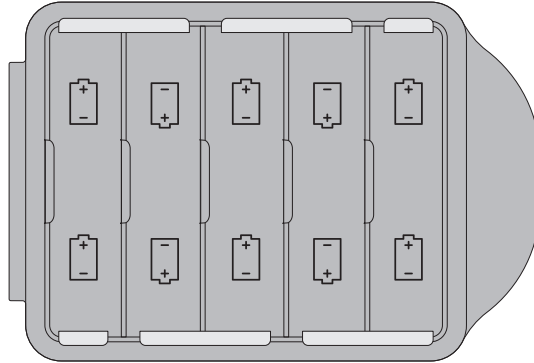

Use ten D-cell alkaline batteries or a Lithium ion battery pack in transmitter.

1. Open battery cover.
2. Insert batteries as shown.
3. Close and tighten battery cover.
4. Check operation.

If battery light is flashing when unit is turned on, then one battery is incorrectly installed or batteries are weak.



- Installing batteries backwards will cause damage to batteries and unit.
- Ensure that door is closed tightly.
- Do not mix new and used batteries.

### Caution

The transmitter's battery pack may get hot after prolonged use.

#### **Precautions:**

Allow the battery pack to cool down before removing.

### Warning

Risk of electric shock when removing the transmitter's battery pack.

#### **Precautions:**

Before removing the battery pack switch the transmitter off and remove any cable set or accessories from the connection socket.

## 4.2











## Transmitter Menu









### Description

Menus allow the operator to set user interface preferences.

Use the up, down, select/next, and back buttons on the keypad to navigate the menu.

### Icons

Main Menu	Sub Menus	
 Settings	 Backlight	Select backlight setting
	 Output	Select output setting. Requires cable set connected to transmitter.   Direction enabled   Dual output   High power output
	 Meter	Select simple or advanced meter
	 Communications	Select communication preference
 Options	 Language	Select user interface language
	 Default	Restores unit to factory default settings.

Main Menu	Sub Menus	
	 Fault Find	Fault Mode indicator
	 Shutdown timer	Set amount of time before unit shuts off.
 Frequency	Select frequencies to activate.	Icons show which connection can be used for each frequency: <ul style="list-style-type: none"> <li data-bbox="957 361 1137 417">  Induction         </li> <li data-bbox="957 440 1201 496">  Direct connect         </li> <li data-bbox="957 518 1297 574">  Signal clamp, standard         </li> <li data-bbox="957 596 1457 652">  Broadband signal clamp, broadband         </li> </ul>
 System Information		Displays the unit model configuration, model number, serial number, software version, hour count, configuration date, and calibration date.

## 4.3

*f*

### Select Frequency

Ultra system gives the user the ability to choose from up to 100 different transmitter frequencies.

Optimal frequencies for your area can be configured for each unit using appropriate software.

Use Ultra Advanced systems AIM® (Ambient Interference Measurement) application to determine suitable frequencies. Then, use the transmitter and locator frequency menus to activate only the frequencies most suited for a particular jobsite.

Be aware of these points:

- Lower frequencies travel farther than higher frequencies
- Higher frequencies couple onto lines more easily
- Higher frequencies also couple onto lines other than the target line more easily

Enabling frequencies on transmitter and locator

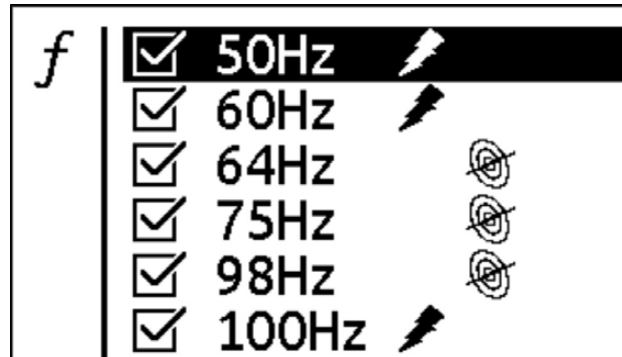

1. Navigate to the **Frequency** menu.
2. Select the frequencies best suited for the jobsite conditions. When the box is checked, the frequency is enabled.  
 Power, line, and sonde icons indicate which mode a frequency will be available in.
3. While locating, press the Frequency button to select the next enabled frequency.



## 4.4

## Induction

### Setup

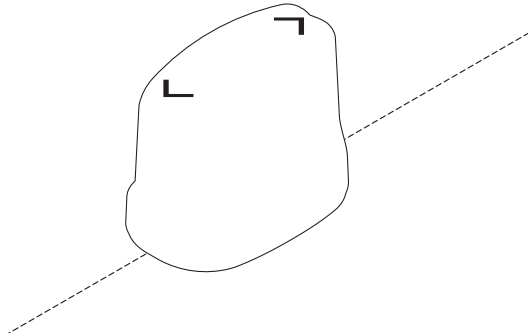

1. Remove cable, stake, clamp and any other metal objects from transmitter.
  2. Place transmitter parallel to and directly above suspected cable as shown.
  3. Turn on transmitter and check battery level.
-  Transmitter must be parallel to object, as shown, in order to produce the best signal.

## 4.5



## Direct Connections

- A built-in circuit breaker will automatically disable transmitter when leads are connected to a live cable. Display will flash and transmitter will beep. Turn off transmitter and disconnect from cable to reset breaker.

### Setup

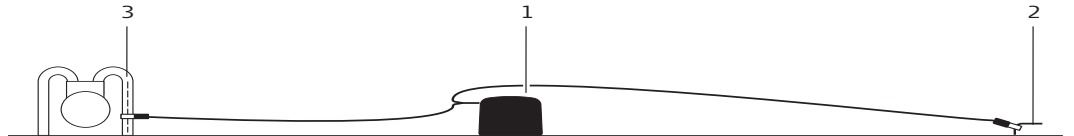

1. Plug cable into transmitter.
2. Ensuring that no utilities are below push the ground stake into ground.  
Connect black lead to ground stake.
3. Connect red lead to cable.
4. Turn on transmitter and check battery.



### Danger

If using dual location, connect white lead to the additional cable to be located.

Connecting the cable set to a live service can result in an electric shock.

#### **Precautions:**

Never connect the connection cable set directly to a live service.

### Warning

The transmitter is capable of outputting potentially lethal voltages.

#### **Precautions:**

Take care when handling exposed or non-insulated connections including the connection cables sets, the Earth Pin and the connection to the service. Notify others who may be working on or around the service.

## 4.6

### High Power Output

---

#### Availability

High power output is a feature on Ultra 12 W advanced transmitter. It allows the operator to transmit 12 W on a line at frequencies less than 10 kHz. Use this function on large diameter direct buried steel pipe and long distance locates.

---



When using high-power output, either install a Lithium ion battery pack or connect the transmitter to an external power source.

---

#### Activation

1. Navigate the transmitter menu to **Settings** > **Output** > **High Power**.
  2. Select **Enable** or set timer as desired.
- 

#### Warning

The transmitter is capable of outputting potentially lethal voltages.

#### **Precautions:**

Take care when using the maximum power output level.

---

## 4.7



## Signal Clamp

- A built-in circuit breaker will automatically disable transmitter when leads are connected to a live cable. Display will flash and transmitter will beep. Turn off transmitter and disconnect from cable to reset breaker.

### Setup

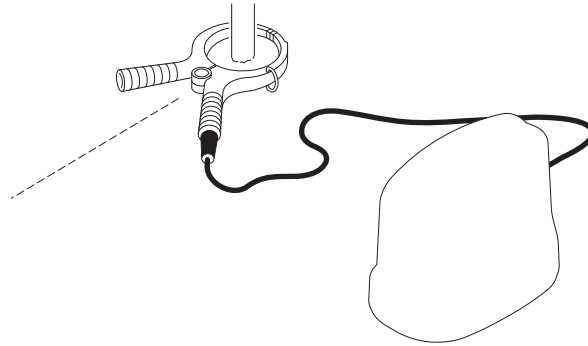

1. Plug cable into transmitter.
2. Place clamp around cable.
3. Turn on transmitter.
4. Select appropriate frequency.
5. Check battery level.

### Danger

A hazardous signal may be present on the connection plug of the signal clamp when clipped over a live service.

#### **Precautions:**

Connect the clamp to the transmitter before clamping around a live service.

### Danger

A hazardous signal may be present on the service causing personal harm.

#### **Precautions:**

Do not use on electrical services which have impaired, or no insulation. If in doubt do not use.

## 4.8

### Connect with Live Power Adapter

---

#### Setup

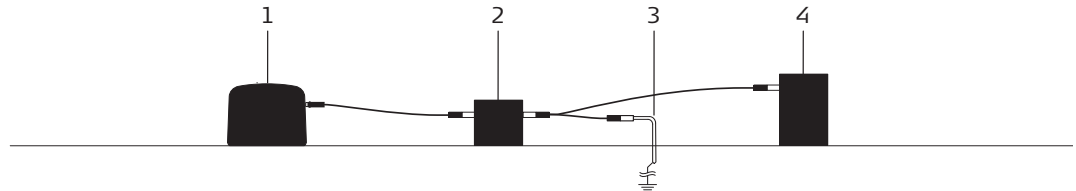

1. Verify that transmitter is turned off.
2. Connect live power adapter to the transmitter.
3. Connect live power adapter black lead to the ground stake.
4. Connect live power adapter red lead to live power conductor.
5. Turn on transmitter.
6. Select frequency greater than 8 kHz. 29 kHz is preferred.
7. Adjust power level as needed.
8. Check battery level.



When finished locating the cable, turn off transmitter, disconnect live power adapter red lead from live power conductor, disconnect live power adapter black lead from ground stake, and disconnect live power adapter from transmitter.



**Danger**

Connecting live power adapter to a live service can result in an electric shock.

**Precautions:**

Do not operate equipment unless you are properly qualified to work on live power conductors.

---

# 5

## 5.1

# Locate Active Signals

## Setup

### Procedure

Follow setup procedures for the type of locating you will be doing: direct connection, signal clamp, connecting to live power with live power adapter, or broadcast induction.

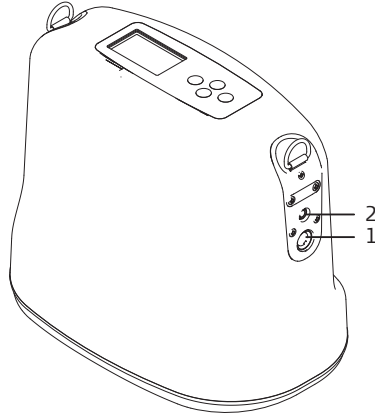

1. For all types of active location that require leads, connect leads to transmitter at connector.
2. When it is necessary to connect to external power, use connector.

## 5.2



## Technique

Follow steps in this chapter for all types of active location. For reference, the illustration shows direct connection method. If using broadcast induction, ensure that transmitter is in line with and above suspected cable, as shown on previous page.

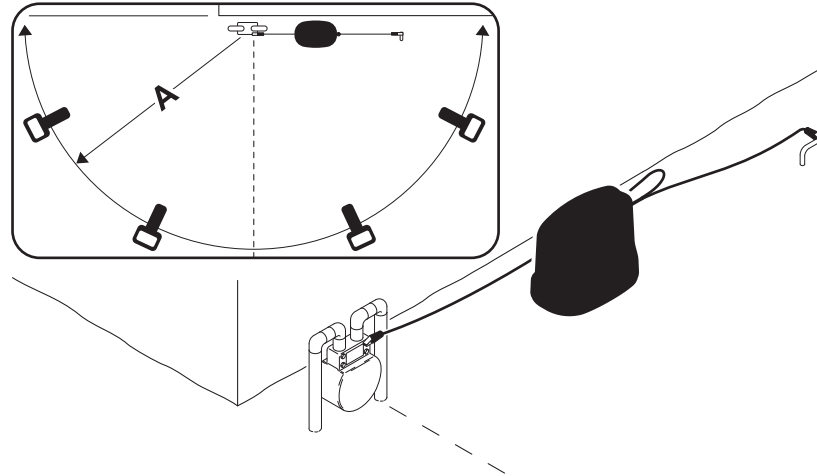

## Procedure

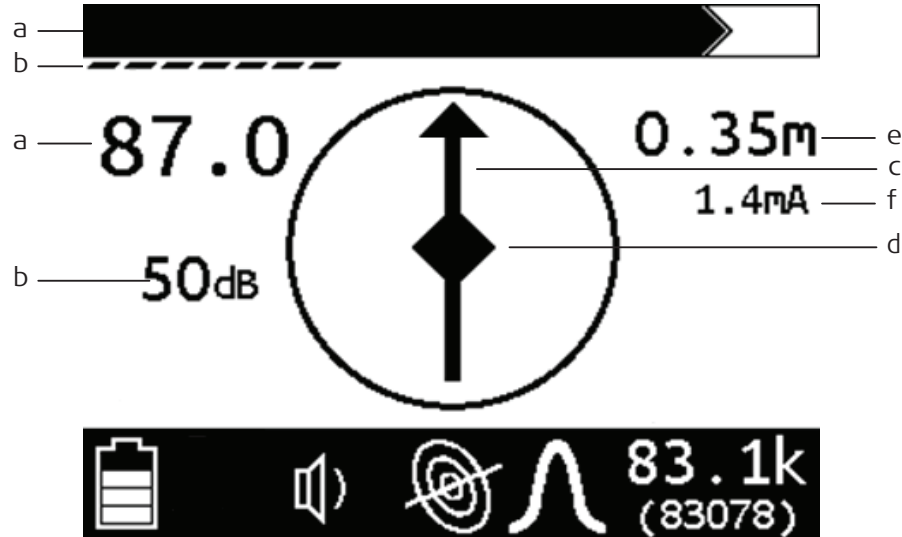

1. Facing away from the transmitter, walk in an arc approximately 25' (A, 7.5 m) around transmitter, as shown above.
2. Rotate the locator and observe the screen.
  - a) Target is located where signal response is strongest. Signal strength is shown graphically as well as numerically. The signal strength number will flash when the locator is saturated. Reduce the gain until the number stops flashing.
  - b) Adjust gain as needed to maintain signal strength. Gain is shown graphically as well as numerically.
  - c) The compass line shows the direction the cable runs.



- d) Move in the direction of the center arrows. When the arrows form a diamond, the target is located.
  - e) AutoDepth reading will appear when target is correctly located. If operating in manual depth mode, press and hold the **Depth** button.
  - f) Use current measurement to identify target cable. Current on the target cable should be higher than current on another cable that is picking up signal inductively from target cable.
3. Continue to trace the cable and observe depth estimates every few paces.
  4. Retrace the cable and mark with appropriate flags or paint.
-

## 5.3



### **Warning**

## Mark the Cable

---

Sweep, focus, and trace all detected signals in the area.  
Mark cable paths with colored paint or flags.

---

The depth reading might not reflect the real depth if your locator picks up the signal induced into the service by the transmitter. This signal is radiated from the centre of the service. This is even more important when the signal is produced by a sonde, lying in a large diameter conduit!

### **Precautions:**

Always compensate depth reading for service size.

---

## 5.4

## Special Situations

### Overview

Situation	What to try
Signal is lost.	Walk in a circle to detect a tee or bend in the cable.
Signal varies from low to high and is unstable.	Mark as a hand-dig area.
You are near a power line and are receiving interference.	Sweep the area in 50 Hz or 60 Hz power mode. If locator gives a strong signal response, a power line is interfering with transmitter signal.
Locator does not function properly.	Locator gain could be set too high or low. Lower or raise gain to locate the cable.
Target cable has connections to other cables.	Disconnect target cable from other cables or use direct connect or signal clamp to focus signal on target cable.
Signal is transferring to other cables.	<ul style="list-style-type: none"><li>• Lower the frequency.</li><li>• Lower the power level.</li><li>• Use direct connection, if possible, or use signal clamp.</li><li>• Move the ground stake away from the target cable and away from other buried cables.</li><li>• Apply signal at the point where the target cable is farthest from the other cables.</li></ul>

## 5.5

### Direction Enable



Direction Enable allows the operator to set a reference for current flow on a target line. It is useful for maintaining line identity on jobsites where multiple utilities are present.

Direction Enable is only available:

- In transmitter mode
- At frequencies of 10 kHz and below.

#### Using Direction Enable

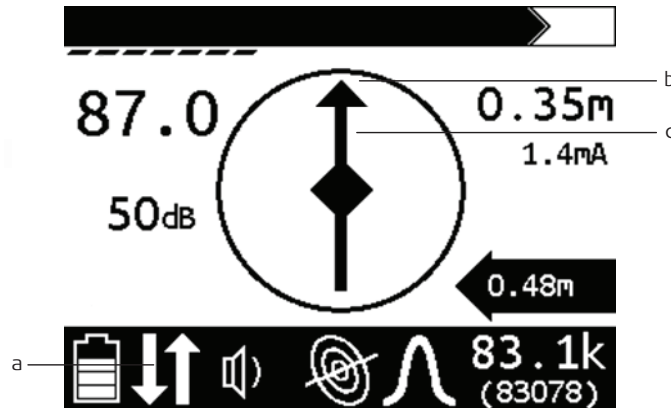

- a) Direction Enable icon
- b) Arrow on compass heading
- c) Compass heading

1. On the transmitter menu, navigate to **Settings** > **Output** > **Direction Enabled** and select **Enable**.
2. Ensure the function is available by looking for the Direction Enable icon on the locator.
3. Stand approximately 10 ft (3 m) from the transmitter with the locator positioned so that the compass heading is parallel to the target line. Face away from the transmitter.

4. . Press and hold the Frequency button to set the direction of current flow. An arrow will appear on the compass heading.
5. Continue locating.



- 
- Power output is reduced when **Direction Enable** is in use.
  - **Direction Enable** is not available when transmitter is set to **High Output**.
-

## 6

# Ultra Advanced - Features

### 6.1

## Measure Ambient Interference

#### Description

The AIM® (Ambient Interference Measurement) application measures interference on the jobsite. For best locating, select a frequency with the least amount of interference. Interference levels are indicated numerically and graphically.

#### Procedure

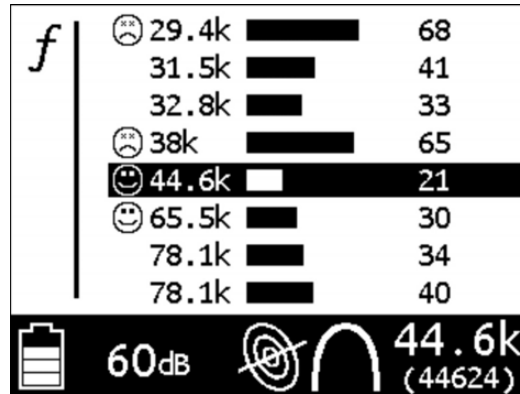

1. Ensure that transmitter output is turned off.
2. From the locator menu, select the **Ambient Noise** function. The locator will scan the surrounding area for interference on all frequencies enabled in the selected mode.
3. Highlight the desired frequency and press the **Next** button to exit the menu.

Icon	Description
	Frequencies with the least amount of interference
	Frequencies with a large amount of interference



- If a line is connected to an active signal, the ambient interference measurement will be high.
  - When a frequency is highlighted, a realtime interference is displayed.
  - The 😊 and 😞 are reversed for passive (power) modes.
-

## 6.2

### Link Locator to Transmitter

---

#### Description

Ultra Advanced locators and transmitters can be linked through a wireless connection. This allows the locator operator to change transmitter settings through the locator.

---

#### Procedure

To link the locator to a transmitter via radio:

1. Turn both locator and transmitter on and unlinked.
  2. On the locator: Navigate to **Settings** > **Communications** and select **Link TX**.
  3. On the transmitter: Navigate to **Settings** > **Communications** and select **Link RX**.
  4. Select a device to link. Link is complete when the link icon is displayed.
- 



Once linked, devices automatically connect when turned on. To unlink devices, navigate to **Settings** > **Communications** and select **Unlink**.

---



## 6.3

### Offset Depth

#### Description

Offset Depth assists in locating a target line that cannot be accessed from directly above due to obstruction. The function uses available data to estimate horizontal distance and depth.

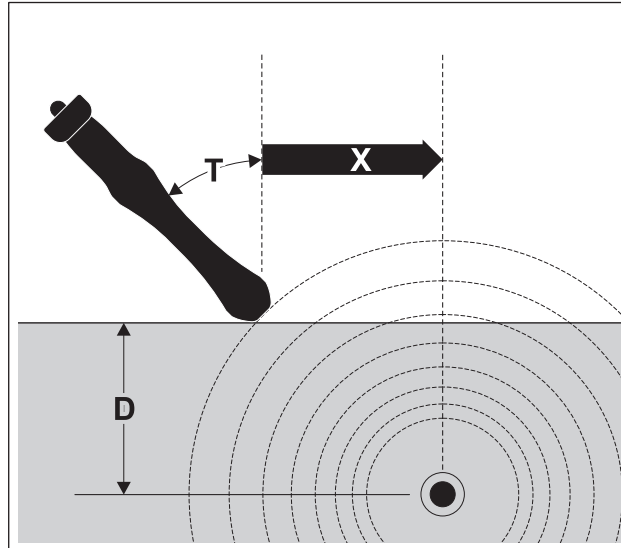

X Horizontal distance  
D Depth  
T Tilt

## Procedure

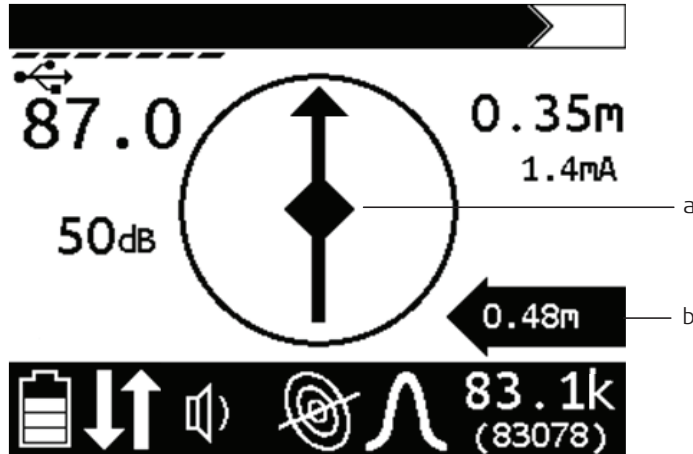

- a) Diamond
- b) Estimated distance

1. On the locator menu:  
Navigate to **Options** > **Offset Depth** and select **Enable**.
2. Begin by holding locator parallel to line.
3. Tilt locator until center diamond appears.  
 Tilt of unit should be  $>10^\circ$  and  $<60^\circ$  to display offset depth.
4. Read the estimated distance.

### Warning

The depth reading might not reflect the real depth if your locator picks up the signal induced into the service by the transmitter. This signal is radiated from the centre of the service. This is even more important when the signal is produced by a sonde, lying in a large diameter conduit!

#### **Precautions:**

Always compensate depth reading for service size.

# 7

## Locator Receiver Clamp

### 7.1

#### General Information

#### Description

The locator receiver clamp is used to identify a target line in a vault or utility box with multiple lines.

### 7.2



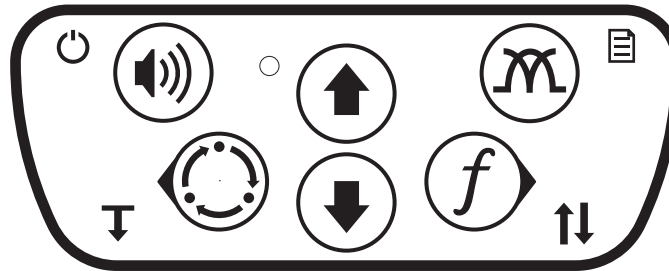

#### Locator Buttons Used with Clamp

#### Locator keypad



Locator button functions and information displayed will be specific to the locator receiver clamp.

#### Locator keypad buttons

	Power ON/OFF, press and hold		Up	
	Location mode		Down	 Frequency

## 7.3

### Locate with Locator Clamp

#### Procedure

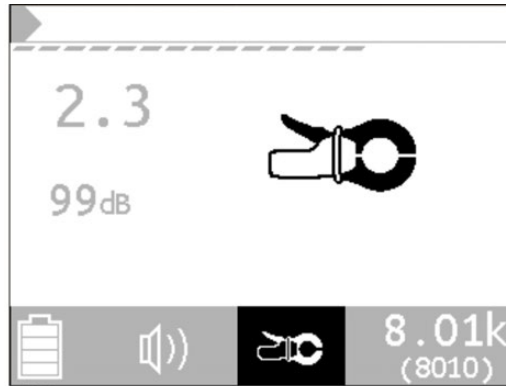

1. Plug the locator clamp cable into the accessory connector on the locator.
2. Turn on the locator. When clamp is plugged into locator, locator will enter clamp mode. Clamp icon will show.
3. Use locator frequency key to select desired frequency. Use mode key to toggle between active and passive power frequencies.
4. Compress the clamp handles together to open the clamp.
5. Place the clamp around the target line and release handles to close clamp.
6. Adjust the locator gain using the up and down arrow keys to bring the received signal strength into range.



**Danger**

A hazardous signal may be present on the service causing personal harm.

**Precautions:**

Do not use on electrical services which have impaired, or no insulation. If in doubt do not use.

# 8

## Locator with Stethoscope

### 8.1

#### General Information

#### Description

The stethoscope accessory is used to identify lines in cabinets with multiple lines. It has an adjustable neck to make it easier to identify target lines in tight spaces.

### 8.2



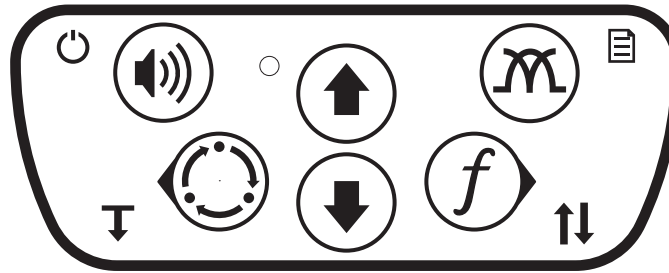

#### Locator Buttons Used with Stethoscope

#### Locator keypad



Locator button functions and information displayed will be specific to the stethoscope accessory.

#### Locator keypad buttons

	Power ON/OFF, press and hold		Up	
	Location mode		Down	 Frequency

## 8.3

### Locate with Stethoscope

#### Procedure

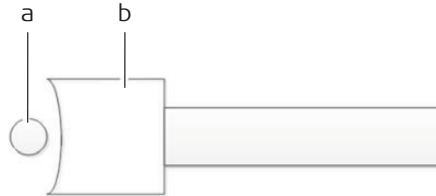
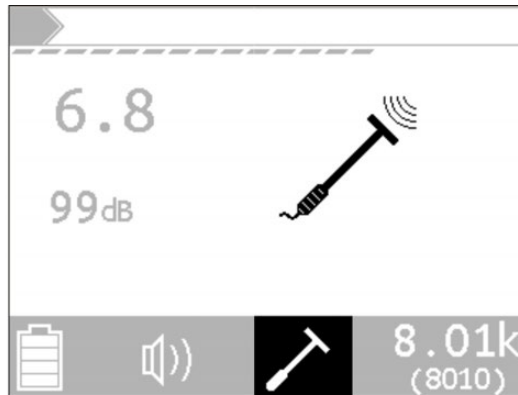

- a) Target line
- b) Head

1. Plug the stethoscope cable into the accessory connector on the locator.
2. Turn on the locator. When stethoscope is plugged into locator. Locator will enter stethoscope mode. Stethoscope icon will show.
3. Use locator frequency key to select desired frequency. Use mode key to toggle between active and passive power frequencies.

4. Grip stethoscope by the handle and place the head as close to the target line as possible. Position the target line in the concave portion of the head as shown.  
 Adjust flexible neck as needed to improve positioning.
  5. Adjust the locator gain using the up and down arrow keys to bring the received signal strength into range.
-

## 9

# Locate Sonde Signal

### 9.1

## General Information

---

#### Description

Trace metallic pipes or conduits by locating and following a sonde signal.

---



Large metal objects and other signals (such as railroad signals or overhead power lines) will distort signal.

---

### 9.2

## Setup

---

#### Procedure

1. Follow instructions for installing sonde battery.
  2. Turn on locator to ensure that sonde is functioning properly.
  3. Attach sonde to drain rods, plumber's snake, flex rod or similar.
-



## 9.3

## Technique

### Procedure

1. Turn on locator.
2. Set operating mode to sonde location.
3. Set antenna configuration to **Total Field**.
4. Place sonde into the pipe and move it down the pipe.
5. Locate sonde using peak or null methods.

### Peak signal method

Peak location is the preferred method in most situations. When the peak signal is in range, rotation arrows will appear.

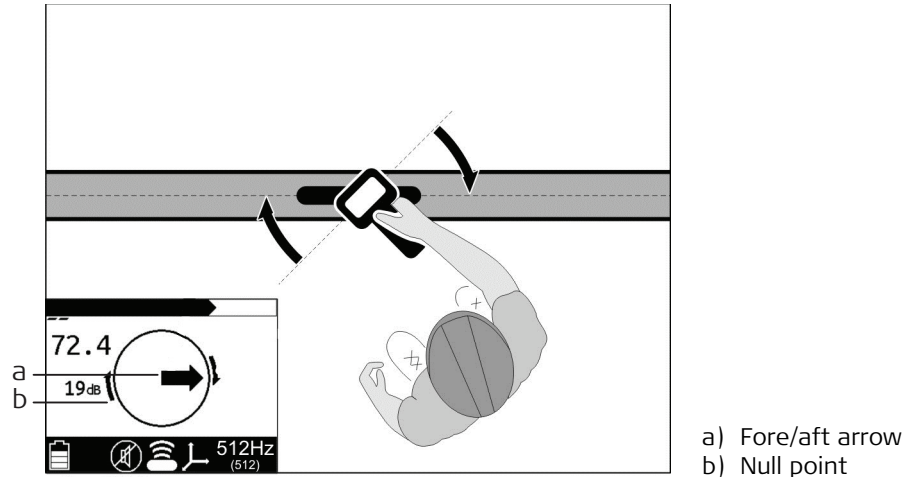

1. Follow arrows to rotate the locator handle so that it is perpendicular to the sonde.
2. Follow fore/aft arrow to locate the approximate sonde position.

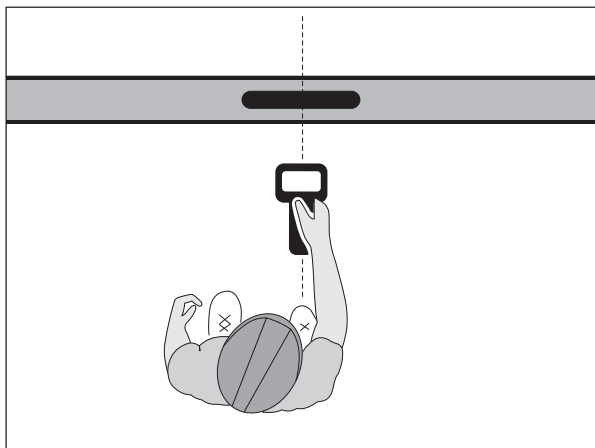

3. Walk forward or backward to identify the location with the strongest signal response.

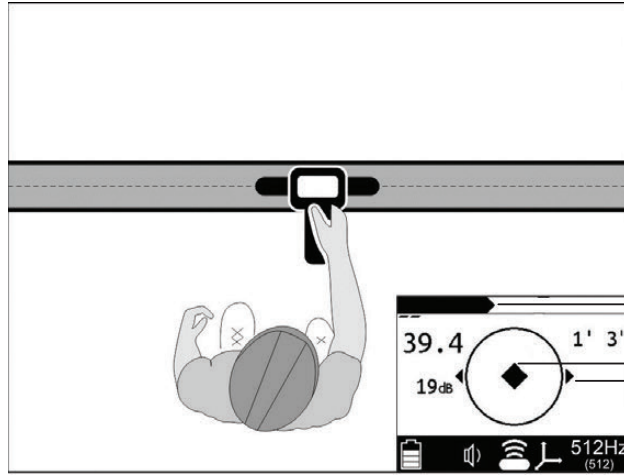

- a) Strongest signal
- b) Diamond
- c) Exterior arrows

4. When the sonde is correctly located, a diamond will form in the center of the compass, the exterior arrows will appear, and the signal will be strongest. The depth reading will display.
5. If operating in Manual depth, press the **Depth** key to estimate depth.
6. Continue to track the sonde and observe depth readings. Mark pipe location with paint.

## Null point method

Null point method is effective for locating deep sondes or for verifying the location of a sonde.

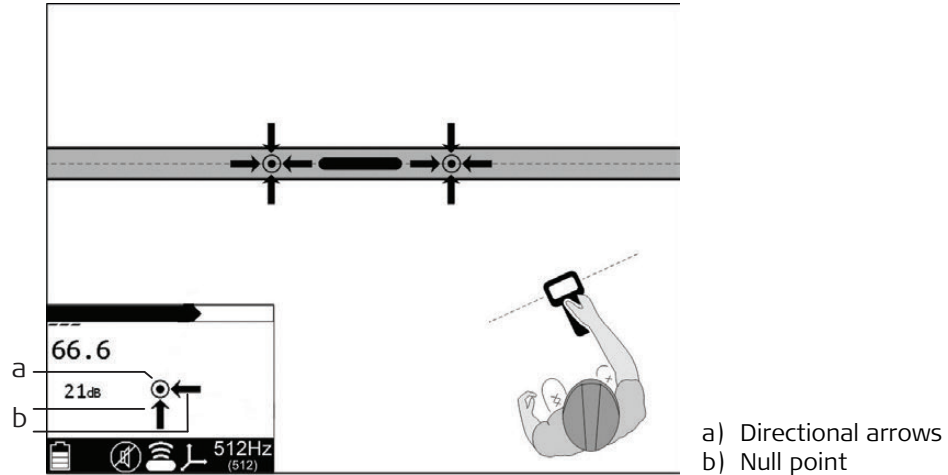

1. Circle over approximate location.
2. Follow directional arrows to locate the null point.
3. The sonde is correctly located at peak signal between null points.

### Warning

The depth reading may not indicate the real depth of the service, especially if the sonde is lying at the base of a large diameter duct.

#### **Precautions:**

Always compensate depth reading for service size.

# 10

# Electronic Marker Location (EML) Accessory

## 10.1

## General Information

### Description

The EML accessory is designed to locate electronic markers on pipes and cables. It allows users to find any standard electronic marker, used to mark specific locations for future locating.

## 10.2



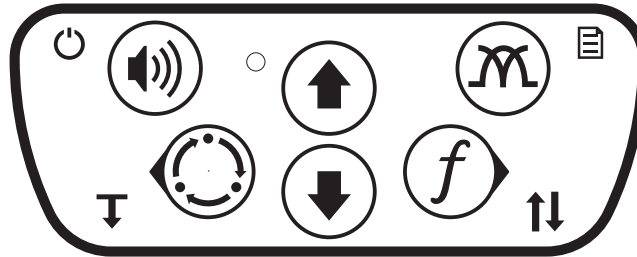

## Locator Buttons Used with EML Accessory

### Locator keypad



Locator button functions and information displayed will be specific to the EML accessory.

### Locator keypad buttons

	Power ON/OFF, press and hold		Up		
	Volume				
	Location mode		Down	<i>f</i>	Frequency



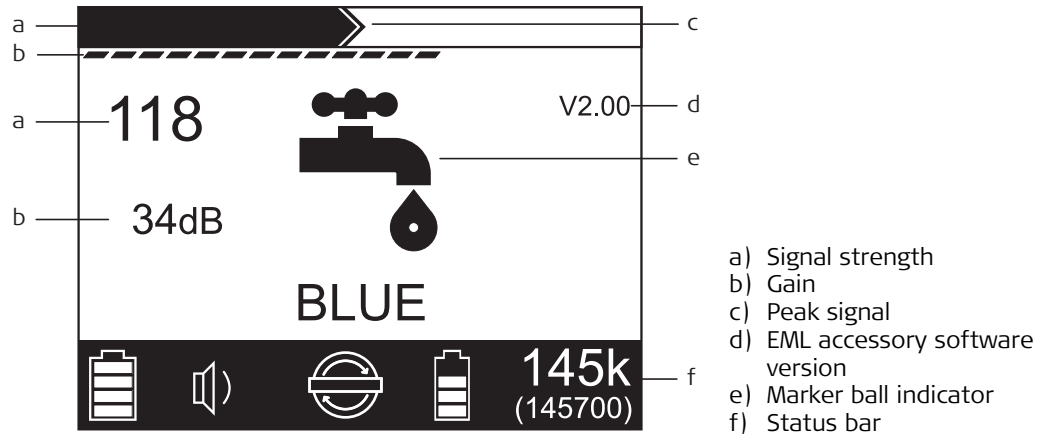

## 10.3

### Locator Display





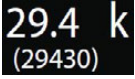

#### Display panel overview



## Status bar icons

Type	Icon	Description
Battery		Locator battery level
Volume		Volume level
EML		Normal mode
		Search mode
		Battery level
Frequency setting		Selected frequency setting

## Marker ball indicator

Icon	Description
	Water, blue, 145 k Non-potable water, purple, 66.3 k
	Power, red, 169 k, non-EU only Power, red/blue, 134 k, EU only
	Waste water, green, 121 k
	Communications, black/orange, 77.0 k
	Phone, orange, 101 k
	Gas, yellow, 83.0 k



## 10.4

### Setup

#### Setup

1. Place locator wand into recess of the EML accessory.

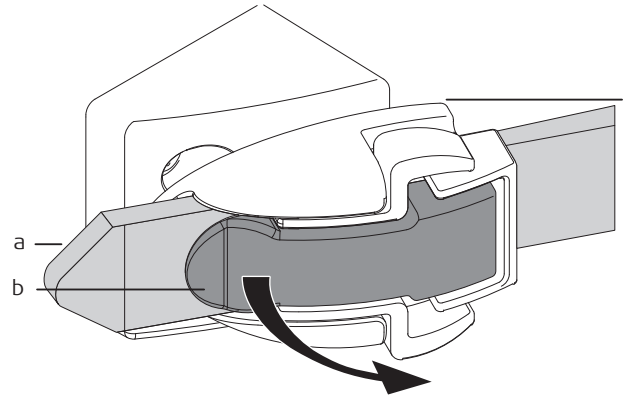

- a) Strap
- b) Buckle ratchet
- c) Buckle

2. Insert strap through buckle.
  3. Tighten strap using buckle ratchet.
-  Do not overtighten.

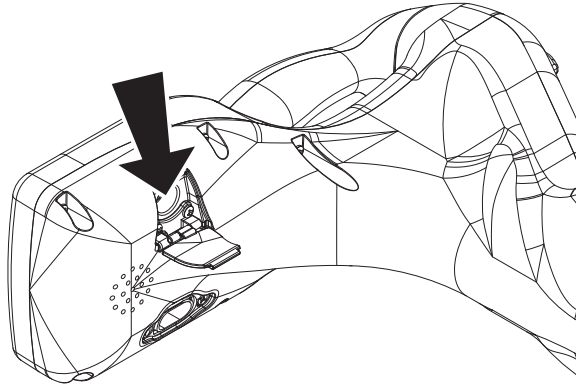

4. Plug cable into locator accessory connector behind spring-loaded door.

5. Turn locator on. The locator will enter EML Mode automatically and remain in EML Mode as long as EML accessory is plugged in and has sufficient battery power.

---

## Release

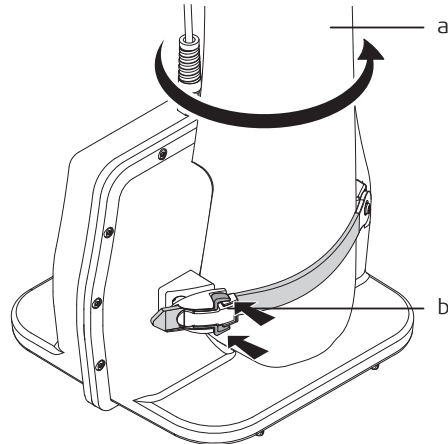

- a) Locator wand
- b) Levers

1. Disconnect the EML cable from the locator.
  2. Place EML accessory on solid surface (ground, tailgate, etc.) and hold locator wand with left hand while pushing both levers toward EML accessory with the right hand.
  3. When buckle clicks, continue pressing levers and twist locator to loosen strap enough to remove wand.
-

## 10.5

### Normal marker locating mode

### Technique

---

1. Attach EML accessory to the locator.
  2. Plug the EML cable into the locator accessory connector.
  3. Select marker type using the frequency key.
    -  Test unit for proper operation by passing the wand 1 m (3') over a marker. Signal strength should increase and the bar graph should close.
  4. Walk over area where you suspect a marker has been buried. Hold EML accessory close to the ground and move it from side to side. Move in the direction of increasing signal strength. Adjust gain as needed. Marker is located where locator indicates maximum signal.
  5. To locate next marker, adjust gain to 30 dB and repeat process.
-

## Change batteries

Use ten AA-cell alkaline batteries in transmitter.

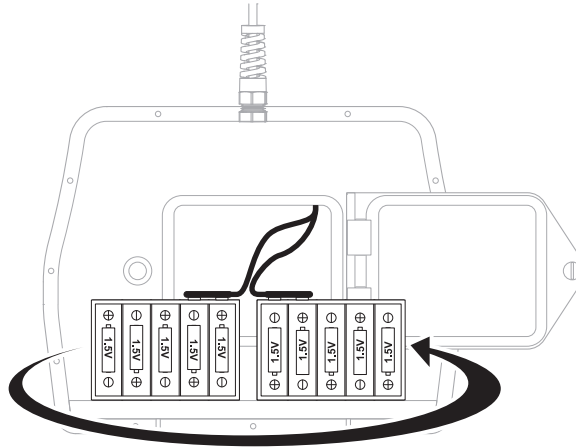

1. Open battery cover.
2. Remove battery holder.
3. Insert batteries in holder as shown.
4. Place battery holder in battery compartment.
5. Close and tighten battery cover.



- Installing batteries backwards will cause damage to batteries and unit.
- Do not mix new and used batteries.

# 11

## 11.1



### How earth return faults are created

# Fault Finder on Ultra Advanced

## General Information

---

The locator and transmitter require setup when using the fault finder accessory. Key functions and information displayed will be specific to the fault finder.

---

When a direct-buried cable's insulation is damaged, the conductor is exposed to contact with the earth which creates a fault. If large enough, the fault can degrade the service provided by the cable. This type of fault is called an earth return fault. These damaged areas interact with the earth which causes corrosion that can further degrade the service.

Faults can be caused by a number of actions.

Action	Description
Splicing	Corroded or damaged splices may fault to ground.
Excavation	Cables can be nicked or broken by excavation equipment such as shovel, backhoe, trencher, drill head, auger, fence post, etc. These nicked areas can fault to ground and provide a place for corrosion to start.
Abrasion	Rocks and other abrasive elements can damage cable when the earth shifts due to soil conditions, climate and above-ground traffic.



---

Although there are other types of faults, only earth return faults can be detected with this type of equipment.

---

## Finding general location of a faulted cable

Some things to look for when searching for the general location of a faulted cable are:

- Recently disturbed soil
- Past splices
- "Buried utility" notices
- Utility facilities without overhead lines
- Function boxes
- Drop boxes
- Light poles
- Sunken ground

## Fault locating concepts

Isolating the cable on both ends and then energizing it with a special signal generated by a transmitter creates an electrical circuit where current flows down the cable and seeks a path back to the transmitter. The path back to the transmitter is along the path of the fault to ground. Current will not flow without a path to ground.

Use a fault probe to probe the earth and measure the signal along the path of the cable. Signal will be highest at the point of the fault where the current enters the ground and at the transmitter ground stake. The arrows on the locator point toward the direction of the fault.

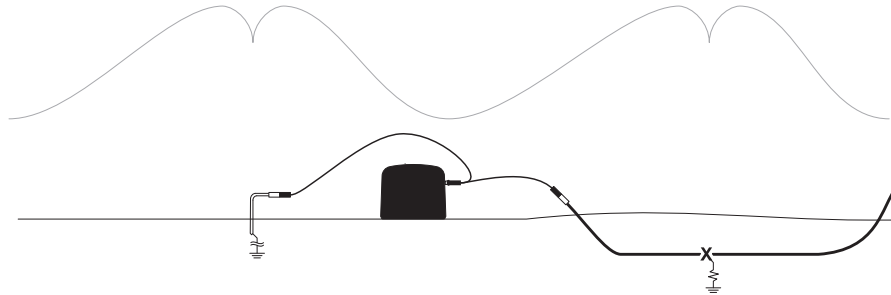

As you move away from the transmitter, detector may stop indicating transmitter pulses. As you near the fault, detector will resume indicating transmitter pulses. This is normal. Transmitter pulses are strongest near the point of the fault (X) and at the transmitter ground. When probes straddle the fault or transmitter ground, signal will drop.

## 11.2



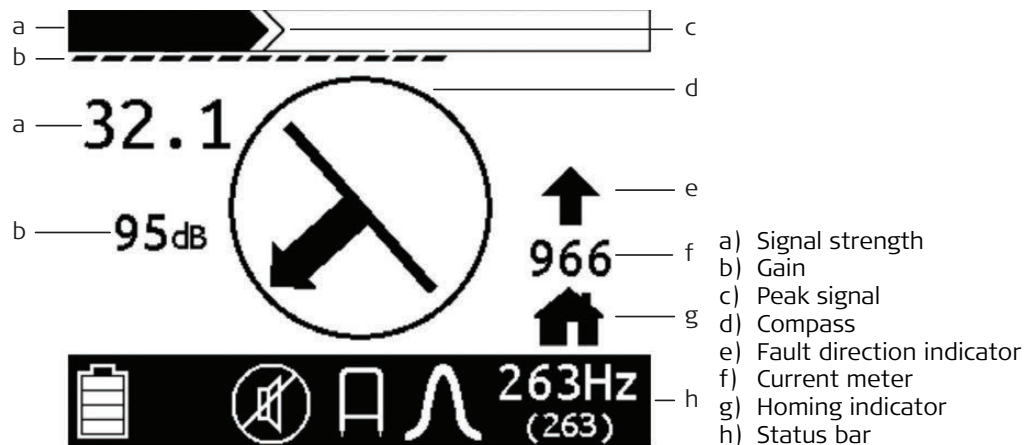

### Locator

#### Display panel overview





## Status bar icons

Type	Icon	Description
Battery		Locator battery level
Volume		Volume level
Mode		Fault Mode indicator
Antenna		Antenna indicator
Frequency setting		Selected frequency setting

## Locator and fault probe



- Fault mode is not available on basic locators.
- If locator does not have 263 Hz installed, fault finding will not work.
- Locator must be running firmware v6 or higher.
- The locator can also locate cables while in Fault Mode but performance will vary based on the amount of current on the cable.

1. Press On/Off key to turn on locator.
2. Plug fault probe into accessory port.



3. When fault probe is plugged into locator, locator will enter fault mode. Probe icon will show.  
A home symbol flashes in the bottom right corner of the locate screen.
4. Connect transmitter to faulted cable following transmitter setup instructions. Select power level 1 or 2 on transmitter and observe adequate current on the cable, ideally at least 10 mA.

5. With back toward transmitter, move down faulted cable a few meters/feet from transmitter.
6. Center fault probe over the cable and ensuring that no services are below push it into the soil.
7. Numbers will appear above the flashing home icon.  
Once they do, press and hold Frequency key to home the fault system.

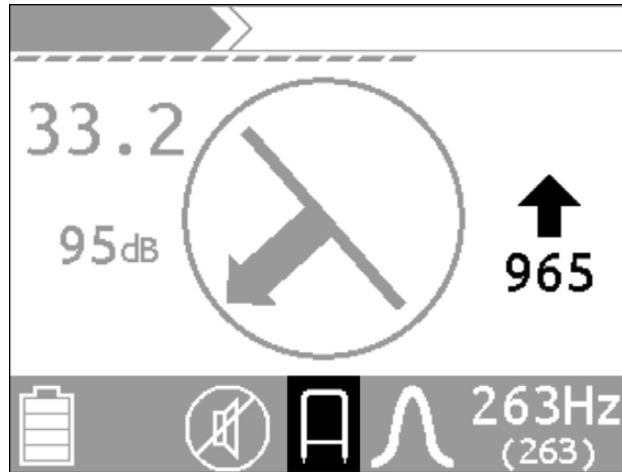

8. After system is successfully homed, a chime will sound and an arrow will appear, as shown. This indicates the fault is located toward the top of the screen.



Keep fault probe and locator oriented the same while fault finding.

## 11.3

## Transmitter

### Display panel overview

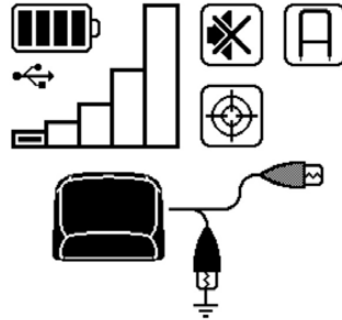





**FF**  
(263)







**10mA**

**701Ω**  
**7V**

The transmitter display shows the status of selected options as well as the active frequency and meter reading.

### Display icons

Type	Icon	Description
Battery/power		Battery level
		External power connected
USB		Connected
Output power		Level
		High power output enabled

Type	Icon	Description
Volume		On
		Off
Fault finder	<b>FF</b>	Fault finder mode indicator
Output		Active
		Interrupted
Link		Linked to locator
Induction		Direct-connect leads connected
		Dual-connect leads connected

## Setup

 Transmitter must be running firmware v2 or greater.

1. De-energize and disconnect the cable at both ends.  
Turning off a breaker is usually not enough to isolate the cable for fault finding.
2. Plug direct connect lead into transmitter.
3. Connect black lead of the transmitter to the ground stake and connect the red lead to one end of the faulted cable.
4. Press the On/Off key to turn on fault transmitter.
5. Press and hold the Power Level key to enter menu.
6. Navigate down to Options menu and press Power Level key to select.
7. Navigate down to Fault Mode and press Power Level key to select.

 If direct connect leads are not plugged in, Fault Mode will not appear in menu.

8. Select **Enabled** by pressing Power Level key.
9. Transmitter will return to main screen and be in fault mode.

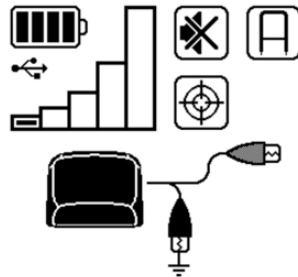

**FF**  
**(263)**

**10 mA**

**701 Ω**  
**7 V**

After the transmitter is connected to the cable, the impedance reading will help verify that a fault exists on the cable.

While transmitter is in Fault Mode, the screen will show:

- Current
- Impedance
- Voltage
- Power level 1

If current is below 5 mA, increase power level until it shows 5 mA or transmitter is at highest power level.

Readings > 100 k indicate no significant fault exists in the cable.

Readings < 50 k indicate a fault is likely.

Higher transmitter power levels give better readings. Try a higher power level to ensure the cable is faulted.

## 11.4

### Locate Faults

#### Known cable route

After the locator is homed, the locator will display signal strength and direction if sufficient signal is present. If no signal is detected, detector will display ---- in center of screen.

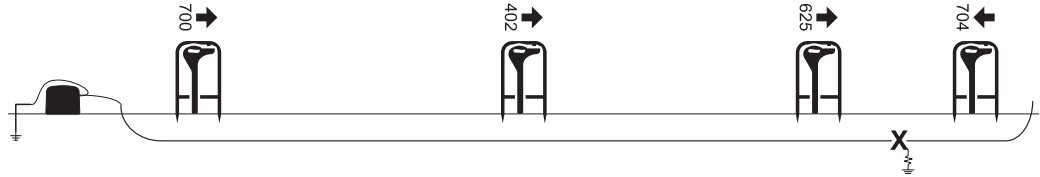

1. Move 3 m (10') down the cable route and ensuring that no services are below insert fault probe again.
2. After arrows point in the opposite direction, insert detector a few meters (feet) back down the cable.
3. Repeat step 2 moving smaller distances until arrow changes direction after only a few millimeters (inches) of movement.
4. Rotate fault probe 90° and repeat location process until arrow switches direction after a small movement. Fault is directly between probes.

## Unknown cable route



If possible, locate the cable with a locator and mark the location. Then follow the instructions in "Known cable route".

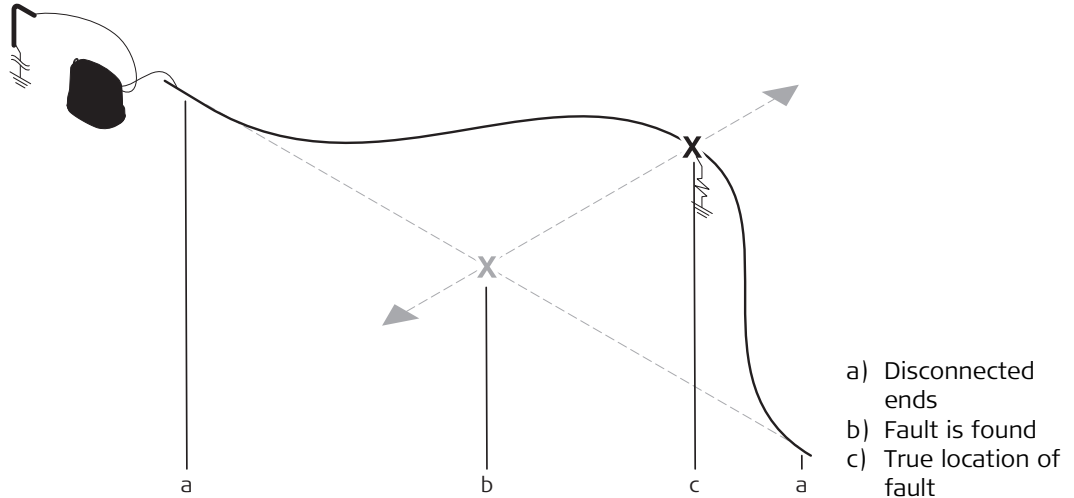

1. Draw a straight line between the two disconnected ends of the isolated cable.
2. Follow the instructions in "Known cable route".
3. Once fault is found on straight line, turn fault probe 90° and find true location of fault.

## Multiple faults

After a fault is located and fixed, check the rest of the cable for other faults using the same process.



## 12

# GPS Capability on Ultra Advanced

### 12.1

## General Information

#### Description

The GPS capability is used to log locate data from the locator to the GPS unit or log data in the locator.

### 12.2



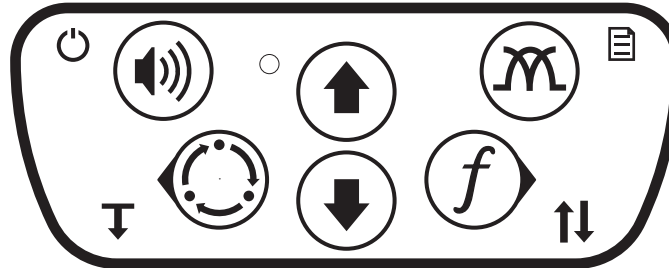

## Locator Buttons Used with GPS

#### Locator keypad



Locator button functions and information displayed will be specific to the GPS accessory.

#### Locator keypad buttons

	Power ON/OFF, press and hold		Up		
	Location mode		Down	<i>f</i>	Frequency





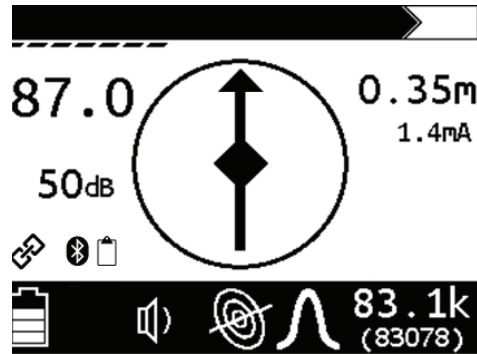

## 12.3

### Locator Display

Display panel overview



## GPS indicators

Icon	Description
	A Bluetooth® connection is active
	Flashing once: A data point was logged
	Blinking: Attempting to call external logging GPS device
	Last data point failed to send data to the GPS device
	GPS data being received, but no GPS lock, center dot blinking
	GPS data being received and GPS lock established, solid

## 12.4

### 12.4.1

## Locate Using GPS

### External Logging - Mapping Grade GPS

#### Description

This method of logging location data sends data from the locator to the GPS unit. This feature is only available on Ultra Advanced units.

#### Prerequisites

- The GPS unit must have software that will recognize the data that is sent by the locator.
- The GPS unit must support Bluetooth SPP connections.

#### Initial pairing

This is required the first time a GPS device is connected to the locator.

To use a different GPS device, repeat this procedure.

1. Power on the GPS device and ensure its Bluetooth radio is active and discoverable. Refer to the GPS device manual for details.
2. Power on the locator and go to **Settings > Communications > Radio On/Off**. Ensure the radio is "on".
3. Initiate pairing from the GPS device. Refer to the GPS device manual for details. The locator will be named "MFLRX\_nnnnnnnn" where nnnnnnn is the serial number of the locator. If prompted for a passcode, it is **0000** (four zeros).
4. If applicable to the selected GPS device, choose "Serial Port" as the service type.

#### Connecting to the GPS device

1. Launch the application software.
2. Connect to the locator in the GPS application software. For applications that connect to a COM port, make sure it is the incoming COM port.
3. On the locator go to **Settings > Communications > Bluetooth > Connect GPS**. The locator will begin scanning for Bluetooth® devices. Make sure the GPS device is still discoverable.
4. Select the GPS device from the list. The locator will begin the connection process.

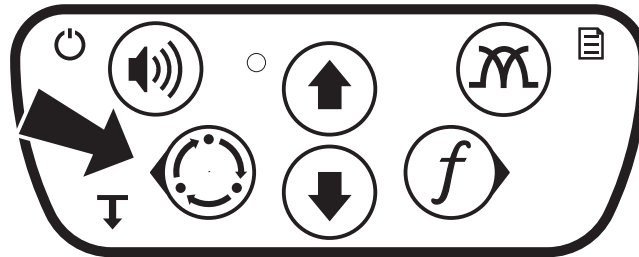
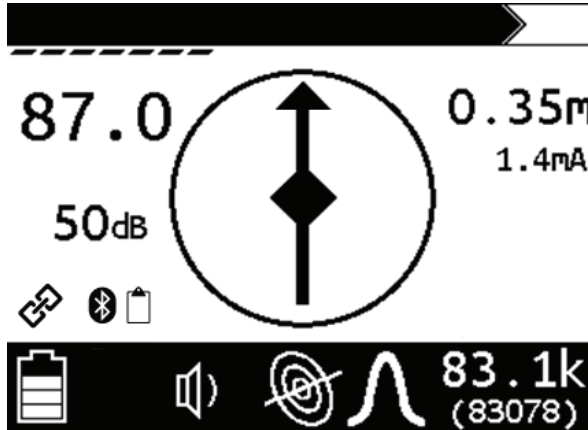

5. On the main locate screen, the Bluetooth icon should be on.

6. To store a point, force a depth from the main locate screen push and hold the bottom left button on the keypad. The user should hear a low tone and the log icon if data is sent instead of a high tone. If a high tone sounds when forcing the depth button the locator is not sending data. Reconnect to the GPS.

## 12.4.2

### Internal Logging - Document Grade GPS

#### Description

This application stored data in the locator for downloading later using the locator downloader software.

#### Connecting to the GPS device

1. Make sure you are in a location that the GPS can see satellites.
2. Power on the GPS and make sure it is discoverable.
3. Power on the locator and go to **Settings** > **Communications** > **Bluetooth** > **Connect GPS**.
4. Once the GPS is discovered, select it from the list.

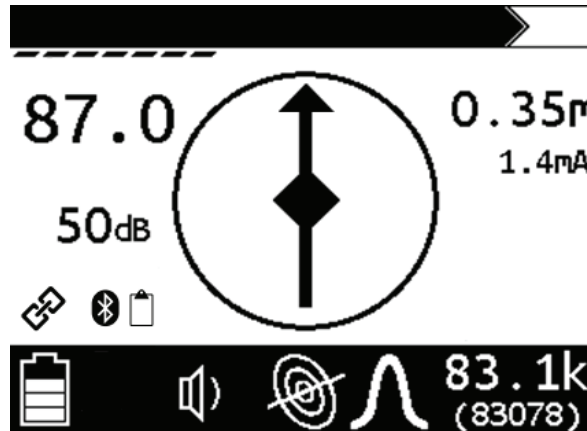

5. On the main locate screen, the Bluetooth icon should be on and the GPS receive icon should appear.

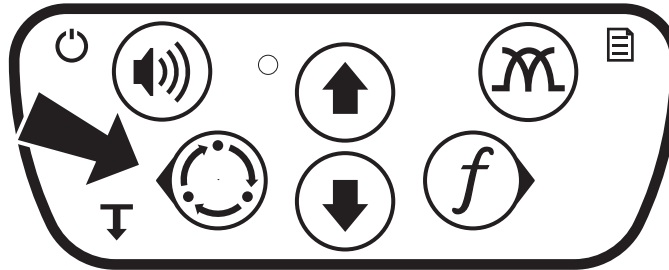

6. To store a point, force a depth from the main locate screen push and hold the bottom left button on the keypad. The user should hear a low tone if data is stored instead of a high tone. If a high tone sounds when forcing the depth button the locator is not storing data. Reconnect to the GPS.

## Troubleshooting

Troubleshooting	Measure
Either the GPS device or locator is unpaired	Un-pair or remove the other device from both devices and repeat the "Initial pairing" procedure.
Pairing fails	If the GPS device does not support Secure Simple Pairing, the passcode consisting of four zeros (0000) must be entered to complete pairing.
The connection fails from the <b>Connect GPS</b> menu	Repeat the connection attempt by selecting the GPS device again.
GPS device does not show up in the <b>Connect GPS</b> menu.	Make sure the GPS device's Bluetooth radio is active and it is discoverable. Some devices only remain discoverable for a few minutes. Check the device's Bluetooth settings.
The locator is not found by the GPS device during pairing.	Make sure the locator is <b>On</b> in <b>Settings &gt; Communications &gt; Radio On/Off</b> . The locator will revert to <b>Off</b> after power-cycling if no devices are paired.



## Retrieving GPS data

Install the Locator Log Downloader software supplied on the the disc or media card. Once the software is downloaded the GPS data stored in the locator can be retrieved.

1. Connect the USB cable from the PC to the locator.
2. Double click on the locator log downloader icon. The software will automatically connect to the locator and begin downloading stored information.
3. Once the software has downloaded the GPS information, it will give you an option to save the Log.
4. Click on the save log button. This will pull up a box allowing changing the file name and changing the file type to either a .KML file or a .CSV file.
5. Once finished saving, the log downloader will give you an option to clear the locator log data or close the utility.



---

It is recommended to clear the data off of the locator after every download.

---

## 13

### 13.1

## Care and Transport

### Transport

---

#### Transport in the field

When transporting the equipment in the field, always make sure that you carry the product in its original transport container.

---

#### Transport in a road vehicle

Never carry the product loose in a road vehicle, as it can be affected by shock and vibration. Always carry the product in its transport container and secure it.

---

#### Shipping

When transporting the product by rail, air or sea, always use the complete original Leica Geosystems packaging, transport container and cardboard box, or its equivalent, to protect against shock and vibration.

---

#### Shipping, transport of batteries

When transporting or shipping batteries, the person in charge of the product must ensure that the applicable national and international rules and regulations are observed. Before transportation or shipping, contact your local passenger or freight transport company.

---

### 13.2

### Storage

---

#### Product

Respect the temperature limits when storing the equipment, particularly in summer if the equipment is inside a vehicle. Refer to "14 Technical Data" for information about temperature limits.

If the equipment is to be stored for a long time, remove the alkaline batteries from the product in order to avoid the danger of leakage.

---

#### Batteries

- Protect batteries from damp and wetness. Wet or damp batteries must be dried before storing or use.
-

## 13.3

### Cleaning and Drying

---

#### Damp products

Dry the product, the transport container, the foam inserts and the accessories at a temperature not greater than 40°C / 104°F and clean them. Do not repack until everything is completely dry.

---

#### Cables and plugs

Keep plugs clean and dry. Blow away any dirt lodged in the plugs of the connecting cables.

---

# 14

## 14.1

### For products without radio

# Technical Data

## Conformity to National Regulations

---

FCC Part 15 (applicable in US)



Hereby, Leica Geosystems AG, declares that the Ultra is in compliance with the essential requirements and other relevant provisions of the applicable European Directives. The declaration of conformity can be consulted at <http://www.leica-geosystems.com/ce>.

---

### For products with radio

- FCC Part 15 (applicable in US)
- Hereby, Leica Geosystems AG, declares that the Ultra is in compliance with the essential requirements and other relevant provisions of Directive 1999/5/EC. The declaration of conformity may be consulted at <http://www.leica-geosystems.com/ce>.



Class 1 equipment according European Directive 1999/5/EC (R&TTE) can be placed on the market and be put into service without restrictions in any EEA member state.

- The conformity for countries with other national regulations not covered by the FCC part 15 or European directive 1999/5/EC has to be approved prior to use and operation.
-

## 14.2

### Locator Technical Data

---

#### Internal battery

Type:	2 D-cell alkaline
Typical operating time:	60 h intermittent use 30 h continuous use at 21°C / 70°F
Battery saver:	Unit shuts off after 5, 10, 20, or 30 min inactivity according to user setting, if selected

---

#### Bluetooth (when fitted)

Frequency bandwidth:	2402 - 2802 MHz
Output power:	100 mW
Antenna:	Integrated antenna

---

## Dimensions

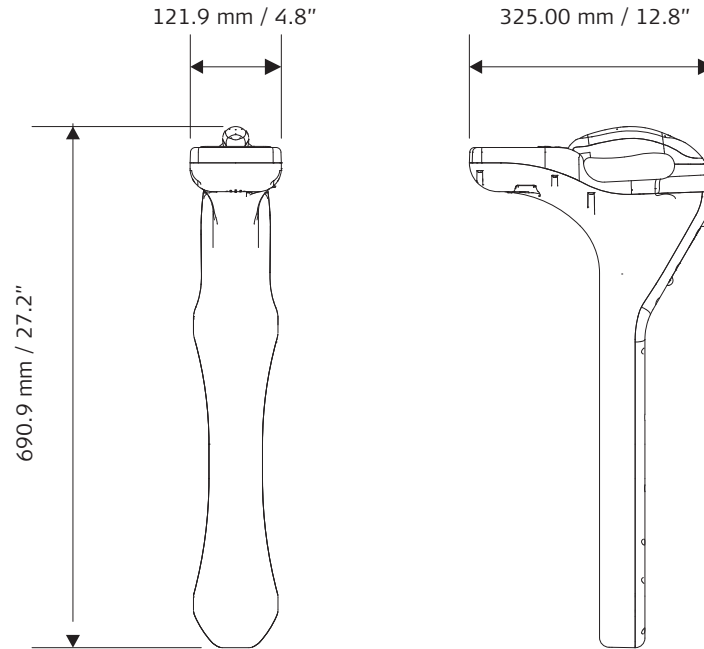

## Environmental specifications

Type		Description
Temperature	Operating	-20°C to +50°C -4°F to +122°F
Protection	Against water projected in jets from any direction	IP65 (IEC 60529) Dust tight
Humidity		95% RH non condensing The effects of condensation are to be effectively counteracted by periodically drying out the product.

## Antenna configurations

- Single peak
- Twin peak
- null
- Left/right, cable only

## Audio output

Speaker

## LCD backlight

LED

## External ports

Mini-USB

## 14.3

## Transmitter Technical Data

---

### Internal battery

Type:	10 D-cell alkaline or 1 Lithium ion battery pack
Typical operating time:	Alkaline: Approximately 100 h Lithium ion: Approximately 80 h
Battery saver:	Unit shuts off after 2, 4, 8 h or always on according to user setting, if selected.

---

### Dimensions

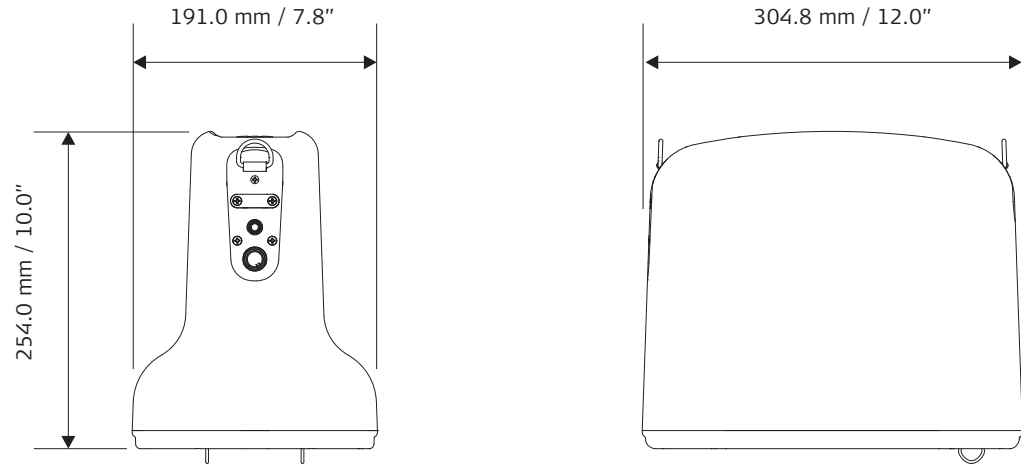



## Environmental specifications

Type		Description
Temperature	Operating	-20°C to +50°C -4°F to +122°F
Protection	Against water projected in jets from any direction	IP65 (IEC 60529) Dust tight
Humidity		95% RH non condensing The effects of condensation are to be effectively counteracted by periodically drying out the product.

## Maximum power output

Ultra 5 W:	5 W
Ultra 12 W:	12 W

## Bluetooth (when fitted)

Frequency bandwidth:	2402 - 2802 MHz
Output power:	100 mW
Antenna:	Integrated antenna

## 14.4

## System Operation Technical Data

### Operating modes and frequencies

Mode	Frequency
Active cable, standard	Up to 100 frequencies
Passive cable, standard	60 Hz, 120 Hz, 180 Hz, 50 Hz, 100 Hz, 150 Hz
Sonde, optional, locate/depth only	Any frequency
Radio, optional, locate only	-

### Locating ranges

Type	Range
Cables	4.6 m / 15'
Sondes	3.0 m / 10'

### Depth estimate tolerances

Locators are calibrated at factory frequencies to these tolerances under ideal test conditions. Actual operating conditions may have signal distortions or noise sources which result in depth estimate errors. Tolerances do not apply to offset depth estimates.

Type	Tolerance
Passive cable $\pm 10\%$	0.15-3 m / 0.5-10'
Active cable $\pm 5\%$	0.2-3 m / 0.2-10'
Sonde $\pm 5\%$	0.15-3 m / 0.5-10'

## 14.5

## Fault Finder Technical Data

---

### Dimensions

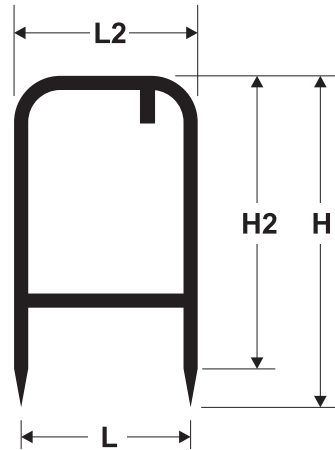

- L Length between probes
- L2 Handle length
- H Height from probe tip to carrying handle
- H2 Height from probe base to carrying handle
- W Width

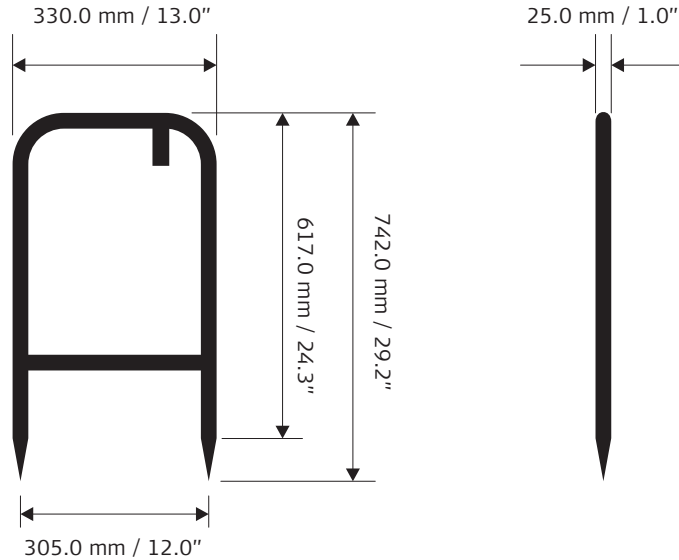

**Weight**

Instrument: 2.2 kg / 4.8 lbs

**Compatibility**

Transmitter must be running firmware v2.0 or higher  
 Locator must be running firmware v6.0 or higher

## 14.6

## EML Accessory Technical Data

### Dimensions

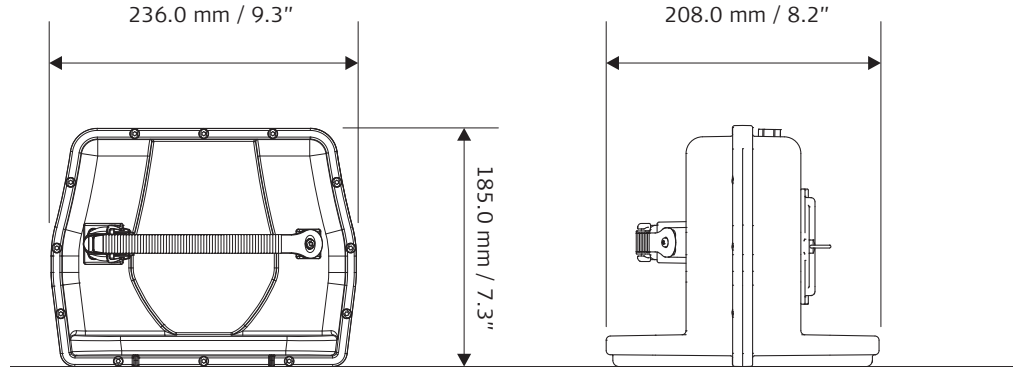

### Marker frequencies

Type	Frequency
Non-potable water	66.35 kHz
Cable television	77.0 kHz
Gas	83.0 kHz
Telephone	101.4 kHz
Sewer	121.6 kHz
electric power - EU countries	134.0 kHz
Water	145.7 kHz
electric power - non-EU countries	169.8 kHz

**Internal battery**

Type: 10 AA-cell alkaline  
Typical operating time: 20 h at low power

---

**Weight**

Instrument, including batteries: 1.4 kg / 3.0 lbs  
Instrument, without batteries: 1.2 kg / 2.5 lbs

---

**Environmental specifications**

<b>Type</b>		<b>Description</b>
Temperature	Operating	-20°C to +50°C -4°F to +122°F
Protection	Against water projected in jets from any direction	IP65 (IEC 60529) Dust tight
Humidity		95% RH non condensing The effects of condensation are to be effectively counteracted by periodically drying out the product.

---

**Compatibility**

Locator must be running software v7.0 or higher

---

## 14.7

### Live Power Adapter Accessory Technical Data

#### Dimensions

Length:	124 mm / 4.9"
Height:	48 mm / 1.9"
Width:	81 mm / 3.2"

#### Weight

0.9 kg / 2.0 lbs

#### Environmental specifications

Type		Description
Temperature	Operating	-20°C to +50°C -4°F to +122°F
Protection	Against water projected in jets from any direction	IP65 (IEC 60529) Dust tight
Humidity		95% RH non condensing The effects of condensation are to be effectively counteracted by periodically drying out the product.

#### Cable length

Transmitter side:	254 mm / 10"
Utility side (retracted coils):	635 mm / 25"

#### Input

480 V, 50/60 Hz

#### Output

10 VAC, 50/60 Hz

#### Fuse

F2.5A 500V

## 14.8

## Clamps

### Dimensions

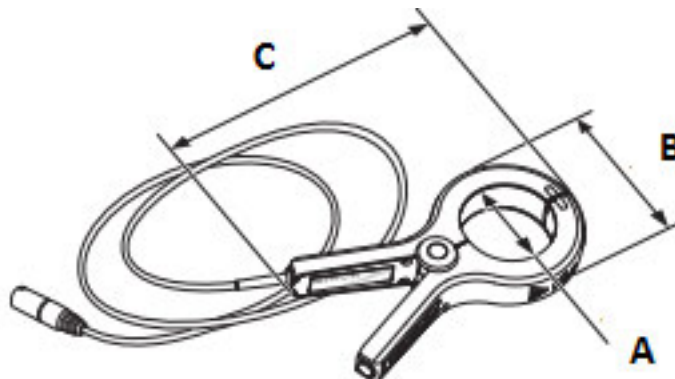

Type	Dimensions					
	A		B		C	
	[mm]	["]	[mm]	["]	[mm]	["]
Ultra signal clamp 80 mm	80	3.15	129	5.07	250	9.84
Ultra signal clamp 125 mm	125	5	163	6.4	275	10.8
Ultra signal clamp 175 mm	175	7	220	8.6	340	13.4
Receiver clamp	54.1	2.13	101	3.98	216	8.5



## Weight

Type	Weight	
	[g]	[lbs]
Ultra signal clamp 80 mm	820	1.8
Ultra signal clamp 125 mm	740	1.6
Ultra signal clamp 175 mm	915	2
Receiver clamp	915	2

## Frequency range

Type	Frequency
Ultra signal clamp 80 mm	256 Hz to 83 kHz
Ultra signal clamp 125 mm	3 kHz to 200 kHz
Ultra signal clamp 175 mm	3 kHz to 200 kHz
Receiver clamp	256 Hz to 200 kHz

## Environmental specifications

Type		Description
Temperature	Operating	-20°C to +50°C -4°F to +122°F
	Storage	-40°C to +70°C -40°F to +158°F
Protection	Against water, dust and sand	IP54 (IEC 60529) Dust-protected
Humidity		95% RH non condensing The effects of condensation are to be effectively counteracted by periodically drying out the product.

## 14.9

## Sondes

### Batteries

Type	Battery	Typical operating time [h]
Standard sonde	1 x LR6 (AA) alkaline	40 intermittent use at 20°C/68°F in 8 kHz mode or 33 kHz mode
Maxi sonde	3 x LR6 (AA) alkaline	10 continuous use at 20°C/68°F in 8 kHz mode or 33 kHz mode

## Dimensions

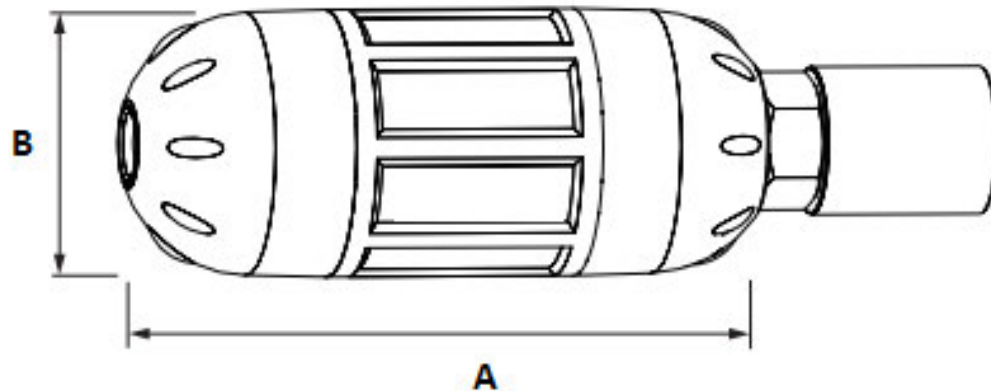

Type	Dimensions			
	A		B	
	[mm]	["]	[mm]	["]
Standard sonde	120	4.7	38	1.5
Maxi sonde	300	12	55	2.17

## Weight

Type	Weight	
	[g]	[lbs]
Standard sonde	180	0.4
Maxi sonde	830	1.18

**Frequency range**

Type	Frequency
Standard sonde	8.192 (8) kHz or 32.768 (33) kHz
Maxi sonde	8.192 (8) kHz or 32.768 (33) kHz

**Environmental specifications**

Type		Description
Temperature	Operating	-20°C to +50°C -4°F to +122°F
	Storage	-40°C to +70°C -40°F to +158°F
Protection	Against water, dust and sand	IP54 (IEC 60529) Dust-protected
Humidity		95% RH non condensing The effects of condensation are to be effectively counteracted by periodically drying out the product.

## 14.10

## Stethoscope

### Dimensions

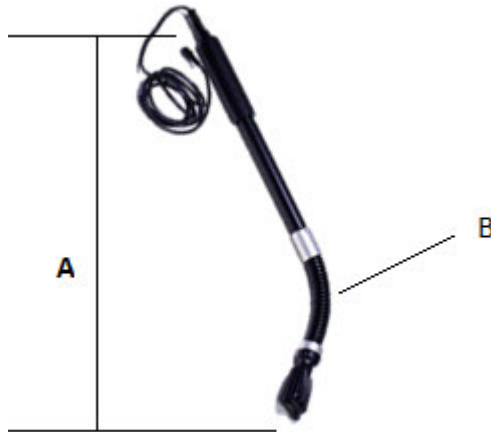

A (max)		B (bend)	
[mm]	["]	[mm]	["]
585	23	Radius (minimum)	
		76	3
		Angle (maximum)	
		90°	

### Weight

820 g / 1.8 lbs

**Frequency range**

50 Hz – 200 kHz

**Environmental specifications**

---

<b>Type</b>		<b>Description</b>
Temperature	Operating	-20°C to +50°C -4°F to +122°F
	Storage	-32°C to +70°C -25°F to +158°F

---

**International Limited  
Warranty**

This product is subject to the terms and conditions set out in the International Limited Warranty which you can download from the Leica Geosystems home page at <http://www.leica-geosystems.com/internationalwarranty> or collect from your Leica Geosystems distributor. The foregoing warranty is exclusive and is in lieu of all other warranties, terms or conditions, expressed or implied, either in fact or by operation of law, statutory or otherwise, including warranties, terms or conditions of merchantability, fitness for a particular purpose, satisfactory quality and noninfringement, all which are expressly disclaimed.

---

## Appendix A

## World Frequency Zones

---

### North America

Canada	120 V / 60 Hz
United States	120 V / 60 Hz
Mexico	120 V / 50 Hz, 60 Hz

### Central America

Bahamas	115 V / 60 Hz
Barbados	115 V / 50 Hz
Belize	110-220 V / 60 Hz
Bermuda	115 V / 60 Hz
Costa Rica	120 V / 60 Hz
Cuba	115-120 V / 60 Hz
Dominican Republic	110-220 V / 60 Hz
El Salvador	120-240 V / 60 Hz
Guatemala	115-230 V / 60 Hz
Haiti	110-220 V / 60 Hz
Honduras	110-220 V / 60 Hz
Jamaica	220 V / 50 Hz
Netherland Antilles	110-127 V / 50 Hz
Nicaragua	120 V / 60 Hz
Panama	120 V / 60 Hz
Puerto Rico	120 V / 60 Hz
Trinidad & Tobago	115-230 V / 60 Hz
Virgin Islands	120 V / 60 Hz

### South America

Argentina	230 V / 50 Hz
Bolivia	110 V / 50 Hz
Brazil	110-127-220 V / 60 Hz
Chile	220 V / 50 Hz
Colombia	110-220 V / 60 Hz
Ecuador	110-220 V / 60 Hz
French Guiana	220 V / 50 Hz
Guyana	110-240 V / 60 Hz
Paraguay	220 V / 60 Hz
Peru	220 V / 60 Hz
Surinam	110-127 V / 60 Hz
Uruguay	220 V / 50 Hz
Venezuela	120-240 V / 60 Hz

### Australia, Oceania

Australia	240 V / 50 Hz
Fiji Islands	240 V / 50 Hz
New Zealand	230 V / 50 Hz
Solomon Island	240 V / 50 Hz
Tonga	230 V / 50 Hz



## Europe

Albania	230 V / 50 Hz	Slovenia	230 V / 50 Hz
Austria	230 V / 50 Hz	Spain	230 V / 50 Hz
Belgium	230 V / 50 Hz	Sweden	230 V / 50 Hz
Belarus	230 V / 50 Hz	Switzerland	230 V / 50 Hz
Bulgaria	230 V / 50 Hz	Ukraine	230 V / 50 Hz
Croatia	230 V / 50 Hz	United Kingdom	230 V / 50 Hz
Czech Republic	230 V / 50 Hz	Yugoslavia	230 V / 50 Hz
Denmark	230 V / 50 Hz		
Estonia	230 V / 50 Hz		
Finland	230 V / 50 Hz		
France	230 V / 50 Hz		
Germany	230 V / 50 Hz		
Greece	230 V / 50 Hz		
Hungary	230 V / 50 Hz		
Iceland	230 V / 50 Hz		
Ireland	230 V / 50 Hz		
Italy	230 V / 50 Hz		
Latvia	230 V / 50 Hz		
Lithuania	230 V / 50 Hz		
Luxemburg	230 V / 50 Hz		
Moldavia	230 V / 50 Hz		
Netherlands	230 V / 50 Hz		
Norway	230 V / 50 Hz		
Poland	230 V / 50 Hz		
Portugal	230 V / 50 Hz		
Romania	230 V / 50 Hz		
Russia	230 V / 50 Hz		
Slovakia	230 V / 50 Hz		

## Africa

Algeria	127-220 V / 50 Hz	Niger	220 V / 50 Hz
Angola	220 V / 50 Hz	Nigeria	230 V / 50 Hz
Benin	220 V / 50 Hz	Rwanda	220 V / 50 Hz
Botswana	220 V / 50 Hz	Senegal	110 V / 50 Hz
Burkina Faso	220 V / 50 Hz	Sierra Leone	230 V / 50 Hz
Burundi	220 V / 50 Hz	Somalia	220 V / 50 Hz
Cameroon	127-220 V / 50 Hz	South Africa	220-240 V / 50 Hz
Central Africa Rep.	220 V / 50 Hz	Sudan	240 V / 50 Hz
Chad	220 V / 50 Hz	Swaziland	220 V / 50 Hz
Congo	220 V / 50 Hz	Tanzania	230 V / 50 Hz
Dahomey	220 V / 50 Hz	Togo	127-220 V / 50 Hz
Egypt	220 V / 50 Hz	Tunisia	127-220 V / 50 Hz
Ethiopia	220 V / 50 Hz	Uganda	240 V / 50 Hz
Gabon	220 V / 50 Hz	Zaire	220 V / 50 Hz
Gambia	230 V / 50 Hz	Zambia	220 V / 50 Hz
Ghana	240 V / 50 Hz	Zimbabwe	220 V / 50 Hz
Ivory Coast	220 V / 50 Hz		
Kenya	240 V / 50 Hz		
Lesotho	220-240 V / 50 Hz		
Liberia	120 V / 60 Hz		
Libya	115-220 V / 50 Hz		
Malawi	230 V / 50 Hz		
Mali	220 V / 50 Hz		
Mauritania	220 V / 50 Hz		
Mauritius	230 V / 50 Hz		
Morocco	127-220 V / 50 Hz		
Mozambique	220 V / 50 Hz		
Namibia	220 V / 50 Hz		

<b>Asia</b>			
Abu Dhabi	230 V / 50 Hz	Oman	240 V / 50 Hz
Afghanistan	220 V / 50 Hz	Pakistan	230 V / 50 Hz
Armenia	220 V / 50 Hz	Philippines	110-220 V / 60 Hz
Azerbaijan	220 V / 50 Hz	Qatar	240 V / 50 Hz
Bahrain	110-230 V / 50 Hz, 60 Hz	Saudi Arabia	127-220 V / 50 Hz
Bangladesh	230 V / 50 Hz	Singapore	230 V / 50 Hz
Brunei	240 V / 50 Hz	Sri Lanka	230 V / 50 Hz
Cambodia	220 V / 50 Hz	Syria	220 V / 50 Hz
China	220 V / 50 Hz	Taiwan	110-220 V / 60 Hz
Cyprus	240 V / 50 Hz	Tajikistan	220 V / 50 Hz
Georgia	220 V / 50 Hz	Thailand	220 V / 50 Hz
Hong Kong	220 V / 50 Hz	Turkey	220 V / 50 Hz
India	230-250 V / 50 Hz, 60 Hz	Turkmenistan	220 V / 50 Hz
Indonesia	127-220 V / 50 Hz	United Arab Emirates	220 V / 50 Hz
Iran	220 V / 50 Hz	Uzbekistan	220 V / 50 Hz
Iraq	220 V / 50 Hz	Vietnam	120-220 V / 50 Hz
Israel	230 V / 50 Hz	Yemen	220 V / 50 Hz
Japan	100-220 V / 50 Hz, 60 Hz		
Jordan	220 V / 50 Hz		
Kazakhstan	220 V / 50 Hz		
Kirgizstan	220 V / 50 Hz		
Korea (North)	220 V / 50 Hz		
Korea (South)	110-220 V / 60 Hz		
Kuwait	240 V / 50 Hz		
Laos	220 V / 50 Hz		
Lebanon	110-220 V / 50 Hz		
Malaysia	240 V / 50 Hz		
Myanmar	240 V / 50 Hz		

**Leica Geosystems AG**  
Heinrich-Wild-Strasse  
CH-9435 Heerbrugg  
Switzerland  
Phone +41 71 727 31 31  
[www.leica-geosystems.com](http://www.leica-geosystems.com)

- when it has to be **right**

**Leica**  
**Geosystems**

**841205-1.0.1 en**  
Original text:  
© 2015 Leica Geosystems AG, Heerbrugg, Switzerland