



RX8160BPS

ERGO™ Performance Specific Diagonal Cutters with Oval Unique Head & Relieved Tip







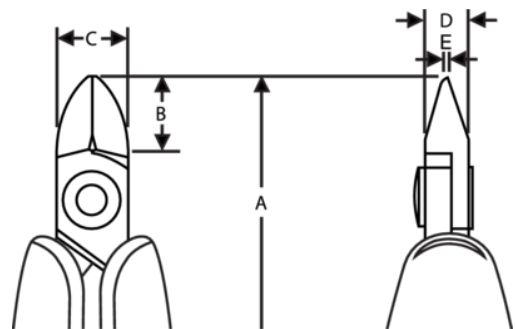



PRODUCT DETAILS

- Designed to cut multiple guidewires, catheter coil wires & cardiology & urology stents
- Micro-bevel cut
- Sharp & fully aligned edges
- ERGO™ handles with two-component combination, thermoplastic surface, for comfortable grip, on tough polypropylene core for rigidity
- High performance alloyed steel
- Burnished finish
- Numerically controlled machine grinding guarantees edge angle accuracy & contact, increases the tool's reliability & consistency
- Precision induction-hardened edges 63-65 HRC
- Screw joint minimises friction & maximises alignment of cutting edges
- ESD safe handles in two-component synthetic material
- Bio spring limits the tension throughout the working cycle of the tool & can be adjusted to 3 different positions or removed



PRODUCT ATTRIBUTES

Product: **RX8160BPS**

	Oval		L		Micro-Bevel®
	0.1-1.0 mm		0.01-0.04 in		0.3-0.8 mm
	0.01-0.03 in	A	147 mm	A	5.80 in
B	16 mm	B	0,63 in	C	16 mm
C	0.63 in	D	8 mm	D	0,31 inch
E	1,6 mm	E	0,06 in		97 g