



7191

Flush Cut Diagonal Cutter with  
Tapered Head & ESD Safe Handle  
0.1 mm-1 mm







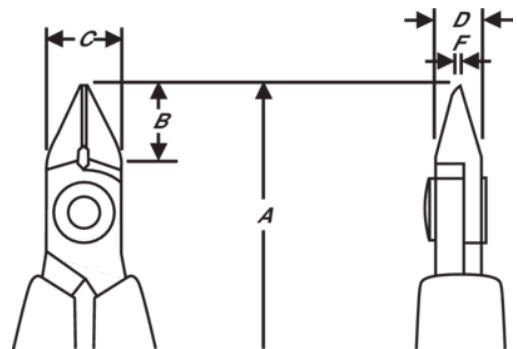

## PRODUCT DETAILS

- Ideal for assembly work where access is a consideration
- Material: High performance alloy steel
- Polished and precision induction hardened to 63–65 HRC
- Precision screw joint minimizes friction and maximizes alignment of cutting edges
- ESD safe handles in synthetic material with leaf springs
- Cutting capacity is listed for solid copper wire



PRODUCT ATTRIBUTES

Product: **7191**

	Tapered		S		Flush
	0.1-1.0 mm		0.00-0.04 in	<b>A</b>	108 mm
<b>A</b>	4.29 in	<b>B</b>	9 mm	<b>B</b>	0,35 in
<b>C</b>	9 mm	<b>C</b>	0.35 in	<b>D</b>	6 mm
<b>D</b>	0,24 inch	<b>F</b>	1 mm	<b>F</b>	0,04 in
	50 g	<b>Ω</b>	Dissipative		