



**8248**  
**Flush Precision Cut 45° Angle**  
**Tapered & Relieved Head Oblique**  
**Cutter 0.2 mm-0.8 mm**







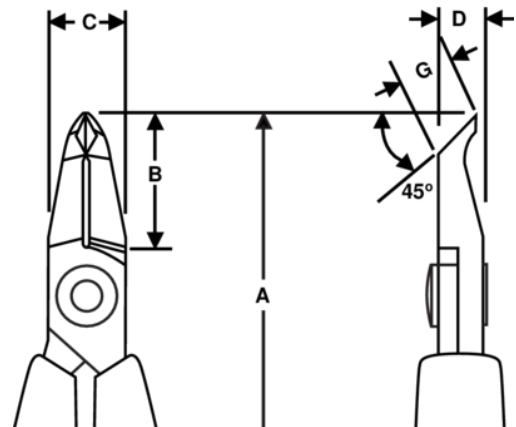

PRODUCT DETAILS

- Material: High performance alloy steel
- Exacting induction hardened edges 63–65 HRC
- ESD safe handles in synthetic material with leaf springs
- Precision screw joint that minimizes friction and maximizes alignment of cutting edges
- Cutting capacity is listed for solid copper wire



PRODUCT ATTRIBUTES

Product: **8248**

	Angle 45°		S		Flush
	0.2-0.8 mm		0.01-0.03 in	<b>A</b>	117.5 mm
<b>A</b>	4.63 in	<b>B</b>	18 mm	<b>B</b>	0,71 in
<b>C</b>	10 mm	<b>C</b>	0.39 in	<b>D</b>	6 mm
<b>D</b>	0,24 inch	<b>G</b>	7,5 mm	<b>G</b>	0,29 in
	51 g		Dissipative		