



## HS6000

### Multipurpose Shear with Non-Slip Grip and Smooth Jaws 145 mm







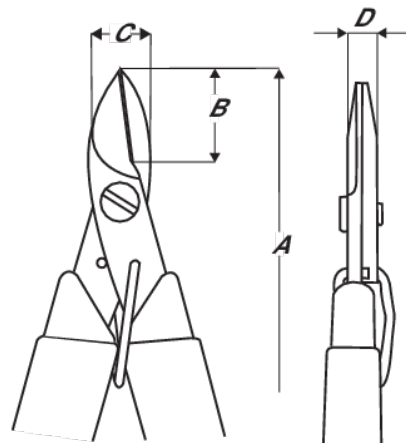

#### PRODUCT DETAILS

- Kevlar cutter
- Designed to cut tough Kevlar elements used in fibre optic & other types of cables
- High carbon steel blades with a hardness of 57-59 HRC
- Serrations on one edge to prevent the material being cut from sliding away
- Precision screw joint minimises friction & maximises alignment of cutting edges
- User-friendly while optimising durability & precision
- Fits comfortably in either hand
- ESD safe non-slip grips provide cushioning & secure grasp
- Ideal for many other applications such as cutting insulation, cables, ties & corded material of all types



PRODUCT ATTRIBUTES

Product: **HS6000**

	Serrated-Jaws		L		Flush
	Kevlar	<b>A</b>	145 mm	<b>A</b>	5.7 in
<b>B</b>	29 mm	<b>B</b>	1,1 in	<b>C</b>	12,7 mm
<b>C</b>	0.5 in	<b>D</b>	6,4 mm	<b>D</b>	0,2 inch
	Serrated		88 g	<b>Ω</b>	Dissipative