

# VC-A20P Quick Installation Guide

## 1. Instruction for Installation

### 1.1 Preparation before installation

Installation and connection of HD camera requires special skills. To install by yourself, please follow necessary steps, ensure steady and tight installation of the device, and pay attention to your safety to avoid any accident.

1. Ensure the safety of the installation environment. Please do not install the device on unstable ceiling or in a place where the device is in danger of falling to avoid any accident.
2. Please check whether accessories in the box are complete or not. Please contact the supplier for any shortage, and make sure to keep the accessories in the box intact.
3. Please choose a proper place for installation of camera in advance. Please determine an installation place according to the following requirements:
  - ▶ Confirm the position for the object to be captured.
  - ▶ Confirm whether the camera is set at a proper distance from other light sources.

## 2. I would like to install Camera on the desk

### 2.1 Precautions for installation

- ▶ Please install the machine on a flat desk.
- ▶ Do not grab the camera head by hand when handling the device.
- ▶ Do not rotate the camera head by hand. Improper rotation may result in breakdown of the camera.

### 2.2 Installation steps

1. Please adjust DIP switch at first prior to installation. (Please refer to [4. Instruction on DIP SWITCH Setting](#))
2. Place the camera on a flat desk directly to ensure the normal vertical and horizontal operation of the machine.

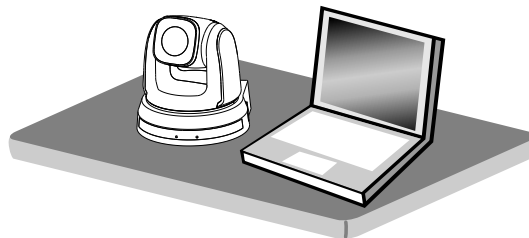

## 3. I would like to install Camera on the ceiling

### 3.1 Prepare for the parts and equipment required during the installation

- ▶ Accessories of Camera in the box (metal plates A, B, M3 screw x 7)
- ▶ Screw for locking on ceiling mounted hanger x 4
- ▶ Drilling machine, screw driver, ladder

### 3.2 Precautions for installation

1. Before installation, please confirm the orientation of the machine relative to the object to be captured.
2. It is recommended that the machine should be set at a distance of more than 1 meter away from the object to be captured. Please adjust for a best distance according to the magnification of the lens.
3. The machine (including metal plates) is weighed at about 2.5 kg. If it is to be installed on the ceiling, please use the hanger that has obtained UL security approval to prevent the machine from falling down.
4. Please check whether the camera is installed stably on a periodical basis.

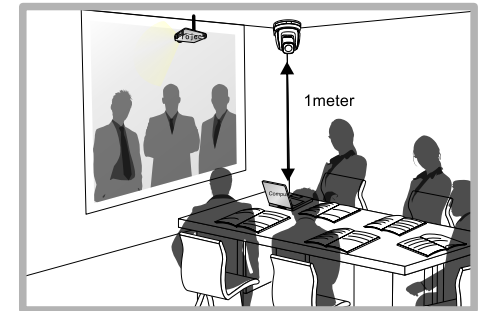

### 3.3 Installation steps

1. Please adjust resolution on DIP Switch at first. (Please refer to [4. Instruction on DIP SWITCH Setting](#))
2. Fix the metal plate A on the machine base with 4 M3 screws.

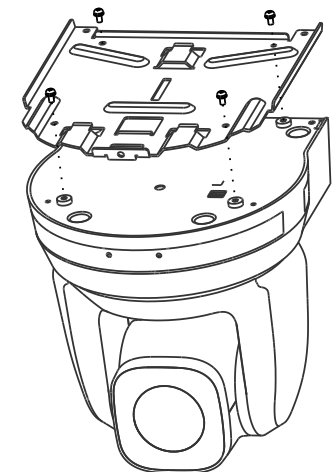

## 4. Instruction on DIP SWITCH Setting

### 3. Lock the metal plate B on ceiling mounted hanger

※Caution:

- \* Please use the hanger that has obtained UL security approval.
- \* Please reserve the hole for the connecting wires of the camera.

### 4. Combine the metal plate A and the metal plate B

- ▶ Push the metal plate A up to the ceiling and then to the right to latch the metal plate B.
- ▶ Fix with 3 M3 screws.

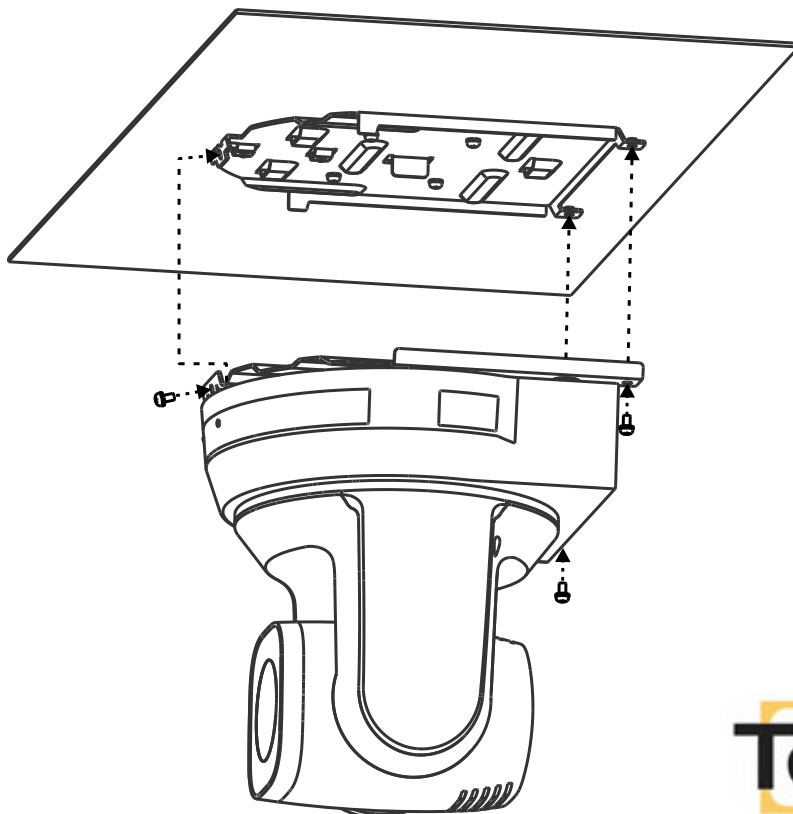

### 4.1 OUTPUT SWITCH

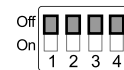

Output Mode	Setting
1920x1080/60p	
1920x1080/50p	
1920x1080/30p	
1920x1080/25p	
1920x1080/60i	
1920x1080/50i	
1280x720/60p	
1280x720/50p	
1080/59.94p	
1080/59.94i	
1080/29.97p	
720/59.94p	

### 4.2 IR SELECT



ID	Setting
1	
2	
3	

### 4.3 Camera Address Selector

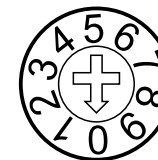

Setting	Function Descriptions
0~7	ID 0~7
8~9	Reserved

### 4.4 System Switch

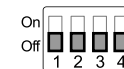

Setting	Function Descriptions
DIP 1	RS-232C/RS-422 selector OFF: RS-232C / ON : RS-422
DIP 2	Infrared signal output switch OFF: Off / ON : On
DIP 3	Communication baud rate selector OFF: 9600 / ON : 38400
DIP 4	Reserved

**Touchboards**

205 Westwood Ave, Long Branch, NJ 07740  
Phone: 866-94 BOARDS (26273) / (732)-222-1511  
Fax: (732)-222-7088 | E-mail: sales@touchboards.com