

# **VC-BC701P**

## **Ultra HD Camera**

### **(4K UHD Box Camera)**



## **User Manual - English**

**[Important]**

To download the latest version of Quick Start Guide, multilingual user manual, software, or driver, etc., please visit Lumens

<http://www.MyLumens.com/support>

# Table of Contents

Copyright Information .....	2
Chapter 1 Safety Instructions.....	3
Chapter 2 Package Contents.....	5
Chapter 3 Function Introduction .....	6
3.1 I/O functions Introduction .....	6
3.2 Tally Indicator Light Function Description .....	7
Chapter 4 Instruction for installation.....	8
4.1 Basic Devices.....	8
4.2 Connecting devices .....	9
Chapter 5 Network Function Settings Description.....	11
5.1 Web System Requirements.....	11
5.2 Connecting Camera to Network.....	11
5.3 Web Page Function Description .....	14
Chapter 6 Troubleshooting.....	25

# Copyright Information

---

Copyrights © Lumens Digital Optics Inc. All rights reserved.

Lumens is a trademark that is currently being registered by Lumens Digital Optics Inc.

Copying, reproducing or transmitting this file is not allowed if a license is not provided by Lumens Digital Optics Inc. unless copying this file is for the purpose of backup after purchasing this product.

In order to keep improving the product, Lumens Digital Optics Inc. hereby reserves the right to make changes to product specifications without prior notice. The information in this file is subject to change without prior notice.

To fully explain or describe how this product should be used, this manual may refer to names of other products or companies without any intention of infringement.

Disclaimer of warranties: Lumens Digital Optics Inc. is neither responsible for any possible technological, editorial errors or omissions, nor responsible for any incidental or related damages arising from providing this file, using, or operating this product.

# Chapter 1 Safety Instructions

---

Always follow these safety instructions when setting up and using the product:

## 1 Operation

- 1.1 Please use the product in the recommended operating environment.
- 1.2 Do not place the product in tilted position.
- 1.3 Do not place the product on an unstable trolley, stand or table.
- 1.4 Do not use this product near water or source of heat.
- 1.5 Use attachments only as recommended.
- 1.6 Use the type of power source indicated on the product. If you are not sure of the type of power available, consult your distributor or local electricity company for advice.
- 1.7 Always take the following precautions when handling the plug. Failure to do so may result in sparks or fire:
  - Ensure the plug is free of dust before inserting it into a socket.
  - Ensure that the plug is inserted into the socket securely.
- 1.8 Do not overload wall sockets, extension cords or multi-way plug boards to avoid potential risks.
- 1.9 Do not block the slots and openings in the case of product. They provide ventilation and prevent the product from overheating.
- 1.10 Except as specifically instructed in this User Manual, do not open or remove covers, otherwise it may expose you to dangerous voltages and other hazards. Refer all servicing to licensed service personnel.
- 1.11 Unplug the product from the wall outlet and refer servicing to licensed service personnel when the following situations happen:
  - If the power cords are damaged or frayed.
  - If liquid is spilled into the product or the product has been exposed to rain or water.

## 2 Installation

- 2.1 For security considerations, please make sure the standard hanging rack you bought is in line with UL or CE safety approbations and installed by technician personnel approved by agents.

## 3 Storage

- 3.1 Do not place the product where the cord can be stepped on as this may result in fraying or damage to the lead or the plug.
- 3.2 Never push objects of any kind through cabinet slots. Never allow liquid of any kind to spill into the product.
- 3.3 Unplug this product during thunderstorms or if it is not going to be used for an extended period.
- 3.4 Do not place this product or accessories on top of vibrating equipment or heated objects.

## 4 Cleaning

- 4.1 Unplug all the cables before cleaning. Use a damp cloth for cleaning. Do not use liquid or aerosol cleaners.





## 5 Remote control (if the accessories are equipped with remote control)

- 5.1 Using an incorrect battery type in the remote control may result in breakdown. Follow local instructions on how to dispose of used batteries.

■ **Precautions**

**Warning: To reduce the risk of fire or electric shock, do not expose this appliance to rain or moisture.**

If the HD camera will not be used for an extended time, unplug it from the power socket.

	<table border="1"> <tr><td style="text-align: center;">Caution</td></tr> <tr><td style="text-align: center;">Risk of Electric Shock</td></tr> <tr><td style="text-align: center;">Please do not open it by yourself.</td></tr> </table>	Caution	Risk of Electric Shock	Please do not open it by yourself.	
Caution					
Risk of Electric Shock					
Please do not open it by yourself.					
Caution: To reduce the risk of electric shock, do not remove cover (or back). No user-serviceable parts inside. Refer servicing to licensed service personnel.					
	This symbol indicates that this equipment may contain dangerous voltage which could cause electric shock.				
		This symbol indicates that there are important operating and maintenance instructions in this User Manual with this unit.			

■ **FCC Warning**

This HD Camera has been tested and found to comply with the limits for a Class A computer device, pursuant to Article 15-J of FCC Rules. These limits are designed to provide reasonable protection against harmful interference in a residential installation.

This digital apparatus does not exceed the Class A limits for radio noise emissions from digital apparatus as set out in the interference-causing equipment standard entitled "Digital Apparatus , " ICES-003 of Industry Canada.

Cet appareil numerique respecte les limites de bruits radioelectriques applicables aux appareils numeriques de Classe A prescrites dans la norme sur le material brouilleur: "Appareils Numeriques , " NMB-003 edictee par l'Industrie.

■ **EN55032 (CE Radiation) Warning**

Operation of this equipment in a residential environment could cause radio interference.

# Chapter 2 Package Contents

---

VC-BC701P



Power Cord

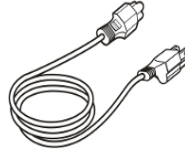

Appearance may vary depending on country/region

Power Adapter

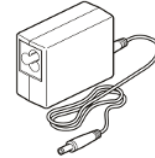

Instruction for installation

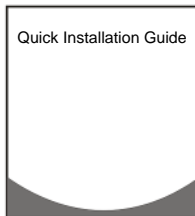

# Chapter 3 Function Introduction

## 3.1 I/O functions Introduction



NO.	Item	Function Descriptions
1.	Lens	30x HD camera lens
2.	Tally indicator light	Display the tally light status of the camera
3.	Network port	Network port. Support routers or hubs (IEEE 802.3 af) with PoE power supply support
4.	HDMI output	The factory output resolution is 4K/30. Please make sure that the connected display device supports 4K resolution
5.	RS232 output	RS232 output port. At most 7 cameras can be connected in a serial connection
6.	RS232 input	RS232 input port. At most 7 cameras can be connected in a serial connection
7.	DC 12 V power connector	AC power supply connecting port
8.	Power indicator light	After power is on, the indicator light will display in red
9.	Audio input	Support Line In / Mic In
10.	Audio output	Support 3.5 mm audio input
11.	Tripod screw holes	The camera is mounted on a (specification) 1/4", 20 UNC tripod deck or installed on VC-WM11 (optional)

## 3.2 Tally Indicator Light Function Description

3.2.1 The tally indicator light function may be enabled through the control of RS232 command. The setting method is as follows:

Tally Mode : 8x 01 7E 01 0A 01 0p FF

p = 0 : OFF

p = 4 : On (half-brightness)

p = 5 : On (full-brightness)



# Chapter 4 Instruction for installation

## 4.1 Basic Devices

### 4.1.1 VC-BC701P size

Length x Width x Height : 168.3 x 67.0 x 67.0 mm

Weight : 0.5 Kg

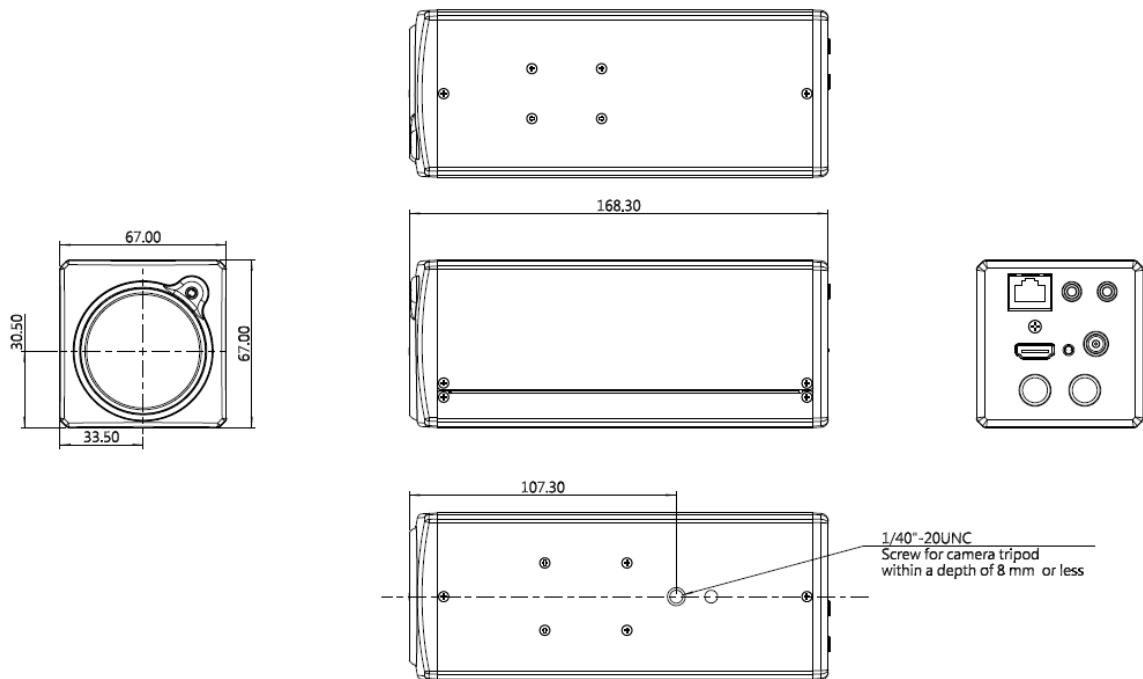

### 4.1.2 Installation method

4.1.2.1 Wall-mounted frame: The camera is installed on the wall, using Lumens VC-WM11 (optional) wall-mounted frame

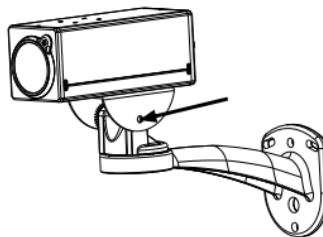

4.1.2.2 Tripod: The camera is mounted on a 1/4", 20 UNC PTZ tripod deck



(Schematic diagram)

## 4.2 Connecting devices

### 4.2.1 HDMI connection to TV/display screen

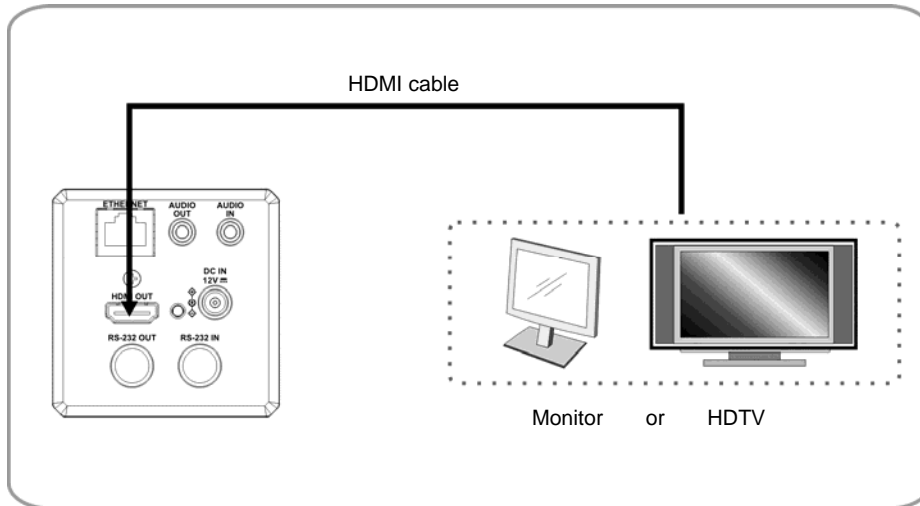

### 4.2.2 Connecting to Internet

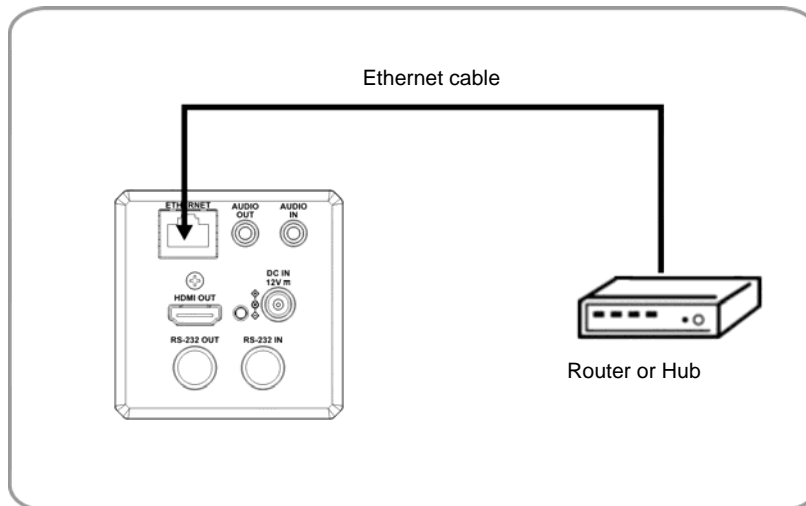

<Remark> For details of web page connection setting and description, please refer to [Chapter 5 Network Function Settings Description](#).

### 4.2.3 Connecting AUDIO IN

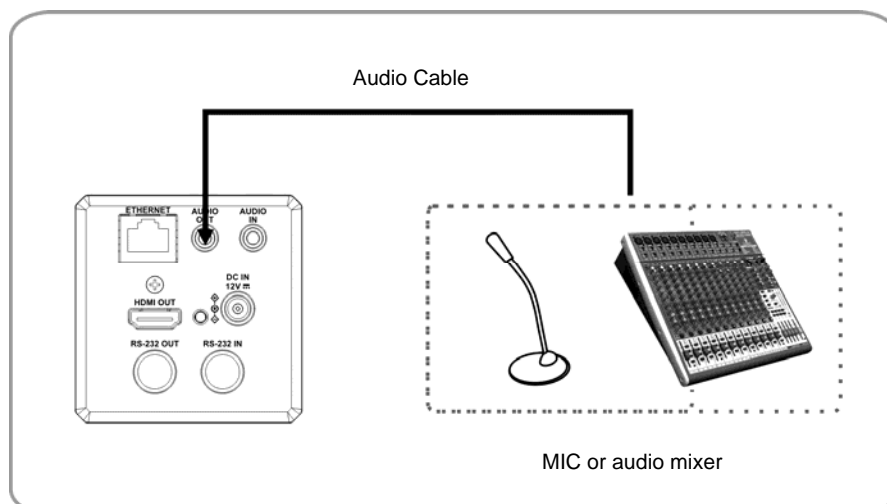

## 4.2.4 Connecting RS-232

### ■ RS-232 serial connection

With RS-232 in/out, at most 7 Lumens cameras can be connected.

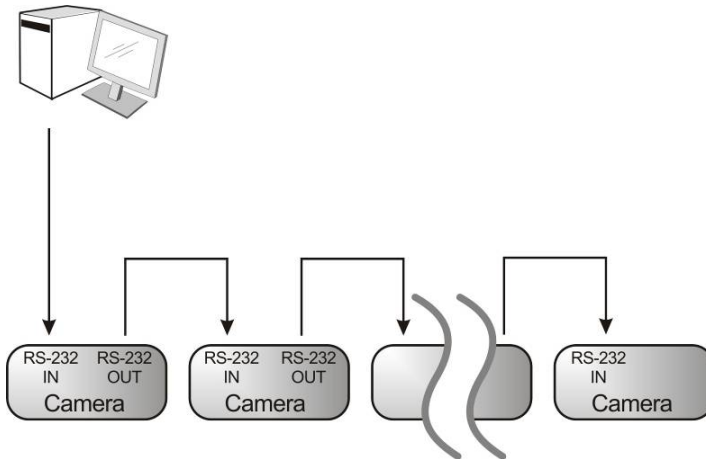

### ■ RS-232 pin definition description

#### ▼ RS-232 IN Pins Instructions

NO	Pins	Signals
1	DTR	Data Transmission Reade
2	DSR	Data Set Reade
3	TXD	Transmit Data
4	GND	Ground
5	RXD	Receive Data
6	GND	Ground
7	IR OUT	IR Commander Signal
8	N.C.	No Connection

#### ▼ RS-232 OUT Pins Instructions

NO	Pins	Signals
1	DTR	Data Transmission Reade
2	DSR	Data Set Reade
3	TXD	Transmit Data
4	GND	Ground
5	RXD	Receive Data
6	GND	Ground
7	OPEN	Reserved
8	OPEN	Reserved

#### ▼ RS-232 Connection Instructions

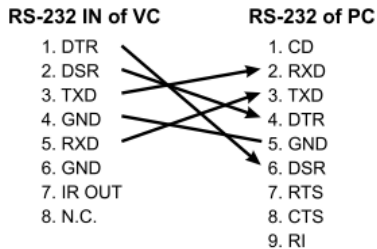

#### ▼ RS-232 Connection Instructions

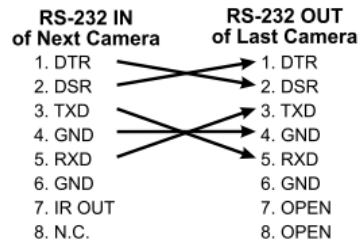

# Chapter 5 Network Function Settings Description

## 5.1 Web System Requirements

### 5.1.1 Web Browser:

- Internet Explorer 11 or above
- FireFox 66.0.3 or above
- Chrome 73 or above
- Edge 42.17134 or above
- Safari 12.1 or above

## 5.2 Connecting Camera to Network

### 5.2.1 Connecting to Internet

Two common connection methods are shown below

1. Connecting via switch or router

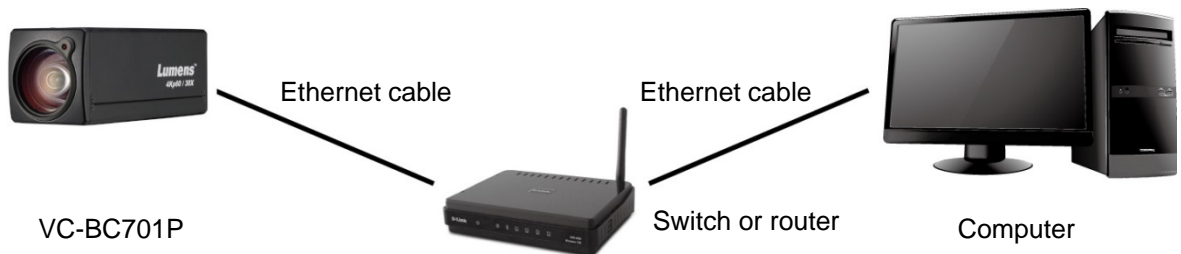

2. If the camera is connected to the computer directly, the computer IP address must be modified to have the same network segment as the camera  
For example, the factory-preset default IP address of VC-BC701P is 192.168.100.100. The computer IP address must be set with the same subnet, such as 192.168.100.101, so that the computer can be connected correctly with the camera

- Connection diagram

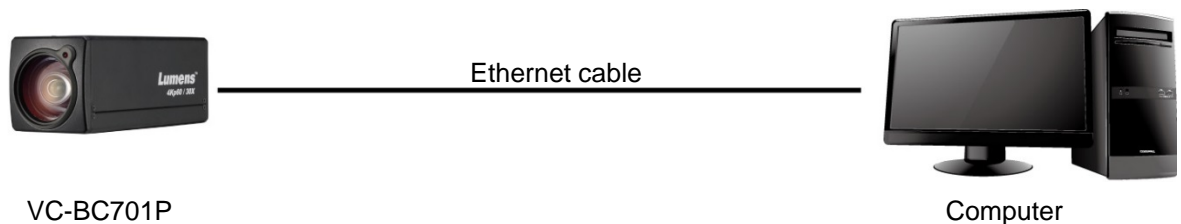

- Change network settings

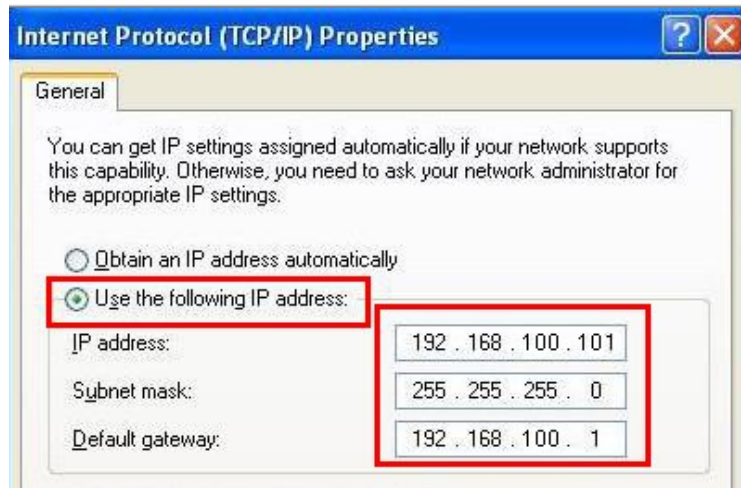

### 5.2.2 Using Lumens VMS Software to View the Images

- The VC-BC701P DHCP initial setting is ON. If VC-BC701P is connected to the local area network (LAN), the camera IP can be retrieved via the following methods
  - Install Lumens VMS software (Please download from the Lumens official website, <http://www.mylumens.com/support>)
    - Open **LUMENS VMS** software
    - Search for the camera: Press  [automatically search for the device] button to locate the VC-BC701P camera
    - Click VC-BC701P in the list and start operation after connecting to network
- <Note> When using automatic search, the camera and computer must be in the same network segment, e.g.: 192.168.4.X**

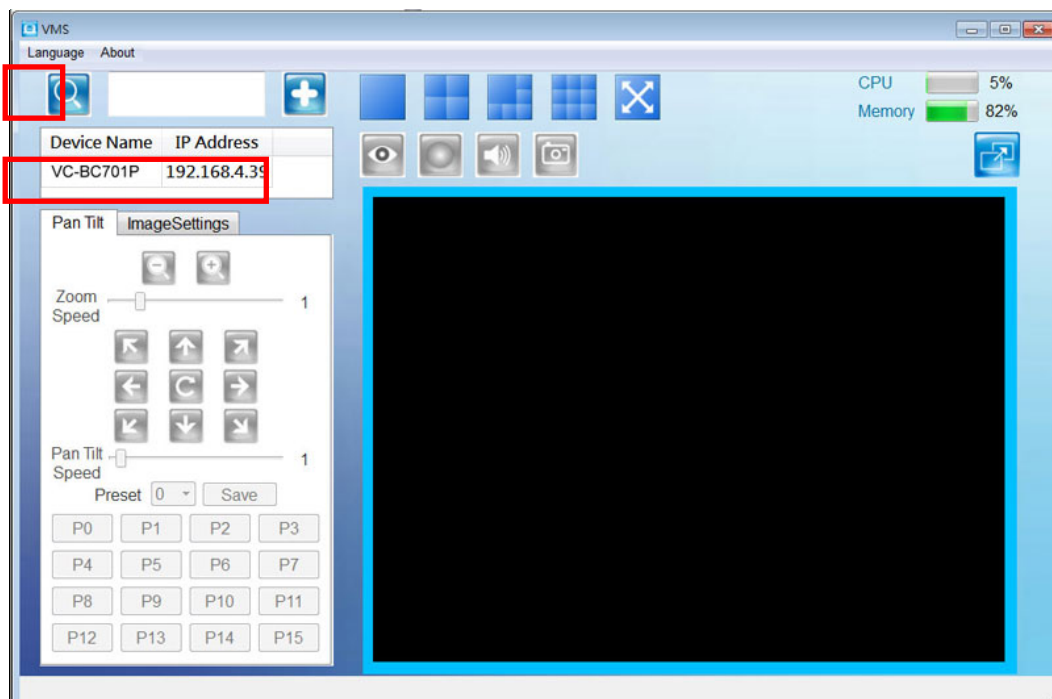

### 5.2.3 Using the Browser to View the Images

- Open the browser, and enter the URL of VC-BC701P in the IP address bar  
e.g.: <http://192.168.100.100> (default IP address)
- Enter administrator's account and password  
Account: admin (Default)  
Password: 9999 (Default)

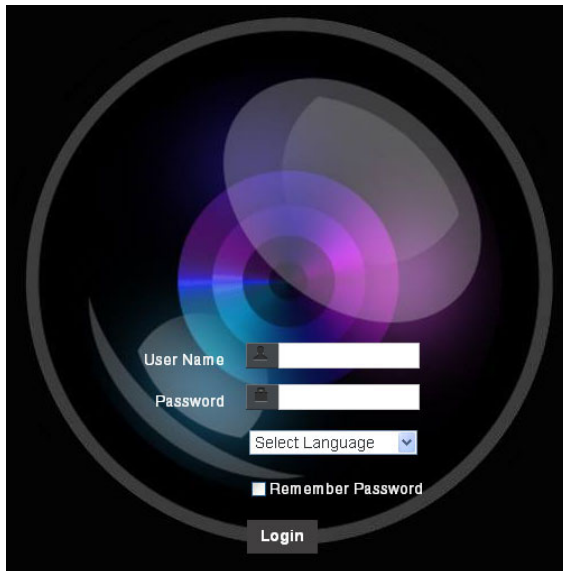

### 5.2.4 Using RTSP Player to View the Images

Besides the browser and VMS, other free software also can be used for RTSP connection, such as VLC、Quick Time、PotPlayer and other free software

RTSP connection address formats are as follows:

- RTSP Main Streaming => <rtsp://camera IP:8554/hevc>
- RTSP Sub1 Streaming => <rtsp://camera IP:8557/h264>
- RTSP Sub2 Streaming => <rtsp://camera IP:8556/h264>

Example: Open VLC software and input the URL: <rtsp://192.168.100.150:8557/h264>

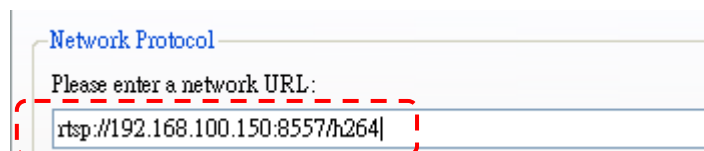

## 5.3 Web Page Function Description

### 5.3.1 Login Screen

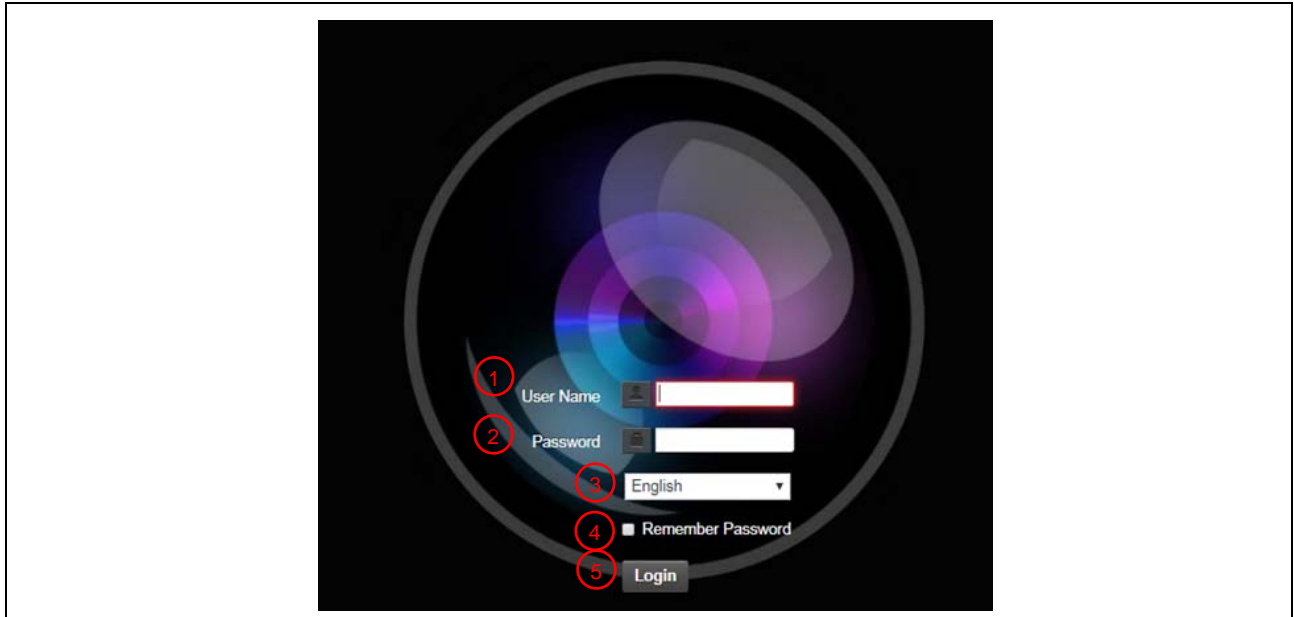

No	Item	Function Descriptions
1	Username	Enter user account name (default: admin)
2	Password	Enter user password (default: 9999)
3	Language selection	Currently, the system supports English, Traditional Chinese and Simplified Chinese
4	Remember password	Save user account name and password to the browser. When you log in next time, there is no need to re-enter them
5	Login	Log into the administrator screen on the website

### 5.3.2 Viewing In Real Time

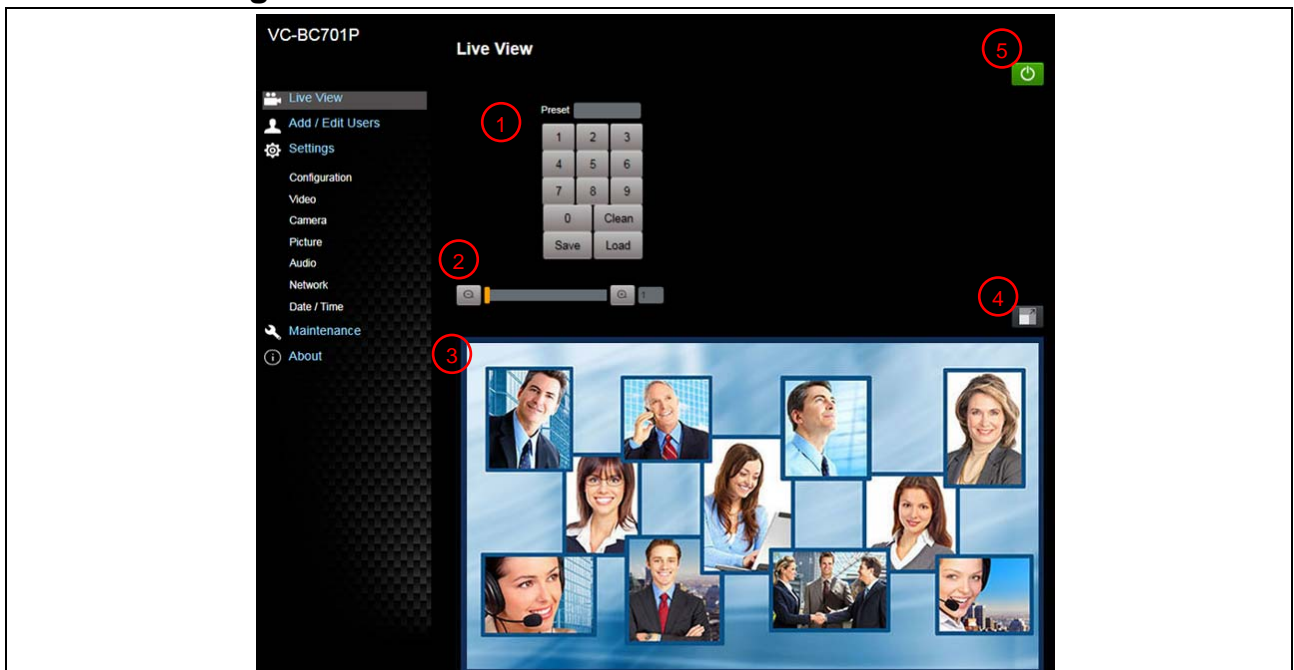

No	Item	Function Descriptions
1	Preset setting	Select the number first and then select SAVE or LOAD

2	Zoom ratio	Adjust the zoom-in or zoom-out ratio via scroll bar
3	Preview window	Display the screen currently captured by the camera
4	Switch to Full Screen	Switch the preview window to full screen
5	Power button	Turn on or turn off the camera power

### 5.3.3 Account Management

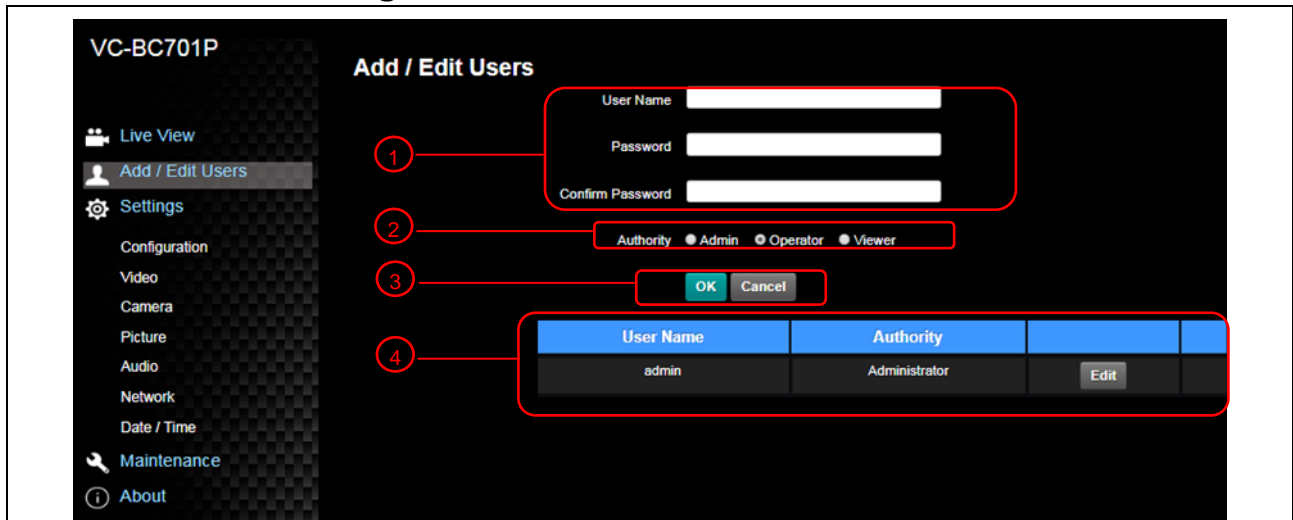

No	Item	Function Descriptions																
1	Add user account	Enter a user name and password to add a new user																
2	Permission setting	Set the new account management permissions <table border="1" data-bbox="603 1104 1337 1321"> <thead> <tr> <th>User Type</th> <th>Admin</th> <th>Operator</th> <th>Viewer</th> </tr> </thead> <tbody> <tr> <td>View images</td> <td>Y</td> <td>Y</td> <td>Y</td> </tr> <tr> <td>Settings</td> <td>Y</td> <td>Y</td> <td>N</td> </tr> <tr> <td>Account management</td> <td>Y</td> <td>N</td> <td>N</td> </tr> </tbody> </table>	User Type	Admin	Operator	Viewer	View images	Y	Y	Y	Settings	Y	Y	N	Account management	Y	N	N
User Type	Admin	Operator	Viewer															
View images	Y	Y	Y															
Settings	Y	Y	N															
Account management	Y	N	N															
3	Applying setting	Add the newly created user to the account list																
4	List of accounts	Edit: Modify the user password and permissions Delete: Delete the user account																



### 5.3.4 Setting-System Setting



No	Item	Function Descriptions																	
1	Resolution	Set the resolution of the camera. Resolutions supported by the camera are as follows: 3840x2160P 59.94/50/29.97 fps 1080P 59.94/50/29.97/25 fps 720P 59.94/50/29.97/25 fps After switching to the resolution, the camera will restart. Please refresh the browser																	
2	Output signal	<p>According to the output resolution, selections are available for HDMI output, streaming output, or HDMI + streaming output. For output signals supported by different resolution, please refer to the following table:</p> <table border="1"> <thead> <tr> <th>Resolution</th> <th>Available output modes</th> </tr> </thead> <tbody> <tr> <td>3840x2160/59.94p</td> <td>HDMI or streaming single output</td> </tr> <tr> <td>3840x2160/50p</td> <td>HDMI or streaming single output</td> </tr> <tr> <td>3840x2160/29.97p</td> <td rowspan="10">Simultaneous HDMI and streaming outputs</td> </tr> <tr> <td>3840x2160/25p</td> </tr> <tr> <td>1080p/59.94</td> </tr> <tr> <td>1080p/50</td> </tr> <tr> <td>1080p/29.97</td> </tr> <tr> <td>1080p/25</td> </tr> <tr> <td>720p/59.94</td> </tr> <tr> <td>720p/50</td> </tr> <tr> <td>720p/29.97</td> </tr> <tr> <td>720p/25</td> </tr> </tbody> </table>	Resolution	Available output modes	3840x2160/59.94p	HDMI or streaming single output	3840x2160/50p	HDMI or streaming single output	3840x2160/29.97p	Simultaneous HDMI and streaming outputs	3840x2160/25p	1080p/59.94	1080p/50	1080p/29.97	1080p/25	720p/59.94	720p/50	720p/29.97	720p/25
Resolution	Available output modes																		
3840x2160/59.94p	HDMI or streaming single output																		
3840x2160/50p	HDMI or streaming single output																		
3840x2160/29.97p	Simultaneous HDMI and streaming outputs																		
3840x2160/25p																			
1080p/59.94																			
1080p/50																			
1080p/29.97																			
1080p/25																			
720p/59.94																			
720p/50																			
720p/29.97																			
720p/25																			
3	HDMI YUV	Select YUV422 or YUV420 (This function is only available for these two resolutions, 3840x2160/59.94p and 3840x2160/50p and remains in display mode for all other resolutions)																	
4	Apply	After the setting has been modified, select this button to apply the setting																	

### 5.3.5 Setting-Video

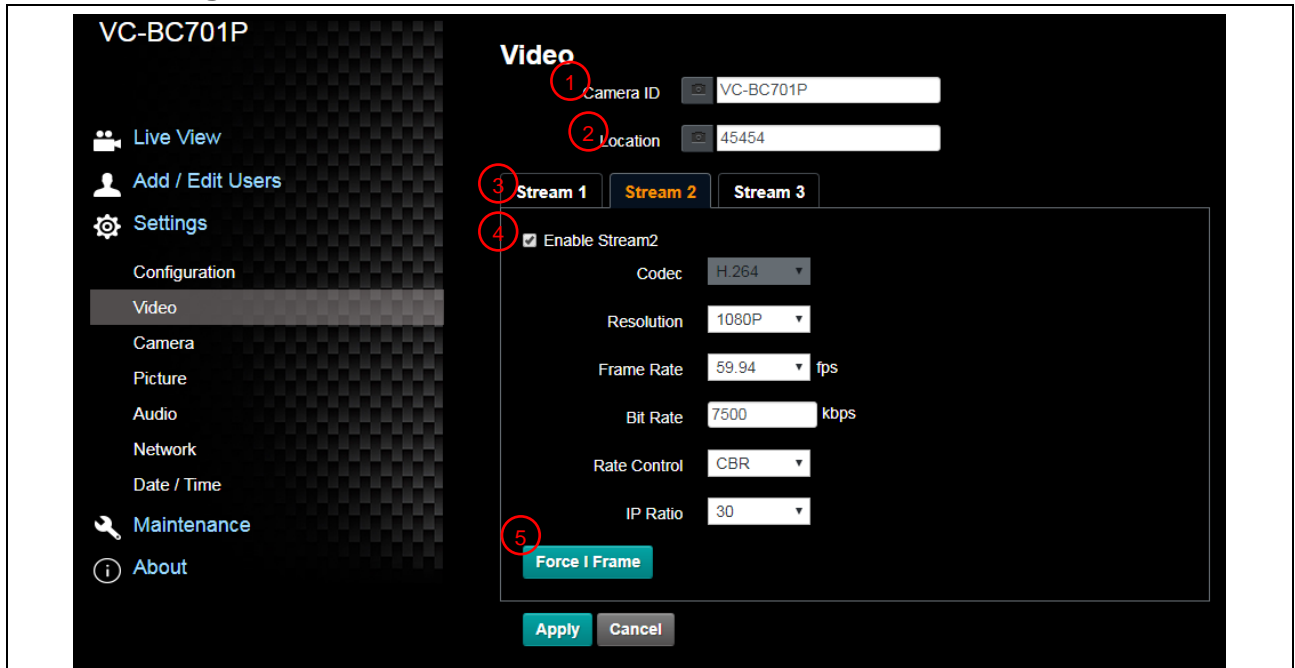

No	Item	Function Descriptions
1	Camera name	<p>Modify the camera name</p> <ul style="list-style-type: none"> <li>Camera names are limited to 1-12 characters</li> <li>Please use a camera name by mixing uppercase and lowercase letters and numbers. Do not use “/” and “space” or special symbols</li> </ul>
2	Camera location	<p>Modify the location of the camera, such as Meeting Room 1</p> <ul style="list-style-type: none"> <li>Camera locations are limited to 1-12 characters</li> <li>Please use a camera name by mixing uppercase and lowercase letters and numbers. Do not use “/” and “space” or special symbols</li> </ul>
3	Streaming 1 / Streaming 2 / Streaming 3	VC-BC701P supports 3 streaming outputs. Please refer to <a href="#">5.3.5.1 Streaming Parameter Setting</a> for relevant settings
4	Open streaming	Confirm the streaming function
5	Force I Frame	Check this item to insert IDR frame into specified series flow and apply its setting. User’s setting will be reserved and displayed in GUI interface

#### 5.3.5.1 Streaming parameter setting

Function		Streaming 1	Streaming 2	Streaming 3
Encode Format		H.265	H.264	
Resolution		4K /1080P / 720P	1080P / 720P	640x360
Frame rate		Setting according to the supported resolution		
Bit Rate(kbps)	Range	2,000~20,000	2,000~20,000	512~5,000
	Factory default	15,000	7,500	1,000
Rate control		CBR / VBR		
IP ratio		Setting according to the supported resolution		

### 5.3.6 Setting-Camera

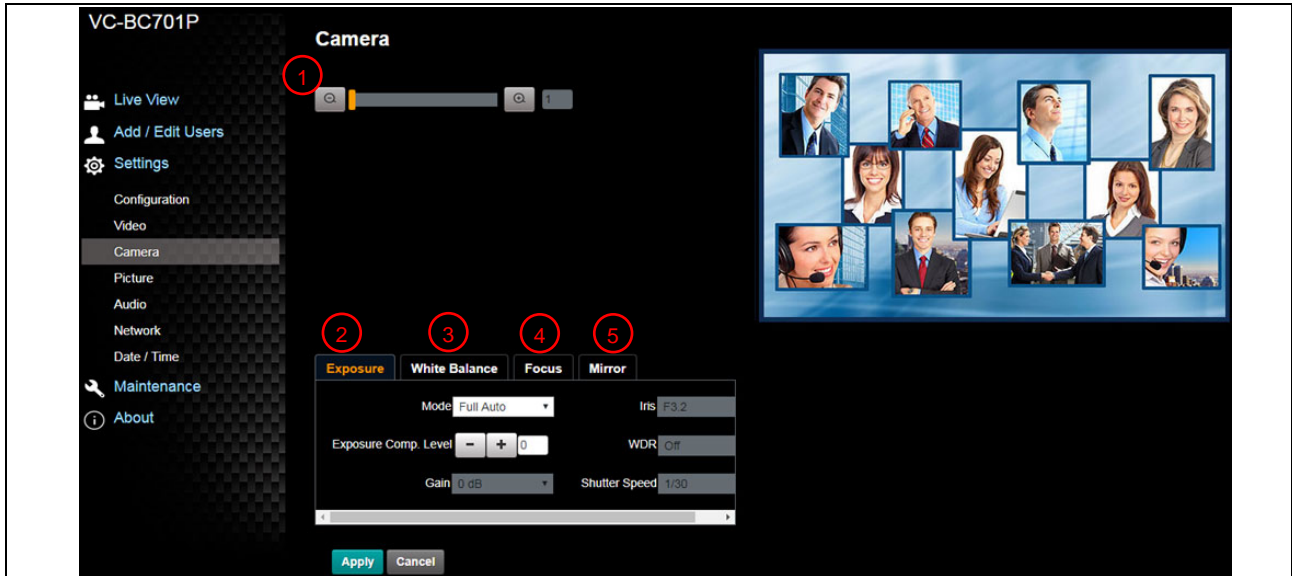

No	Item	Function Descriptions
1	Zoom ratio	Adjust the zoom-in or zoom-out ratio via scroll bar
2	Exposure	<ul style="list-style-type: none"> <li>■ <b>Mode:</b> Select exposure mode (Automatic/Shutter Priority/Aperture Priority/Manual )</li> <li>■ <b>Exposure Comp. Level:</b> Select exposure compensation level</li> <li>■ <b>Gain:</b> The gain limit is adjustable when the exposure mode is set to "Manual"</li> <li>■ <b>Iris:</b> The size of aperture is adjustable when the exposure mode is set to "Manual" or "Aperture Priority"</li> <li>■ <b>WDR:</b> Set the level of wide dynamic range (WDR) in order to obtain better images</li> <li>■ <b>Shutter Speed:</b> The shutter speed is adjustable when the exposure mode is set to "Manual" or "Shutter Priority"</li> </ul>
3	White balance	<ul style="list-style-type: none"> <li>■ <b>Mode:</b> Select the color temperature mode                             <ul style="list-style-type: none"> <li>➢ Auto</li> <li>➢ Indoor</li> <li>➢ Outdoor</li> <li>➢ One Push WB</li> <li>➢ ATW</li> <li>➢ Manual</li> <li>➢ Sodium Lamp</li> </ul> </li> <li>■ <b>Open Push Trigger:</b> One push color temperature is adjustable when the white balance mode is set to "One Push Trigger"</li> <li>■ <b>Manual Red/Blue:</b> Manually adjust blue/red color temperature</li> </ul>
4	Focus	<ul style="list-style-type: none"> <li>■ <b>Mode:</b> Select manual/automatic focus</li> <li>■ <b>Focus Range:</b> The focusing range is adjustable when the focus mode is set to "Manual"</li> <li>■ <b>AF Sensitivity:</b> Set automatic focus sensitivity</li> <li>■ <b>AF Frame:</b> Set automatic focus range</li> </ul>
5	MIRROR	<ul style="list-style-type: none"> <li>■ <b>Mirror:</b> Set automatic flip mode</li> </ul>

### 5.3.7 Setting-Picture

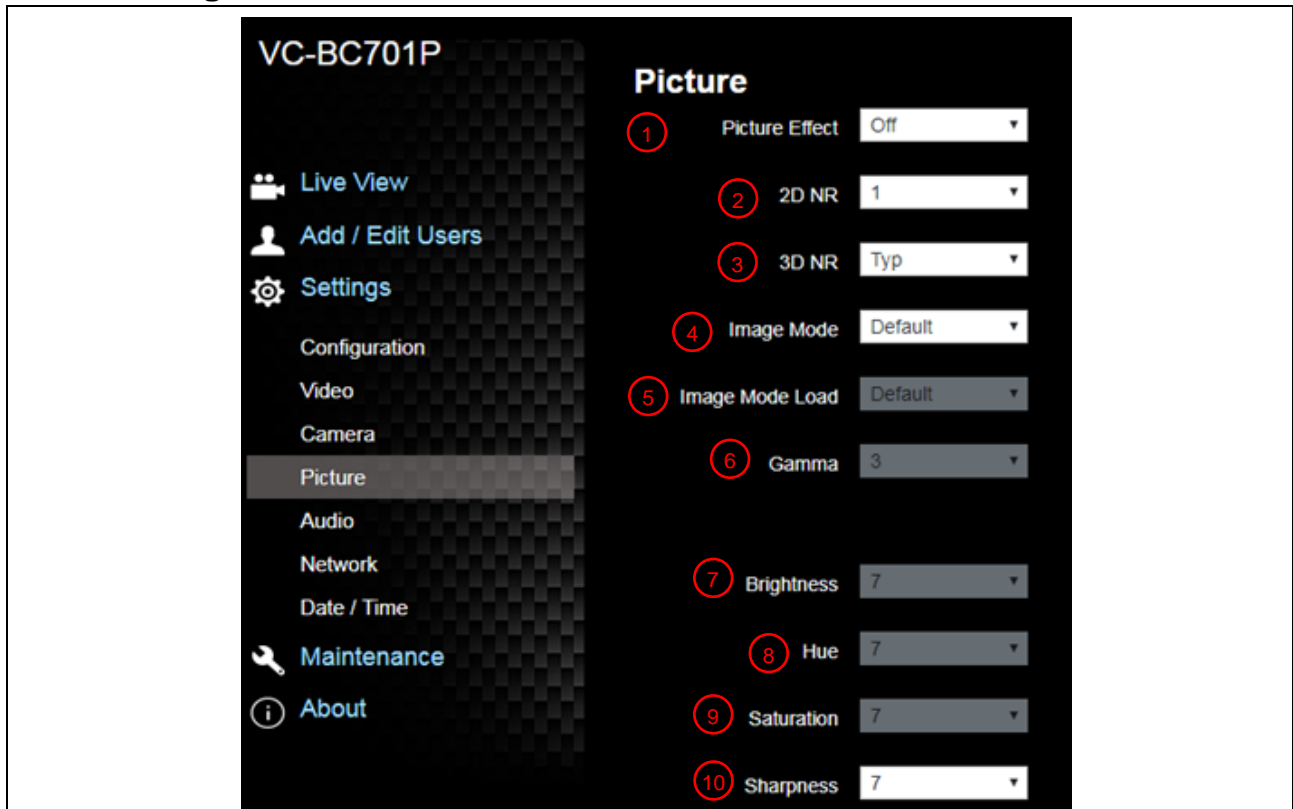

No	Item	Function Descriptions
1	Picture effect	Set picture effect, Off / Film / Black and White
2	2D noise reduction settings	2D noise reduction settings
3	3D noise reduction settings	3D noise reduction settings
4	Image mode	The user may customize his/her desired image mode
5	Image mode load	When no custom setting is needed, reset the picture parameters back to the factory default by selecting this item
6	Gamma	Gamma Level adjustment; Adjustable when the image mode is set to Custom
7	Brightness	Brightness adjustment; Adjustable when the image mode is set to Custom
8	Contrast	Contrast adjustment; Adjustable when the image mode is set to Custom
9	Saturation	Saturation adjustment; Adjustable when the image mode is set to Custom
10	Sharpness	Adjust the sharpness of the image

### 5.3.8 Setting-Audio

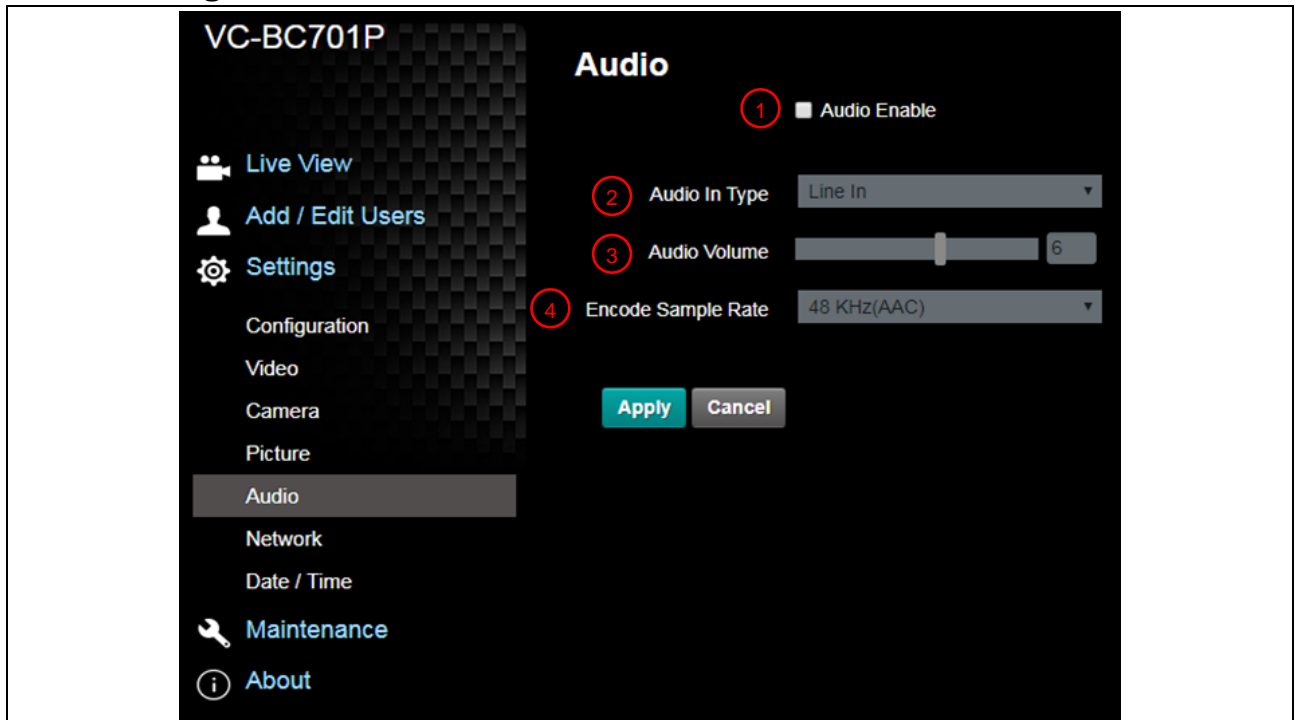

No	Item	Function Descriptions
1	Open audio	Turn on / off sound
2	Soundtrack effect setting	Set MIC In / Line In
3	Audio Volume	Adjust Volume
4	Encode sample rate	Set Encode sample rate ➤ 48 KHz(AAC) ➤ 44.1 KHz(AAC) ➤ 16 KHz(G.711) ➤ 8 KHz(G.711)

### 5.3.9 Setting-Time

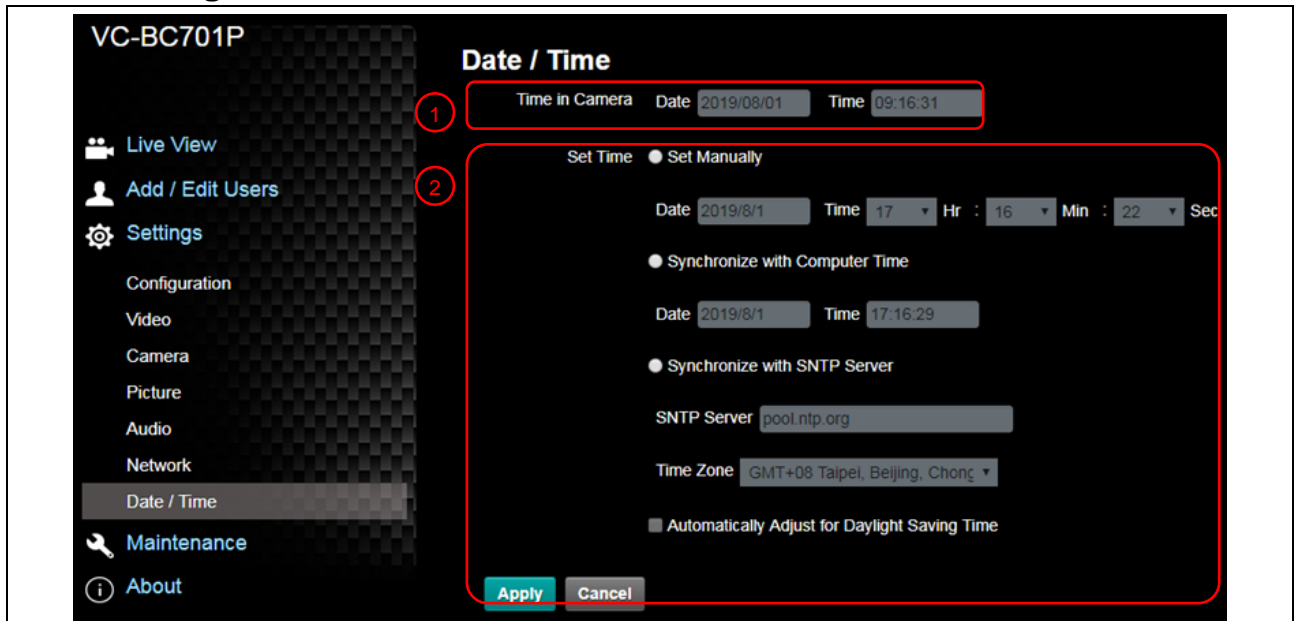

No	Item	Function Descriptions
1	Camera Time	Display the date and time of the camera
2	Set the Time	<ul style="list-style-type: none"> <li>■ Set Manually: Set time manually</li> <li>■ Synchronize with computer time: Set the camera time according to the computer time</li> <li>■ Synchronize with SNTP server: Set the camera time synchronously with the SNTP server</li> </ul> <p><b>&lt;Remark&gt;</b> SNTP server address: Please change in network setting</p>

## 5.3.10 Setting-Network

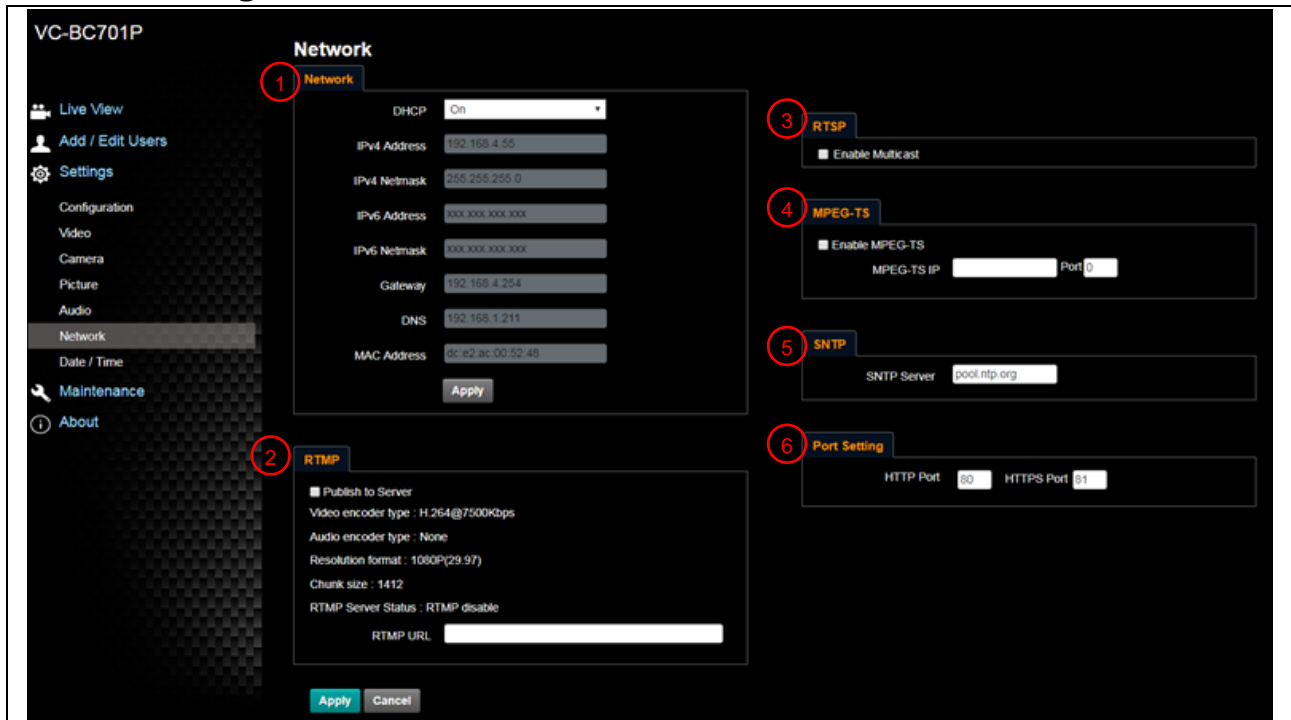

No	Item	Function Descriptions
1	Network	Network setting of camera. Change of setting is available only when DHCP function is closed.
2	RTMP Setting	Copy the RTMP web address provided by the RTMP service platform and paste it to the RTMP connection address to publish the camera images on the RTMP service platform To upload to YouTube for live streaming, the audio function must be turned on first
3	RTSP Setting	Enable/Disable Multicast. It is suggested to enable Multicast when the number of users online watching the live image simultaneously is more than 4
4	MPEG-TS Setting	Set MPEG-TS format <b>&lt;Remark&gt;</b> The following port has been used by the camera. Setting of the port may not connect correctly 8554, 8556, 8557, 8080, 80, 81, 9090, 23
5	SNTP Setting	Set SNTP Server IP
6	Port Setting	Set HTTP port. The default Port value is 80 <b>&lt;Remark&gt;</b> Change of setting is available only when DHCP function of camera is closed

### 5.3.11 Setting-Maintenance-Upgrading Firmware

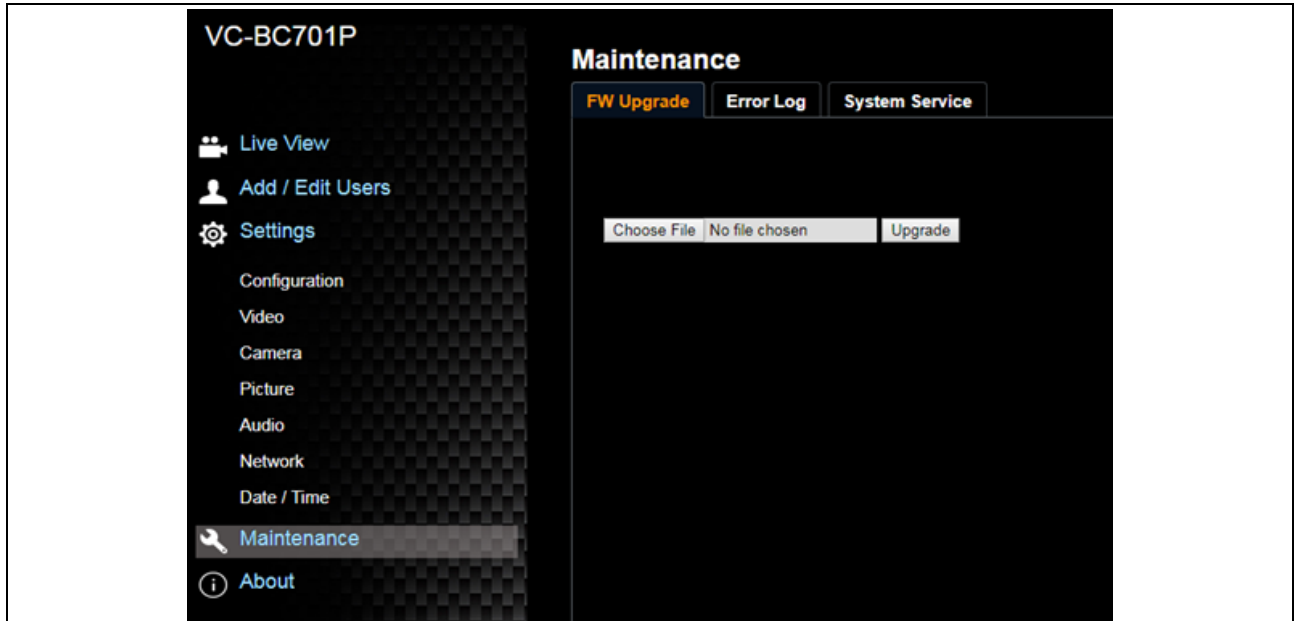

No	Item	Function Descriptions
1	Firmware Update	The camera firmware may be upgraded via web page. For the upgrade method, please download the FW upgrade manual from Lumens website

### 5.3.12 Setting-Maintenance-Incident Log

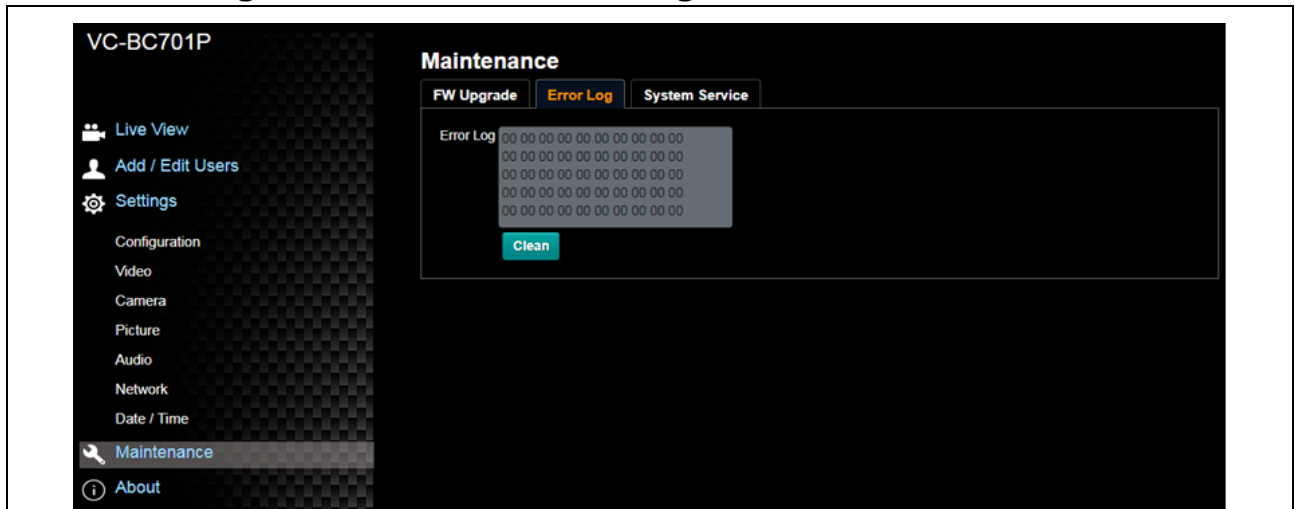

No	Item	Function Descriptions
1	Event Logs	If the camera encounters errors, an error code log will be established



### 5.3.13 Setting-Maintenance-System Service

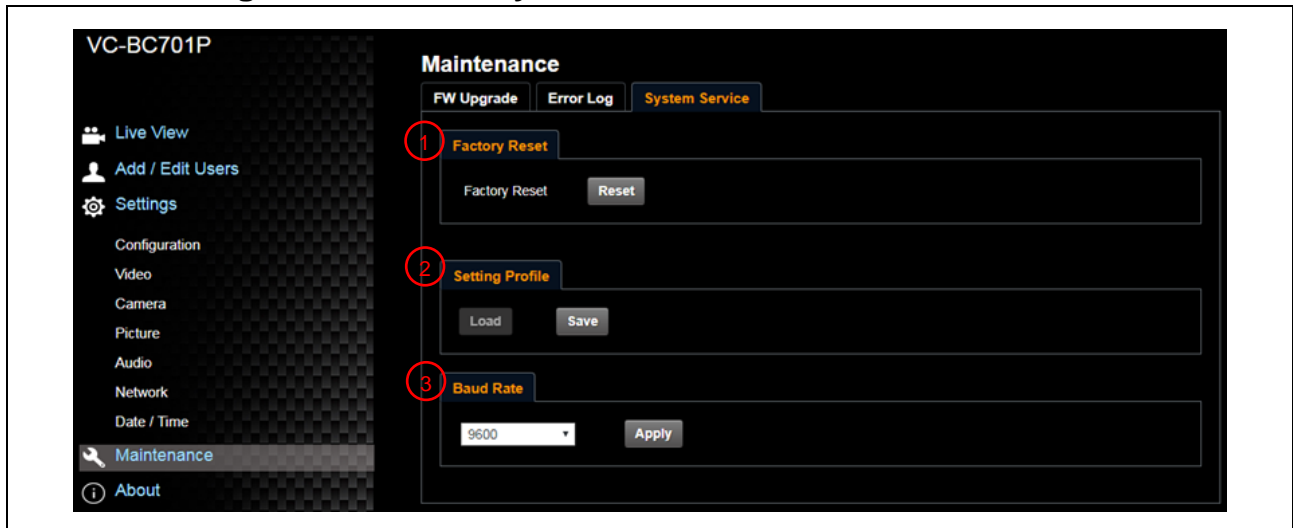

No	Item	Function Descriptions
1	Reset to the default value	Select the reset button to resume the factory default setting as the web page setting
2	Setting File	The web page setting parameters can be exported from the computer and imported/applied to another camera
3	Baud Rate	Set the camera Baud Rate for the use of connecting RS-232 communication

### 5.3.14 About

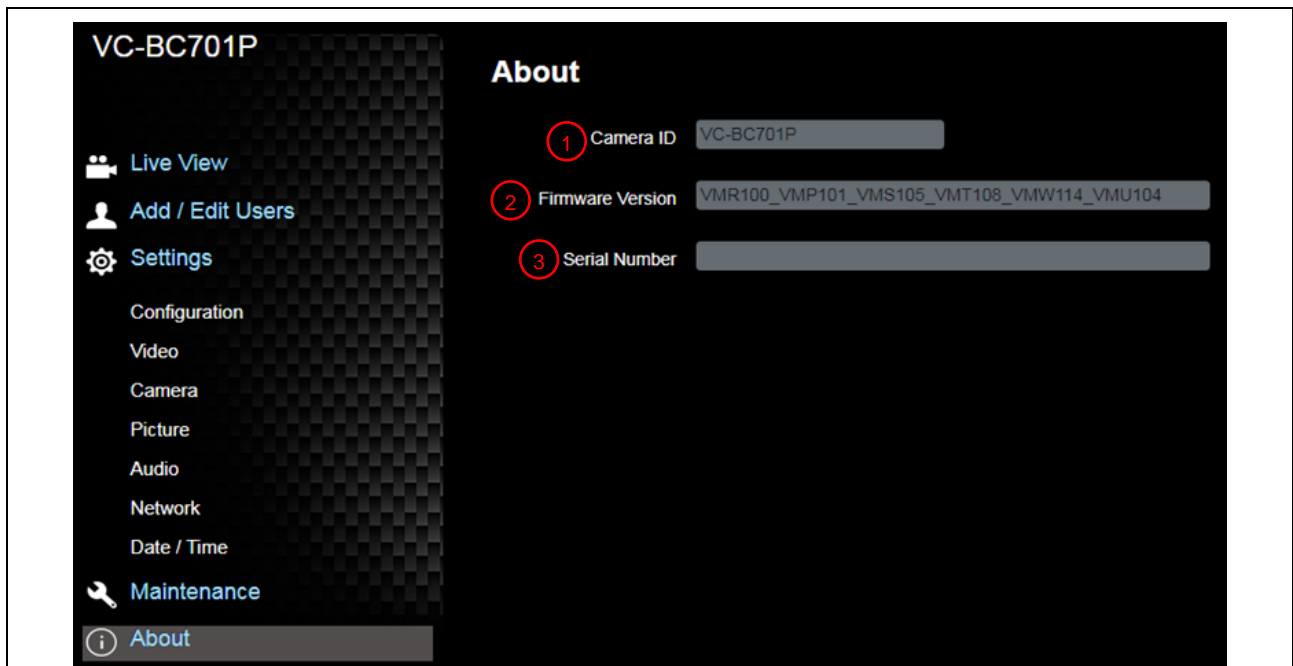

No	Item	Function Descriptions
1	Camera ID	Display the camera name
2	Firmware Version	Display the firmware version of the camera
3	Serial Number	Display the camera serial No.

## Chapter 6 Troubleshooting

---

This chapter describes problems you may encounter while using VC-BC701P. If you have questions, please refer to related chapters and follow all the suggested solutions. If the problem still occurred, please contact your distributor or the service center.

No.	Problems	Solutions
1.	<b>Boot without power signal</b>	<ol style="list-style-type: none"><li>1. Make sure you have plugged in the power cord.</li><li>2. When using a PoE connection, ensure that the power supply supports IEEE 802.3af hubs</li></ol>
2.	<b>There is no image output from VC-BC701P</b>	<ol style="list-style-type: none"><li>1. Check the power supply or PoE supply functions.</li><li>2. Confirm the output signals are in streaming output.</li><li>3. If the camera is connected to a monitor, confirm the monitor equipment supports 4K output</li><li>4. Replace the cables and make sure they are not faulty.</li></ol>
3.	<b>VC-BC701P image is severely delayed</b>	Please use 4K, 1080p or 720p 60/50 Hz signals rather than 25/30 Hz signals.
4.	<b>RS-232 cannot be controlled</b>	<ol style="list-style-type: none"><li>1. Confirm the connection is correct (RS-232 Input / Output)</li><li>2. Please make sure the Baud rate setting is the same as the control equipment</li></ol>
5.	<b>Whether the Internet can be used for operation</b>	Please refer to <a href="#">Chapter 5 Network Function Description</a> for the Internet usage