

VC-A71P-HN

PTZ Video Camera (4K PTZ Video Camera)

User Manual - English

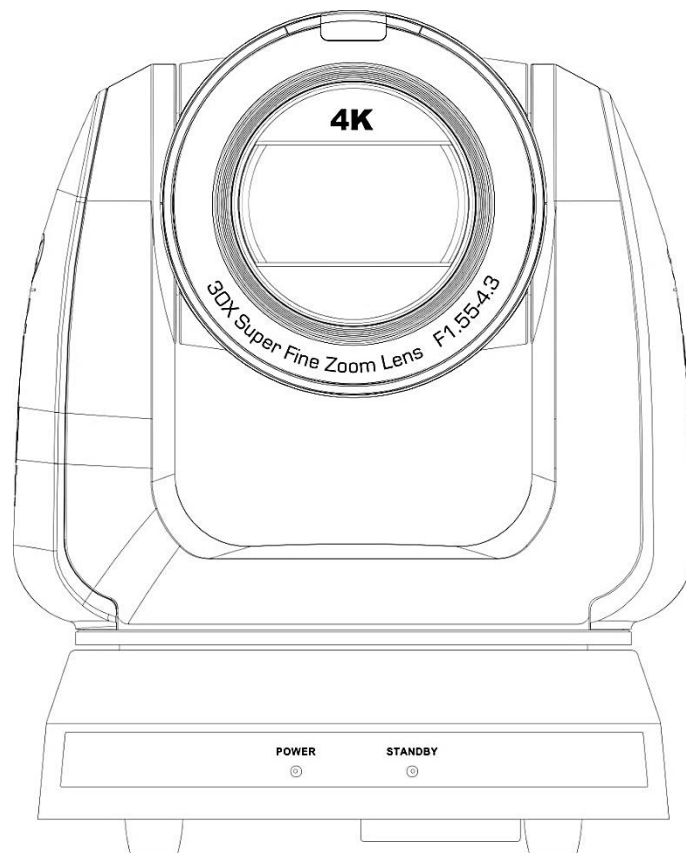

Version VCBK100

To download the latest versions of the Quick Start Guide, multilingual user manual, software, driver, etc., please visit Lumens

<https://www.MyLumens.com/support>

Table of Contents

Chapter 1	Package Contents	3
Chapter 2	Function Introduction	4
2.1	I/O functions Introduction	4
2.2	Description of LED indicator	6
2.3	Tally Lamp Function Description	6
Chapter 3	Instruction for installation	7
3.1	Camera Size	7
3.2	Preparation before installation	8
3.3	Instruction for installation	8
3.4	Connecting devices	13
Chapter 4	Remote Control and Setting Menu	16
4.1	Functions of remote control	16
4.2	Setting Menu	17
Chapter 5	Network Function Settings Description	21
5.1	Connecting Camera to Network	21
5.2	Web Page Function Description	24
Chapter 6	DIP Switch Setting	41
6.1	DIP SWITCH	41
Chapter 7	Troubleshooting	42
Chapter 8	Safety Instructions	43
	Copyright Information	45

Chapter 1 Package Contents

Camera

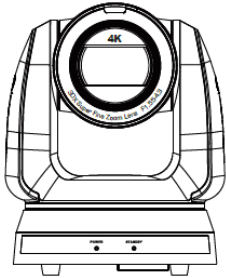

Instruction for Installation



Remote Control



AC Power Cord

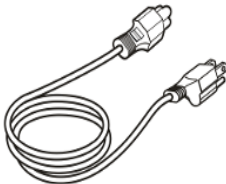

Appearance may vary depending on county/ region

Power Adapter

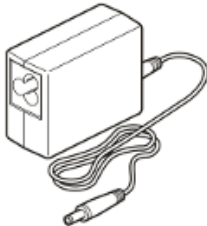

RS-422 Connector

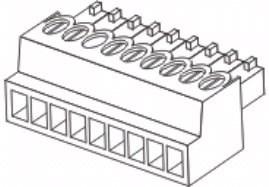

Metal Plate A

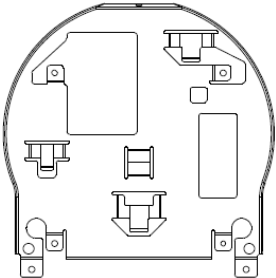

Metal Plate B

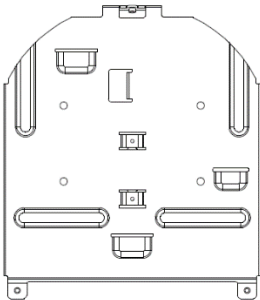

M3 Screws

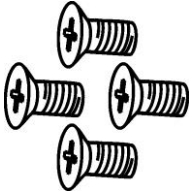

Silver x8/ Black x2

Chapter 2 Function Introduction

2.1 I/O functions Introduction

2.1.1 Front View

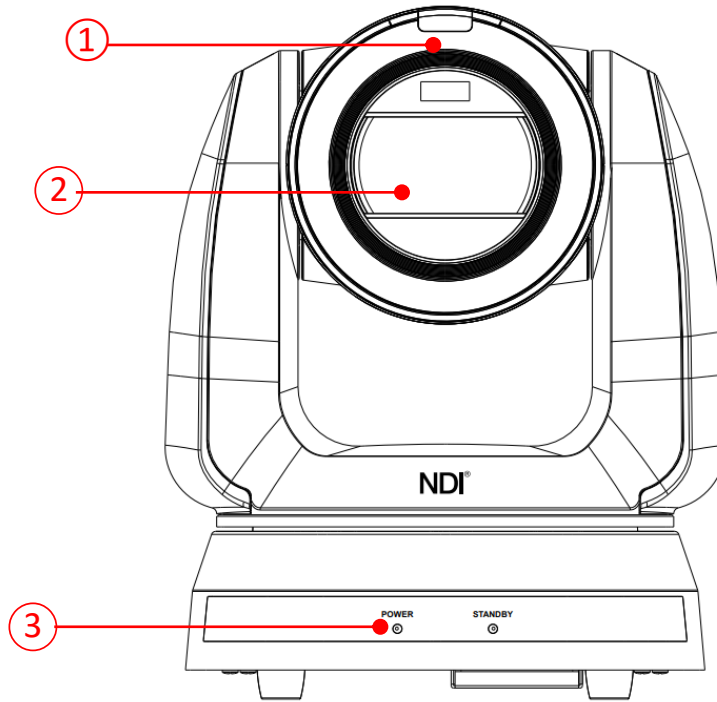

NO.	Item	Function Descriptions
1.	Tally Lamp	Displaying the Tally Lamp status of the camera
2.	Camera lens	30x HD camera lens
3.	Power/Standby LED indicator	Displaying the status of the camera, please refer to 2.2 Description of LED indicator

2.1.2 Back View

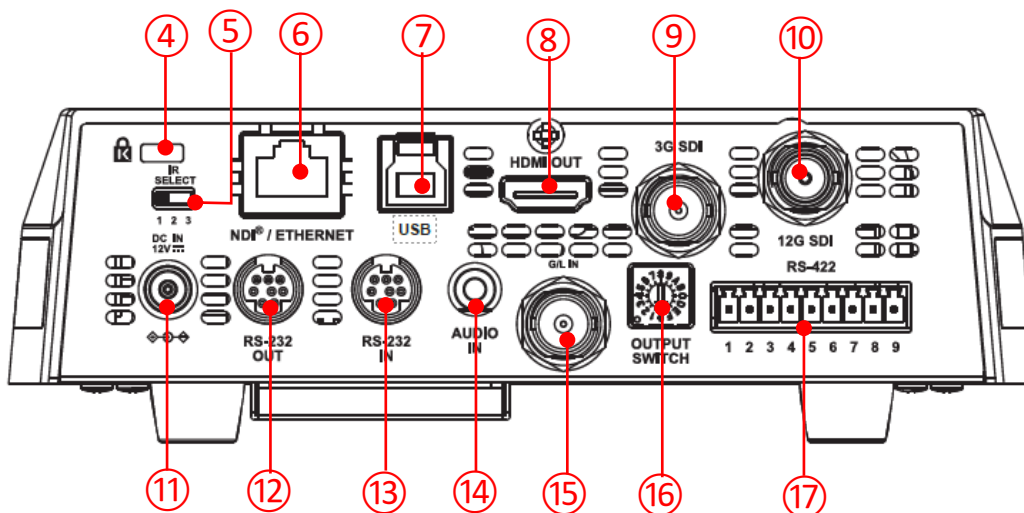

NO.	Item	Function Descriptions
4	Kensington lock hole	Safety lock slot
5	IR SELECT	The remote control ID setting is only controlled after corresponding to the Camera Select on the remote control
6	Network port	Network port supports routers or hubs of PoE++ (IEEE802.3bt) with power supply
7	USB 3.0 port	The USB port is for connecting to the USB port of the computer and providing USB signal images <Remark> Support up to 3840 x 2160/29.97p
8	HDMI 2.0 output	HDMI 2.0 output (Audio output supported)
9	3G-SDI output	3G-SDI output(Audio output supported)
10	12G-SDI output	12G-SDI output (Audio output supported)
11	DC 12V power connector	AC power supply connecting port
12	RS-232 output	RS-232 output port, at most 7 cameras can be connected in a serial connection
13	RS-232 input	RS-232 input port, at most 7 cameras can be connected in a serial connection
14	Audio input	Support Line In/Mic In
15	G/ L IN	SDI Synchronous Source Input
16	OUTPUT SWITCH	Adjust the resolution setting. The default is 3840 x 2160/59.94p
17	RS-422 port	RS-422 connecting port, at most 7 cameras can be connected in a serial connection

2.1.3 Bottom

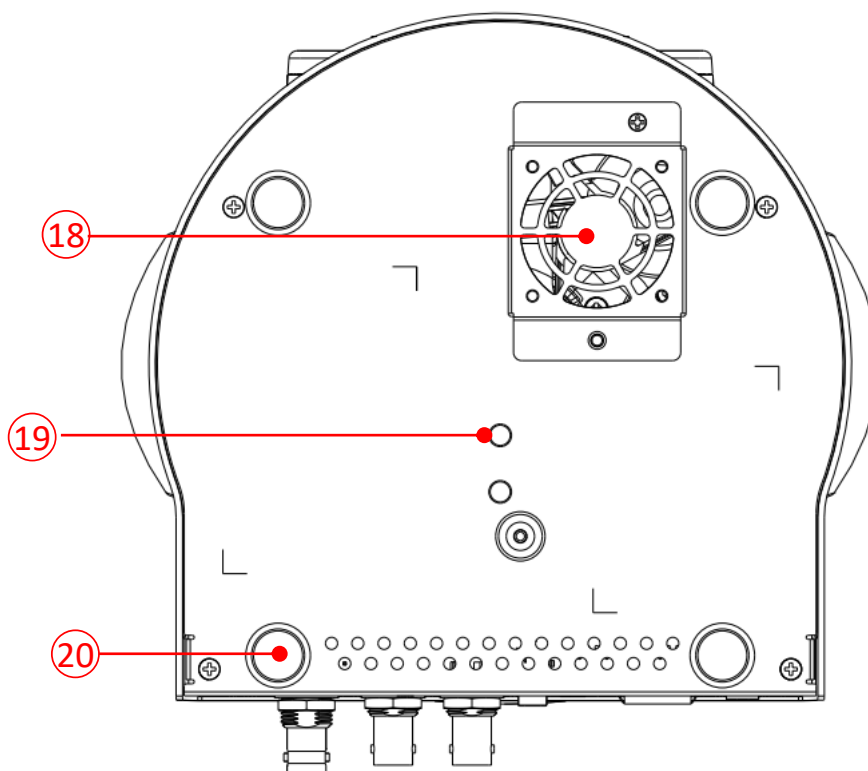

NO.	Item	Function Descriptions
18	Mute cooling fan	The cooling fan automatically controls its rotation speed and performs cooling in cope with the operation temperature of the machine
19	Tripod lock hole	The camera is mounted on a (specification) 1/4"-20 UNC tripod
20	Rotatable foot pad	When using the metal plates of accessories, remove 4 pieces of rotatable food pads on the bottom by rotating counterclockwise, and then install the mental plates

2.2 Description of LED indicator

Status	Power	Standby
Startup in progress (initialization)	Green light	Orange light
In use	Green light	No indicator
In standby mode	No indicator	Orange light

2.3 Tally Lamp Function Description

The Tally lamp function may be enabled through the RS232 command. Please refer to [RS-232 command set](#) document

Chapter 3 Instruction for installation

3.1 Camera Size

3.1.1 Camera Front View and Side View

- Length x Width x Height: 232 x 188 x 189 mm
- Weight: 3.0 Kg (without mental plates)

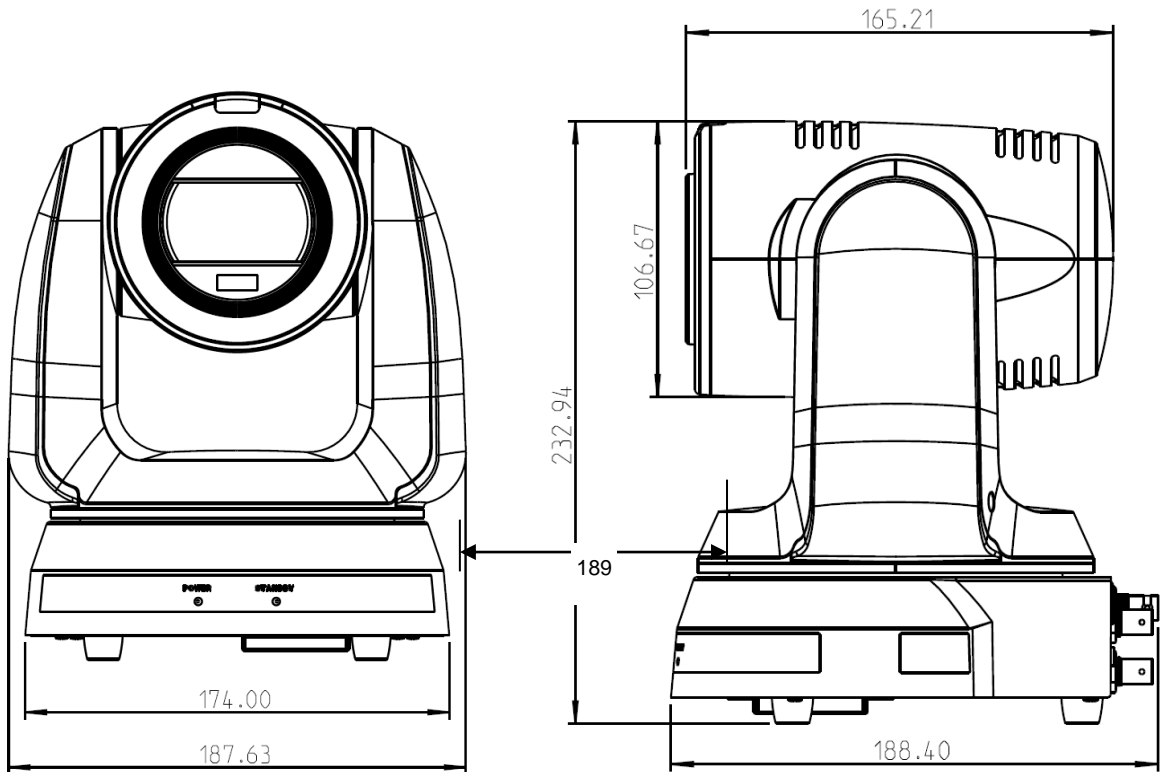

3.1.1.1 Camera Bottom View

The camera can be mounted on a 1/4"-20 UNC PTZ tripod deck by using the lock holes on the bottom for the tripod

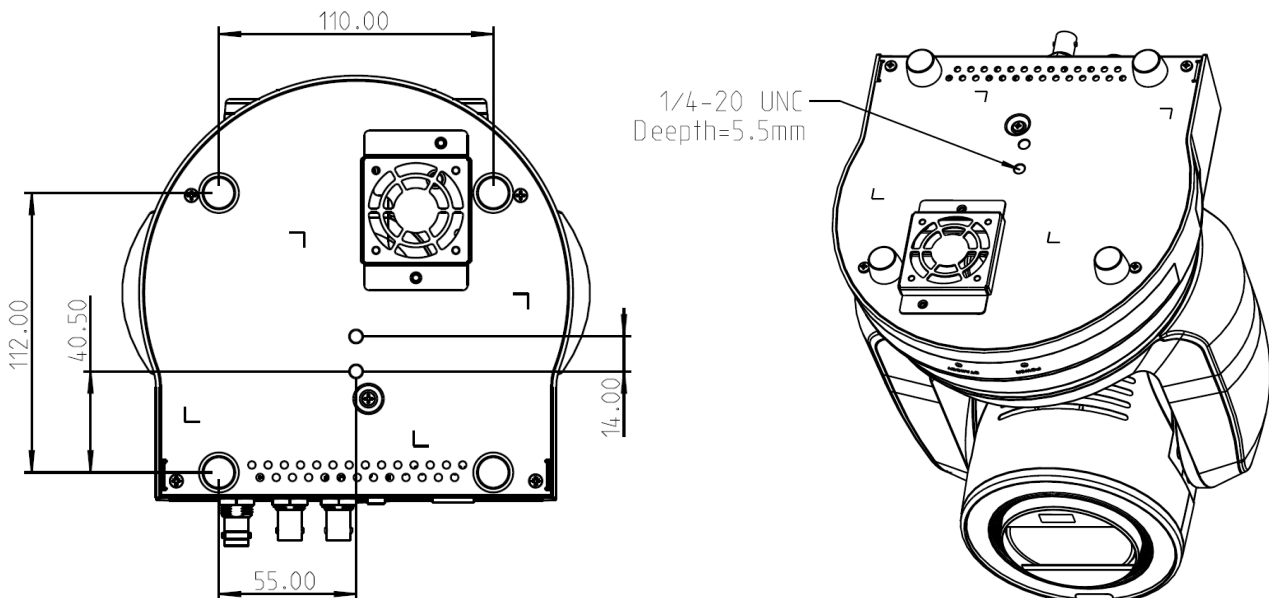

3.2 Preparation before installation

Installation and connection of HD camera requires special skills. To install by yourself, please follow necessary steps, ensure steady and tight installation of the device, and pay attention to your safety to avoid any accident.

3.2.1 Ensure the safety of the installation environment. Please do not install the device on unstable ceiling or in a place where the device is in danger of falling to avoid any accident.

3.2.2 Please check whether accessories in the box are complete or not. Please contact the supplier for any shortage, and make sure to keep the accessories in the box intact.

3.2.3 Please choose a proper place for installation of camera in advance. Please determine an installation place according to the following requirements

3.2.3.1 Confirm the position for the object to be captured.

3.2.3.2 Confirm whether the camera is set at a proper distance from other light sources.

3.3 Instruction for installation

3.3.1 Install the camera on the desk

3.3.1.1 Precautions for installation

- ◆ Please install the machine on a flat desk
- ◆ Do not grab the camera head by hand when handling the device
- ◆ Do not rotate the camera head by hand. Improper rotation may result in breakdown of the camera

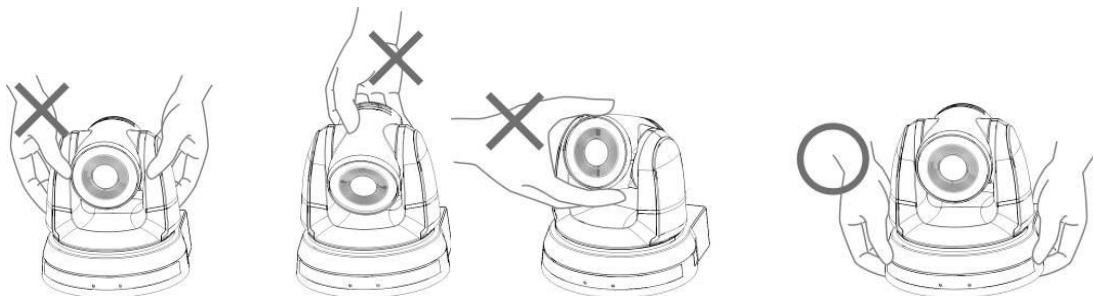

3.3.1.2 Installation steps

Please place the camera on a flat desk to ensure the normal vertical and horizontal operation of the machine and the good cooling of the fan at the bottom

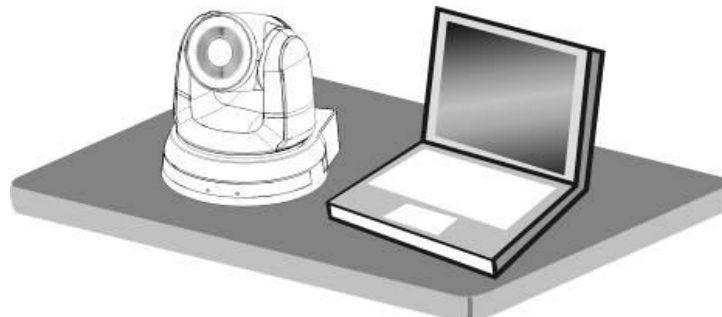

3.3.2 I would like to install the camera on the ceiling

3.3.2.1 Prepare for the parts and equipment required during the installation

- Accessories in the box (metal plates A, B, M3 screw silver x 8, black x 2)
- Screw for locking on ceiling mounted hanger x 4
- Drilling machine, screw driver, ladder

3.3.2.2 Metal Plate size diagram

- Metal plate A - machine side

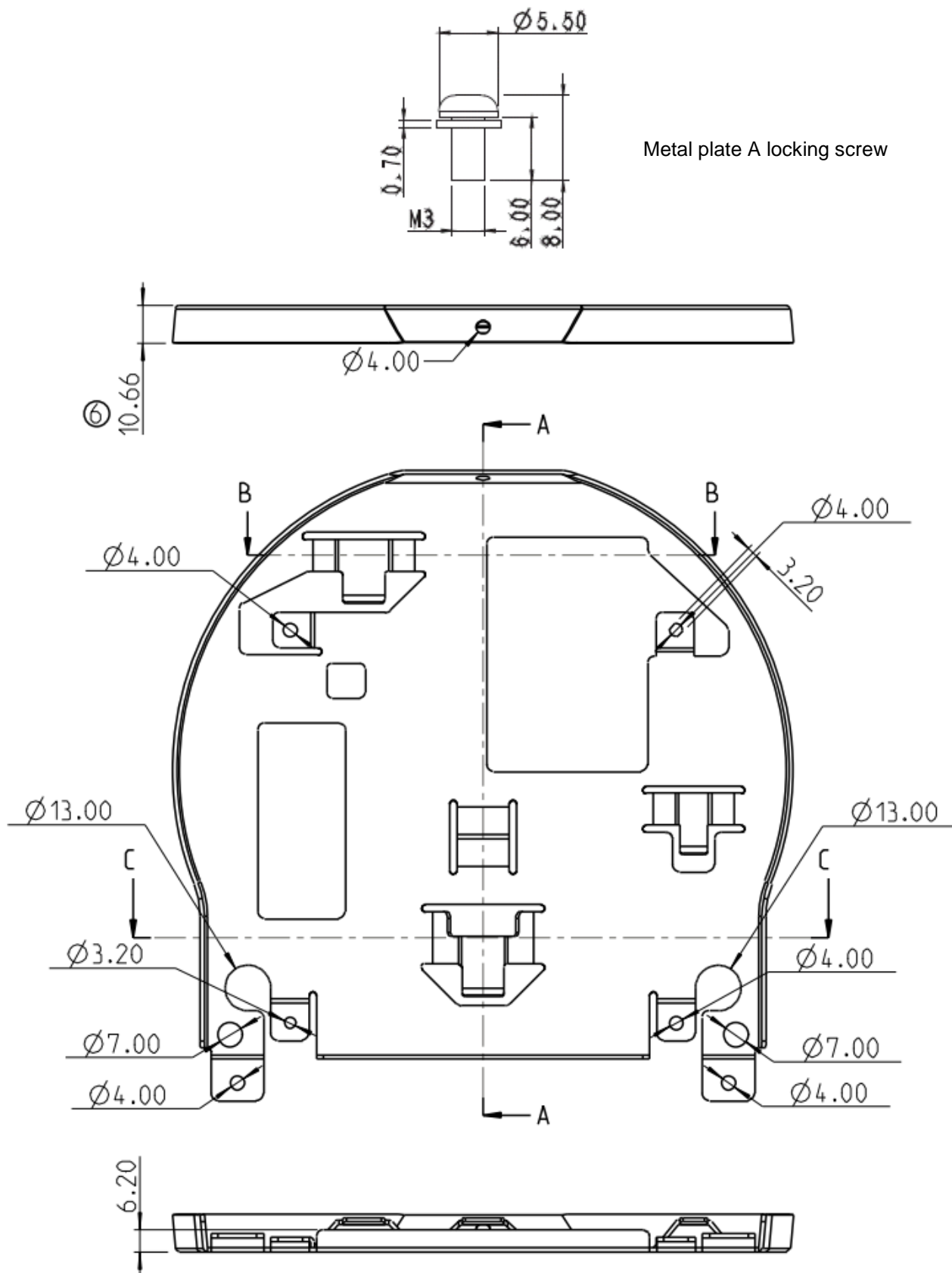

Metal plate A locking screw

Metal plate A - machine side

■ Metal plate B - ceiling side

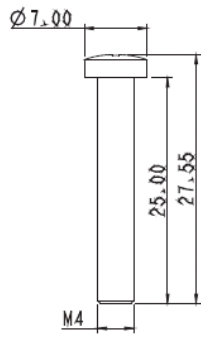

Metal plate B locking screw

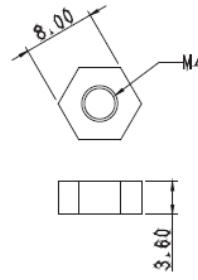

Metal plate B locking bolt

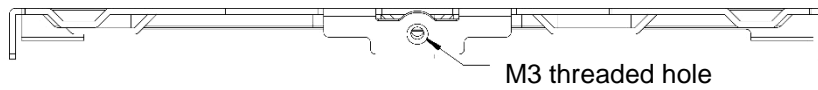

M3 threaded hole

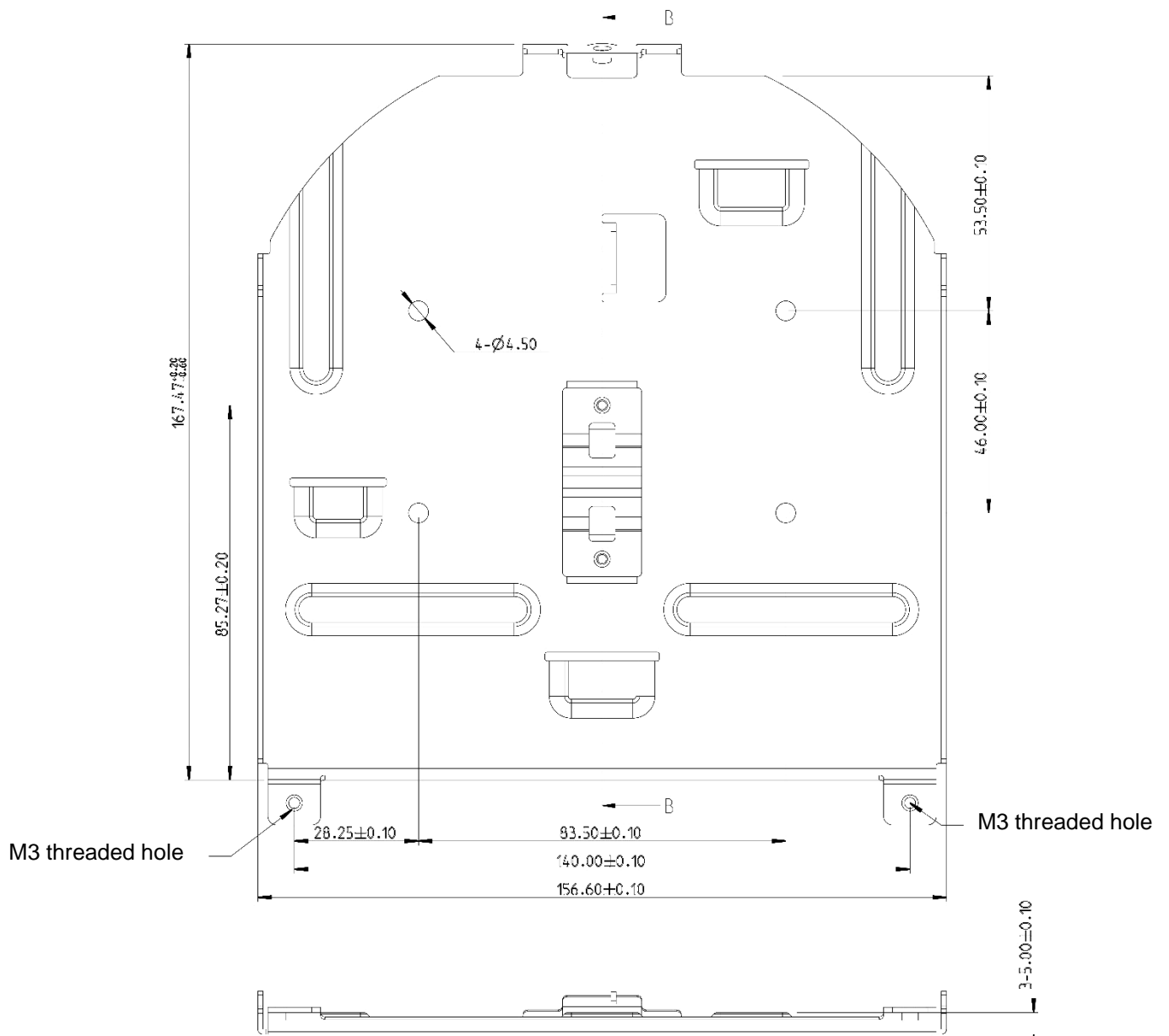

Metal plate B - ceiling side

3.3.2.3 Precautions for installation

1. Before installation, please confirm the orientation of the machine relative to the object to be captured
2. It is recommended that the machine should be set at a distance of more than 1.5 meter away from the object to be captured. Please adjust for a best distance according to the magnification of the lens

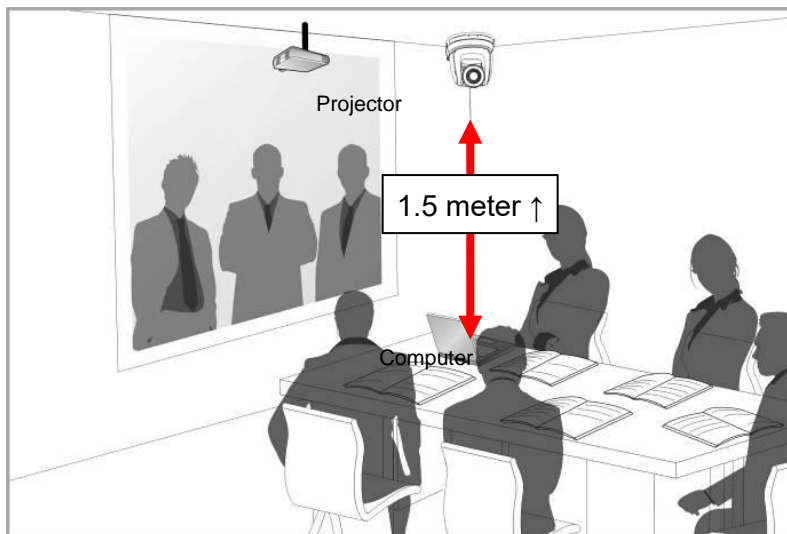

3. The machine (including metal plates) is weighed at about 3 kg. If it is to be installed on the ceiling, please use the hanger that has obtained UL security approval to prevent the machine from falling down.
4. Please check whether the camera is installed securely on a regular basis.
5. Please clean the cooling fan located at the bottom to ensure the good heat dissipation effect of the machine on a regular basis.

3.3.2.4 Installation steps

1. Remove the 4 foot pads on the machine base. The foot pads are designed to be detachable and can be removed by rotating them counterclockwise by hand.
<Remark> The removed foot pads must be kept properly for future use.

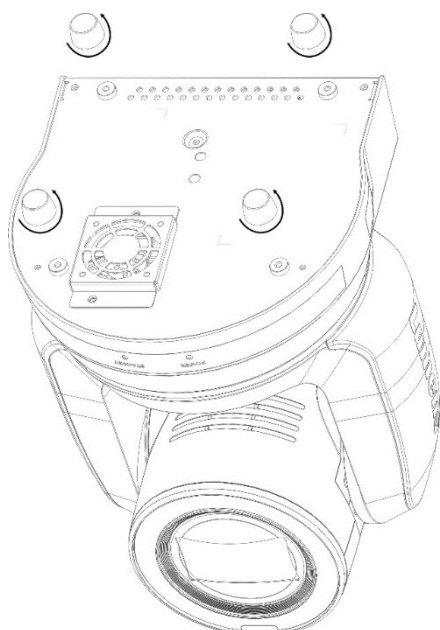

2. Fix the metal plate A on the machine base with 4 M3 silver screws

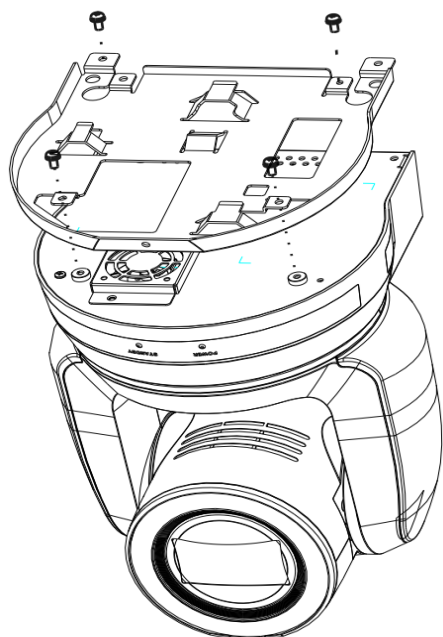

3. Lock the metal plate B on ceiling mounted hanger

<Note>

- (1) Please use the hanger that has obtained UL security approval
- (2) Please reserve the hole for the connecting wires of the camera

4. Combine the metal plate A and the metal plate B

- (1) Push the metal plate A up to the ceiling and then to the right to latch the metal plate B
- (2) And then secure with 2 M3 silver screws and 1 M3 black screw

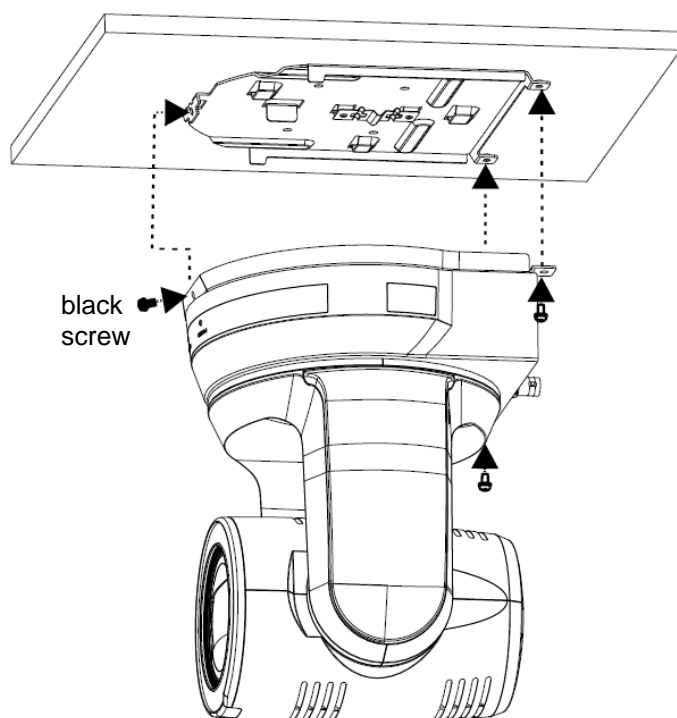

3.3.2.5 How to remove

1. Remove the connecting wires from the camera
2. Uninstall the camera together with the ceiling, loosen the three screws that fix the metal plates A and B and push to the left to remove the machine
3. Then remove the screws on the hanger and the machine

3.4 Connecting devices

3.4.1 RS-232 Connection

With RS-232 in/out, at most 7 Lumens cameras can be connected.

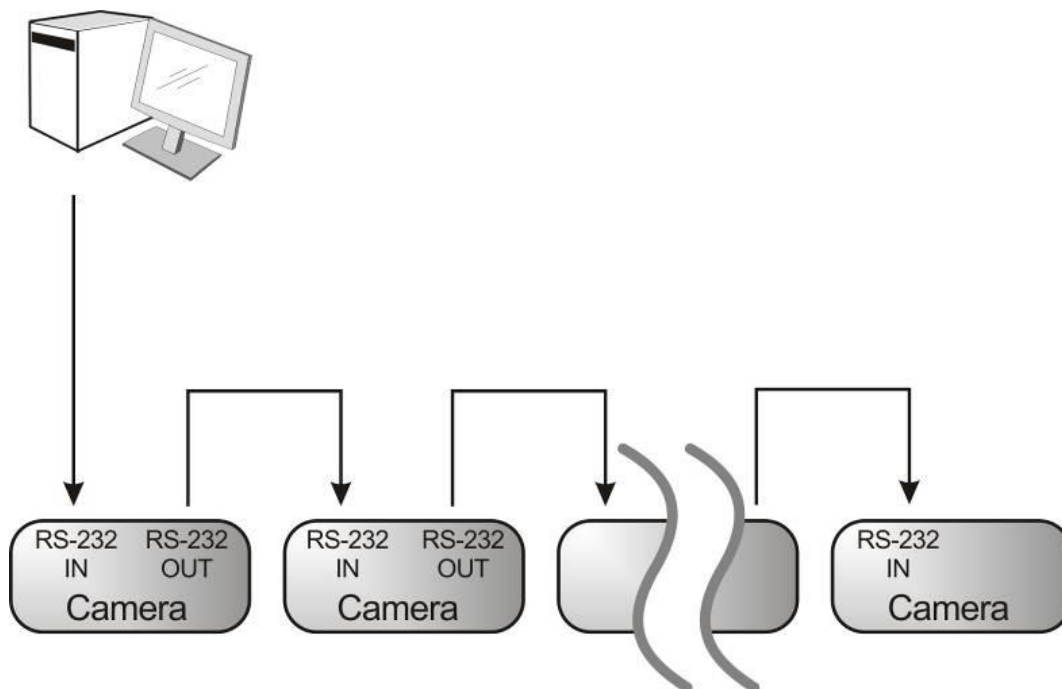

■ RS-232 pins definition instructions

▼ RS-232 IN Pins Instructions

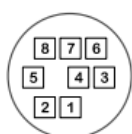

NO	Pins	Signals
1	DTR	Data Transmission Reade
2	DSR	Data Set Reade
3	TXD	Transmit Data
4	GND	Ground
5	RXD	Receive Data
6	GND	Ground
7	IR OUT	IR Commander Signal
8	N.C.	No Connection

▼ RS-232 OUT Pins Instructions

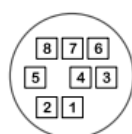

NO	Pins	Signals
1	DTR	Data Transmission Reade
2	DSR	Data Set Reade
3	TXD	Transmit Data
4	GND	Ground
5	RXD	Receive Data
6	GND	Ground
7	OPEN	Reserved
8	OPEN	Reserved

▼ RS-232 Connection Instructions

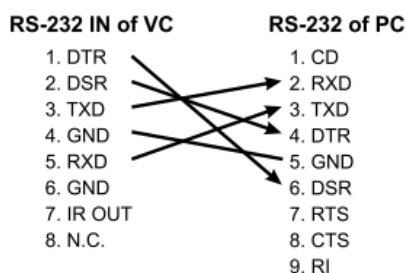

▼ RS-232 Connection Instructions

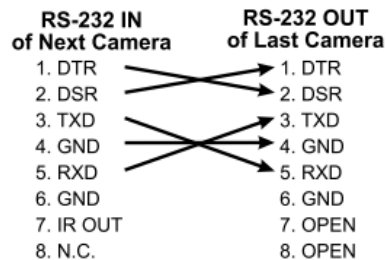

3.4.2 RS-422 Connection

With RS-422, at most 7 Lumens cameras can be connected.

<Note> When RS-422 connection is being used, do not use RS-232 connection.

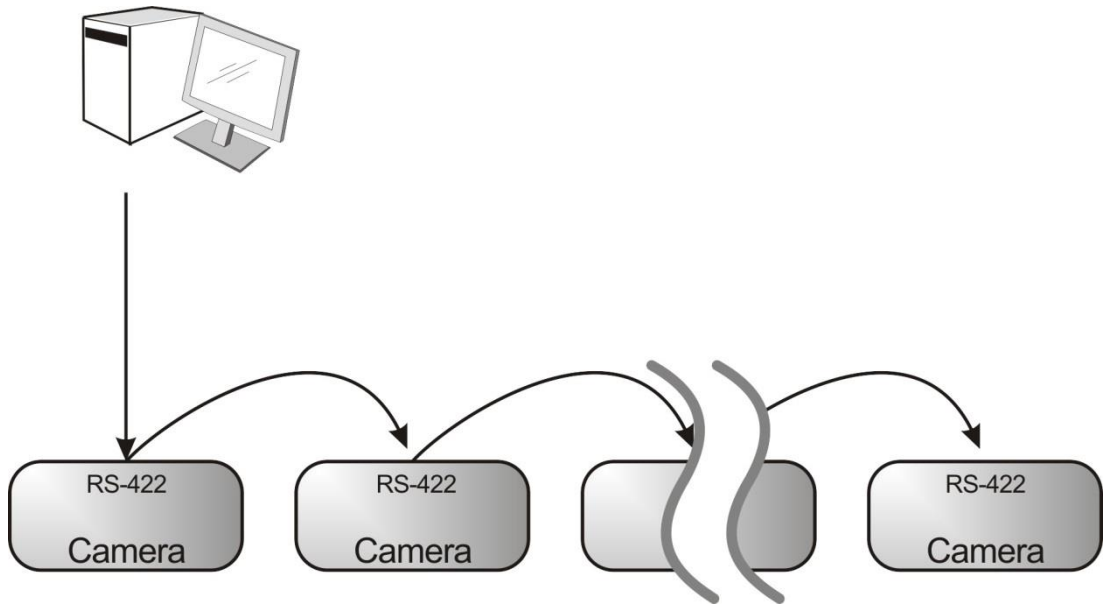

■ RS-422 pins definition instructions

▼ RS-422 Pins Instructions

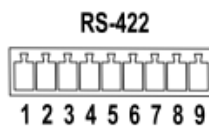

Pin NO.	Function
1	RXD OUT-
2	RXD OUT+
3	TXD OUT-
4	TXD OUT+
5	GND
6	RXD IN-
7	RXD IN+
8	TXD IN-
9	TXD IN+

▼ RS-422 Serial Connection

Up to seven cameras can be daisy-chained

Third Camera

1	RXD OUT-
2	RXD OUT+
3	TXD OUT-
4	TXD OUT+
5	GND
6	RXD IN-
7	RXD IN+
8	TXD IN-
9	TXD IN+

Second Camera

1	RXD OUT-
2	RXD OUT+
3	TXD OUT-
4	TXD OUT+
5	GND
6	RXD IN-
7	RXD IN+
8	TXD IN-
9	TXD IN+

First Camera

1	RXD OUT-
2	RXD OUT+
3	TXD OUT-
4	TXD OUT+
5	GND
6	RXD IN-
7	RXD IN+
8	TXD IN-
9	TXD IN+

Compact Camera Controller

1	NC
2	NC
3	NC
4	NC
5	GND
6	RXD IN-
7	RXD IN+
8	TXD IN-
9	TXD IN+

▼ RS-422 Connection Instructions

—Applicable to Lumens Compact Camera Controller

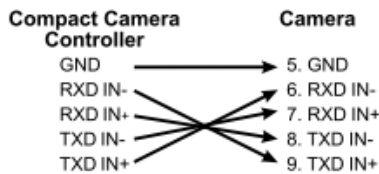

▼ RS-422 Connection Instructions

—Applicable to SONY Compact Camera Controller

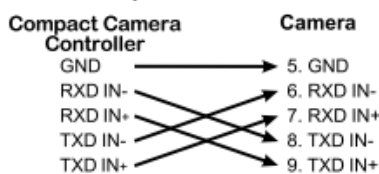

■ RS-422 connection instructions

1. Hold the two sides of RS-422 connector and pull out in the direction shown by the arrow in the figure below

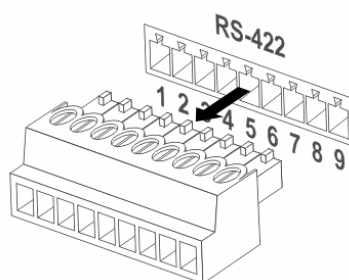

2. Peel off a section of copper wire (AWG Nos. 28 to 18) and insert it into the connector hole; then use flat screw driver to fix it

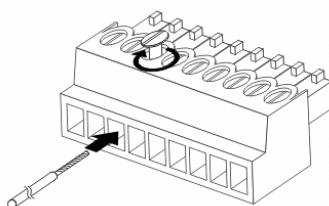

3. Insert the wired RS-422 connector back to the camera. Now the connection is completed

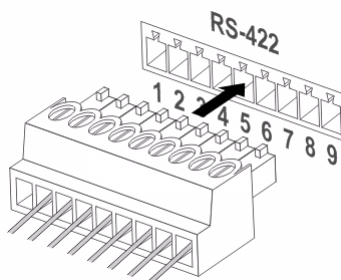

Chapter 4 Remote Control and Setting Menu

4.1 Functions of remote control

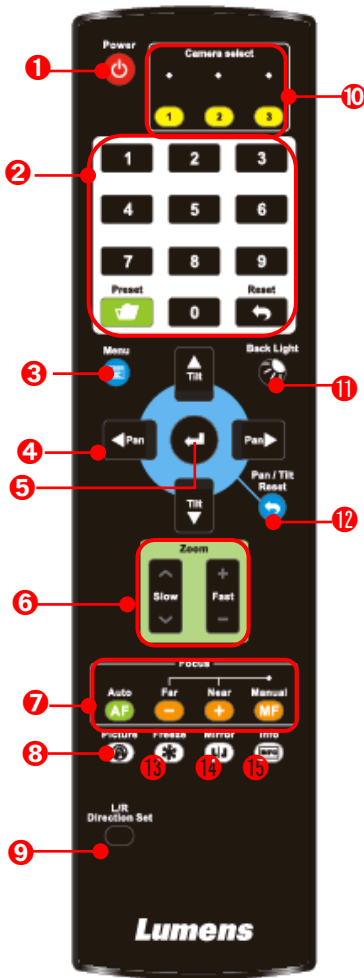

No.	Item	Description
1.	Power	Power Switch
2.	Preset	<ul style="list-style-type: none"> ■ Numeric Keys 0 - 9: Click to call the preset ■ Preset: Appoint an ID (0 ~ 9) to save the current position data ■ Reset: Appoint an ID (0 ~ 9) to delete the current position data
3.	Menu	Display OSD menu
4.	Pan/ Tilt	Move the lens
5.	Home-Enter	Go back to the main page / Execute
6.	Zoom	<ul style="list-style-type: none"> ■ Fast: Adjust image size ■ Slow: Fine-tune image size
7.	Focus	<ul style="list-style-type: none"> ■ Auto: Auto focus ■ Manual: Enable Manual Focus ■ Far/ Near: Adjust the focal length in Manual
8.	Picture	Switch image effect (OFF/ Neg/ B&W)
9.	L/R Direction Set	L/R Direction / Normal
10.	Camera select	Choose camera ID 1 ~ 3
11.	Back Light	Turn on/off back light compensation
12.	Pan/ Tilt Reset	Clear the Pan/Tilt setting
13.	Freeze	Freeze the screen
14.	Mirror	Rotate the image (OFF/ Mirror/ Flip/ Rotate)
15.	Info	Status information

4.2 Setting Menu

<Remark> Press [MENU] on the **remote control** to enter the setting menu; the **bold underlined** values in the following table are defaults.

1 st Level Major Items	2 nd Level Minor Items	3 rd Level Adjustment Values	Function Descriptions
Exposure	Mode	1. <u>Full Auto</u> 2. Shutter Pri 3. Iris Pri 4. Manual	Exposure mode setting
	Exposure Comp	On / <u>Off</u>	AE Level
	Exposure Comp. Level	-5~ <u>C</u> ~5	The value can be adjusted after Exposure Comp. is activated
	Spot Light	On / <u>Off</u>	
	Spot Light Position	X(0~6)Y(0~4)	The value can be adjusted after Spot Light is activated
	Shutter Pri	1/10000-1/1	Adjustable when the Exposure mode is set to Shutter Pri
	Iris Pri	F1.6~ <u>C</u> ~F18/Off	Adjustable when the Exposure mode is set to Iris Pri
	Manual Gain	<u>0</u> -45dB	Adjustable when the Exposure mode is set to Manual
	Manual Speed	1/10000-1/1	Manually set the shutter
	Manual Iris	F1.6~ <u>C</u> ~F18/Off	Manually set the iris
	Gain Limit	9- <u>45</u> dB	Max. limit value of electron gain
	Iris Limit	<u>F2.2</u> -F11	Max. limit value of iris
	WDR	<u>Off</u> / 1 / 2 /	
White Balance	Mode	1. <u>Auto</u> 2. Indoor 3. Outdoor 4. One Push WB 5. ATW 6. Manual 7. Sodium Lamp 8. 3000K 9. 4300K 10. 5000K 11. 6500K 12. 8000K	Select the color temperature mode 1. 4000k ~ 7000k 2. 3200k 3. 5800k 4. 1700k ~ 10000k 5. 1700k ~ 10000k 6. Custom 7. 2800k
	One Push Trigger	<u>ENTER</u>	One push trigger
	Manual Red	0~ <u>C</u> ~128	Adjustable when the white balance mode is set to Manual
	Manual Blue	0~ <u>C</u> ~128	Adjustable when the white balance mode is set to Manual
Picture	Picture effect	<u>OFF</u> / Neg / B&W	
	Sharpness	0~ <u>C</u> ~14	
	2D NR	Off / <u>1</u> / 2 / 3	
	3D NR	Off / Low / <u>Typical</u> / Highest	
	Image Mode	<u>Default</u> /Custom	The user may customize his/her desired image mode
	Image Mode Load	<u>ENTER</u>	Adjustable when the Image mode is set to Custom . After selected, the corresponding Image mode parameters will be read and applied to Custom
	Brightness	0~ <u>C</u> ~15	Adjustable when the Image mode is set to Custom

1 st Level Major Items	2 nd Level Minor Items	3 rd Level Adjustment Values	Function Descriptions
	Hue	0~ <u>C</u> ~15	Adjustable when the <i>Image mode</i> is set to Custom
	Saturation	0~ <u>C</u> ~15	Adjustable when the <i>Image mode</i> is set to Custom
	Gamma	0~ <u>C</u> ~3	Adjustable when the <i>Image mode</i> is set to Custom
Pan Tilt Zoom	Pan/Tilt Limit	On / Off	Turn on/off the angle limit setting
	Pan Right Limit	0~ <u>170</u>	Limit the right angle
	Pan Left Limit	<u>-170</u> ~0	Limit the left angle
	Tilt UP Limit	0~ <u>90</u>	Limit the upward angle
	Tilt Down Limit	<u>-30</u> ~0	Limit the downward angle
	Pan Flip	On / Off	Activate the reverse Pan direction
	Tilt Flip	On / Off	Activate the reverse Tilt direction
	Preset Speed	5/ 25/ 50/ 80/ 120/ <u>160</u> / 200/ 300 deg/sec	Set the rotation speed of the cradle head when Preset is performed
	PTZ Speed Comp	On / Off	Set the Pan/Tilt moving speed to vary from the zoom position
	D-Zoom Limit	<u>x1</u> ~x12	Set the D-zoom limit
	PTZ Motion Sync	On / Off	When activated, PTZ synchronization can be achieved by controlling with the Presets <Remark> Refer to the Preset speed setting for this feature. The speed may be adjusted automatically due to the difference of PTZ moving range.
D-Effect	Mirror	Off / Mirror / Flip / Mirror + Flip	Set the mode at which the image is mirror or flipped
Auto Focus	AF Sensitivity	Low / <u>Mid</u> / High	For AF triggering speed, the higher the speed is, the faster AF is triggered
	AF Frame	Center Area / All Area / Auto	AF frame setting, when central area was set as AF frame, focusing will be on the center of the screen. When Full Frame was set as AF frame, focusing will be calculated based on the full screen
	Zoom Tracking	Manual / Curve Tracing / Zoom Tracking	The focus mode during lens zooming (It can be set in the Manual Focus (MF) mode)
	PTZ Assist	On / Off	When PTZ Assist is enabled and PTZ control is in operation, the focus performs only once upon immediate execution. The focus will not be triggered afterward when the scene changes (It can be set in the Manual Focus (MF) mode)
	SMART AF	On / Off	Turn on this function and AF will mainly focus on the face
Ethernet	DHCP	On / Off	Enable/Disable DHCP setting using left and right arrow keys and press [ENTER] to apply setting.

1 st Level Major Items	2 nd Level Minor Items	3 rd Level Adjustment Values	Function Descriptions
	IP Address	<u>192.168.100.100</u>	Press [ENTER] to be in modify mode; select the item to be modified using the up and down keys, and modify the value using the left and right keys or the numeric keys.
	Subnet mask	<u>255.255.255.0</u>	Press [ENTER] to be in modify mode; select the item to be modified using the up and down keys, and modify the value using the left and right keys or the numeric keys.
	Gateway	<u>192.168.100.254</u>	Press [ENTER] to be in modify mode; select the item to be modified using the up and down keys, and modify the value using the left and right keys or the numeric keys.
Audio	Audio In	<u>Line In</u> / Mic In	Set Audio In
	Audio Enable	On / <u>Off</u>	Turn on/off audio output
	Audio Volume	0~ <u>C</u> ~10	Audio Volume Setting
	Audio Delay	On / <u>Off</u>	When the audio is not synchronized with the video, enable this function to set the audio delay time <Remark> Supported when NDI HX function setting is off
	Audio Delay Time(ms)	<u>-1</u> ~-500ms	Set audio delay time <Remark> Supported when NDI HX function setting is off
	Encode Type	<u>AAC</u> / G.711	Set audio encode type <Remark> Supported when NDI HX function setting is off
	Encode Sample Rate	1. <u>48 KHz(AAC)</u> 2. 44.1 KHz(AAC) 3. 16 KHz(AAC) 4. 16 KHz(G.711) 5. 8 KHz(G.711)	Set the encode type and sample rate <Remark> Supported when NDI HX function setting is off
System	Prompt	On / <u>Off</u>	Turn on/off the prompt information on the display
	IR Receive	<u>On</u> / Off	When it is Off, the remote control will not be able to control the camera. At this moment, turn off and then turn on the power to restore control of the remote control.
	Tally Lamp	On / <u>Off</u>	Select to enable or disable Tally Lamp function.
	Tally CMMD Mode	General / <u>Link</u>	Set whether the indicator light is linked with RS232 command <ul style="list-style-type: none"> ■ General (Not linked): The indicator light switch and mode shall be set separately. • When the indicator light is on and the default mode is off, additional command is required to set the indicator light mode • Setting the indicator light mode when the indicator light is off will not trigger the indicator light

1 st Level Major Items	2 nd Level Minor Items	3 rd Level Adjustment Values	Function Descriptions
			<ul style="list-style-type: none"> ▪ Link: <ul style="list-style-type: none"> · When the indicator light is on, the default mode is red light · Setting the indicator light mode when the indicator light is off will turn on the indicator light
	Language	<u>English</u> / Chinese	
	Initial Position	<u>Last operated</u> / First default position	Select the camera lens to return to the last operated position or the first default position after POWER ON <Remark> First default position = Preset 0
	Control Device	Encoder / <u>Controller</u>	Control Device setting, Controller: for joystick Encoder: for tracking system
	Motionless Preset	On / <u>Off</u>	When the function is enabled, the screen will Freeze when Preset is executed. Freeze will be released after Preset is completed.
	Control Port	<u>RS-232</u> / RS-422	Choose whether the control interface used is RS-232 or RS-422
	Protocol	<u>VISCA</u> / Pelco D	
	Baud Rate	<u>9600</u> / 38400	Choose the transmission speed of the control signal
	VISCA Address	<u>0</u> ~7	The Protocol set to VISCA allows the camera ID address to be assigned. Select 0 for automation.
	PELCO D Address	<u>1</u> ~255	The Protocol set to Pelco D allows the camera ID address to be assigned.
	Genlock - Hor. Phase	500~ <u>C</u> --500	Set synchronized source parameters
	Output Mode	<ol style="list-style-type: none"> 1. <u>3840x2160/59.94p</u> 2. 3840x2160/50p 3. 3840x2160/29.97p 4. 3840x2160/25p 5. 1080p/59.94 6. 1080p/50 7. 1080p/29.97 8. 1080p/25 9. 720p/59.94 10. 720p/50 11. 1080i/59.94 12. 1080i/50 	Choose the output resolution
	Color Space	<u>Standard Profile</u> / REC.709/ BT.2020	Set the standard for color space
	Factory Reset	On / <u>Off</u>	Resume the factory default setting
Status			Display the current setting status

Chapter 5 Network Function Settings Description

5.1 Connecting Camera to Network

5.1.1 Connecting to Internet

Two common connection methods are shown below

1. Connecting via switch or router

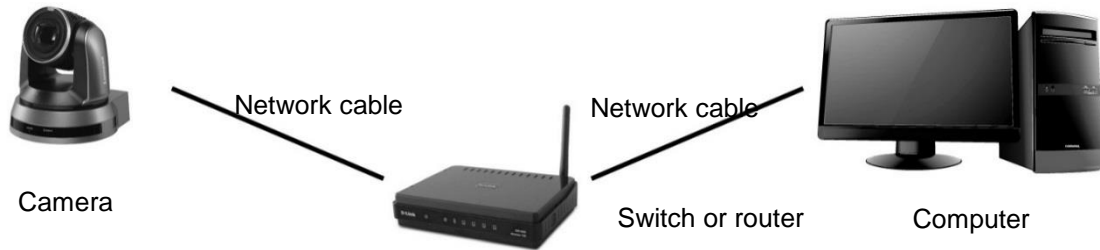

2. To connect directly through network cable, the IP address of the computer should be changed so that it is on the same network segment as the camera

E.g.: The factory-preset default IP address of the camera is 192.168.100.100. The computer IP address must be set with the same network segment, such as 192.168.100.101, so that the computer can be connected correctly with the camera

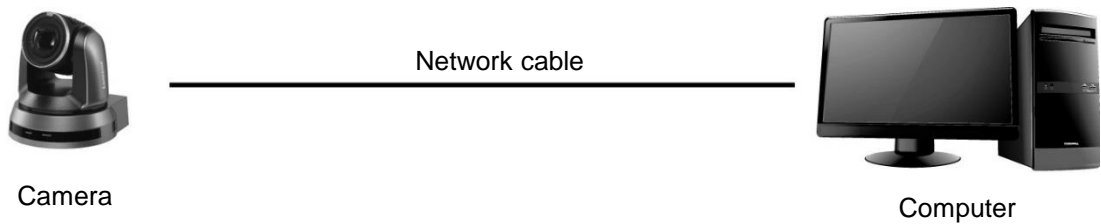

• Change network settings

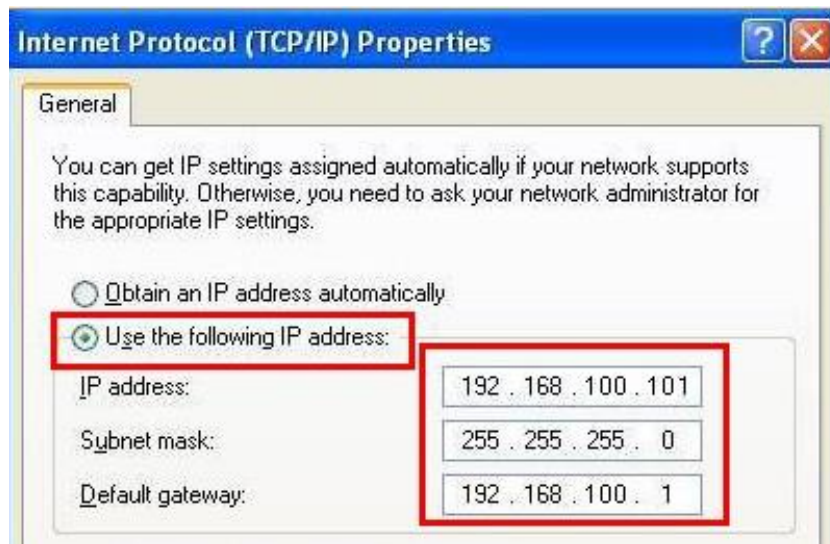

5.1.2 Using the Browser to View the Images

- Open the browser, and enter the IP address of the camera in the address bar
E.g.: <http://192.168.100.100> (default IP address)
- Enter administrator's account and password
For the first-time login, please refer to [5.2.12 Settings - User](#) to change the default password

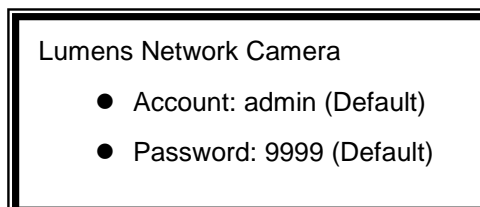

5.1.3 Using Lumens VMS Software to View the Images

<Remark> Supported when NDI|HX function is off (Please refer to [5.2.5 Streaming - NDI](#))

- Open **LUMENS VMS** software (Please download from the Lumens official website)
- Search Camera: Press  [automatically search for the device] button to locate the Camera
- Click camera in the list and start operation after connecting to network

<Note> When using automatic search, the camera and computer must be in the same network segment, e.g., 192.168.4.X

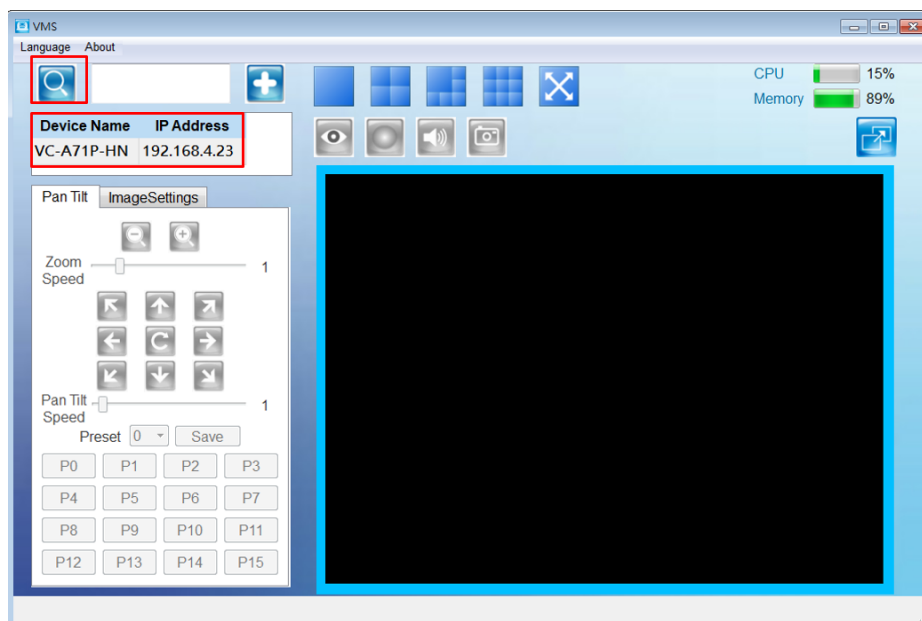

5.1.4 Using RTSP Player to View the Images

<Remark> To support this function, please turn off NDI|HX function (Please refer to [5.2.5 Streaming - NDI](#))

In addition to the browser and VMS, other free softwares also can be used for RTSP connection, such as VLC, Quick Time and PotPlayer

RTSP connection address formats are as follows:

- RTSP Main Streaming (4K@H.265)=> <rtsp://camera IP:8554/hevc>
- RTSP Sub1 Streaming (1080P@H.264)=> <rtsp://camera IP:8557/h264>
- RTSP Sub2 Streaming (720P@H.264)=> <rtsp://camera IP:8556/h264>

If password authentication is enabled, the RTSP connection address is as follows:

- RTSP Main Streaming
<rtsp://Username:Password@VC IP address:port/hevc>
- RTSP Sub1/ Sub2 Streaming
<rtsp://Username:Password@VC IP address:port/h264>
- To enable password authentication function, please refer to [5.2.4 Stream](#)

Example:

Open the VLC software, click [Open Network Streaming], and enter the URL:

<rtsp://192.168.100.100:8554/hevc>

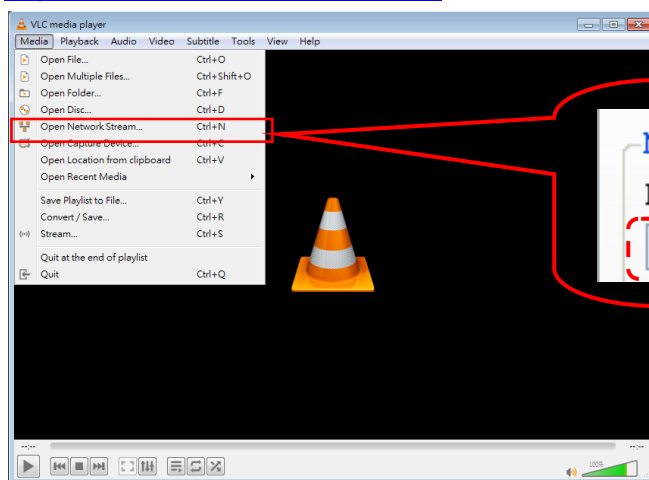

5.1.5 Using NDI Studio Monitor to View the Images

<Remark> To support this function, please turn on NDI|HX (Please refer to [5.2.5 Streaming - NDI](#))
For operation or description of NewTek, please visit the website <https://www.newtek.com/>
NDI 4 Tool Download link <http://new.tk/NDIHX-Driver-Win>

5.2 Web Page Function Description

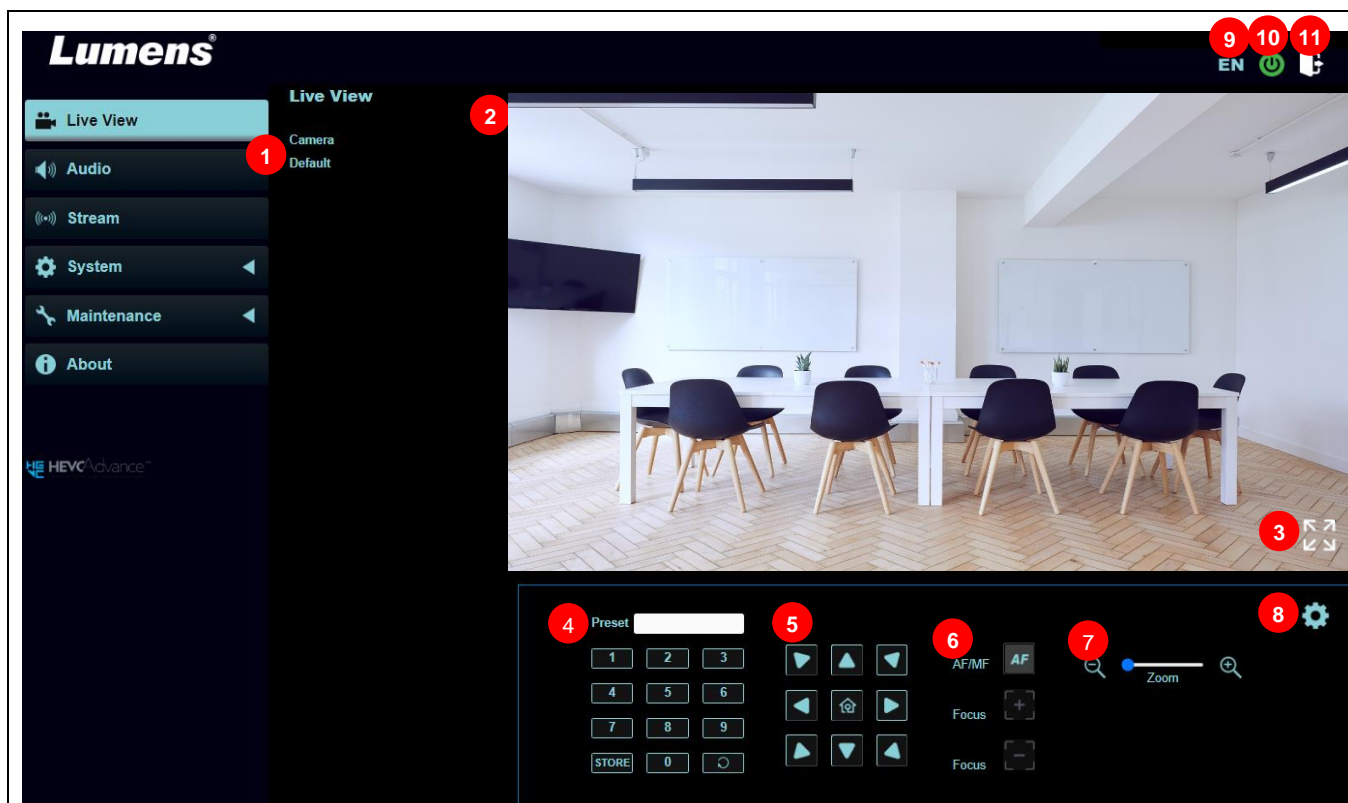

5.2.1 Live View

<Remark> The preview window is not supported when NDI|HX is on

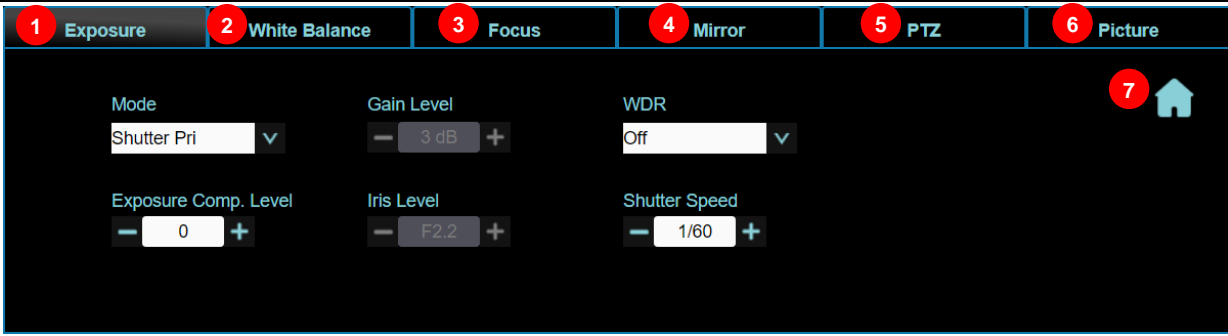

No	Item	Function Descriptions	NDI HX OFF	NDI HX ON
1	Camera ID/ location	Display camera ID/location Please refer to 5.2.7 System Settings - Device	✓	✓
2	Preview window	Display the screen currently captured by the camera	✓	
3	Enlarge the preview window	Zooming in/out the preview image	✓	
4	Preset setting	Select the number first and then select SAVE or LOAD	✓	✓
5	Pan/ Tilt setting	Adjust the Pan/Tilt position of the camera screen	✓	✓
6	AF/ MF	Switch to Auto Focus/Manual Focus. Focus can be adjusted in Manual Focus	✓	✓
7	Zoom	Zoom In/Zoom Out ratio	✓	✓
8	Camera Setting	Please refer to 5.2.2 Camera Setting for relevant settings	✓	✓
9	Language	Supporting English/ Traditional Chinese/ Simplified Chinese	✓	✓
10	Power on and off	Turn on/ off the camera	✓	✓
11	Logout	Log out the administrator screen on the website	✓	✓

5.2.2 Camera Setting

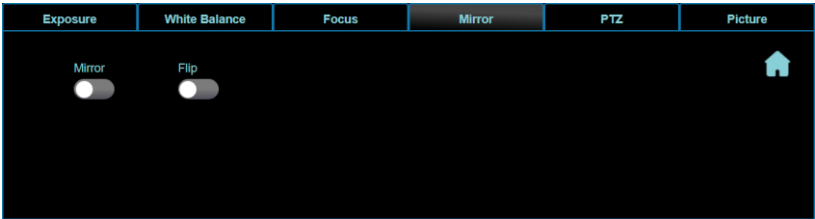
No	Item	Function Descriptions
1	Exposure	 <ul style="list-style-type: none"> ■ Mode: Select exposure mode (Full Auto / Shutter Pri / Iris Pri / Manual) ■ Gain Level: Adjust the gain level (adjustable under the “Manual”) ■ WDR: Set the level of wide dynamic range (WDR) in order to obtain better images ■ Exposure Comp. Level: Select exposure compensation level ■ Iris Level: Adjust the size of iris (adjustable under the “Manual” or “Iris Priority”) ■ Shutter Speed: Adjust the shutter speed (adjustable under the “Manual” or “Shutter Priority”)
2	White Balance	 <ul style="list-style-type: none"> ■ Mode: Select the color temperature mode ■ One Push WB: Single color temperature execution adjustment (adjustable only under the “One Push WB”) ■ Manual Red/Blue: Manually adjust blue/red color temperature
3	Focus	 <ul style="list-style-type: none"> ■ AF Sensitivity: Set automatic focus sensitivity ■ AF Frame: Set automatic focus range ■ Zoom Tracking: The focus mode during lens zooming (can be set in “Manual”) ■ PTZ Assist: Check whether auto focus is enabled if there is any changes of PTZ (can be set in “Manual”) <p><Remark> When PTZ Assist is enabled and PTZ control is in operation, the focus will be triggered. The focus will not be triggered when the scene changes</p> <ul style="list-style-type: none"> ■ Smart AF: AF will mainly focus on the face ■ One Push AF: When the manual focus mode is on, click the button to perform one auto focus
4	Mirror	 <ul style="list-style-type: none"> ■ Mirror: Set image mirroring ■ Flip: Set the mirror/flip mode

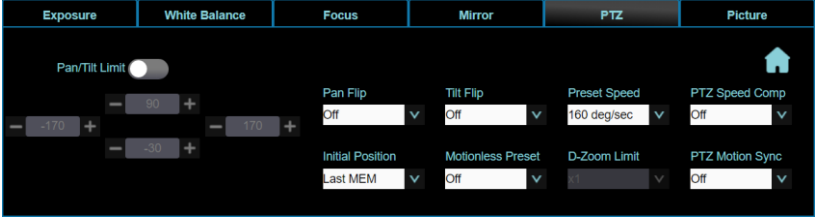
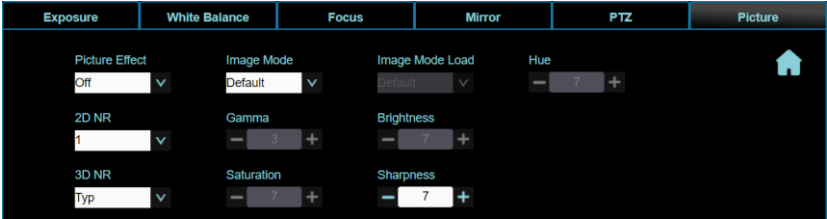
5	PTZ	 <ul style="list-style-type: none"> ■ Pan/Tilt limit: Enable, and set the pan/tilt limit ■ Pan/Tilt flip: When it is set, the Pan/Tilt direction will go oppositely ■ Preset Speed: Set the rotation speed of the cradle head when Preset is executed ■ PTZ Speed Comp: After it is activated, the Pan/Tilt moving speed will vary from the zoom position ■ Initial Position: Set the camera lens to return to the last operated position or the first default position after POWER ON <Remark> First default position = Preset 0 ■ Motionless Preset: When the function is enabled, the screen will Freeze when Preset is executed. Freeze will be released after Preset is completed ■ D-Zoom Limit: Set the D-zoom limit ■ PTZ Motion Sync: When activated, PTZ synchronization can be achieved by controlling with the Presets <Remark> Refer to the Preset speed setting for this feature. The speed may be adjusted automatically due to the difference of PTZ moving range.
6	Picture	 <ul style="list-style-type: none"> ■ Picture Effect: Set picture effect, Off/Neg/Black and White ■ Image Mode: The user may customize his/her desired image mode ■ Image Mode Load: Adjustable when the Image mode is set to Custom. After selected, the corresponding Image mode parameters will be read and applied to Custom ■ 2D noise reduction: 2D noise reduction settings ■ 3D noise reduction: 3D noise reduction settings ■ Gamma: Gamma Level adjustment (Adjustable when the image mode is set to Custom) ■ Brightness: Brightness adjustment of the image (Adjustable when the image mode is set to Custom) ■ Hue: Hue adjustment of the image (Adjustable when the image mode is set to Custom) ■ Saturation: Saturation adjustment of the image (Adjustable when the image mode is set to Custom) ■ Sharpness: Adjust the sharpness of the image
7	PTZ Control	Go back to PTZ Control page

5.2.3 Audio

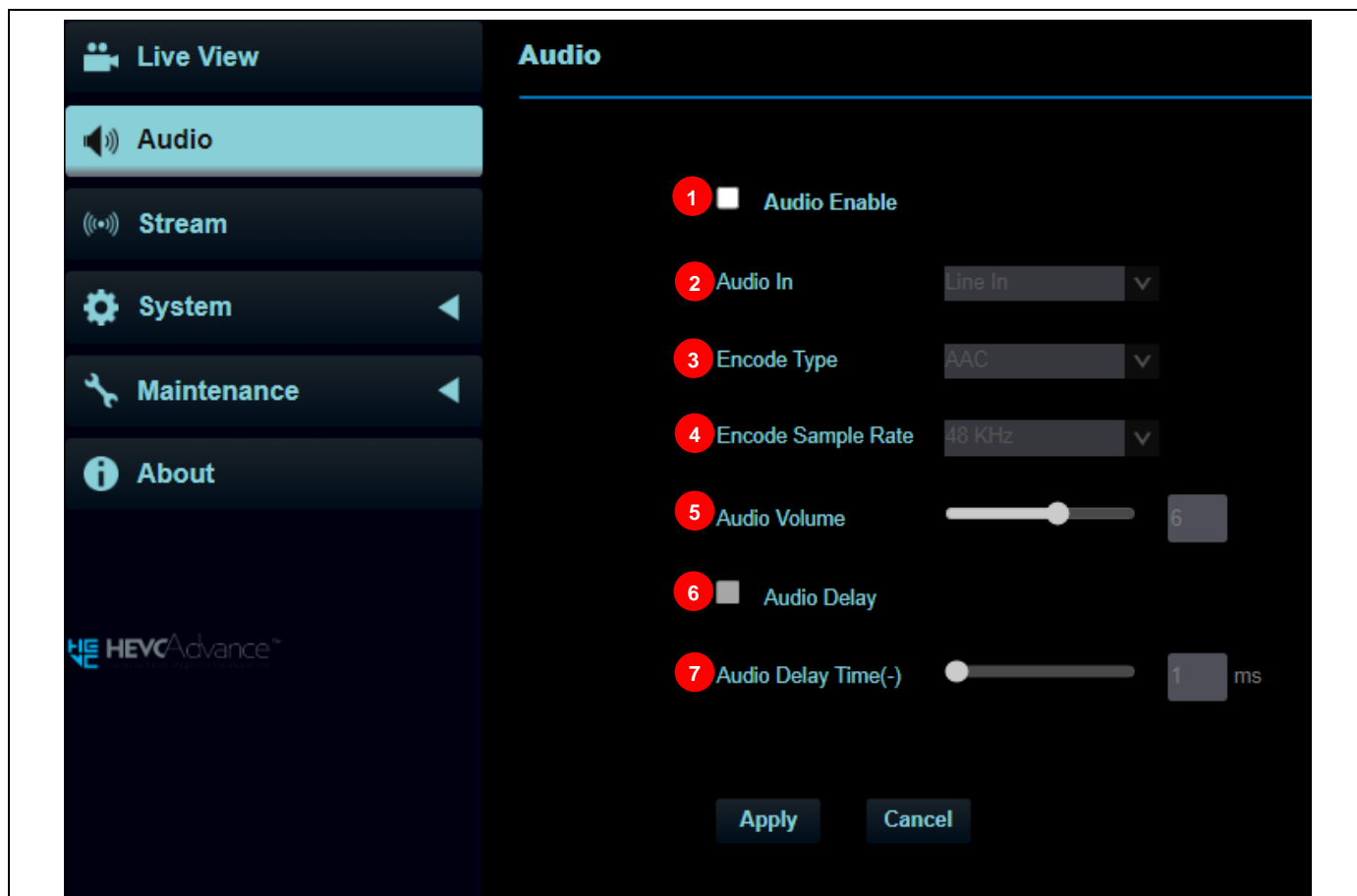

No	Item	Function Descriptions	NDI HX OFF	NDI HX ON
1	Audio Enable	Enable/disable audio	v	v
2	Audio In	Set MIC In/Line In	v	v
3	Encode Type	AAC / G.711	v	
4	Encode Sample Rate	Set Encode sample rate ➤ 48 KHz (AAC) ➤ 44.1 KHz (AAC) ➤ 16 KHz (AAC) ➤ 16 KHz (G.711) ➤ 8 KHz (G.711)	v	
5	Audio Volume	Adjust Audio Volume	v	v
6	Audio Delay	Turn on/off audio delay	v	
7	Audio Delay Time	Set the audio delay time (-1 ~ -500 ms)	v	

5.2.4 Stream

<Remark> The setting is available when NDI|HX is on

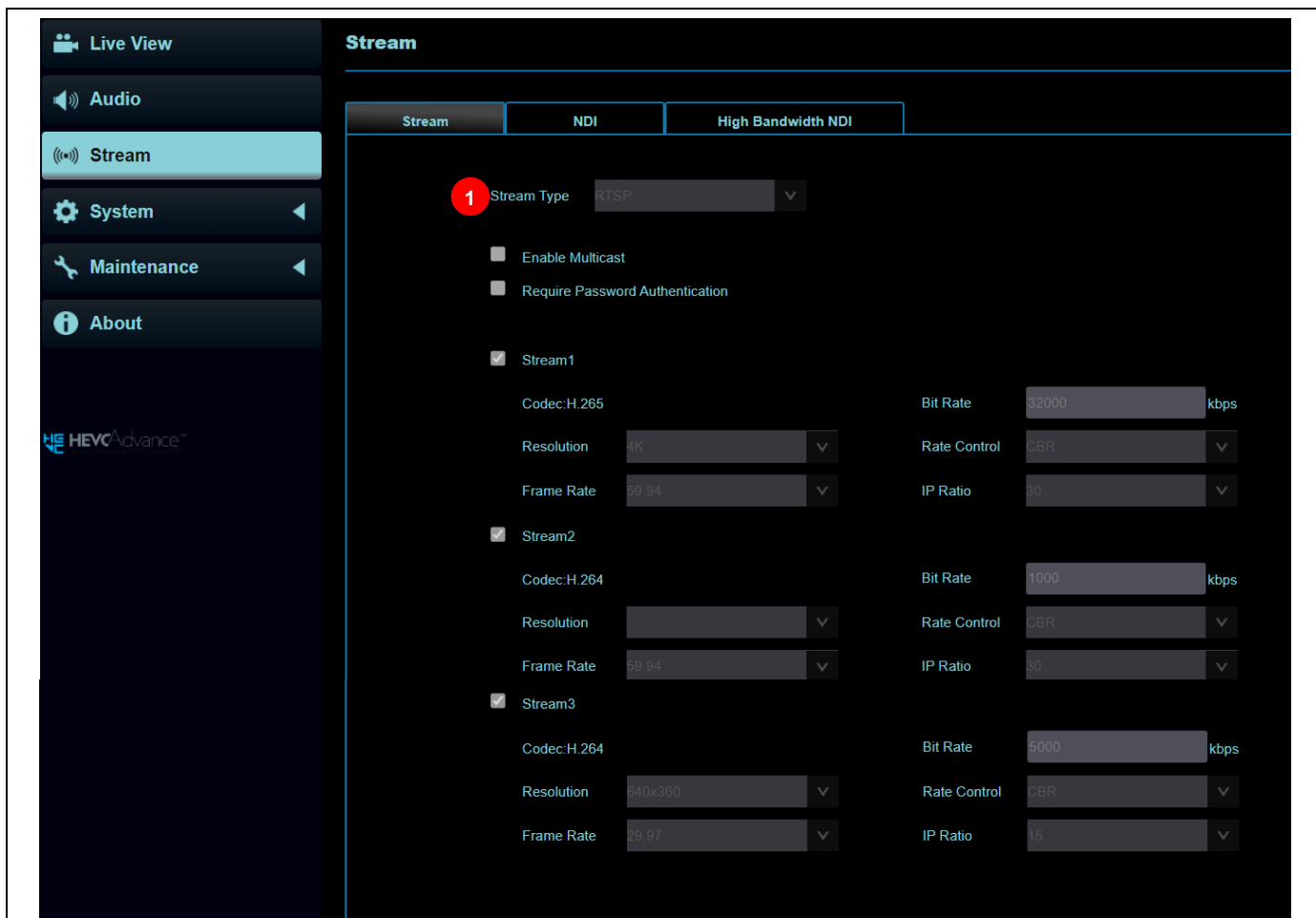

No	Item	Function Descriptions
1	Stream Type	Support types: MPEG-TS/RTMP/RTMPS/RTSP/SRT
	RTSP	<ul style="list-style-type: none"> ■ Enable/Disable Multicast <Remark> It is suggested to enable Multicast when the number of users online watching the image simultaneously is more than 4 ■ Enable/Disable Username/Password Authentication <ul style="list-style-type: none"> ➢ RTSP connection format can be found in 5.1.4 Using RTSP Player to View the Images ➢ The username/password is the same as the web login password of the camera, please refer to 5.2.12 Settings - User to add/modify account information ■ Stream 1 / 2 / 3: Please refer to 5.2.4.1 Streaming Parameter Setting for streaming parameters

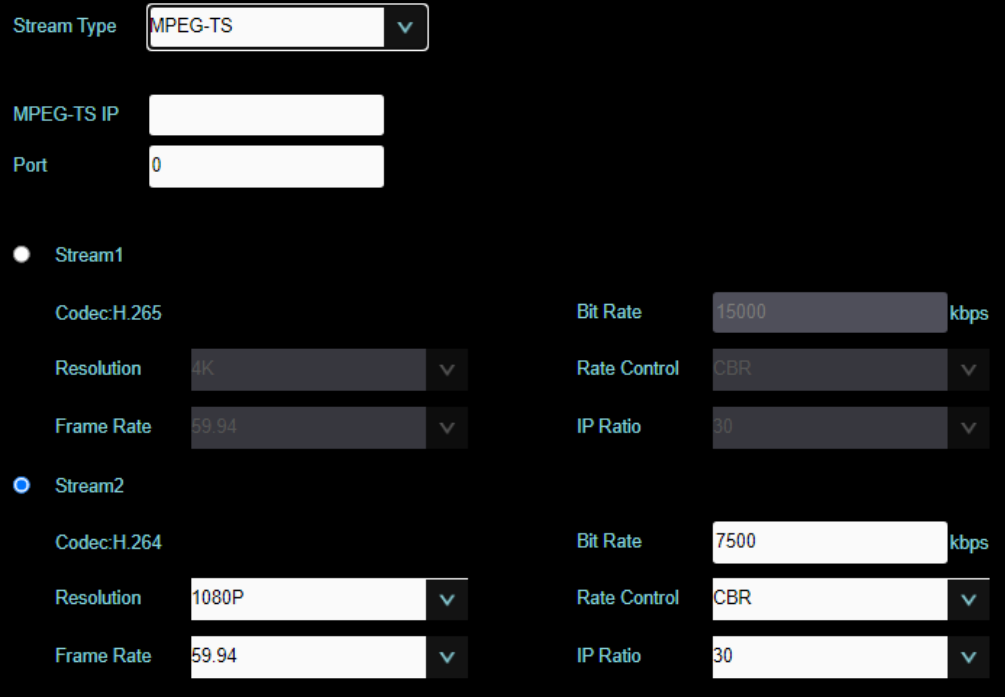
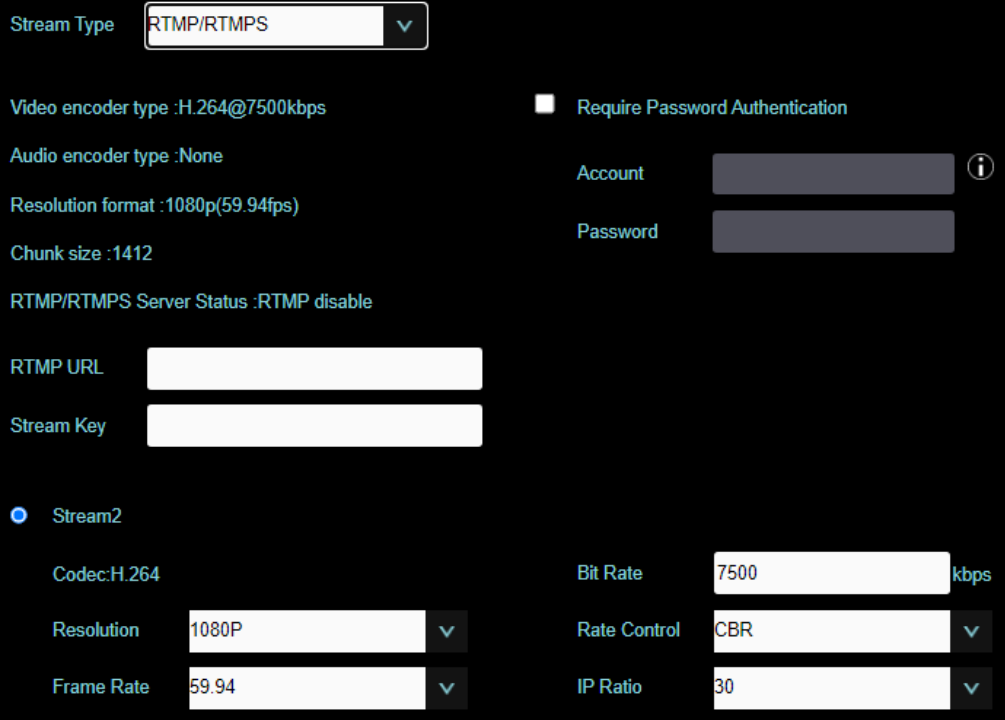
<p>MPEG-TS</p>	 <ul style="list-style-type: none"> ■ Set MPEG-TS format <ul style="list-style-type: none"> <Remark> Port must be set in the range above 1024 with a maximum value of 9999 <Remark> The following port is used by the camera. Setting of the port may not connect correctly 8557, 8556, 8555, 1935 ■ Stream 1 / 2: Please refer to 5.2.4.1 Streaming Parameter Setting for streaming parameters
<p>RTMP/ RTMPS</p>	 <ul style="list-style-type: none"> ■ Copy the RTMP web address provided by the RTMP service platform and paste it to the RTMP connection address to publish the camera images on the RTMP service platform <ul style="list-style-type: none"> <Remark> To upload to YouTube for live streaming, please refer to 5.2.3 Audio ■ Stream 2: Please refer to 5.2.4.1 Streaming Parameter Setting for streaming parameters

SRT

Stream Type SRT ▼

Connect Status :SRT Disable

Connection Mode Caller ▼

URL Port 0

Stream ID

Latency 120 ms

Encryption None ▼

Passphrase

Stream1

Codec:H.265

Resolution 4K ▼

Frame Rate 59.94 ▼

Bit Rate 15000 kbps

Rate Control CBR ▼

IP Ratio 30 ▼

Stream2

Codec:H.264

Resolution 1080P ▼

Frame Rate 59.94 ▼

Bit Rate 7500 kbps

Rate Control CBR ▼

IP Ratio 30 ▼

- The port number must be set in the range above 1024 with a maximum value of 9999
 <Remark> The following port is used by the camera. Setting of the port may not connect correctly
 8554, 8557, 8556, 8555, 19353
- Delay time is for 20 to 8000 microseconds. The default value is 120 microseconds
- Stream1 / 2: Please refer to [5.2.4.1 Streaming Parameter Setting](#) for streaming parameters

5.2.4.1 Streaming parameter setting

Function		Stream 1	Stream 2	Stream 3
Encode Format		H.265	H.264	
Resolution		4K	1080p / 720p / 1080i	640x360
Frame Rate		Setting according to the supported resolution		
Bit Rate(kbps)	Range	2,000~20,000	2,000~20,000	512~5,000
	Factory Default	15,000	7,500	1,000
Rate Control		CBR / VBR		
IP Ratio		Setting according to the supported resolution		

5.2.5 Streaming - NDI

<Remark> The setting is available when NDI|HX is on

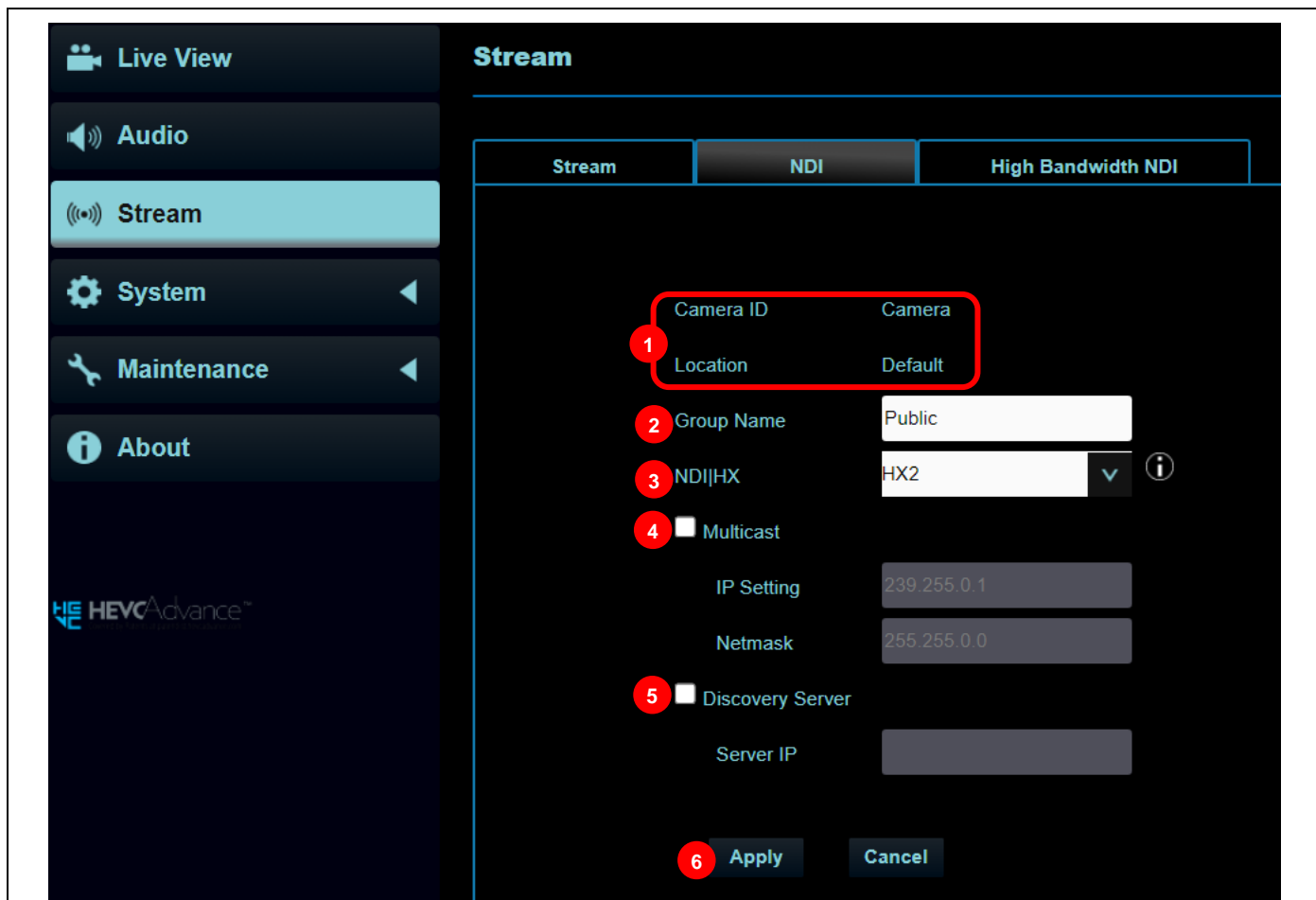

No	Item	Function Descriptions
1	Camera ID/ Location	Displaying ID/location according to [System Settings] > [Device] setting content
2	Group Name	<p>The group name can be modified here and set with Access Manager - Receive in NDI Tool</p> <ul style="list-style-type: none"> ■ If no group is assigned, the machine belongs to Public. As the default of Access Manager includes Public, Studio Monitor can discover this machine. ■ If a group is assigned, but this group is not added into Access Manager, Studio Monitor cannot discover this machine. ■ If a group is assigned and this group is added into Access Manager, Studio Monitor can discover this machine. <p><Remark> The name can contain commas (,) to distinguish different groups Example: "default, 123, abc" means this machine belongs to three groups at the same time (default/ 123/ abc)</p>
3	NDI HX	<p>NDI HX Off/HX2/HX3 can be set on VC-A71PN</p> <ul style="list-style-type: none"> ■ Off: Support RTSP/RTMP/RTMPS/MPEG-TS/SRT, and ONVIF can find devices but cannot be used with NDI Tool ■ HX2: HX2 is supported ■ HX3: HX3 is supported <p><Remark> HX3 only supports 1080p 60/59.94/50 resolutions <Remark> When HX2/ HX3 is on, ONVIF cannot find devices, and RTSP/ RTMP/ RTMPS/ MPEG-TS/ SRT streams cannot be used</p>
4	Multicast	<p>Multicast Setting</p> <p>It is suggested to enable Multicast when the number of users online watching the image simultaneously is more than 4</p>
5	Discovery Server	Check to enter the Server IP address
6	Apply	After the setting has been modified, select this button to apply the setting

5.2.6 Streaming - High Bandwidth NDI

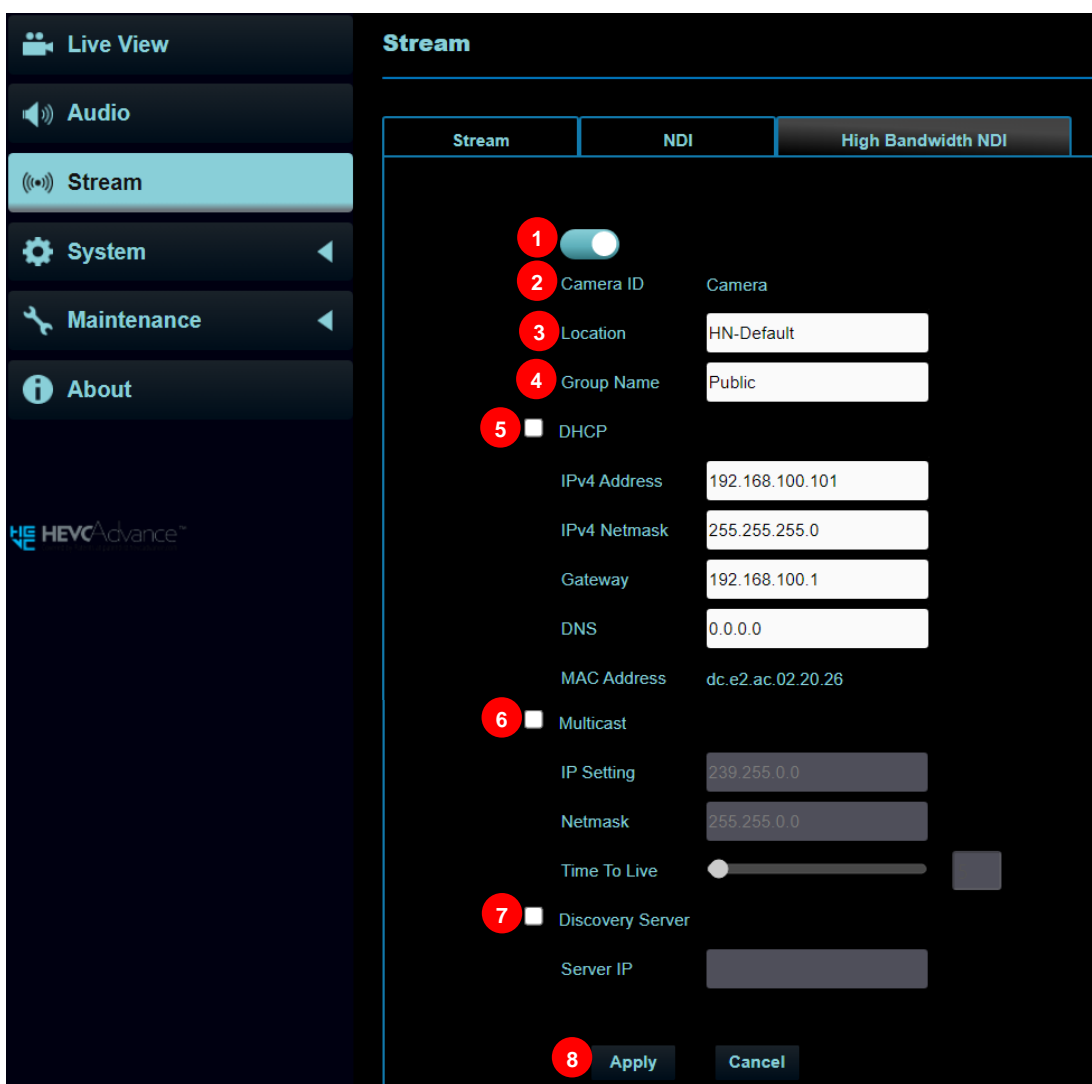

No	Item	Function Descriptions
1	On / Off	Enable / Disable High Bandwidth NDI
2	Camera ID	Displaying ID according to [System Settings] > [Device] setting content
3	Location	Modify the location of the camera, such as Room 1 <ul style="list-style-type: none"> Camera location is limited to 1 - 11 characters Please mix uppercase and lowercase letters or numbers for characters. Special symbols such as "/" and "space" cannot be used
4	Group Name	The group name can be modified here and set with Access Manager - Receive in NDI Tool <ul style="list-style-type: none"> If no group is assigned, the machine belongs to Public. As the default of Access Manager includes Public, Studio Monitor can discover this machine. If a group is assigned, but this group is not added into Access Manager, Studio Monitor cannot discover this machine. If a group is assigned and this group is added into Access Manager, Studio Monitor can discover this machine. <p><Remark> The name can contain commas (,) to distinguish different groups Example: "default, 123, abc" means this machine belongs to three groups at the same time (default / 123 / abc)</p>
5	DHCP	Network setting of camera. Change of setting is available when DHCP function is closed.
6	Multicast	Multicast Setting It is suggested to enable Multicast when the number of users online watching the image simultaneously is more than 4
7	Discovery Server	Check to enter the Server IP address
8	Apply	After the setting has been modified, select this button to apply the setting

5.2.7 System Device - Device

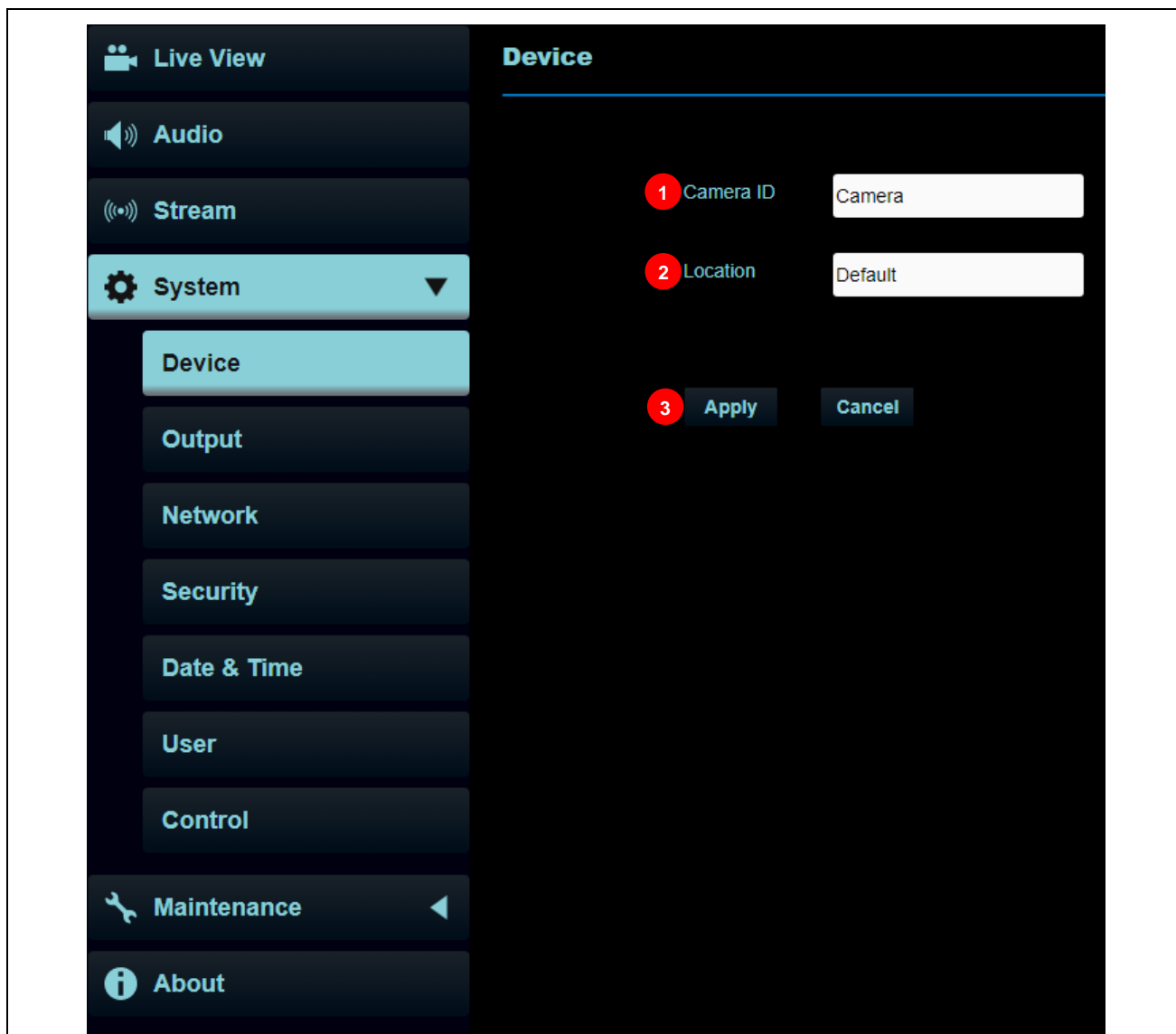

No	Item	Function Descriptions
1	Camera ID	<p>Change camera ID here</p> <ul style="list-style-type: none"> ■ Camera IDs are limited to 1 - 12 characters ■ Please mix uppercase and lowercase letters or numbers for characters. Special symbols such as “/” and “space” cannot be used <p><Remark> Modifying this field will modify the Onvif device name synchronously</p>
2	Location	<p>Modify the location of the camera, such as Room 1</p> <ul style="list-style-type: none"> ■ Camera location is limited to 1 - 11 characters ■ Please mix uppercase and lowercase letters or numbers for characters. Special symbols such as “/” and “space” cannot be used <p><Remark> Modifying this field will modify the Onvif device location synchronously</p>
3	Apply	After the setting has been modified, select this button to apply the setting

5.2.8 Setting - Audio

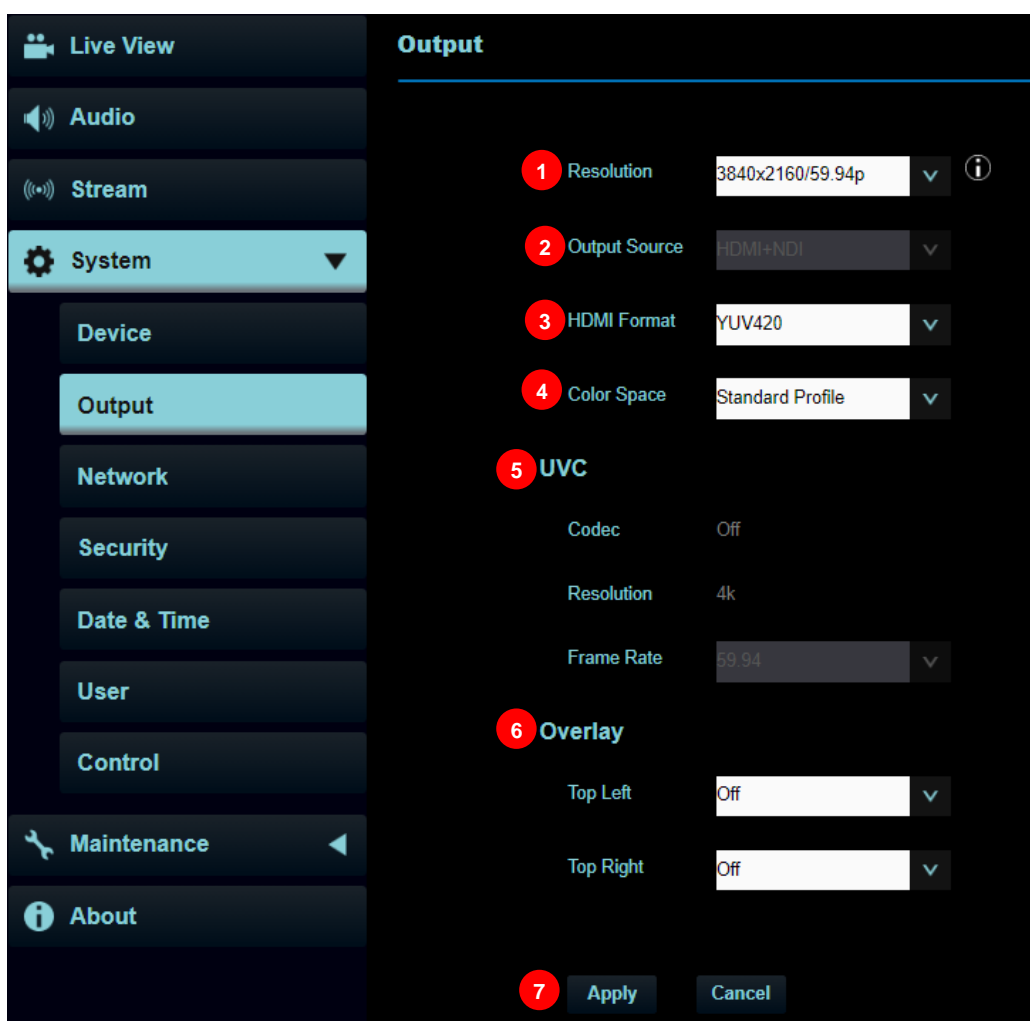

No	Item	Function Descriptions
1	Resolution	Set the resolution of the camera After switching the resolution, the camera will restart. Please refresh the browser
2	Output Source	According to the output protocol, you can select HDMI + Streaming, HDMI+NDI or HDMI + UVC output <Remark> When it is set to UVC output, 3840 x 2160 30p or lower resolutions are supported <Remark> 1080i does not support UVC
3	HDMI format	Select YUV422 / YUV420 / RGB <Remark> 3840x2160 59.94/50 resolutions are applicable to YUV420
4	Color Space	Set the standard for color space Standard Profile/REC.709/BT.2020
5	UVC	This can be set when <u>Settings - System Settings - Output Source</u> is set as HDMI + UVC <ul style="list-style-type: none"> ■ Encode Format: <ul style="list-style-type: none"> ➢ 3840 x 2160 29.97/25 fps: H.264 ➢ Less than 1080p (inclusive): H.264/MJPEG ■ Resolution: It is shown based on <u>Settings - System Settings - Resolution</u> Frame Rate: 3840 x 2160 can only select the highest 29.97 fps
6	Overlay	Set the stream to display “date and time” or “custom content” and to display location
7	Apply/Cancel	Apply/Cancel Setting

5.2.9 Setting - Network

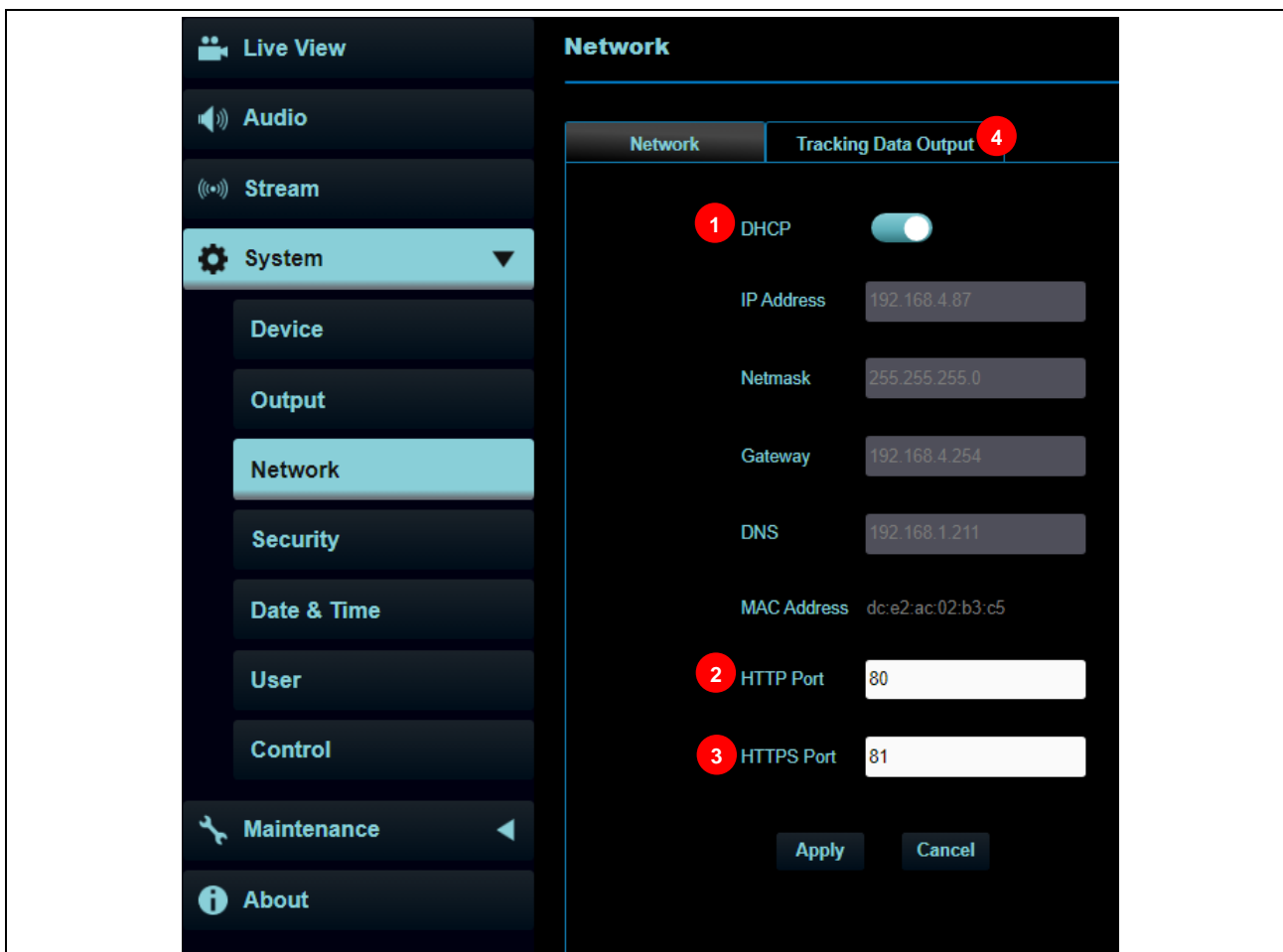

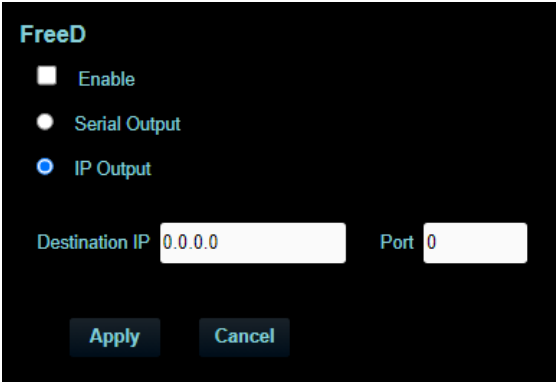
No	Item	Function Descriptions
1	DHCP	Network setting of camera. Change of setting is available when DHCP function is closed
2	HTTP port	Set HTTP port. The default Port value is 80
3	HTTPS port	Set HTTPS port. The default Port value is 81
4	Tracking Data Output	 <p>When enabled, PTZ position information can be reported when the camera moves</p> <ol style="list-style-type: none"> 1. Serial Output: Please set the protocol to VISCA and the baud rate to 38400 2. IP output: Set the destination IP address and port 3. The port numbers should be > 1024. 1935, 8555, 8556, 8557 cannot be used. <p><Remark> When Tracking Data Output is enabled, the camera performance may be affected.</p>

5.2.10 Setting - Maintenance - Security

Function Descriptions

Enable/disable 802.1x protocol, and configure settings when enabled
<Remark> The router must support 802.1x protocol to enable this feature

5.2.11 Settings - Date & Time

Function Descriptions

Display date and time of the current camera/ PC. You may set the synchronization method and modify date and time

5.2.12 Settings - User

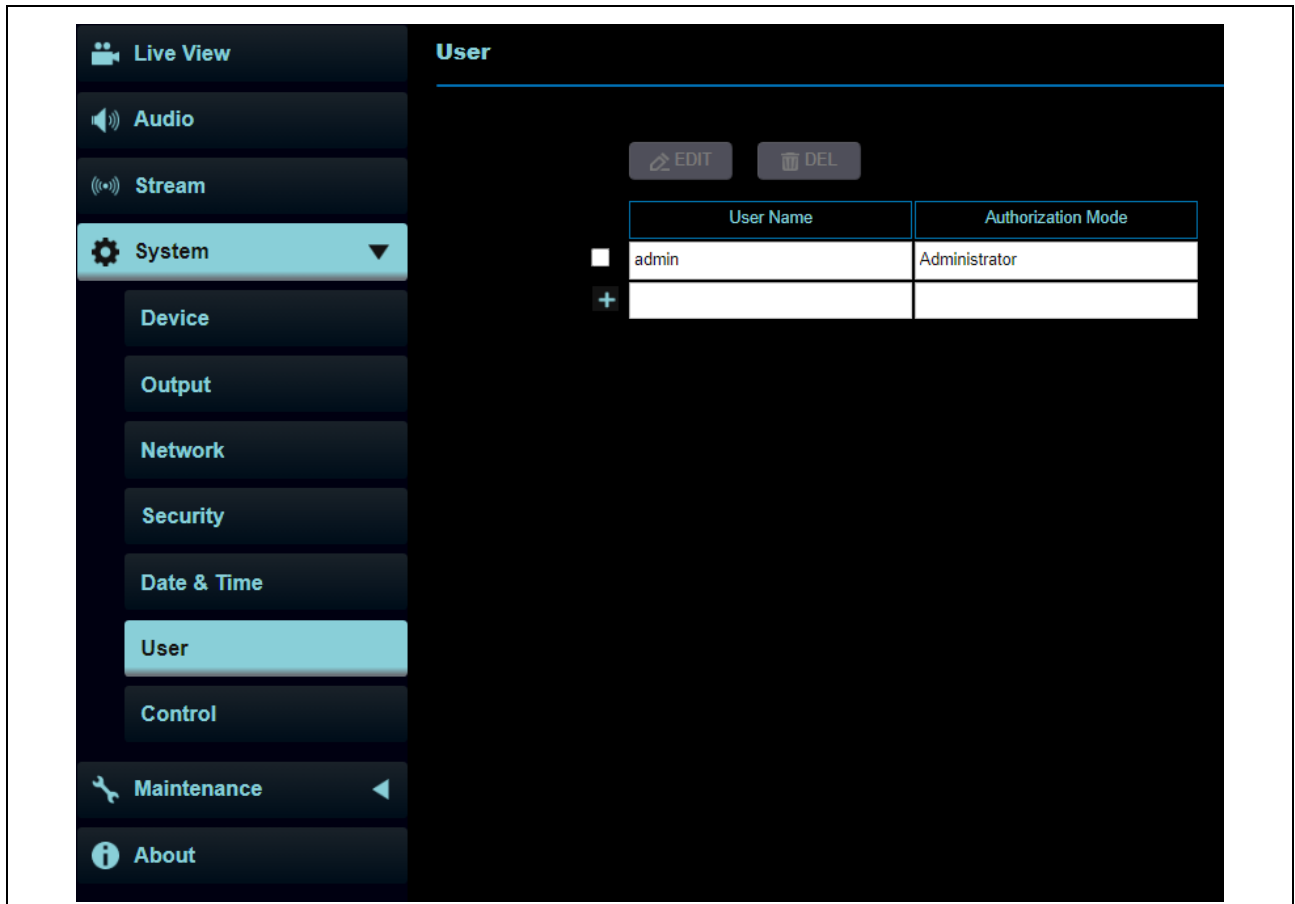

Function Descriptions

Add/ Modify/ Delete user account

- Supporting 4 ~ 32 characters for user name and password
- Please mix uppercase and lowercase letters or numbers for characters. Special symbols or the underlined cannot be used
- Authentication Mode: Set the new account management permissions

User Type	Admin	Operator	Viewer
View images	V	V	V
Settings	V	V	X
Account management	V	X	X

<Remark> When Factory Reset is executed, it will clear the user's data.

5.2.13 Settings – Control Port Number

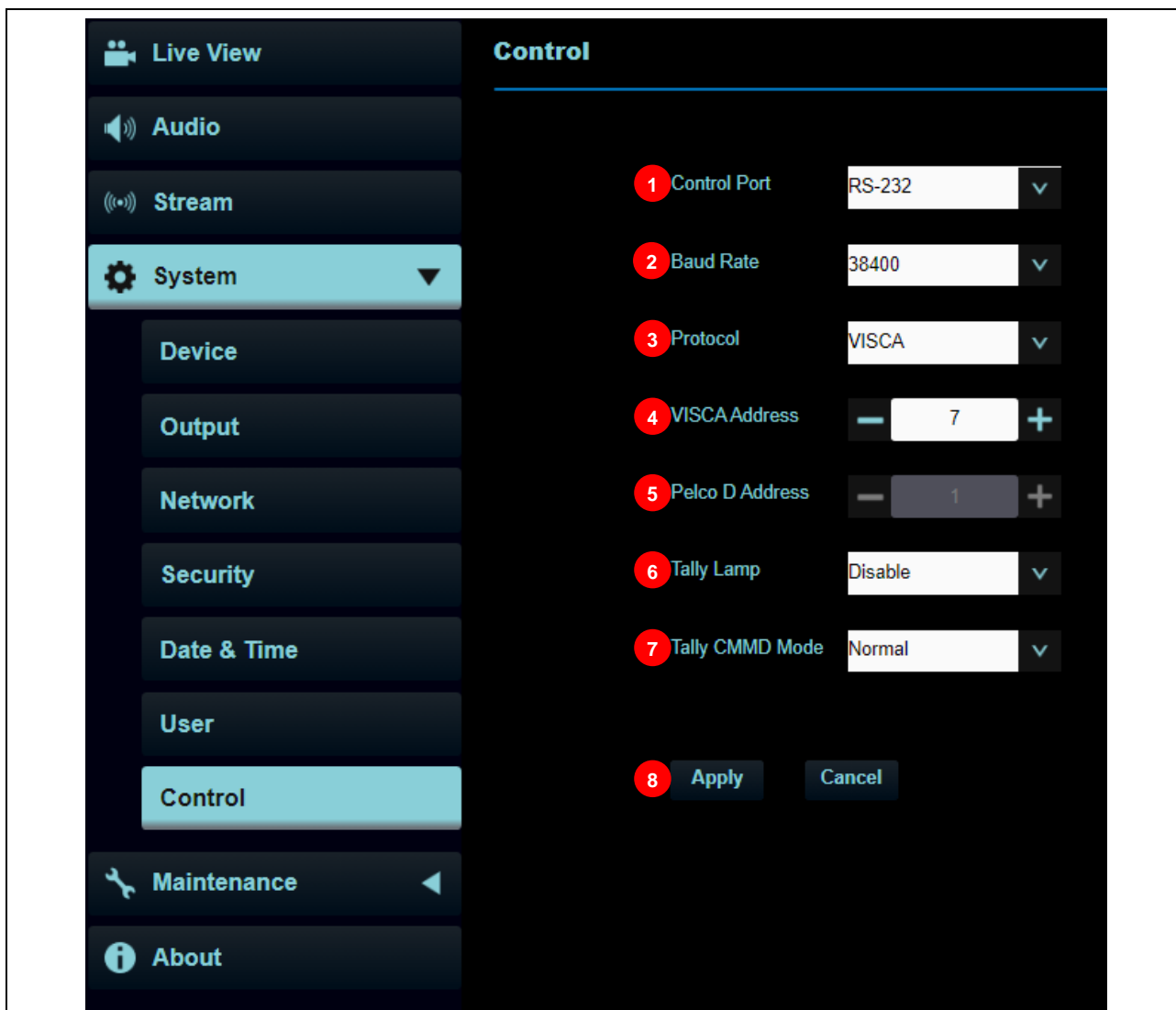

No	Item	Function Descriptions
1	Control Port	RS-232 / RS-422
2	Baud Rate	Choose the transmission speed of the control signal as 9600/38400
3	Protocol	VISCA/Pelco D protocol is supported
4	VISCA address	The camera ID address 0 ~ 7 can be assigned.
5	Pelco D address	The camera ID address 1 ~ 255 can be assigned.
6	Tally Lamp	Enable/Disable Tally Lamp
7	Tally CMMD Mode	<p>Set whether the indicator light is linked with RS232 command</p> <ul style="list-style-type: none"> ➤ General (Not linked): The indicator light switch and mode shall be set separately. <ul style="list-style-type: none"> - When the indicator light is on and the default mode is off, additional command is required to set the indicator light mode - Setting the indicator light mode when the indicator light is off will not trigger the indicator light ➤ Link: <ul style="list-style-type: none"> - When the indicator light is on, the default mode is red light - Setting the indicator light mode when the indicator light is off will turn on the indicator light
8	Apply/ Cancel	Apply/ Cancel Setting

5.2.14 Maintenance

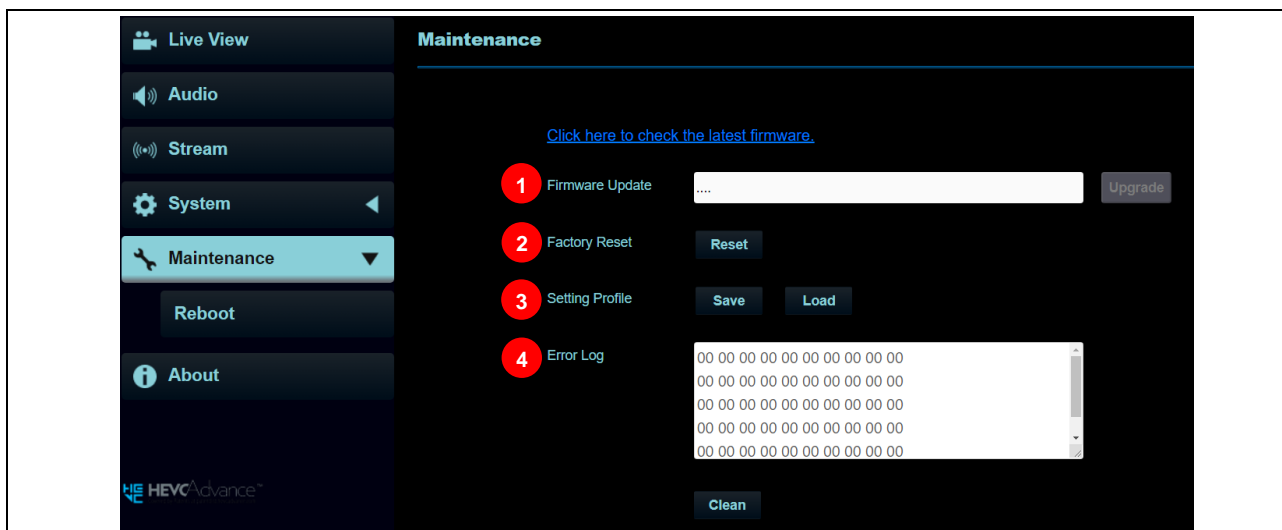

No	Item	Function Descriptions
1	Firmware Update	<ul style="list-style-type: none"> Click the link to check the latest firmware. Click [...] to select the firmware file, and click [Upgrade] to update the firmware <p><Remark> Update takes about 2 - 3 minutes <Remark> Please do not operate or turn off the power of the device during the update to avoid firmware update failure</p>
2	Factory Reset	Restore the factory default setting
3	System Settings	Save setup parameters, and users can download and upload camera setup parameters
4	Event Logs	If the camera encounters errors, an error code log will be established <Remark> When an error code appears, please try to click Clean to make sure whether the issue has occurred repetitively

5.2.15 Maintenance - Reboot

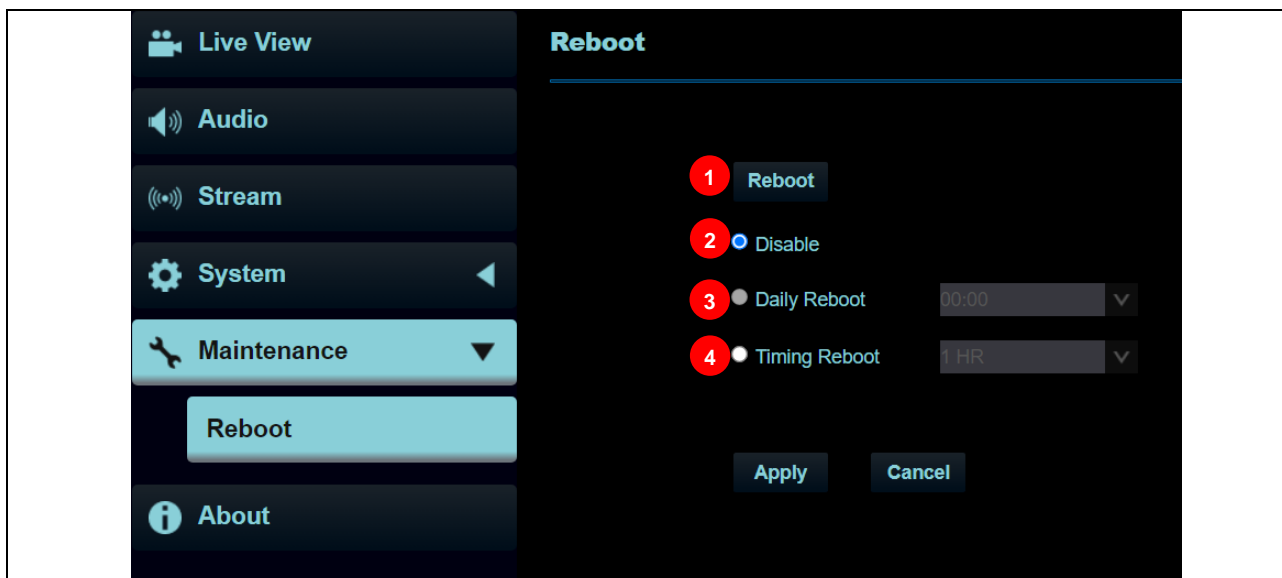

No	Item	Function Descriptions
1	Reboot	Reboot immediately
2	Disable	Disable the reboot settings
3	Daily reboot	Set the daily reboot time <Remark> Please go to Settings - Time to complete the SNTP server synchronization to set daily reboot
4	Timing Reboot	Set the timing reboot time

5.2.16 About

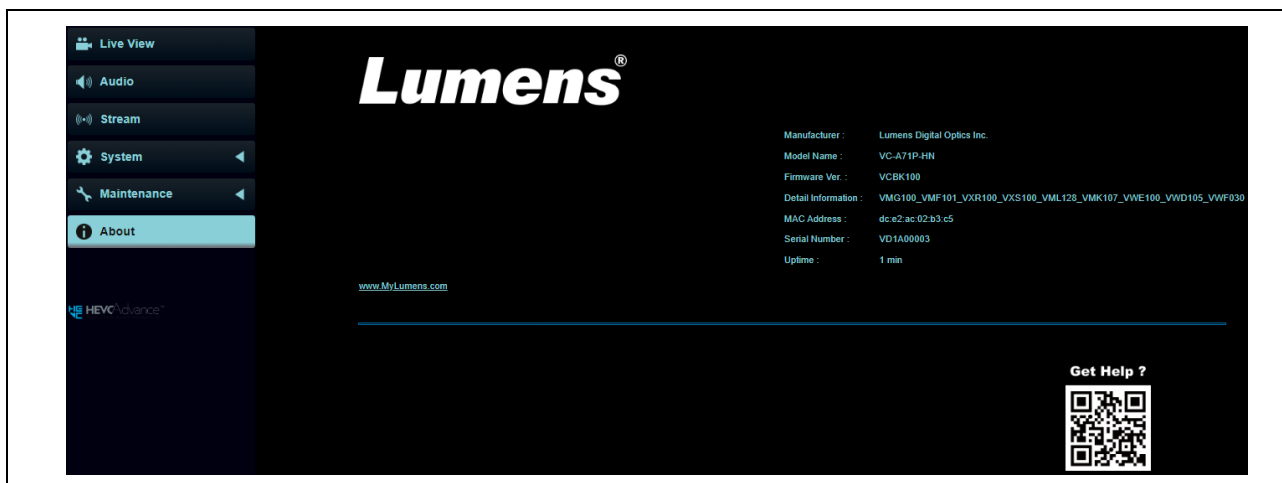

Function Descriptions

Display the firmware version, serial number, running time and other related information of the camera
For technical support, please scan the QRcode at the bottom right

Chapter 6 DIP Switch Setting

6.1 DIP SWITCH

6.1.1 OUTPUT Switch (Switch to different output resolutions)

To switch via the OSD/ Web Page/RS-232 Command is also available based on the last executed action

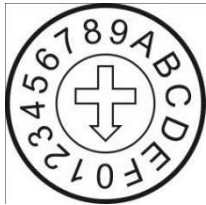

ID	Output Resolution	Frame Rate	Note
0	3840x2160p	59.94	<Remark> For 3G-SDI, 1080P output will be automatically adjusted <Remark> USB only supports resolutions lower than 3840 x 2160p 29.97
1		50	
2		29.97	
3		25	
4	1920x1080p	59.94	
5		50	
6		29.97	
7		25	
8	1280x720p	59.94	
9		50	
A		Reserved	
B		Reserved	
C	1920x1080i	59.94	
D		50	
E	Reserved	Reserved	
F			

6.1.2 IR SELECT (Selected by Remote control)

When using the remote control, please make sure the settings of IR SELECT and the Camera Select of the remote control are consistent



ID	Setting
1	
2	
3	



Chapter 7 Troubleshooting

This chapter describes problems you may encounter while using VC-A71P-HN. If you have questions, please refer to related chapters and follow all the suggested solutions. If the problem still occurred, please contact your distributor or the service center.

No.	Problems	Solutions
1.	Boot without power signal	<ol style="list-style-type: none"> 1. Make sure you have plugged in the power cord. 2. When using a PoE connection, ensure that the power supply supports PoE++ (IEEE802.3bt) hubs
2.	There is no image output from VC-A71P-HN	<ol style="list-style-type: none"> 1. Check the power supply or PoE supply functions. 2. Check the correct output source is selected by [System Setting] > [Output Setting] on the web page <ul style="list-style-type: none"> ▪ Streaming: HDMI + Streaming ▪ NDI: HDMI+NDI ▪ USB Output: HDMI + UVC 3. Confirm whether the camera resolution can be used together with the monitor equipment <ul style="list-style-type: none"> ▪ If 4k output, confirm the monitor equipment supports 4K output 4. Replace the cables and make sure they are not faulty.
3.	RS-232 cannot be controlled	<ol style="list-style-type: none"> 1. Confirm the connection is correct (RS-232 In/ Out) 2. Please make sure the Baud rate setting is the same as the control equipment
4.	Whether the Internet can be used for operation	Please refer to 5.2.9 Settings- Network for the Internet usage
5.	The ONVIF software cannot find the machine	<ol style="list-style-type: none"> 1. Please make sure that [Setting]> [Video]> [Camera Location] on the web page uses only English letters or numbers. The ONVIF software cannot find the machine if you use special characters and space. 2. Either NDI or ONVIF can be used. Please go to the [Setting] > [Video] > [NDI HX] on the web page to check if it is [Off].
6.	Tally lamp is not working when applying RS232 setting	<p>Please make sure if the Tally lamp function is enabled from the setting menu or web page.</p> <ul style="list-style-type: none"> ■ Setting Menu: [System] > [Tally Lamp] ■ Web page: [Setting] > [Camera] > [Tally Lamp]
7.	The camera does not save the relevant parameters (PTZ, AWB ...) after reboot	<p>Please make sure if the Initial Position is set to Last Operated Position from the setting menu or web page</p> <ul style="list-style-type: none"> ■ Setting Menu: [System] > [Initial Position] ■ Web page: [Setting] > [Camera] > [Pan Tilt Zoom]
8.	Tracking Data Output is delayed or not updated	<p>Please confirm that the camera is not in the following status</p> <p>The following function settings may cause data output to be delayed or not updated:</p> <ul style="list-style-type: none"> - Modify output resolution - Modify camera mode - Modify HDMI format - Turn on the setting menu - Streaming Setting - Audio Source Setting
9.	With LC100N device, VC-A71P-HN cannot be found by NDI	LC100N only supports the cameras the NDI HX2-source camera. Please go to [Streaming] > [NDI] > [NDI HX] on the web page to check the HX2 output is set

Chapter 8 Safety Instructions

Always follow these safety instructions when setting up and using the VC-A71P-HN PTZ Video Camera:

1 Operation

- 1.1 Please use the product in the recommended operating environment, away from water or source of heat
- 1.2 Do not place the product on a tilted or unstable trolley, stand or table.
- 1.3 Please clean the dust on the power plug prior to usage. Do not insert the product's power plug into a multiplug to prevent sparks or a fire.
- 1.4 Do not block the slots and openings in the case of the product. They provide ventilation and prevent the product from overheating.
- 1.5 Do not open or remove covers, otherwise it may expose you to dangerous voltages and other hazards. Refer all servicing to licensed service personnel.
- 1.6 Unplug the product from the wall outlet and refer servicing to licensed service personnel when the following situations happen:
 - If the power cords are damaged or frayed.
 - If liquid is spilled into the product or the product has been exposed to rain or water.

2 Installation

- 2.1 For security considerations, please make sure the standard mount you use is in line with UL or CE safety approbations and installed by technician personnel approved by agents.

3 Storage

- 3.1 Do not place the product where the cord can be stepped on as this may result in fraying or damage to the lead or the plug.
- 3.2 Unplug this product during thunderstorms or if it is not going to be used for an extended period.
- 3.3 Do not place this product or accessories on top of vibrating equipment or heated objects.



4 Cleaning

- 4.1 Disconnect all the cables prior to cleaning and wipe the surface with a dry cloth. Do not use alcohol or volatile solvents for cleaning.

5 Batteries (for products or accessories with batteries)

- 5.1 When replacing batteries, please only use similar or the same type of batteries
- 5.2 When disposing of batteries or products, please adhere to the relevant instructions in your country or region for disposing of batteries or products

■ Precautions

	This symbol indicates that this equipment may contain dangerous voltage which could cause electric shock. Do not remove the cover (or back). No user-serviceable parts inside. Refer servicing to licensed service personnel.		This symbol indicates that there are important operating and maintenance instructions in this User Manual with this unit.
---	---	--	---

■ FCC Warning

This equipment has been tested and found to comply with the limits for a Class A digital device, pursuant to part 15 of the FCC Rules. These limits are designed to provide reasonable protection against harmful interference when the equipment is operated in a commercial environment.

Notice :

The changes or modifications not expressly approved by the party responsible for compliance could void the user's authority to operate the equipment.

本設備符合 FCC 規則第 15 部分的規定。本設備已經過測試，符合 A 類設備的限制。這些限制旨在為在商業環境操作設備提供合理的保護，以防止有害干擾。

■ IC Warning

This digital apparatus does not exceed the Class A limits for radio noise emissions from digital apparatus as set out in the interference-causing equipment standard entitled "Digital Apparatus," ICES-003 of Industry Canada.

Cet appareil numérique respecte les limites de bruits radioélectriques applicables aux appareils numériques de Classe A prescrites dans la norme sur le matériel brouilleur: "Appareils Numériques," NMB-003 édictée par l'Industrie.

■ EN55032 CE Warning

Operation of this equipment in a residential environment could cause radio interference.

警告：本設備在居住環境中使用可能會導致無線電干擾

Supplier's Declaration of Conformity 47 CFR § 2.1077 Compliance Information

Manufacturer : Lumens Digital Optics Inc.

Product Name : VC-A71P-HN

Model Number : PTZ Video Camera

Responsible Party – U.S. Contact Information

Supplier : Lumens Integration, Inc.

4116 Clipper Court, Fremont, CA 94538, United States

e-mail : support@mylumens.com

FCC Compliance Statement

This device complies with Part 15 of the FCC Rules. Operation is subject to the following two conditions : (1) This device may not cause harmful interference, and (2) this device must accept any interference received, including interference that may cause undesired operation.

Copyright Information

Copyrights © Lumens Digital Optics Inc. All rights reserved.

Lumens is a trademark that is currently being registered by Lumens Digital Optics Inc.

Copying, reproducing or transmitting this file is not allowed if a license is not provided by Lumens Digital Optics Inc. unless copying this file is for the purpose of backup after purchasing this product.

In order to keep improving the product, the information in this file is subject to change without prior notice.

To fully explain or describe how this product should be used, this manual may refer to names of other products or companies without any intention of infringement.

Disclaimer of warranties: Lumens Digital Optics Inc. is neither responsible for any possible technological, editorial errors or omissions, nor responsible for any incidental or related damages arising from providing this file, using, or operating this product.