

# VC-A71P/VC-A71PN

## 4K PTZ Video Camera

### User Manual - English

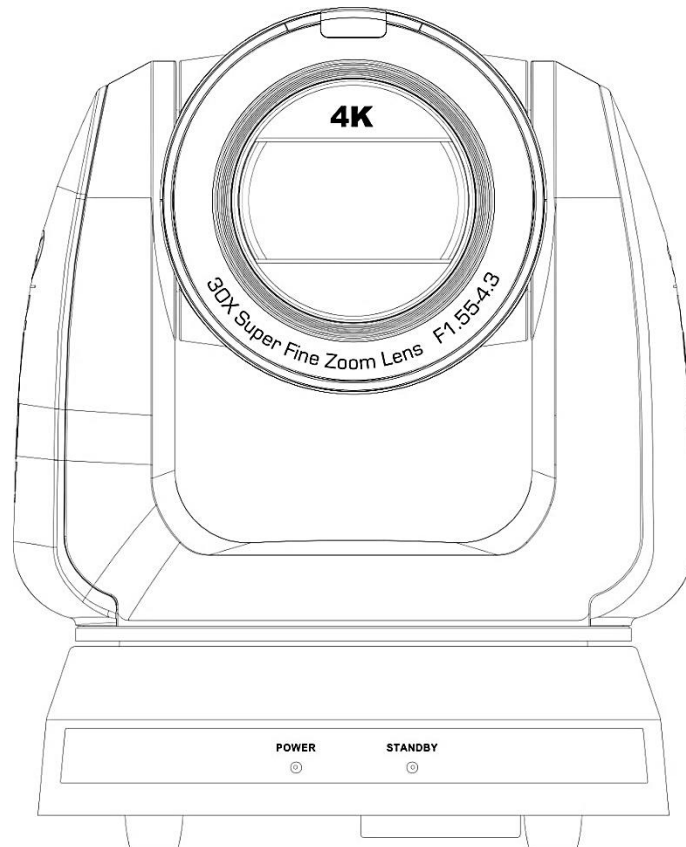

To download the latest version of Quick Start Guide, multilingual user manual, software, or driver, etc., please visit Lumens

<https://www.MyLumens.com/support>

# Table of Contents

Copyright Information .....	2
Chapter 1 Safety Instructions.....	3
Chapter 2 Package Contents .....	4
Chapter 3 Function Introduction .....	5
3.1 I/O functions Introduction.....	5
3.2 Description of LED indicator.....	7
3.3 Tally Lamp Function Description.....	7
Chapter 4 Instruction for installation.....	8
4.1 Camera dimension:.....	8
4.2 Preparation before installation .....	9
4.3 Instruction for installation.....	9
4.4 Connecting devices .....	14
Chapter 5 Remote Control and Setting Menu .....	17
5.1 Functions of remote control .....	17
5.2 Setting Menu .....	18
Chapter 6 Network Function Settings Description .....	27
6.1 Connecting Camera to Network.....	27
6.2 Web Page Function Description .....	30
Chapter 7 DIP Switch Setting .....	46
7.1 DIP SWITCH.....	46
Chapter 8 Troubleshooting.....	47
Supplier's Declaration of Conformity 47 CFR § 2.1077 Compliance Information.....	49

# Copyright Information

---

Copyrights © Lumens Digital Optics Inc. All rights reserved.

Lumens is a trademark that is currently being registered by Lumens Digital Optics Inc.

Copying, reproducing or transmitting this file is not allowed if a license is not provided by Lumens Digital Optics Inc. unless copying this file is for the purpose of backup after purchasing this product.

In order to keep improving the product, Lumens Digital Optics Inc. hereby reserves the right to make changes to product specifications without prior notice. The information in this file is subject to change without prior notice.

To fully explain or describe how this product should be used, this manual may refer to names of other products or companies without any intention of infringement.

Disclaimer of warranties: Lumens Digital Optics Inc. is neither responsible for any possible technological, editorial errors or omissions, nor responsible for any incidental or related damages arising from providing this file, using, or operating this product.

# Chapter 1 Safety Instructions

Always follow these safety instructions when using the product:

## 1 Operation

- 1.1 Please use the product in the recommended operating environment, away from water or source of heat.
- 1.2 Do not place the product in tilted position or unstable trolley, stand or table.
- 1.3 Please clean the dust on the power plug prior to usage. Do not insert the product's power plug into a multiplug to prevent sparks or a fire.
- 1.4 Do not block the slots and openings in the case of the product. They provide ventilation and prevent the product from overheating.
- 1.5 Do not open or remove covers, otherwise it may expose you to dangerous voltages and other hazards. Refer all servicing to licensed service personnel.
- 1.6 Unplug the product from the wall outlet and refer servicing to licensed service personnel when the following situations happen:
  - If the power cords are damaged or frayed.
  - If liquid is spilled into the product or the product has been exposed to rain or water.

## 2 Installation

- 2.1 For security considerations, please make sure the standard hanging rack you bought is in line with UL or CE safety approbations and installed by technician personnel approved by agents.

## 3 Storage

- 3.1 Do not place the product where the cord can be stepped on as this may result in fraying or damage to the lead or the plug.
- 3.2 Unplug the product during thunderstorms or if it is not going to be used for an extended period.
- 3.3 Do not place the product or accessories on top of vibrating equipment or heated objects.



## 4 Cleaning

- 4.1 Disconnect all the cables prior to cleaning and wipe the surface with a dry cloth. Do not use alcohol or volatile solvents for cleaning.

## 5 Batteries (for products or accessories with batteries)

- 5.1 When replacing batteries, please only use similar or the same type of batteries.
- 5.2 When disposing of batteries or products, please adhere to the relevant instructions in your country or region for disposing of batteries or products.

## ■ Precautions

	This symbol indicates that this equipment may contain dangerous voltage which could cause electric shock. Do not remove the cover (or back). No user-serviceable parts inside. Refer servicing to licensed service personnel.		This symbol indicates that there are important operating and maintenance instructions in this User Manual with this unit.
---	---	---	---

## ■ FCC Warning

This equipment has been tested and found to comply with the limits for a Class A digital device, pursuant to part 15 of the FCC Rules. These limits are designed to provide reasonable protection against harmful interference when the equipment is operated in a commercial environment.

Notice :

The changes or modifications not expressly approved by the party responsible for compliance could void the user's authority to operate the equipment.

## ■ IC Warning

This digital apparatus does not exceed the Class A limits for radio noise emissions from digital apparatus as set out in the interference-causing equipment standard entitled "Digital Apparatus," ICES-003 of Industry Canada.  
Cet appareil numérique respecte les limites de bruits radioélectriques applicables aux appareils numériques de Classe A prescrites dans la norme sur le matériel brouilleur: "Appareils Numériques," NMB-003 édictée par l'Industrie.

## ■ EN55032 CE Warning

Operation of this equipment in a residential environment could cause radio interference.

## ■ KC Warning

This equipment is Industrial (Class A) electromagnetic wave suitability equipment and seller or user should take notice of it, and this equipment is to be used in the places except for home.

# Chapter 2 Package Contents

**VC-A71P/VC-A71PN**

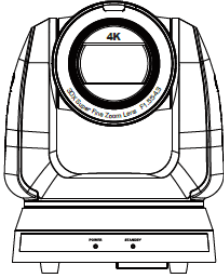

**Instruction for installation**



**Remote Control**



**Power Cord**

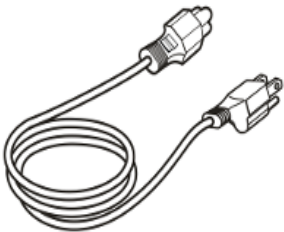

Appearance may vary depending on country/region

**Power Adapter**

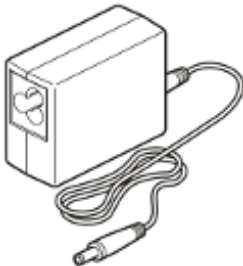

**RS-422 Connector**

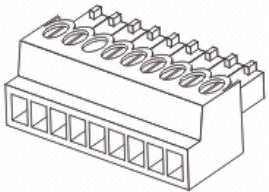

**Metal Plate A**

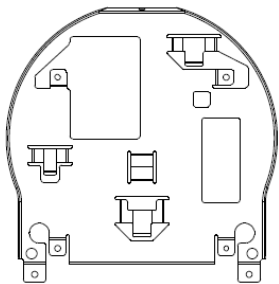

**Metal Plate B**

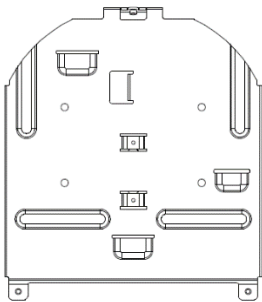

**M3 Screws**

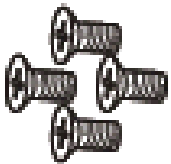

Silver x8 / Black x2

# Chapter 3 Function Introduction

## 3.1 I/O functions Introduction

### 3.1.1 Front View

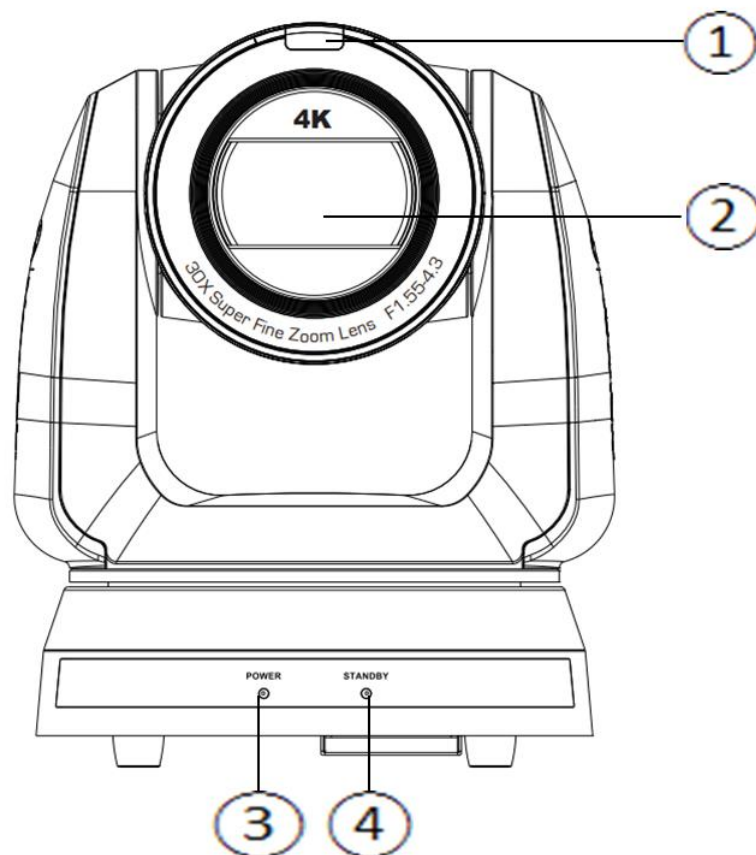

NO.	Item	Function Descriptions
1.	Tally indicator light	Display the tally light status of the camera
2.	Camera lens	30x HD camera lens
3.	Power LED indicator	Display the status of the camera, please refer to <a href="#">3.2 Description of LED indicator</a>
4.	Standby LED indicator	Display the status of the camera, please refer to <a href="#">3.2 Description of LED indicator</a>

### 3.1.2 Back View

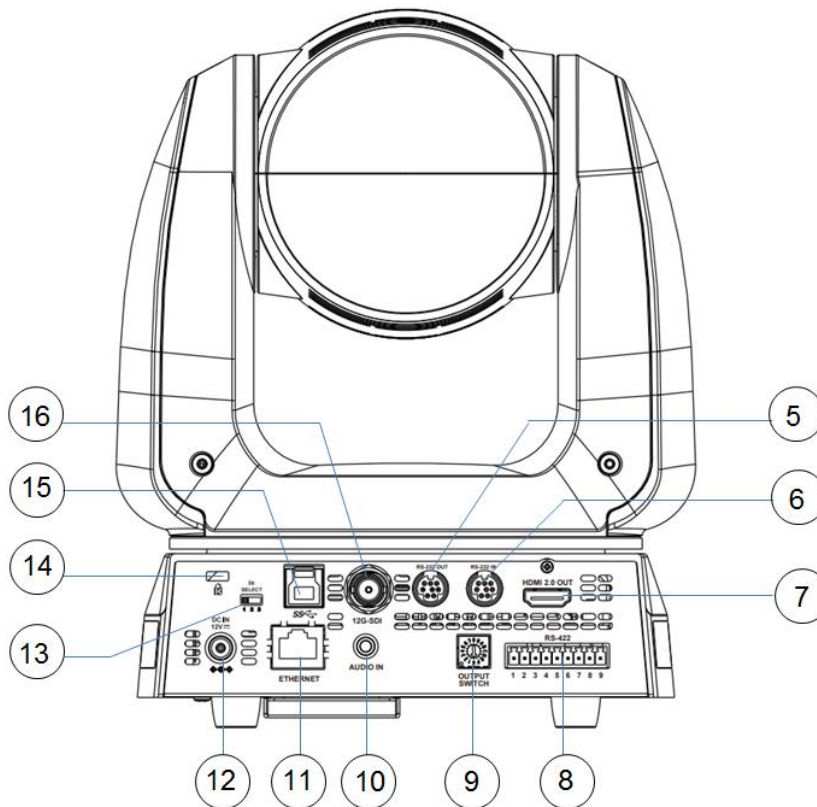

**<Remark> The figure is an example of VC-A71P. VC-A71PN does not support SDI output and USB.**

NO.	Item	Function Descriptions
5.	RS-232 output	RS-232 output port, at most 7 cameras can be connected in a serial connection
6.	RS-232 input	RS-232 input port, at most 7 cameras can be connected in a serial connection
7.	HDMI 2.0 output	HDMI 2.0 output (Audio output supported)
8.	RS-422 port	RS-422 connecting port, at most 7 cameras can be connected in a serial connection
9.	OUTPUT SWITCH	Adjust the resolution setting. The default is 3840 x 2160/59.94p
10.	Audio input	Support Line In/Mic In
11.	Network port	Network port, supporting routers or hubs with power supply <ul style="list-style-type: none"> <li>■ VC-A71P : PoE++ (IEEE802.3bt)</li> <li>■ VC-A71PN : PoE+ (IEEE802.3at)</li> </ul>
12.	DC 12 V power connector	AC power supply connecting port
13.	IR SELECT	The remote control ID setting is only controlled after corresponding to the Camera Select on the remote control
14.	Kensington lock hole	Safety lock slot
15.	USB 3.0 port	A reserved hole. The current firmware does not support this function. Please refer to the firmware update information on the webpage for the official release schedule. <b>&lt;Remark&gt;</b> Support up to 3840 x 2160/29.97p <b>&lt;Remark&gt;</b> VC-A71PN does not support this output port.
16.	12G-SDI output	12G-SDI output (Audio output supported) <b>&lt;Remark&gt;</b> VC-A71PN does not support this output port.

### 3.1.3 Bottom

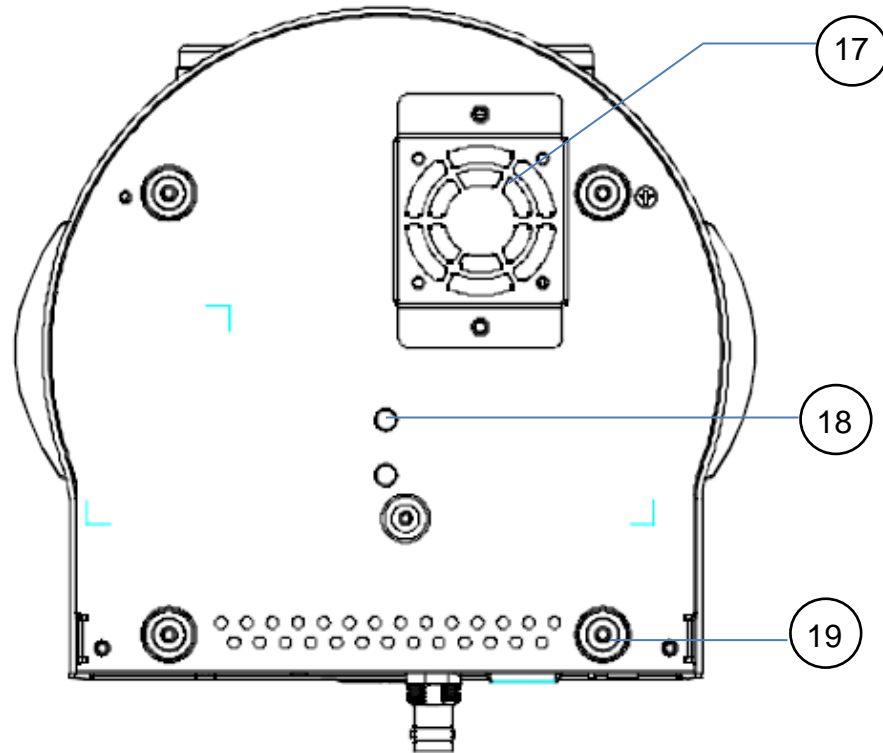

NO.	Item	Function Descriptions
17.	Mute cooling fan	The cooling fan automatically controls its rotation speed and performs cooling in cope with the operation temperature of the machine <Remark>The cooling fan is not available on VC-A71PN.
18.	Tripod deck lock hole	The camera is mounted on a (specification) 1/4" - 20 UNC tripod
19.	Rotatable foot pad	When using the metal plates of accessories, remove 4 pieces of rotatable food pads on the bottom by rotating counterclockwise, and then install the mental plates

### 3.2 Description of LED indicator

Status	Power	Standby
Startup in progress (initialization)	Green light	Orange light
In use	Green light	No indicator
In standby mode	No indicator	Orange light

### 3.3 Tally Lamp Function Description

3.3.1 Tally Lamp function may be enabled through the control of RS-232 command. The setting method is as follows:

Tally Mode: 8x 01 7E 01 0A 01 0p FF

p = 0: OFF

p = 4: Red light (half-brightness)

p = 5: Red light (full-brightness)

p = 6: Green light (full-brightness)

p = 7: Orange light (full-brightness)



# Chapter 4 Instruction for installation

## 4.1 Camera dimension:

### 4.1.1.1 Camera front view and side view

- Length x width x height: 232 x 188 x 189 mm
- Weight: 3.0Kg (excluding the metal plate)

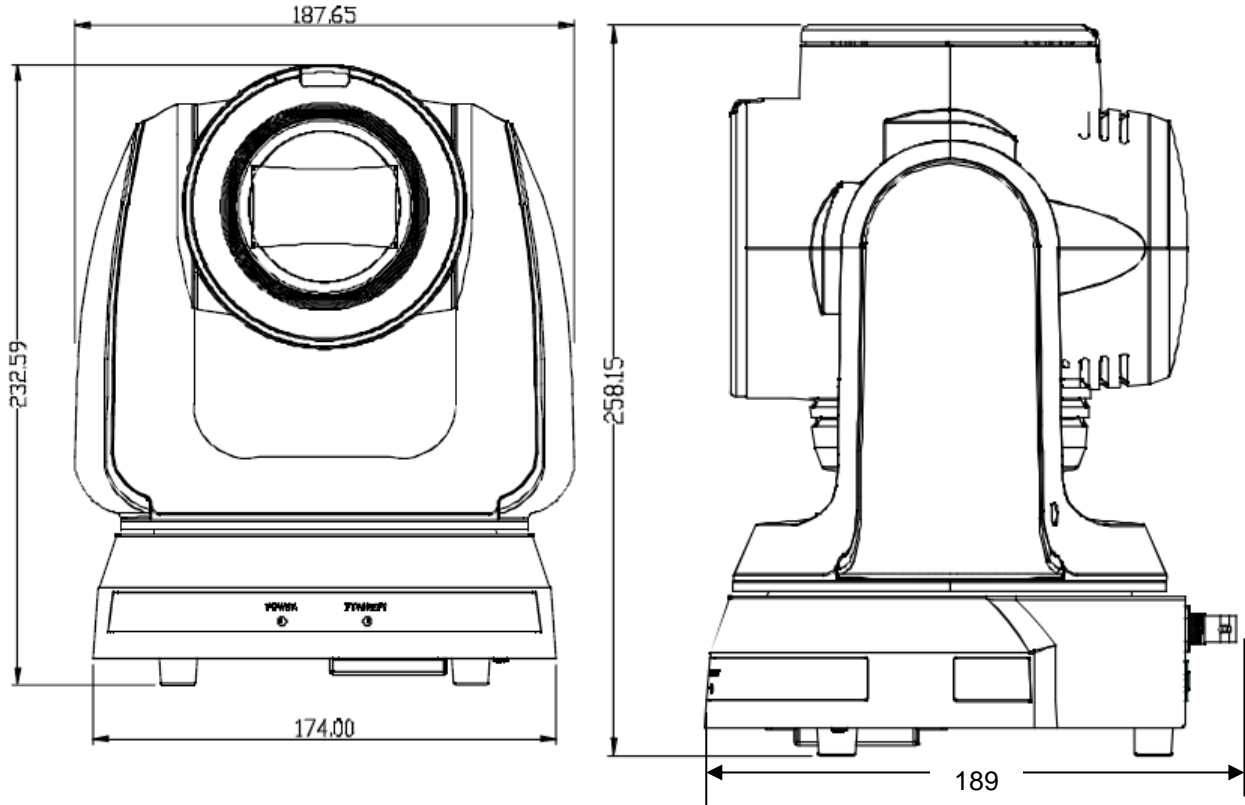

### 4.1.1.2 Camera base

The camera base has tripod mount lock holes and can be installed on the tripod deck of a standard specification 1/4"-20 UNC.

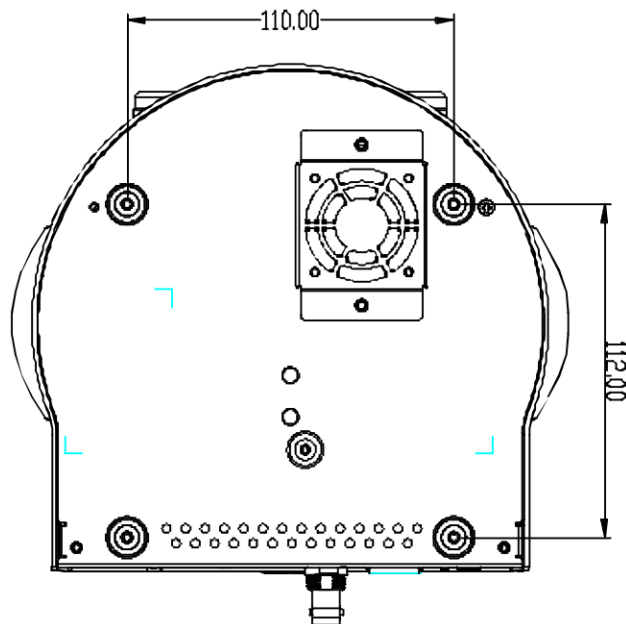

## 4.2 Preparation before installation

Installation and connection of the HD camera requires special skills. To install by yourself, please follow necessary steps, ensure steady and tight installation of the device, and pay attention to your safety to avoid any accident.

- 4.2.1 Ensure the safety of the installation environment. Please do not install the device on unstable ceiling or in a place where the device is in danger of falling to avoid any accident.
- 4.2.2 Please check whether accessories in the box are complete or not. Please contact the supplier for any shortage, and make sure to keep the accessories in the box intact.
- 4.2.3 Please choose a proper place for installation of camera in advance. Please determine an installation place according to the following requirements
  - 4.1.1.1 Confirm the position for the object to be captured.
  - 4.1.1.2 Confirm whether the camera is set at a proper distance from other light sources.

## 4.3 Instruction for installation

4.3.1 I would like to install camera on the desk

4.3.1.1 Precautions for installation

- ◆ Please install the machine on a flat desk
- ◆ Do not grab the camera head by hand when handling the device
- ◆ Do not rotate the camera head by hand. Improper rotation may result in breakdown of the camera

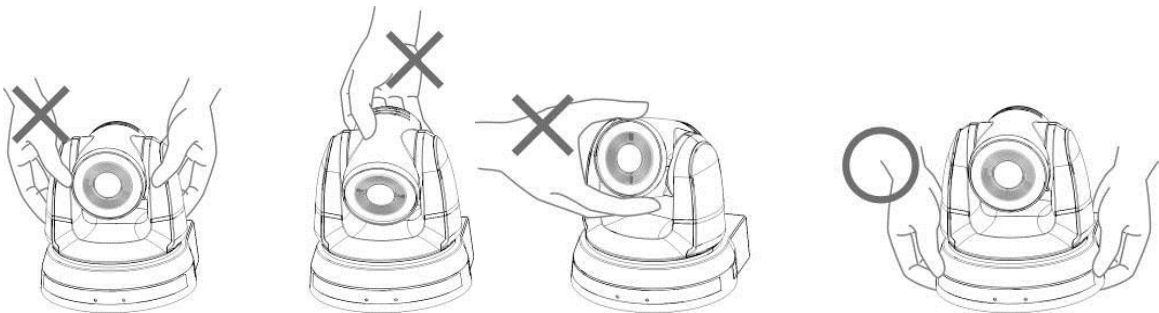

4.3.1.2 Installation steps

1. Place the camera on a flat desk directly to ensure the normal vertical and horizontal operation of the machine

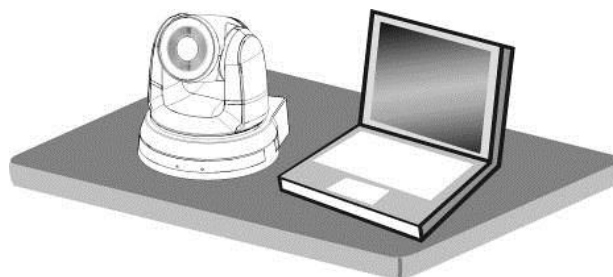

### 4.3.2 I would like to install the camera on the ceiling

4.3.2.1 Prepare for the parts and equipment required during the installation

1. Accessories in the box (metal plates A, B, M3 screw silver x 8, black x 2)
2. Screw for locking on ceiling mounted hanger x 4
3. Drilling machine, screw driver, ladder

#### 4.3.2.2 Metal Plate size diagram

- Metal plate A - machine side

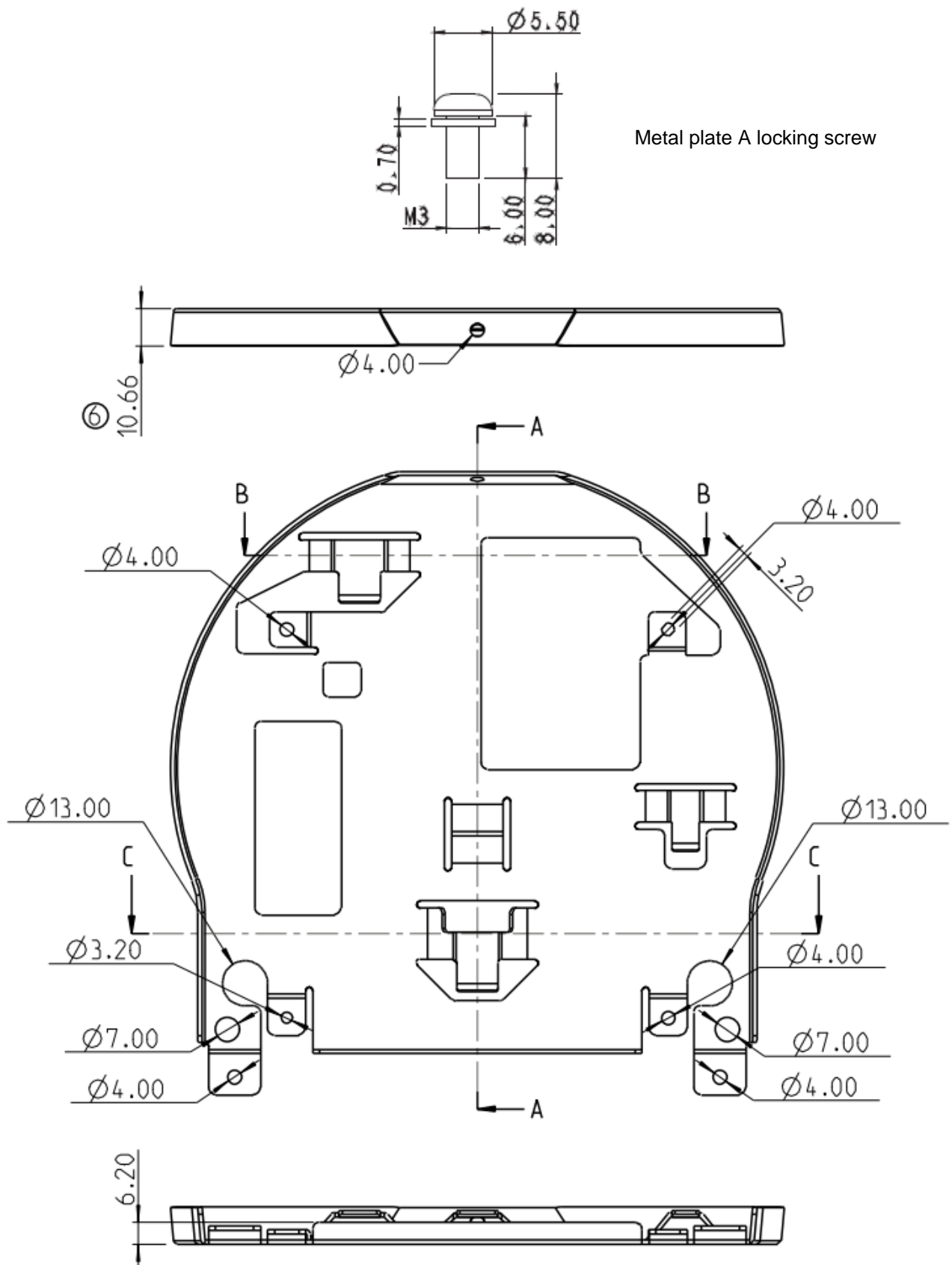

Metal plate A locking screw

Metal plate A - machine side

■ Metal plate B - ceiling side

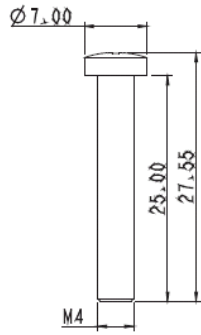

Metal plate B locking screw

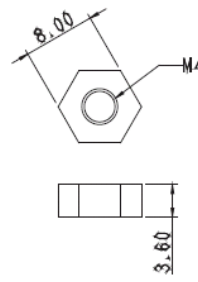

Metal plate B locking bolt

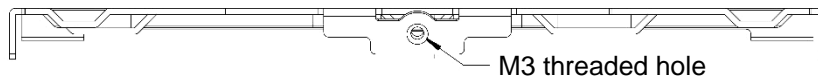

M3 threaded hole

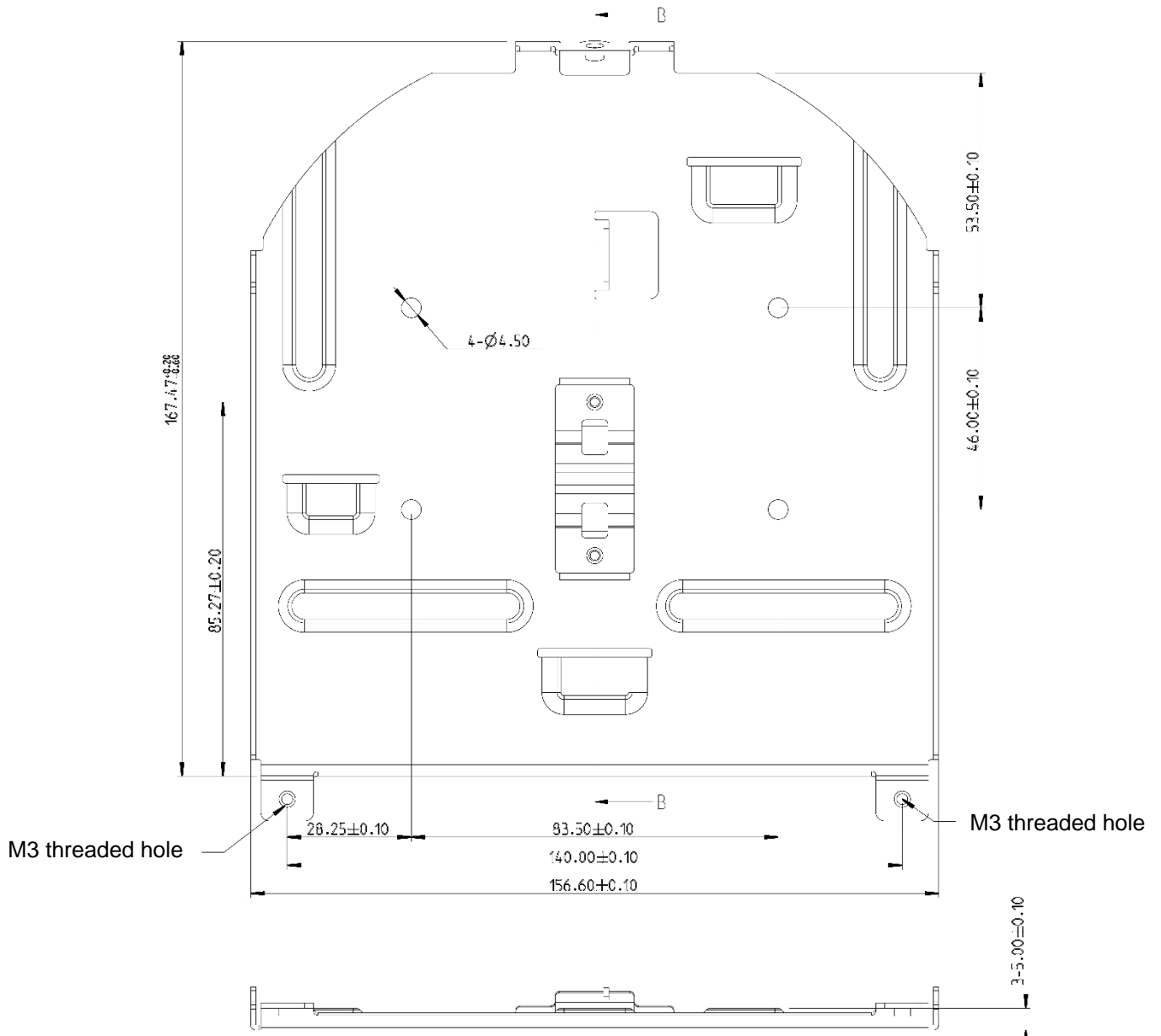

Metal plate B - ceiling side

#### 4.3.2.3 Precautions for installation

1. Before installation, please confirm the orientation of the machine relative to the object to be captured
2. It is recommended that the machine should be set at a distance of more than 2 meter away from the object to be captured. Please adjust for a best distance according to the magnification of the lens

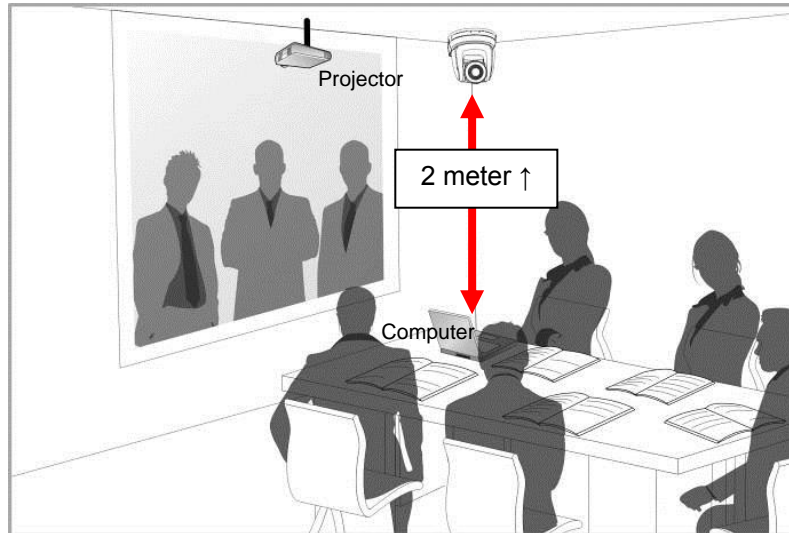

3. The machine (including metal plates) is weighed at about **3 kg**. If it is to be installed on the ceiling, please use the hanger that has obtained UL security approval to prevent the machine from falling down.
4. Please check whether the camera is installed securely on a regular basis.
5. Please clean the cooling fan located at the bottom to ensure the good heat dissipation effect of the machine on a regular basis.

#### 4.3.2.4 Installation steps

1. Remove 4 pieces of foot pads on the bottom of the camera by rotating the foot pads counterclockwise.

**<Remark>** Please keep the foot pads properly after removal and store them for future use.

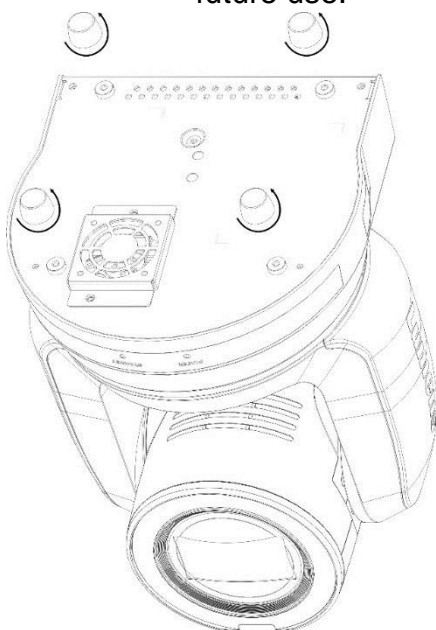

2. Fix the metal plate A on the machine base with 4 M3 silver screws

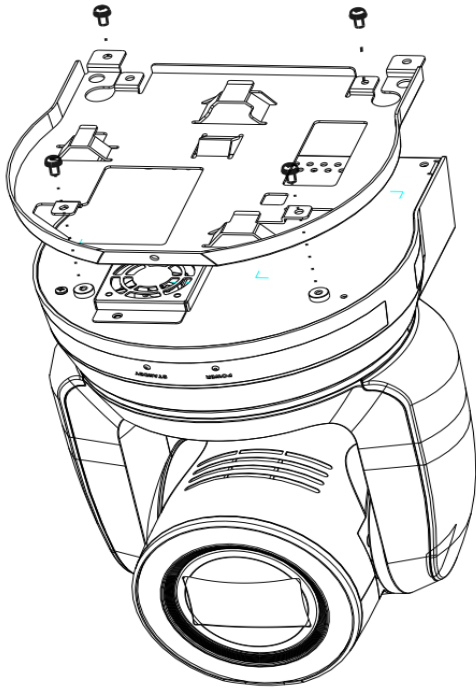

3. Lock the metal plate B on ceiling mounted hanger

**<Caution>:**

- (1) Please use the hanger that has obtained UL security approval
- (2) Please reserve the hole for the connecting wires of the camera

4. Combine the metal plate A and the metal plate B

- (1) Push the metal plate A up to the ceiling and then to the right to latch the metal plate B
- (2) And then secure with 2 M3 silver screws and 1 M3 black screw

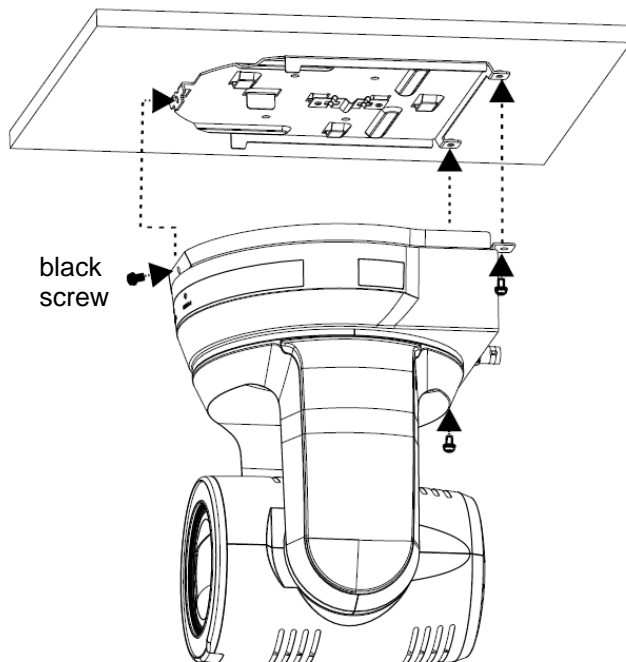

#### 4.3.2.5 How to remove

1. Remove the connecting wires from the camera
2. Uninstall the camera together with the ceiling, loosen the three screws that fix the metal plates A and B and push to the left to remove the machine
3. Then remove the screws on the hanger and the machine

### 4.4 Connecting devices

#### 4.4.1 Connecting RS-232

With RS-232 in/out, at most 7 Lumens cameras can be connected.

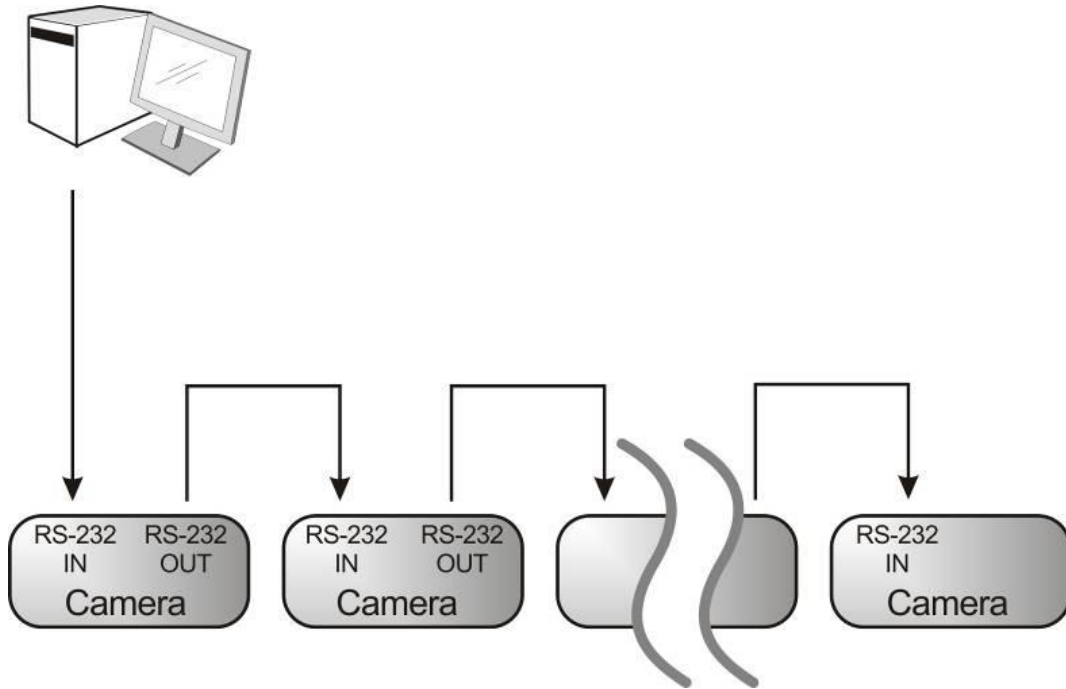

#### ■ RS-232 pins definition instructions

##### ▼ RS-232 IN Pins Instructions

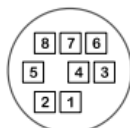

NO	Pins	Signals
1	DTR	Data Transmission Reade
2	DSR	Data Set Reade
3	TXD	Transmit Data
4	GND	Ground
5	RXD	Receive Data
6	GND	Ground
7	IR OUT	IR Commander Signal
8	N.C.	No Connection

##### ▼ RS-232 OUT Pins Instructions

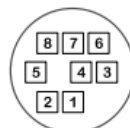

NO	Pins	Signals
1	DTR	Data Transmission Reade
2	DSR	Data Set Reade
3	TXD	Transmit Data
4	GND	Ground
5	RXD	Receive Data
6	GND	Ground
7	OPEN	Reserved
8	OPEN	Reserved

##### ▼ RS-232 Connection Instructions

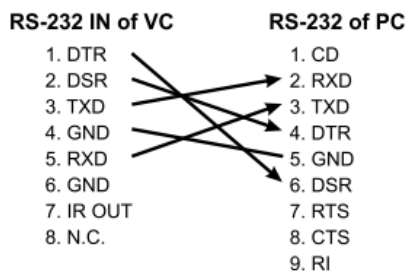

##### ▼ RS-232 Connection Instructions

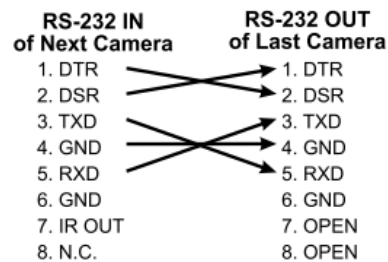

#### 4.4.2 Connecting RS-422

With RS-422, at most 7 Lumens cameras can be connected.

**<Caution> When RS-422 connection is being used, do not use RS-232 connection.**

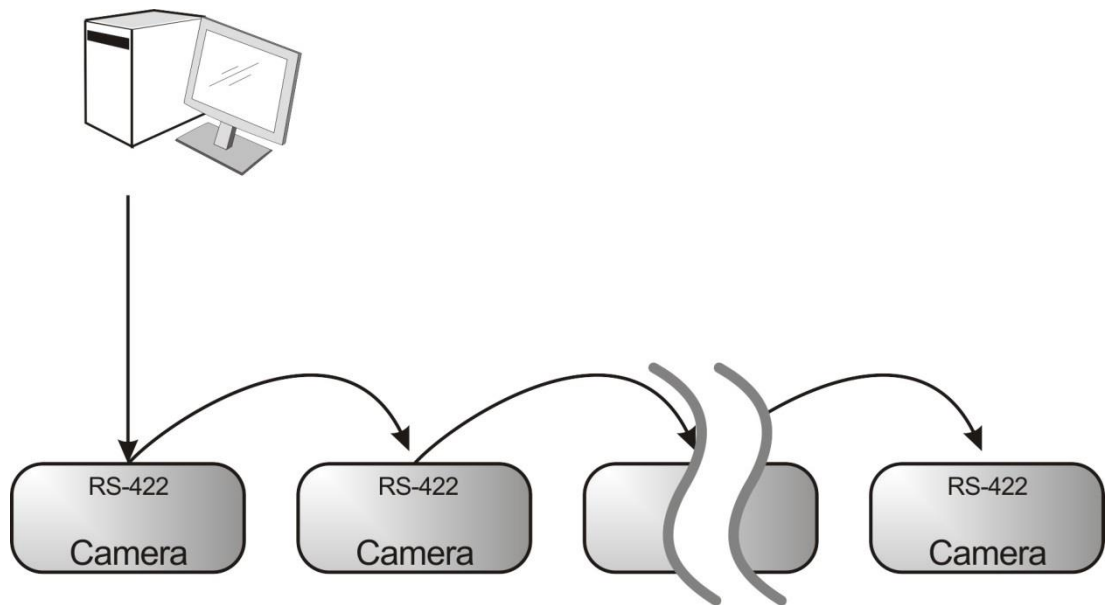

#### ■ RS-422 pins definition instructions

##### ▼ RS-422 Pins Instructions

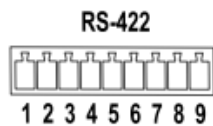

Pin NO.	Function
1	RXD OUT-
2	RXD OUT+
3	TXD OUT-
4	TXD OUT+
5	GND
6	RXD IN-
7	RXD IN+
8	TXD IN-
9	TXD IN+

##### ▼ RS-422 Serial Connection

Up to seven cameras can be daisy-chained

⋮

Third Camera

1	RXD OUT-
2	RXD OUT+
3	TXD OUT-
4	TXD OUT+
5	GND
6	RXD IN-
7	RXD IN+
8	TXD IN-
9	TXD IN+

Second Camera

1	RXD OUT-
2	RXD OUT+
3	TXD OUT-
4	TXD OUT+
5	GND
6	RXD IN-
7	RXD IN+
8	TXD IN-
9	TXD IN+

First Camera

Compact Camera Controller

1	NC
2	NC
3	NC
4	NC
5	GND
6	RXD IN-
7	RXD IN+
8	TXD IN-
9	TXD IN+

1	RXD OUT-
2	RXD OUT+
3	TXD OUT-
4	TXD OUT+
5	GND
6	RXD IN-
7	RXD IN+
8	TXD IN-
9	TXD IN+

##### ▼ RS-422 Connection Instructions

— Applicable to

Lumens Compact Camera Controller

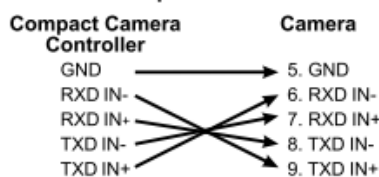

##### ▼ RS-422 Connection Instructions

— Applicable to

SONY Compact Camera Controller

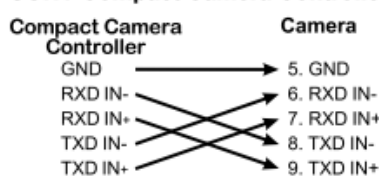



■ RS-422 connection instructions

1. Hold the two sides of RS-422 connector and pull out in the direction shown by the arrow in the figure below

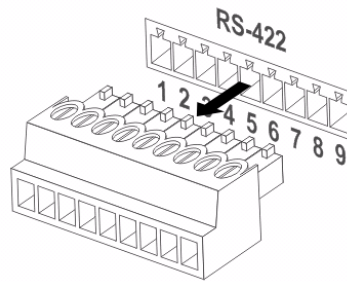

2. Peel off a section of copper wire (AWG Nos. 28 to 18) and insert it into the connector hole; then use flat screw driver to fix it

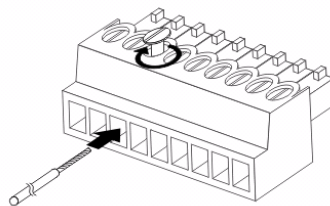

3. Insert the wired RS-422 connector back to the Camera. Now the connection is completed

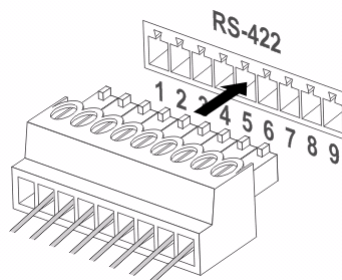

# Chapter 5 Remote Control and Setting Menu

## 5.1 Functions of remote control

<Remark> The below functions are listed alphabetically.

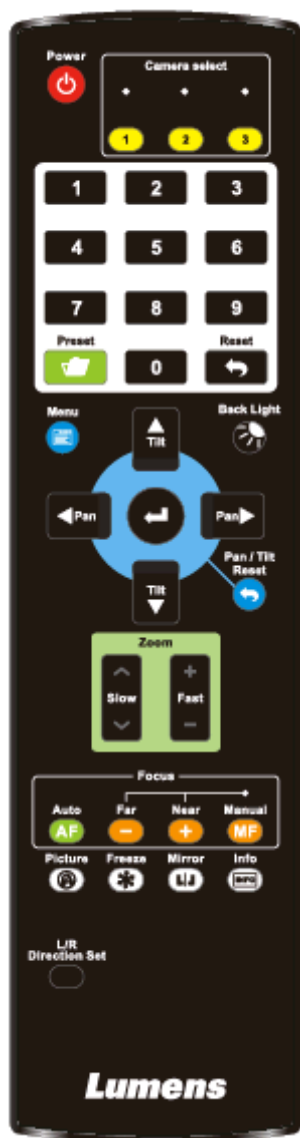

Item	Description
◀, ▶, ▲, ▼	Move the lens
Back Light	Turn on/off back light compensation
Camera select	Choose Camera ID 1 ~ 3
Focus-Manual / Far/Near	Turn on manual focus to adjust the focal length
Focus-Auto	Auto Focus
Freeze	Freeze the screen
Home-Enter	Go back to the main page / Execute
Info	Status information
L/R Direction Set	L/R Direction / Normal
Menu	Display OSD menu
Mirror	Rotate the image (OFF / Mirror / Flip / Rotate)
Pan/Tilt Reset	Clear the Pan / Tilt setting
Picture	Switch image effect (OFF / Neg / B&W)
Power	Power Switch
Preset	Appoint an ID (0 ~ 9) to save the current position data
Reset	Appoint an ID (0 ~ 9) to delete the current position data
Zoom-Fast	Adjust image size
Zoom-Slow	Fine-tune image size

## 5.2 Setting Menu

<Remark> Press [**Menu**] on the **remote control** to enter the setting menu; the **bold underlined** values in the following table are defaults.

1st Level Major Items	2nd Level Minor Items	3rd Level Adjustment Values		Function Descriptions	
Exposure	Mode	1. <b>Full Auto</b> 2. Shutter Pri 3. Iris Pri 4. Manual		Exposure mode setting	
	Exposure Comp.	On / <b>Off</b>		AE Level	
	Exposure Comp. Level	-5 ~ <b>C</b> ~ 5		The value can be adjusted after <b>Exposure Comp.</b> is activated	
	Spot Light	On / <b>Off</b>			
	Spot Light Position	X (0 ~ 6) Y (0 ~ 4)		The value can be adjusted after <b>Spot Light</b> is activated	
	Shutter Pri		60/30 mode	50/25 mode	Adjustable when the <b>Exposure mode</b> is set to <b>Shutter Pri</b>
			1/10000	1/10000	
			1/5000	1/5000	
			1/3000	1/3000	
			1/2500	1/2500	
			1/2000	1/1750	
			1/1500	1/1250	
			1/1000	1/1000	
			1/725	1/600	
			1/500	1/425	
			1/350	1/300	
			1/250	1/215	
1/180			1/150		
1/120			1/120		
1/100			1/100		
1/90			1/75		
<b>1/60</b>	<b>1/50</b>				
1/30	1/25				
1/15	1/12				
1/8	1/6				
1/4	1/3				
1/2	1/2				
1/1	1/1				

1st Level Major Items	2nd Level Minor Items	3rd Level Adjustment Values		Function Descriptions
	<b>Iris Pri</b>	1. F1.6 2. F2 3. F2.2 4. F2.7 5. <b><u>F3.2</u></b> 6. F3.8 7. F4.5 8. F5.4 9. F6.3 10. F7.8 11. F9 12. F11 13. F13 14. F16 15. F18 16. Off		Adjustable when the <b>Exposure mode</b> is set to <b>Iris Pri</b>
	<b>Manual Gain</b>	1. <b><u>0 dB</u></b> 2. 3 dB 3. 6 dB 4. 9 dB 5. 12 dB 6. 15 dB 7. 18 dB 8. 21 dB 9. 24 dB 10. 27 dB 11. 30 dB 12. 33 dB 13. 36 dB 14. 39 dB 15. 42 dB 16. 45 dB		Adjustable when the <b>Exposure mode</b> is set to <b>Manual</b>
	<b>Manual Speed</b>	60/30 mode	50/25 mode	Manually set the shutter
	1/10000	1/10000		
	1/5000	1/5000		
	1/3000	1/3000		
	1/2500	1/2500		

1st Level Major Items	2nd Level Minor Items	3rd Level Adjustment Values		Function Descriptions
		1/2000	1/1750	
		1/1500	1/1250	
		1/1000	1/1000	
		1/725	1/600	
		1/500	1/425	
		1/350	1/300	
		1/250	1/215	
		1/180	1/150	
		1/120	1/120	
		1/100	1/100	
		1/90	1/75	
		<b><u>1/60</u></b>	<b><u>1/50</u></b>	
		1/30	1/25	
		1/15	1/12	
		1/8	1/6	
		1/4	1/3	
		1/2	1/2	
1/1	1/1			
	<b>Manual Iris</b>	<ol style="list-style-type: none"> <li>1. F1.6</li> <li>2. F2</li> <li>3. F2.2</li> <li>4. F2.7</li> <li>5. <b><u>F3.2</u></b></li> <li>6. F3.8</li> <li>7. F4.5</li> <li>8. F5.4</li> <li>9. F6.3</li> <li>10. F7.8</li> <li>11. F9</li> <li>12. F11</li> <li>13. F13</li> <li>14. F16</li> <li>15. F18</li> <li>16. Off</li> </ol>		Manually set the iris

1st Level Major Items	2nd Level Minor Items	3rd Level Adjustment Values	Function Descriptions
	<b>Gain Limit</b>	1. 9 dB 2. 12 dB 3. 15 dB 4. 18 dB 5. 21 dB 6. 24 dB 7. <b><u>27 dB</u></b> 8. 30 dB 9. 33 dB 10. 36 dB 11. 39 dB 12. 42 dB 13. 45 dB	Max. limit value of electron gain
	<b>Iris Limit</b>	1. <b><u>F3.2</u></b> 2. F3.8 3. F4.5 4. F5.4 5. F6.3 6. F7.8 7. F9 8. F11	Max. limit value of iris
	<b>WDR</b>	1. <b><u>Off</u></b> 2. 1 3. 2 4. 3	
<b>White Balance</b>	<b>Mode</b>	1. <b><u>Auto</u></b> 2. Indoor 3. Outdoor 4. One Push WB 5. ATW 6. Manual 7. Sodium Lamp	Select the color temperature mode 1. 4000k ~ 7000k 2. 3200k 3. 5800k 4. 1700k ~ 10000k 5. 1700k ~ 10000k 6. Custom 7. 2800k
	<b>One Push Trigger</b>	<b><u>ENTER</u></b>	One push trigger
	<b>Manual Red</b>	0 ~ <b><u>C</u></b> ~ 128	Adjustable when the white balance mode is set to <b>Manual</b>
	<b>Manual Blue</b>	0 ~ <b><u>C</u></b> ~ 128	Adjustable when the white balance mode is set to <b>Manual</b>

1st Level Major Items	2nd Level Minor Items	3rd Level Adjustment Values	Function Descriptions
Picture	Picture effect	1. <u>Off</u> 2. Neg 3. B & W	
	Sharpness	0 ~ <u>A</u> ~ 14	
	2D NR	1. Off 2. <u>1</u> 3. 2 4. 3	
	3D NR	1. Off 2. LOW 3. <u>Typ</u> 4. Max	
	Image Mode	1. <u>Default</u> 2. Custom	The user may customize his/her desired image mode.
	Image Mode Load	<u>ENTER</u>	Adjustable when the <b>Image mode</b> is set to <b>Custom</b> . After selected, the corresponding <b>Image mode</b> parameters will be read and applied to <b>Custom</b>
	Brightness	0 ~ <u>A</u> ~ 15	Adjustable when the <b>Image mode</b> is set to <b>Custom</b>
	Hue	0 ~ <u>A</u> ~ 15	Adjustable when the <b>Image mode</b> is set to <b>Custom</b>
	Saturation	0 ~ <u>A</u> ~ 15	Adjustable when the <b>Image mode</b> is set to <b>Custom</b>
Pan Tilt Zoom	Gamma	0 ~ <u>A</u> ~ 3	Adjustable when the <b>Image mode</b> is set to <b>Custom</b>
	Pan/Tilt Limit	On / <u>Off</u>	Turn on/off the angle limit setting
	Pan Right Limit	0 ~ <u>170</u>	Limit the right angle
	Pan Left Limit	<u>-170</u> ~ 0	Limit the left angle
	Tilt UP Limit	0 ~ <u>90</u>	Limit the upward angle
	Tilt Down Limit	<u>-30</u> ~ 0	Limit the downward angle
Pan Flip	On / <u>Off</u>	Activate the reverse Pan direction	

1st Level Major Items	2nd Level Minor Items	3rd Level Adjustment Values	Function Descriptions
	Tilt Flip	On / <u>Off</u>	Activate the reverse Tilt direction
	Preset Speed	<ol style="list-style-type: none"> <li>1. 5 deg/sec</li> <li>2. 25 deg/sec</li> <li>3. 50 deg/sec</li> <li>4. 80 deg/sec</li> <li>5. 120 deg/sec</li> <li>6. <u>160 deg/sec</u></li> <li>7. 200 deg/sec</li> <li>8. 300 deg/sec</li> </ol>	Set the rotation speed of the cradle head when <b>Preset</b> is executed
	PTZ Speed Comp	On / <u>Off</u>	Set the Pan/Tilt moving speed to vary from the zoom position
	D-Zoom Limit	<u>x1</u> ~x12	Set the D-zoom limit <Remark>3840 x 2160 59.94/50 does NOT support this setting
	PTZ Motion Sync	On / <u>Off</u>	After turning on, operate <b>Preset</b> to achieve PTZ Motion Sync <Remark> This function will refer to the default speed setting, but may automatically adjust the speed due to the difference in PTZ movement range
D-Effect	Mirror	<ol style="list-style-type: none"> <li>1. <u>Off</u></li> <li>2. MIRROR</li> <li>3. Flip</li> <li>4. Mirror + Flip</li> </ol>	Set the mode at which the image is mirror or flipped
Auto Focus	AF Sensitivity	<ol style="list-style-type: none"> <li>1. LOW</li> <li>2. <u>Middle</u></li> <li>3. High</li> </ol>	For AF triggering speed, the higher the speed is, the faster AF is triggered
	AF Frame	<ol style="list-style-type: none"> <li>1. Center Area</li> <li>2. Full Area</li> <li>3. <u>Auto</u></li> </ol>	AF frame setting, when central area was set as AF frame, focusing will be on the center of the screen. When Full Frame was set as AF frame, focusing will be calculated based on the full screen



1st Level Major Items	2nd Level Minor Items	3rd Level Adjustment Values	Function Descriptions
	<b>PTZ Assist</b>	On / <u>Off</u>	This function can only be enabled in the Manual Focus (MF) mode When PTZ Assist is enabled and PTZ control is in operation, the focus performs only once upon immediate execution. The focus will not be triggered afterward when the scene changes
	<b>SMART AF</b>	On / <u>Off</u>	Turn on this function and AF will mainly focus on the face
<b>Ethernet</b>	<b>DHCP</b>	<u>On</u> / Off	Enable/Disable DHCP setting using left and right arrow keys and press [ENTER] to apply setting.
	<b>IP Address</b>	<u>192.168.100.100</u>	Press [ENTER] to be in modify mode; select the item to be modified using the up and down keys, and modify the value using the left and right keys or the numeric keys.
	<b>Subnet Mask</b>	<u>255.255.255.0</u>	Press [ENTER] to be in modify mode; select the item to be modified using the up and down keys, and modify the value using the left and right keys or the numeric keys.
	<b>Gateway</b>	<u>192.168.100.254</u>	Press [ENTER] to be in modify mode; select the item to be modified using the up and down keys, and modify the value using the left and right keys or the numeric keys.
<b>Audio</b>	<b>Audio In</b>	<u>Line In</u> /Mic In	Set Audio In
	<b>Audio Enable</b>	On / <u>Off</u>	Turn on/off audio output
	<b>Audio Volume</b>	0 ~ <u>A</u> ~ 10	Volume Setting

1st Level Major Items	2nd Level Minor Items	3rd Level Adjustment Values	Function Descriptions
	Audio Delay	On / <u>Off</u>	When audio and video are out of sync, enable this feature to set the audio delay time <Remark>VC-A71PN does not support this setting
	Audio Delay Time(ms)	-1~-500ms	Set audio delay time <Remark>VC-A71PN does not support this setting
	Encode Type	1. <u>AAC</u> 2. G.711	Set encode type <Remark>VC-A71PN does not support this setting
	Encode Sample Rate	1. <u>48 KHz (AAC)</u> 2. 44.1 KHz (AAC) 3. 16 KHz (AAC) 4. 16 KHz (G.711) 5. 8 KHz (G.711)	Set the encode type and sample rate <Remark>SDI supports the audio output of 48 KHz only <Remark>VC-A71PN does not support this setting
System	Prompt	On / <u>Off</u>	Turn on/off the prompt information on the display
	IR Receive	<u>On</u> / Off	When it is Off, the remote control will not be able to control the camera. At this moment, turn off and then turn on the power to restore control of the remote control.
	Tally Lamp	<u>On</u> / Off	Select to enable or disable Tally Lamp function.
	Language	<u>English</u> / Chinese	
	Initial Position	<u>Last Memory</u> / 1st Preset	Select the camera lens to return to the last operated position or the first preset position after POWER ON. <Remark>First default position = Preset 0
Control Device	Encoder / <u>Controller</u>	Control Device setting, Controller: for joystick Encoder: for tracking system	

1st Level Major Items	2nd Level Minor Items	3rd Level Adjustment Values	Function Descriptions
	<b>Motionless Preset</b>	On / <u>Off</u>	When the function is enabled, the screen will Freeze when Preset is executed. Freeze will be released after Preset is completed.
	<b>Control Port</b>	<u>RS-232</u> /RS-422	Choose whether the control interface used is RS-232 or RS-422
	<b>Protocol</b>	<u>VISCA</u> / Pelco D	
	<b>Baud Rate</b>	<u>9600</u> /38400	Choose the transmission speed of the control signal
	<b>VISCA Address</b>	<u>0</u> ~ 7	The Protocol set to VISCA allows the camera ID address to be assigned. Select 0 for automation.
	<b>PELCO D Address</b>	<u>1</u> ~ 255	The Protocol set to Pelco D allows the camera ID address to be assigned.
	<b>Output Mode</b>	<ol style="list-style-type: none"> <li>1. <u>3840 x 2160/59.94p</u></li> <li>2. 3840 x 2160/50p</li> <li>3. 3840 x 2160/29.97p</li> <li>4. 3840 x 2160/25p</li> <li>5. 1080p/59.94</li> <li>6. 1080p/50</li> <li>7. 1080p/29.97</li> <li>8. 1080p/25</li> <li>9. 720p/59.94</li> <li>10. 720p/50</li> <li>11. 720p/29.97</li> <li>12. 720p/25</li> <li>13. 1080i/59.94</li> <li>14. 1080i/50</li> </ol>	<p>Choose the output resolution</p> <p>&lt;Remark&gt;VC-A71PN does not support 720p/29.97 and 720p/25 output modes</p> <p>&lt;Remark&gt;For HDMI/SDI output, when 1080i mode is set, NDI output is 1080p</p>
	<b>Factory Reset</b>	On / <u>Off</u>	Resume the factory default setting
<b>Status</b>			Display the current setting status

# Chapter 6 Network Function Settings Description

## 6.1 Connecting Camera to Network

### 6.1.1 Connecting to Internet

Two common connection methods are shown below

#### 1. Connecting via switch or router

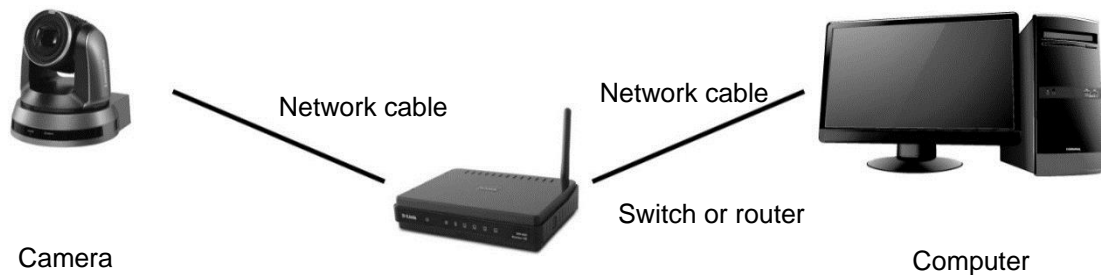

2. To connect directly through network cable, the IP address of the computer should be changed so that it is on the same network segment as the camera  
e.g.: The factory-preset default IP address of camera is 192.168.100.100. The computer IP address must be set with the same network segment, such as 192.168.100.101, so that the computer can be connected correctly with the camera

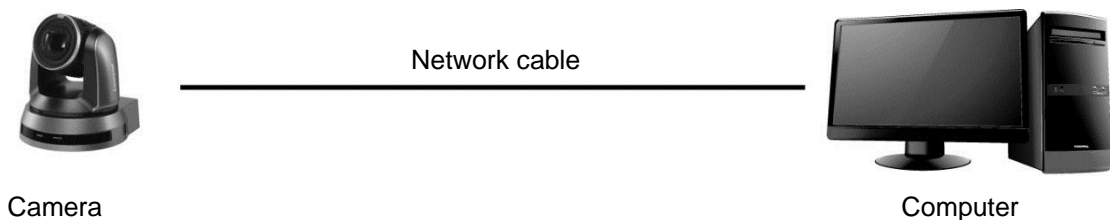

- Change network settings

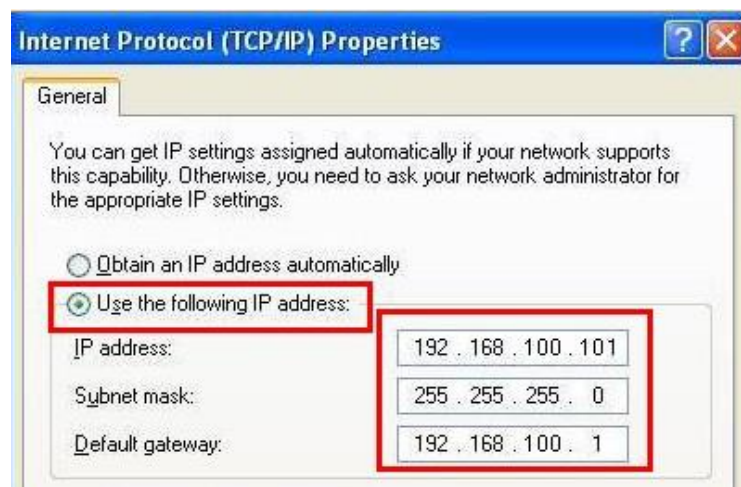

### 6.1.2 Using the Browser to View the Images

- Open the browser, and enter the URL of camera in the IP address bar  
e.g.: <http://192.168.100.100> (default IP address)
- Enter administrator's account and password
  - \*For the first login, please refer to [6.2.3 Account Management](#) to change the default password

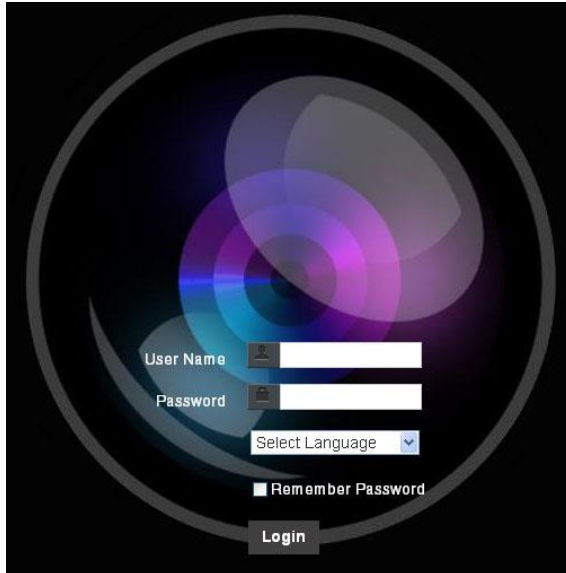

Lumens Network Camera	
●	Account: admin
●	Password: 9999

### 6.1.3 Using Lumens VMS Software to View the Images

<Remark> Lumens VMS is for VC-A71P only and cannot work with VC-A71PN

- Open **LUMENS VMS** software (Please download from the Lumens official website)
- Search for the camera: Press  [automatically search for the device] button to locate the VC-A71P camera
- Click the camera in the list and start operation after connecting to network

<Caution> When using automatic search, the camera and computer must be in the same network segment, e.g.: 192.168.4.X

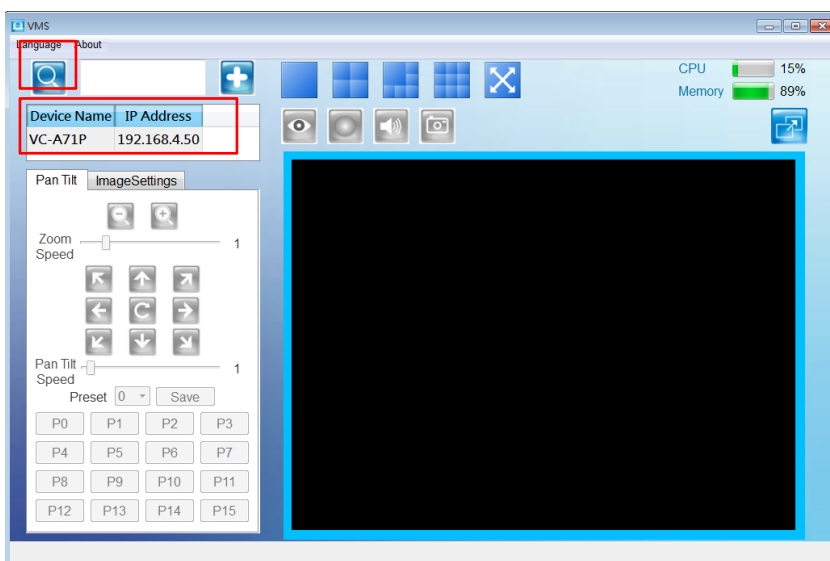

## 6.1.4 Using RTSP Player to View the Images

<Remark> This is only applicable to VC-A71P. VC-A71PN does not support RTSP Streaming

In addition to the browser and VMS, other free softwares also can be used for RTSP connection, such as VLC, Quick Time and PotPlayer

RTSP connection address formats are as follows:

- RTSP Main Streaming (4K@H.265) => rtsp://camera IP:8554/hevc
- RTSP Sub1 Streaming (1080P@H.264) => rtsp://camera IP:8557/h264
- RTSP Sub2 Streaming (720P@H.264) => rtsp://camera IP:8556/h264

For password authentication, the RTSP connection address is as follows:

- RTSP Main Streaming  
rtsp://Username:Password@VC IP address:port/hevc
- RTSP Sub1/ Sub2 Streaming  
rtsp://Username:Password@VC IP address:port/h264
- To enable password authentication, please refer to [6.2.9 Setting - Network](#)

Example: Open VLC software, click [Open Network Stream], and enter a URL:  
rtsp://192.168.4.48:8554/hevc

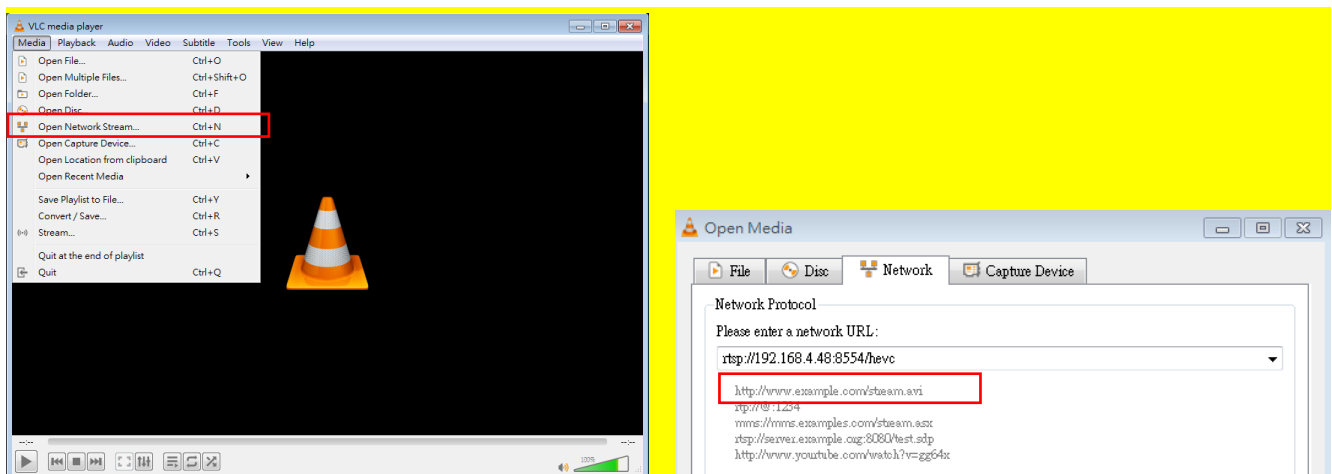

## 6.1.5 Using NDI Studio Monitor to View the Images

<Remark> This is only applicable to VC-A71PN. VC-A71P does not support NDI

For NewTek product operation or instructions, please visit the website:

<https://www.newtek.com/>.

To download NDI 4 Tool, click the link: <http://new.tk/NDIHX-Driver-Win>

## 6.2 Web Page Function Description

### 6.2.1 Login Screen

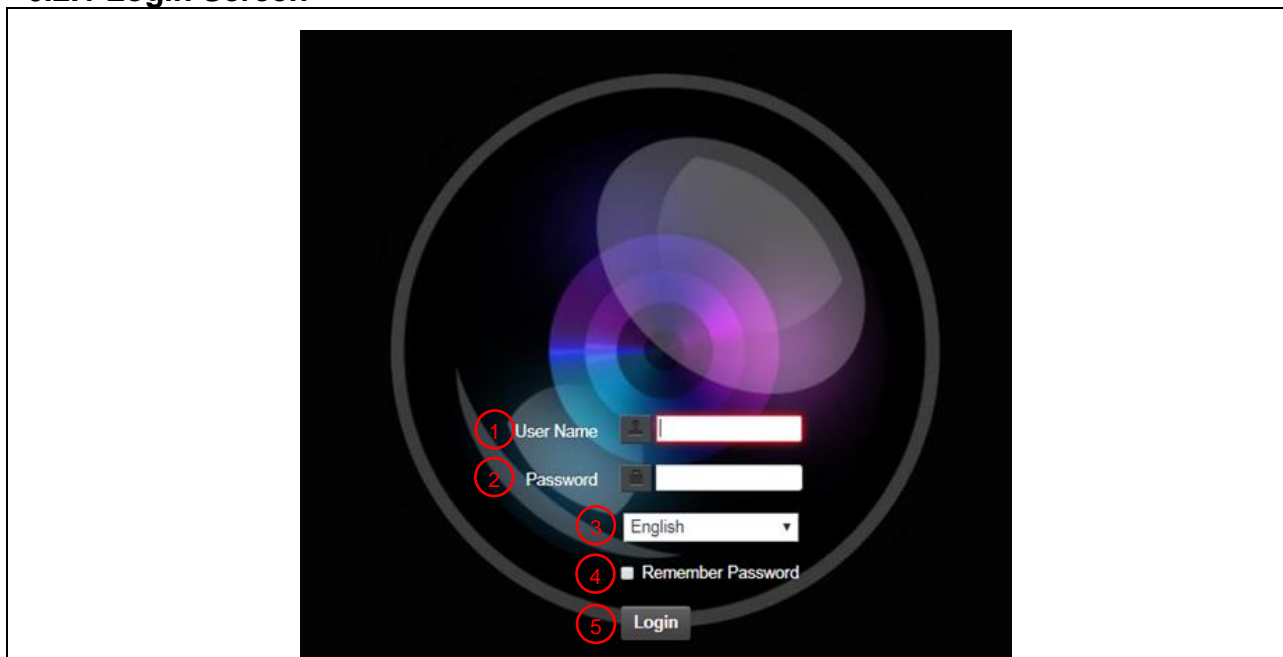

No	Item	Function Descriptions
1	Username	Enter user account (default: admin)
2	Password	Enter user password (default: 9999) *For the first login, please refer to <a href="#">6.2.3 Account Management</a> the default password
3	Language selection	Currently, the system supports English, Traditional Chinese and Simplified Chinese
4	Remember password	Save user account name and password to the browser. When you log in next time, there is no need to re-enter them
5	Login	Log into the administrator screen on the website

## 6.2.2 Live View

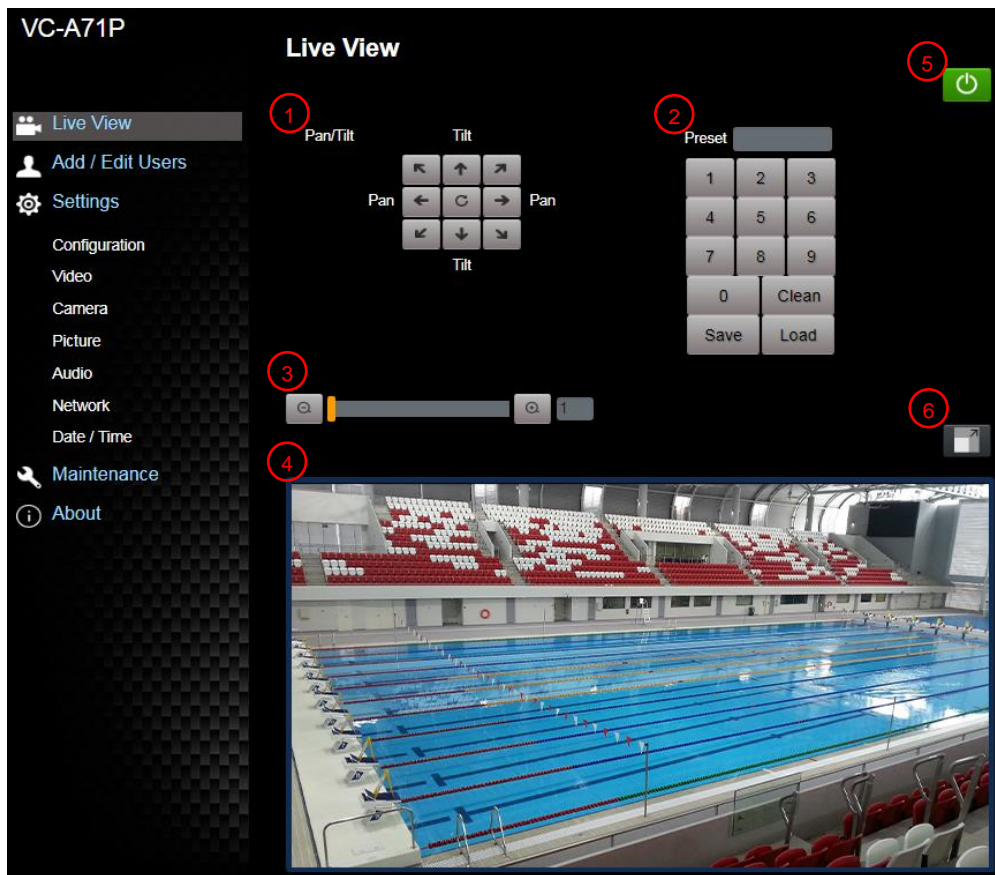

No	Item	Function Descriptions
1	Pan / Tilt setting	Adjust the Pan/Tilt position of the camera screen
2	Preset setting	Select the number first and then select SAVE or LOAD
3	Zoom ratio	Adjust the zoom-in or zoom-out ratio via scroll bar
4	Preview window	Display the screen currently captured by the camera <b>&lt;Remark&gt;</b> VC-A71PN does not support this setting
5	Power button	Turn on or turn off the camera power
6	Switch to Full Screen	Switch the preview window to full screen <b>&lt;Remark&gt;</b> VC-A71PN does not support this setting



## 6.2.3 Account Management

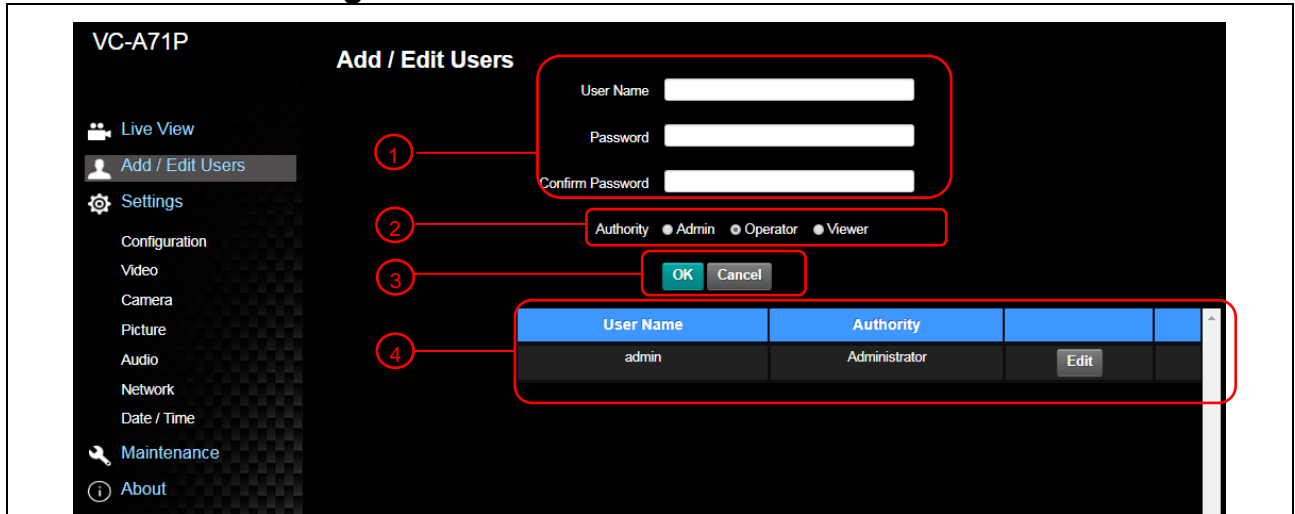

No	Item	Function Descriptions																
1	Add user account	Enter a user name and password to add a new user																
2	Permission setting	Set the new account management permissions <table border="1"> <thead> <tr> <th>User Type</th> <th>Admin</th> <th>Operator</th> <th>Viewer</th> </tr> </thead> <tbody> <tr> <td>View images</td> <td>V</td> <td>V</td> <td>V</td> </tr> <tr> <td>Settings</td> <td>V</td> <td>V</td> <td>X</td> </tr> <tr> <td>Account management</td> <td>V</td> <td>X</td> <td>X</td> </tr> </tbody> </table>	User Type	Admin	Operator	Viewer	View images	V	V	V	Settings	V	V	X	Account management	V	X	X
User Type	Admin	Operator	Viewer															
View images	V	V	V															
Settings	V	V	X															
Account management	V	X	X															
3	Applying setting	Add the newly created user to the list of account																
4	List of accounts	Edit: Modify the user password and permissions Delete: Delete the user account																

## 6.2.4 Setting - System Setting

<Remark> The figure is an example of VC-A71P. VC-A71PN does not support Preview Window

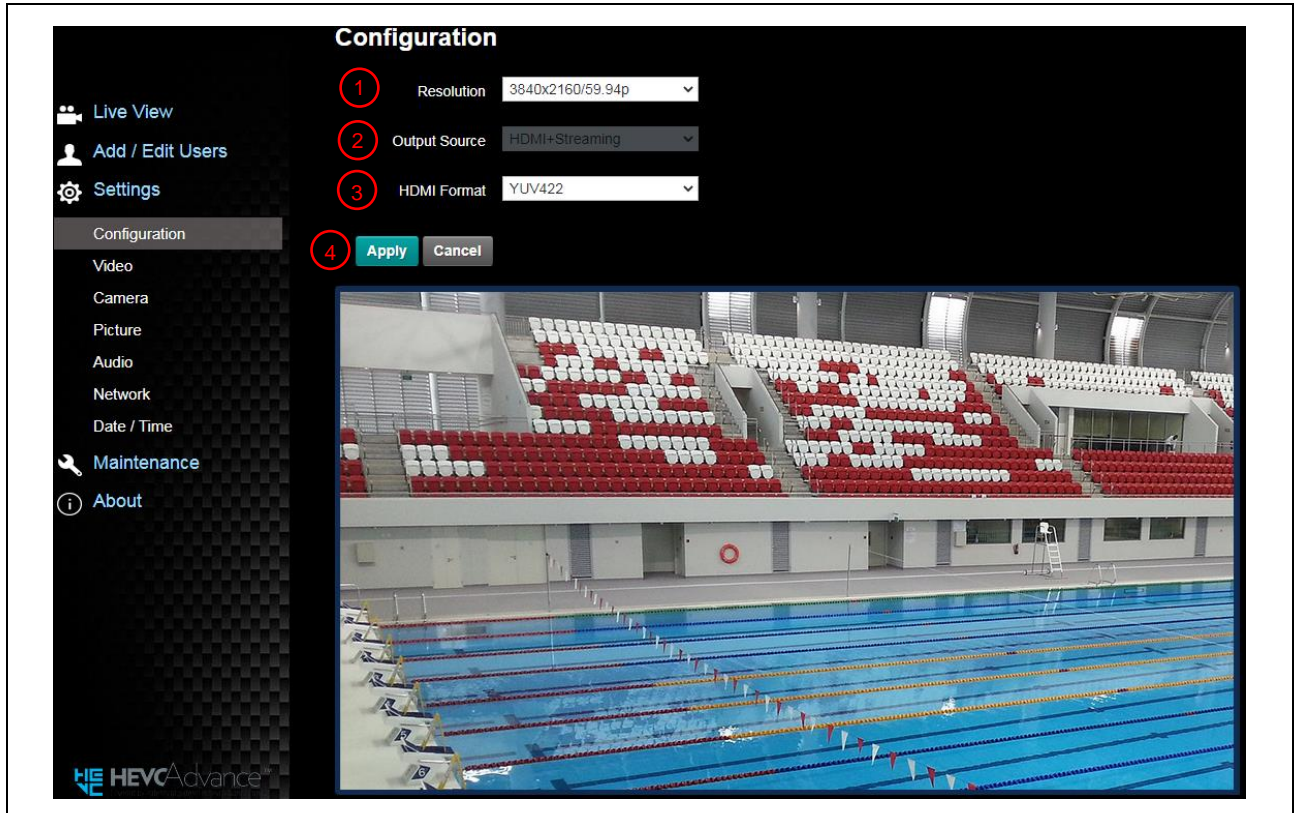

No	Item	Function Descriptions
1	Resolution	<p>Set the resolution of the camera, resolutions supported by the camera are as follows:</p> <p>3840 x 2160 59.94 / 50 / 29.97 / 25 fps            1080P 59.94 / 50 / 29.97 / 25            720P 59.94 / 50 / 29.97 / 25            1080i 59.94/50</p> <p>After switching to the resolution, the camera will restart. Please refresh the browser</p> <p>&lt;Remark&gt;VC-A71PN does not support 720p 29.97/25 fps resolutions            &lt;Remark&gt;1080i mode only supports HDMI/SDI output. When 1080i mode is set, NDI output is 1080p</p>
2	Output signal	<p>According to the output resolution, you can select HDMI + streaming output or HDMI + UVC output</p> <p>&lt;Remark&gt; When it is set to UVC output, 3840 x 2160 29.97p or lower resolutions are supported</p>
3	HDMI Format	<p>Select YUV422 / YUV420 / RGB</p> <p>&lt;Remark&gt; When it is set to YUV420, 3840 x 2160 59.94p and 3840 x 2160 50p resolutions are supported</p>
4	Apply	<p>After the setting has been modified, select this button to apply the setting</p>

## 6.2.5 Setting - Video

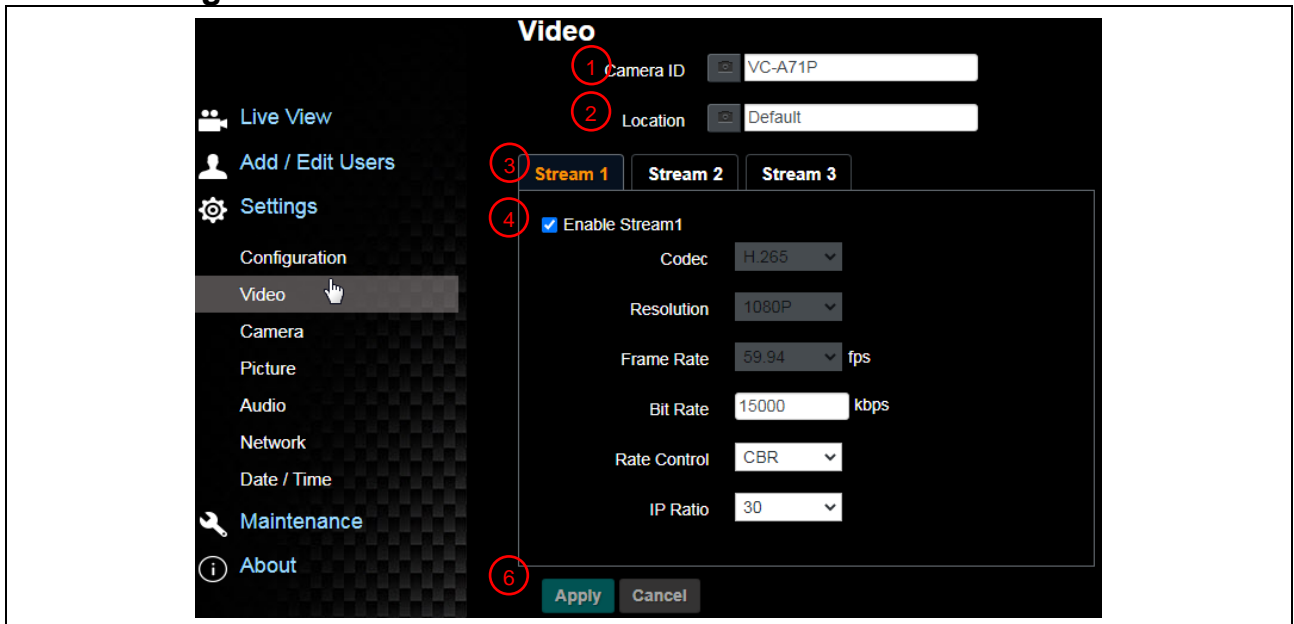

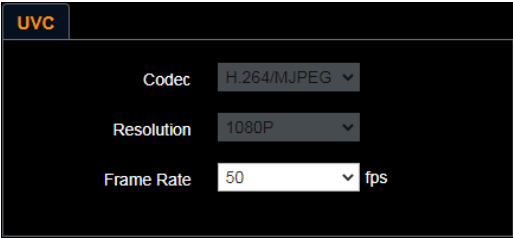
No	Item	Function Descriptions
1	Camera name	<p>Modify the camera name</p> <ul style="list-style-type: none"> <li>Camera names are limited to 1 - 12 characters</li> <li>Please use a camera name by mixing uppercase and lowercase letters or numbers. Do not use "/" and "space" or special symbols</li> </ul>
2	Camera Location	<p>Modify the location of the camera, such as Meeting Room 1</p> <ul style="list-style-type: none"> <li>Camera location is limited to 1 - 12 characters</li> <li>Please use a camera name by mixing uppercase and lowercase letters or numbers. Do not use "/" and "space" or special symbols</li> </ul>
3	Streaming 1/Streaming 2/Streaming 3	<p><b><u>Setting - System Setting - Output Signal</u></b> Display when it is set to HDMI + streaming</p> <p>VC-A71P supports 3 streaming outputs. Please refer to <a href="#">6.2.5.1 Streaming Parameter Setting</a> for relevant settings</p> <p><b>&lt;Remark&gt;</b> VC-A71PN does not support this setting</p>
4	Open Streaming	<p>Confirm whether or not the streaming function is opened</p> <p><b>&lt;Remark&gt;</b> VC-A71PN does not support this setting</p>
5	UVC	<p><b><u>Setting - System Setting - Output Signal</u></b> Display when it is set to HDMI + UVC</p>  <ul style="list-style-type: none"> <li><b>Encode Format:</b> <ul style="list-style-type: none"> <li>3840 x 2160 29.97 / 25 fps: H.264</li> <li>Less than 1080p (inclusive): H.264/MJPEG</li> </ul> </li> <li><b>Resolution:</b> It is shown based on <u>Settings - System Settings - Resolution</u></li> </ul> <p>Frame Rate: 3840 x 2160 can only select the highest 29.97 fps</p> <p><b>&lt;Remark&gt;</b> VC-A71PN does NOT support this setting</p>
6	Apply	<p>After the setting has been modified, select this button to apply the setting</p>

### 6.2.5.1 Streaming parameter setting

Function		Streaming 1	Streaming 2	Streaming 3
Encode Format		H.265	H.264	
Resolution		4K /1080p / 720p	1080p / 720p / 1080i	640 x 360
Frame Rate		Setting according to the supported resolution <Remark> Only 59.97 / 50 are supported when the resolution of Streaming 2 is 1080i		
Bit Rate (kbps)	2,000 ~ 20,000	2,000 ~ 20,000	512 ~ 5,000	512 ~ 5,000
	7,000	7,000	1,000	1,000
Rate Control		CBR / VBR		
IP Ratio		Setting according to the supported resolution <Remark> Only 15 / 25 are supported when the resolution is 1080i		

### 6.2.6 Setting - Camera

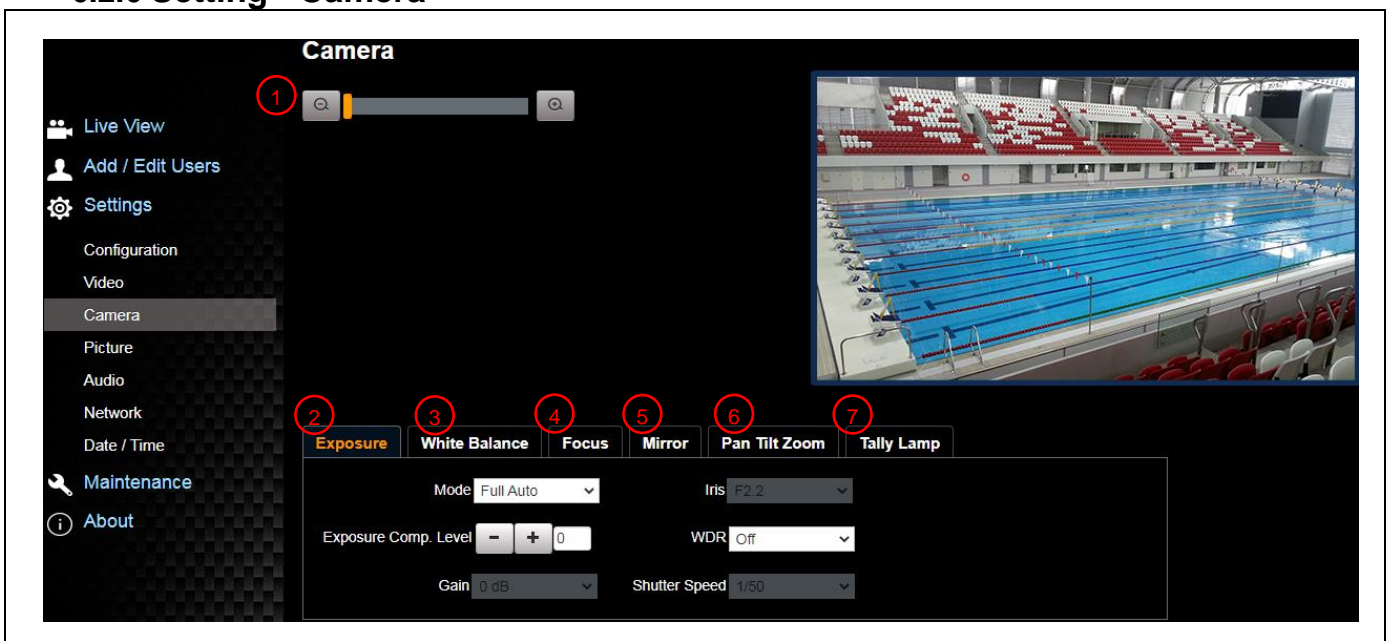

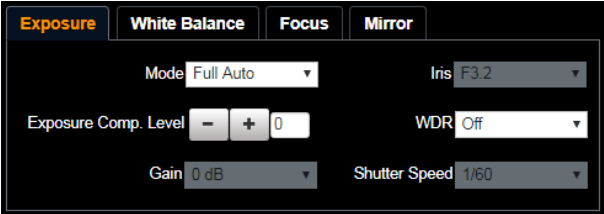
No	Item	Function Descriptions
1	Zoom ratio	Adjust the zoom-in or zoom-out ratio via scroll bar
2	Exposure	 <ul style="list-style-type: none"> <li>■ <b>Mode:</b> Select exposure mode (Automatic/Shutter Priority/Aperture Priority/ Manual)</li> <li>■ <b>Exposure Comp. Level:</b> Select exposure compensation level</li> <li>■ <b>Gain:</b> The gain limit is adjustable when the exposure mode is set to “Manual”</li> <li>■ <b>Iris:</b> The size of aperture is adjustable when the exposure mode is set to “Manual” or “Aperture Priority”</li> <li>■ <b>WDR:</b> Set the level of wide dynamic range (WDR) in order to obtain better images</li> <li>■ <b>Shutter Speed:</b> The shutter speed is adjustable when the exposure mode is set to “Manual” or “Shutter Priority”</li> </ul>

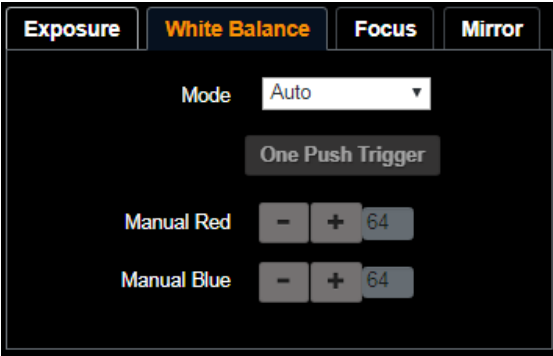
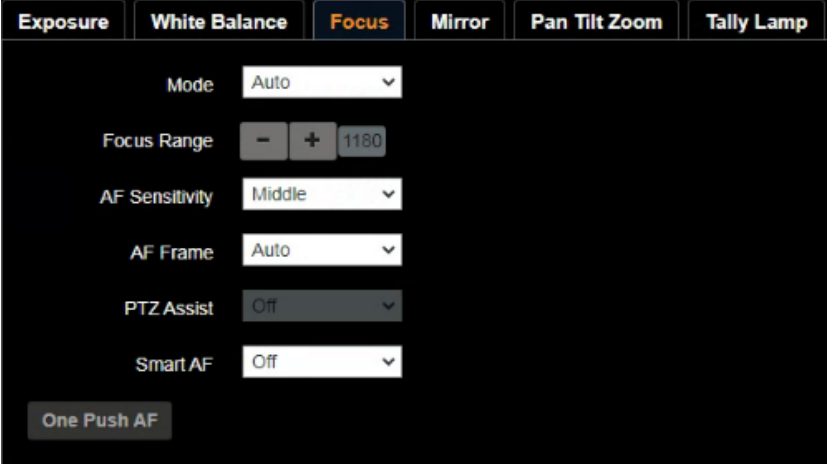
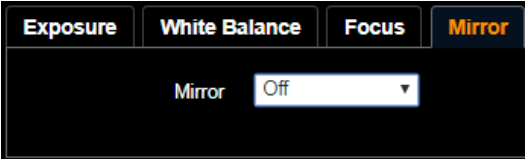
3	White Balance	 <ul style="list-style-type: none"> <li>■ <b>Mode:</b> Select the color temperature mode <ul style="list-style-type: none"> <li>➢ Auto</li> <li>➢ Indoor</li> <li>➢ Outdoor</li> <li>➢ One Push WB</li> <li>➢ ATW</li> <li>➢ Manual</li> <li>➢ Sodium Lamp</li> </ul> </li> <li>■ <b>Open Push WB:</b> One push color temperature is adjustable when the white balance mode is set to “One Push WB”</li> <li>■ <b>Manual Red/Blue:</b> Manually adjust blue/red color temperature</li> </ul>
4	Focus	 <ul style="list-style-type: none"> <li>■ <b>Mode:</b> Select manual/automatic focus</li> <li>■ <b>Focus Range:</b> The focusing range is adjustable when the focus mode is set to “Manual”</li> <li>■ <b>AF Sensitivity:</b> Set automatic focus sensitivity</li> <li>■ <b>AF Frame:</b> Set automatic focus range</li> <li>■ <b>PTZ Assist:</b> Set Auto Focus in manual mode</li> <li>■ <b>Smart AF:</b> Turn on this function and AF will mainly focus on the face</li> <li>■ <b>One-shot Focus:</b> When manual focus mode is on, click this function for one-shot autofocus</li> </ul>
5	MIRROR	 <ul style="list-style-type: none"> <li>■ <b>Mirror:</b> Set automatic flip mode [Off / Mirror / Flip / Mirror + Flip]</li> </ul>

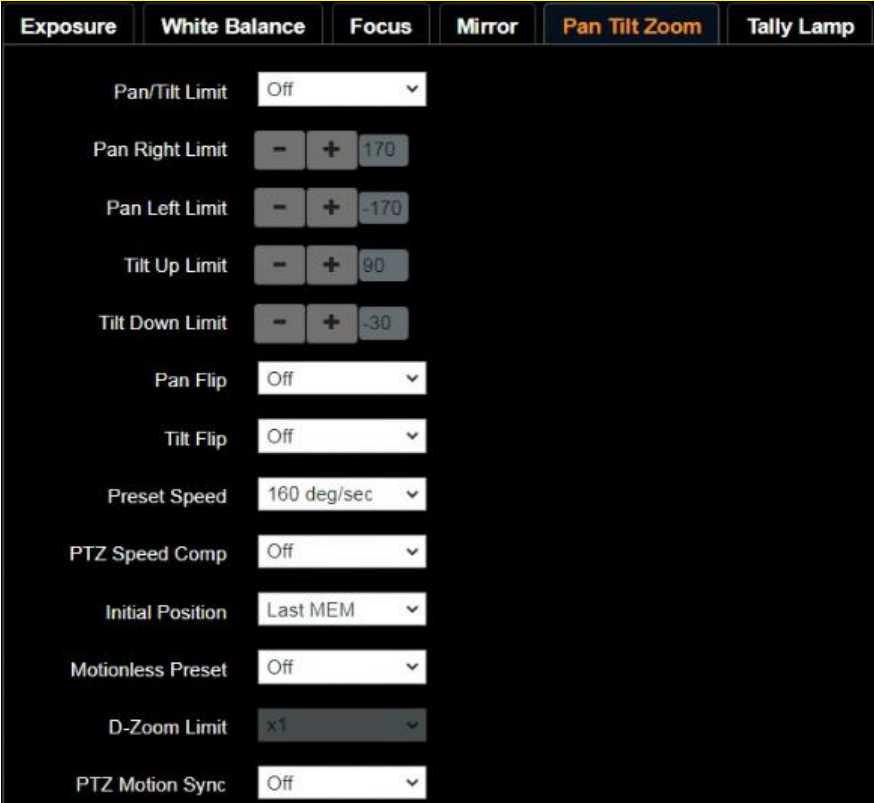
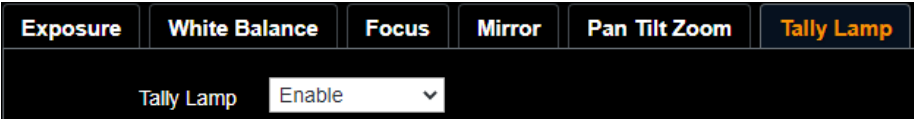
6.	Pan Tilt Zoom	 <ul style="list-style-type: none"> <li>■ <b>Pan/Tilt Limit:</b> Set the Pan/Tilt limit</li> <li>■ <b>Pan/Tilt Flip:</b> Set Pan/Tilt flip</li> <li>■ <b>Preset Speed:</b> Set the rotation speed of the cradle head when Preset is executed</li> <li>■ <b>PTZ Speed Comp:</b> Set the Pan/Tilt moving speed to vary from the zoom position</li> <li>■ <b>Initial Position:</b> Set the camera lens to return to the last operated position or the first preset position after POWER ON        ※First default position = Preset 0</li> <li>■ <b>Motionless Preset:</b> When the function is enabled, the screen will Freeze when Preset is executed. Freeze will be released after Preset is completed</li> <li>■ <b>D-Zoom Limit:</b> Set the D-Zoom Limit, x1 - x12</li> <li>■ <b>PTZ Motion Sync:</b> After turning on, operate <b>Preset</b> to achieve PTZ Motion Sync</li> </ul> <p><b>&lt;Remark&gt;</b> This function will refer to the default speed setting, but may automatically adjust the speed due to the difference in PTZ movement range</p>
7	Tally Lamp	 <p>Enable/Disable Tally Lamp</p> <p><b>&lt;Remark&gt;</b> When it is disabled, the Tally lamp will not receive RS232 commands to trigger Enable or Disable</p>

## 6.2.7 Setting - Picture

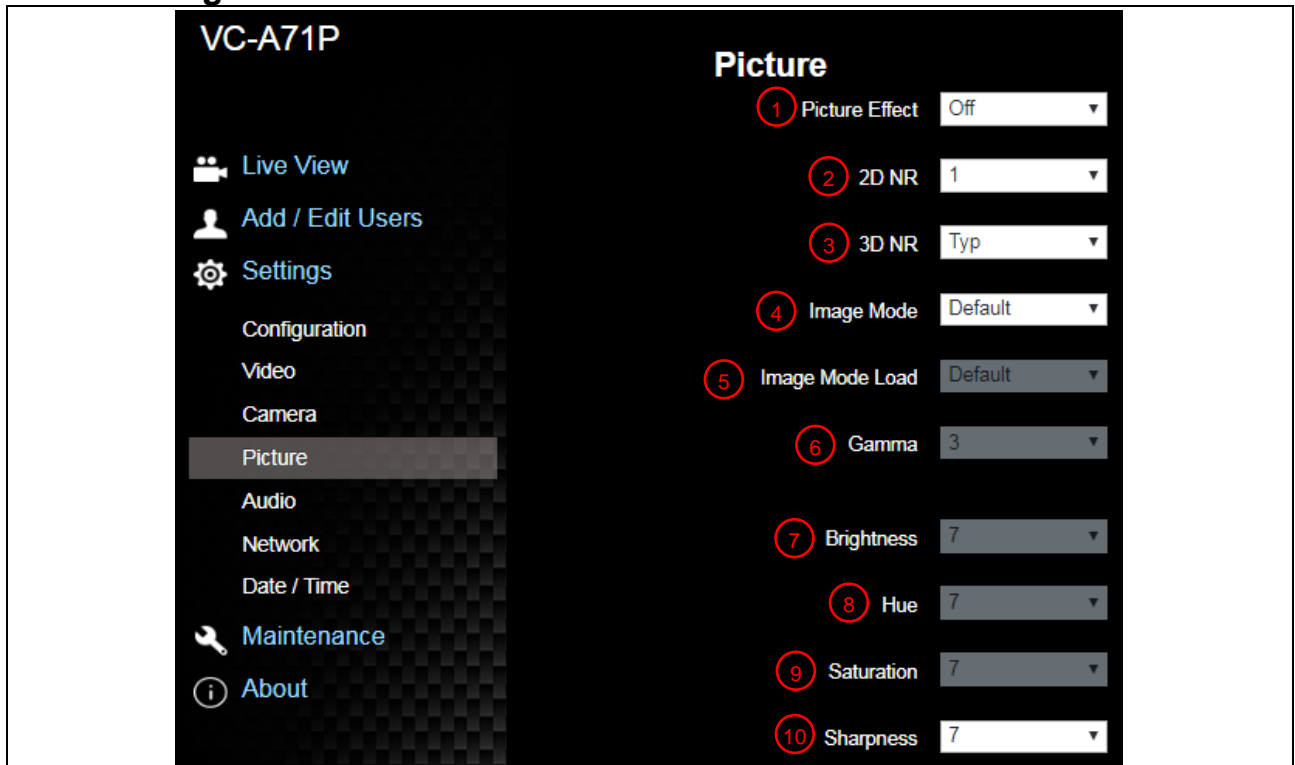

No	Item	Function Descriptions
1	Picture Effect	Set picture effect, Off/Neg/Black and White
2	2D noise reduction settings	2D noise reduction settings
3	3D noise reduction settings	3D noise reduction settings
4	Image mode	The user may customize his/her desired image mode.
5	Image Mode Load	When no custom setting is needed, reset the picture parameters back to the factory default by selecting this item
6	Gamma	Gamma Level adjustment; Adjustable when the image mode is set to Custom
7	Brightness	Brightness adjustment; Adjustable when the image mode is set to Custom
8	Contrast	Contrast adjustment; Adjustable when the image mode is set to Custom
9	Saturation	Saturation adjustment of the image; Adjustable when the image mode is set to Custom
10	Sharpness	Adjust the sharpness of the image

## 6.2.8 Setting - Audio

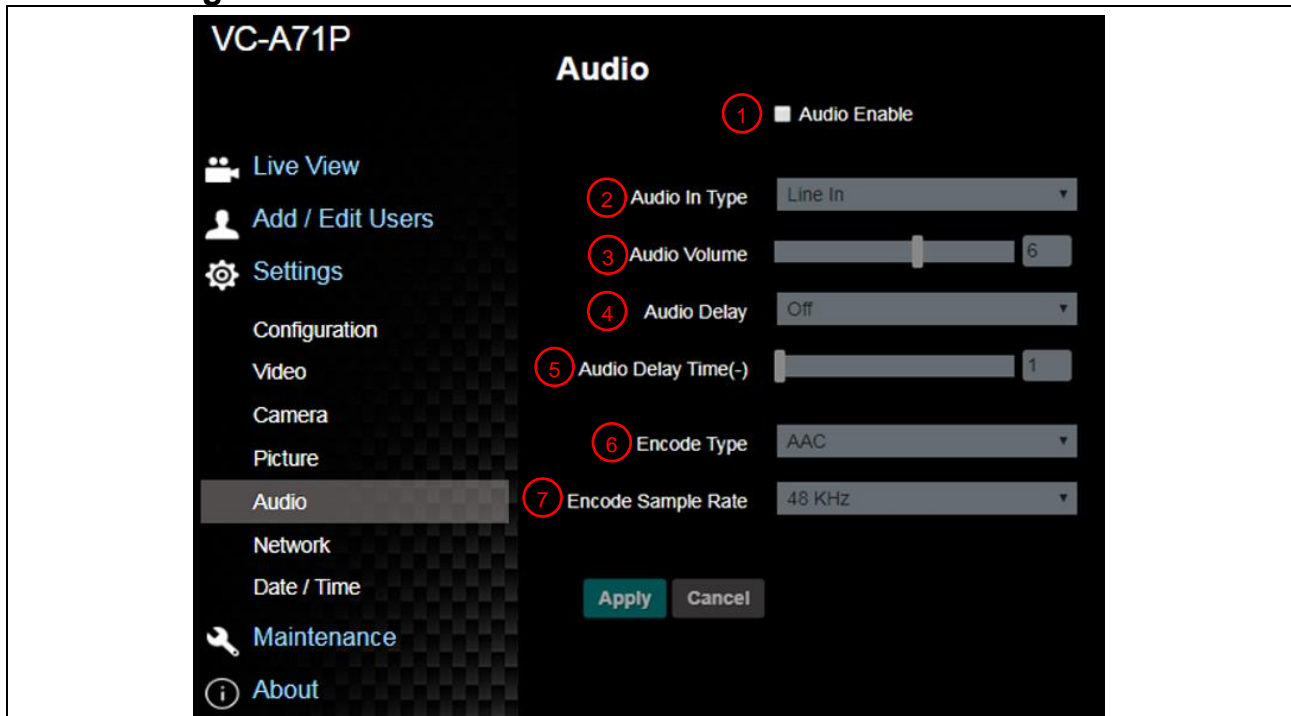

No	Item	Function Descriptions
1	Open audio	Turn on/off sound
2	Soundtrack effect setting	Set MIC In/Line In
3	Audio Volume	Adjust Volume
4	Audio Delay	Turn on / offAudio Delay <b>&lt;Remark&gt;</b> VC-A71PN does not support this setting
5	Audio Delay Time(ms)	Set Audio Delay Time (-1--500ms) <b>&lt;Remark&gt;</b> VC-A71PN does not support this setting
6	Encode Type	AAC / G.711 <b>&lt;Remark&gt;</b> VC-A71PN does not support this setting
7	Encode sample rate	Set Encode sample rate <ul style="list-style-type: none"> <li>■ 48 KHz (AAC)</li> <li>■ 44.1 KHz (AAC)</li> <li>■ 16 KHz (AAC)</li> <li>■ 16 KHz (G.711)</li> <li>■ 8 KHz (G.711)</li> </ul> <b>&lt;Remark&gt;</b> VC-A71PN does not support this setting



## 6.2.9 Setting - Network

No	Item	Function Descriptions
1	Network	Network setting of camera. Change of setting is available when DHCP function is closed.
2	RTMP Setting	Copy the RTMP web address provided by the RTMP service platform and paste it to the RTMP connection address to publish the camera images on the RTMP service platform To upload to YouTube for live streaming, the audio function must be turned on first To upload to YouTube for live streaming, please see <a href="#">6.2.8 Setting - Audio</a> to turn on the audio function first <Remark> VC-A71PN does not support this setting
3	RTSP Setting	<b>Enable / Disable Multicast</b> <b>When more than 4 people are connected to watch live video at the same time, it is recommended to enable the multicast function</b> <b>Enable / Disable Account Password Authentication</b> ➤ <b>Refer to 6.1.4 Using RTSP Player to View Images for RTSP connection format</b> ➤ <b>The account password is the same as that for the camera web login page. Please refer to 6.2.3 Account Management to add/revise the account information</b> <Remark> VC-A71PN does not support this setting
4	MPEG-TS Setting	1. Set MPEG-TS format

		<p>2. The port number must be set in the range above 1024 with a maximum value of 9999</p> <p><b>&lt;Remark&gt;</b>The following port has been used by the camera. Setting of the port may not connect correctly 8554, 8556, 8557, 8080, 80, 81, 9090, 23</p> <p><b>&lt;Remark&gt;</b> VC-A71PN does not support this setting</p>
5	SRT Setting	<p>1. Set the field of SRT and then check the item to open SRT streaming After the SRT streaming is opened, it will be connected automatically upon startup</p> <p>2. The port number must be set in the range above 1024 with a maximum value of 9999 The following port has been used by the camera. Setting of the port may not connect correctly 8554, 8556, 8557, 8080, 9090, 1935</p> <p>3. Delay time is for 20 to 8000 microseconds. The default value is 120 microseconds</p> <p><b>&lt;Remark&gt;</b> VC-A71PN does not support this setting</p>
6	SNTP/ Port Setting	<p>1. Set the SNTP server address</p> <p>2. Set the HTTP port, and the default is Port 80 Set the HTTPS port, and the default is Port 81</p> <p><b>&lt;Remark&gt;</b> The settings can only be modified when the camera's DHCP function is turned off</p>
7	Tracking Data Output Setting	<p>When enabled, PTZ position information can be fed back when the camera is moving</p> <p>1. Serial port output: The protocol must be set to VISCA, and the baud rate should be 38400 (For related settings, please refer to <a href="#">6.2.14 Setting - Maintenance - System Service</a>)</p> <p>2. IP output: It can set IP address and communication port</p> <p><b>&lt;Remark&gt;</b> The performance of the camera may be affected when Tracking Data Output is enabled</p>

## 6.2.10 Setting - Time

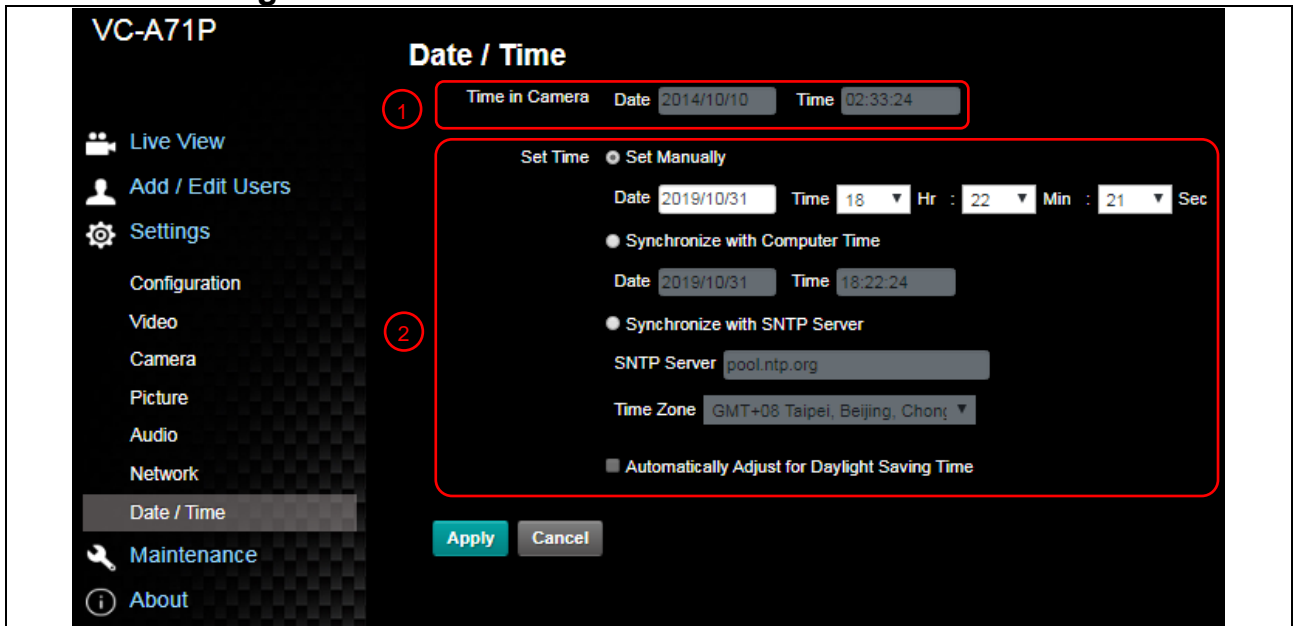

No	Item	Function Descriptions
1	Camera Time	Display the date and time of the camera
2	Set the Time	<ul style="list-style-type: none"> <li>■ Manual Configuration Set time manually</li> <li>■ Synchronize with computer time: Set the camera time according to the computer time</li> <li>■ Synchronize with SNTP server: Set the camera time synchronously with the SNTP server</li> </ul> <p>&lt;Remark&gt;SNTP server address: Please change in network setting</p>

## 6.2.11 Setting - Maintenance - Upgrading Firmware

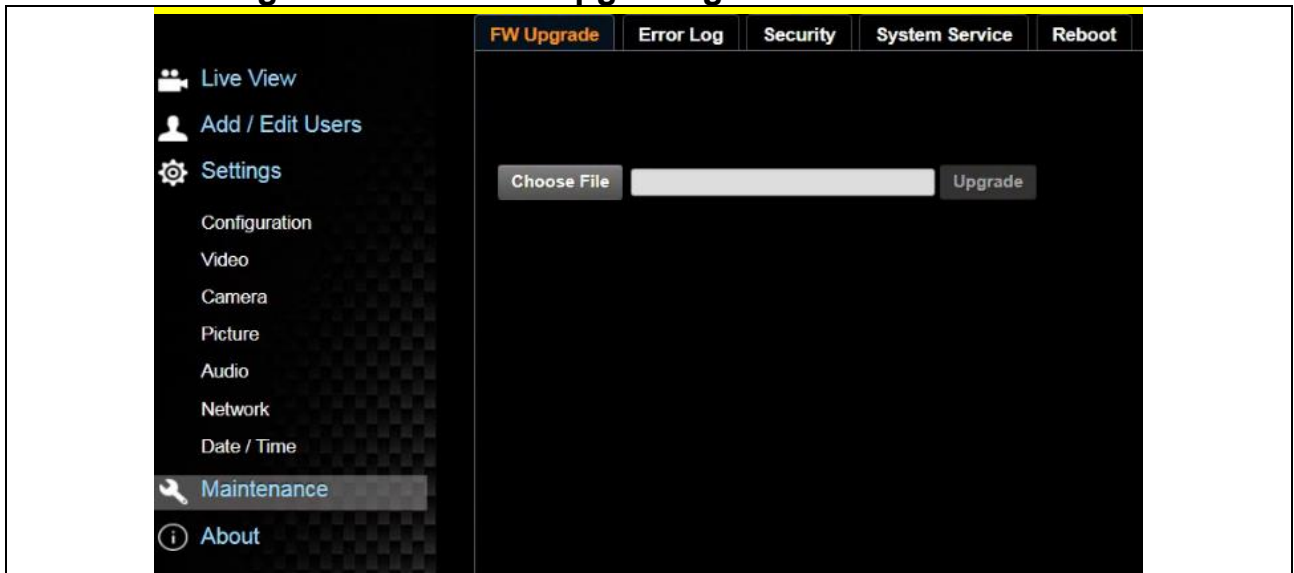

No	Item	Function Descriptions
1	Firmware Update	The camera firmware may be upgraded via web page. For the upgrade method, please download the FW upgrade manual from Lumens official website

### 6.2.12 Setting - Maintenance - Incident Log

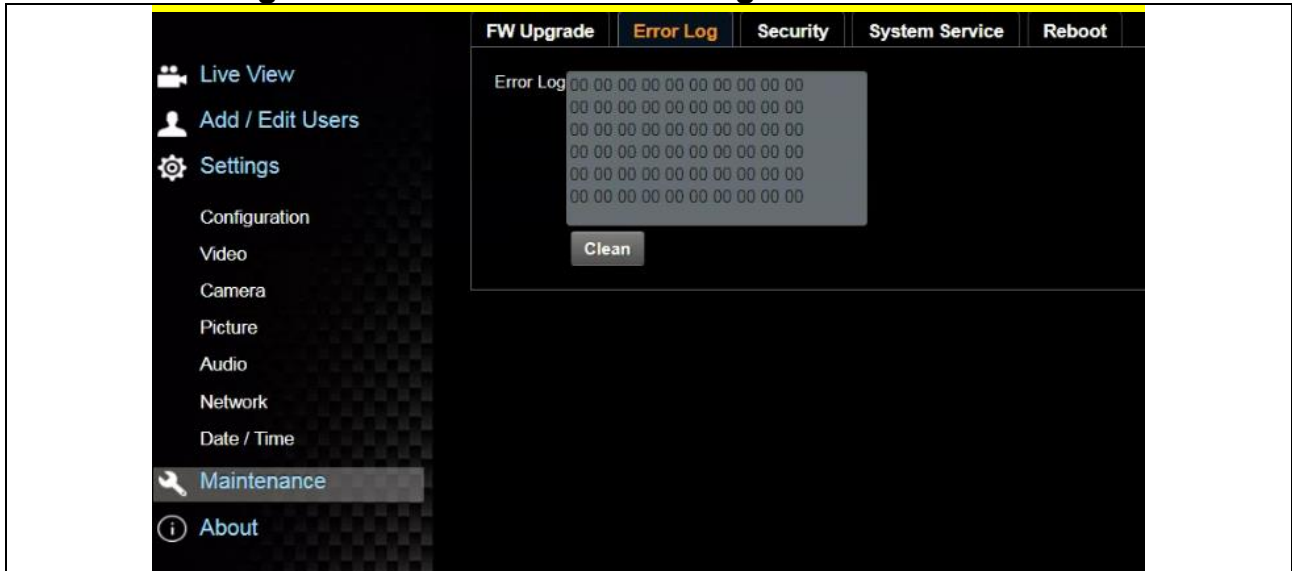

No	Item	Function Descriptions
1	Event Logs	If the camera encounters errors, an error code log will be established <b>&lt;Remark&gt; When an error code appears, please try to clear it to make sure whether the issue has occurred repetitively</b>

### 6.2.13 Setting – Maintenance - Security

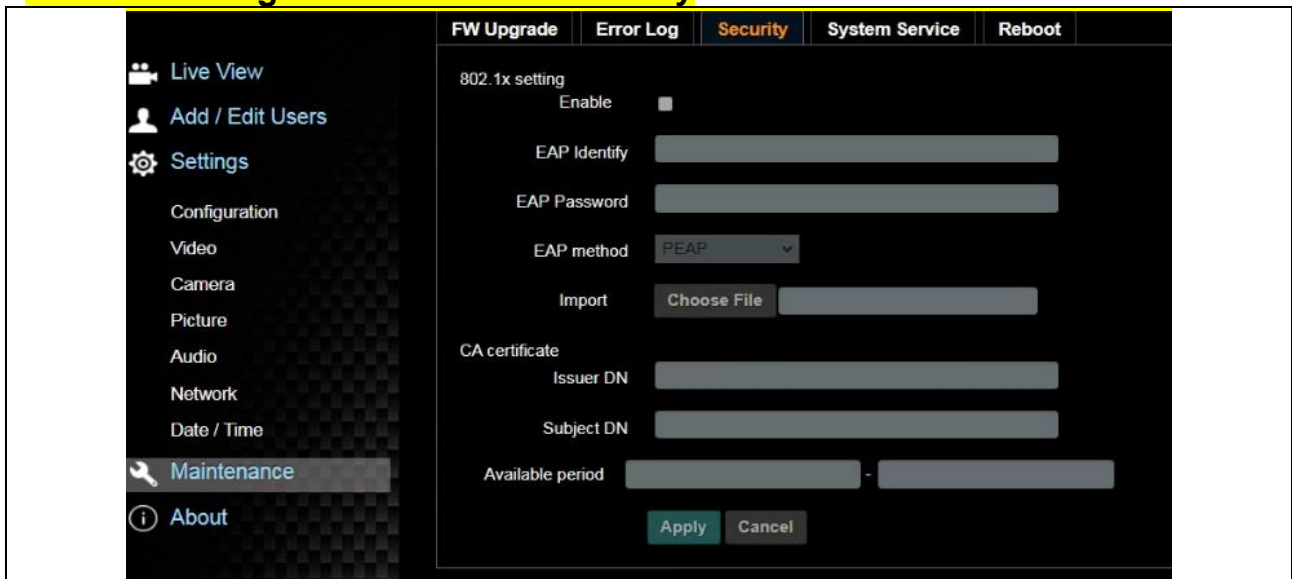

No	Item	Function Descriptions
1	802.1x Setting	Enable/Disable 802.1x Protocol. Setting can be made after enabling. <b>&lt;Remark&gt; In order to enable this function, the router must support 802.1x Protocol.</b>

## 6.2.14 Setting - Maintenance - System Service

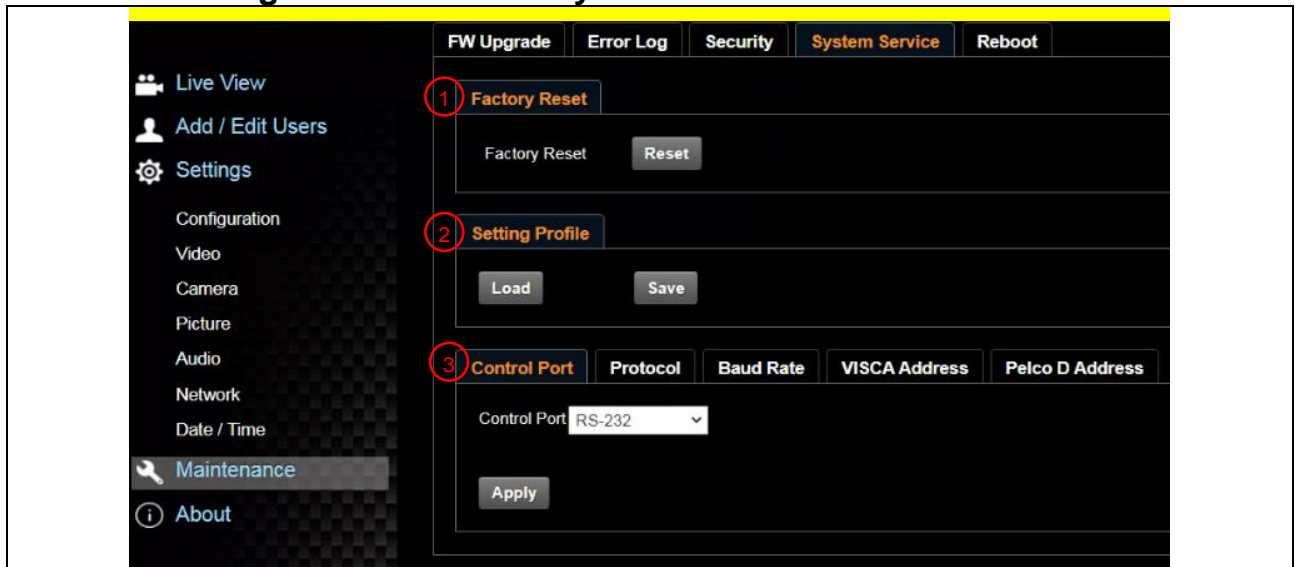

No	Item	Function Descriptions
1	Reset to the default value	Select the reset button to resume the factory default setting as the web page setting
2	Setting File	The web page setting parameters can be exported from the computer and imported/applied to another camera
3	Protocol Setting	Communication protocol related settings for connection with RS-232/RS-422 communication

## 6.2.15 Setting - Maintenance - Reboot

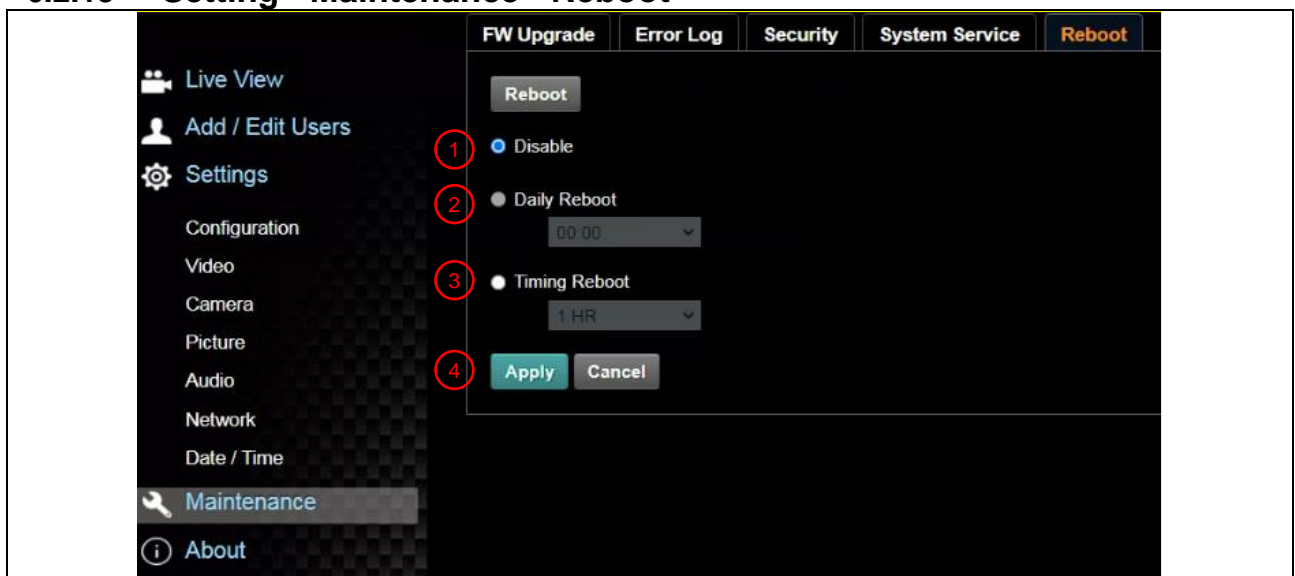

No	Item	Function Descriptions
1	Reboot	Reboot immediately
2	Disable	Disable the reboot settings
3	Daily reboot	Set the daily reboot time <b>&lt;Remark&gt;</b> Please go to <b>Settings - Time</b> to complete the SNTP server synchronization to set daily reboot
4	Timing Reboot	Set the timing reboot time

## 6.2.16 About

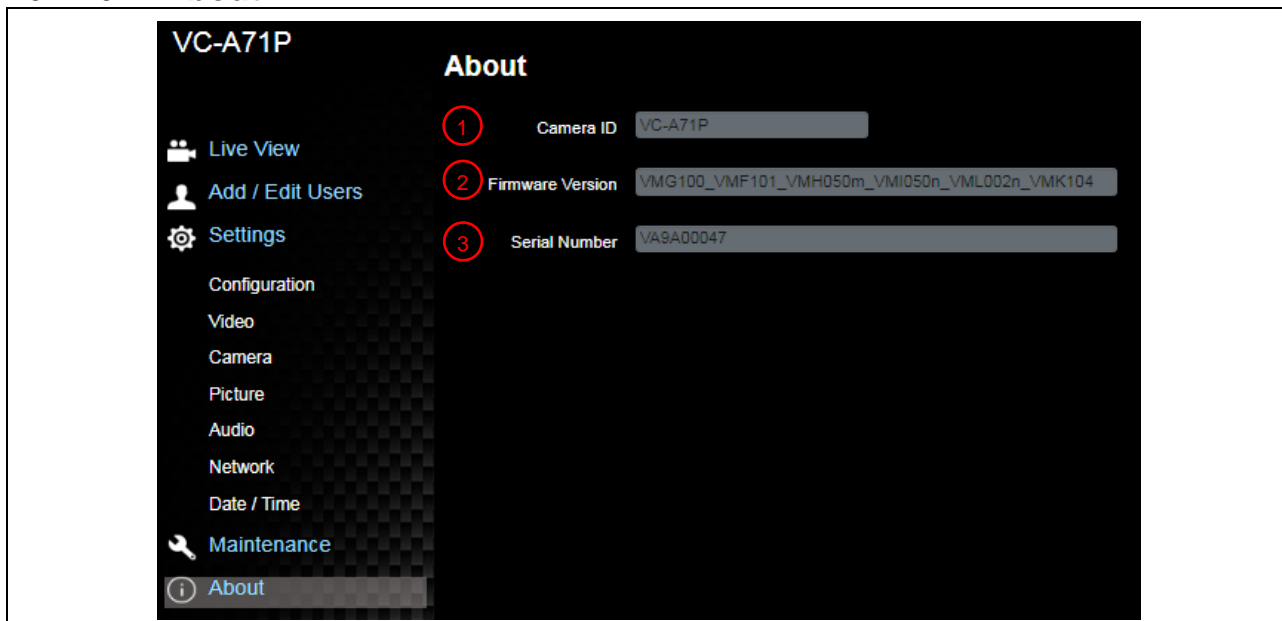

No	Item	Function Descriptions
1	Camera name	Display the camera name
2	Firmware Version	Display the firmware version of the camera
3	Serial No.	Display the camera serial No.

# Chapter 7 DIP Switch Setting

## 7.1 DIP SWITCH

### 7.1.1 OUTPUT Switch (Switch to different output resolutions)

To switch via the OSD/ RS-232 Command is also available based on the last executed action



ID	Resolution	Frame Rate	
0	3840x2160p	59.94	
1		50	
2		29.97	
3		25	
4	1920x1080p	59.94	
5		50	
6		29.97	
7		25	
8	1280x720p	59.94	
9		50	
A		29.97	<b>&lt;Remark&gt;</b> VC-A71PN does not support 720p 29.97/25 fps resolutions
B		25	
C	1920x1080i	59.94	<b>&lt;Remark&gt;</b> 1080i mode only supports HDMI/SDI output. When 1080i mode is set, NDI output is 1080p
D		50	
E	Reserved	Reserved	
F			

### 7.1.2 IR SELECT (Selected by Remote control)

When using the remote control, please make sure the settings of IR SELECT and the Camera Select of the remote control are consistent

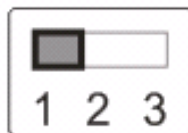

ID	Setting
1	
2	
3	



# Chapter 8 Troubleshooting

This chapter describes problems you may encounter while using VC-A71P/VC-A71PN. If you have questions, please refer to related chapters and follow all the suggested solutions. If the problem still occurred, please contact your distributor or the service center.

No.	Problems	Solutions
1.	Boot without power signal	1. Make sure you have plugged in the power cord. 2. When using a PoE connection, ensure that the power supply supports PoE+ / PoE++ hubs <ul style="list-style-type: none"> <li>■ VC-A71P : PoE++ (IEEE802.3bt)</li> <li>■ VC-A71PN : PoE+ (IEEE802.3at)</li> </ul>
2.	There is no image output from VC-A71P	1. Check the power supply or PoE supply functions. 2. Confirm the output signals are in streaming output. 3. Confirm whether the camera resolution can be used together with the monitor equipment <ul style="list-style-type: none"> <li>■ If 4k output, confirm the monitor equipment supports 4K output</li> </ul> 4. Replace the cables and make sure they are not faulty.
3.	RS-232 cannot be controlled	1. Confirm the connection is correct (RS-232 In/ Out) 2. Please make sure the Baud rate setting is the same as the control equipment
4.	Whether the Internet can be used for operation	Please refer to <a href="#">Chapter 6 Network Function Settings Description</a> for the Internet usage
5.	ONVIF software cannot locate the machine	Please be sure to use only English alphabets or numbers in [Setting]>[Video]> [Camera](Location) of the webpage. Using special characters and pressing the spacebar will cause the ONVIF software unable to locate the machine. <b>&lt;Remark&gt; This is only applicable to VC-A71P. VC-A71PN does not support ONVIF protocol</b>
6.	Tally lamp is not working when applying RS232 setting	Please make sure if the <b>Tally lamp</b> function is enabled from the setting menu or web page. <ul style="list-style-type: none"> <li>■ <b>Setting Menu: System - Tally Lamp</b></li> <li>■ <b>Web page: Setting - Camera - Tally Lamp</b></li> </ul>
7.	The camera does not save the relevant parameters (PTZ, AWB ...) after reboot	Please make sure if the <b>Initial Position</b> is set to <b>Last Operated Position</b> from the setting menu or web page <ul style="list-style-type: none"> <li>■ <b>Setting Menu: System - Initial Position</b></li> <li>■ <b>Web page: Setting - Camera - Pan Tilt Zoom</b></li> </ul>
8.	Tracking Data Output is delayed or not updated	Please make sure that the camera is not in the following conditions. The following function settings may cause data output to be delayed or not updated: <ul style="list-style-type: none"> <li>- Modify output resolution</li> </ul>



		<ul style="list-style-type: none"><li>- Modify camera mode</li><li>- Modify HDMI format</li><li>- Enable screen menu</li><li>- Streaming setting</li><li>- Audio setting</li></ul>
--	--	--

# Supplier's Declaration of Conformity 47 CFR § 2.1077 Compliance Information

**Manufacturer :** Lumens Digital Optics Inc.

**Product Name :** VC-A71P/ VC-A71PN

**Model Number :** 4KPTZ Video Camera

## Responsible Party – U.S. Contact Information

**Supplier :** Lumens Integration, Inc.

4116 Clipper Court, Fremont, CA 94538, United States

**e-mail :** support@mylumens.com

## FCC Compliance Statement

This device complies with Part 15 of the FCC Rules. Operation is subject to the following two conditions : (1) This device may not cause harmful interference, and (2) this device must accept any interference received, including interference that may cause undesired operation.