

# Instruction Sheet

## Model LS9128

# LUXOR

INNOVATIVE WORKSPACE PRODUCT SOLUTIONS

Customer Service Department

2245 Delany Rd

Waukegan, IL 60087

Ph: 847-244-1800 \* 800-323-4656

Fax: 847-244-1818 \* 800-327-1698



## Parts List

Wood top = 1

Right leg = 1

Left leg = 1

Base = 1

Upper support = 1

Tension knob = 1

Tilt guide knob = 1

Tilt guide = 1

Plastic collar = 1

Paper guard = 1

Caster with brake = 2

Caster without brake = 2

Inner plastic collar = 1

Allen wrench = 1

1/2" bolt = 12

Locking nut = 1

Washer = 1

Washer (large) = 1

### Step 1

Identify parts.  
Attach the tilt guide to the upper support using 1/2" bolt, one washer and one locking nut.

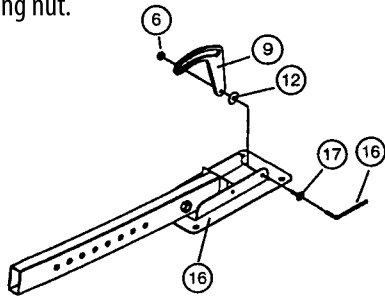

### Step 2

Insert the shorter threaded knob and one washer through the tilt guide and into the threaded hole on the upper support.

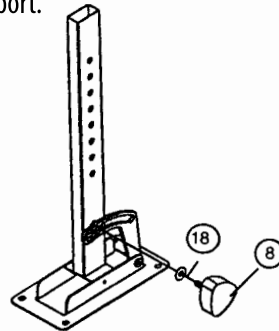

### Step 3

Align the four holes on the upper support to the four holes on the top and bolt down with 1/2" bolts. Attach paper guard to the two threaded holes on the wood top using two 1/2" bolts.

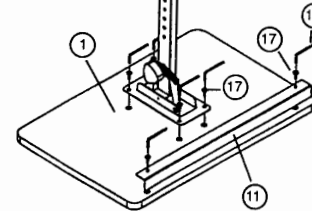

### Step 4

Slide the locking collar and the inner plastic collar onto the upper support.

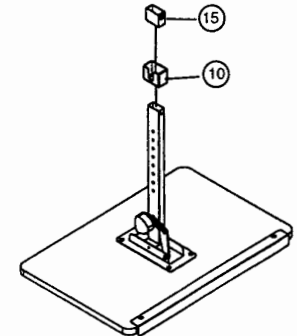

### Step 5

Align the inner plastic collar to the hole on the bottom of the upper support and attach with 1/2" bolt.

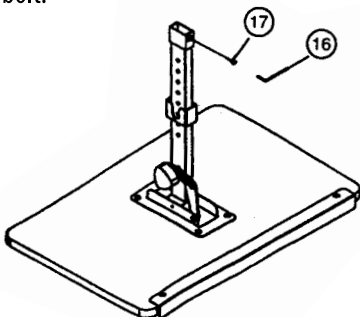

### Step 6

Install casters to the right and left legs. Casters with brake go opposite of the two holes on the side of the legs.

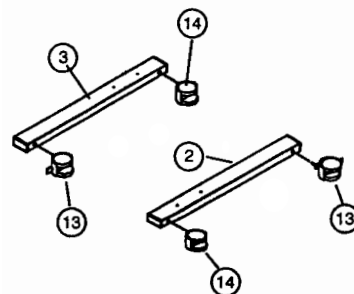

### Step 7

Align the two holes on the left and right legs to the two holes on the leg support on the base. Bolt down using four - 1/2" bolts.

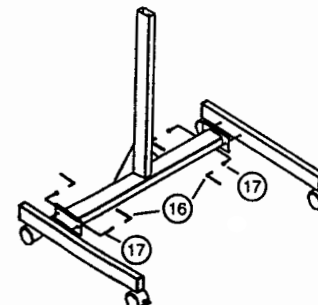

### Step 8

Slide assembled top half onto the base. Align hole on the upper support to the threaded hole on the base to desired height and tighten down with tension knob.

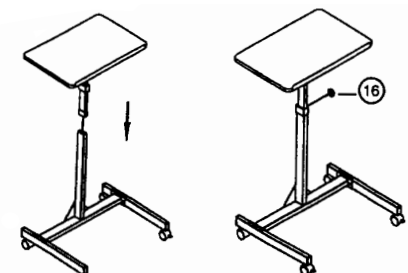

# Parts List

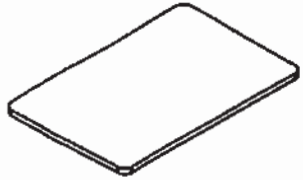

Wood top = 1

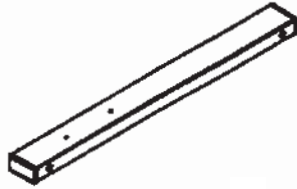

Right leg = 1

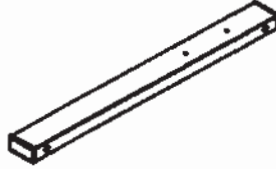

Left leg = 1

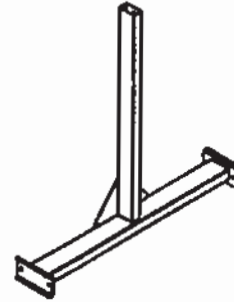

Base = 1

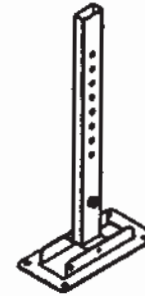

Upper support = 1



Locking nut = 1



Tension knob = 1

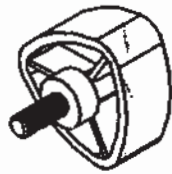

Tilt guide knob = 1

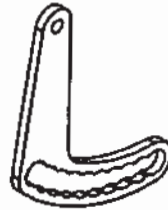

Tilt guide = 1

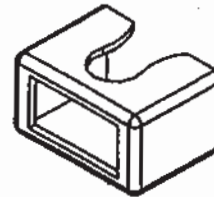

Plastic collar = 1



Paper guard = 1



Washer = 1



Caster = 2  
(with brake)



Caster = 2  
(without brake)

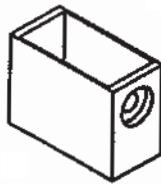

Inner plastic collar = 1

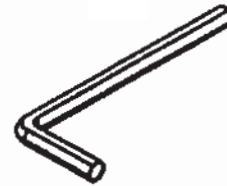

Allen wrench = 1



1/2" bolt = 12



Washer = 1  
(large)