

Mobile Music Board Instructions

01/18/17

Note: After assembly, peel the protective film from both sides of the board.

Cleaning Tip: A mild dish washing liquid can be used with a soft cloth to clean the writing surface.



Parts List

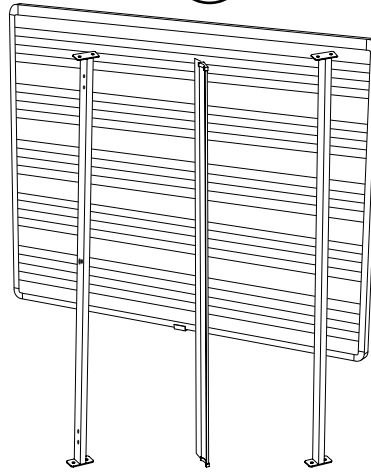
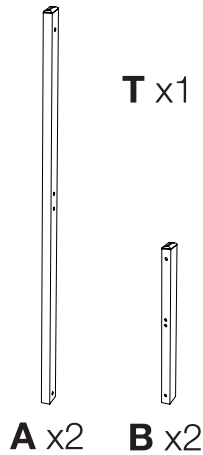

Tools Required

- Additional Wrench

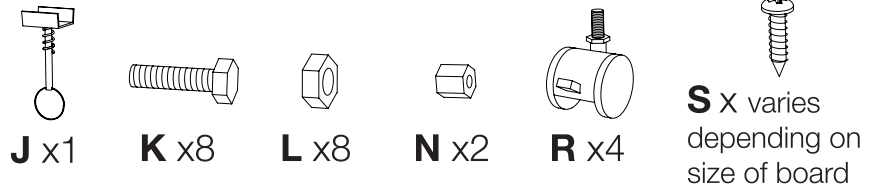
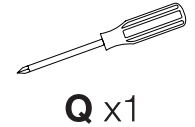
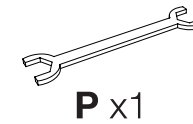

205 Westwood Ave, Long Branch, NJ 07740
 Phone: 866-94 BOARDS (26273) / (732)-222-1511
 Fax: (732)-222-7088 | E-mail: sales@touchboards.com

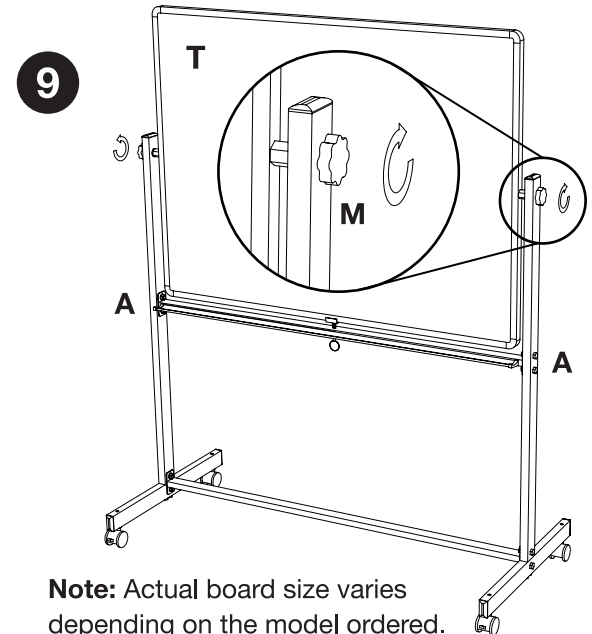
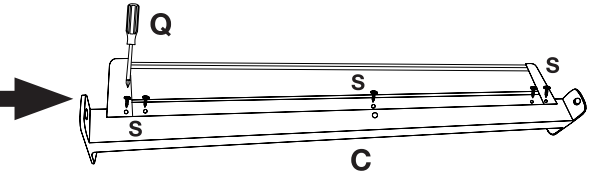
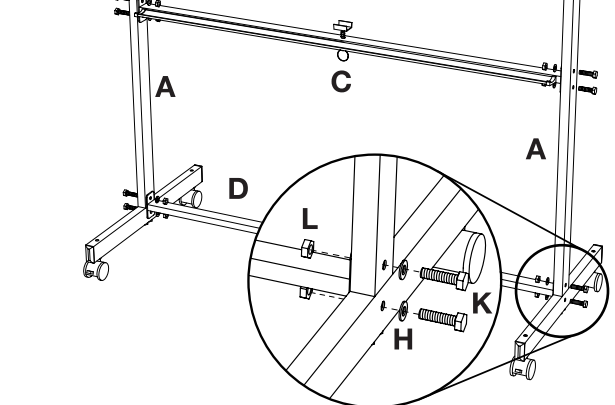
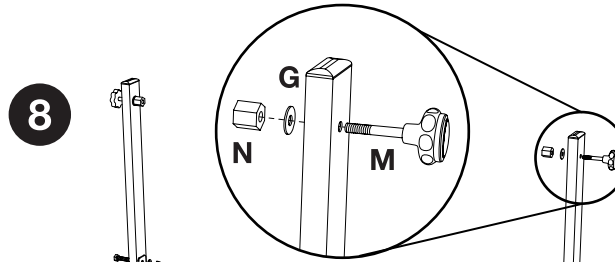
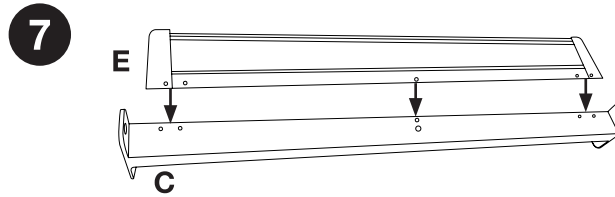
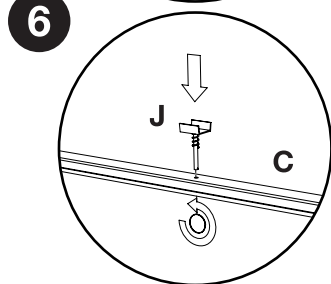
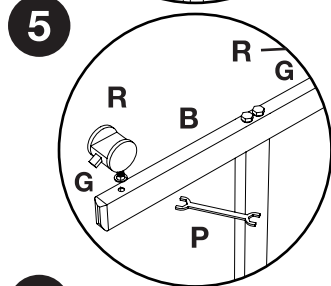
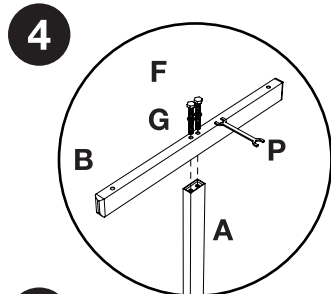
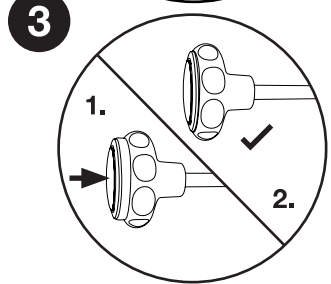
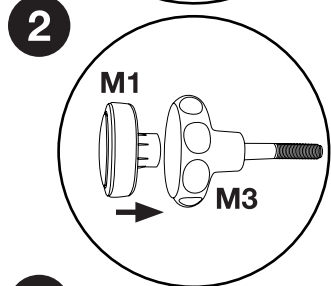
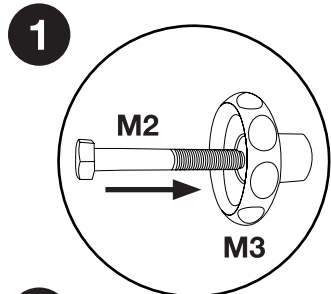

Note: Actual board size varies depending on the model ordered.