

# Mobile Acrylic Divider Instructions

07/24/20

## Parts List

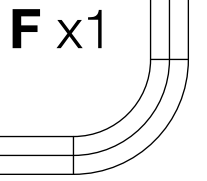
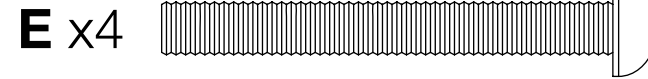
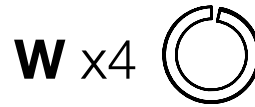
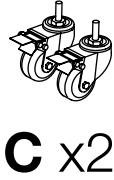
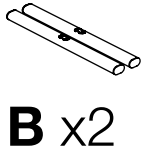
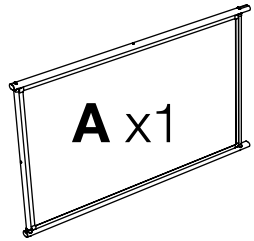

**1**

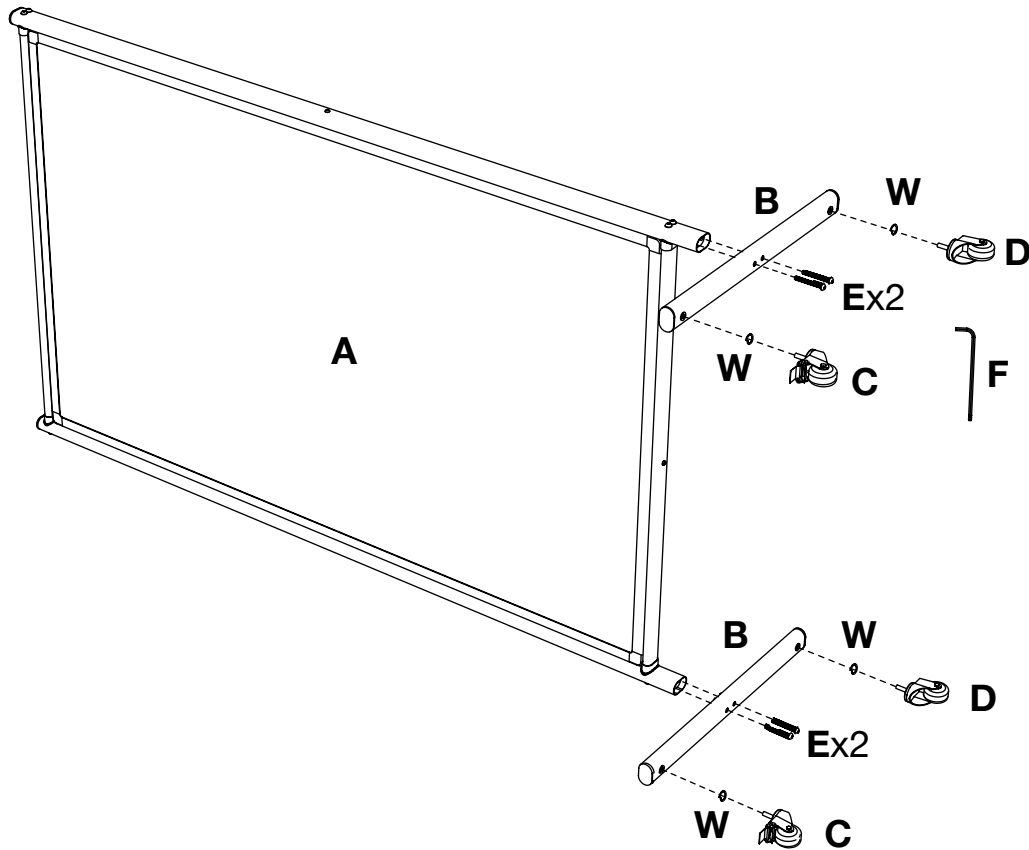

**2**

