

# INSTRUCTIONS - MOBILE CLASS BOARD

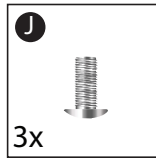

## STEP 1

Note the orientation markings for the holes

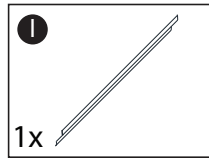
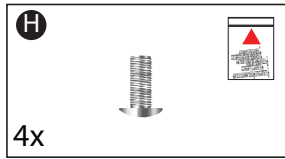
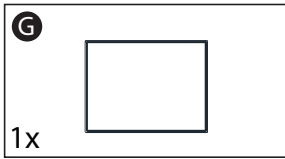
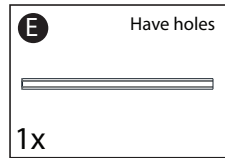
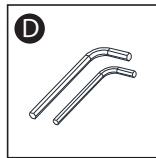
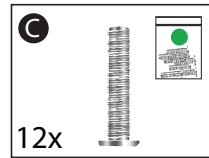
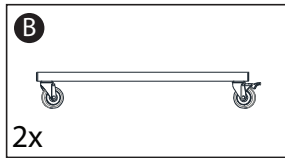
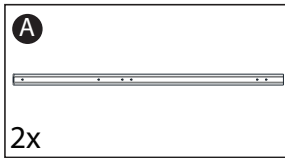
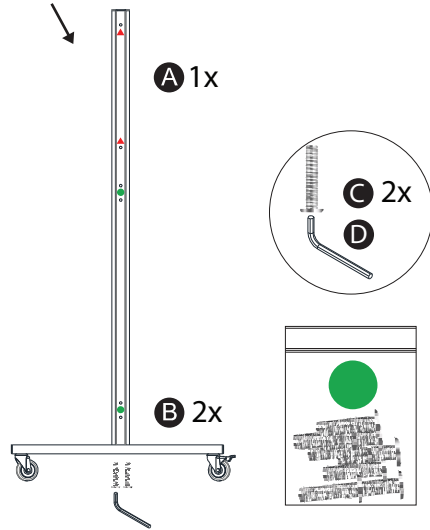

## STEP 2

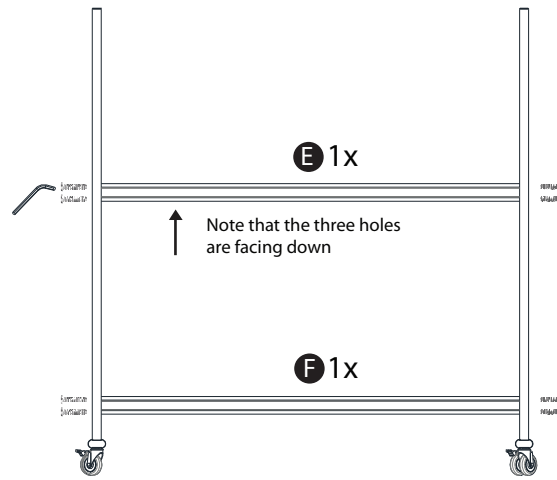

Two people together to complete

## STEP 3

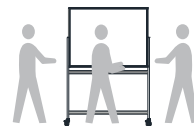
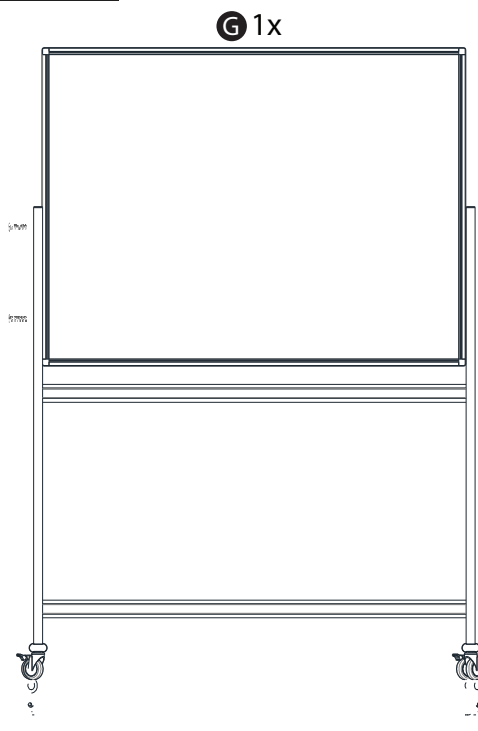

Three people together to complete

## STEP 4

