

M70W

Instruction Manual







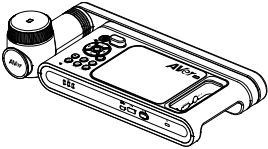

Content

Package Contents.....	1
Optional Accessories	1
Overview	2
Compound Key	2
Remote Controller.....	3
LED Indicator	4
Device Connection.....	5
Power Connection and Charging	5
USB Connection.....	6
HDMI Connection.....	7
P2P connection via Wi-Fi Dongle	7
Wi-Fi Connection	10
Miracast Connection	11
Using the Camera	13
Object Position	13
Shooting Area.....	13
Storage the Camera	14
Mounting the Camera on a Flat Surface	14
Specification.....	15

Package Contents

The items below are included with this product. If any item is missing, contact the dealer from whom you purchased this product.

M70W unit	Remote controller	Power Adaptor Power cord*	USB Cable
			
AAA Batteries	Quick Guide	Wi-Fi Dongle	
			

*The power cord will vary depending on the standard power outlet of the country where it is sold.

Optional Accessories



Carrying Bag

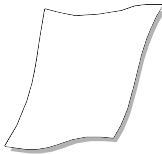

Anti-glare Sheet

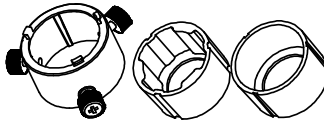

Microscope Adapter

(28mm and 34mm Rubber Coupler are included)

Overview

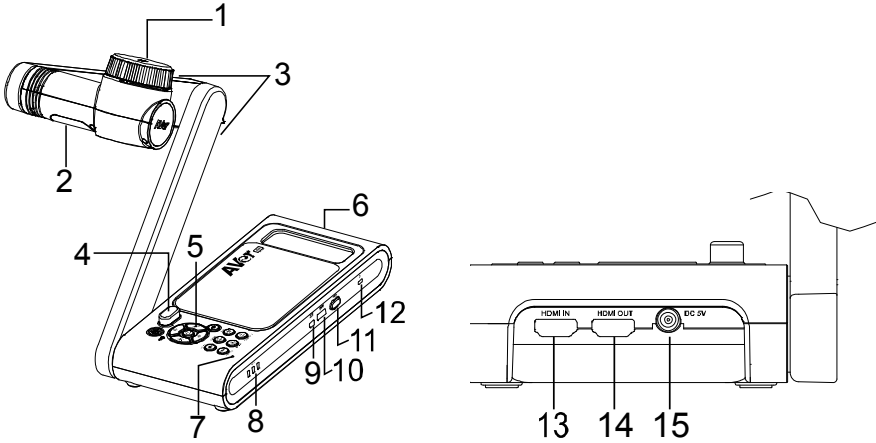

1. Camera head	2. LED lighting
3. Arm	4. IR sensor
5. Control panel	6. Handle
7. Built-in MIC	8. Battery Indicator
9. USB mini port	10.USB port
11.Wi-Fi dongle	12.Anti-theft Slot
13.HDMI Input	14.HDMI Output
15.DC power jack	

Compound Key

Back to factory default settings.



Press to switch between following modes:
 - Auto detects the best resolution(4K, 720P, 1080P)
 - 1024x768 (If HDMI device support)
 - 4K 60Hz (If HDMI device support)

Press to switch between following modes:
 Normal, High frame, High quality, Microscope,
 Infinity, Marco

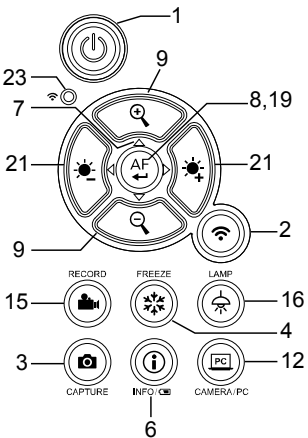
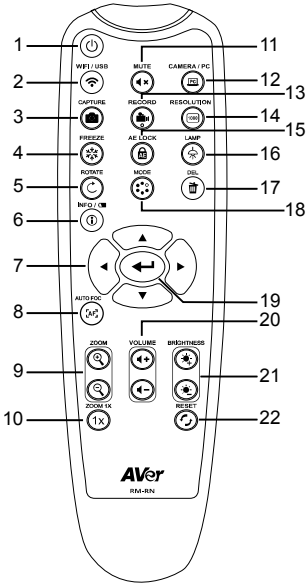

Remote Controller



Name	Function
(1) POWER	Turn the unit on/off/standby.
(2) WiFi/USB	Switch between WiFi and USB mode.
(3) CAPTURE	Capture still image in Camera mode. In continuous capture mode, press this button again to stop.
(4) FREEZE	Freeze live images.
(5) ROTATE	Rotate the image by 0/180° in Camera mode.
(6) INFO/	Press to view system information and battery power status.
(7) ▲, ▼, ◀, & ▶	Pan and zoom-in image in live streaming.
(8) AUTO FOC	Adjust the focus automatically.
(9) ZOOM +/-	Increase/decrease the image magnification in camera mode.
(10) ZOOM 1X	Reset zoom level to 100%.
(11) MUTE	Set the volume to mute.
(12) CAMERA / PC	Switch the video signal between camera and computer from the HDMI Input port
(13) RECORD	Start/Stop audio & video recording. Video recording can only be saved in a USB flash drive.
(14) RESOLUTION	Press to switch between following modes: - Auto detects the best resolution(4K, 720P, 1080P) - 1024x768 (If HDMI device support) - 4K 60Hz (If HDMI device support)
(15) AE LOCK	Lock the exposure to stop M70W attempting to find optimal exposure.
(16) LAMP	Turn the overhead light on/off.
(17) DEL	Delete the selected picture/video in Playback mode.

(18) MODE	Press to switch between Normal, High frame, and High quality, Microscope, Infinity, or Marco mode.
(19) ◀	Make a selection.
(20) VOLUME +/-	Adjust the volume.
(21) BRIGHTNESS +/-	Adjust the brightness.
(22) RESET +/-	Reset to factory default setting.
(23) WiFi indicator	WiFi status indicator: Please refer to LED Indicator section.

LED Indicator

Name	Status indicator
Power 	Solid green: Power on No light: Power off Solid red: Standby mode
Battery 	Solid green(x3): Battery is full(100% ~ 60%) Solid green(x2): Battery is 60% ~ 30% Solid green(x1): Battery is 30% ~ 5% Solid red (x1): Battery is 5% ~ 0% Flashing red (x1): Battery is out of power Solid orange(x3): Battery is abnormal
WiFi 	Solid blue: AP Mode Ready / STA connected Slow flashing blue: Software connection with camera Short flashing blue: Create AP mode / STA connecting Solid green: Miracast mode ready Slow flashing green: Miracast streaming start Quick flashing green: Miracast device scan / connecting

[Note]

1. The battery will be exhausted for long-term usage. Do not replace the battery by yourself. Please contact your dealer.
2. To complete turn off camera, press and long press the power button.

Device Connection

Power Connection and Charging

1

Plug in power adapter and turn on M70W.

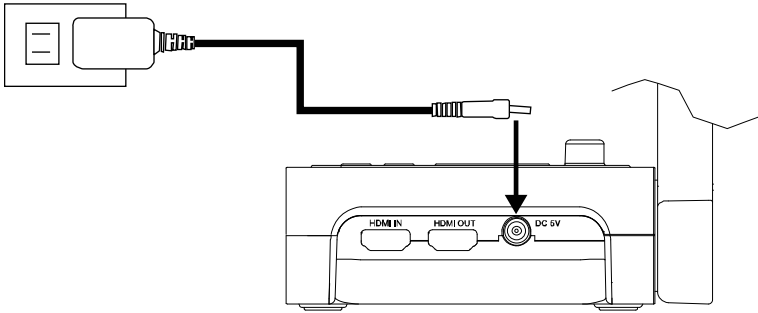

[Note]

- **Please full charge the camera for the first time use.**
- When the camera is power on, the camera is in “**Standby**” mode. In standby mode, it can be charging with the USB connection between other devices; but the power supply is required 5V2A and the charging time will be longer.
- The laptop, projector, or monitor **cannot** provide the power through the USB connection to the camera while the camera is operating.
- When the camera is charging with the wall outlet, the battery indicator is in green flashing.
- Press (AF) + (Q) when the camera doesn't work properly. The camera back to standby mode.

USB Connection

1 Connect M70W to laptop/PC with USB port.

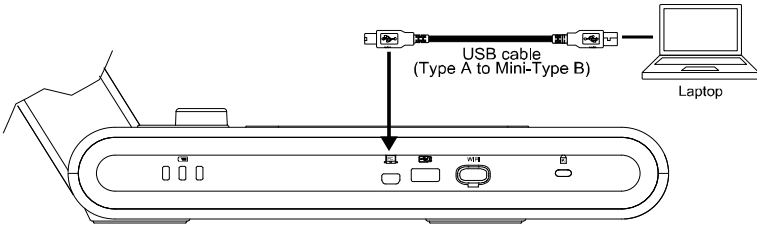

2 Connect USB pen drive to USB port to save the recording file.

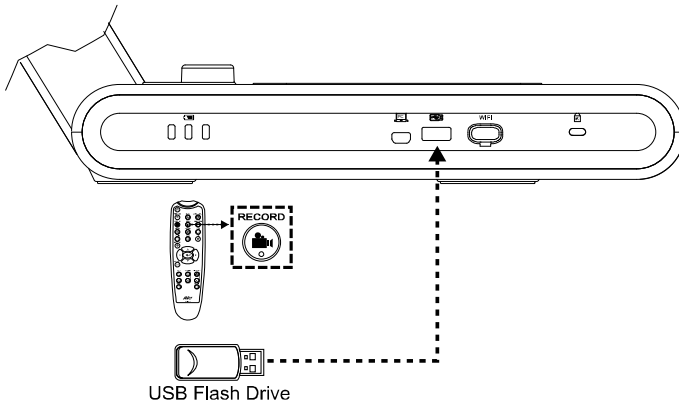

HDMI Connection

1

Connect M70W to HDMI display with HDMI output port.

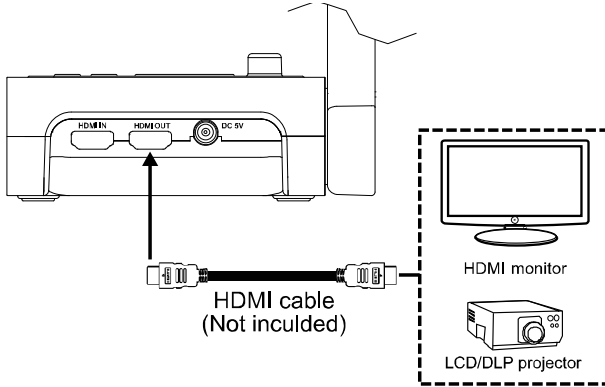

2

Connect M70W to laptop/PC with HDMI input port.

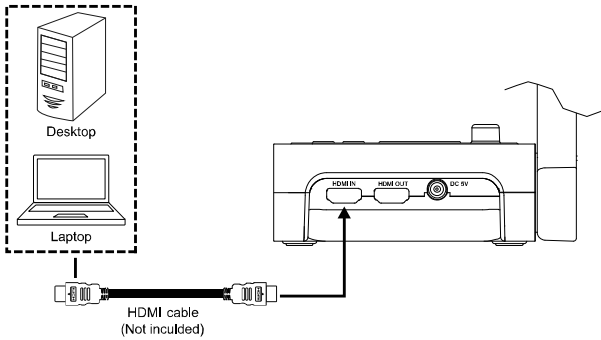

P2P connection via Wi-Fi Dongle

1 Plug-in the WiFi dongle to PC/laptop and Install AVerTouch application.

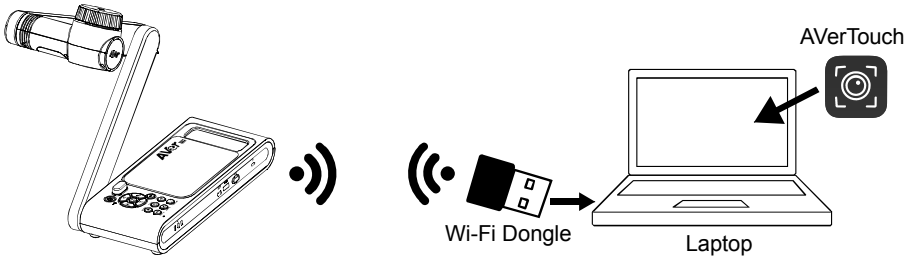

2 Open AVerTouch application, click  to connect the camera.



[Note] Check the serial number at bottom of the camera to find your camera.

3 Click Next to continue.

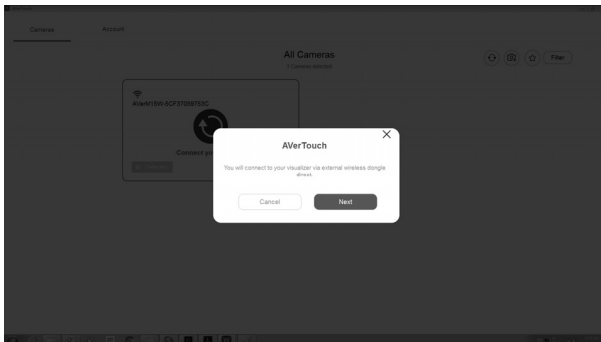

4

Entering the Camera Name and Passcode, click Done to continue.

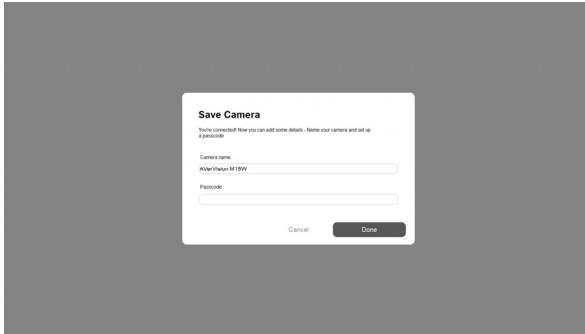

5

Click Done button to connect camera.



[Note] It takes about 60 seconds to complete connection.

6

Select X can exit the live view page.



[Note] When connecting is successful, you should see the live view of the camera.

Wi-Fi Connection

1 **Power on the camera.** **Check the Wi-Fi status – Blue light on.**

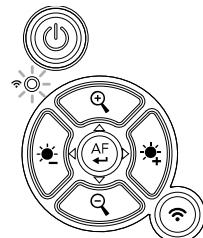
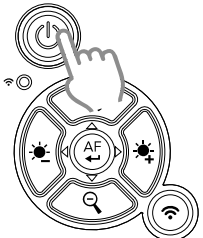

RECORD FREEZE LAMP
CAPTURE INFO/CAM CAMERA/PC

RECORD FREEZE LAMP
CAPTURE INFO/CAM CAMERA/PC

2 **Open AVerTouch and follow on-screen instruction to enable Wi-Fi function on camera.**

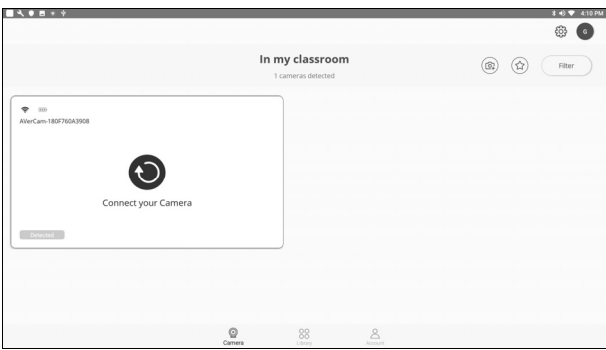

[Note]

- The software will auto detect the camera on your network.
- Select the camera that you want to connect with it.
- The camera name will be "AVer 'model name' - WiFi dongle Mac address". The Mac address will be different from the device.

3

Select the  to make a connection with the camera.

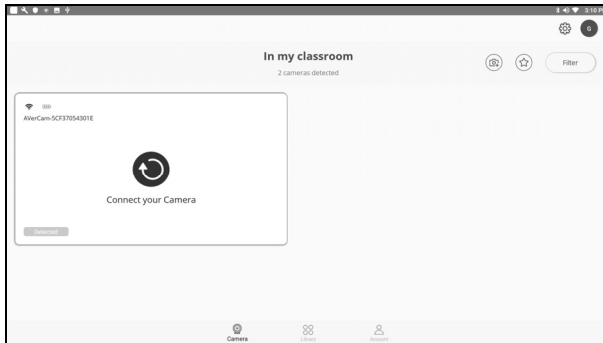

4

Select  to switch to camera live screen.

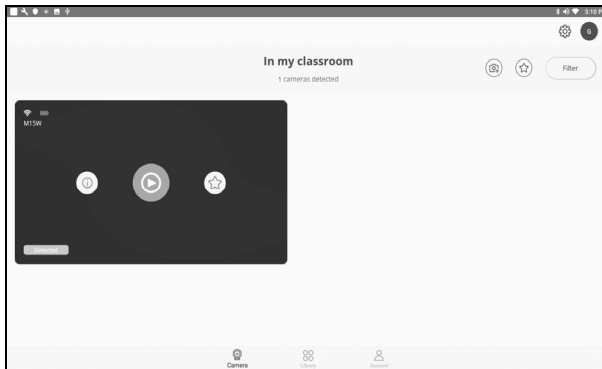



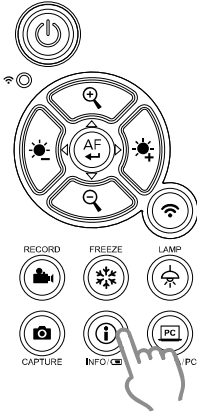

Miracast Connection

1

Press  to enter selection menu.



[Note]

- Use , , , and  button to move between the selections and press  button to confirm the selection.
- Make sure M70W and display device (such as an Interactive flat panel) are on same Wi-Fi network and Wi-Fi is connected.
- A commercial Miracast Dongle (Wireless Adapter) is required for the display device.

2

Select **Wireless > Mode > Miracast** to enable Miracast mode.

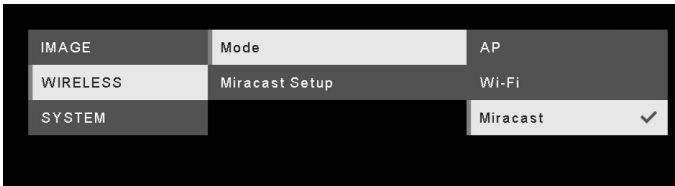

3

The camera image will display on the display device's screen.

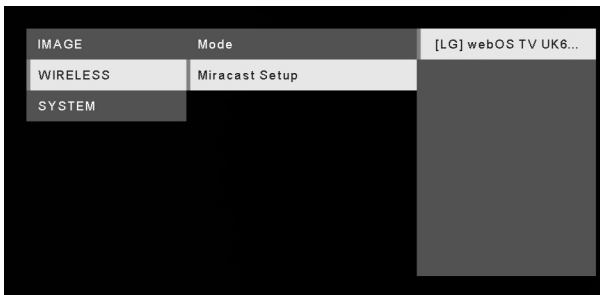

[Note]

- Press  back to the menu.
- The detected display devices will be listed out.
- The camera image will display on the display device's screen after connecting.

Using the Camera

Object Position

The icon on top of camera head can help user to place objects in a positive direction.

The direction wheel can turn 90° to change the icon in 2 positions (refer to figure).

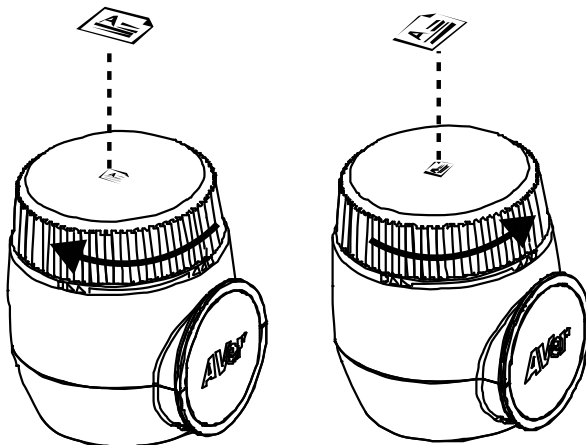

Shooting Area

When camera position is 470mm high, the shooting area will be A3 size.

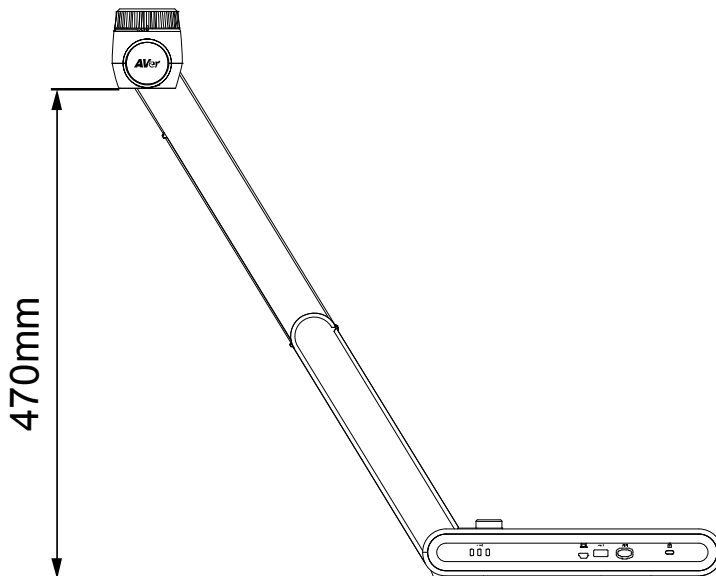

Storage the Camera

1

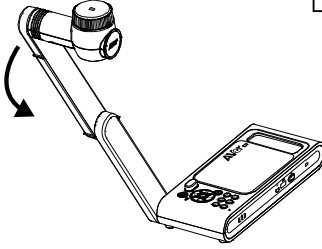

2

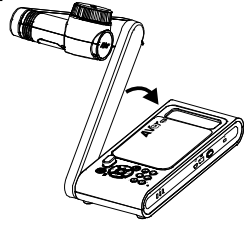

3

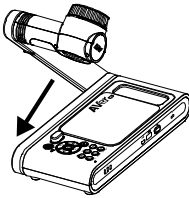

4

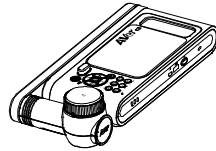

Mounting the Camera on a Flat Surface

[Note] M4 screw x4, depth is 5mm.

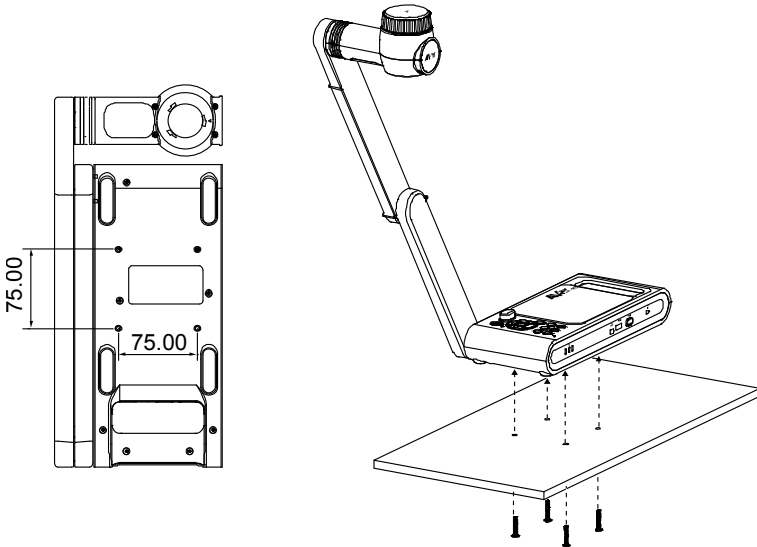

Specification

Sensor	1/3.2 CMOS
Pixel Count	13 megapixels
Frame Rate	60 fps (max.)
Image mode	Normal / High Frame / High Quality/ Microscope/Infinity/Marco
Effect	Rotate / Freeze
HDMI Output	4K; Full HD 1080p 60Hz; HD 720p 60Hz
Focusing	Auto / Manual/ Area (SW)
Shooting Area	480mm x345mm @ 470 mm
Zooming	Total 230X maximum(10x AVerZOOM™ + 23X Digital zoom)
Dual Mode	AP / Station DHCP(Server/Client)
WiFi Streaming	1080P@30fps, up to 4K@30fps
Dual Band	5GHz/2.4GHz
Miracast	Yes
Compatibility	802.11a/b/g/n/ac (45 ft effective range)
Wireless Security	Support WEP, WPA/WPA2-PSK, WPA/WPA2-Enterprise* *EAP-PEAP, EAP-TLS
Power Source	DC5V/ 2A, AC 100-240V
Consumption	8.7 Watts(lamp on) 7.7 Watts(lamp off)
USB Bus Power	Yes(Standby mode only)
Lamp Type	LED light
USB	USB2.0 Type-A x2 (WiFi Dongle, USB storage) USB Type mini-B x 1
DC 5V Input	Power Jack
MIC	Built-in
Operating	587mm(L)*159 mm(W)*546mm(H) (+/-2mm include rubber foot)
Folded	363.5mm(L)*159mm(W)*76.3mm(H) (+/-2mm include rubber foot)
Weight	2.6 kg (about 5.7lbs)
Software Supported	ePTZ Image/ Area capture Picture by Picture Timer Cloud library Recording Annotation

WARNING

- To reduce the risk of fire or electric shock, do not expose this appliance to rain or moisture. Warranty will be void if any unauthorized modifications are done to the product.
- Do not drop the camera or subject it to physical shock.
- Use the correct power supply voltage to avoid the damaging camera.
- Do not place the camera where the cord can be stepped on as this may result in fraying or damage to the lead or the plug.
- Hold the bottom of the camera with both hands to move the camera. Do not grab the lens or Flexible arm to move the camera.
- Do not pull the mechanical arm and camera part in the opposite direction.

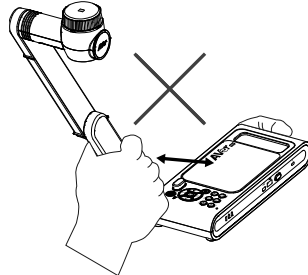
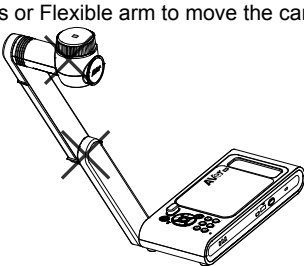

RADIO FREQUENCY

FOR PORTABLE DEVICE USAGE (<20m from body/SAR needed eg. BT dongle, smartphone)

Radiation Exposure Statement:

The product comply with the FCC portable RF exposure limit set forth for an uncontrolled environment and are safe for intended operation as described in this manual. The further RF exposure reduction can be achieved if the product can be kept as far as possible from the user body or set the device to lower output power if such function is available.

FOR MOBILE DEVICE USAGE (>20cm/low power eg. AP routers)

Radiation Exposure Statement:

This equipment complies with FCC radiation exposure limits set forth for an uncontrolled environment. This equipment should be installed and operated with minimum distance 20cm between the radiator & your body.

RADIO FREQUENCY

Europe – EU Declaration of Conformity

This device complies with the essential requirements of the Radio Equipment Directive (2014/53/EU). The following test methods have been applied in order to prove presumption of conformity with the essential requirements of the Radio Equipment Directive (2014/53/EU)

CAUTION

- Risk of explosion if battery is replaced by an incorrect type.
- Dispose of used batteries in a safe and proper manner.

FEDERAL COMMUNICATIONS COMMISSION

This device complies with Part 15 of the FCC Rules. Operation is subject to the following two conditions: (1) This device may not cause harmful interference, and (2) this device must accept any interference received, including interference that may cause undesired operation.

This equipment has been tested and found to comply with the limits for a Class B digital device, pursuant to Part 15 of the FCC Rules. These limits are designed to provide reasonable protection against harmful interference in a residential installation. This equipment generates uses and can radiate radio frequency energy and, if not installed and used in accordance with the instructions, may cause harmful interference to radio communications. However, there is no guarantee that interference will not occur in a particular installation. If this equipment does cause harmful interference to radio or television reception, which can be determined by turning the equipment off and on, the user is encouraged to try to correct the interference by one of the following measures:

- Reorient or relocate the receiving antenna.
- Increase the separation between the equipment and receiver.
- Connect the equipment into an outlet on a circuit different from that to which the receiver is connected.
- Consult the dealer or an experienced radio/TV technician for help.

FCC Caution: Any changes or modifications not expressly approved by the party responsible for compliance could void the user's authority to operate this equipment.



THE MARK OF CROSSED-OUT WHEELED BIN INDICATES THAT THIS PRODUCT MUST NOT BE DISPOSED OF WITH YOUR OTHER HOUSEHOLD WASTE. INSTEAD, YOU NEED TO DISPOSE OF THE WASTE EQUIPMENT BY HANDING IT OVER TO A DESIGNATED COLLECTION POINT FOR THE RECYCLING OF WASTE ELECTRICAL AND ELECTRONIC EQUIPMENT. FOR MORE INFORMATION ABOUT WHERE TO DROP OFF YOUR WASTE EQUIPMENT FOR RECYCLING, PLEASE CONTACT YOUR HOUSEHOLD WASTE DISPOSAL SERVICE OR THE SHOP WHERE YOU PURCHASED THE PRODUCT.

DISCLAIMER

No warranty or representation, either expressed or implied, is made with respect to the contents of this documentation, its quality, performance, merchantability, or fitness for a particular purpose. Information presented in this documentation has been carefully checked for reliability; however, no responsibility is assumed for inaccuracies. The information contained in this documentation is subject to change without notice.

In no event will AVer be liable for direct, indirect, special, incidental, or consequential damages arising out of the use or inability to use this product or documentation, even if advised of the possibility of such damages.

COPYRIGHT

©2019 AVer Information Inc. All rights reserved.

More Help

For FAQs, technical support, software and instruction manual download, please visit:

<https://www.averusa.com/education/support/>

Contact Information

AVer Information Inc.

www.averusa.com

668 Mission Ct.

Fremont, CA 94539, USA

Toll-free: 1(877)528-7824

Local: 1(408)263-3828

Support.usa@aver.com

