



**MDO3000 Series
Mixed Domain Oscilloscopes
User Manual**



077-0968-02



**MDO3000 Series
Mixed Domain Oscilloscopes
User Manual**

Copyright © Tektronix. All rights reserved. Licensed software products are owned by Tektronix or its subsidiaries or suppliers, and are protected by national copyright laws and international treaty provisions.

Tektronix products are covered by U.S. and foreign patents, issued and pending. Information in this publication supersedes that in all previously published material. Specifications and price change privileges reserved.

TEKTRONIX and TEK are registered trademarks of Tektronix, Inc.

e*Scope, iView, OpenChoice, and TekSecure, and TekVPI are registered trademarks of Tektronix, Inc.

MagniVu and Wave Inspector are trademarks of Tektronix, Inc.

PictBridge is a registered trademark of the Standard of Camera & Imaging Products Association CIPA DC-001-2003 Digital Photo Solutions for Imaging Devices.

Contacting Tektronix

Tektronix, Inc.
14150 SW Karl Braun Drive
P.O. Box 500
Beaverton, OR 97077
USA

For product information, sales, service, and technical support:

- In North America, call 1-800-833-9200.
- Worldwide, visit www.tek.com to find contacts in your area.

Warranty

Tektronix warrants that the product will be free from defects in materials and workmanship for a period of three (3) years from the date of original purchase from an authorized Tektronix distributor. If the product proves defective during this warranty period, Tektronix, at its option, either will repair the defective product without charge for parts and labor, or will provide a replacement in exchange for the defective product. Batteries are excluded from this warranty. Parts, modules and replacement products used by Tektronix for warranty work may be new or reconditioned to like new performance. All replaced parts, modules and products become the property of Tektronix.

In order to obtain service under this warranty, Customer must notify Tektronix of the defect before the expiration of the warranty period and make suitable arrangements for the performance of service. Customer shall be responsible for packaging and shipping the defective product to the service center designated by Tektronix, shipping charges prepaid, and with a copy of customer proof of purchase. Tektronix shall pay for the return of the product to Customer if the shipment is to a location within the country in which the Tektronix service center is located. Customer shall be responsible for paying all shipping charges, duties, taxes, and any other charges for products returned to any other locations.

This warranty shall not apply to any defect, failure or damage caused by improper use or improper or inadequate maintenance and care. Tektronix shall not be obligated to furnish service under this warranty a) to repair damage resulting from attempts by personnel other than Tektronix representatives to install, repair or service the product; b) to repair damage resulting from improper use or connection to incompatible equipment; c) to repair any damage or malfunction caused by the use of non-Tektronix supplies; or d) to service a product that has been modified or integrated with other products when the effect of such modification or integration increases the time or difficulty of servicing the product.

THIS WARRANTY IS GIVEN BY TEKTRONIX WITH RESPECT TO THE PRODUCT IN LIEU OF ANY OTHER WARRANTIES, EXPRESS OR IMPLIED. TEKTRONIX AND ITS VENDORS DISCLAIM ANY IMPLIED WARRANTIES OF MERCHANTABILITY OR FITNESS FOR A PARTICULAR PURPOSE. TEKTRONIX' RESPONSIBILITY TO REPAIR OR REPLACE DEFECTIVE PRODUCTS IS THE SOLE AND EXCLUSIVE REMEDY PROVIDED TO THE CUSTOMER FOR BREACH OF THIS WARRANTY. TEKTRONIX AND ITS VENDORS WILL NOT BE LIABLE FOR ANY INDIRECT, SPECIAL, INCIDENTAL, OR CONSEQUENTIAL DAMAGES IRRESPECTIVE OF WHETHER TEKTRONIX OR THE VENDOR HAS ADVANCE NOTICE OF THE POSSIBILITY OF SUCH DAMAGES.

[W16 – 15AUG04]

Warranty

Tektronix warrants that the product will be free from defects in materials and workmanship for a period of one (1) year from the date of original purchase from an authorized Tektronix distributor. If the product proves defective during this warranty period, Tektronix, at its option, either will repair the defective product without charge for parts and labor, or will provide a replacement in exchange for the defective product. Batteries are excluded from this warranty. Parts, modules and replacement products used by Tektronix for warranty work may be new or reconditioned to like new performance. All replaced parts, modules and products become the property of Tektronix.

In order to obtain service under this warranty, Customer must notify Tektronix of the defect before the expiration of the warranty period and make suitable arrangements for the performance of service. Customer shall be responsible for packaging and shipping the defective product to the service center designated by Tektronix, shipping charges prepaid, and with a copy of customer proof of purchase. Tektronix shall pay for the return of the product to Customer if the shipment is to a location within the country in which the Tektronix service center is located. Customer shall be responsible for paying all shipping charges, duties, taxes, and any other charges for products returned to any other locations.

This warranty shall not apply to any defect, failure or damage caused by improper use or improper or inadequate maintenance and care. Tektronix shall not be obligated to furnish service under this warranty a) to repair damage resulting from attempts by personnel other than Tektronix representatives to install, repair or service the product; b) to repair damage resulting from improper use or connection to incompatible equipment; c) to repair any damage or malfunction caused by the use of non-Tektronix supplies; or d) to service a product that has been modified or integrated with other products when the effect of such modification or integration increases the time or difficulty of servicing the product.

THIS WARRANTY IS GIVEN BY TEKTRONIX WITH RESPECT TO THE PRODUCT IN LIEU OF ANY OTHER WARRANTIES, EXPRESS OR IMPLIED. TEKTRONIX AND ITS VENDORS DISCLAIM ANY IMPLIED WARRANTIES OF MERCHANTABILITY OR FITNESS FOR A PARTICULAR PURPOSE. TEKTRONIX' RESPONSIBILITY TO REPAIR OR REPLACE DEFECTIVE PRODUCTS IS THE SOLE AND EXCLUSIVE REMEDY PROVIDED TO THE CUSTOMER FOR BREACH OF THIS WARRANTY. TEKTRONIX AND ITS VENDORS WILL NOT BE LIABLE FOR ANY INDIRECT, SPECIAL, INCIDENTAL, OR CONSEQUENTIAL DAMAGES IRRESPECTIVE OF WHETHER TEKTRONIX OR THE VENDOR HAS ADVANCE NOTICE OF THE POSSIBILITY OF SUCH DAMAGES.

Table of Contents

Important safety information	v
General safety summary	v
Service safety summary	viii
Terms in this manual	ix
Symbols and terms on the product	ix
Compliance information	x
EMC compliance	x
Safety compliance	xi
Environmental considerations	xiv
Preface	xv
Key Features	xvi
Conventions Used in This Manual	xvi
Installation	1
Before Installation	1
Operating Considerations	5
Connecting Probes	7
Securing the Oscilloscope	8
Powering on the Oscilloscope	9
Powering off the Oscilloscope	10
Functional Check	10
Compensating a TPP0250, TPP0500B or TPP1000 Passive Voltage Probe	11
Compensating a non-TPP0250, non-TPP0500B or non-TPP1000 Passive Voltage Probe	13
Application Module Free Trial	14
Installing an Application Module	14
Upgrading Bandwidth	15
Changing the Language of the User Interface or Keyboard	18
Changing the Date and Time	20
Signal Path Compensation	21
Upgrading Firmware	23
Connecting Your Oscilloscope to a Computer	26
Connecting a USB Keyboard to Your Oscilloscope	35
Get Acquainted with the Instrument	36
Front-Panel Menus, Controls, and Connectors	36
Front Panel Menus and Controls	37
Front Panel Connectors	52
Side-Panel Connector	52
Rear-Panel Connectors	53
Acquire the Signal	54
Setting Up Analog Channels	54
Using the Default Setup	57
Using Autoset	58
Acquisition Concepts	59

Using FastAcq	60
How the Analog Acquisition Modes Work	62
Changing the Acquisition Mode, Record Length, and Delay Time	62
Using Roll Mode	64
Act on Event	65
Setting Up a Serial or Parallel Bus	67
Setting Up Digital Channels	81
When and Why to Turn On MagniVu	83
Using MagniVu	83
Setting Up the RF Inputs	84
Trigger Setup	89
Triggering Concepts	89
Choosing a Trigger Type	92
Selecting Triggers	93
Triggering on Buses	95
Checking Trigger Settings	100
Using Sequence Trigger (A (Main) and B (Delayed))	100
Starting and Stopping an Acquisition	102
Display Waveform or Trace Data	103
Adding and Removing a Waveform	103
Setting the Display Style and Persistence	103
Setting Waveform Intensity	107
Scaling and Positioning a Waveform	108
Setting Input Parameters	109
Positioning and Labeling Bus Signals	113
Positioning, Scaling, and Grouping Digital Channels	113
Viewing Digital Channels	115
Annotating the Screen	115
Viewing the Trigger Frequency	116
Displaying the Frequency Domain Menu	117
Analyze Waveform or Trace Data	121
Using Markers in the Frequency Domain	121
Taking Automatic Measurements in the Time Domain	124
Selecting Automatic Measurements in the Time Domain	125
Customizing an Automatic Measurement in the Time Domain	128
Taking Automatic Measurements in the Frequency Domain	132
Taking Digital Voltmeter Measurements	133
Taking Manual Measurements with Cursors	134
Setting Up a Histogram	138
Using Math Waveforms	141
Using FFT	142
Using Advanced Math	145
Using Spectrum Math	146
Using Reference Waveforms and Traces	147
Using Wave Inspector to Manage Long Record Length Waveforms	149

Auto-magnify	154
Limit and Mask Testing.....	155
Making Video Tests	159
Making Automated Power Measurements	160
Save and Recall Information	162
Saving a Screen Image.....	164
Saving and Recalling Waveform and Trace Data.....	165
Saving and Recalling Setups	168
Saving with One Button Push	170
Managing Drives, Directories, and Files	171
Mounting a Network Drive	171
Printing a Hard Copy.....	172
Using Oscilloscope Security Features	180
Use the Arbitrary Function Generator	185
Use the Application Modules.....	191
Appendix A: Warranted Specifications.....	193
Appendix B: TPP0250, TPP0500B and TPP1000: 250 MHz, 500 MHz and 1 GHz 10X Passive Probes Information	198
Operating Information.....	198
Connecting the Probe to the Oscilloscope	198
Compensating the Probe with MDO3000 Series Oscilloscopes	198
Standard Accessories.....	198
Optional Accessories	200
Replacing the Probe Tip	201
Specifications.....	201
Performance Graphs.....	201
Safety Summary	203
Appendix C: P6316 General-Purpose Logic Probe Information	205
Product Description	205
Connecting the Probe to the Oscilloscope	205
Connecting the Probe to Your Circuit	206
Functional Check.....	206
Typical Application	207
Accessories	208
Specifications.....	209
Safety Summary	209
Safety Terms and Symbols in This Manual.....	210
Appendix D: OpenSSL License	211
Index	

Important safety information

This manual contains information and warnings that must be followed by the user for safe operation and to keep the product in a safe condition.

To safely perform service on this product, additional information is provided at the end of this section. (See page viii, *Service safety summary*.)

General safety summary

Use the product only as specified. Review the following safety precautions to avoid injury and prevent damage to this product or any products connected to it. Carefully read all instructions. Retain these instructions for future reference.

Comply with local and national safety codes.

For correct and safe operation of the product, it is essential that you follow generally accepted safety procedures in addition to the safety precautions specified in this manual.

The product is designed to be used by trained personnel only.

Only qualified personnel who are aware of the hazards involved should remove the cover for repair, maintenance, or adjustment.

Before use, always check the product with a known source to be sure it is operating correctly.

This product is not intended for detection of hazardous voltages.

Use personal protective equipment to prevent shock and arc blast injury where hazardous live conductors are exposed.

While using this product, you may need to access other parts of a larger system. Read the safety sections of the other component manuals for warnings and cautions related to operating the system.

When incorporating this equipment into a system, the safety of that system is the responsibility of the assembler of the system.

To avoid fire or personal injury

Use proper power cord. Use only the power cord specified for this product and certified for the country of use.

Do not use the provided power cord for other products.

Ground the product. This product is grounded through the grounding conductor of the power cord. To avoid electric shock, the grounding conductor must be connected to earth ground. Before making connections to the input or output terminals of the product, make sure that the product is properly grounded.

Do not disable the power cord grounding connection.

Power disconnect. The power cord disconnects the product from the power source. See instructions for the location. Do not position the equipment so that it is difficult to operate the power cord; it must remain accessible to the user at all times to allow for quick disconnection if needed.

Connect and disconnect properly. Do not connect or disconnect probes or test leads while they are connected to a voltage source.

Use only insulated voltage probes, test leads, and adapters supplied with the product, or indicated by Tektronix to be suitable for the product.

Observe all terminal ratings. To avoid fire or shock hazard, observe all ratings and markings on the product. Consult the product manual for further ratings information before making connections to the product. Do not exceed the Measurement Category (CAT) rating and voltage or current rating of the lowest rated individual component of a product, probe, or accessory. Use caution when using 1:1 test leads because the probe tip voltage is directly transmitted to the product.

Do not apply a potential to any terminal, including the common terminal, that exceeds the maximum rating of that terminal.

Do not float the common terminal above the rated voltage for that terminal.

Do not operate without covers. Do not operate this product with covers or panels removed, or with the case open. Hazardous voltage exposure is possible.

Avoid exposed circuitry. Do not touch exposed connections and components when power is present.

Do not operate with suspected failures. If you suspect that there is damage to this product, have it inspected by qualified service personnel.

Disable the product if it is damaged. Do not use the product if it is damaged or operates incorrectly. If in doubt about safety of the product, turn it off and disconnect the power cord. Clearly mark the product to prevent its further operation.

Before use, inspect voltage probes, test leads, and accessories for mechanical damage and replace when damaged. Do not use probes or test leads if they are damaged, if there is exposed metal, or if a wear indicator shows.

Examine the exterior of the product before you use it. Look for cracks or missing pieces.

Use only specified replacement parts.

Use proper fuse. Use only the fuse type and rating specified for this product.

Do not operate in wet/damp conditions. Be aware that condensation may occur if a unit is moved from a cold to a warm environment.

Do not operate in an explosive atmosphere.

Keep product surfaces clean and dry. Remove the input signals before you clean the product.

Provide proper ventilation. Refer to the installation instructions in the manual for details on installing the product so it has proper ventilation.

Slots and openings are provided for ventilation and should never be covered or otherwise obstructed. Do not push objects into any of the openings.

Provide a safe working environment. Always place the product in a location convenient for viewing the display and indicators.

Avoid improper or prolonged use of keyboards, pointers, and button pads. Improper or prolonged keyboard or pointer use may result in serious injury.

Be sure your work area meets applicable ergonomic standards. Consult with an ergonomics professional to avoid stress injuries.

Use only the Tektronix rackmount hardware specified for this product.

Probes and test leads

Before connecting probes or test leads, connect the power cord from the power connector to a properly grounded power outlet.

Keep fingers behind the finger guards on the probes.

Remove all probes, test leads and accessories that are not in use.

Use only correct Measurement Category (CAT), voltage, temperature, altitude, and amperage rated probes, test leads, and adapters for any measurement.

Beware of high voltages. Understand the voltage ratings for the probe you are using and do not exceed those ratings. Two ratings are important to know and understand:

- The maximum measurement voltage from the probe tip to the probe reference lead.
- The maximum floating voltage from the probe reference lead to earth ground

These two voltage ratings depend on the probe and your application. Refer to the Specifications section of the manual for more information.



WARNING. *To prevent electrical shock, do not exceed the maximum measurement or maximum floating voltage for the oscilloscope input BNC connector, probe tip, or probe reference lead.*

Connect and disconnect properly. Connect the probe output to the measurement product before connecting the probe to the circuit under test. Connect the probe reference lead to the circuit under test before connecting the probe input. Disconnect the probe input and the probe reference lead from the circuit under test before disconnecting the probe from the measurement product.

Connect and disconnect properly. De-energize the circuit under test before connecting or disconnecting the current probe.

Connect the probe reference lead to earth ground only.

Do not connect a current probe to any wire that carries voltages above the current probe voltage rating.

Inspect the probe and accessories. Before each use, inspect probe and accessories for damage (cuts, tears, or defects in the probe body, accessories, or cable jacket). Do not use if damaged.

Ground-referenced oscilloscope use. Do not float the reference lead of this probe when using with ground-referenced oscilloscopes. The reference lead must be connected to earth potential (0 V).

Service safety summary

The *Service safety summary* section contains additional information required to safely perform service on the product. Only qualified personnel should perform service procedures. Read this *Service safety summary* and the *General safety summary* before performing any service procedures.

To avoid electric shock. Do not touch exposed connections.

Do not service alone. Do not perform internal service or adjustments of this product unless another person capable of rendering first aid and resuscitation is present.

Disconnect power. To avoid electric shock, switch off the product power and disconnect the power cord from the mains power before removing any covers or panels, or opening the case for servicing.

Use care when servicing with power on. Dangerous voltages or currents may exist in this product. Disconnect power, remove battery (if applicable), and disconnect test leads before removing protective panels, soldering, or replacing components.

Verify safety after repair. Always recheck ground continuity and mains dielectric strength after performing a repair.

Terms in this manual

These terms may appear in this manual:



WARNING. Warning statements identify conditions or practices that could result in injury or loss of life.



CAUTION. Caution statements identify conditions or practices that could result in damage to this product or other property.

Symbols and terms on the product

These terms may appear on the product:

- DANGER indicates an injury hazard immediately accessible as you read the marking.
- WARNING indicates an injury hazard not immediately accessible as you read the marking.
- CAUTION indicates a hazard to property including the product.



When this symbol is marked on the product, be sure to consult the manual to find out the nature of the potential hazards and any actions which have to be taken to avoid them. (This symbol may also be used to refer the user to ratings in the manual.)

The following symbol(s) may appear on the product:



Standby

Compliance information

This section lists the EMC (electromagnetic compliance), safety, and environmental standards with which the instrument complies.

EMC compliance

EU EMC Directive

Meets intent of Directive 2014/30/EU for Electromagnetic Compatibility. Compliance was demonstrated to the following specifications as listed in the Official Journal of the European Communities:

EN 61326-1:2006, EN 61326-2-1:2006. EMC requirements for electrical equipment for measurement, control, and laboratory use.^{1 2 3}

- CISPR 11:2003. Radiated and conducted emissions, Group 1, Class A
- IEC 61000-4-2:2001. Electrostatic discharge immunity
- IEC 61000-4-3:2002. RF electromagnetic field immunity⁴
- IEC 61000-4-4:2004. Electrical fast transient/burst immunity
- IEC 61000-4-5:2001. Power line surge immunity
- IEC 61000-4-6:2003. Conducted RF immunity⁵
- IEC 61000-4-11:2004. Voltage dips and interruptions immunity⁶

EN 61000-3-2:2006. AC power line harmonic emissions

EN 61000-3-3:1995. Voltage changes, fluctuations, and flicker

European contact.

Tektronix UK, Ltd.
Western Peninsula
Western Road
Bracknell, RG12 1RF
United Kingdom

- ¹ This product is intended for use in nonresidential areas only. Use in residential areas may cause electromagnetic interference.
- ² Emissions which exceed the levels required by this standard may occur when this equipment is connected to a test object.
- ³ For compliance with the EMC standards listed here, high quality shielded interface cables should be used.
- ⁴ Oscilloscope: ≤ 3.0 division waveform displacement and ≤ 6.0 division increase in peak-to-peak noise. RF: Residual spurious signals in the RF section can typically increase to -50 dBm when the instrument is subjected to electromagnetic interference per the IEC 61000-4-3 test for frequencies up to 1 GHz, and to -35 dBm for frequencies above 1 GHz.
- ⁵ Oscilloscope: ≤ 1.0 division waveform displacement and ≤ 2.0 division increase in peak-to-peak noise. RF: Residual spurious signals in the RF section can typically increase to -85 dBm when the instrument is subjected to electromagnetic interference per the IEC 61000-4-6 test.
- ⁶ Performance Criterion C applied at the 70%/25 cycle Voltage-Dip and the 0%/250 cycle Voltage-Interruption test levels (IEC 61000-4-11).

Australia / New Zealand Declaration of Conformity – EMC

Complies with the EMC provision of the Radiocommunications Act per the following standard, in accordance with ACMA:

- CISPR 11:2003. Radiated and Conducted Emissions, Group 1, Class A, in accordance with EN 61326-1:2006 and EN 61326-2-1:2006.

Australia / New Zealand contact.

Baker & McKenzie
Level 27, AMP Centre
50 Bridge Street
Sydney NSW 2000, Australia

Russian Federation

This product is approved by the Russian government to carry the GOST mark.

Safety compliance

This section lists the safety standards with which the product complies and other safety compliance information.

EU declaration of conformity – low voltage

Compliance was demonstrated to the following specification as listed in the Official Journal of the European Union:

Low Voltage Directive 2014/35/EU.

- EN 61010-1. Safety Requirements for Electrical Equipment for Measurement, Control, and Laboratory Use – Part 1: General Requirements.
- EN 61010-2-030. Safety Requirements for Electrical Equipment for Measurement, Control, and Laboratory Use – Part 2-030: Particular requirements for testing and measuring circuits.

U.S. nationally recognized testing laboratory listing

- UL 61010-1. Safety Requirements for Electrical Equipment for Measurement, Control, and Laboratory Use – Part 1: General Requirements.
- UL 61010-2-030. Safety Requirements for Electrical Equipment for Measurement, Control, and Laboratory Use – Part 2-030: Particular requirements for testing and measuring circuits.

Canadian certification

- CAN/CSA-C22.2 No. 61010-1. Safety Requirements for Electrical Equipment for Measurement, Control, and Laboratory Use – Part 1: General Requirements.
- CAN/CSA-C22.2 No. 61010-2-030. Safety Requirements for Electrical Equipment for Measurement, Control, and Laboratory Use – Part 2-030: Particular requirements for testing and measuring circuits.

Additional compliances

- IEC 61010-1. Safety Requirements for Electrical Equipment for Measurement, Control, and Laboratory Use – Part 1: General Requirements.
- IEC 61010-2-030. Safety Requirements for Electrical Equipment for Measurement, Control, and Laboratory Use – Part 2-030: Particular requirements for testing and measuring circuits.

Equipment type

Test and measuring equipment.

Safety class

Class 1 – grounded product.

Pollution degree descriptions

A measure of the contaminants that could occur in the environment around and within a product. Typically the internal environment inside a product is considered to be the same as the external. Products should be used only in the environment for which they are rated.

- Pollution degree 1. No pollution or only dry, nonconductive pollution occurs. Products in this category are generally encapsulated, hermetically sealed, or located in clean rooms.
- Pollution degree 2. Normally only dry, nonconductive pollution occurs. Occasionally a temporary conductivity that is caused by condensation must be expected. This location is a typical office/home environment. Temporary condensation occurs only when the product is out of service.
- Pollution degree 3. Conductive pollution, or dry, nonconductive pollution that becomes conductive due to condensation. These are sheltered locations where neither temperature nor humidity is controlled. The area is protected from direct sunshine, rain, or direct wind.
- Pollution degree 4. Pollution that generates persistent conductivity through conductive dust, rain, or snow. Typical outdoor locations.

Pollution degree rating

Pollution degree 2 (as defined in IEC 61010-1). Rated for indoor, dry location use only.

IP rating

IP20 (as defined in IEC 60529).

Measurement and overvoltage category descriptions

Measurement terminals on this product may be rated for measuring mains voltages from one or more of the following categories (see specific ratings marked on the product and in the manual).

- Category II. Circuits directly connected to the building wiring at utilization points (socket outlets and similar points).
- Category III. In the building wiring and distribution system.
- Category IV. At the source of the electrical supply to the building.

NOTE. *Only mains power supply circuits have an overvoltage category rating. Only measurement circuits have a measurement category rating. Other circuits within the product do not have either rating.*

Mains overvoltage category rating

Overvoltage category II (as defined in IEC 61010-1).

Environmental considerations

This section provides information about the environmental impact of the product.

Product end-of-life handling

Observe the following guidelines when recycling an instrument or component:

Equipment recycling. Production of this equipment required the extraction and use of natural resources. The equipment may contain substances that could be harmful to the environment or human health if improperly handled at the product's end of life. To avoid release of such substances into the environment and to reduce the use of natural resources, we encourage you to recycle this product in an appropriate system that will ensure that most of the materials are reused or recycled appropriately.



This symbol indicates that this product complies with the applicable European Union requirements according to Directives 2002/96/EC and 2006/66/EC on waste electrical and electronic equipment (WEEE) and batteries. For information about recycling options, check the Support/Service section of the Tektronix Web site (www.tektronix.com).

Perchlorate materials. This product contains one or more type CR lithium batteries. According to the state of California, CR lithium batteries are classified as perchlorate materials and require special handling. See www.dtsc.ca.gov/hazardouswaste/perchlorate for additional information.

Restriction of hazardous substances

This product is classified as an industrial monitoring and control instrument, and is not required to comply with the substance restrictions of the recast RoHS Directive 2011/65/EU until July 22, 2017.

Preface

This manual describes the installation and operation of the following oscilloscopes:

Model	MDO3104	MDO3102	MDO3054	MDO3052	MDO3034
Bandwidth	1 GHz	1 GHz	500 MHz	500 MHz	350 MHz
Analog Channels	4	2	4	2	4
Digital Channels	16	16	16	16	16
RF Channels	1	1	1	1	1
Sample Rate (1 ch)	5 GS/s	5 GS/s	2.5 GS/s	2.5 GS/s	2.5 GS/s
Sample Rate (2 ch)	5 GS/s	5 GS/s	2.5 GS/s	2.5 GS/s	2.5 GS/s
Sample Rate (4 ch)	2.5 GS/s	N/A	2.5 GS/s	N/A	2.5 GS/s
Record Length (1 ch)	10 M	10 M	10 M	10 M	10 M
Record Length (2 ch)	10 M	10 M	10 M	10 M	10 M
Record Length (4 ch)	10 M	N/A	10 M	N/A	10 M
RF Frequency Range	9 kHz - 1 GHz	9 kHz - 1 GHz	9 kHz - 500 MHz	9 kHz - 500 MHz	9 kHz - 350 MHz
AFG Outputs	1	1	1	1	1

Model	MDO3032	MDO3024	MDO3022	MDO3014	MDO3012
Bandwidth	350 MHz	200 MHz	200 MHz	100 MHz	100 MHz
Analog Channels	2	4	2	4	2
Digital Channels	16	16	16	16	16
RF Channels	1	1	1	1	1
Sample Rate (1 ch)	2.5 GS/s	2.5 GS/s	2.5 GS/s	2.5 GS/s	2.5 GS/s
Sample Rate (2 ch)	2.5 GS/s	2.5 GS/s	2.5 GS/s	2.5 GS/s	2.5 GS/s
Sample Rate (4 ch)	N/A	2.5 GS/s	N/A	2.5 GS/s	N/A
Record Length (1 ch)	10 M	10 M	10 M	10 M	10 M
Record Length (2 ch)	10 M	10 M	10 M	10 M	10 M

Model	MDO3032	MDO3024	MDO3022	MDO3014	MDO3012
Record Length (4 ch)	N/A	10 M	N/A	10 M	N/A
RF Frequency Range	9 kHz - 350 MHz	9 kHz - 200 MHz	9 kHz - 200 MHz	9 kHz - 100 MHz	9 kHz - 100 MHz
AFG Outputs	1	1	1	1	1

Key Features

MDO3000 Mixed Domain Oscilloscopes are 6-in-1 integrated oscilloscopes, offering a built-in spectrum analyzer, arbitrary function generator, logic analyzer, protocol analyzer, digital voltmeter and frequency counter. Key features include:

- A dedicated RF input channel for frequency domain measurements
- Four or two analog channels for time domain measurements
- Models are available with bandwidths from 100 MHz to 1 GHz
- Sample rates of 2.5 GS/s on all analog channels (5 GS/s on 1 or 2 channels for the MDO3104 or MDO3102)
- 10 M points record length on all channels
- Maximum waveform capture rate: >280,000 waveforms/second with FastAcq. >50,000 waveforms/second with normal operation.
- Advanced triggering and analysis: ARINC429, I²C, SPI, USB 2.0, CAN, CAN FD, LIN, FlexRay, RS-232, RS-422, RS-485, UART, I²S, Left Justified (LJ), Right Justified (RJ), TDM, MIL-STD-1553 (with the appropriate application module), and Parallel
- Power analysis, and limit and mask testing application modules (optional)
- Arbitrary function generator and 16 digital channels (optional)
- Digital voltmeter free with product registration

Conventions Used in This Manual

The following icons are used throughout this manual.

Sequence Step



Front panel power



Connect power

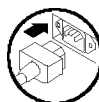

Network

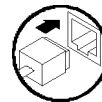

USB

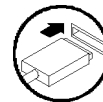

Installation

Before Installation

Unpack the oscilloscope and check that you received all items listed as standard accessories. The following pages list recommended accessories and probes, instrument options, and upgrades. Check the Tektronix Web site (www.tektronix.com) for the most current information.

Standard accessories

Accessory	Description	Tektronix part number
MDO3000 Installation and Safety Manual	General installation and safety information	071-3249-XX
MDO3000 Series Oscilloscopes Documentation Browser CD	Electronic versions of or links to documents, including the User Manual, Programmer Manual and the Technical Reference.	063-4526-XX
Tektronix OpenChoice Desktop CD	Productivity, analysis, and documentation software	
Calibration certificate documenting traceability to national metrology institute(s), and ISO9001 quality system registration.		--
Front Panel Overlay	French (Option L1)	335-3264-XX
	Italian (Option L2)	335-3265-XX
	German (Option L3)	335-3266-XX
	Spanish (Option L4)	335-3267-XX
	Japanese (Option L5)	335-3268-XX
	Portuguese (Option L6)	335-3269-XX
	Simplified Chinese (Option L7)	335-3270-XX
	Traditional Chinese (Option L8)	335-3271-XX
	Korean (Option L9)	335-3272-XX
	Russian (Option L10)	335-3273-XX
Probes	For 100 and 200 MHz models, one 250 MHz, 10X passive probe per channel Two TPP0250 for the MDO3012/22 and four TPP0250 for the MDO3014/24	TPP0250
	For 350 and 500 MHz models, one 500 MHz, 10X passive probe per channel Two TPP0500B for the MDO3032/52 and four TPP0500B for the MDO3034/54	TPP0500B
	For 1 GHz models, one 1 GHz, 10X passive probe per channel Two TPP1000 for the MDO3102 and four TPP1000 for the MDO3104	TPP1000
Adapter	N Male to BNC Female	103-0473-XX

Standard accessories (cont.)

Accessory	Description	Tektronix part number
Power Cord	North America (Option A0)	161-0348-XX
	Universal Euro (Option A1)	161-0343-XX
	United Kingdom (Option A2)	161-0344-XX
	Australia (Option A3)	161-0346-XX
	Switzerland (Option A5)	161-0347-XX
	Japan (Option A6)	161-0342-XX
	China (Option A10)	161-0341-00
	India (Option A11)	161-0349-XX
	Brazil (Option A12)	161-0356-XX
	No power cord or AC adapter (Option A99)	--
Logic probe (with MDO3MSO option)	One, 16-channel logic probe, with accessories	P6316
Probe and accessory pouch	Bag to hold probes and related accessories	016-2008-XX

Optional application modules

Tektronix part number	Description
MDO3AERO	ARINC429 and MIL-STD-1553 Serial Triggering and Analysis
MDO3AUDIO	Audio Serial Triggering and Analysis (I ² S, LJ, RJ, TDM)
MDO3AUTO	Automotive Serial Triggering and Analysis (CAN, CAN FD, and LIN)
MDO3COMP	Computer Serial Triggering and Analysis (RS-232, RS-422, RS-485 and UART)
MDO3EMBD	Embedded Serial Triggering and Analysis (I ² C and SPI)
MDO3FLEX	FlexRay Serial Triggering and Analysis
MDO3USB	Universal Serial Bus Triggering and Analysis (LS, FS, HS). High speed is decode only; available on 1 GHz models only.
MDO3LMT	Limit/Mask Test Analysis
MDO3PWR	Power Measurement Analysis

Optional instrument upgrades

Tektronix part number	Description
MDO3AFG	Arbitrary function generator
MDO3MSO	16 digital channels; includes P6316 digital probe
MDO3SA	Increase spectrum analyzer input frequency range to 9 kHz - 3 GHz
MDO3SEC	Add password protected security to enable or disable all communication ports and firmware upgrades to any MDO3000 Series oscilloscope.
Bandwidth upgrades	Upgrade the analog bandwidth on MDO3000 Series products post-purchase. Visit www.tektronix.com for information on available upgrade products.

Optional accessories

Accessory	Description	Tektronix part number
TPA-BNC adapter	TekVPI to TekProbe II BNC Adapter	TPA-BNC
TPA-N-VPI adapter	Adapter from N connection (RF input) to TekVPI probe.	TPA-N-BNC
TekVPI probes that work with MDO3000 Series oscilloscopes	Visit the Oscilloscope Probe and Accessory Selector Tool on the Tektronix website at www.tektronix.com/probes	—
NEX-HD2HEADER	Adapter that routes the channels from a Mictor connector to 0.1 inch header pins	NEX-HD2HEADER
TEK-USB-488 Adapter	GPIB to USB Adapter	TEK-USB-488
Rackmount kit	Adds rackmount brackets	RMD3000
Soft transit case	Case for carrying instrument.	ACD3000
Protective front cover	Also included with this case is a hard plastic protective instrument front cover (200-5052-00).	

Optional accessories (cont.)

Accessory	Description	Tektronix part number
Hard transit case	Traveling case, which requires use of the soft transit case (ACD3000)	HCTEK4321
Front cover	Hard plastic cover to help protect the instrument	200-5052-00
Demonstration Board	Electronic circuit board used for demonstration and training on the MDO3000 Series.	020-3087-XX
MDO3000 Series Oscilloscopes User Manual	English	071-0968-XX
	French	071-0969-XX
	Italian	071-0970-XX
	German	071-0971-XX
	Spanish	071-0972-XX
	Japanese	071-0973-XX
	Portuguese	071-0974-XX
	Simplified Chinese	071-0975-XX
	Traditional Chinese	071-0976-XX
MDO3000 Series Oscilloscopes Programmer Manual	Korean	071-0977-XX
	Russian	071-0978-XX
MDO3000 Series Oscilloscopes Programmer Manual	Describes commands for remote control of the oscilloscope. Available electronically on the Documentation Browser CD or for download from www.tektronix.com/manuals .	077-0510-XX
MDO3000 Series Oscilloscopes Technical Reference Manual	Describes the oscilloscope specifications and performance verification procedure. Available electronically on the Documentation Browser CD or for download from www.tektronix.com/manuals .	077-0979-XX
MDO3000 Series Oscilloscopes Service Manual	Service information on MDO3000 Series oscilloscopes	077-0981-XX

Optional accessories (cont.)

Accessory	Description	Tektronix part number
MDO3000 Series Application Module Installation Instructions	Describes how to install application modules on your oscilloscope	071-3250-XX
MDO3PWR, DPO3PWR and DPO4PWR Power Measurement Module User Manual	English (Option L0)	071-2631-XX
	French (Option L1)	077-0235-XX
	Italian (Option L2)	077-0236-XX
	German (Option L3)	077-0237-XX
	Spanish (Option L4)	077-0238-XX
	Japanese (Option L5)	077-0239-XX
	Portuguese (Option L6)	077-0240-XX
	Simplified Chinese (Option L7)	077-0241-XX
	Traditional Chinese (Option L8)	077-0242-XX
	Korean (Option L9)	077-0243-XX
Russian (Option L10)	077-0244-XX	
MDO3000 Series Oscilloscopes Declassification and Security Instructions	Describes how to sanitize or remove memory devices from the Tektronix MDO3000 Series oscilloscopes	077-0980-XX

The MDO3000 Series oscilloscopes support a multitude of optional probes. (See page 7, *Connecting Probes*.) Visit the Oscilloscope Probe and Accessory Selector Tool on the Tektronix Web site (www.tektronix.com/probes) for the most up to date information.

Operating Considerations

MDO3000 Series Oscilloscopes

Mains Input Voltage: 100 V to 240 V \pm 10%

Mains Input Power Frequency:

50/60 Hz at 100 V to 240 V

400 Hz \pm 10% at 100 to 132 V

Weight: 4.2 kg (9.2 lbs), standalone instrument

Height, including feet but not handle:

203.2 mm (8 in)

Width, 416.6 mm (16.4 in)

Depth, 147.4 mm (5.8 in)

Clearance: 51 mm (2 in)



MDO3000 Series

Temperature:

Operating: -10°C to $+55^{\circ}\text{C}$ ($+14^{\circ}\text{F}$ to $+131^{\circ}\text{F}$)

Nonoperating: -40°C to $+71^{\circ}\text{C}$ (-40°F to $+159^{\circ}\text{F}$)

Humidity:

Operating:

5% to 90% relative humidity (% RH) at up to +40°C,
5% to 60% RH above +40 C up to +55°C,
non-condensing

Non-Operating:

5% to 90% RH (Relative Humidity) at up to +40 C,
5% to 60% RH above +40°C up to +55°C,
5% to 40% RH above +55 °C up to +71 °C
non-condensing

Altitude:

Operating: 3,000 m (about 9,843 ft)
Non-operating: 12,000 m (39,370 ft)

Acquisition System: 1 M Ω

The maximum input voltage: At the BNC, 300 V_{RMS}, Installation Category II. De-rate at 20 dB/decade between 4.5 MHz and 45 MHz, De-rate 14 db between 45 MHz and 450 MHz. Above 450 MHz, 5 V_{RMS}.

Acquisition System: 50 Ω and 75 Ω

The maximum input voltage: 5 V_{RMS} with a peak at ± 20 V. (DF \leq 6.25%).

Dedicated RF Input:

The maximum operating input level:

Average Continuous Power: +20 dBm (0.1 W)

DC maximum before damage: ± 40 V_{DC}

Max "No damage" +33 dBm (2 W) CW

Peak Pulse Power: +45 dBm (32 W)

Peak Pulse Power defined as <10 μ s pulse width, <1% duty cycle, and reference level of \geq +10 dBm



CAUTION. To ensure proper cooling, keep the sides and rear of the instrument clear of obstructions. Ventilation clearance should be at least 51 mm (2 in) on the left side, when looking at the front of the instrument, and on the rear of the instrument

MDO3000 Series Oscilloscope with a P6316 Digital Probe

Threshold Accuracy: $\pm(100$ mV + 3% of threshold setting after calibration)

Threshold Range: +25 V to -15 V.

Maximum nondestructive input signal to probe: +30 V to -20 V

Minimum signal swing: 500 mV_{peak-to-peak}

Input resistance: 101 K Ω

Input capacitance: 8.0 pF typical

Pollution Degree: 2, Indoor use only

Humidity: 5% to 95% relative humidity

Cleaning

Inspect the oscilloscope and probes as often as operating conditions require. To clean the exterior surface, perform the following steps:

1. Remove loose dust on the outside of the oscilloscope and probes with a lint-free cloth. Use care to avoid scratching the display.
2. Use a soft cloth dampened with water to clean the oscilloscope. Use an aqueous solution of 75% isopropyl alcohol for more efficient cleaning.



CAUTION. Avoid getting moisture inside the unit during external cleaning. Use only enough cleaning solution to dampen the cloth or swab.



CAUTION. To avoid damage to the surface of the oscilloscope or probes, do not use any abrasive or chemical cleaning agents.

Connecting Probes

The oscilloscope supports probes with the following:

1. Tektronix Versatile Probe Interface (TekVPI)

These probes support two-way communication with the oscilloscope through on-screen menus and remotely through programmable support. The remote control is useful in applications like ATE where you want the system to preset probe parameters.
2. Tektronix Versatile Probe Interface (TekVPI) for Passive Probes

These probes build upon the functionality of the TekVPI interface. Each probe is matched with its corresponding oscilloscope channel, allowing the oscilloscope to optimize the signal input path. This provides AC compensation across the frequency band.

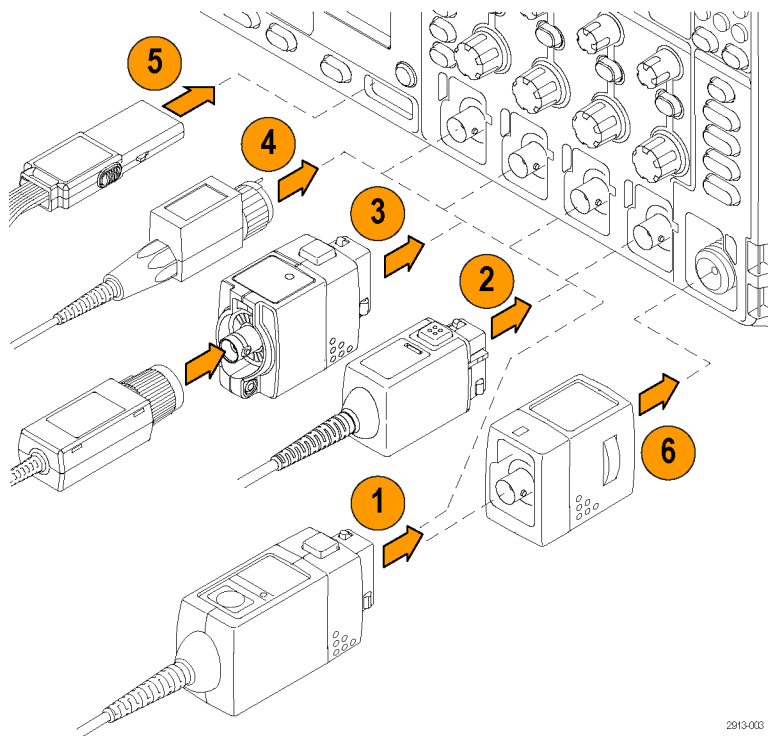

2913-003

3. TPA-BNC Adapter

The TPA-BNC Adapter allows you to use TEKPROBE II probe capabilities, such as providing probe power, and passing scaling and unit information to the oscilloscope.

4. BNC Interfaces

Some of these use TEKPROBE capabilities to pass the waveform signal and scaling to the oscilloscope. Some only pass the signal and there is no other communication.

5. Logic Probe Interface

The P6316 probe provides 16 channels of digital (on or off state) information.

6. The TPA-N-VPI Adapter allows you to use TekVPI probes in the RF input.

For more information on the many probes available for use with MDO3000 Series oscilloscopes, visit the Oscilloscope Probe and Accessory Selector Tool on the Tektronix website at www.tektronix.com.

Securing the Oscilloscope

1. Use a standard laptop computer style security lock to secure your oscilloscope to your location.

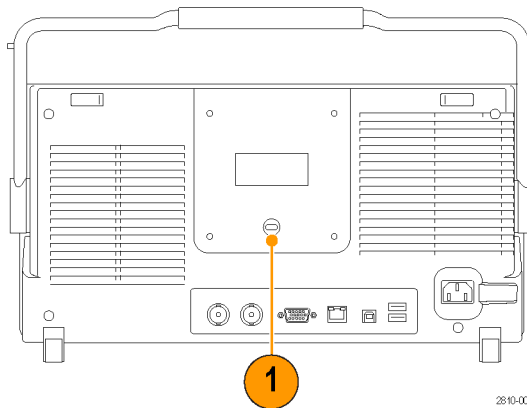

2810-004

Powering on the Oscilloscope

Ground the Oscilloscope and Yourself

To power on the instrument, connect the power cord that was provided with the instrument to the power connector on the rear panel. Connect the power cord to a properly grounded electrical outlet. To power off the instrument, remove the power cord from the instrument.

Grounding the oscilloscope is necessary for safety and to take accurate measurements. The oscilloscope needs to share the same ground as any circuits that you are testing.

If you are working with static sensitive components, ground yourself. Static electricity that builds up on your body can damage static-sensitive components. Wearing a grounding strap safely sends static charges on your body to earth ground.

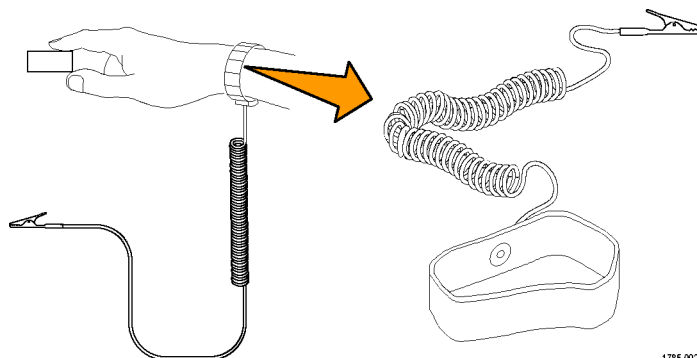

1785-002

To connect the power cord and power on the oscilloscope:

1. Connect the supplied power cord to the rear-panel power connector.
2. Push the power button on the instrument front-panel and the instrument will turn on.

NOTE. The Standby button on the front-panel does not disconnect mains power. Only the power cord at the rear of the product can disconnect mains power.

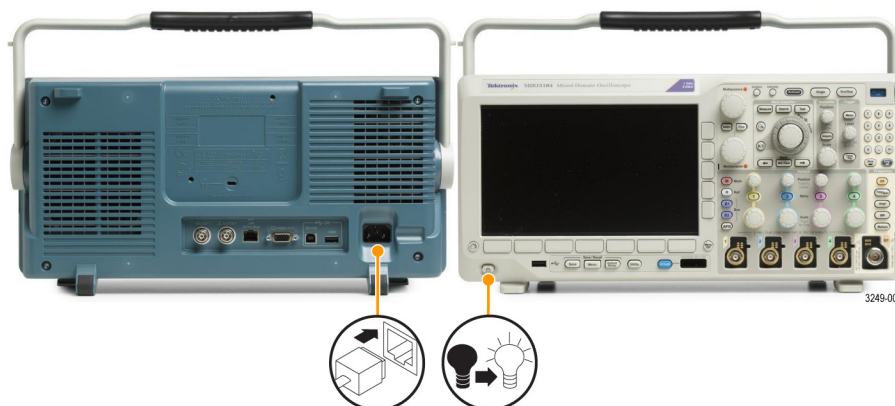

3249-004

Powering off the Oscilloscope

To power off the oscilloscope and remove the power cord:

1. Push the power button on the instrument front-panel to turn the instrument off.
2. If you want to remove power completely, disconnect the power cord from the rear-panel of the instrument.



Functional Check

Perform this quick functional check to verify that your oscilloscope is operating correctly.

1. Connect the oscilloscope power cable as described in *Powering On the Oscilloscope*. (See page 9.)
2. Power on the oscilloscope.

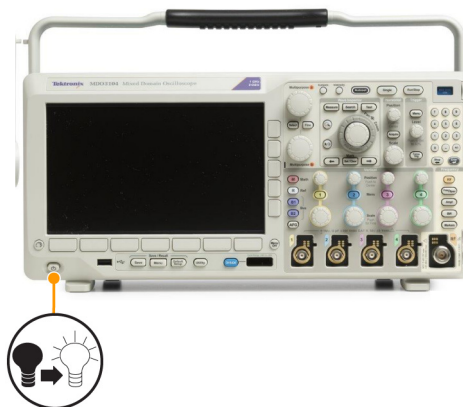

3. Connect the probe connector to oscilloscope channel 1 and the probe tip and reference lead to the **PROBE COMP** terminals on the oscilloscope front panel.



0968-002

4. Push **Default Setup**.



3249-008

5. Push **Autoset**. The screen should now display a square wave, approximately 2.5 V at 1 kHz.

If the signal appears but is misshapen, perform the procedures for compensating the probe.

If no signal appears, rerun the procedure.

If this does not remedy the situation, have the instrument serviced by qualified service personnel.

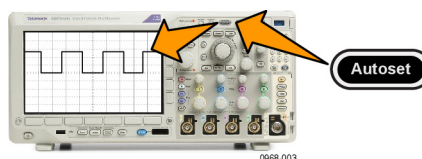

0968-003

Compensating a TPP0250, TPP0500B or TPP1000 Passive Voltage Probe

The MDO3000 Series oscilloscopes can automatically compensate TPP0250, TPP0500B and TPP1000 probes. This eliminates the need for manual probe compensation, as is typically performed with other probes.

Each compensation generates values for a specific probe and channel combination. If you want to use the probe on another channel and desire to compensate the new probe-channel pair, you must run a new set of compensation steps for that new combination.

1. Connect the oscilloscope power cable. (See page 9, *Powering on the Oscilloscope*.)
2. Power on the oscilloscope.

3. Connect the probe connector to the oscilloscope channel, and the probe tip and reference lead to the **PROBE COMP** terminals on the oscilloscope front panel.

NOTE. Connect only one probe at a time to the probe comp terminals.



0968-002

4. Push a front panel button for an input channel connected to the probe you wish to compensate. (1, 2, 3, or 4)



0968-004

5. Notice on the lower menu that the oscilloscope has automatically set the probe termination value

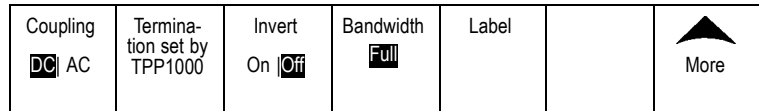

6. Push **More** repeatedly to select **Probe Setup** from the resulting pop-up menu.

7. Notice that the compensation status starts as **Default**.

8. Push **Compensate probe** and follow the instructions that appear on the display.

TPP1000 Probe Setup	
SN: 000001 Atten: 10X	
Compensation Status Default	7
Compensate probe for 1	8
Measure Current Yes <input type="checkbox"/> No <input checked="" type="checkbox"/>	

When compensating TPP0250/TPP0500B/TPP1000 probes on the MDO3000 Series oscilloscopes:

- Each compensation generates values for a specific probe and channel combination. If you want to use the probe on another channel and desire to compensate the new probe-channel pair, you must run a new set of compensation steps.
- Each channel can store compensation values for 10 individual probes. If you try to compensate an 11th probe on a channel, the oscilloscope will delete the values for the least recently used probe and add the values for the new probe.
- The oscilloscope will assign default compensation values to a TPP0250, TPP0500B or TPP1000 probe connected to the **Aux In** channel.

NOTE. A factory calibration will delete all stored compensation values

NOTE. A probe compensation failure is most likely due to intermittent connection of the probe tip or ground connection during the probe compensation operation. If a failure occurs, the oscilloscope will re-use the old probe compensation values, if they existed prior to the failed probe compensation operation.

Compensating a non-TPP0250, non-TPP0500B or non-TPP1000 Passive Voltage Probe

Whenever you attach a passive voltage probe for the first time to any input channel, compensate the probe to match it to the corresponding oscilloscope input channel.

If you are interested in using the automatic probe compensation procedure described above for the TPP0250, TPP0500 and TPP1000 probes (See page 11, *Compensating a TPP0250, TPP0500B or TPP1000 Passive Voltage Probe*). On a non-TPP0250/TPP0500B/TPP1000 Tektronix passive probe, check the instruction manual for your probe to see if it qualifies. Otherwise, to properly compensate your passive probe:

1. Follow the steps for the functional check. (See page 10, *Functional Check*.)

2. Check the shape of the displayed waveform to determine if your probe is properly compensated.
3. If necessary, adjust your probe. Repeat as needed.

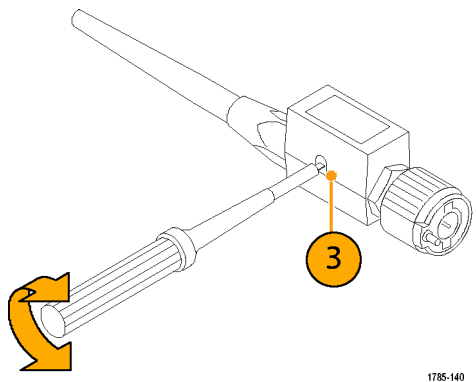

Quick Tips

Use the shortest possible ground lead and signal path to minimize probe-induced ringing and distortion on the measured signal.

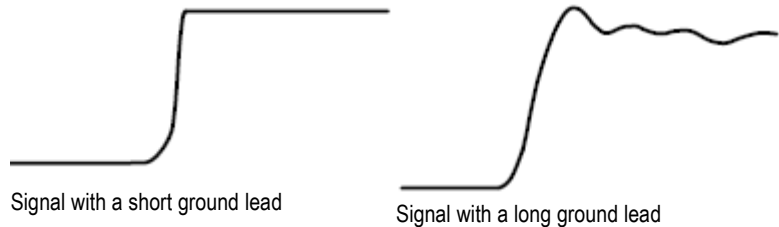

Application Module Free Trial

A 30-day free trial is available for all application module licenses not installed in your oscilloscope. The trial period begins when you power on the oscilloscope for the first time.

After 30 days, you must purchase the module if you want to continue using the application. To see the date when your free trial period expires, push **Utility** on the front panel, push **Utility Page** on the lower menu, turn the **Multipurpose a** knob to select **Config**, and push **About** on the lower menu.

Installing an Application Module



CAUTION. To avoid damage to the oscilloscope or application module, observe ESD (electrostatic discharge) precautions. (See page 9, Powering on the Oscilloscope.)

Turn off the oscilloscope power while removing or adding an application module.

(See page 10, Powering off the Oscilloscope.)

Optional application module packages extend the capability of your oscilloscope.

You can physically install up to two application modules at one time. Application modules can go into the slots with a window in the upper right corner of the front panel. One additional slot is directly behind the one that you can see. To use the hidden slot, install the module with the label facing away from you.

Some of the modules have licenses that allow you to transfer the license between your application modules and the oscilloscope. You can keep each license in the module, which will allow you to move the module from one instrument to another. Alternatively, you can move the license from the module to the oscilloscope. This approach will allow you to store the module separately from the oscilloscope for safe keeping. This approach will also allow you to use more than two applications on your oscilloscope simultaneously. To transfer a license from a module to your oscilloscope or from your oscilloscope to a module:

1. Turn off the power to the oscilloscope. Insert the application modules into the oscilloscope. Turn on the power.
2. Push **Utility** on the front panel. If needed, push **Utility Page** on the lower menu and turn the **Multipurpose a** knob to select **Config**. Push **Manage Modules and Options** on the lower menu, and then push **License Type** on the side menu until "Modules" is selected. The licenses contained in the oscilloscope will be listed in the side menu. Push the button next to the appropriate license to transfer. You may transfer up to two licenses at one time.
3. After you turn off the power to the oscilloscope, you can remove the physical application module from the oscilloscope.

Refer to the *MDO3000 Series Oscilloscopes Application Module Installation Manual* that came with your application module for instructions on installing and testing an application module.

NOTE. *If you transfer a license from a module to an oscilloscope, the module will not work on another oscilloscope until you transfer the license back from the oscilloscope to the module. Consider putting the physical module in an envelope or other storage with a label recording the date, module name, model and serial number of the oscilloscope which holds the license. This will help prevent confusion later if someone finds the module, installs it in some other oscilloscope, and wonders why it does not work.*

Upgrading Bandwidth

You may increase the bandwidth of an instrument when your project requirements demand higher performance. Do this by purchasing an upgrade.

1 GHz upgrades require Tek Service installation and option IFC (calibration).

Model to be upgraded	Bandwidth before upgrade	Bandwidth after upgrade	Order this product
MDO3012	100 MHz	200 MHz	MDO3BW1T22
	100 MHz	350 MHz	MDO3BW1T32
	100 MHz	500 MHz	MDO3BW1T52
	100 MHz	1 GHz	MDO3BW1T102
	200 MHz	350 MHz	MDO3BW2T32
	200 MHz	500 MHz	MDO3BW2T52

	200 MHz	1 GHz	MDO3BW2T102
	350 MHz	500 MHz	MDO3BW3T52
	350 MHz	1 GHz	MDO3BW3T102
	500 MHz	1 GHz	MDO3BW5T102
MDO3014	100 MHz	200 MHz	MDO3BW1T24
	100 MHz	350 MHz	MDO3BW1T34
	100 MHz	500 MHz	MDO3BW1T54
	100 MHz	1 GHz	MDO3BW1T104
	200 MHz	350 MHz	MDO3BW2T34
	200 MHz	500 MHz	MDO3BW2T54
	200 MHz	1 GHz	MDO3BW2T104
	350 MHz	500 MHz	MDO3BW3T54
	350 MHz	1 GHz	MDO3BW3T104
	500 MHz	1 GHz	MDO3BW5T104
MDO3022	200 MHz	350 MHz	MDO3BW2T32
	200 MHz	500 MHz	MDO3BW2T52
	200 MHz	1 GHz	MDO3BW2T102
	350 MHz	500 MHz	MDO3BW3T52
	350 MHz	1 GHz	MDO3BW3T102
	500 MHz	1 GHz	MDO3BW5T102
MDO3024	200 MHz	350 MHz	MDO3BW2T34
	200 MHz	500 MHz	MDO3BW2T54
	200 MHz	1 GHz	MDO3BW2T104
	350 MHz	500 MHz	MDO3BW3T54
	350 MHz	1 GHz	MDO3BW3T104

	500 MHz	1 GHz	MDO3BW5T104
MDO3032	350 MHz	500 MHz	MDO3BW3T52
	350 MHz	1 GHz	MDO3BW3T102
	500 MHz	1 GHz	MDO3BW5T102
MDO3034	350 MHz	500 MHz	MDO3BW3T54
	350 MHz	1 GHz	MDO3BW3T104
	500 MHz	1 GHz	MDO3BW5T104
MDO3052	500 MHz	1 GHz	MDO3BW5T102
MDO3054	500 MHz	1 GHz	MDO3BW5T104

To enable the upgrade, you will need to order a bandwidth upgrade product. 1 GHz upgrades require you to send your instrument to a Tektronix Service Center. All others can be performed in the field by the customer.

You will need to supply the model number and serial number when placing your order. To determine the serial number of your instrument, push **Utility**, and then push **About**. The serial number is located on the resulting screen.

To upgrade bandwidth by installing an option key on your instrument,

1. Once you have placed an order for the appropriate bandwidth upgrade product, you should receive an **Option Key Certificate** with the option key number.

2. Push **Utility**.



3. On the lower menu, push **Utility Page** and select **Config**.



4. Push **Manage Modules & Options**.



- On the side menu, push **License Type** until **Options** is highlighted.

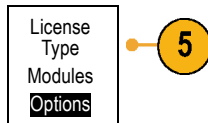

- Push **Install Option**.



- Enter the Option Key number by turning **Multipurpose a** and pushing **Enter Character** on the lower menu. Alternatively, you may use a USB keyboard.

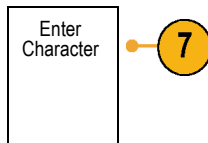

- Push **OK Accept** on the side menu. Following a successful installation of the option key, a message will be displayed indicating that you must power cycle the oscilloscope to enable the new features.

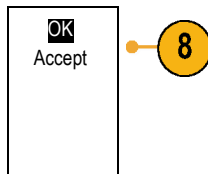

- Power cycle the oscilloscope.

- To verify that the bandwidth has been upgraded, push **Utility**, and then push **About** on the lower menu. The bandwidth information should be towards the top of this screen.

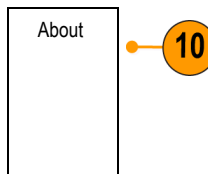

Changing the Language of the User Interface or Keyboard

To change the language of the oscilloscope user interface or keyboard, and to change the front panel button labels through the use of an overlay:

- Push **Utility**.



2. Push **Utility Page**.



3. Turn **Multipurpose a** and select **Config**.

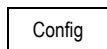

4. Push **Language** from the resulting lower menu.

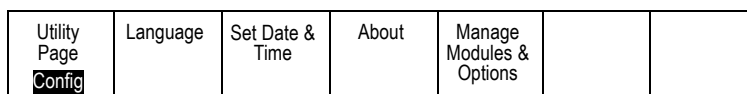

5. Push **Menus** from the resulting side menu and turn **Multipurpose a** to select the desired language for the user interface.

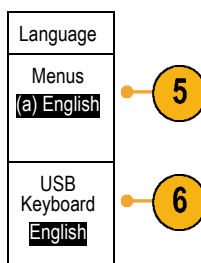

6. Push **USB Keyboard** from the resulting side menu and turn **Multipurpose a** to select the desired language version of keyboard to use.

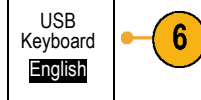

7. If you choose to use an English user interface, be sure that the plastic front panel overlay is removed.
If you choose a language other than English, place the plastic overlay for the language that you desire over the front panel to display labels in that language.

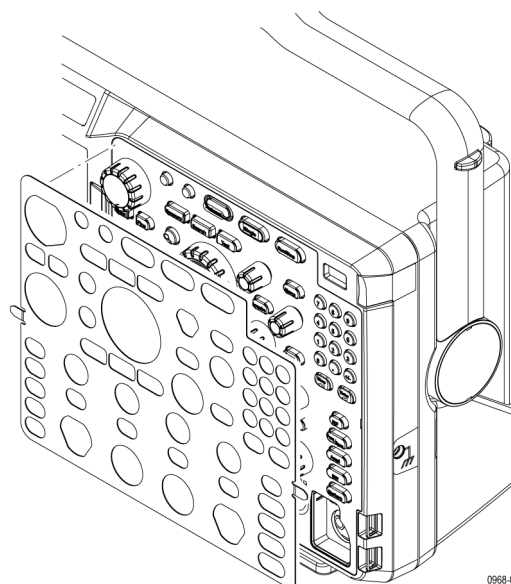

0968-044

Changing the Date and Time

To set the internal clock with the current date and time:

1. Push **Utility**.



2. Push **Utility Page**.



3. Turn **Multipurpose a** and select **Config**.

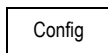

4. Push **Set Date & Time**.

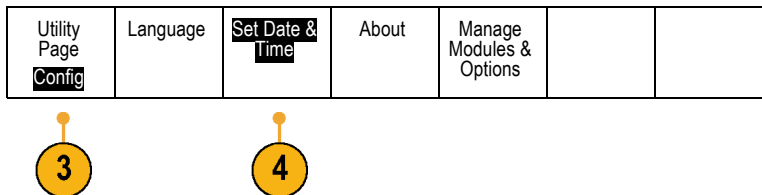

5. Push the side menu buttons and turn both the (**Multipurpose a** and **Multipurpose b**) knobs to set the time and date values.

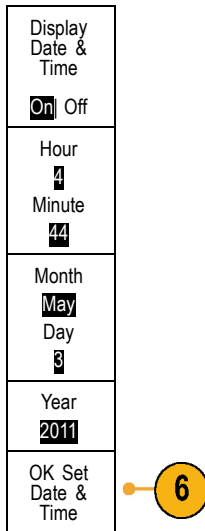

6. Push **OK Set Date & Time**.

Signal Path Compensation

Signal Path Compensation (SPC) corrects for DC inaccuracies caused by temperature variations and/or long-term drift. Run the compensation whenever the ambient temperature has changed by more than 10 °C (18 °F) or once a week if you use vertical settings of 5 mV/division or less. Failure to do so may result in the instrument not meeting warranted performance levels at those volts/div settings.

Signal Path Compensation for Time and Frequency Domains

To compensate the signal path:

1. Warm up the oscilloscope for at least 20 minutes. Remove all input signals (probes and cables) from channel inputs. Input signals with AC components adversely affect SPC.



2. Push **Utility**.



3. Push **Utility Page**.

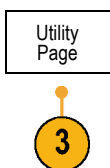

4. Turn **Multipurpose a** and select **Calibration**.

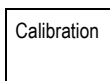

5. Push **Signal Path** on the lower menu.

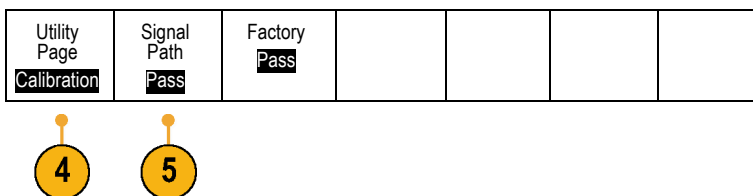

6. Push **OK Compensate Signal Paths** on the resulting side menu.

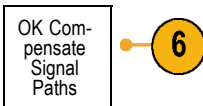

The calibration will take approximately 10 minutes to complete.

7. After calibration, verify that the status indicator on the lower menu displays **Pass**.

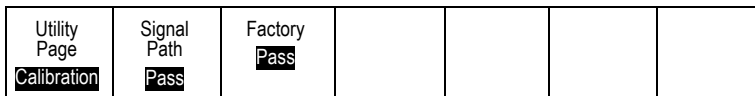

If it does not, then recalibrate the instrument or have the instrument serviced by qualified service personnel.



Service personnel use the factory calibration functions to calibrate the internal voltage references of the oscilloscope using external sources. Contact your Tektronix field office or representative for assistance with factory calibration.

NOTE. Signal Path Compensation does not include calibration to the probe tip. (See page 13, Compensating a non-TPP0250, non-TPP0500B or non-TPP1000 Passive Voltage Probe.)

Signal Path Compensation for Frequency Domain Only

The signal path compensation (SPC) described above runs on both the time and the frequency domain inputs. If you only want to compensate the RF input, you can save time by running SPC only on the RF input and skipping the time domain part. You can do this as follows:

1. As with the time and frequency calibration, warm up the oscilloscope for at least 20 minutes. Remove all input signals (probes and cables) from the RF input.
2. Push **RF** to bring up the Frequency Domain menu.



3. Push **More** to select **Compensate Signal Path**.

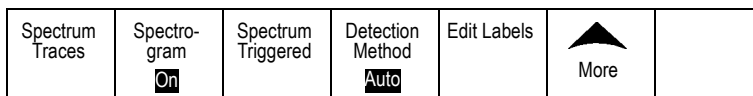

4. On the resulting side menu, push **OK. Compensate RF Signal Path**.



Upgrading Firmware

To upgrade the firmware of the oscilloscope:

1. Open up a Web browser and go to www.tektronix.com/software/downloads. Proceed to the software finder. Download the latest firmware for your oscilloscope on your PC.

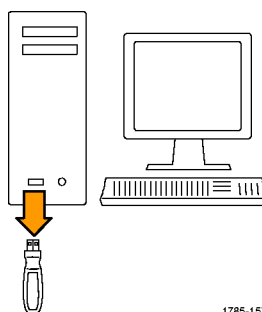

1785-157

Unzip the files and copy the firmware.img file into the root folder of a USB flash drive or USB hard drive.

2. Power off your oscilloscope.



0968-008



3. Insert the USB flash or hard drive into the USB port on the front panel of your oscilloscope.

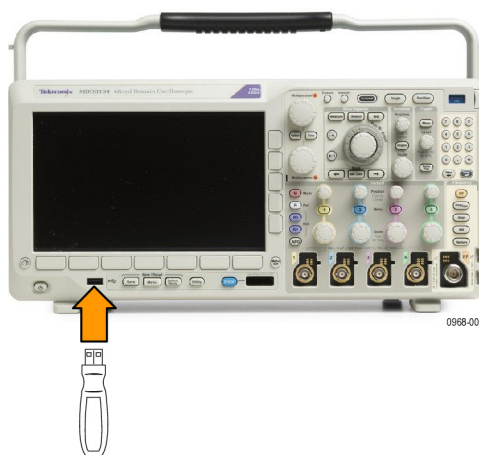

0968-009

4. Power on the oscilloscope. The instrument automatically recognizes the replacement firmware and installs it.

If the instrument does not install the firmware, rerun the procedure. If the problem continues, try a different model of USB flash or hard drive. Finally, if needed, contact qualified service personnel.

NOTE. Do not power off the oscilloscope or remove the USB drive until the oscilloscope finishes installing the firmware.

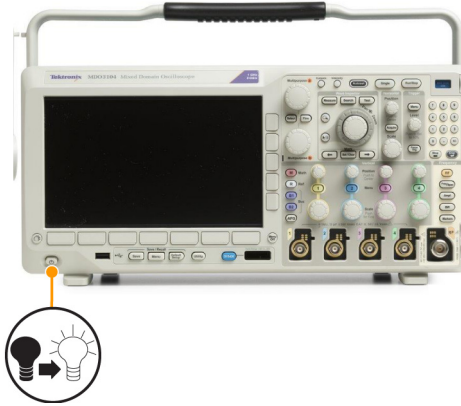

5. Power off the oscilloscope and remove the USB flash or hard drive.



6. Power on the oscilloscope.

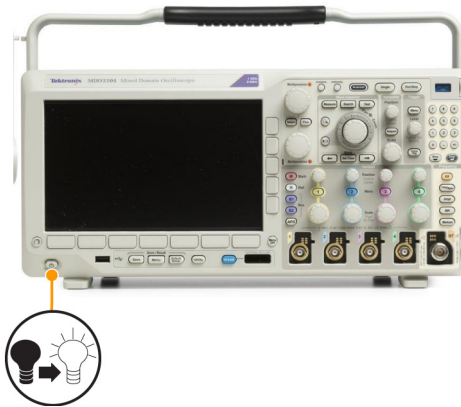

7. Push **Utility**.



3249-012

8. Push **Utility Page**.

Utility
Page



9. Turn **Multipurpose a** and select **Config**.

Config

10. Push **About**. The oscilloscope displays the firmware version number.

Utility Page Config	Language	Set Date & Time	About	Manage Modules & Options		
---------------------------	----------	--------------------	-------	--------------------------------	--	--

11. Confirm that the version number matches that of the new firmware.



Connecting Your Oscilloscope to a Computer

Connect your oscilloscope directly to a computer to let the PC analyze your data, collect screen images, or to control your oscilloscope. (See page 164, *Saving a Screen Image*.) (See page 165, *Saving and Recalling Waveform and Trace Data*.)

Three ways to connect your oscilloscope to a computer are through the VISA drivers, the e*Scope Web-enabled tools, and a socket server. Use VISA to communicate with your oscilloscope from your computer through a software application, such as Tektronix OpenChoice Desktop®. Use e*Scope to communicate with your oscilloscope through a Web browser, such as Microsoft Internet Explorer. For best results, use a browser that supports html 5.

Using VISA

VISA lets you use your MS-Windows computer to acquire data from your oscilloscope for use in an analysis package that runs on your PC, such as Microsoft Excel, National Instruments LabVIEW, Tektronix OpenChoice Desktop software, or a program of your own creation. You can use a common communications connection, such as USB, Ethernet, or GPIB, to connect the computer to the oscilloscope.

For VISA, load the VISA drivers on your computer. Also, load your application, such as OpenChoice Desktop. You will find the drivers and OpenChoice Desktop software on the appropriate CD that comes with your oscilloscope or at the Tektronix software finder Web page (www.tektronix.com).

Using e*Scope

With e*Scope, you can access and control any Internet-connected MDO3000 Series oscilloscope from a web browser on your computer.

Connect the oscilloscope to your network using the LAN port. The built-in LXI web interface (Core 2011, Version 1.4) provides network configuration information, which you can edit and customize. It also provides remote instrument control through the e*Scope user interface. There you can control instrument settings, save screen images, save instrument data or setups, and much more. Do all this through a password-protectable web-interface.

To set up VISA communications between your oscilloscope and a computer:

1. Load the VISA drivers on your computer.
Also, load your application, such as OpenChoice Desktop.
You will find the drivers and OpenChoice Desktop software on the appropriate CD that comes with your oscilloscope or at the Tektronix software finder Web page (www.tektronix.com).

2. Connect the oscilloscope to your computer with the appropriate USB or Ethernet cable.

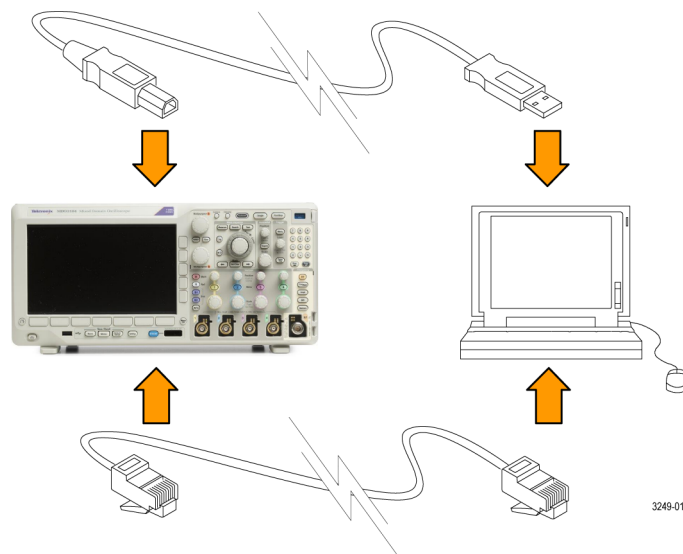

To communicate between the oscilloscope and a GPIB system, connect the oscilloscope to the TEK-USB-488 GPIB-to-USB Adapter with a USB cable. Then connect the adapter to your GPIB system with a GPIB cable. Cycle the power on the oscilloscope.

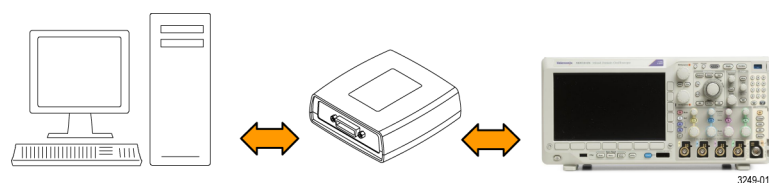

3. Push **Utility**.



4. Push **Utility Page**.

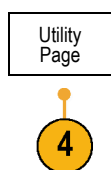

5. Turn **Multipurpose a** and select **I/O**.

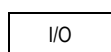

6. If you are using USB, the system sets itself up automatically for you, if USB is enabled.

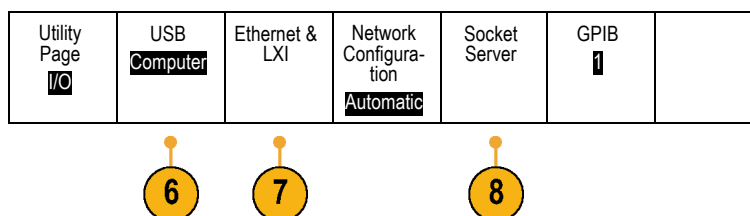

Check **USB** on the lower menu to be sure that USB is enabled. If it is not enabled, push **USB**. Then push **Connect to Computer** on the side menu.

7. To use Ethernet, push **Ethernet & LXI** on the lower menu.

Use the side menu buttons to adjust your network settings, as needed. For more information, see the e*Scope setup information below.

8. If you want to change socket server parameters, push **Socket Server** and enter new values through the resulting side menu.

9. If you are using GPIB, push **GPIB**. Enter the GPIB address on the side menu, by turning the **Multipurpose a** knob.

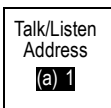

This will set the GPIB address on an attached TEK-USB-488 Adapter.

10. Run your application software on your computer.

Quick Tips

- Your oscilloscope shipped with a CD that contains a variety of Windows-based software tools for efficient connectivity between your oscilloscope and your computer. These include tool bars that speed connectivity with Microsoft Excel and Word. There is also a standalone acquisition program called Tektronix OpenChoice Desktop.
- The rear-panel USB 2.0 device port is the correct USB port for computer connectivity. Use the rear and front panel USB 2.0 host port to connect your oscilloscope to USB flash drives. Use the USB Device port to connect your oscilloscope to a PC or a PictBridge printer.

USB Host port



USB Device port



Using the LXI Web Page and e*Scope

With e*Scope, you can access any Internet-connected MDO3000 Series oscilloscope from a web browser on your computer or tablet.

To set up e*Scope communications between your oscilloscope and a Web browser running on a remote computer:

1. Connect the oscilloscope to your computer network with an appropriate Ethernet cable.

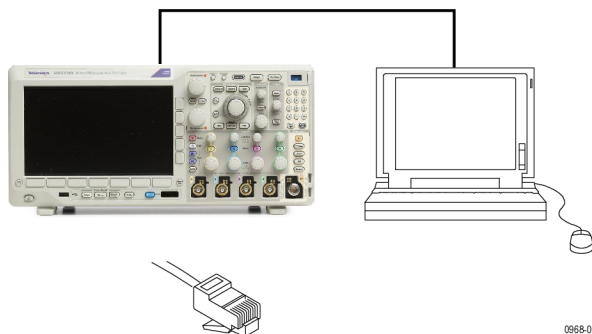

0968-010

2. Push **Utility**.



3249-012

3. Push **Utility Page**.



4. Turn **Multipurpose a** and select **I/O**.

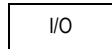

5. Push **Ethernet & LXI**.

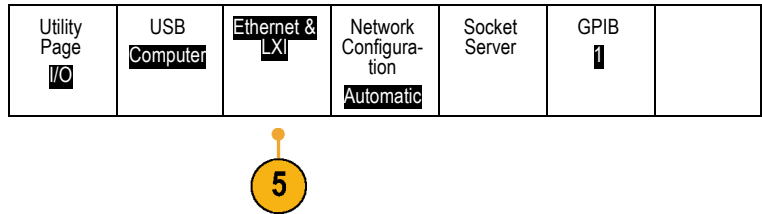

6. View the top item on the side menu to determine the condition of the LAN. An indicator turns green for good status and red if the device detects a fault.



7. Push **LAN Settings** to display the network parameters configured on your oscilloscope.



8. Push **LAN Reset** to restore the LAN defaults to your oscilloscope.



9. Push **Test Connection** to check if your oscilloscope can find an attached network.



10. Push **more** to see another page of side menu items.

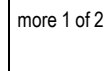

11. Push **Change Names** to change the name of the oscilloscope, the network domain, or the service name.
12. Push **Change Ethernet & LXI Password** to change the name of the password.
13. Push **Change e*Scope Password** to use the LXI password to also protect your oscilloscope from changes made to LAN settings from a Web browser.

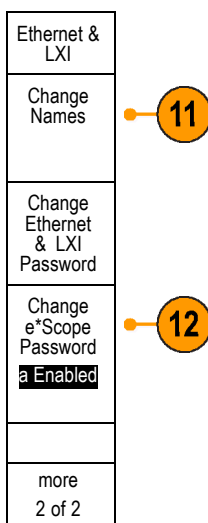

14. Start your browser on your remote computer. In the browser address line, enter the host name, a dot, and the domain name together. Alternatively, just enter the IP address of the instrument. Either way, you should then see the LXI Welcome page on your Web browser on your computer screen.
15. Click "Network Configuration" to view and edit the network configuration settings. If you are using a password and changing your settings, you need to know that the default user name is "ixiuser".

- For e*Scope, click the Instrument Control (e*Scope) link on the left side of the LXI Welcome page. You should then see a new tab (or window) open in your browser with e*Scope running.

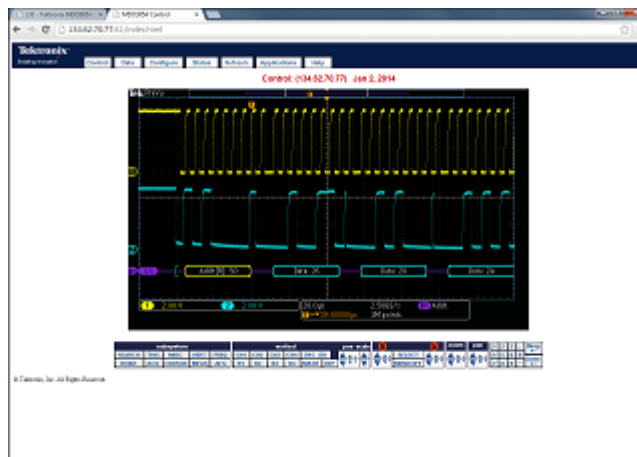
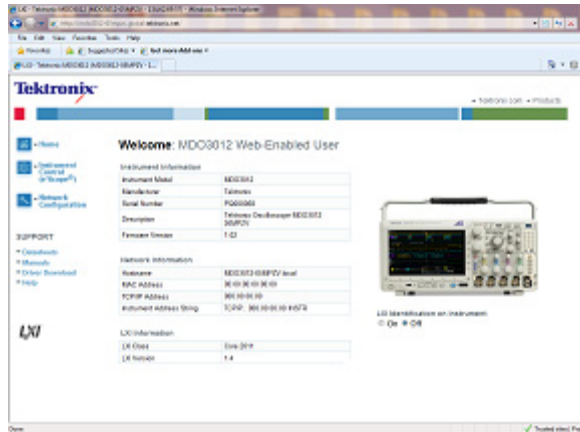

Using a Socket Server

A socket server provides two-way communication over an Internet Protocol-based computer network. You can use your oscilloscope's socket server feature to let your oscilloscope communicate with a remote-terminal device or computer.

To set up and use a socket server between your oscilloscope and a remote terminal or computer:

- Connect the oscilloscope to your computer network using an appropriate Ethernet cable.

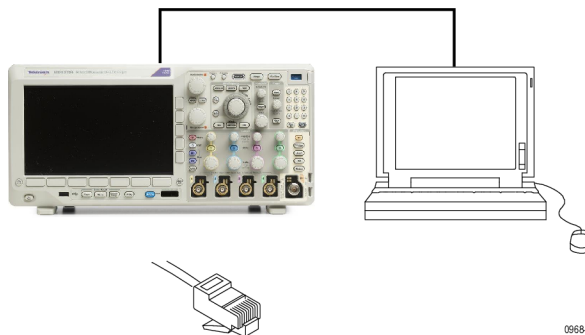

0958-010

2. Push **Utility**.



3. Push **Utility Page**.

Utility Page



4. Turn **Multipurpose a** and select **I/O**.

I/O

5. Push **Socket Server**.

Utility Page I/O	USB Computer	Ethernet & LXI	Network Configura- tion Manual	Socket Server	GPIB 1	
---------------------	-----------------	-------------------	--------------------------------------	---------------	-----------	--



6. On the resulting Socket Server side menu, push the top entry to highlight **Enabled**.

Socket Server
Enabled
Disabled

7. Choose whether the protocol should be **None** or **Terminal**.

A communication session run by a human at a keyboard typically uses a terminal protocol. An automated session might handle its own communications without such protocol from the oscilloscope.

Protocol
None
Terminal

8. If required, change the port number by turning **Multipurpose a**.

Current Port 4000
Select Port
(a) 4000
OK
Set Port

9. If required, press **OK** to set the new port number.

- After you have set up the socket server parameters, the computer is now ready to communicate with the oscilloscope. If you are running an MS Windows PC, you could run its default client Telnet, which has a command interface. One way to do this is by typing "Telnet" in the Run window. The Telnet window will open on the PC.

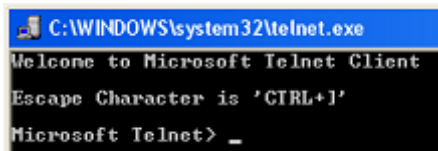

NOTE. On MS Windows 7, you must first enable Telnet in order for Telnet to work.

- Start a terminal session between your computer and your oscilloscope by typing in an open command with the oscilloscope's LAN address and port #.

You can obtain the LAN address by pushing the **Ethernet & LXI** lower menu button and the resulting **LAN Settings** side menu button to view the resulting Ethernet and LXI Settings screen. You can obtain the port # by pushing **Socket Server** on the lower menu and viewing **Current Port** on the side menu.

For example, if the oscilloscope IP address was 123.45.67.89 and the port # was the default of 4000, you could open a session by writing into the MS Windows Telnet screen: o 123.45.67.89 4000.

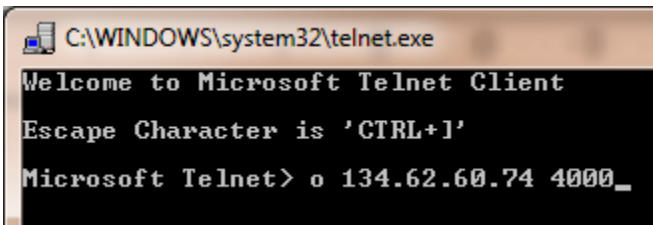

The oscilloscope will send a help screen to the computer when it has finished connecting.



12. You can now type in a standard query, such as, `*idn?`

The Telnet session window will respond by displaying a character string describing your instrument.

You can type in more queries and view more results using this Telnet session window. You can find the syntax for relevant commands, queries and related status codes in the MDO3000 Series Programmer Manual.

NOTE. Do not use the computer's backspace key during an MS Windows Telnet session with the oscilloscope.

Connecting a USB Keyboard to Your Oscilloscope

You can connect a USB keyboard to a USB Host port on the rear or front panel of the oscilloscope. The oscilloscope will detect the keyboard, even if it is plugged in while the oscilloscope is powered on.

You can use the keyboard to quickly create names or labels. You can bring up the **Label** button on the lower menu by pushing a Channel or Bus button. Use the arrow keys on the keyboard to move the insertion point, and then type in a name or label. Labeling channels and buses makes the information on the screen easier to identify.

To choose whether to use a keyboard with a United States (US) key layout or one with an alternative layout:

1. Push **Utility**.



2. Push **Utility Page**.

Utility Page Config	Language	Set Date & Time	About	Manage Modules & Options		
------------------------	----------	-----------------	-------	--------------------------	--	--

3. Turn **Multipurpose a** and select **Config**.



4. Push **Language** on the lower menu.
5. Push **USB Keyboard** on the side menu.
6. Turn **Multipurpose a** and select the desired keyboard layout style from the resulting menu.

Get Acquainted with the Instrument

Front-Panel Menus, Controls, and Connectors

Overview

The front panel has buttons and controls for the functions that you use most often. Use the menu buttons to access more specialized functions.

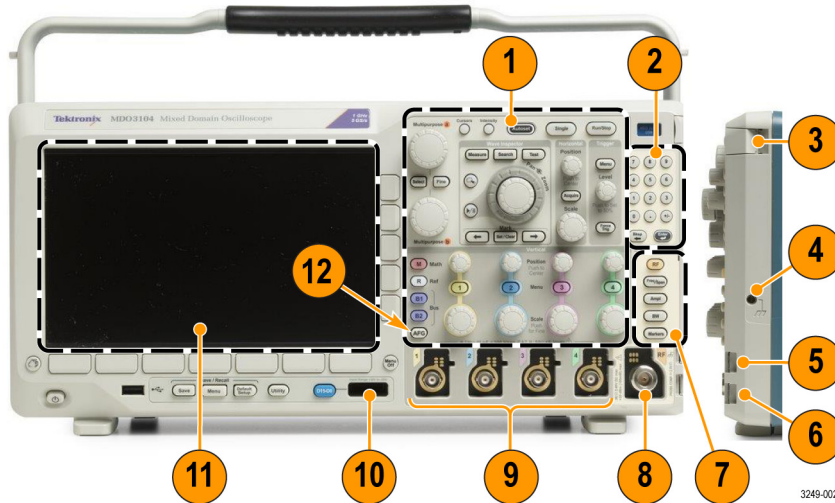

1. Traditional oscilloscope front panel controls
2. 10-digit keypad
3. Application module slots
4. Ground strap connector
5. Ground
6. PROBE COMP
7. Dedicated spectral analysis controls
8. Dedicated RF input with N-connector
9. Analog channel (1, 2, (3, 4)) inputs with TekVPI versatile probe interface
10. Digital channel input
11. Display: shows frequency or time domain
12. Arbitrary function generator (AFG) enable button

Front Panel Menus and Controls

The front panel has buttons and controls for the functions that you use most often. Use the menu buttons to access more specialized functions.

Using the Menu System

To use the menu system:

1. Push a front panel menu button to display the menu that you want to use.

NOTE. The **B1** and **B2** buttons support up to two different serial or parallel buses.



2. Push a lower menu button. If a pop-out menu appears, turn **Multipurpose a** to select the desired choice. If a pop-up menu appears, push the button again to select the desired choice.



3. Push a side menu button.
If the menu item contains more than one choice, push the side button repeatedly to cycle through the choices.
If a pop-out menu appears, turn **Multipurpose a** to select the desired choice.



- To remove a side menu, push the lower button or push **Menu Off**.



- Certain menu choices require you to set a numeric value to complete the setup. You can use the upper and lower multipurpose knobs **a** and **b** to adjust values. You can also set many numerical values with the 10-digit keypad on the front panel.

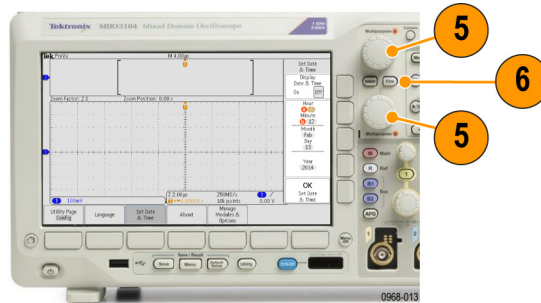

- Push **Fine** to turn off or on the ability to make smaller adjustments.

Using the Menu Buttons

Use the menu buttons to perform many functions in the oscilloscope.

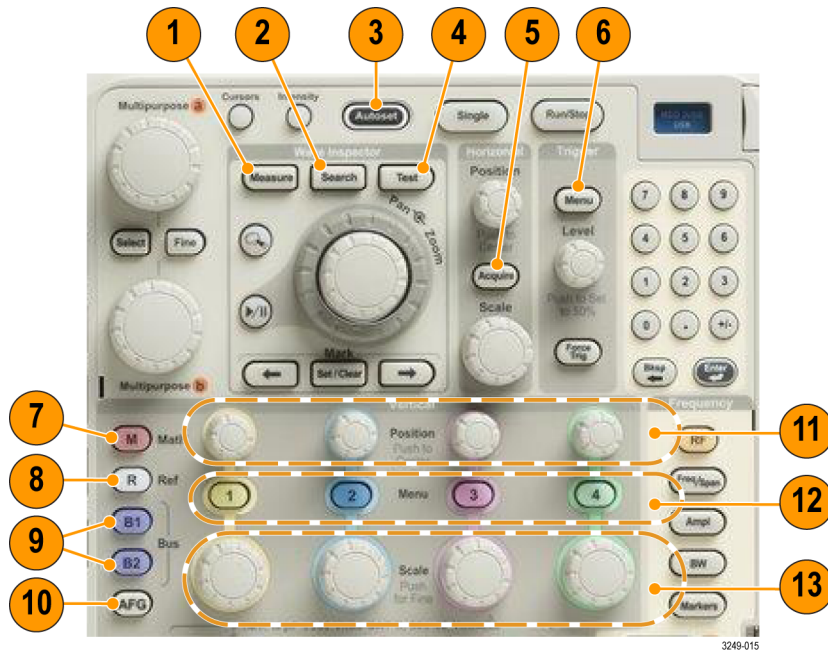

- Measure.** Push to perform automated measurements on waveforms and to access the digital voltmeter (DVM) and waveform histogram functions.
- Search.** Push to perform an automated search through an acquisition for user-defined events/criteria.
- Autoset.** Push to perform an automatic setup of oscilloscope settings.
- Test.** Push to activate advanced or application-specific testing features.

5. **Acquire.** Push to set the acquisition mode and adjust the record length.
6. **Trigger Menu.** Push to specify trigger settings.
7. **M.** Push to manage the math waveform, including the display or removal of the math waveform from the display.
8. **R.** Push to manage reference waveforms, including the display or removal of each reference waveform from the display.
9. **B1 or B2.** Push to define and display a serial bus if you have the appropriate application modules. Parallel bus support is available on MDO3000 products with the MDO3MSO option installed. Also, push the **B1** or **B2** button to display or remove the corresponding bus from the display.
10. **AFG.** Push to enable the arbitrary function generator output and access the AFG menu.
11. **Vertical Position.** Turn to adjust the vertical position of the corresponding waveform. Push to center the waveform baseline indicator.
12. **Channel 1, 2, 3, or 4 Menu.** Push to set vertical parameters for input waveforms and to display or remove the corresponding waveform from the display.
13. **Vertical Scale.** Turn to adjust the vertical scale factor of the corresponding waveform (volts/division). Push the front-panel **Fine** button to make smaller adjustments.

Below the display buttons

Use the buttons below the display to perform many functions in the oscilloscope.

1. **Save / Recall Menu.** Push to define the **Save** button to save and recall setups, waveforms, or screen images to internal memory, a USB flash drive, or a mounted network drive.

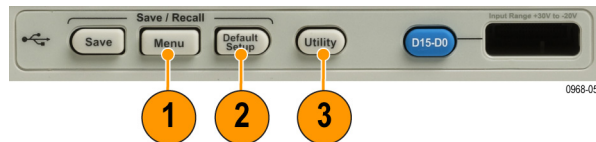

2. **Default Setup.** Push to perform an immediate restore of the oscilloscope to the default settings.



3. **Utility.** Push to activate the system utility functions, such as selecting a language or setting the date/time.



4. **B1** or **B2**. Push to define and display a bus if you have the appropriate module application keys.

- MDO3AERO supports ARINC429 and MIL-STD-1553 buses.
- MDO3AUDIO supports I²S, Left Justified (LJ), Right Justified (RJ), and TDM buses.
- MDO3AUTO supports CAN, CAN FD, and LIN buses.
- MDO3EMBD supports I²C and SPI buses.
- MDO3COMP supports RS-232, RS-422, RS-485, and UART buses.
- MDO3FLEX supports FlexRay buses.
- MDO3USB supports USB 2.0 buses.

Also, push the **B1** or **B2** button to display or remove the corresponding bus from the display.

5. **R**. Push to manage reference waveforms and traces, including the display or removal of each reference waveform or trace from the display.

6. **M**. Push to manage the math waveform or trace, including the display or removal of the math waveform or trace from the display.



0968-050

Using Spectral Analysis Controls

These buttons configure the acquisition and display of the RF input.

1. **RF.** Push to bring up the frequency domain display and menu. The RF menu provides access to the Spectrogram display.
2. **Freq/Span.** Push to specify the portion of the spectrum to view on the display. Set the center frequency and the span – or set the start and stop frequency.
3. **Ampl.** Push to set the reference level.
4. **BW.** Push to define the resolution bandwidth.
5. **Markers.** Push to set automatic or manual markers.

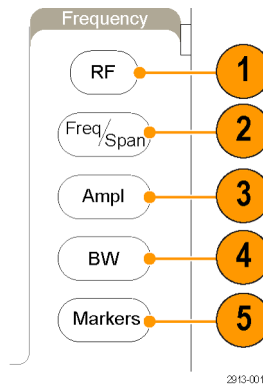

Using Other Controls

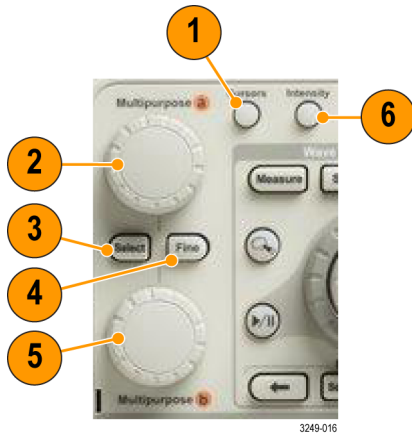

1. **Cursors.** Push once to activate the two vertical cursors. Push again to turn off all cursors. Push and hold to bring up the cursor menu. Use the menu to select the cursor features, such as type, source, orientation, linked status, and units.
When the cursors are on, you can turn the multipurpose knobs to control their position.
2. Turn the upper multipurpose knob **a**, when activated, to move a cursor, to set a numerical parameter value for a menu item, or to select from a pop-out list of choices. Push the **Fine** button to toggle between coarse and fine adjustment.
Screen icons tell you when **a** or **b** are active.
3. **Select.** Push to activate special functions.

For example, when using the two vertical cursors (and no horizontal ones are visible), you can push this button to link or unlink the cursors. When the two vertical and two horizontal cursors are both visible, you can push this button to make either the vertical cursors or the horizontal cursors active.

4. **Fine.** Push to toggle between making coarse and fine adjustments with the many operations of multipurpose knobs **a** and **b**
5. Turn the lower **Multipurpose b** knob, when activated, to move a cursor or set a numerical parameter value for a menu item. Push **Fine** to make adjustments more slowly.
6. **Intensity.** Push to enable **Multipurpose a** to control waveform display intensity and knob **b** to control graticule intensity.

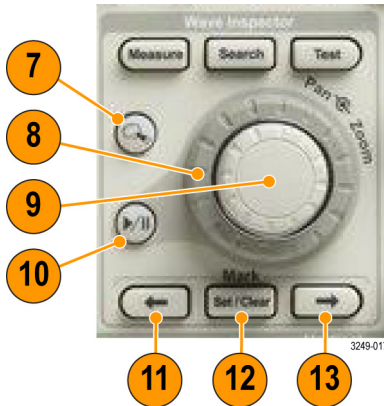

7. **Zoom** button. Push to activate zoom mode.
8. **Pan** (outer knob). Turn to scroll the zoom window through the acquired waveform.
9. **Zoom-scale** (inner knob). Turn to control the zoom factor. Turning it clockwise zooms in further. Turning it counterclockwise zooms out.
10. **Play-pause** button. Push to start or stop the automatic panning of a waveform. Control the speed and direction with the pan knob.
11. ← **Prev.** Push to jump to the previous waveform mark.
12. **Set/Clear Mark.** Push to establish or delete a waveform mark.
13. → **Next.** Push to jump to the next waveform mark.

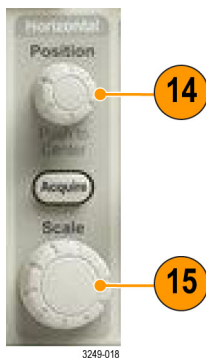

14. Horizontal Position. Turn to adjust the trigger point location relative to the acquired waveforms. Push to center when delay is on. Push to set to 10% when delay is off.

15. Horizontal Scale. Turn to adjust the horizontal scale (time/division).

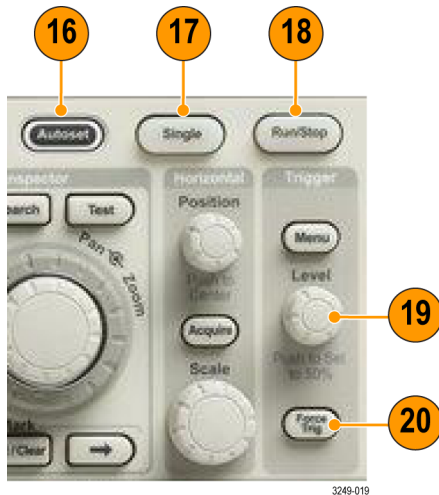

16. Autoset. Push to automatically set the vertical, horizontal, and trigger controls for a usable, stable display.

17. Single. Push to make a single sequence acquisition.

18. Run/Stop. Push to start or stop acquisitions.

19. Trigger Level. Turn to adjust the trigger level.

Push Level to Set 50%. Push the Trigger level knob to set the trigger level to the midpoint of the waveform.

20. Force Trig. Push to force an immediate trigger event.



- 21. **Print.** Push to print to the selected printer.
- 22. **Power switch.** Push to power on or off the oscilloscope.
- 23. **USB 2.0 Host port.** Insert a USB peripheral to the oscilloscope, such as a keyboard or a flash drive.
- 24. **Save.** Push to perform an immediate save operation. The save operation uses the current save parameters, as defined in the Save / Recall menu.
- 25. **Save / Recall Menu.** Push to save and recall setups, waveforms, and screen images to internal memory, or a USB flash drive.
- 26. **Default Setup.** Push to perform an immediate restore of the oscilloscope to the default settings.
- 27. **Utility.** Push to activate the system utility functions, such as selecting a language or setting the date/time.
- 28. **D15 - D0.** Push to display or remove the digital channels from the display, and to access the digital channel setup menu (with option MDO3MSO only).
- 29. **Menu Off.** Push to clear a displayed menu from the screen.

Identifying Items in the Time Domain Display

The items shown in the graphic below may appear in the display. Not all of these items are visible at any given time. Some readouts move outside the graticule area when menus are turned off.

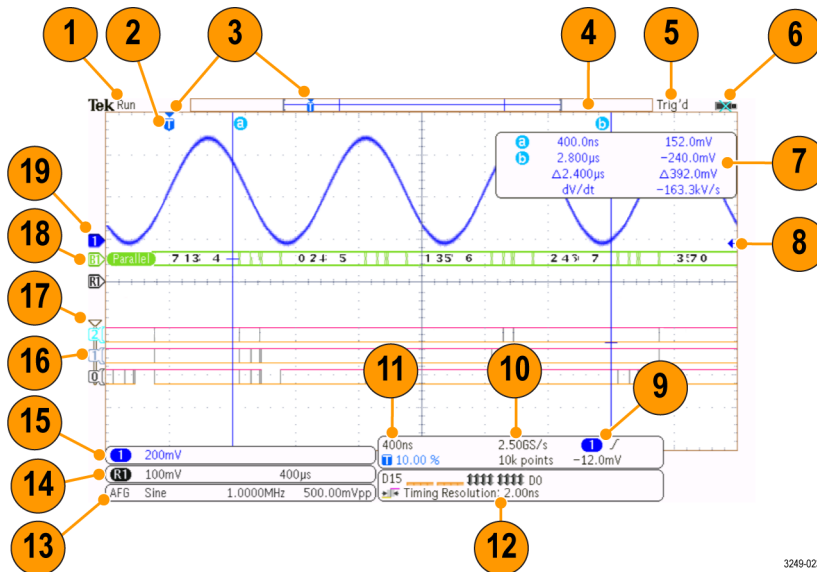

3249-023

1. The acquisition readout shows when an acquisition is running, stopped, or when acquisition preview is in effect. Run = acquisitions enabled. Stop = Acquisitions not enabled. Roll = roll mode (40 ms/div or slower). PreVu = The oscilloscope is stopped or between triggers. You can change the horizontal or vertical position or scale to see approximately what the next acquisition will look like. A/B = When using the average acquisition mode, B shows the total number of acquisitions to be averaged (set this using the Acquisition Mode side menu), and A shows the current progress towards this total number.
2. The trigger position icon shows the trigger position in the acquisition.

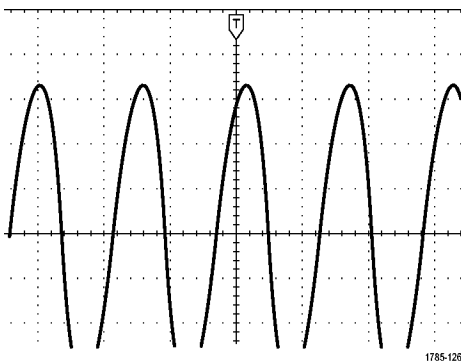

1785-126

3. The expansion point icon (an orange triangle) shows the point that the horizontal scale expands and compresses around. To make the expansion point the same as the trigger point, push **Acquire** and set the lower menu **Delay** item to **Off**.

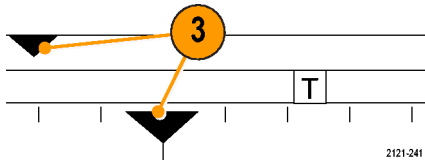

- The waveform record view shows the trigger location relative to the waveform record. The line color corresponds to the selected waveform color. The brackets show the part of the record currently displayed on the screen.

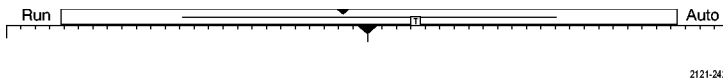

- The trigger status readout shows trigger status. Status conditions are: PrTrig: Acquiring pretrigger data. Trig? = Waiting for trigger. Trig'd: Triggered. Auto: Acquiring untriggered data.
- The security icon indicates when the I/O ports are disabled.
- The cursor readout shows time, amplitude, and delta (Δ) values for each cursor. For FFT measurements, it shows frequency and magnitude. For serial and parallel buses, the readout shows the decoded values.

a	400.0ns	152.0mV
b	2.800 μ s	-240.0mV
	Δ 2.400 μ s	Δ 392.0mV
	dV/dt	-163.3kV/s

- The trigger level icon shows the trigger level on the waveform. The icon color corresponds to the trigger source color.

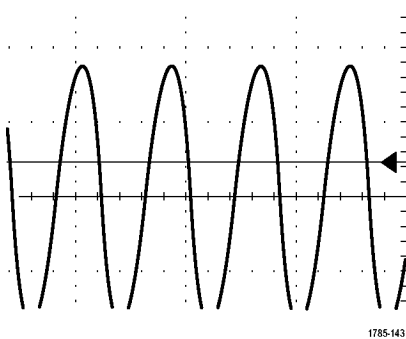

- The trigger readout shows the trigger source, slope, and level. The trigger readouts for other trigger types show other parameters.



- The top line of the record length/sampling rate readout shows the sampling rate. You can adjust it with the **Horizontal Scale** knob. The bottom line shows the record length. You can adjust it by pushing **Acquire** and **Record Length** on the lower menu.

2.50GS/s
10k points

11. The horizontal position/scale readout shows on the top line the horizontal scale (adjust with the **Horizontal Scale** knob). With **Delay Mode** on, the bottom line shows the time from the T symbol to the expansion point icon (adjust with the **Horizontal Position** knob). Use horizontal position to insert added delay between when the trigger occurs and when you actually capture the data. Insert a negative time to capture more pretrigger information. With **Delay Mode** off, the bottom line shows the time location of the trigger within the acquisition, as a percentage.

400ns
10.00 %

12. The Timing Resolution readout shows the timing resolution of the digital channels. Timing resolution is the time between samples. It is the reciprocal of the digital sample rate. When the MagniVu control is on, "MagniVu" appears in the readout.

D15  Timing Resolution: 2.00ns
3249-025

13. Measurement readouts show the selected measurements. You can select up to four measurements to display at one time. A  symbol appears instead of the expected numerical measurement if a vertical clipping condition exists. Part of the waveform is above or below the display. To obtain a proper numerical measurement, turn the vertical scale and position knobs to make all of the waveform appear in the display.

① Period 995 μ s
① Freq 1.004 kHz
1785-144

14. The auxiliary waveform readouts show the vertical and horizontal scale factors of the math and reference waveforms.

Ⓜ
1785-138

15. The channel readout shows the channel scale factor (per division), coupling, invert, and bandwidth status. Adjust with the **Vertical Scale** knob and in the channel 1, 2, 3, or 4 menus.

① \downarrow 20.0mV Ω BW
2121-243

16. For digital channels, the baseline indicators point to the high and low levels. The indicator colors follow the color code used on resistors. The D0 indicator is black, the D1 indicator is brown, the D2 indicator is red, and so on.

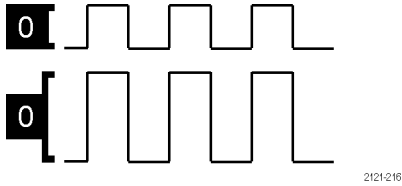

17. The group icon indicates when digital channels are grouped.

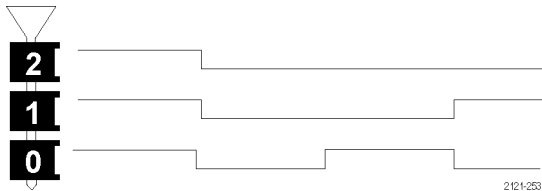

18. The bus display shows decoded packet level information for serial buses or for parallel buses. The bus indicator shows the bus number and bus type.

19. For analog channels, the waveform baseline indicator shows the zero-volt level of a waveform, assuming you have not used any offset. The icon colors correspond to the waveform colors.

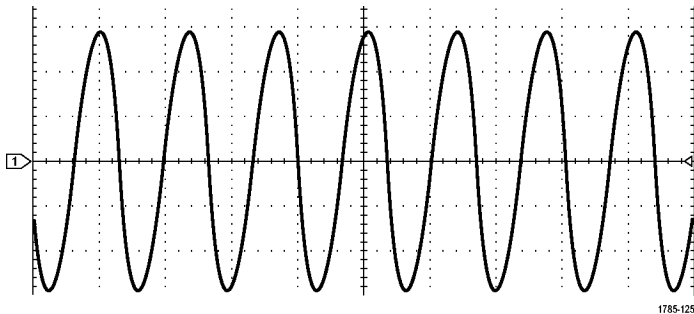

Identifying Items in the Frequency Domain Display

Activate the frequency domain display by pressing the front panel **RF** button.

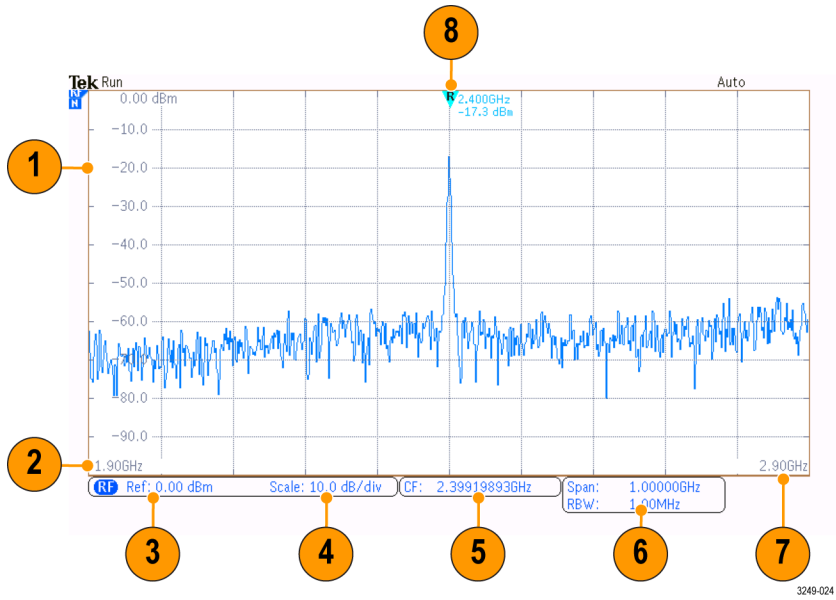

1. Vertical graticule labels
2. Start frequency
3. Reference level
4. Vertical scale
5. Center frequency
6. Span and resolution bandwidth
7. Stop frequency
8. Reference marker

Identifying Items in the Arbitrary Function Generator Display

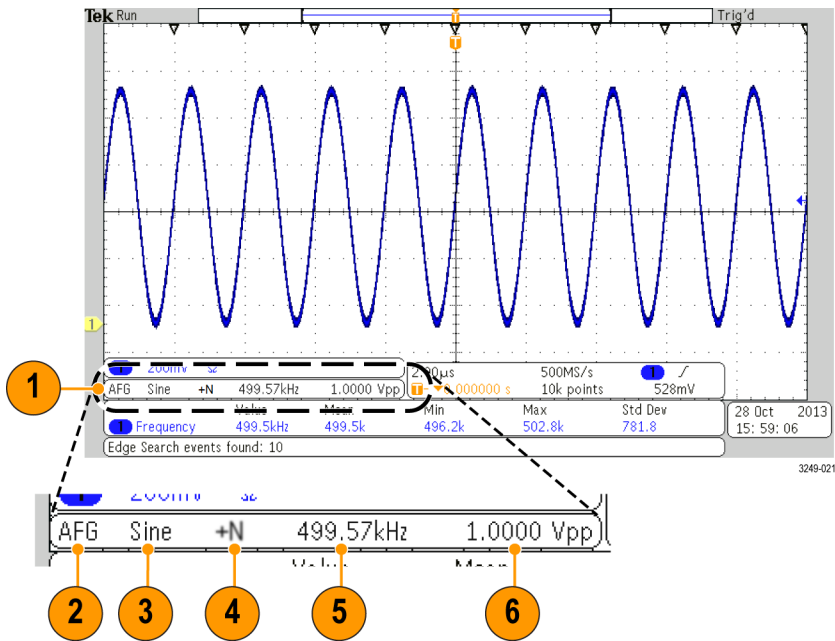

1. If visible, the output is on
2. AFG label
3. Waveform type, e.g. "Sine"
4. Additive Noise icon
5. Frequency
6. Amplitude

(See page 185, *Use the Arbitrary Function Generator.*)

Identifying Items in the Digital Voltmeter Display

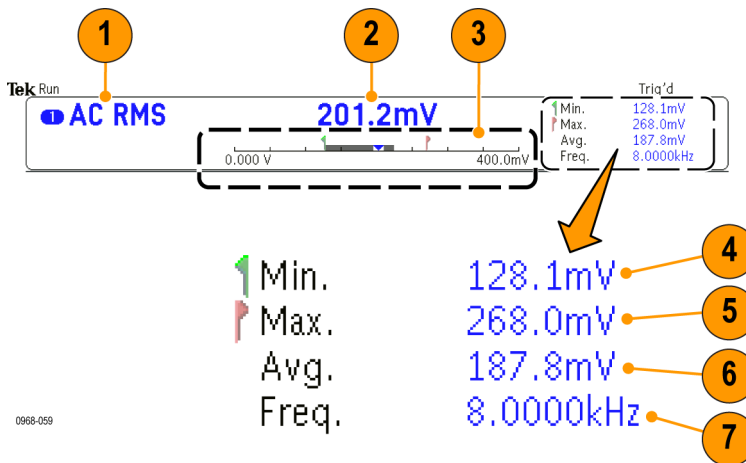

1. Measurement type (AC+DC RMS, DC, AC RMS, or Frequency)
2. Numerical value of the current measurement
3. Graphic (min, max, value, five-second rolling range)
 - The number on the left side of the graphic's linear scale is the minimum value of the range (e.g. 0.000 V).
 - The number on the right side of the graphic's linear scale is the maximum value of the range (e.g. 400.0 mV).
 - The gray bar shows the five second rolling average of measurements.
 - The inverted triangle shows the location on the scale of the current measurement value.
4. Minimum measurement value recorded since you powered on the instrument or since you last pushed the **Reset DVM Statistics** menu item.
5. Maximum measurement value recorded since you powered on the instrument or since you last pushed the **Reset DVM Statistics** menu item.
6. Average of all measurement values recorded since you powered on the instrument or since you last pushed the **Reset DVM Statistics** menu item.
7. Frequency

NOTE. An "Over bandwidth" message appears for voltage measurements ≥ 10 kHz. An "Under bandwidth" message appears for voltage measurements ≤ 10 Hz. A "?" message appears next to min or max measurements that have gone out of bounds. Push **Reset DVM Statistics** to remove the "?" from the display.

(See page 133, *Taking Digital Voltmeter Measurements*.)

Front Panel Connectors

1. Logic Probe Connector
2. Channel 1, 2, 3, 4. Channel inputs with TekVPI Versatile Probe Interface.
3. RF input connector.
4. **PROBE COMP.** Square wave signal source to compensate or calibrate probes. Output voltage: 0 – 2.5 V, amplitude $\pm 1\%$ behind 1 k Ω $\pm 2\%$. Frequency: 1 kHz.
5. Ground.
6. Application Module Slots.

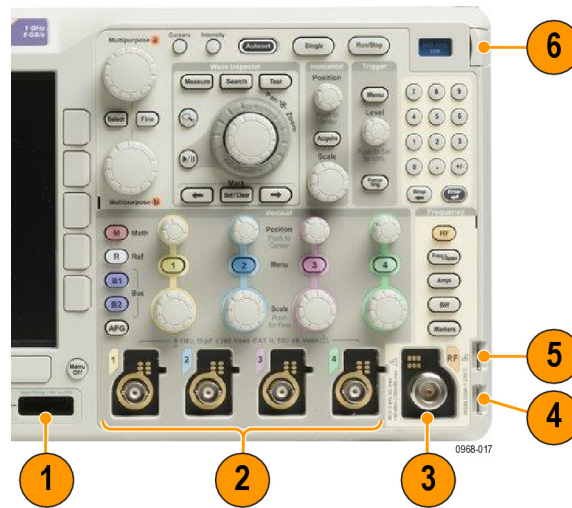

Side-Panel Connector

1. Ground strap connector. This is a receptacle for a grounding strap.

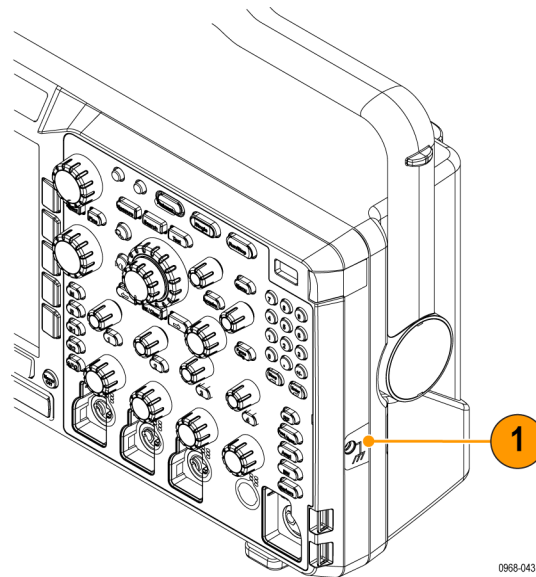

Rear-Panel Connectors

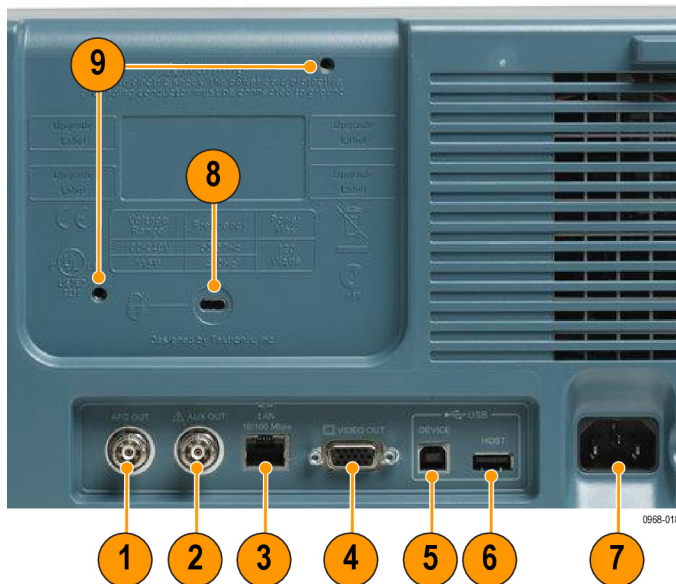

1. **AFG OUT.** Use the AFG OUT port to transmit signals from the arbitrary function generator.
2. **AUX OUT**
3. **LAN.** Use the LAN (Ethernet) port (RJ-45 connector) to connect the oscilloscope to a 10/100 Base-T local area network.
4. **Video Out.** Use the Video Out port (DB-15 female connector) to show the oscilloscope display on an external monitor or projector.
5. **USB 2.0 Device port.** Use the USB 2.0 High Speed Device port to connect a PictBridge compatible printer, or for direct PC control of the oscilloscope using USBTMC protocol.

NOTE. The cable connected from the USB 2.0 Device port to the host computer must meet the USB2.0 specification for high speed operation when connected to a high speed host controller.

6. **USB 2.0 Host port.** Use the USB 2.0 High Speed Host port to connect a USB memory device or USB keyboard.
7. **Power input.** Attach to an AC power line with integral safety ground.
8. **Lock.** Use to secure the oscilloscope.
9. **VESA mount.** 75 mm.

Acquire the Signal

This section describes concepts of and procedures for setting up the oscilloscope to acquire the signal as you want it to.

Setting Up Analog Channels

Use front panel buttons and knobs to set up your instrument to acquire signals using the analog channels.

1. Connect the TPP0250/TPP0500B/TPP1000 or VPI probe to the input signal source.

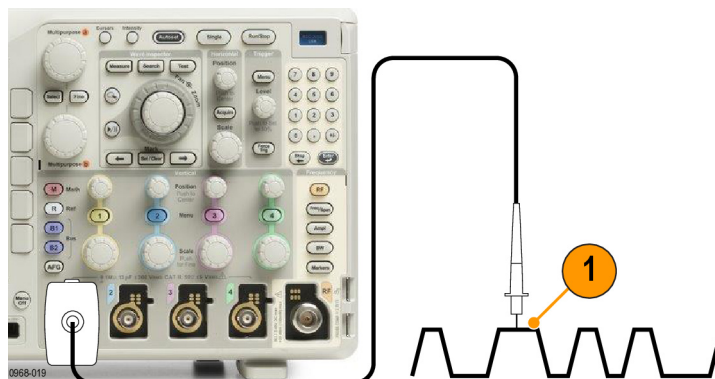

2. Select the input channel by pushing the front panel buttons.

NOTE. If you are using a probe that does not supply probe encoding, set the attenuation (probe factor) in the oscilloscope vertical menu for the channel to match the probe.

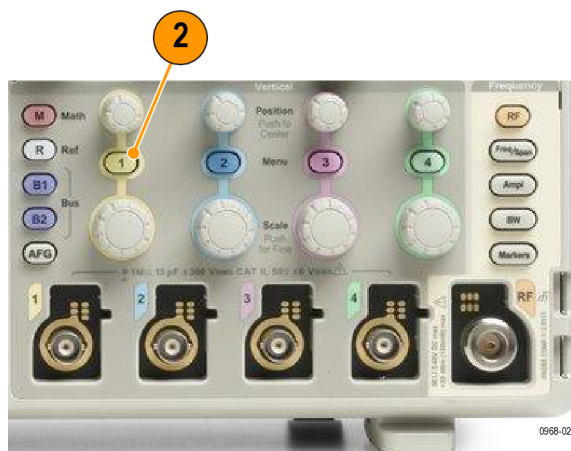

3. Push **Default Setup**.



4. Push **Autoset**.



- 5. Push the desired channel button. Then adjust the vertical position and scale.



- 6. Adjust the horizontal position and scale.

The horizontal position determines the number of pretrigger and posttrigger samples.

The horizontal scale determines the size of the acquisition window relative to the waveform. You can scale the window to contain a waveform edge, a cycle, several cycles, or thousands of cycles.

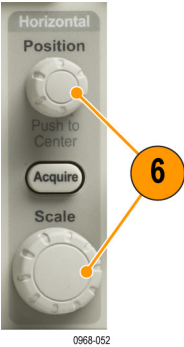

Quick Tip

- Use the zoom feature to see multiple cycles of your signal in the upper part of the display, and a single cycle in the lower part of the display. (See page 149, *Using Wave Inspector to Manage Long Record Length Waveforms.*)

Labeling Channels and Buses

You can add a label to the channels and buses shown on the display for easy identification. The label is placed on the waveform baseline indicator in the left side of the screen. The label can have up to 32 characters.

To label a channel, push a channel input button for an analog channel.

- 1. Push a front panel button for an input channel or a bus.



2. Push a lower menu button to create a label, such as for channel 1 or B1.

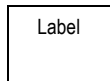

3. Push **Choose Preset Label** to view a list of labels.

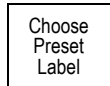

4. Turn **Multipurpose b** to scroll through the list to find a suitable label. You can edit the label after you insert it if necessary.

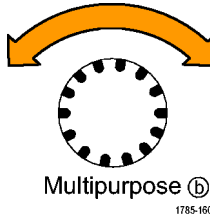

5. Push **Insert Preset Label** to add the label.



If you are using a USB keyboard, use the arrow keys to position the insertion point and edit the inserted label, or type in a new label. (See page 35, *Connecting a USB Keyboard to Your Oscilloscope.*)

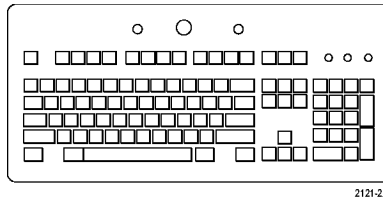

2121-220

6. If you do not have a USB keyboard connected, push the side and lower menu arrow keys to position the insertion point.

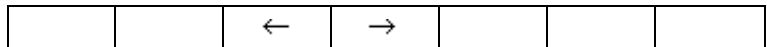
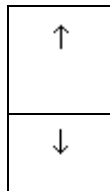

- Turn **Multipurpose a** to scroll through the list of letters, numbers, and other characters to find the character in the name that you want to enter.

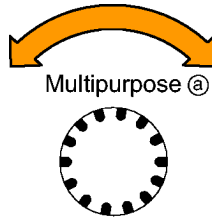

1785-039
 ABCDEFGHIJKLMNOPQRSTUVWXYZ
 abcdefghijklmnopqrstuvwxyz
 0123456789_ =+!@#\$%^&*()[]{}<>/~"'\:;.,?>

- Push **Select** or **Enter Character** to let the oscilloscope know that you have picked the proper character to use.



You can use the lower menu buttons to edit the label as needed.

Enter Character		←	→	Back Space	Delete	Clear
-----------------	--	---	---	------------	--------	-------

- Continue scrolling and pushing **Select** until you have entered all the desired characters. For another label, push the side and lower menu arrow keys to reposition the insertion point.

- Push **Display Labels** and select **On** to see the label.

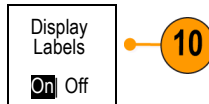

Using the Default Setup

To return the oscilloscope to its default settings:

- Push **Default Setup**.



- If you change your mind, push **Undo Default Setup** to undo the last default setup.

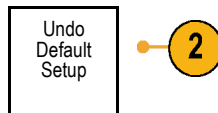

Using Autoset

Autoset adjusts the instrument (acquisition, horizontal, trigger, and vertical controls) such that it displays four or five waveform cycles for analog channels with the trigger near the midlevel, and ten cycles for digital channels.

Autoset works with both the analog and digital channels.

1. To autoset an analog channel, connect the analog probe, and then select the input channel. (See page 54, *Setting Up Analog Channels*.)



To autoset a digital channel, connect the logic probe and select the input channel. (See page 81, *Setting Up Digital Channels*.)



2. Push **Autoset** to execute an Autoset.



3. If desired, push **Undo Autoset** to undo the last Autoset.



You can also disable the Autoset function. To disable or enable the Autoset function:

1. Push and hold **Autoset**.



2. Push and hold **Menu Off**.



3. Release **Menu Off**, and then release **Autoset**.

- Select the desired setting using the side menu.

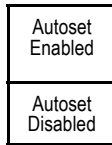

Quick Tips

- To position the waveform appropriately, Autoset may change the vertical position. Autoset always sets vertical offset to 0 V.
- If you use Autoset when no channels are displayed, the instrument turns on channel 1 and scales it.
- If you use Autoset and the oscilloscope detects a video signal, the oscilloscope automatically sets the trigger type to video and makes other adjustments to display a stable video signal.

Acquisition Concepts

Before a signal can be displayed, it must pass through the input channel where it is scaled and digitized. Each channel has a dedicated input amplifier and digitizer. Each channel produces a stream of digital data from which the instrument extracts waveform records.

Sampling Process

Acquisition is the process of sampling an analog signal, converting it into digital data, and assembling it into a waveform record, which is then stored in acquisition memory.

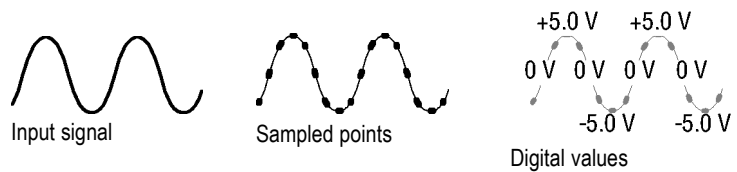

Real-Time Sampling

MDO3000 Series oscilloscopes use real-time sampling. In real-time sampling, the instrument digitizes all of the points it acquires using a single trigger event.

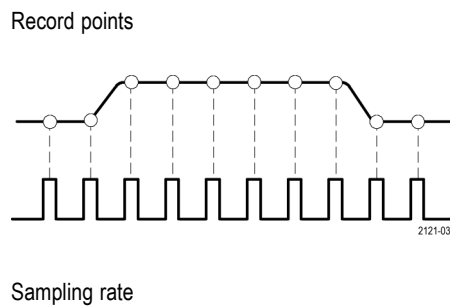

Waveform Record

The instrument builds the waveform record through use of the following parameters:

- **Sample interval:** The time between recorded sample points. Adjust this by turning the **Horizontal Scale** knob or pushing **Acquire** and changing the record length in the Acquire menu.
- **Record length:** The number of samples required to fill a waveform record. Set this by pushing the **Acquire** button and using the lower and side menus.
- **Trigger point:** The zero time reference in a waveform record. It is shown on the screen by an orange T.
- **Horizontal position:** When **Delay Mode** is on, this is the time from the trigger point to the expansion point. Adjust this by turning the **Horizontal Position** knob. Use a positive time to acquire the record after the trigger point. Use a negative time to acquire it before the trigger point.
- **Expansion point:** The point that the horizontal scale expands and contracts around. It is shown by an orange triangle.

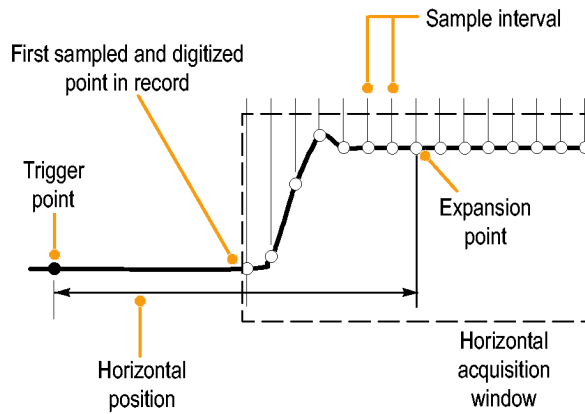

1785-109

Using FastAcq

FastAcq™ provides high-speed waveform capture. It is helpful in finding elusive signal anomalies. Fast acquisition mode reduces the dead time between waveform acquisitions, enabling the capture and display of transient events such as glitches and runt pulses. Fast acquisition mode can also display waveform phenomena at an intensity that reflects their rate of occurrence.

To use FastAcq:

1. Push **Acquire**.



2. Push **FastAcq**.

Mode Sample	Record Length 10k	FastAcq Off	Delay On Off	Set Horiz. Position to 10%	Waveform Display	XY Display Off
----------------	----------------------	----------------	-----------------	-------------------------------	------------------	-------------------



3. Toggle the **FastAcq** side-menu button to select **On**.

FastACq
Fast Acq On Off
Waveform Palette a Temperature



4. Push **Waveform Palette**.

5. Turn the **Multipurpose** a knob to select the desired display palette.

The display palette lets you enhance the visibility of events. This choice uses intensity grading to indicate how often rare transients occur relative to normal signals. The choices are Temperature, Spectral, Normal and Inverted.

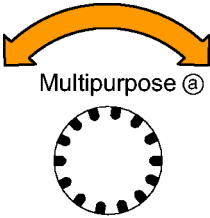

Temperature uses color-grading to indicate frequency of occurrence with hot colors like red/yellow indicating frequently occurring events and colder colors like blue/green indicating rarely occurring events.

Spectral uses color-grading to indicate frequency of occurrence with colder colors like blue indicating frequently occurring events and hot colors like red indicating rarely occurring events.

Normal uses the default channel color (like yellow for channel one) along with gray-scale to indicate frequency of occurrence where frequently occurring events are bright.

Inverted uses the default channel color along with gray scale to indicate frequency of occurrence where rarely occurring events are bright.

These color palettes help highlight the events that over time occur more often or, in the case of infrequent anomalies, occur less often.

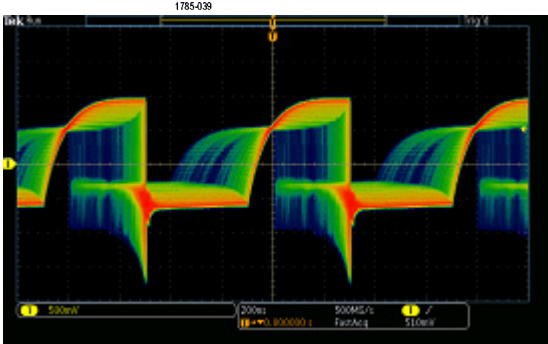

How the Analog Acquisition Modes Work

Sample mode retains the first sampled point from each acquisition interval. Sample is the default mode.

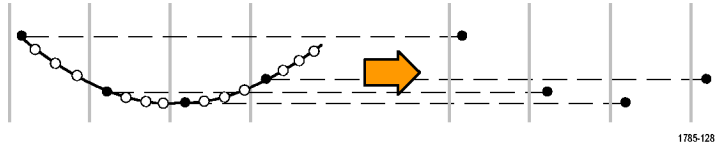

Peak Detect mode uses the highest and lowest of all the samples contained in two consecutive acquisition intervals. This mode only works with real-time, noninterpolated sampling and is useful for catching high frequency glitches.

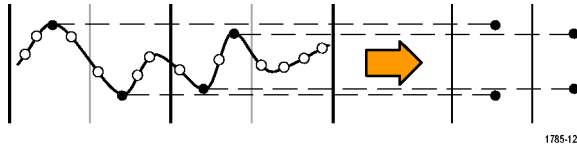

Hi Res mode calculates the average of all the samples for each acquisition interval. This mode also only works with real-time, noninterpolated sampling. Hi-Res provides a higher-resolution, lower-bandwidth waveform.

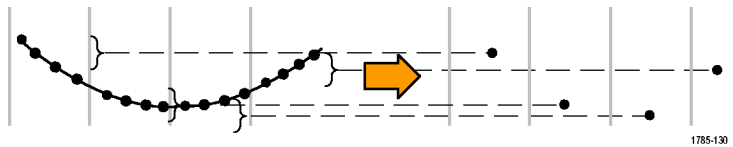

Envelope mode finds the highest and lowest record points over all acquisitions. Envelope uses Peak Detect for each individual acquisition.



Average mode calculates the average value for each record point over a user-specified number of acquisitions. Average uses Sample mode for each individual acquisition. Use average mode to reduce random noise.



Changing the Acquisition Mode, Record Length, and Delay Time

Use this procedure to change the acquisition mode.

1. Push **Acquire**.



2. Push **Mode**.

Mode Sample	Record Length 10k	FastAcq Off	Delay On Off	Set Horiz. Position to 10%	Waveform Display	XY Display Off
-----------------------	-----------------------------	-----------------------	------------------------	----------------------------------	---------------------	--------------------------



- Then choose the acquisition mode from the side menu. You can choose from: Sample, Peak Detect, Hi Res, Envelope, or Average.

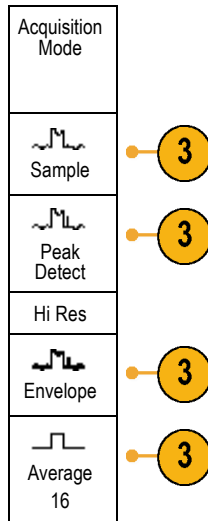

NOTE. Peak Detect and Hi Res modes take advantage of sample points that the oscilloscope would have discarded at lower sweep speeds. Therefore, these modes only work when the current sample rate is less than the maximum possible sample rate. As soon as the oscilloscope starts to acquire at the maximum sample rate, then the Peak Detect, Hi Res and Sample modes all look the same. You can control the sample rate by setting the Horizontal scale and the Record Length.

- If you chose **Average**, turn **Multipurpose a** to set the number of waveforms to average over.

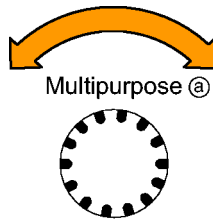

1785-039

- Push **Record Length**.
- Scroll through the available choices. Choose among 1000, 10 k, 100 k, 1 M, 5 M, and 10 M points.

7. Push **Delay** on the lower menu to select **On** when you want to delay the acquisition relative to the trigger event.

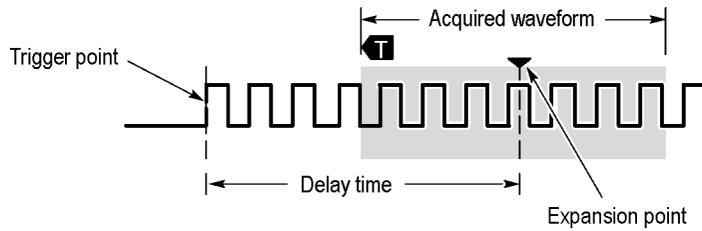

With **Delay** set to **On**, turn the **Horizontal Position** knob counterclockwise to increase the delay. The trigger point will move to the left and ultimately outside of the acquired waveform. Then you can adjust the **Horizontal Scale** knob to acquire more detail around the area of interest at the center of the screen.

When this delay is on, the trigger point separates from the horizontal expansion point. The horizontal expansion point stays at the center of the screen. The trigger point can move off the screen. When this happens, the trigger marker turns to point in the direction of the trigger point.

Use the delay feature when you want to acquire waveform detail that is separated from the trigger event by a significant interval of time. For example, you can trigger on a sync pulse that occurs once every 10 ms and then look at high-speed signal characteristics that occur 6 ms after the sync pulse.

When the delay feature is set to **Off**, the expansion point is tied to the trigger point so that scale changes are centered around the trigger point.

Using Roll Mode

Roll mode gives a display similar to a strip chart recorder for low-frequency signals. Roll mode lets you see acquired data points without waiting for the acquisition of a complete waveform record.

Roll mode is enabled when the trigger mode is auto and the horizontal scale is set to 40 ms/div or slower.

Quick Tips

- Switching to Envelope or Average acquisition mode, using digital channels, using math waveforms, turning on a bus, or switching to Normal trigger will disable Roll mode.
- Roll mode is disabled when you set the horizontal scale to 40 ms per division or faster.
- Push **Run/Stop** to halt Roll mode.



Act on Event

Tell the oscilloscope to perform a defined action after a defined event has occurred. The event can be a trigger or a certain number of acquisitions. The action can be to:

- Stop acquisitions
- Save a waveform or a screen image to a file
- Print
- Send a pulse out the AUX OUT port
- Generate a remote interface SRQ
- Send an e-mail notification
- Display a message on the oscilloscope display

1. Push **Test**.



2. Push **Application** on the lower-menu.

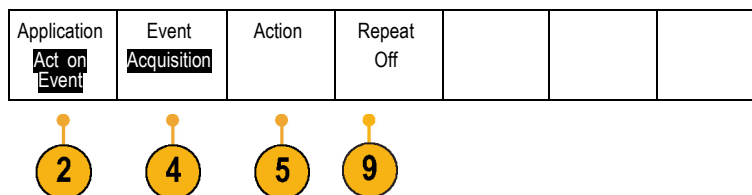

3. Turn **Multipurpose a** to select **Act on Event**

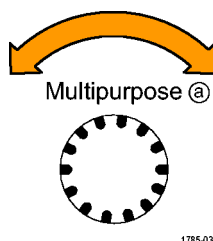



4. Push **Event** on the lower menu.

This brings up the event type side menu.
Select the desired event type.

Event Type
None
Trigger
Acquisitions (a) 10

5. Push **Actions** on the lower menu.
This brings up the Actions side menu. Use the menu to select an action to occur on the event.

6. Select the action type from the resulting pop-out menu.

Actions	
Select Actions (a) Stop Acq	
Enable Action <input checked="" type="checkbox"/> On <input type="checkbox"/> Off	
Configure E-mail	

7. Select whether or not to enable the action.

8. If you selected **E-mail Notification** from the list of actions above, you can now select **Configure E-mail** from the side menu to define the parameters of the e-mail.

NOTE. There is a single set of SMTP server settings saved for both **Act on Event** e-mail notification and for the e-mail printer (set through the **Utility > Print Setup > Select Printer > Add E-mail Printer** menus). If you modify the SMTP settings in one of these two locations, they will be similarly modified in the other location.

9. Push **Repeat.** from the lower menu.
This lets you set how many times to repeat the selected event and resulting action.

Setting Up a Serial or Parallel Bus

Your oscilloscope can decode and trigger on signal events or conditions that occur on:

Bus type	With this hardware
Audio (I ² S, Left Justified (LJ), Right Justified (RJ), and TDM)	MDO3AUDIO application module
CAN, CAN FD, and LIN	MDO3AUTO application module
FlexRay	MDO3FLEX application module
I ² C and SPI	MDO3EMBD application module
ARINC429 and MIL-STD-1553	MDO3AERO application module
Parallel	MDO3000 Series oscilloscope with the MDO3MSO option
RS-232, RS-422, RS-485, and UART	MDO3COMP application module
USB 2.0	MDO3USB application module

NOTE. 1 GHz bandwidth models are required for high-speed (HS) USB.

(See page 14, *Application Module Free Trial.*)

Using Buses in Two Steps

To quickly use serial bus triggering:

1. Push **B1** or **B2** and enter parameters of the bus on which to trigger.
You can separately assign a different bus to each of the **B1** and **B2** buttons.



2. Push **Trigger Menu** and enter trigger parameters. (See page 92, *Choosing a Trigger Type*.)

You can display bus information without triggering on the bus signal.

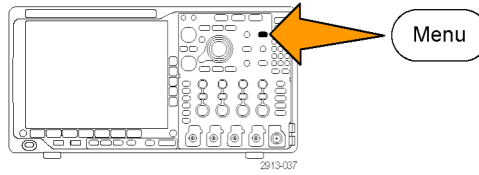

Setting Up Bus Parameters

NOTE. For most bus sources, you may use any combination of channels 1 through 4, and D15 through D0. With some buses, you may also use Ref 1 through 4 and Math as sources for protocol decode.

To trigger on serial or parallel bus conditions, refer to *Triggering on Buses*. (See page 95, *Triggering on Buses*.)

To set up bus parameters:

1. Push **B1** or **B2** to bring up the lower bus menu.



2. Push **Bus**. Turn **Multipurpose a** to scroll through the list of bus types and select the desired bus: Parallel, ARINC429, I²C, SPI, RS-232, CAN, LIN, FlexRay, Audio, USB, or MIL-STD-1553.

The actual menu items shown will depend on your model oscilloscope and the application modules installed.

Bus B1 Parallel	Define Inputs	Thresholds		B1 Label Parallel	Bus Display	Event Table
--------------------	------------------	------------	--	----------------------	----------------	----------------



3. Push **Define Inputs**. The choices depend on the selected bus.

Use the side menu buttons to define parameters for the inputs, such as specific signals to an analog or digital channel.

If you select **Parallel**, push the side menu button to enable or disable **Clocked Data**.

Push the side menu button to select the **Clock Edge** on which to clock data: rising edge, falling edge, or both edges.

Turn **Multipurpose a** to select the **Number of Data Bits** in the parallel bus.

Turn **Multipurpose a** to select the desired bit to define.

Turn **Multipurpose b** to select the desired analog or digital channel as the source for the bit.

Define Inputs
Clocked Data Yes No
Clock Edge 
Number of Data Bits (a) 16
Define Bits (a) Bit 15 (b) D15

4. Push Thresholds.

You can set the threshold for all channels in the parallel or serial bus from a list of preset values. The preset values vary, depending on the bus type.

Alternatively, you can set the threshold to a specific value for the signals that make up the parallel or serial bus. To do so, push **Select** on the side menu and turn **Multipurpose a** to select a Bit or a Channel number (Signal name).

Then, turn **Multipurpose b** to define the voltage level above which the oscilloscope treats the signal as a logic high and below which as a logic low.

NOTE. Some buses use two thresholds per channel.

Bus B1 Parallel	Define Inputs	Thresholds		B1 Label Parallel	Bus Display	Event Table
---------------------------	---------------	------------	--	----------------------	-------------	-------------



2319-045



2319-046

5. Optionally, push **B1 Label** to edit the label for the bus. (See page 55, *Labeling Channels and Buses*.)

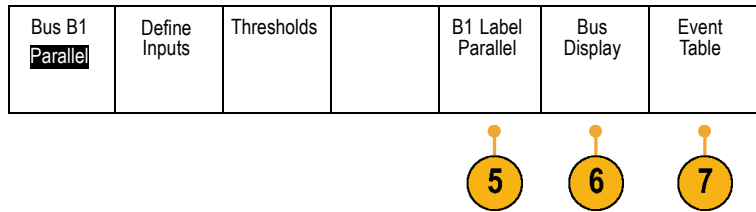

6. Push **Bus Display** and use the side menu to define how to display the parallel or serial bus.

Depending on the bus, use the side menu or the knobs to set the number format.

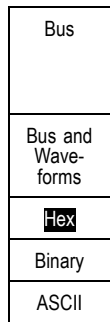

7. Push **Event Table** and select **On** to display a list of bus packets with timestamps.

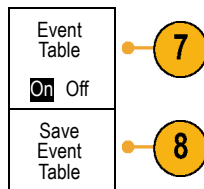

For a clocked parallel bus, the table lists the value of the bus at each clock edge. For an unclocked parallel bus, the table lists the value of the bus whenever any one of its bits changes.

The Event Table lists bytes, words, or packets, depending on the bus type.

(See page 80, *Event Table* .)

8. Push **Save Event Table** to save the event table data in a .csv (spreadsheet) format on the currently selected storage device.

This example of an Event Table is from an RS-232 bus.

RS-232 event tables display one line for each 7- or 8-bit byte when Packets are set to Off. RS-232 event tables display one line for each packet when Packets are set to On. Other buses display one word, frame, or packet per row, depending on the bus type.

Tektronix version v1.2f		
Bus Definition: RS232		
Time	Tx	Rx
-4.77E-02	E	
-4.44E-02	n	
-4.10E-02	g	
-3.75E-02	i	
-3.41E-02	n	
-3.08E-02	e	
-2.73E-02	e	
-2.39E-02	r	
-2.06E-02	i	
-1.71E-02	n	
-1.37E-02	g	
-1.03E-02	.	
-6.92E-03	SP	
-3.49E-03	P	
-5.38E-05	o	
3.28E-03	r	
6.71E-03	t	
1.69E-02	l	
2.02E-02	a	
2.43E-02	n	
2.82E-02	d	
3.16E-02		

9. Push **B1** or **B2** and turn **Multipurpose a** to move the bus display up or down on the screen.

(See page 80, *Event Table* .)

ARINC429 Bus

To acquire data from an ARINC429 bus, you need to setup these items:

1. If you selected **ARINC429**, push **Define Inputs** and the appropriate side menu choices.

Bus B1 AR- INC429	Define Inputs	Thresh- olds 800mV 0.00 V	Configure	B1 Label AR- INC429	Bus Display	Event Table
-------------------------	---------------	------------------------------------	-----------	---------------------------	-------------	-------------



2. Turn **Multipurpose a** to select the waveform under analysis as the bus input.

Define Input (a) 1



3. Push either **Polarity Normal** or **Polarity Inverted** to match the ARINC429 bus being acquired

Polarity Normal
Polarity Inverted



4. Push **Thresholds** to configure the high and low thresholds for the ARINC429 bus being acquired or select from available presets.
5. Push **Configure** and select the appropriate side menu choices.

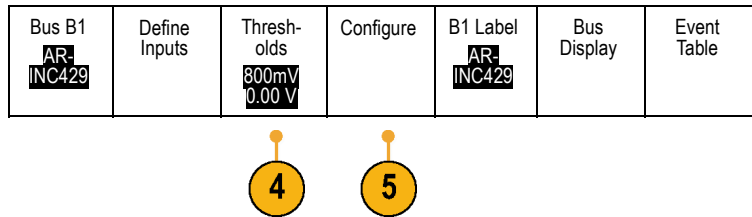

6. Push **Bit Rate**, and turn **Multipurpose a** to select from the list of predefined bit rates. Alternatively, you can set the bit rate to a specific value. To do so, select Custom, and then turn **Multipurpose b** to set the bit rate from 10 kbps to 1 Mbps

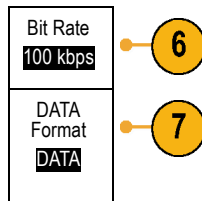

7. Push **DATA format**, and turn **Multipurpose a** to select from the size of the data field for packets being decoded on the ARINC429 bus.

I²C Bus

To acquire data from an I²C bus, you need to also set up these items:

1. If you select **I²C**, push **Define Inputs** and the appropriate side menu choices.

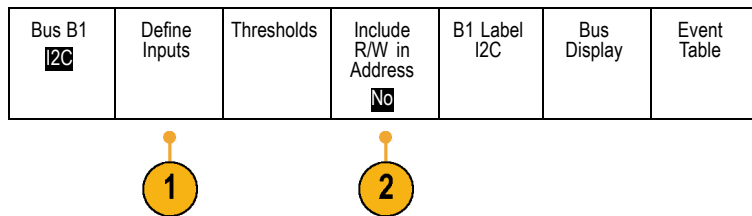

You can assign the predefined **SCLK Input** or **SDA Input** to the channel connected to the signal.

2. Push **Include R/W in Address** and then push the desired side button.
This control determines how the oscilloscope shows the I²C addresses in bus decode traces, cursor readouts, Event Table listings, and trigger settings.

If you select **Yes**, the oscilloscope displays 7-bit addresses as eight bits, where the eighth bit (LSB) is the R/W bit. It displays 10-bit addresses as 11 bits where the third bit is the R/W bit.

If you select **No**, the oscilloscope displays 7-bit addresses as seven bits, and 10-bit addresses as ten bits.

In the physical layer of the I²C protocol, 10 bit I²C addresses are preceded by the five bit code, 11110. The oscilloscope does not include these five bits in address readouts.

SPI Bus

To acquire data from an SPI bus, you need to also set up these items:

1. If you selected **SPI**, push **Define Inputs** and the appropriate side menu choices.

You can set the **Framing** to SS (Slave Select) or to Idle Time.

You can assign the predefined **SCLK**, **SS**, **MOSI**, or **MISO** signals to any channel.

Bus B1 SPI	Define Inputs	Thresholds	Configure	B1 Label SPI	Bus Display	Event Table
---------------	---------------	------------	-----------	-----------------	-------------	-------------



2. Push **Configure** and the desired side menu choices.

3. Push **SCLK** to set the edge of the signal to match the SPI bus being acquired.



4. Set the level of the SS, MOSI, and MISO signals to match the SPI bus.

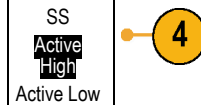

Active High means that a signal is considered active when the signal is greater than the threshold value.

Active Low means that the signal is considered active when the signal is lower than the threshold value.

SCLK	
SS	Active High Active Low
MOSI	Active High Active Low
MISO	Active High Active Low
-more-	1 Of 2

5. Use **Multipurpose a** to set the number of bits of the SPI Word Size.



6. Push either side menu button to set the bit order of the SPI bus.

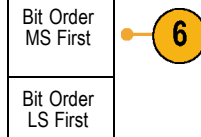

RS-232 Bus

To acquire data from a RS-232 bus, you need to also set up these items:

1. If you selected **RS-232**, push **Configure** and the desired side menu choices.

Bus B1 RS-232	Define Inputs	Thresholds	Configure 9600-8-N	B1 Label RS-232	Bus Display	Event Table
------------------	---------------	------------	-----------------------	--------------------	-------------	-------------

Use the side menu to configure the bus.
Use Normal polarity for RS-232 signals and Inverted polarity for RS-422, RS-485, and UART buses.



2. Push **Bit Rate**, and turn **Multipurpose a** to select the appropriate bit rate.
3. Push **Data Bits** and select the number to match the bus.
4. Push **Parity** and turn **Multipurpose a** to match the polarity used by the bus as None, Odd, or Even.
5. Push **Packets** and select On or Off.
6. Turn **Multipurpose a** to select an end-of-packet character.

Bit Rate 9600 bps	2
Data Bits 7 8	3
Parity (a) None	4
Packets On Off	5
End of Packet 0A (Linefeed)	6

RS-232 decoding displays a stream of bytes.
You can organize the stream into packets with an end-of-packet character

If you defined an end-of-packet character to use for RS-232 decoding, the stream of bytes will be displayed as packets.

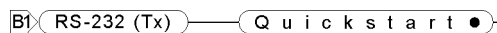

2121-233

When decoding an RS-232 bus in ASCII mode, a large dot indicates that the value represents a character outside the printable ASCII range.



2121-232

CAN, CAN FD BUS

To acquire data from a CAN or CAN FD bus, you need to set up these items:

1. If you selected **CAN**, push **Define Inputs** and the appropriate side menu choices.

Bus B1 CAN	Define Inputs	Thresh-olds	Configure 500 Kbps	B1 Label CAN	Bus Display	Event Table
----------------------	---------------	-------------	------------------------------	-----------------	-------------	-------------



2. Turn **Multipurpose a** to select the channel connected to the CAN bus source.
3. Turn **Multipurpose a** to select the type of CAN signal: CAN_H, CAN_L, Rx, Tx, or Differential.

CAN Input (a) 1	2
Signal Type CAN_H	3
Sample Point 50%	4

4. Turn **Multipurpose a** to set the **Sample Point** to a percentage of the position within the bit period or the unit interval.

For a CAN 2.0 bus the allowable sample point range is 5% to 95%.

For a CAN FD bus the allowable sample point range is 15% to 95%.

NOTE. CAN FD requires an accurately specified sample point for correct decode and triggering..

NOTE. CAN FD uses the same sample point percentage for bits transmitted at SD bit rates and FD bit rates. For optimal performance, set the sample point to the value used for SD bits (the "Arbitration Phase" sample point).

5. Push **Configure** and select the appropriate side menu choices..

Bus B1 CAN	Define Inputs	Thresh-olds	Configure 500 Kbps 4 Mbps	B1 Label CAN	Bus Display	Event Table
----------------------	---------------	-------------	---	-----------------	-------------	-------------



- Push **Standard** to select between CAN 2.0 and CAN FD decode/trigger standards.
While CAN FD is backwards compatible with CAN 2.0 packets, CAN 2.0 should be selected for best performance with non CAN FD bus configurations.

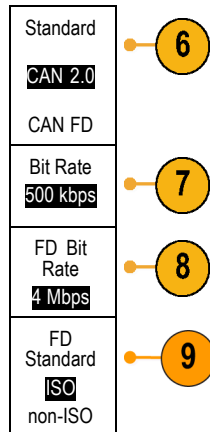

- Push **Bit Rate**, and turn **Multipurpose a** to select from the list of predefined bit rates.
Alternatively, you can set the bit rate to a specific value. To do so, select Custom, and then turn **Multipurpose b** to set the bit rate from 10 kbps to 1 Mbps.
When Standard is set to CAN FD, this will be the SD bit rate.
- If Standard is set to CAN FD, push **FD Bit Rate**, and turn **Multipurpose a** to select from the list of predefined bit rates.
Alternatively, you can set the bit rate to a specific value. To do so, select Custom, and then turn **Multipurpose b** to set the bit rate from 500 kbps to 7 Mbps for the MDO3000.
- If Standard is set to CAN FD, push **FD Standard** to select between ISO (11898-1:2015) and non-ISO (Bosch:2012) protocol standards.

LIN Bus

To acquire data from a LIN bus, you need to also set up these items:

1. If you selected **LIN**, push **Define Inputs** and the appropriate side menu choices.

Bus B1 LIN	Define Inputs	Thresholds	Configure	B1 Label LIN	Bus Display	Event Table
----------------------	---------------	------------	-----------	------------------------	-------------	-------------



2. Turn **Multipurpose a** to select the channel connected to the LIN bus source.
3. Turn **Multipurpose a** to set the **Sample Point** from 5% to 95% of the position within the bit period or the unit interval.
4. Select the **Polarity** to match the LIN bus being acquired.

LIN Input (a) 1
Sample Point 50%
Polarity Normal (High=1)
Polarity Inverted (High=0)



5. Push **Configure** and the appropriate side menu choices.

Bus B1 LIN	Define Inputs	Thresholds	Configure	B1 Label LIN	Bus Display	Event Table
----------------------	---------------	------------	-----------	------------------------	-------------	-------------



6. Push **Bit Rate**, and turn **Multipurpose a** to select from the list of predefined bit rates. Alternatively, you can set the bit rate to a specific value. To do so, select **Custom**, and then turn **Multipurpose b** to set the bit rate from 800 bps to 100,000 bps.
7. Push **LIN Standard**, and turn **Multipurpose a** to select the appropriate standard.
8. Push **Include Parity Bits with Id** to select whether or not to include parity bits.

Bit Rate (a) 19.2K bps
LIN Standard v1.x
Include Parity Bits with Id On Off



FlexRay Bus

To acquire data from a FlexRay bus, you need to also set up these items:

1. If you selected **FlexRay**, push **Define Inputs** and the desired side menu choices.
2. As appropriate, push the Threshold, Bit Rate, Label, Bus Display and Event Table buttons and set their corresponding parameter values.

Bus B1 FlexRay	Define Inputs	Thresholds	Bit Rate	B1 Label FlexRay	Bus Display	Event Table
-------------------	---------------	------------	----------	---------------------	-------------	-------------



Audio Bus

To acquire data from an Audio bus, you need to also set up these items:

1. If you selected **Audio**, push **Define Inputs** and the desired side menu choices.

Bus B1 Audio	Define Inputs	Thresholds	Configure	B1 Label RS-232	Bus Display	Event Table
-----------------	---------------	------------	-----------	--------------------	-------------	-------------



2. Push **Type**, and turn **Multipurpose a** to select the type of audio bus data configuration on which to trigger.
3. Select **I2S** to trigger on the standard Inter-IC Sound, or Integrated Interchip Sound, electrical serial bus interface standard stereo format.
4. Select **Left Justified** to trigger on an I2S stream where there is no bit clock delay and the data starts right on the edge of the word select clock.
5. Select **Right Justified** to trigger on an I2S stream where the data lines up with the right edge of the word select clock.
6. Select **TDM** to trigger on time-division multiplexing.

Audio Bus Type
I2S
Left Justified (LJ)
Right Justified (RJ)
TDM

7. Push **Configure**, and the appropriate buttons on the side menu to further set up I2S triggering.

USB Bus

To acquire data from a USB bus, you need to also set up these items:

1. If you selected **USB**, push **Define Inputs** to set the USB bus speed and probe type.

Bus B1 USB	Define Inputs Full Speed	Thresholds		B1 Label USB	Bus Display	Event Table
----------------------	------------------------------------	------------	--	------------------------	-------------	-------------



2. The Thresholds, Label, Bus Display, and Event Table menus operate similarly to the other serial buses.

NOTE. 1 GHz bandwidth models are required for high-speed (HS) USB.

MIL-STD 1553

To acquire data from a MIL-STD 1553 bus, you need to also set up these items:

Bus B1 MIL-1553	Define Inputs	Thresholds 800 mV 0.00 V	RT 12.0µS 4.00µS	B1 Label 1553	Bus Display	Event Table
---------------------------	---------------	--	--------------------------------------	-------------------------	-------------	-------------



1. Push **Define Inputs** and turn **Multipurpose a** to select the desired side menu choices. Select the polarity desired to match the MIL-STD-1553 bus being acquired.
2. The **Thresholds**, **Label**, **Bus Display**, and **Event Table** menu items operate similarly to how they work on other serial bus menus.
3. Push **RT** if you wish to change the Response Time (RT) maximum and minimum default values.

Physical Layer Bus Activity

Oscilloscope waveform traces from analog channels 1 to 4, digital channels D15 to D0, Math waveforms, and the traces you see when you choose to display a bus always show the physical layer bus activity. In the physical layer display, bits that were transmitted earlier are to the left, and bits that were transmitted later are to the right.

- I²C, and CAN and CAN FD buses transmit the MSB (most significant bit) first
- SPI buses do not specify a bit order
- RS-232 and LIN buses transmit the LSB (least significant bit) first

NOTE. *The oscilloscope displays the decode traces and event tables for all buses with the MSB on the left and LSB on the right.*

For example, an RS-232 signal (after the start bit) might be high, high, high, low, high, low, low, and high. Since the RS-232 protocol uses high for zero and low for one, this value would be 0001 0110.

Since the decode displays the MSB first, the oscilloscope reverses the order of the bits and displays 0110 1000. If the bus display is set to hex, the value displays as 68. If the bus display is set to ASCII, the value displays as h.

Event Table

In addition to seeing decoded packet data on the bus waveform itself, you can view all captured packets in a tabular view much like you would see in a software listing. Packets are time stamped and listed consecutively with columns for each component (Address, Data, etc.). You can save the event table data in .CSV format for detailed offline analysis. Using the Event Table, you can:

- Scroll the event table to update the view point in the waveform.

Each row in the event table represents a time-stamped byte, packet, or word, depending on the bus type. As you scroll the event table using the multipurpose knob, the view point in the oscilloscope display updates to show the position in the waveform corresponding to the event in the Event Table.

- Save the event table. (See page 68, *Setting Up Bus Parameters*.)

Saving an event table may save more data than can be presented on the oscilloscope. Use these saved files for in-depth offline analysis.

Setting Up Digital Channels

Use front panel buttons and knobs to set up your instrument to acquire signals using the digital channels.

- 1. Connect the P6316 16-channel logic probe to the input signal source.

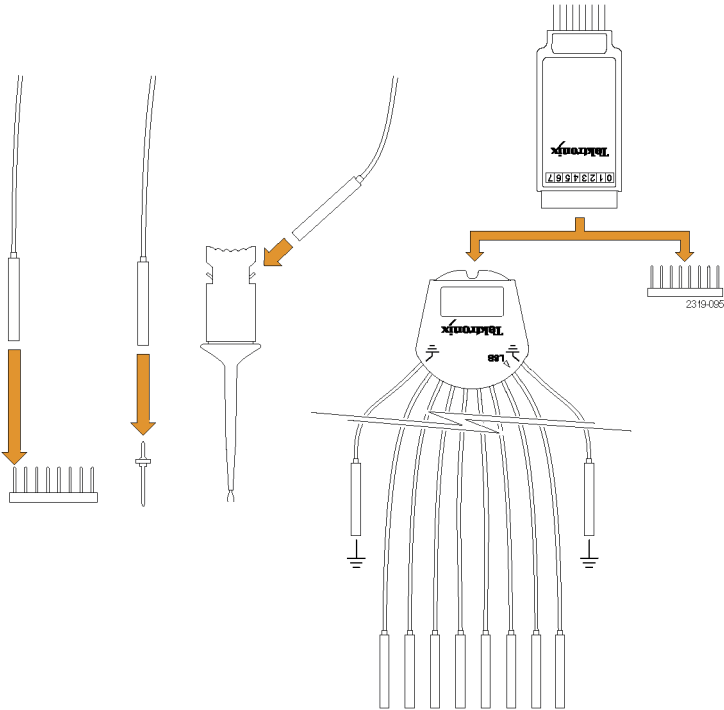

- 2. Connect the ground lead or leads to the circuit ground.
You can connect a separate lead for each channel or a common ground lead for each group of 8 wires.
- 3. If needed, connect the appropriate grabber for each probe to the probe tip.
- 4. Connect each probe to the desired circuit test point.
- 5. Push **D15 - D0** on the front panel to display the menu.



- 6. Push **D15 - D0** on the lower menu to access the D15 - D0 On or Off menu.

D15 - D0 On/Off	Thresholds	Edit Labels		Monitor On <input type="checkbox"/> Off	MagniVu On <input type="checkbox"/> Off	Height S M L
6	8	9		10	11	12

- Turn **Multipurpose a** to scroll through the list of digital channels. Turn **Multipurpose b** to position the selected channel.

As you position channels close to each other on the display, the oscilloscope groups the channels, and adds the group to the pop-up list. You can select the group from the list to move all the channels in the group instead of individual channels.

- Push **Thresholds** on the lower menu. You can assign a different threshold value to each channel.
- Push **Edit Labels** on the lower menu and create the label. You can create labels through the front panel or with an optional USB keyboard. (See page 55, *Labeling Channels and Buses.*)
- Push **Monitor** to show the activity on digital channels at a glance.

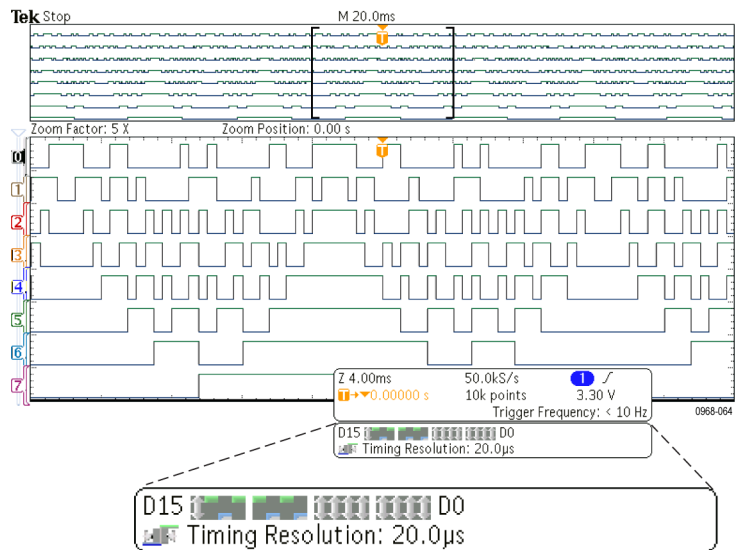

- Push **MagniVu** on the lower menu to increase the timing resolution. (See page 83, *When and Why to Turn On MagniVu.*)

12. Push **Height** on the lower menu repeatedly to set the signal height. You only need to do this once to set the height for all of the digital channels.

Quick Tip

- Use the zoom feature to see multiple cycles of the signal in the upper part, and a single cycle in the lower part of the display. (See page 149, *Using Wave Inspector to Manage Long Record Length Waveforms.*)
- When setting up the logic probe, the first set of eight leads (pins 7 to 0) on the logic probe are marked GROUP 1 on the lead box. The second set (pins 15 to 8) is marked GROUP 2.
- Digital channels store a high or low state for each sample. The threshold that separates high from low can be set for each set of eight channels.

When and Why to Turn On MagniVu

Tektronix MagniVu acquisition technology allows you to have higher timing resolution so that you can more accurately determine edge placement and make more precise timing measurements on digital edges. Using MagniVu, you can see up to 16 times more detail than you can using normal digital channel sampling.

The MagniVu record is acquired in parallel to the main digital acquisition and is available at any time, running or stopped. MagniVu provides an ultra high resolution view of your data sampled at a maximum resolution of 121.2 ps for 10,000 points centered around the trigger.

NOTE. *MagniVu centers itself around the trigger point. If you turn MagniVu on while using a large record length and you are looking somewhere other than the trigger point, then the digital signal may be off screen. In most of these cases, you can find the digital record by looking for the digital signal in the upper overview and panning accordingly.*

NOTE. *You should turn on MagniVu when light gray shading is displayed to indicate the uncertainty of the edge position. If the shading is not displayed, you do not need to use MagniVu. (See page 115, *Viewing Digital Channels.*)*

Using MagniVu

1. Push **D15 – D0**.



2. Push **MagniVu** and select **On**.

D15 – D0 On/Off	Thresholds	Label		Monitor On <input type="checkbox"/> Off <input checked="" type="checkbox"/>	MagniVu On <input type="checkbox"/> Off <input checked="" type="checkbox"/>	Height S M L
--------------------	------------	-------	--	--	--	-----------------

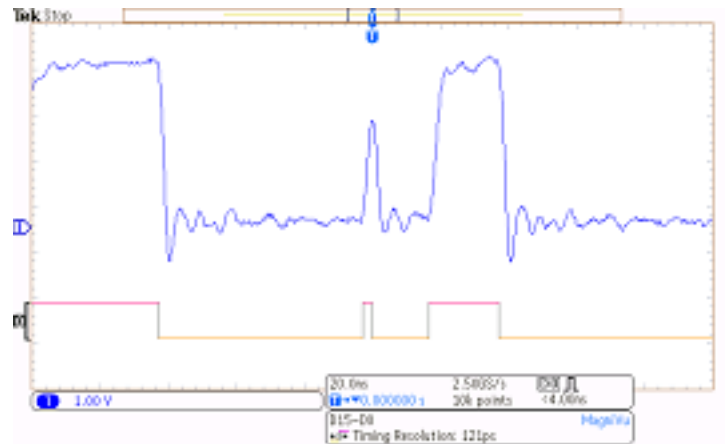

Quick Tips

- If you think you need more timing resolution, turn on MagniVu to increase the resolution.
- MagniVu is always acquired. If the oscilloscope is in a stopped state, you can turn on MagniVu and still get the resolution without taking another acquisition.
- The serial bus features do not use data acquired in MagniVu mode.

Setting Up the RF Inputs

Frequency and Span Parameters

1. The center frequency is a precise frequency at the center of the display. In many applications, it is a carrier frequency.
2. The span is the range of frequencies you can observe around the center frequency.

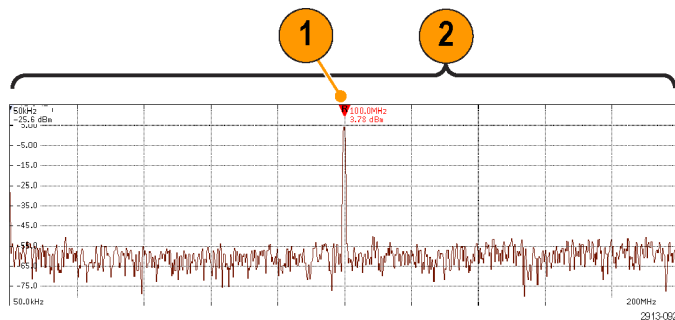

To define the center frequency and the span:

1. Push **Freq/Span** on the front panel.



- 2. Push **Center Frequency** on the side menu and use either the **Multipurpose a** knob or the oscilloscope keypad to enter the desired center frequency. If you use the keypad, you can also use the resulting side menu choices to enter units.
- 3. Push **Span** and use either the **Multipurpose b** knob or the keypad to enter the desired span. If you use the keypad, you can also use the resulting side menu choices to enter units.
- 4. Push **Start** to set the lowest frequency to capture.
- 5. Push **Stop** to set the highest frequency to capture.
- 6. Push ** To Center** to move the frequency identified by the reference marker to the center frequency.

Frequency & Span
Center Frequency (a) 2.24 GHz
Span (b) 3.00 GHz
Start 7.36 MHz
Stop 3.74 GHz
 To Center

Reference Level

- 1. Push **Ampl** to bring up the side menu for adjusting RF amplitude settings.



2. Push **Ref Level** and turn **Multipurpose a** to set the approximate maximum power level, as shown by the baseline indicator at the top of the frequency graticule.
3. Push **Vertical** and turn **Multipurpose a** to adjust the vertical position. You will move the baseline indicator up or down. This is useful if you want to move signals onto the visible display.
Turn **Multipurpose b** to adjust the vertical scale.
4. Push **Vertical Units** and turn **Multipurpose a** to define the vertical units of measure for the frequency domain. Choices are: dBm, dBμW, dBmV, dBμV, dBmA, and dBμA. This is useful if your application requires a different unit of measurement than that being currently displayed.
5. Push **Auto Level** to direct the oscilloscope to automatically calculate and set the reference level for you.

Amplitude
Ref Level (a) -25.0 dBm
Vertical 420 mdiv 20.0 dB/div
Vertical Units dBm
Auto Level

Resolution Bandwidth

The resolution bandwidth (RBW) determines the level to which the oscilloscope can resolve individual frequencies in the frequency domain. For example, if the test signal contains two carriers separated by 1 kHz, you will not be able to discriminate between them unless the RBW is less than 1 kHz.

The views below both show the same signal. The difference between them is their RBW.

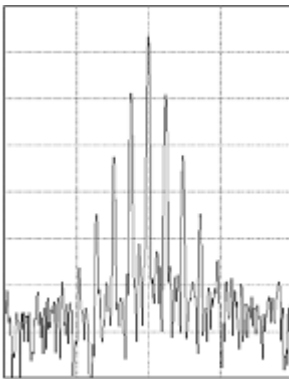

Lower (narrower) RBWs take longer to process, but have finer frequency resolution and a lower noise floor.

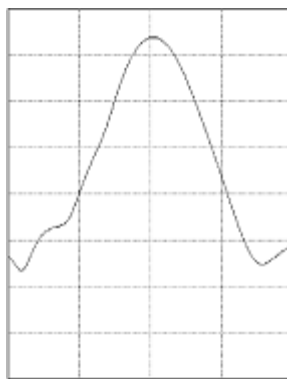

Higher (wider) RBWs take less time to process, but have less frequency resolution and a higher noise floor.

1. Push **BW** to bring up the resolution bandwidth side menu. This allows you to set the smallest frequency difference that the instrument can discern in the frequency axis.



2. Push **RBW Mode** to select either **Auto** or **Manual**.
Auto sets the resolution bandwidth automatically as you change the span. The default behavior is $RBW = \text{Span}/1000$.
Manual allows you to set your own resolution bandwidth.
3. To manually adjust the RBW, push **RBW** and turn **Multipurpose a**.
4. Push **Span : RBW** and turn **Multipurpose a** to set the span/RBW ratio.
 This ratio is used when the **RBW Mode** is set to **Auto**. The default is 1000:1 but you can set it to other values in a 1-2-5 sequence (e.g. 1000, 20000, 50000).
5. Push **Window** and turn **Multipurpose a** to choose which FFT window type to use.
 The choices are: Kaiser, Rectangular, Hamming, Hanning, Blackman-Harris, or Flat-Top.

Bandwidth
RBW Mode Auto Manual
RBW (a) 600 kHz (Auto)
Span : RBW 1000 : 1
Window Kaiser

The RF bandwidth FFT feature provides six windows. Each offers a trade-off between frequency resolution and magnitude accuracy. The choice of which window to use depends upon what you want to measure and your source's signal characteristics. Use the following guidelines to select the best window:

Description

Window

Kaiser

The frequency resolution when using the Kaiser window is fair; the spectral leakage and amplitude accuracy are both good.

The Kaiser window is best used when frequencies are very close to the same value but have widely differing amplitudes (the side lobe level and shape factor are closest to the traditional Gaussian RBW). This window is also good for random signals.



Rectangular

The frequency resolution when using the Rectangular (a.k.a. boxcar or none) window is very good, the spectral leakage is high, and amplitude accuracy is poor.

Use the Rectangular window for measuring transients or bursts where the signal levels before and after the event are nearly equal. Also, use this window for equal-amplitude sine waves with frequencies that are very close together, and for broadband random noise with a relatively slow varying spectrum. This window is the best type for measuring the frequency spectrum of non-repetitive signals, and measuring frequency components near DC.



Hamming

The frequency resolution when using the Hamming window is good (slightly better than Hanning), the spectral leakage is moderate, and amplitude accuracy is fair.

Use the Hamming window for measuring sine, periodic, and narrow band random noise. This window works well on transients or bursts where the signal levels before and after the event are significantly different.



Hanning

The frequency resolution when using the Hanning (a.k.a. Hann) window is good, the spectral leakage is low and amplitude accuracy is fair.

Use the Hanning window for measuring sine, periodic, and narrow band random noise. This window works well on transients or bursts where the signal levels before and after the event are significantly different.



Blackman-Harris

The frequency resolution when using the Blackman-Harris window is poor, the spectral leakage is very low and amplitude accuracy is good.

Use the Blackman-Harris window for measuring predominantly single frequency waveforms to look for higher order harmonics, or several moderately or widely spaced sinusoidal signals.



Flat-Top

The frequency resolution when using a Flat-Top window is poor, the spectral leakage is low and amplitude accuracy is very good.

Use the Flat-Top window for making accurate amplitude measurements of moderately or widely spaced sinusoidal signals.

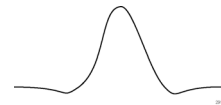

Trigger Setup

This section contains concepts and procedures for setting up the oscilloscope to trigger on your signal.

Triggering Concepts

Trigger Event

The trigger event establishes the time-reference point in the waveform record. All waveform record data is located in time with respect to that point. The instrument continuously acquires and retains enough sample points to fill the pretrigger portion of the waveform record. That is the part of the waveform that is displayed before, or to the left of, the triggering event on screen. When a trigger event occurs, the instrument starts acquiring samples to build the posttrigger portion of the waveform record, that is, the part displayed after or to the right of the trigger event. After a trigger is recognized, the instrument will not accept another trigger until the acquisition is complete and the holdoff time has expired.

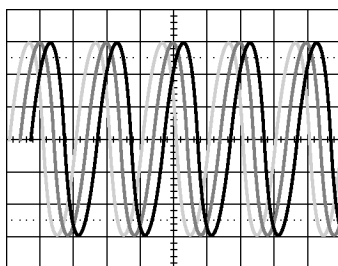

1785-087a

Untriggered display

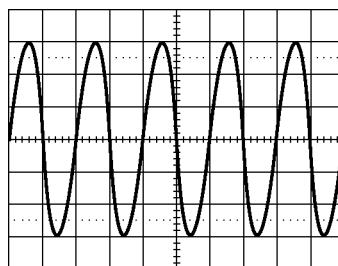

1785-087b

Triggered display

Trigger Modes

The trigger mode determines how the instrument behaves in the absence of a trigger event:

- Normal trigger mode enables the instrument to acquire a waveform only when it is triggered. If no trigger occurs, the last waveform record acquired remains on the display. If no last waveform exists, no waveform is displayed.
- Auto trigger mode enables the instrument to acquire a waveform even if a trigger does not occur. Auto mode uses a timer that starts when the acquisition is started, and the pretrigger information is obtained. If a trigger event is not detected before the timer times out, the instrument forces a trigger. The length of time it waits for a trigger event depends on the time base setting.

Auto mode, when forcing triggers in the absence of valid triggering events, does not synchronize the waveform on the display. The waveform will appear to roll across the screen. If valid triggers occur, the display will become stable.

You can also force the instrument to trigger by pushing the front panel **Force Trig** button.

Trigger Holdoff

Adjust holdoff to obtain stable triggering when the instrument is triggering on undesired trigger events.

Trigger holdoff can help stabilize triggering, since the oscilloscope does not recognize new triggers during the holdoff time. When the instrument recognizes a trigger event, it disables the trigger system until acquisition is complete. In addition, the trigger system remains disabled during the holdoff period that follows each acquisition.

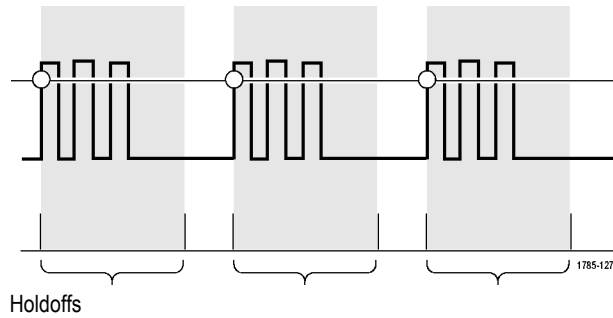

Trigger Coupling

Trigger coupling determines what part of the signal is passed to the trigger circuit. Edge and Sequence triggering can use all available coupling types: DC, AC, Low Frequency Rejection, High Frequency Rejection, and Noise Rejection. All other trigger types use DC coupling only.

Horizontal Position

When **Delay Mode** is on, use horizontal position to acquire waveform detail in a region that is separated from the trigger location by a significant interval of time.

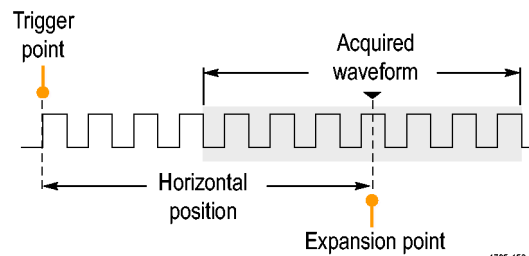

1. Adjust the position (delay) time by rotating the **Horizontal Position** knob.
2. Turn horizontal **SCALE** to acquire the detail that you need around the position (delay) expansion point.

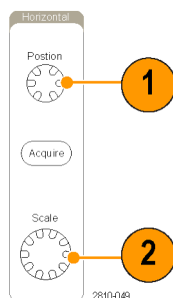

The part of the record that occurs before the trigger is the pretrigger portion. The part that occurs after the trigger is the posttrigger portion. Pretrigger data can help you troubleshoot. For example, to find the cause of an unwanted glitch in your test circuit, you can trigger on the glitch and make the pretrigger period large enough to capture data before the glitch. By analyzing what happens before the glitch, you may uncover information that helps you find the source of the glitch. Alternatively, to see what is happening in your system as a result of the trigger event, make the posttrigger period large enough to capture data after the trigger.

Slope and Level

The slope control determines whether the instrument finds the trigger point on the rising or the falling edge of a signal.

The level control determines where on that edge the trigger point occurs.

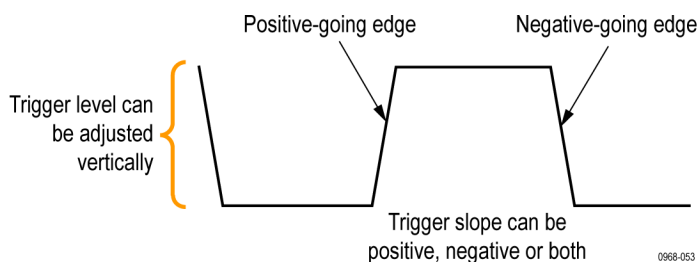

The oscilloscope provides a long horizontal bar or bars across the graticule to temporarily show the trigger level.

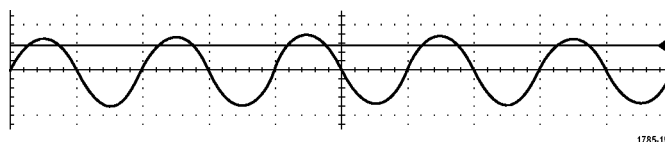

1. Turn the front panel Trigger **Level** knob to adjust the trigger level without going to a menu.
2. Push the front panel Trigger **Level** knob to quickly set the trigger level to the midpoint of the waveform.

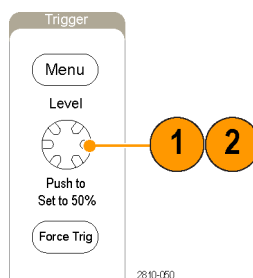

Choosing a Trigger Type

To select a trigger:

1. Push Trigger **Menu**.



2. Push **Type** to bring up the **Trigger Type** side menu.

NOTE. The bus trigger in the MDO3000 Series works on parallel buses even without an application module. Using the bus trigger on other buses requires use of a MDO3AERO, MDO3AUDIO, MDO3AUTO, MDO3FLEX, MDO3COMP, MDO3EMBD, or MDO3USB application module.

Trigger Type
Sequence (B Trigger)
Pulse Width
Timeout
Runt
Logic
Setup & Hold
Rise/Fall Time
Video
Bus

3. Turn **Multipurpose a** to select the desired trigger type.

4. Complete the trigger setup using the lower menu controls displayed for the trigger type. The controls to set up the trigger vary depending on the trigger type.

Type Edge	Source 1	Coupling DC	Slope 	Level 100 mV		Mode Auto & Holdoff
---------------------	--------------------	-----------------------	-----------	------------------------	--	----------------------------------

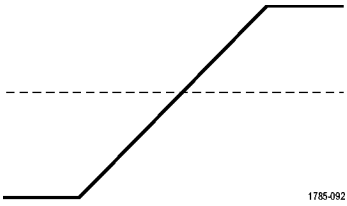
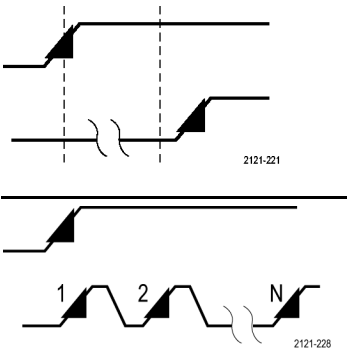
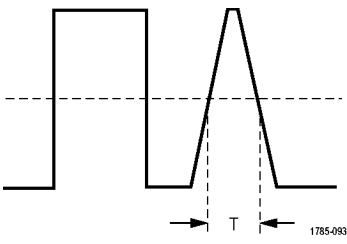
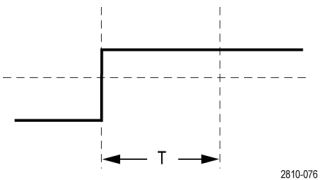
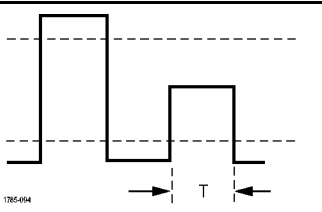

Selecting Triggers

Trigger Type	Trigger Conditions
<p data-bbox="256 300 310 327">Edge</p> 	<p data-bbox="911 300 1442 390">Trigger on a rising edge, a falling edge, or both edges, as defined by the slope control. Coupling choices are DC, LF Reject, HF Reject, and Noise Reject.</p> <p data-bbox="911 401 1453 548">Edge triggers are the simplest and most commonly used trigger type, with both analog and digital signals. An edge trigger event occurs when the trigger source passes through a specified voltage level in the specified direction.</p>
<p data-bbox="256 562 418 709">Sequence (B Trigger) (not available with an edge slope of Both)</p> 	<p data-bbox="911 562 1458 653">Combine an edge A Event (Main) trigger with the B Event (Delayed) trigger to capture more complex signals. (See page 65, <i>Act on Event</i>.)</p> <p data-bbox="911 663 1453 753">Time. After the A Event occurs, the trigger system waits the specified amount of time, and then looks for the B Event before triggering and displaying the waveform.</p> <p data-bbox="911 764 1453 854">Events. After the A Event occurs, the trigger system looks for a specified number of B Events before triggering and displaying the waveform.</p>
<p data-bbox="256 924 375 951">Pulse Width</p> 	<p data-bbox="911 924 1458 1110">Trigger on pulses that are less than, greater than, equal to, or not equal to a specified time. Additionally, you can trigger when a pulse width is within or outside a range of two different specified times. You can trigger on positive or negative pulses. Pulse width triggers are primarily used on digital signals.</p>
<p data-bbox="256 1176 337 1203">Timeout</p> 	<p data-bbox="911 1176 1458 1266">Trigger when no pulse is detected within a specified time. The signal stays above or below (or either above or below) a set value for a set amount of time.</p>
<p data-bbox="256 1365 305 1392">Runt</p> 	<p data-bbox="911 1365 1458 1551">Trigger on a pulse amplitude that crosses one threshold but fails to cross a second threshold before recrossing the first. You can detect positive or negative (or either) runts, or only those wider than, less than, greater than, equal to, or not equal to a specified width. Runt triggers are primarily used on digital signals.</p>

Trigger Type

Logic

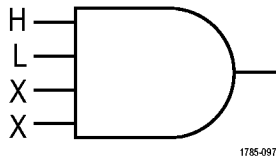

Trigger Conditions

Trigger when all channels transition to the specified state. Turn **Multipurpose a** to select a channel. Push the appropriate button on the side menu to set that channel's state to **High (H)**, **Low (L)**, or **Don't Care (X)**. Push **Clock** on the side menu to enable clocked (state) triggering. You can have at most a single clock channel. Push **Clock Edge** on the lower menu to change the polarity of the clock edge. Turn off clocked triggering and return to unclocked (pattern) triggering by selecting the clock channel and setting it to high, low, or don't care. For unclocked triggering, by default, triggering occurs when the selected condition goes true. You can also select triggering when the condition goes false, or time-qualified triggering. You can use up to 20 channels for a Logic trigger (4 analog and 16 digital).

NOTE. Optimum Logic trigger performance is achieved by using only analog channels or only digital channels.

Setup and Hold

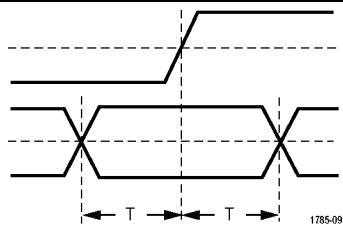

Trigger when a logic data input changes state inside of the setup or hold time relative to a clock edge.

Setup is the amount of time that data should be stable and not change before a clock edge occurs. Hold is the time that data should be stable and not change after a clock edge occurs.

MDO3000 Series oscilloscopes are capable of multiple channel Setup and Hold triggering, and can monitor the state of an entire bus for setup and hold violations. You can use up to 20 channels for a Setup and Hold trigger (4 analog and 16 digital).

Push **Clock** on the side menu to select the clock channel. Push the **Select** control, **Data**, and **Not used** buttons to select one or more channels you want to monitor for setup and hold violations.

NOTE. Optimum Setup and Hold trigger performance is achieved by using only analog channels or only digital channels.

Rise/Fall Time

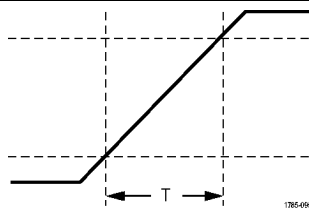

Trigger on rise and fall times. Trigger on pulse edges that traverse between two thresholds at faster or slower rates than the specified time. Specify pulse edges as positive or negative or either.

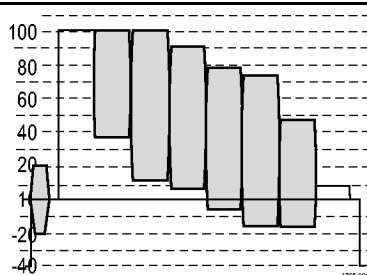
Trigger Type
Video**Trigger Conditions**

Trigger on specified fields or lines of a composite video signal. Only composite signal formats are supported.

Trigger on NTSC, PAL, or SECAM. Works with Macrovision signals.

Trigger on a variety of HDTV video standard signals, as well as custom (non-standard) bilevel and trilevel video signals with 3 to 4,000 lines.

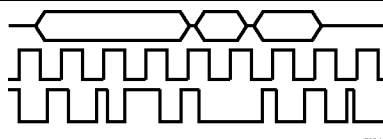
Bus

Trigger on various bus conditions.

I²C requires a MDO3EMBD module.

SPI requires an MDO3EMBD module.

CAN, CAN FD requires an MDO3AUTO module.

RS-232, RS-422, RS-485, and UART require an MDO3COMP module.

LIN requires an MDO3AUTO module.

FlexRay requires an MDO3FLEX module.

Audio requires an MDO3AUDIO module.

USB requires an MDO3USB module.

ARINC429 and MIL-STD-1553 requires an MDO3AERO module.

Parallel requires option MDO3MSO.

(See page 14, *Application Module Free Trial*.)

Triggering on Buses

You can use your oscilloscope to trigger on multiple data buses, if you have the appropriate application module installed. The MDO3000 Series can trigger on parallel buses without an application module. The oscilloscope can display both the physical layer (as analog waveforms) and the protocol level information (as digital and symbolic waveforms).

To set up the bus trigger:

1. If you have not already defined your bus using the front panel **B1** or **B2** buttons, do so now. (See page 67, *Setting Up a Serial or Parallel Bus*.)



2. Push Trigger **Menu**.



3. Push **Type**.

Type Bus	Source Bus B1 (I2C)	Trigger On Address	Address 07F		Direction Write	Mode Auto & Holdoff
--------------------	-------------------------------	------------------------------	-----------------------	--	---------------------------	-----------------------------------

4. Turn **Multipurpose a** to scroll through the trigger type side menu until you select **Bus**.



5. Push **Source Bus** and use the Source Bus side menu to select the bus that you want to trigger on.

6. Push **Trigger On** and select the desired trigger on feature from the side menu.

Parallel Bus Trigger (requires option MDO3MSO)

You can trigger on a binary or hex data value. Push **Data** on the lower menu and enter the parameters of interest with the **Multipurpose a** and **Multipurpose b** knobs.

ARINC429 Bus Trigger

You can trigger on **Word Start**, **Label**, **Data**, **Label and Data**, **Word End**, and **Error**.

If you have made a **Trigger On** selection of **Label** or **Label and Data**, push **Label** on the lower menu and enter a qualifier and **Label** values of interest.

NOTE. When the **Trigger On** selection is **Label and Data**, the qualifier for the **Label** value must be "EQUAL" and is locked to this value. It is unlocked when the **Trigger On** conditions is changed.

If you have made a **Trigger On** selection of **Data** or **Label and Data**, push **Data** on the lower menu and enter a qualifier and **Data** values of interest.

If you have made a **Trigger On** selection of **Error**, push **Error Type** on the lower menu and select **Any Error**, **Parity Error**, **Word Error**, or **Gap Error**.

I²C Bus Trigger

You can trigger on **Start**, **Repeated Start**, **Stop**, **Missing Ack**, **Address**, **Data**, or **Address/Data**.

If you are setting up an I²C trigger and have made a **Trigger On** selection of **Address** or **Address/Data**, push **Address** on the lower menu to access the I²C Address side menu.

Push **Addressing Mode** on the side menu and select **7 bit** or **10 bit**. Push **Address** on the side menu. Enter the address parameters of interest with the **Multipurpose a** and **Multipurpose b** knobs.

Then push **Direction** on the lower menu and select the direction of interest: **Read**, **Write**, or **Read or Write**.

If you have made a **Trigger On** selection of **Data** or **Address/Data**, push **Data** on the lower menu to access the I²C Data side menu.

Push **Number of Bytes** and enter the number of bytes with **Multipurpose a**.

Push **Addressing Mode** on the side menu and select **7-bit** or **10-bit**. Push **Data** on the side menu. Enter the data parameters of interest with the **Multipurpose a** and **Multipurpose b** knobs.

For more information on the I²C address formats, refer to item 2 under *Setting Up Bus Parameters*.

SPI Bus Trigger

You can trigger on **SS Active**, **MOSI**, **MISO**, or **MOSI & MISO**.

If you are setting up an SPI trigger and have made a **Trigger On** selection of **MOSI** or **MISO**, push **Data** on the lower menu, push **MOSI** or **MISO** on the side menu, and enter the data parameters of interest using the **Multipurpose a** and **Multipurpose b** knobs.

Then push **Number of Bytes** and enter the number of bytes with the **Multipurpose a** knob.

If you select **MOSI & MISO**, push **Data** on the lower menu and enter the parameters of interest in the side menus.

RS-232 Bus Trigger

You can trigger on **Tx Start Bit**, **Rx Start Bit**, **Tx End of Packet**, **Rx End of Packet**, **Tx Data**, or **Rx Data**.

If you are setting up an RS-232 trigger and have made a **Trigger On** selection of **Tx Data** or **Rx Data**, push **Data** on the lower menu.

Push **Number of Bytes** and enter the number of bytes with **Multipurpose a**.

Push **Data** on the side menu, and enter the parameters of interest with the **Multipurpose a** and **Multipurpose b** knobs.

CAN and CAN FD Bus Trigger

You can trigger on **Start of Frame**, **Type of Frame**, **Identifier**, **Data**, **Id & Data**, **End of Frame**, **Bit Stuffing Error**, and **Missing Ack**, **FD BRS Bit**, **FD ESI Bit**, **Form Error**, and **Any Error**. FD BRS Bit, FD ESI Bit, Form Error and Any Error are available only when CAN FD is selected as BUS.

If you are setting up a CAN or CAN FD trigger and have made a **Trigger On** selection of **Type of Frame**, push **Frame Type** on the lower menu, and select **Data Frame**, **Remote Frame**, **Error Frame**, or **Overload Frame**. All CAN FD data packets register as **Data Frame**.

If you have made a **Trigger On** selection of **Identifier**, push **Identifier** on the lower menu and select a **Format**. Then push **Identifier** on the side menu, and enter a binary or hex value with multipurpose knobs **a** and **b**.

Push **Direction** on the lower menu and select the direction of interest: **Read**, **Write**, or **Read or Write**. All CAN FD data packets register as **Write** direction.

If you have made a **Trigger On** selection of **Data**, push **Data** on the lower menu and enter the parameters of interest.

LIN Bus Trigger

You can trigger on **Sync**, **Identifier**, **Data**, **Id & Data**, **Wakeup Frame**, **Sleep Frame**, or **Error**.

If you are setting up an LIN trigger and have made a **Trigger On** selection of **Identifier**, **Data**, or **Identifier & Data**, push **Identifier** or **Data** on the lower menu and enter the parameters of interest on the resulting side menu.

If you have made a **Trigger On** selection of **Error**, push **Error Type** on the lower menu and enter the parameters of interest on the side menu.

FlexRay Bus Trigger

You can trigger on **Start of Frame**, **Type of Frame**, **Identifier**, **Cycle Count**, **Header Fields**, **Data**, **Id & Data**, **End of Frame** or **Error**.

Audio Bus Trigger

If you are using an **I2C**, **Left Justified (LJ)**, or **Right Justified (RJ)** audio bus, you can trigger on **Word Select** or **Data**.

If you are using an **TDM** audio bus, you can trigger on **Frame Sync** or **Data**.

USB Bus Trigger

You can trigger on **Sync**, **Reset**, **Suspend**, **Resume**, **End of Packet**, **Token (Address) Packet**, **Data Packet**, **Handshake Packet**, **Special Packet**, or **Error**.

MIL-STD-1553 Bus Trigger

You can trigger on **Sync**, **Command**, **Status**, **Data**, **Time (RT/IMG)**, or **Error**.

If you are setting up a MIL-STD-1553 trigger and have made a **Trigger On** selection of **Command**, push **RT Address** on the lower menu to enter specific values of **RT Address** to trigger on. Push **Command Word Details** on the lower menu to enter the **T/R bit** value, **Subaddress/Mode** value, **Word Count/Mode Code** value, and **Parity** value.

If you are setting up a MIL-STD-1553 trigger and have made a **Trigger On** selection of **Status**, push **RT-Address** on the lower menu to enter specific values of **RT Address** to trigger on. Push **Status Word Bits** on the lower menu to enter values for **Message Error (bit 9)**, **Instr. (bit 10)**, **Service Req. (bit 11)**, **BCR (bit 15)**, **Busy (bit 16)**, **Subsystem Flag (bit 17)**, **DBCA (bit 18)**, **Terminal Flag (bit 19)** and **Parity**.

If you are setting up a MIL-STD-1553 trigger and have made a **Trigger On** selection of **Data**, push **Data** on the lower menu to enter specific **Data** values, and the **Parity** value.

If you are setting up a MIL-STD-1553 trigger and have made a **Trigger On** selection of **Time (RT/IMG)**, push **Trigger When** on the lower menu to set the trigger condition. Push **Times** on the lower menu to set the **Maximum** and **Minimum** times.

If you are setting up a MIL-STD-1553 trigger and have made a **Trigger On** selection of **Error**, push **Error Type** on the lower menu to select the type of error to trigger on.

I²C, SPI, USB, CAN, CAN FD, LIN, and FlexRay Bus Trigger Data Matching

Rolling window byte matching for I²C, SPI, USB, CAN, CAN FD, and FlexRay. To use a rolling window to trigger on data, you define the number of bytes to match. Then the oscilloscope uses a rolling window to find any match within a packet, with the window rolling one byte at a time.

For example, if the number of bytes is one, the oscilloscope will attempt to match the first byte, second byte, third, and so on within the packet.

If the number of bytes is two, the oscilloscope will try to match any two consecutive bytes, such as one and two, two and three, three and four, and so on. If the oscilloscope finds a match, it will trigger.

With USB, CAN, CAN FD, or FlexRay, obtain a rolling window match by setting the **Byte Offset** in the Data menu to **Don't care**.

Specific byte matching (non-rolling window matching for a specific position in the packet) for I²C, SPI, USB, CAN, CAN FD, LIN, and FlexRay.

You can trigger on a specific byte for I²C, SPI, CAN, CAN FD, LIN, and FlexRay in several ways:

- For I²C and SPI, enter the number of bytes to match the number of bytes in the signal. Then use don't cares (X) to mask the bytes that you are not interested in.
- For I²C, push **Trigger On** on the lower menu to trigger on **Address/Data**. Push **Address**. On the side menu, push **Address**, and turn **Multipurpose a** and **Multipurpose b** as needed. Set the address to don't cares (X) if you want to mask the address. The data will be matched starting at the first byte without using a rolling window.
- For USB, triggering occurs when the user-selected data input matches the data and qualifier in the signal starting at the byte offset. Set the number of bytes to match the number of bytes of interest. Use the data qualifier to perform: =, !=, <, >, >=, and <= operations.
- For CAN and CAN FD triggering occurs when the user-selected data input matches the data and qualifier in the signal starting at the byte offset. Set the number of bytes to match the number of bytes of interest. Use the data qualifier to perform: =, !=, <, >, >=, and <= operations. Triggering on identifier and data always performs an exact match on the specified identifier and uses the selected qualifier operation on the data, starting at the byte offset. Setting the qualifier to perform an "=" comparison will allow matching on up to 8 bytes of data. All other qualifiers are limited to 4 bytes of specified data.
- For LIN, triggering occurs when the user-selected data input matches the data and qualifier in the signal starting with the first data byte. Set the number of bytes to match the number of bytes of interest. Use the data qualifier to perform: =, !=, <, >, >=, <=, In Range, and Out of Range operations. Triggering on identifier and data always performs an exact match on the specified identifier and uses the selected qualifier operation on the data, starting with the first data byte. Setting the qualifier to perform an "=" comparison will allow matching on up to 8 bytes of data. All other qualifiers are limited to 4 bytes of specified data. No rolling window is used.
- For FlexRay and Ethernet, triggering occurs when the user-selected data input matches the data and qualifier in the signal starting at the byte offset. Set the number of bytes to match the number of bytes of interest. Use the data qualifier to perform: =, !=, <, >, >=, and <= operations. Triggering on identifier and data always matches the identifier and data selected by the user, with the data starting at the first byte. No rolling window is used.

Data Value Matching

You can trigger on a specific data value for RS-232 bytes. If you defined an end-of-packet character to use for RS-232 bus decoding, you can use the same end-of-packet character as a data value for trigger data matching. To do so, choose the Tx End of Packet or the Rx End of Packet character as the Trigger On selection.

You can also trigger on a specific data value for other buses.

Parallel Bus Trigger Data Matching

Optimum parallel bus trigger performance is achieved by using only analog channels or only digital channels.

Checking Trigger Settings

To quickly determine the settings of some key trigger parameters, check the Trigger readout at the bottom of the display. The readouts differ for edge and the advanced triggers.

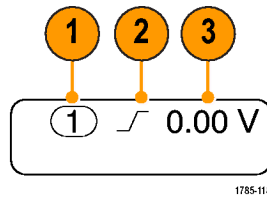

Edge trigger readout

1. Trigger source = channel 1.
2. Trigger slope = rising.
3. Trigger level = 0.00 V.

Using Sequence Trigger (A (Main) and B (Delayed))

Combine an edge A Event (Main) trigger with the B Event (Delayed) trigger to capture more complex signals. After the A Event occurs, the trigger system looks for the B Event before triggering and displaying the waveform.

A and B triggers can (and typically do) have separate sources.

NOTE. You can select sequence triggering when you choose the slope type **Falling** or **Rising** — but not when you pick the slope type **Both**.

Use the Edge trigger menu to set up the A trigger first. Then, to use the B trigger:

1. Push Trigger **Menu**.



2. Push **Type**.
3. Turn **Multipurpose a** to select a trigger type of **Sequence (B Trigger)**.
This brings up the Sequence (B Trigger) menu.

4. Push **B Trigger After A**.

Type Sequence (B Trigger)	Source 1	Coupling DC	Slope 	Level 0.00 V	B Trigger After A Time	Mode Auto & Holdoff
---------------------------------	-------------	----------------	-----------	-----------------	------------------------------	---------------------------



Select the method for sequencing the B trigger after the A by pushing a side menu button.

Time (a) 8 ns
B Events 1
Set to Minimum

- Set the other Sequence Trigger parameters in the related side and lower menus.

B Trigger After Delay Time

The A trigger arms the instrument. Posttrigger acquisition starts on the first B edge after the trigger delay time.

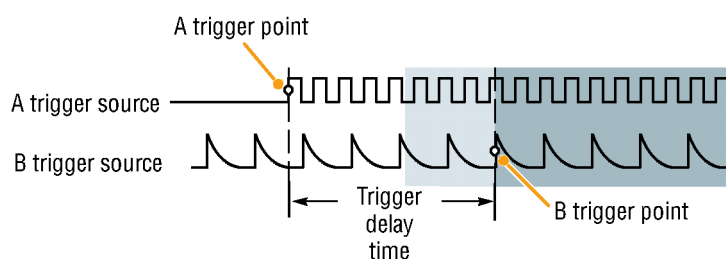

Trigger on B Events

The A trigger arms the instrument. Posttrigger acquisition starts on the nth B event.

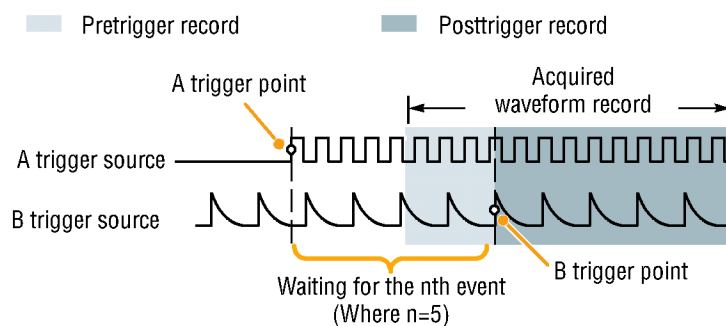

Quick Tips

- B-trigger delay time and horizontal position are independent functions. When you establish a trigger condition using either the A trigger alone or the A and B triggers together, you can also use the horizontal position control to delay the acquisition by an additional amount.
- When using the B trigger, the A and B trigger types can only be Edge.

Starting and Stopping an Acquisition

After you have defined the acquisition and trigger parameters, start the acquisition with **Run/Stop** or **Single**.

- Push **Run/Stop** to start acquisitions. The oscilloscope acquires repeatedly until you push the button again to stop the acquisition.
- Push **Single** to take a single acquisition. Single sets the trigger mode to **Normal** for the single acquisition.
- If any analog or digital waveforms are active, then pressing **Run/Stop** to stop acquisitions will cause the oscilloscope to wait for one more trigger event before stopping. Once the acquisition occurs, the **Run/Stop** button will turn red and the **Single** button will become unlit.

If the Trigger Mode is set to Auto and another trigger event does not occur within the Auto trigger timeout period then an acquisition will be made and the instrument will stop.

If the Trigger mode is set to Normal, the oscilloscope will continue waiting for a trigger event to occur as long as necessary.

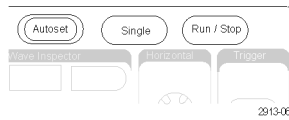

Display Waveform or Trace Data

This section contains concepts and procedures for displaying the acquired waveform or trace.

Adding and Removing a Waveform

1. To add or remove a waveform from the display, push the corresponding front panel channel button or the D15-D0 button.

You can use the channel as a trigger source whether or not it is displayed.

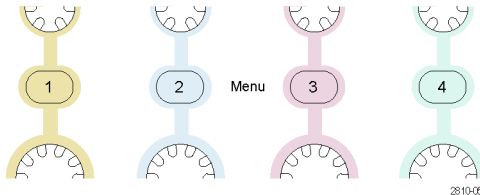

Setting the Display Style and Persistence

1. To set the display style, push **Acquire**.



2. Push **Waveform Display**.

Mode Sample	Record Length 10k	FastAcq Off	Delay On Off	Set Horiz. Position to 10%	Waveform Display	XY Display On
----------------	----------------------	----------------	-----------------	----------------------------------	---------------------	------------------



3. Push **Dots Only On Off** on the side menu. Dots on will display the waveform record points as dots on the screen. Dots off connects the dots with vectors.

4. Push **Persistence** to **Off** to display the display persistence.

5. Push **Persist Time**, and turn **Multipurpose a** to have waveform data remain on screen for a user-specified amount of time.

6. Push **Set to Auto** to have the oscilloscope automatically determine a persistence time for you.

7. Push **Clear Persistence** to reset the persistence information.

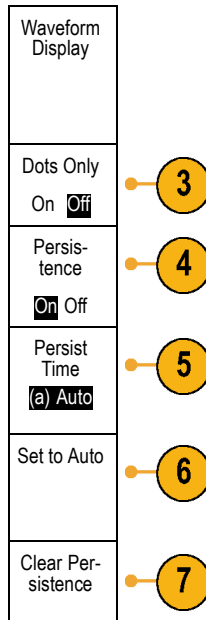

8. To display the amplitude from one waveform against the amplitude from another, push **XY Display**. Then push **Triggered XY** from the side menu.

A data point from the first waveform specifies the horizontal location while the corresponding data point from the second waveform specifies the vertical location for each displayed point.

You can optionally view both the YT and XY displays simultaneously on the same screen.

Quick Tips

- Variable persistence accumulates record points for a specified time interval. Each record point decays independently according to the time interval. Use variable persistence for displaying infrequently appearing signal anomalies, such as glitches.
- Infinite persistence continuously accumulates record points until you change one of the acquisition display settings. Use infinite persistence for displaying unique signal anomalies, such as glitches.
- The XY Display mode graphs the data in fixed pairs of waveforms against one another.

Setting the Graticule Style

1. To set the graticule style, push **Utility**.



2. Push **Utility Page**.

Utility
Page



3. Turn **Multipurpose a** and select **Display**.

Display

4. Push **Graticule** on the lower menu.

Utility Page Display	Backlight Intensity High	Graticule Full	Screen Annotation	Trigger Frequency Readout		
-----------------------------------	---------------------------------------	--------------------------	----------------------	---------------------------------	--	--



5. Select the desired style on the side menu.

The **Frame** graticule provides a clean screen on which you can most easily read automatic measurement results and other screen text.

The **Full** graticule can help you make cursor measurements on hard copies.

The **Grid**, **Solid**, and **Cross Hair** graticules provide compromises between **Frame** and **Full**.

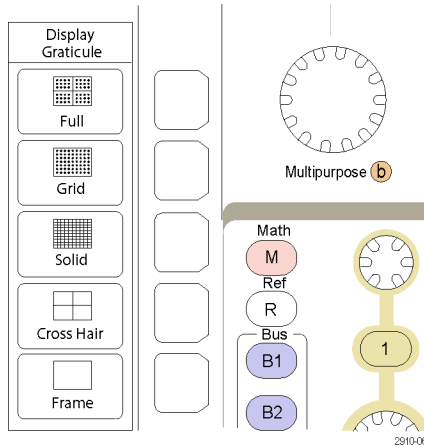

Quick Tips

- You can display IRE and mV graticules. To do this, set the trigger type to video and set the vertical scale to 114 mV/division. (The 114 mV/division selection is available in the fine vertical scale settings for the channel when you set the trigger type to video.) The oscilloscope will automatically display the IRE graticule for NTSC signals, and the mV graticule for other video signals (PAL, SECAM, HDTV, and custom).

Setting the LCD Backlight Brightness and Dimming Settings

1. Push **Utility**.



2. Push **Utility Page**.



3. Turn **Multipurpose a** and select **Display**.



4. Push **Backlight**.

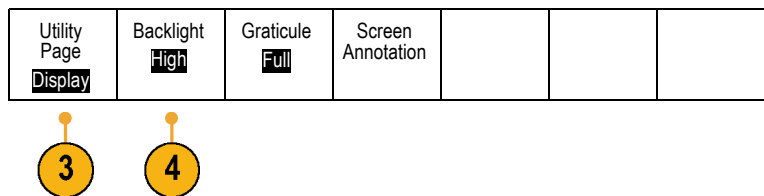

5. Select the intensity level on the side menu. Choices are: **High**, **Medium**, and **Low**.
6. Enabling **Auto-Dim** will turn down the screen lighting after a set time. Using it may help prolong the LCD life.

Backlight
Backlight Intensity High
Auto-Dim On Off
Time 60min

Setting Waveform Intensity

1. Push **Intensity** on the front panel.



This will bring up the intensity readout on the display.

- a) Waveform Intensity: 35%
- b) Graticule Intensity: 75%

2121-246

2. Turn **Multipurpose a** to select the desired waveform intensity.

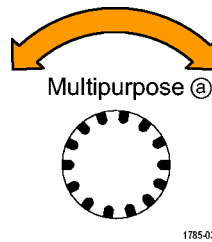

3. Turn **Multipurpose b** to select the desired intensity for the graticule.
4. Push **Intensity** again to clear the intensity readout from the display.



Scaling and Positioning a Waveform

Use the horizontal controls to adjust the time base, adjust the trigger point, and to examine waveform details more closely. You can also use the Wave Inspector Pan and Zoom controls to adjust the display of waveforms. (See page 149, *Using Wave Inspector to Manage Long Record Length Waveforms*.)

If you push the **Horizontal Position** knob and **Delay** is set to **On**, the horizontal position is set to 0 seconds. If you push it and **Delay** is set to **Off**, the horizontal position is set to 10%.

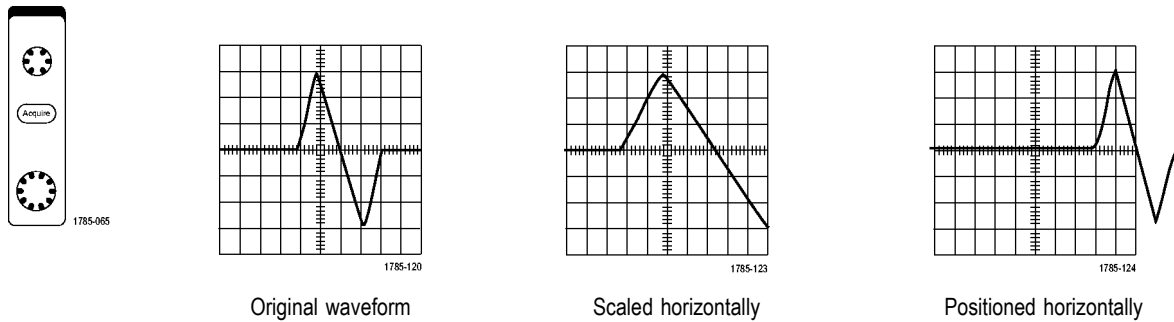

Use the vertical controls to select waveforms, adjust the waveform vertical position and scale, and set input parameters. Push a channel menu button (1, 2, 3, or 4), button as many times as needed and the associated menu items to select, add, or remove a waveform.

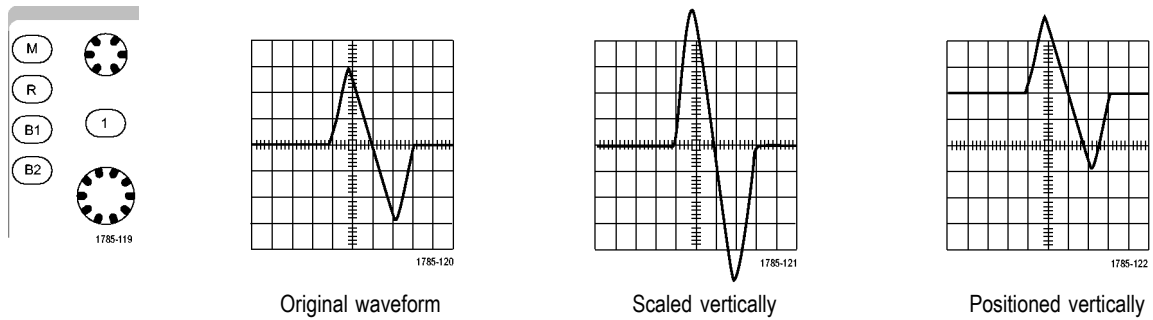

Quick Tips

- **Preview.** If you change the Position or Scale controls when the acquisition is stopped or when it is waiting for the next trigger, the oscilloscope rescales and repositions the relevant waveforms in response to the new control settings. It simulates what you will see when you next push the **RUN** button. The oscilloscope uses the new settings for the next acquisition.

You may see a clipped waveform if the original acquisition went off the screen.

The math waveform, cursors, and automatic measurements remain active and valid when using preview.

Setting Input Parameters

Use the vertical controls to select waveforms, adjust the waveform vertical position and scale, and set input parameters.

1. Push a channel menu button **1**, **2**, **3**, or **4** to bring up the vertical menu for the designated waveform. The vertical menu only affects the selected waveform.

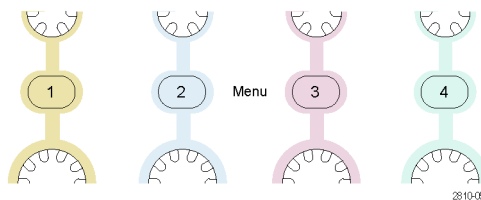

Pushing a channel button will also select or cancel that waveform selection.

2. Push **Coupling** repeatedly to select the coupling to use.
Use DC coupling to pass both AC and DC components.
Use AC coupling to block the DC component and show only the AC signal.

Coupling DC AC	Termination 1MΩ 50Ω	Invert On Off	Bandwidth Full	(1) Label	More	
--------------------------	------------------------	-------------------------	--------------------------	-----------	------	--



3. Push **Termination** repeatedly to select the input impedance to use.
Set the input impedance (termination) to 50 Ω or 1 MΩ if using DC coupling. Input impedance is automatically set to 1 MΩ when using AC coupling.
75 Ω is available on models ≤ 500 MHz.
For more information on input impedance, see **Quick Tips**. (See page 112, *Quick Tips*.)
4. Push **Invert** to invert the signal.
Select **Off** for normal operation and **On** to invert the polarity of the signal in the preamplifier.

5. Push **Bandwidth**, and select the desired bandwidth on the side menu.

The set choices are: Full, 250 MHz, and 20 MHz. Additional choices may appear, depending on the probe that you use.

Select **Full** to set the bandwidth to the full oscilloscope bandwidth.

Select **250 MHz** to set the bandwidth to 250 MHz.

Select **20 MHz** to set the bandwidth to 20 MHz.

NOTE. 100 MHz and 200 MHz model oscilloscopes do not include a 250 MHz option on the menu.

6. Push **Label** to create a label for the channel. (See page 55, *Labeling Channels and Buses*.)
7. Push **More** to access a pop-up menu of additional features. These are described below.

8. Select **Fine Scale** to enable **Multipurpose a** to make fine vertical scale adjustments.

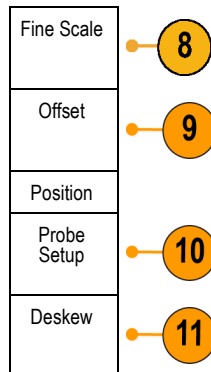

9. Select **Offset** to enable **Multipurpose a** to make vertical offset adjustments.
Push **Set to 0 V** on the side menu to set the vertical offset to 0 V.
For more information on offset, see **Quick Tips**. (See page 112, *Quick Tips*.)

10. Select **Probe Setup** to define probe parameters.

On the side menu:

- Select **Voltage** or **Current** to set the probe type for probes that do not have a TekProbe Level 1, TekProbe II (requires a TPA-BNC adapter) or TekVPI interface.
- For probes that do not have a Tek interface, when **Probe Type** is set to **Voltage**, turn **Multipurpose a** to set **Attenuation** to match the probe
- For probes that do not have a Tek interface, when **Probe Type** is set to **Current**, turn **Multipurpose a** to set the Amps/Volts ratio (Attenuation) to match the probe.
- If you are measuring current by probing the voltage drop across a resistor, set **Measure Current** to **Yes**. Push **A/V** ratio on the side menu and turn **Multipurpose a** to set the Amps/Volts or Volts/Amp ratio of your setup. For example, if you are measuring the drop across a 2 Ω resistor, set the V/A ratio to 2.
- For some types of probes, you can push this button to instruct the oscilloscope to perform an AC calibration on the entire signal path from the probe tip to the specific oscilloscope channel. This can result in a flatter frequency response over the entire frequency range.

11. Select **Deskew** to make display and measurement adjustments for probes that have differing propagation delays. This is especially important when using a current probe in conjunction with a voltage probe.

For best results, use a deskew fixture, such as the Tektronix 067-1686-xx.

If you do not have a deskew fixture, you can use the controls in the Deskew menu to set the oscilloscope's deskew parameters to recommended values, based on the nominal propagation delay of each probe. The oscilloscope automatically loads the nominal propagation delay values of TekVPI and TekProbe II (requires use of a TPA-BNC adaptor) probes. For other common probes, first push **Select** on the side menu, and select the channel to which the probe is attached. Then push **Probe Model** on the side menu, and select the probe model. If your probe is not in the list, set probe model to **Other**, and push **Propagation Delay** on the side menu and dial in its propagation delay with **Multipurpose a**.

To display the recommended deskew values calculated by the oscilloscope, set **Show rec. deskews** on the side menu to **Yes**.

To set the deskew values of each channel to the recommended values, push **Set all deskews to recommended values** on the side menu.

Quick Tips

- **Using Probes with the TekProbe II and TekVPI Interfaces.** When you attach a probe with the TekProbe II or the TekVPI interface, the oscilloscope sets the channel sensitivity, coupling, and termination resistance automatically to match the probe requirements. Tek Probe II probes require use of the TPA-BNC Adapter.
- **The Difference Between Vertical Position and Offset.** Adjust the vertical position to place the waveforms where you want to see them. The waveform baseline indicators indicate the zero Volts (or Amps) level for each waveform. If you adjust the channel's Vertical Scale, the waveform expands or contracts around the waveform's baseline indicator.

When you use the Channel<x> > **More** > **Offset** > **Vertical Offset** control to move a waveform, the baseline indicator no longer represents zero. Instead, it represents the level of the offset. If you adjust the channel's Vertical Scale, the waveform expands or contracts around the waveform's baseline indicator.

- **50 Ω Protection.** If you select 50 Ω termination, the maximum vertical scale factor is limited to 1 V/div, except that with a 10X probe the scale factor is 10 V. If you apply excessive input voltage, the oscilloscope automatically switches to 1 M Ω termination to protect the internal 50 Ω termination. For more details, refer to the specifications in the *MDO3000 Series Oscilloscopes Technical Reference*.

Positioning and Labeling Bus Signals

Positioning bus signals. Push the appropriate front panel bus button and turn the **Multipurpose a** knob to adjust the vertical position of the selected bus. (See page 67, *Setting Up a Serial or Parallel Bus*.)

1. Push the appropriate front panel bus button to select that bus.



2. Turn the **Multipurpose a** knob to adjust the vertical position of the selected bus.

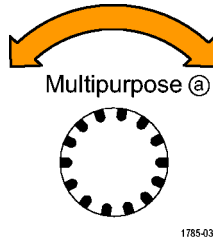

Labeling bus signals. To label a bus, do the following steps:

1. Push the appropriate front panel bus button.



2. Push **Label**.
(See page 55, *Labeling Channels and Buses*.)

Bus (B1) Parallel	Define Inputs	Thresholds		(B1) Label Parallel	Bus Display	Event Table
----------------------	------------------	------------	--	------------------------	----------------	----------------



Positioning, Scaling, and Grouping Digital Channels

1. Push the front panel **D15–D0** button.



2. Push **D15–D0** on the lower menu.

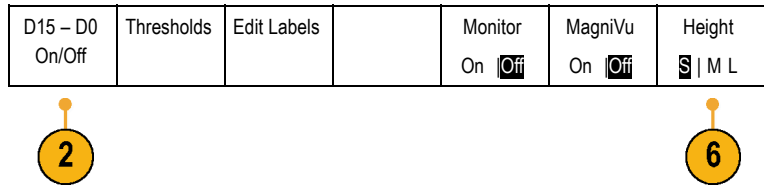

3. Push **Select** on the side menu.

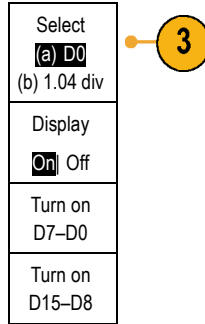

4. Turn **Multipurpose a** to select the channel to move.

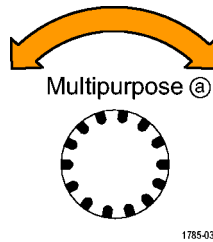

5. Turn **Multipurpose b** to move the selected channel.

NOTE. The display of the channel (or group) only moves after you stop rotating the knob.

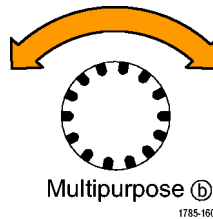

6. To change the scale (height) of the digital channels, push **Height** on the lower menu.

NOTE. The **S** (Small) selection will display each waveform at 0.2 divisions tall. The **M** (Medium) selection will display each waveform at 0.5 divisions tall. The **L** (Large) selection will display each waveform at 1 division tall. **L** only works if there is enough room in the display to display the waveforms. You can display up to 8L waveforms at one time.

7. You can label individual digital channels for easier identification. (See page 55, *Labeling Channels and Buses.*)

8. To group some or all of the digital channels together, move the channels right next to each other. All the channels that are next to each other automatically form a group.

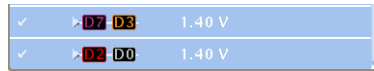

You can see the groups by pushing **Select** on the side menu and turning the **Multipurpose a** knob.

When a group is selected, turn **Multipurpose b** to move the whole group.

Viewing Digital Channels

The various ways of displaying data from the digital channels help you analyze the signals. Digital channels store a high or low state for each sample.

Logic high levels are displayed in green. Logic low levels are displayed in blue. When a single transition occurs during the time represented by one pixel column, the transition (edge) is displayed in gray.

When multiple transitions occur during the time represented by one pixel column, the transition (edge) is displayed in white.

When the display shows a white edge, indicating multiple transitions, you may be able to zoom in and see the individual edges.

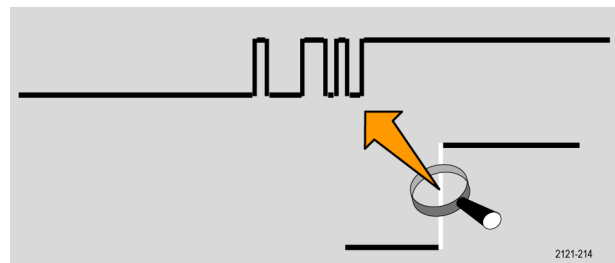

When you are zoomed in so far that there is more than one pixel column per sample, the uncertainty of the edge position is indicated by light gray shading.



NOTE. When the light gray shading is displayed, use *MagniVu*.

Annotating the Screen

You can add your own text to the screen by doing the following:

1. Push **Utility**.



2. Push **Utility Page**.



3. Turn the **Multipurpose a** knob and select **Display**.



4. Push **Screen Annotation** on the resulting lower menu.

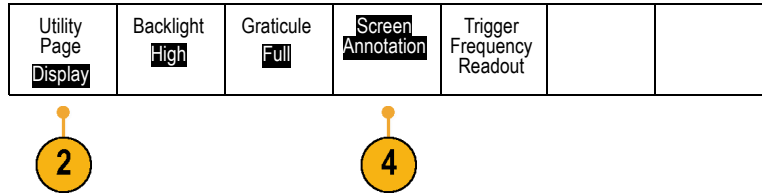

5. Push **Display Annotation** to select **On** on the side menu.

The annotation window now appears.
Position it by turning the **Multipurpose a** and **Multipurpose b** knobs.

6. Push **Edit Annotation** on the side menu

7. Turn the **Multipurpose a** knob to scroll through the list of letters, numbers, and other characters to select each desired character.

Alternatively, use a USB keyboard to type in characters. (See page 35, *Connecting a USB Keyboard to Your Oscilloscope.*)

To reposition the annotated text, push **Position** on the side menu and turn **Multipurpose a** and **Multipurpose b**, as desired.

Viewing the Trigger Frequency

You can display a readout of trigger frequency. It counts all of the triggerable events, whether the oscilloscope triggered on them or not, and displays the number of times per second that they occur. To display this readout, do the following:

1. Push **Utility**.



3249-012

2. Push **Utility Page**.



3. Turn **Multipurpose a** and select **Display**.



4. Push **Trigger Frequency Readout** from the resulting lower menu.

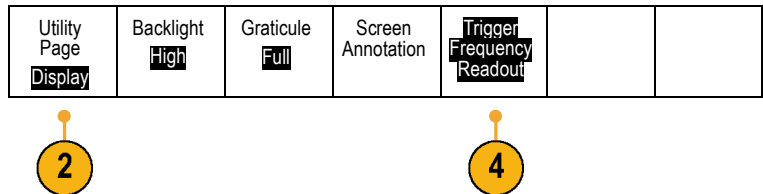

5. Push **On** on the side menu.

The trigger frequency now appears in the Trigger readout, toward the lower right of the display.

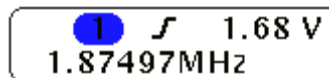

Displaying the Frequency Domain Menu

1. Push **RF** to bring up the frequency domain menu.



2. Push **Spectrum Traces** to bring up the side menu of four different spectrum trace types that the MDO3000 can display.

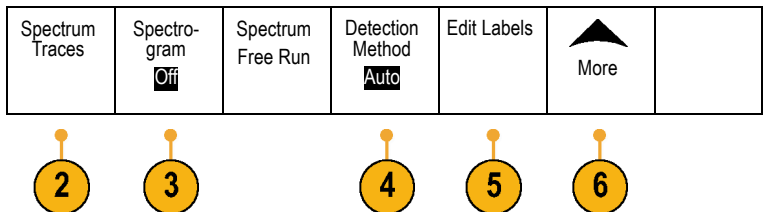

3. Push **Spectrogram** to bring up a side menu to enable and configure the spectrogram display.
4. Push **Detection Method** to bring up a side menu of ways to reduce the FFT output to the 750 pixel wide display.
5. Push **Edit Label** to label the RF traces.
6. Push **More** to choose between side menus to compensate the RF signal path or to configure the RF input probe.

Trace Types

The frequency domain window supports four spectrum traces. You may turn each of these traces on and off independently. You can display all or some of them simultaneously.

1. Push **Spectrum Traces** from the RF Menu to bring up the related side menu.

2. Set **Normal** to **On** to display the normal trace.
3. Set **Average** to **On** to display the average trace. Turn **Multipurpose a** to set the number of waveforms to include in each average.
4. Set **Max Hold** to **On** to display the max hold trace.
5. Set **Min Hold** to **On** to display the min hold trace.

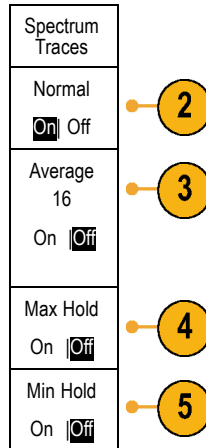

The figure to the right illustrates the different trace types.

1. Normal trace: Each acquisition is discarded as new data is acquired.
2. Max hold trace: The maximum data values are accumulated over multiple acquisitions of the Normal trace.
3. Min hold trace: The minimum data values are accumulated over multiple acquisitions of the Normal trace.
4. Average trace: Data from the Normal trace is averaged over multiple acquisitions. This is true power averaging, which occurs before the log conversion. Each power of 2 averaging reduces the displayed noise by 3 dB.

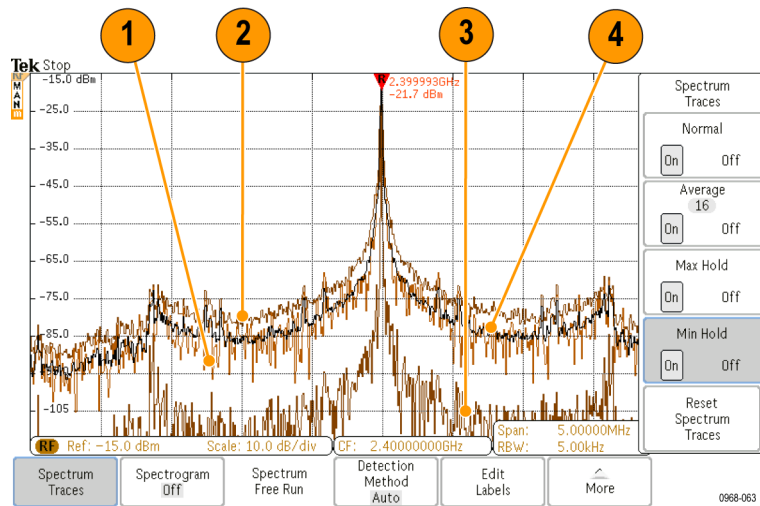

The figure to the right shows the frequency domain window's trace indicator.

1. An **RF** trace indicator is placed at the Reference Level.
2. A capital **M** appears if the maximum trace is turned on.
3. A capital **A** appears if the average trace is turned on.
4. A capital **N** appears if the normal trace is turned on.
5. The small **m** appears if the minimum trace is turned on.

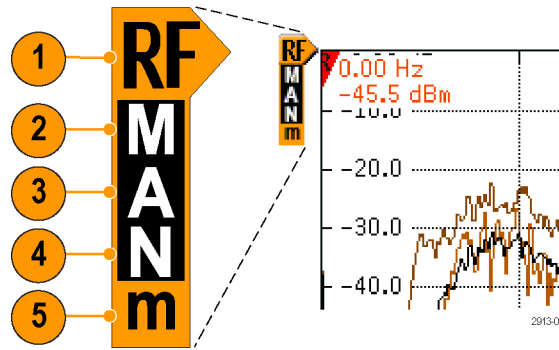

Orange highlighting indicates the currently selected trace. In the figure to the right, the small **m**, which stands for the minimum trace, is highlighted. This indicates that the minimum trace is currently selected.

Detection Types

The MDO3000 calculates FFTs with a 1,000 to ~2,000,000 point output, depending on the acquisition settings. It then reduces that FFT output into a 750 pixel-wide display. This means that approximately 1 to 2,000 FFT points get compressed into each pixel column. The MDO3000 gives you several choices as to how this compression is done. The choices are: +peak, sample, average, and -peak. The figure below illustrates how these detection methods work in a 5:1 compression, where five points are reduced to each pixel column.

1. FFT points

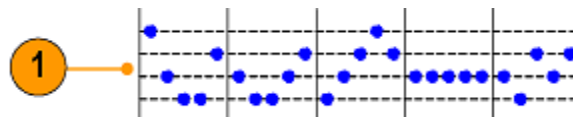

2. Decimation



3. +Peak: Uses the highest amplitude point in each interval.



4. Sample: Uses the first point in each interval.



5. Average: Averages all points in each interval.



6. -Peak: Uses the lowest amplitude point in each interval.



2916-003

Spectrogram Display

The spectrogram display is particularly useful for monitoring slowly-changing RF phenomena. The x-axis represents frequency, just like the typical spectrum display. The y-axis represents time. Color indicates amplitude.

Spectrogram slices are generated by taking each spectrum and flipping it on its edge so that it is one pixel row tall, and then assigning colors to each pixel based on the amplitude at that frequency with the cold colors of blue and green representing low amplitude, and the hotter colors of yellow and red indicating higher amplitude. Each new acquisition adds another slice at the bottom of the spectrogram, and the history moves up one row.

When acquisitions are stopped, you can navigate through the history of the spectrogram by pressing the side menu slice control and turning the **Multipurpose a** knob. When acquisitions are stopped and the spectrogram is displayed, the spectrogram slice trace is displayed as the Normal spectrum trace.

To use the spectrogram feature, push **Spectrogram** from the RF Menu to bring up the related side menu.

1. Push **Display** to **On** to start the spectrogram.
2. To review each spectrum captured in the spectrogram, push **Run / Stop** to stop acquiring RF acquisitions. Turn **Multipurpose a**.

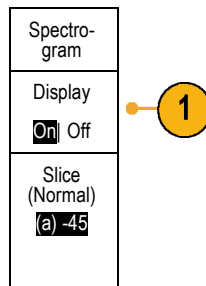

Analyze Waveform or Trace Data

After having properly set up the acquisition, triggering, and display of your desired waveform or trace, you can analyze the results. Select from features such as cursors, automatic measurements, statistics, waveform histograms, math, and FFT.

Using Markers in the Frequency Domain

1. Push **Markers**. This brings up the **Markers** side menu.



2. Push **Peak Markers** and turn **Multipurpose a** to select how many peaks to label on the display.

NOTE. This is the maximum number of peaks that will be marked. If there are more peaks that meet the threshold and excursion criteria than the specified number of Peak Markers identified in this control, then only the specified number of highest amplitude peaks will be marked.

3. Push  To Center to set the center frequency to the frequency indicated by the Reference Marker. The Reference Marker is automatically placed on the highest amplitude peak.

4. Push **Threshold** and turn **Multipurpose a** to define the threshold of the peak markers. Turn **Multipurpose b** to define their excursion value.

5. Push **Manual Markers** to activate manual markers. Use manual markers to measure non-peak areas of interest in the spectrum.

6. Push **Readout** to choose between Absolute and Delta readouts. Delta readouts are relative to the Reference Marker.

Markers
Peak Markers (a) 5 On Off
 To Center
Threshold -50.0 dBm Excursion 30.0 dB
Manual Markers On Off
Readout Absolute Delta

Automatic Peak Markers

Automatic peak markers are on by default and assist with quickly identifying the frequency and amplitude of peaks in the spectrum.

1. The Reference Marker is placed on the highest amplitude peak. It is marked with a red R in a triangle.
2. The automatic markers indicate frequency and amplitude.
3. Absolute readouts show the actual frequency and amplitude of the automatic markers.
4. Delta readouts show the frequency and amplitude of the automatic markers relative to the reference marker.

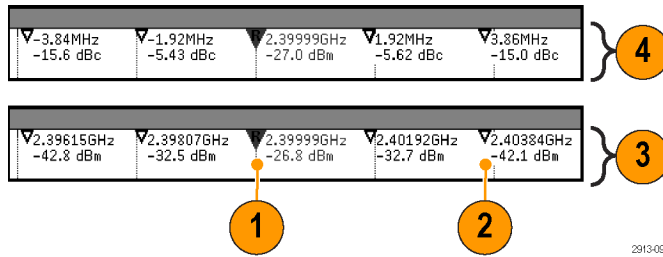

In the screen shot shown below, a marker has been placed on each of the obvious peaks in the display. The Reference Marker is the highest peak. It is marked with the red R in a triangle, and its readout is shown in red text.

1. Reference marker
2. Automatic markers

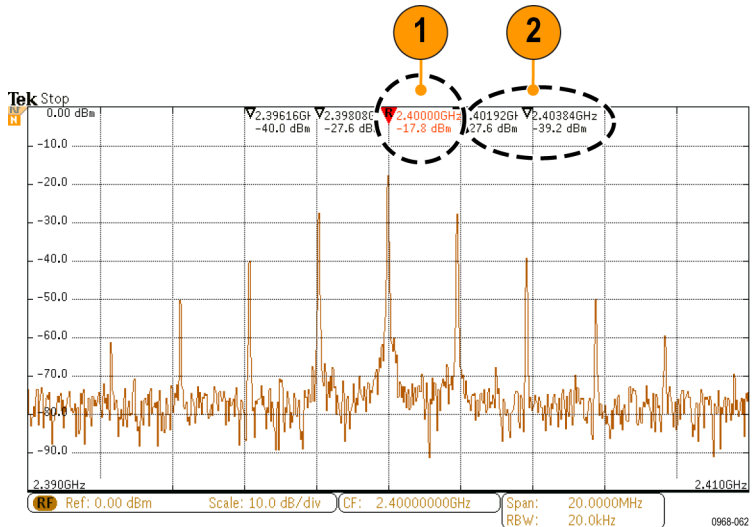

Use **Threshold** and **Excursion** to define which peaks are marked.

The threshold is a minimum amplitude that a signal must cross to be a valid peak. If the threshold is lower, more peaks will tend to qualify to have markers. If the threshold is higher, fewer peaks tend to qualify to have markers.

The excursion is how far a signal needs to fall in amplitude between marked peaks to be another valid peak. If the excursion is low, more peaks will tend to qualify to have associated markers. If the excursion is high, fewer peaks will tend to qualify to have associated markers.

Each automatic marker has a readout associated with it. These can be absolute or delta readouts. An absolute marker readout shows the actual frequency and amplitude of the associated marker. A delta marker readout shows the frequency and amplitude differences from the Reference Marker. The Reference Marker's readout indicates absolute frequency and amplitude, regardless of the readout type.

Manual Markers

Two manual markers are provided for you to measure non-peak areas of the spectrum and to measure Noise Density and Phase Noise. When the manual markers are turned on, the Reference Marker is no longer automatically attached to the highest amplitude peak. It is now assigned to the **Multipurpose a** knob and can be moved to any location you desire. This enables easy measurement of any part of the spectrum as well as delta measurements to any part of the spectrum. This also lets you measure non-peak spectral content of interest. The readouts for manual markers indicate frequency and amplitude, just like automatic marker readouts.

As with automatic peak marker readouts, the manual marker readouts can show either absolute or delta values.

1. One manual marker is controlled by **Multipurpose a**.
2. The other manual marker is controlled by **Multipurpose b**.

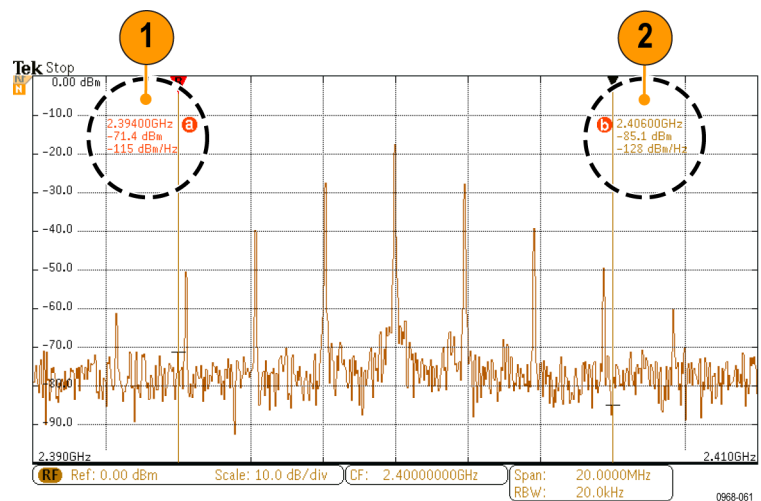

3. Delta readouts for frequency and amplitude are shown at the top of the display.
4. The third line of the manual marker **a** always shows the noise density (dBm/Hz).
5. The third line of manual marker **b** always shows noise density when you choose absolute markers. It shows phase noise when you choose delta markers (dBc/Hz).

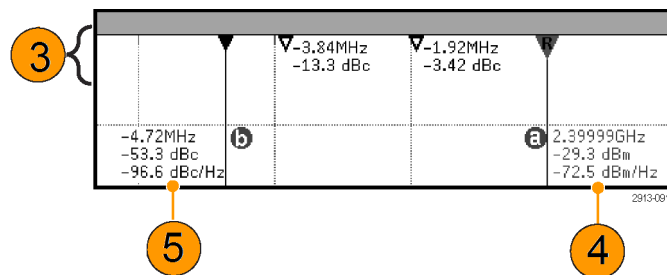

Taking Automatic Measurements in the Time Domain

To take an automatic measurement in the time domain:

1. If the instrument is in the frequency domain, push channel 1.



2. Push **Measure**.



3. Push **Add Measurement**.

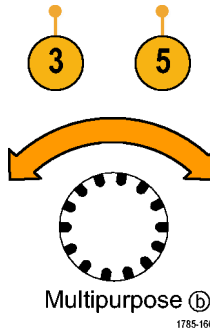
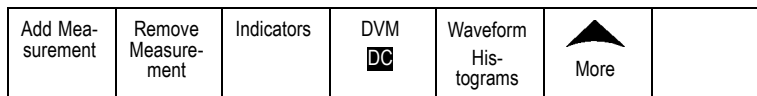

4. Turn the **Multipurpose b** knob to select the specific measurement. If needed, then turn **Multipurpose a** to select the channel to measure on.

5. To remove a measurement, push **Remove Measurement**, turn **Multipurpose a** to select the specific measurement, and push **OK Remove Measurement** on the side menu.







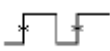

Quick Tips

- To remove all measurements, select **Remove All Measurements**.
- A  symbol appears instead of the expected numerical measurement if a vertical clipping condition exists. Part of the waveform is above or below the display. To obtain a proper numerical measurement, turn the vertical scale and position knobs to make all of the waveform appear in the display.
- If the oscilloscope displays a **Low Resolution** message, increase the record length of the acquisition so that the oscilloscope has more points from which to calculate the measurement.

Selecting Automatic Measurements in the Time Domain

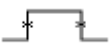

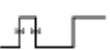
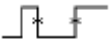



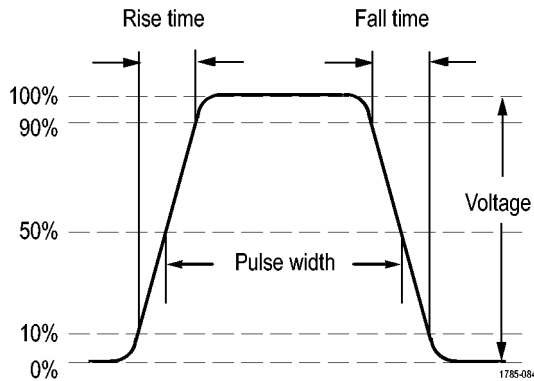

The following tables list each automatic measurement by category: time or amplitude. (See page 124, *Taking Automatic Measurements in the Time Domain*.)

Time measurements



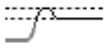

Measurement		Description
Frequency		The first cycle in a waveform or gated region. Frequency is the reciprocal of the period; it is measured in hertz (Hz) where one Hz is one cycle per second.
Period		The time required to complete the first cycle in a waveform or gated region. Period is the reciprocal of frequency and is measured in seconds.
Rise Time		The time required for the leading edge of the first pulse in the waveform or gated region to rise from the low reference value (default = 10%) to the high reference value (default = 90%) of the final value.
Fall Time		The time required for the falling edge of the first pulse in the waveform or gated region to fall from the high reference value (default = 90%) to the low reference value (default = 10%) of the final value.
Delay		The time between the mid reference (default 50%) amplitude point of two different waveforms. See also <i>Phase</i> .
Phase		The amount of time that one waveform leads or lags another waveform, expressed in degrees where 360° makes up one waveform cycle. See also <i>Delay</i> .
Positive Pulse Width		The distance (time) between the mid reference (default 50%) amplitude points of a positive pulse. The measurement is made on the first pulse in the waveform or gated region.
Negative Pulse Width		The distance (time) between the mid reference (default 50%) amplitude points of a negative pulse. The measurement is made on the first pulse in the waveform or gated region.
Positive Duty Cycle		The ratio of the positive pulse width to the signal period expressed as a percentage. The duty cycle is measured on the first cycle in the waveform or gated region.
Negative Duty Cycle		The ratio of the negative pulse width to the signal period expressed as a percentage. The duty cycle is measured on the first cycle in the waveform or gated region.
Burst Width		The duration of a burst (a series of transient events) and is measured over the entire waveform or gated region.



Amplitude measurements

Measurement		Description
Peak-to-peak		The absolute difference between the maximum and minimum amplitude in the entire waveform or gated region.
Amplitude		The high value less the low value measured over the entire waveform or gated region.
Max		The most positive peak voltage. Max is measured over the entire waveform or gated region.
Min		The most negative peak voltage. Min is measured over the entire waveform or gated region.
High		This value is used as 100% whenever high reference, mid reference, or low reference values are needed, such as in fall time or rise time measurements. Calculate using either the min/max or histogram method. The min/max method uses the maximum value found. The histogram method uses the most common value found above the midpoint. This value is measured over the entire waveform or gated region.
Low		This value is used as 0% whenever high reference, mid reference, or low reference values are needed, such as in fall time or rise time measurements. Calculate using either the min/max or histogram method. The min/max method uses the minimum value found. The histogram method uses the most common value found below the midpoint. This value is measured over the entire waveform or gated region.
Positive Overshoot		This is measured over the entire waveform or gated region and is expressed as: Positive Overshoot = (Maximum – High) / Amplitude x 100%.
Negative Overshoot		This is measured over the entire waveform or gated region and is expressed as: Negative Overshoot = (Low – Minimum) / Amplitude x 100%.
Total overshoot		This is the summation of the positive overshoot and the negative overshoot.





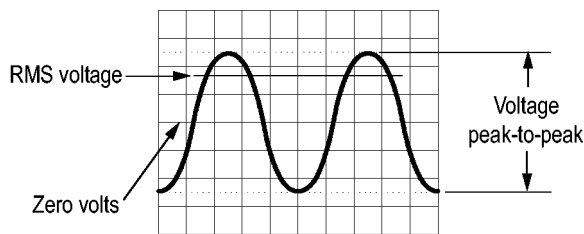

Amplitude measurements (cont.)

Measurement		Description
Mean		The arithmetic mean over the entire waveform or gated region.
Cycle Mean		The arithmetic mean over the first cycle in the waveform or the first cycle in the gated region.
RMS		The true Root Mean Square voltage over the entire waveform or gated region.
Cycle RMS		The true Root Mean Square voltage over the first cycle in the waveform or the first cycle in the gated region.



1785-083

Miscellaneous measurements

Measurement		Description
Positive Pulse Count		The number of positive pulses that rise above the mid reference crossing in the waveform or gated region.
Negative Pulse Count		The number of negative pulses that fall below the mid reference crossing in the waveform or gated region.
Rising Edge Count		The number of positive transitions from the low reference value to the high reference value in the waveform or gated region.
Falling Edge Count		The number of negative transitions from the high reference value to the low reference value in the waveform or gated region.
Area		Area measurement is a voltage over time measurement. It returns the area over the entire waveform or gated region in volt-seconds. Area measured above ground is positive; area measured below ground is negative.
Cycle Area		A voltage over time measurement. The measurement is the area over the first cycle in the waveform or the first cycle in the gated region expressed in volt-seconds. The area above the common reference point is positive, and the area below the common reference point is negative.

Histogram measurements

Measurement	Description
Waveform Count	Displays the number of waveforms that contributed to the histogram.
Hits in Box	Displays the number of samples within the histogram box or on its boundaries.
Peak Hits	Displays the number of samples in the bin that contains the most hits.
Median	Displays the middle histogram data value, where half of all histogram data points are less than this value and half are greater than this value.
Peak-to-peak	Displays the peak-to-peak value of the histogram. Vertical histograms display the voltage of the highest nonzero bin minus the voltage of the lowest nonzero bin. Horizontal histograms display the time of the right-most nonzero bin minus the time of the left-most nonzero bin.
Histogram Max	Displays the voltage of the highest nonzero bin in vertical histograms or the time of the right most nonzero bin in horizontal histograms.
Histogram Min	Displays the voltage of the lowest nonzero bin in vertical histograms or the time of the left most nonzero bin in horizontal histograms.
Histogram Mean	Measures the average of all histogram data points within or on the histogram box.
Standard Deviation	Measures the standard deviation (Root Mean Square (RMS) deviation) of all histogram data points within or on the histogram box.
Sigma1	Displays the percentage of the hits in the histogram that are within one standard deviation of the histogram mean.
Sigma2	Displays the percentage of the hits in the histogram that are within two standard deviations of the histogram mean.
Sigma3	Displays the percentage of the hits in the histogram that are within three standard deviations of the histogram mean.

Customizing an Automatic Measurement in the Time Domain

You can customize automatic measurements by using gating, modifying measurement statistics, adjusting the measurement reference levels, or taking a snapshot.

Gating

Gating confines the measurement to a certain portion of a waveform. To use:

1. Push **Measure**.



- 2. Push **More** as many times as needed to select **Gating** from the resulting pop-up menu.

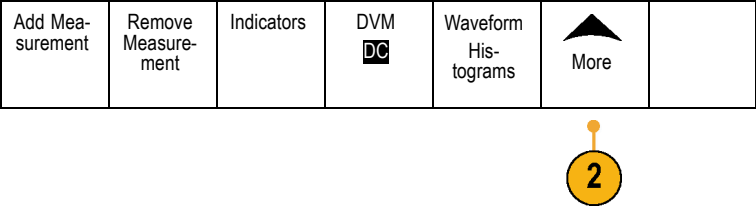

- 3. Position the gates using the side menu options.

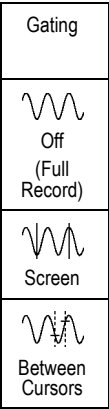

Statistics

Statistics characterize the stability of measurements. To adjust statistics:

- 1. Push **Measure**.



- 2. Push **More** as many times as needed to select **Statistics** from the resulting pop-up menu.

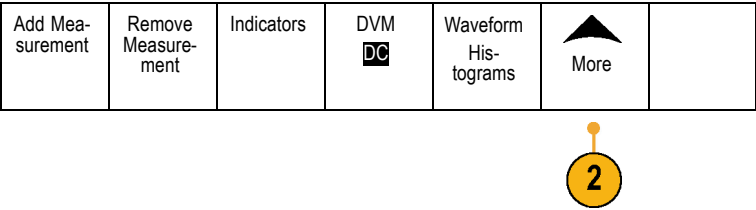

- Push the side menu options. These include whether to turn statistics on or off and how many samples to use for mean and standard deviation calculations.

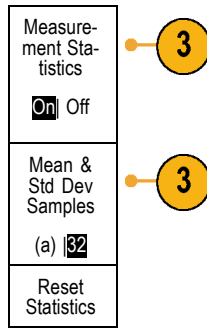

Snapshot

To see all the single-sourced measurements at one moment in time:

- Push **Measure**.



- Push **Add Measurement**.

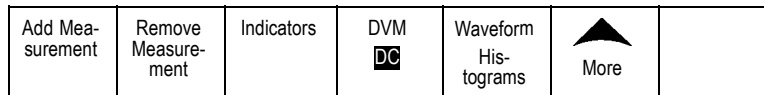

- Turn **Multipurpose a** to select the desired **Source** channel.

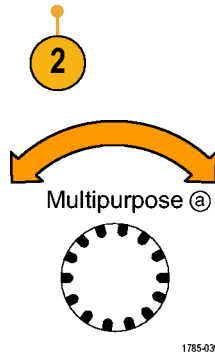

- Turn **Multipurpose b** to select the **Measurement Type** of Snapshot.

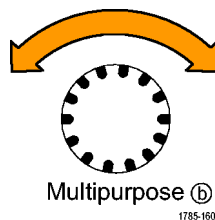

5. Push **OK Snapshot All Measurements**.

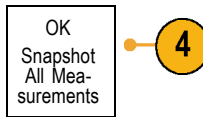

6. View results.

Snapshot on 1

Period	: 312.2µs	Freq	: 3.203 kHz
+Width	: 103.7µs	-Width	: 208.5µs
Burst W	: 936.5µs	Fall	1.144µs
Rise	: 1.452µs	±Over	: 14.286%
+Duty	: 33.23%	-Duty	: 66.77 %
+Over	: 7.143%	-Over	: 7.143 %
High	: 9.200 V	Low	: -7.600 V
Max	: 10.40 V	Min	: -8.800 V
Ampl	: 16.80 V	Pk-Pk	: 19.20 V
Mean	: -5.396 V	CycleMean	: -5.396 V
RMS	: 7.769 V	CycleRMS	: 8.206 V
Area	: -21.58 mVs	CycleArea	: -654.6µVs
+Edges	: 1	-Edges	: 0
+Pulses	: 2	-Pulses	: 2

Reference Levels

Reference levels determine how time-related measurements are taken. For example, they are used in calculating rise and fall times.

1. Push **Measure**.



2. Push **More** as many times as needed to select **Reference Levels** from the resulting pop-up menu.

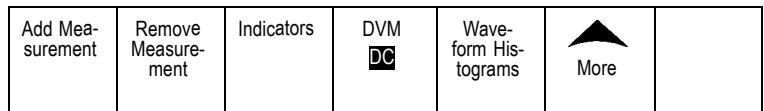

3. Set the levels using the side menu.

Use High and Low reference to calculate rise and fall times.

Use Mid reference primarily for measurements between edges such as pulse widths.

Reference Levels
Set Levels in % Units
High Ref (a) 90.0 %
Mid Ref 50.0 % 50.0 %
Low Ref 10.0 %
- Set to Defaults

Taking Automatic Measurements in the Frequency Domain

To take an automatic measurement in the frequency domain:

1. If the instrument is in the time domain, push **RF**.



2. Push **Measure**.



3. Push **Select Measurement**.

Select Measurement						
None						



- 4. Choose the measurement of interest from the side menu.

Channel power: The total power within the bandwidth, defined by the Channel Width.

Adjacent channel power ratio: The power in the main channel and the ratio of channel power to main power, for the upper and lower halves of each adjacent channel.

Occupied bandwidth: The bandwidth that contains the specified % of power within the analysis bandwidth.

Select Measurement
None
Channel Power
Adjacent Channel Power Ratio
Occupied Bandwidth

As you select each frequency measurement, on screen help will appear to explain the purpose of that measurement. A **Configure** item will appear on the lower menu. After you press **Configure** and set the measurement parameters in the resulting side menu, the oscilloscope will automatically set the span. When the RF measurements are on, the Auto detection method will set all frequency domain traces to the **Average** detection method. This provides optimal measurement accuracy.

Taking Digital Voltmeter Measurements

Use the digital voltmeter to measure the potential difference between two points in an electrical circuit.

- 1. Push channel 1 .



- 2. Push **Measure**.



- 3. Push the bottom-menu button labelled **DVM**.

Add Measurement	Remove Measurement	Indicators Off	DVM Off	Waveform Histograms	More	
-----------------	--------------------	-------------------	------------	---------------------	------	--



4. From the side menu, select the desired **Mode**, **Source** and **Display Style**.

Digital Voltmeter
Mode (a) <input checked="" type="radio"/> Off
Source (b) 1
Autorange Unavailable when Triggering on DVM Source
Display Style <input checked="" type="radio"/> Full Minimized
Reset DVM Statistics

View the finished results.

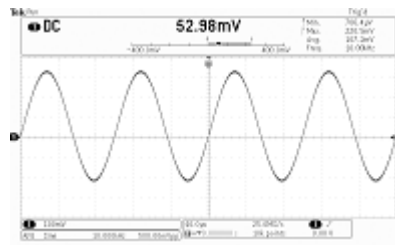

Taking Manual Measurements with Cursors

Cursors are on-screen markers that you position in the waveform display to take manual measurements on acquired data. They appear as horizontal and/or as vertical lines. To use cursors on analog or digital channels:

1. Push **Cursors** to turn cursors on.

NOTE. A second push turns cursors off. You can also push and hold **Cursors** to display the cursor menu.



In this example, two vertical cursors appear on the selected waveform. As you turn **Multipurpose a**, you move one cursor to the right or left. As you turn knob **Multipurpose b**, you move the other cursor.

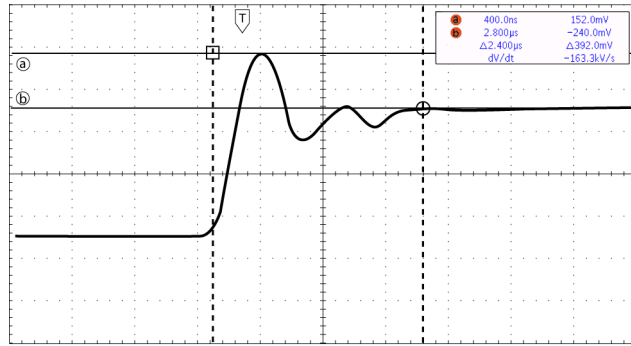

2. With cursors on, push **Select**.

This turns the cursor linking on and off. If linking is on, turning **Multipurpose a** moves the two cursors together. Turning **Multipurpose b** adjusts the time between the cursors.



3. Push **Fine** to toggle between a coarse and a fine adjustment for the **Multipurpose a** and **Multipurpose b** knobs.

Pushing **Fine** also changes the sensitivity of other knobs as well.



4. Push and hold **Cursors** to display the cursor menu.

5. Push **Cursors** on the lower menu to set the cursors to **Screen**.

In screen mode, two horizontal bars and two vertical bars span the graticule.

Cursors	Source	Bars	Linked	Bring	Cursor	
Waveform	Selected	Horizontal	On	Cursors	Units	
Screen	Waveform	Vertical	Off	On Screen		

6. Turn **Multipurpose a** and **Multipurpose b** to move the pair of horizontal cursors.

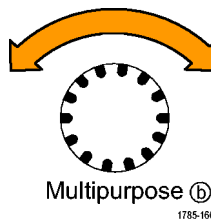
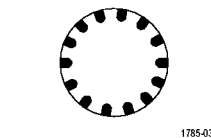
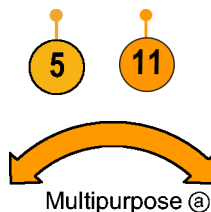

7. Push **Select**.

This makes the vertical cursors active and the horizontal cursors inactive. Now, as you turn the multipurpose knobs, the vertical cursors will move.

Push **Select** to make the horizontal cursors active again.



8. View the cursor and the cursor readout.

NOTE. On digital channels, you can take timing measurements with cursors, but not amplitude measurements.

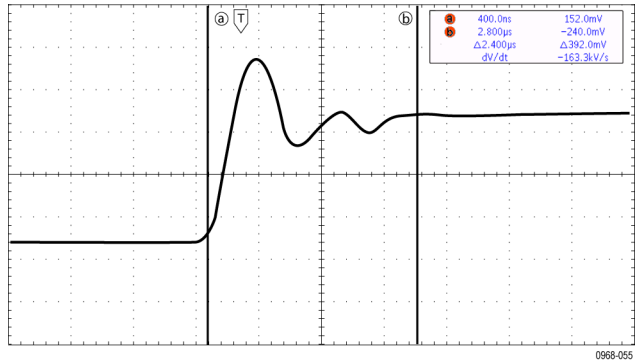

9. Display multiple waveforms on the screen by pushing one or more of the channel 1 through 4 buttons or by pushing the **D15 – D0** button.

10. Push and hold **Cursors** to display the cursor menu again.



11. Push **Source** on the lower menu.

A pop-up menu will appear. The default menu selection of **Selected Waveform** will cause the cursors to take measurements on the selected (last used) waveform.

12. Turn **Multipurpose a** to choose a channel to measure other than the one pointed to by **Selected Waveform**.

13. Push **Menu Off** to remove the pop-up menu.

14. Turn **Multipurpose a** and take cursor measurements on the alternate waveform.



15. Push **Cursors** again. This turns off the cursors. The screen no longer displays the cursors and the cursor readout.



Using Cursor Readouts

Cursor readouts supply textual and numeric information relating to the current cursor positions. The oscilloscope always shows the readouts when the cursors are turned on.

Readouts appear in the upper right corner of the graticule. If Zoom is on, the readout appears in the upper right corner of the zoom window.

When a bus is selected, the readout shows the decoded bus data in the format you have selected from the choices in the bus menu. When a digital channel is selected, the cursors show the values of all displayed digital channels.

NOTE. When serial or parallel buses are selected, the data value at that point is displayed in the cursor readout.

Δ Readout:

The Δ readouts indicate the difference between the cursor positions.

a	400.0ns	152.0mV
b	2.800 μ s	-240.0mV
	Δ 2.400 μ s	Δ 392.0mV
	dV/dt	-163.3kV/s

a Readout:

Indicates that the value is controlled by the **Multipurpose a** knob.

b Readout:

Indicates that the value is controlled by the **Multipurpose b** knob.

The horizontal cursor lines on the display measure the vertical parameters, typically voltage.



The vertical cursor lines on the display measure horizontal parameters, typically time.



The square and circle shapes in the readout map to the multipurpose knobs when both vertical and horizontal cursors are present.

Using XY Cursors

When the XY Display mode is on, the cursor readouts will appear to the right of the lower graticule (XY). They will include rectangular, polar, product, and ratio readouts. The oscilloscope will display vertical-bar waveform cursors in the upper graticule (YT).

Setting Up a Histogram

You can display a vertical (voltage) or horizontal (time) histogram. Use histogram measurements to get statistical measurement data for a section of a waveform along one axis. The sources for a histogram can be any of the four or two analog channels, a math waveform, or any of the four or two reference waveforms.

To Display a Histogram

1. Set up the oscilloscope to show the waveform on which to measure the histogram. Use **Autoset** if appropriate.



2. Push **Measure**.



3. Push **Waveform Histograms** on the lower menu.

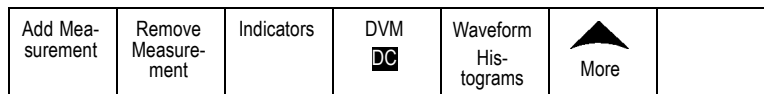

4. Push the top button on the side menu to select the waveform axis for which you want to show the histogram values: **Vertical** or **Horizontal**.
5. Push **Source** on the side menu and turn **Multipurpose a** to select the channel for which to display histogram measurements.
6. Push **Horiz. Limits** on the side menu and turn the **Multipurpose a** and **Multipurpose b** knobs to set the **L** (left) and **R** (right) boundaries of the histogram box.
7. Push **Vert. Limits** on the side menu and turn the **Multipurpose a** and **Multipurpose b** to set the **T** (top) and **B** (bottom) boundaries of the histogram box.
8. Push - more - 1 of 2.

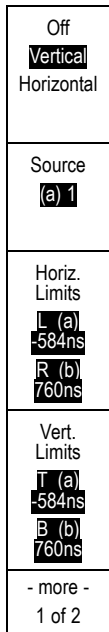

9. Push **Display** on the side menu and select **Linear** or **Log**.

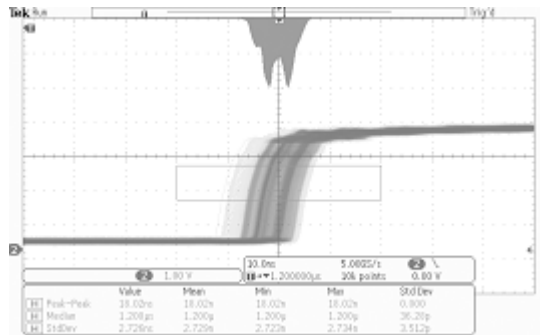
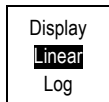

To Add Measurements on Histogram Data

1. Push **Add Measurement** on the lower menu to add measurements on the histogram data.

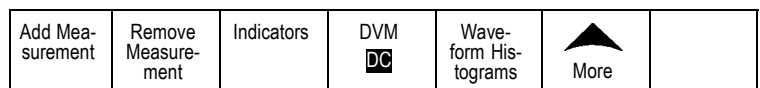

2. Push **Source** on the side menu and turn **Multipurpose a** to select **H** for histogram measurements.
3. Push **Measurement Type** on the side menu and turn **Multipurpose b** to select a histogram measurement.

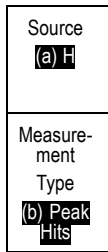

4. Push **OK Add Measurement** on the side menu to add the measurement to the measurement readout list.

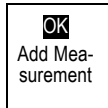

To Reset Histogram Measurements and Statistics

To reset the histogram measurements and statistics, follow these steps:

1. Push **Waveform Histograms** on the lower menu.

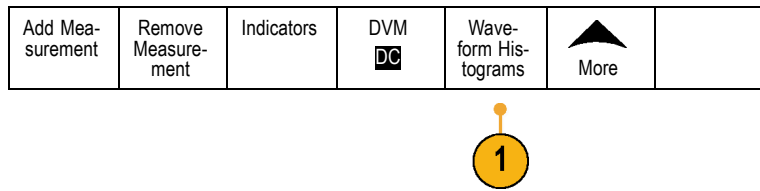

2. Push **- more - 1 of 2** on the side menu.

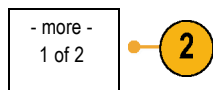

3. Push **Reset Histogram Counts** on the side menu.



4. Push **More** on the side menu.

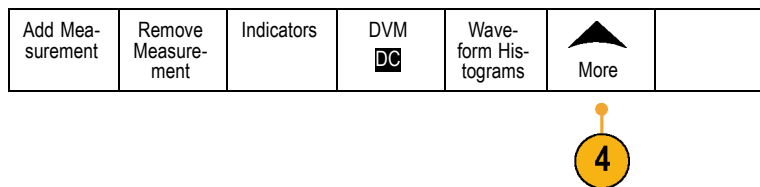

5. Push **Reset Statistics** on the side menu.

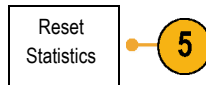

You can view the histogram at the top (for horizontal histograms) or the left edge (for vertical histograms) of the graticule.

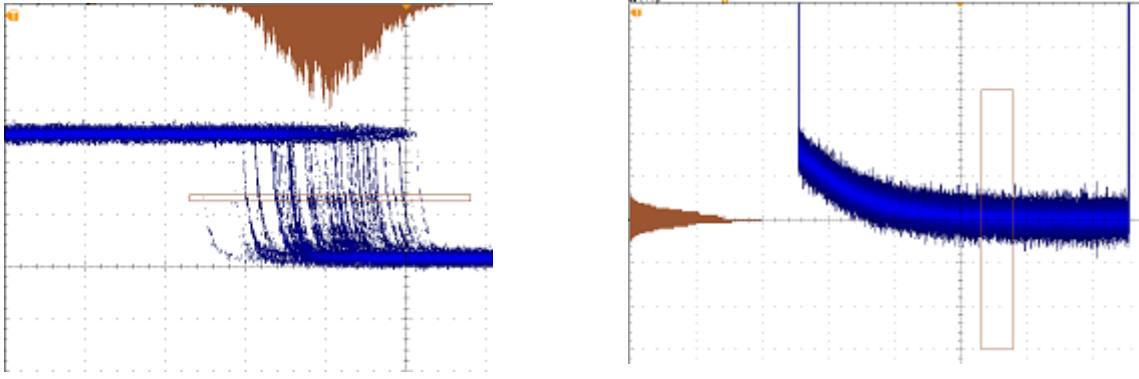

Quick Tips

- Use horizontal histograms to measure signal jitter.
- Use vertical histograms to measure signal noise.

Using Math Waveforms

Create math waveforms to support the analysis of your channel and reference waveforms. By combining and transforming source waveforms and other data into math waveforms, you can derive the data view that your application requires.

NOTE. Math waveforms are not available for use with serial buses.

NOTE. Math functions are available when the instrument is operating in time-domain mode.

Use the following procedure for executing simple (+, −, ×, ÷) math operations on two waveforms:

1. Push **Math**.



2. Push **Dual Wfm Math**.

Dual Wfm Math	FFT	Advanced Math	Spectrum Math	(M) Label		
---------------	-----	---------------	---------------	-----------	--	--



3. On the side menu, set the sources to either channel 1, 2, 3, 4, or reference waveforms R1, 2, 3, or 4. Choose the +, -, x, or ÷ operators.
4. For example, you might calculate power by multiplying a voltage waveform and a current waveform.

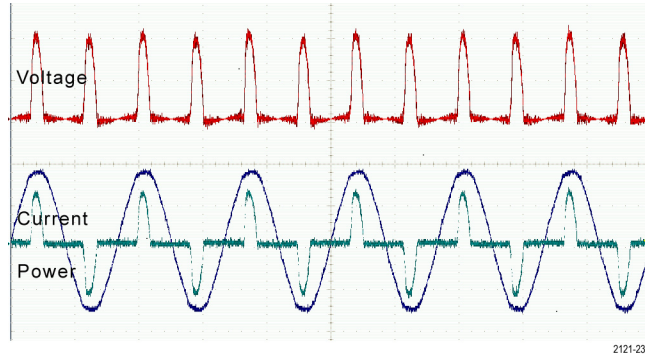

Quick Tips

- Math waveforms can be created from channel or reference waveforms or a combination of them.
- Measurements can be taken on math waveforms in the same way as on channel waveforms.
- Math waveforms derive their horizontal scale and position from the sources in their math expressions. Adjusting these controls for the source waveforms also adjusts the math waveform.
- You can zoom in on math waveforms using the inner knob of the Pan-Zoom control. Use the outer knob for positioning the zoomed area. (See page 149, *Using Wave Inspector to Manage Long Record Length Waveforms*.)

Using FFT

An FFT function breaks down signals into component frequencies, which the oscilloscope uses to display a graph of the frequency domain of a signal, as opposed to the oscilloscope's standard time domain graph. You can match these frequencies with known system frequencies, such as system clocks, oscillators, or power supplies.

1. Push **Math**.



2. Push **FFT**.

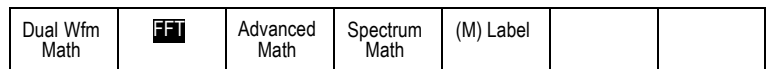

3. Push **FFT Source** on the side menu, if needed, and turn **Multipurpose a** to select the source to use. Choices are: channels 1, 2, (3, and 4 on four-channel models), reference waveforms R1, R2, (R3, and R4 on four-channel models).
4. Push **Vertical Scale** on the side menu repeatedly to select either Linear RMS or dBV RMS.
5. Push **Window** on the side menu repeatedly to select the desired window. Window choices are: Rectangular, Hamming, Hanning, and Blackman-Harris.
6. Push **Horizontal** on the side menu to activate the **Multipurpose a** and **Multipurpose b** knobs to pan and zoom the FFT display.

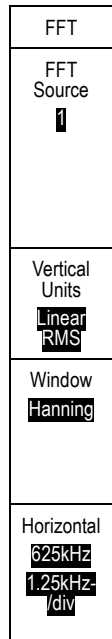

7. The FFT will appear on the display.

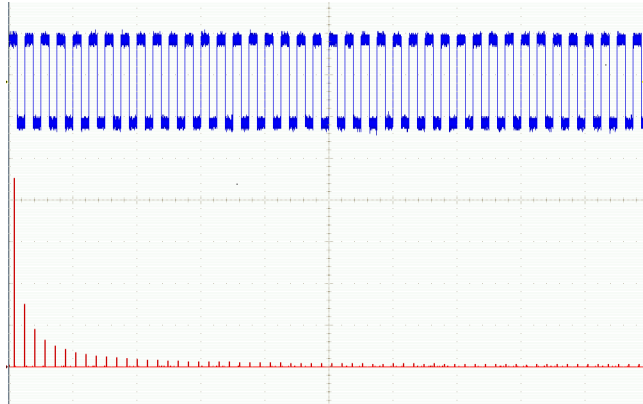

Quick Tips

- Use short record lengths for faster instrument response.
- Use long record lengths to lower the noise relative to the signal and increase the frequency resolution.
- If desired, use the zoom feature along with the horizontal **Position** and **Scale** controls to magnify and position the FFT waveform.
- Use the default dBV RMS scale to see a detailed view of multiple frequencies, even if they have very different amplitudes. Use the linear RMS scale to see an overall view of how all frequencies compare to each other.
- The math FFT feature provides four windows. Each offers a trade-off between frequency resolution and magnitude accuracy. The choice of which window to use depends upon what you want to measure and your source's signal characteristics. Use the following guidelines to select the best window:

Description

Window

Rectangular

The frequency resolution when using the Rectangular (a.k.a. boxcar or none) window is very good, the spectral leakage is high, and amplitude accuracy is poor.

Use the Rectangular window for measuring transients or bursts where the signal levels before and after the event are nearly equal. Also, use this window for equal-amplitude sine waves with frequencies that are very close together, and for broadband random noise with a relatively slow varying spectrum. This window is the best type for measuring the frequency spectrum of non-repetitive signals, and measuring frequency components near DC.



Hamming

The frequency resolution when using the Hamming window is good (slightly better than Hanning), the spectral leakage is moderate, and amplitude accuracy is fair.

Use the Hamming window for measuring sine, periodic, and narrow band random noise. This window works well on transients or bursts where the signal levels before and after the event are significantly different.



Description

Window

Hanning

The frequency resolution when using the Hanning (a.k.a. Hann) window is good, the spectral leakage is low and amplitude accuracy is fair. Use the Hanning window for measuring sine, periodic, and narrow band random noise. This window works well on transients or bursts where the signal levels before and after the event are significantly different.



Blackman-Harris

The frequency resolution when using the Blackman-Harris window is poor, the spectral leakage is very low and amplitude accuracy is good. Use the Blackman-Harris window for measuring predominantly single frequency waveforms to look for higher order harmonics, or several moderately or widely spaced sinusoidal signals.



Using Advanced Math

The advanced math feature lets you create a custom math waveform expression that can incorporate active and reference waveforms, measurements, and/or numeric constants. To use this feature:

- 1. Push **Math**.



- 2. Push **Advanced Math**.

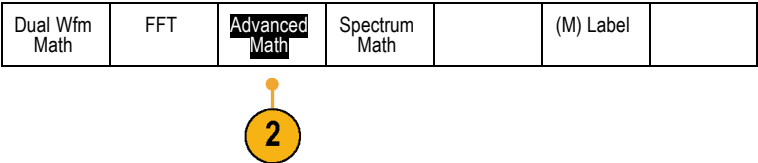

- 3. Use the side menu buttons to create custom expressions.

4. Push **Edit Expression** and use the multipurpose knobs and the resulting lower menu buttons to create an expression. When done, push **OK Accept**.

For example, to use **Edit Expression** to take the integral of a square wave:

1. Push **Clear** on the lower menu.
2. Turn **Multipurpose a** to select **Intg(**.
3. Push **Enter Selection**.
4. Turn **Multipurpose a** to select channel **1**.
5. Push **Enter Selection**.
6. Turn **Multipurpose a** to select **)**.
7. Push **OK Accept**.

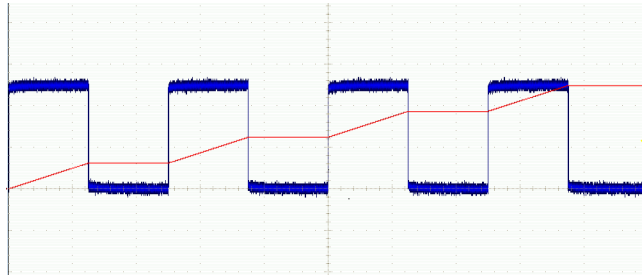

Using Spectrum Math

The spectrum math feature lets you create a math waveform by adding or subtracting frequency traces.

NOTE. *Spectrum Math is only available when the instrument is acquiring in Spectrum Analyzer mode.*

1. Push **Math**.



2. Push **Spectrum Math**. Use the side menu choices to construct your desired math trace.

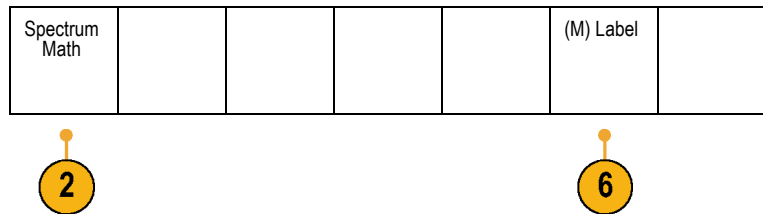

3. Push **1st Source** on the side menu and use the multipurpose knobs to adjust the vertical settings of the reference waveform or trace.
4. Choose **+** or **-** as the operator.
5. Choose the second source from the provided options.

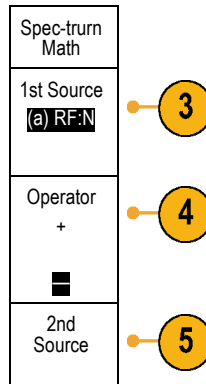

The math waveform will appear on the display as a red trace.

6. Push **Label** from the lower menu and use the resulting side menu choices to give your math trace an appropriate label.

NOTE. The oscilloscope will only complete the calculation if the units of measure of the source waveforms, when combined, make logical sense.

Using Reference Waveforms and Traces

Create and store a reference waveform or trace. For example, you might do this to set up a standard against which to compare other waveforms. To use the reference waveforms or traces:

NOTE. 10 M reference waveforms are volatile and not saved when the oscilloscope power is turned off. To keep these waveforms, save them to external storage.

1. Push **Ref R**. This brings up the lower reference menu.



2. Use the resulting lower menu selections to display or select a reference waveform or trace.

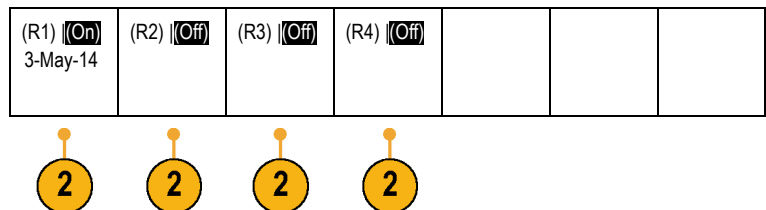

3. Push **Vertical** on the side menu and use the multipurpose knobs to adjust the vertical settings of the reference waveform or trace.
4. Push **Horizontal** on the side menu and use the multipurpose knobs to adjust the horizontal settings of the reference waveform or trace.
5. Push **Edit Label** and use the resulting menus to define labels to display with the reference waveforms and traces.
6. Pus **Ref Details** to read information about the selected reference. Use this to determine whether the reference is an analog waveform or an RF trace.
7. Push **Save to File** to store reference information in external storage.

R1	
Vertical	0.00 div 100 mV/div
Horizontal	0.00 s 4.00 μs/div
Edit Labels	
Ref Details	
Save to File	



Quick Tips

- **Selecting and Displaying Reference Waveforms.** You can display all the reference waveforms at the same time. Push the appropriate screen button to select a particular reference waveform.
- **Removing Reference Waveforms from the Display.** To remove a reference waveform from the display, push **R** on the front panel to access the lower menu. Then push the associated lower menu to turn it off.
- **Scaling and Positioning a Reference Waveform.** You can position and scale a reference waveform independently from all other displayed waveforms. Select the reference waveform and then adjust it with a multipurpose knob. You can do this whether acquisition is running or not.

If a reference waveform is selected, scaling and repositioning of the reference waveform operates the same way whether zoom is turned on or off.
- **Saving 10 M Reference Waveforms.** 10 M reference waveforms are volatile and not saved when the oscilloscope power is turned off. To keep these waveforms, save them to external storage.

Using Wave Inspector to Manage Long Record Length Waveforms

The Wave Inspector controls (zoom/pan, play/pause, marks, search) help you to efficiently work with long record length waveforms. To magnify a waveform horizontally, turn the Zoom knob. To scroll through a zoomed waveform, turn the Pan knob.

The Pan-Zoom Control consists of:

1. An outer pan knob
2. An inner zoom knob

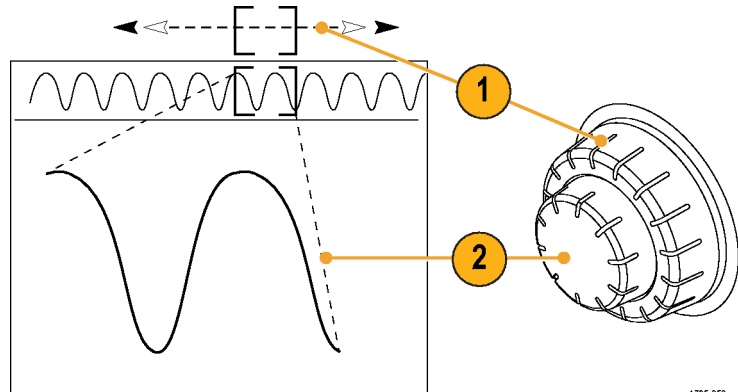

1785-053

Zooming a Waveform

To use zoom:

1. Rotate the inner knob on the Pan-Zoom control clockwise to zoom in on a selected portion of the waveform. Rotate the knob counterclockwise to zoom back out.

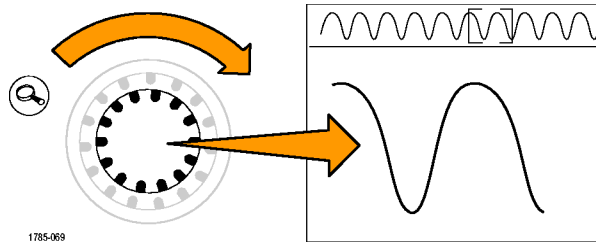

1785-069

2. Alternatively, enable or disable the zoom mode by pushing the zoom button.

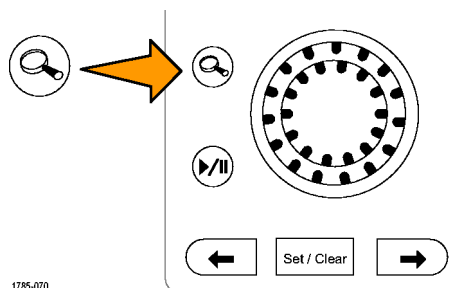

1785-070

3. Examine the zoomed view of the waveform that appears on the larger, lower portion of the display. The upper portion of the display will show the position and size of the zoomed portion in the waveform, within the context of the overall record.

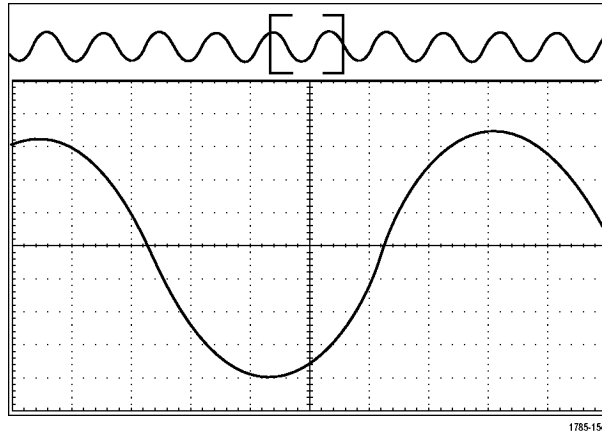

Panning a Waveform

While the zoom feature is on, you can use the pan feature to quickly scroll through the waveform. To use pan:

1. Rotate the pan (outer) knob of the pan-zoom controls to pan the waveform.
Turn the knob clockwise to pan forward. Turn it counterclockwise to pan backwards. The further you turn the knob, the faster the zoom window pans.

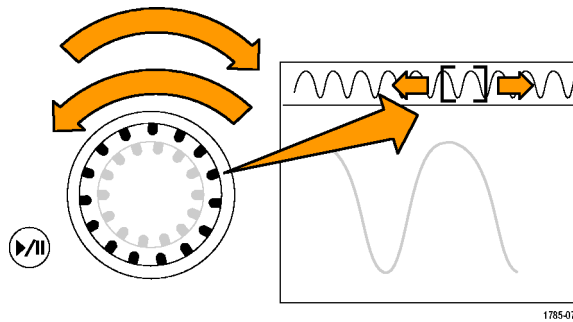

Playing and Pausing a Waveform

Use the play-pause feature to automatically pan through a waveform record. To use it:

1. Enable the play-pause mode by pushing the play-pause button.
2. Adjust the play speed by turning the pan (outer) knob further. The further you turn it, the faster it goes.

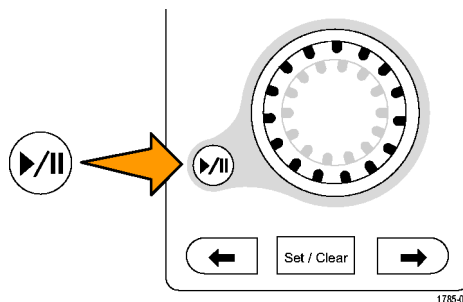

3. Change the play direction by reversing the direction that you are turning the pan knob.
4. During play, up to a point, the more you turn the ring, the faster the waveform accelerates. If you rotate the ring as far as it can go, the play speed does not change, but the zoom box quickly moves in that direction. Use this maximum rotation feature to replay a portion of the waveform that you just saw and want to see again.
5. Pause the play-pause feature by pushing the play-pause button again.

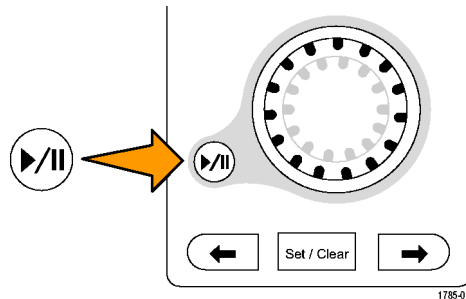

Searching and Marking Waveforms

You can mark locations of interest in the acquired waveform. These marks help you limit your analysis to particular regions of the waveform. You can mark areas of the waveform automatically, if they meet some special criteria, or you can manually mark each item of interest. You can use arrow keys to jump from mark to mark (area of interest to area of interest). You can automatically search and mark many of the same parameters that you can trigger on.

Search marks provide a way to mark a waveform region for reference. You can set marks automatically with search criteria. You can search for and mark regions with particular edges, pulse widths, runts, logic states, rise/fall times, setup and hold, and bus search types.

To manually set and clear (delete) marks:

1. Move (the zoom box) to the area on the waveform where you want to set (or clear) a search mark by turning the pan (outer) knob. Push the next (→) or previous (←) arrow button to jump to an existing mark.
2. Push **Set/Clear**.
If no search mark is at the screen center, the oscilloscope will add one.

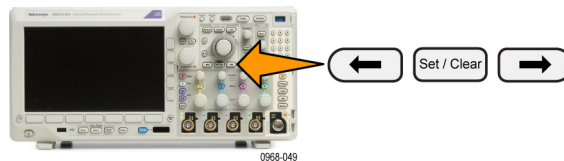

- Investigate your waveform by moving from search mark to search mark. Use the next (→) or previous (←) arrow button to jump from one marked location to another, without adjusting any other controls.
- Delete a mark. Push the next (→) or previous (←) arrow button to jump to the mark you want to clear. To remove the current, center-positioned mark, push **Set/Clear**. It works on both manually and automatically created marks.

To automatically set and clear (delete) search marks:

- Push **Search**.



- Select the search type desired from the lower menu.

Search Off	Search Type Edge	Source 1	Slope 			Threshold 0.00V
---------------	---------------------	-------------	-----------	--	--	--------------------

The search menu is similar to the trigger menu.



- From the side menu, turn on the search function.

If desired, go to the second page of the side menu and turn on the search mark table. The search mark table shows a time-stamped listing of each event.

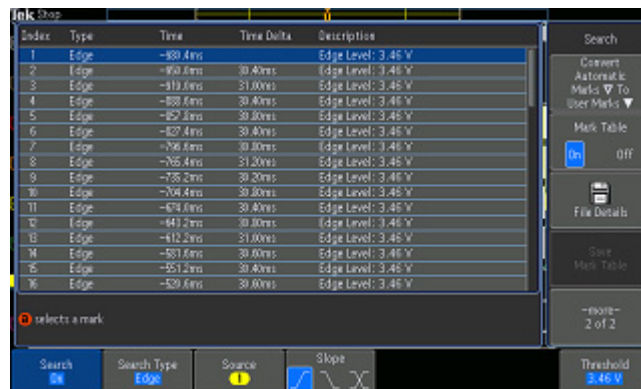

4. On the screen, hollow triangles show the location of automatic marks and solid triangles show the custom (user-defined) locations. These appear on both normal and zoomed waveform views.
5. You can quickly investigate your waveform by moving from search mark to search mark with the next (→) and previous (←) arrow buttons. No other adjustments are needed.

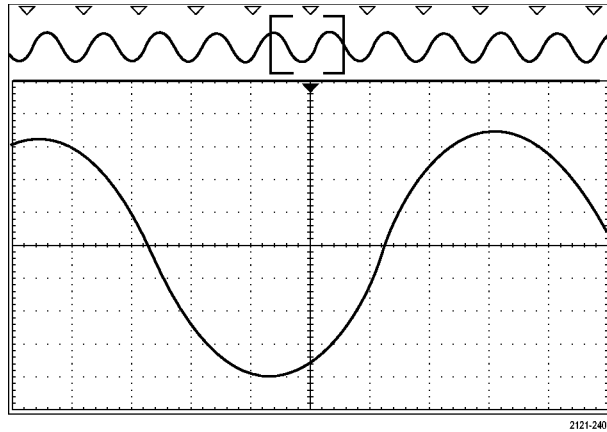

Quick tips.

- You can copy trigger settings to search for other locations in your acquired waveform that meet the trigger conditions.
- You can also copy search settings to your trigger.
- Custom (User) marks are saved with the waveform when the waveform is saved and when the setup is saved.
- Automatic search marks are not saved with the waveform when the waveform is saved. However, you can easily recapture them by reusing the search function.
- The search criteria are saved in the saved setup.

The Wave Inspector includes the following search capabilities:

Search	Description
Edge	Searches for edges (rising, falling or both) with a user-specified threshold level.
Pulse Width	Searches for positive or negative pulse widths that are >, <, =, or ≠ a user specified pulse width, or are inside or outside of a range.
Timeout	Searches for the lack of a pulse. The signal stays above or below (or either above or below) a set value for a set amount of time.
Runt	Searches for positive or negative pulses that cross one amplitude threshold but fail to cross a second threshold before crossing the first again. Search for all runt pulses or only those with a duration >, <, =, or ≠ a user specified time.
Logic	Search for a logic pattern (AND, OR, NAND, or NOR) across multiple waveforms with each input set to either High, Low, or Don't Care. Search for when the event goes true, goes false, or stays valid for >, <, =, or ≠ a user specified time. Additionally, you can define one of the inputs as a clock for synchronous (state) searches.
Setup & Hold	Search for violations of user specified Setup and Hold times.

Search	Description
Rise/Fall Time	Search for rising and/or falling edges that are >, <, =, or ≠ a user specified time.
Bus	Parallel: Search for a binary or hex value. I ² C: Search for Start, Repeated Start, Stop, Missing Ack, Address, Data, or Address and Data. SPI: Search for SS Active, MOSI, MISO, or MOSI & MISO RS-232, RS-422, RS-485, UART: Search for Tx Start Bit, Rx Start Bit, Tx End of Packet, Rx End of Packet, Tx Data, Rx Data, Tx Parity Error, Rx Parity Error. CAN, CAN FD: Search for Start of Frame, Type of Frame (Data, Remote, Error, Overload), Identifier (standard or extended), Data, Identifier and Data, End of Frame, Bit Stuffing Error, Missing Ack, FD BRS Bit, FD ESI Bit, Form Error, or Any Error ¹ LIN: Search for Synch, Identifier, Data, ID & Data, Wakeup Frame, Sleep Frame, Error FlexRay: Search for Start of Frame, Type of Frame, Identifier, Cycle Count, Header Fields, Data, ID & Data, End of Frame, Error Audio: Search for Word Select or Data USB: Search for Sync, Reset, Suspend, Resume, End of Packet, Token (Address) Packet, Data Packet, Handshake Packet, Special Packet, or Error MIL-STD-1553: Search for Sync, Command, Status, Data, Time (RT/IMG), Error ARINC429: Search for Word Start, Label, Data, Label and Data, Word End, or Error

¹ FD BRS Bit, FD ESI Bit, Form Error and Any Error are available only when CAN FD is selected as BUS.

Auto-magnify

As you adjust the horizontal scale control to faster time/division settings, the MDO3000 Series automatically increases the sample rate to keep acquiring the same record length in the shorter period of time. Eventually though, the MDO3000 Series hits its maximum sample rate. Once the instrument is at its fastest sample rate, further changes to faster timebase settings cause the oscilloscope to operate in Auto-magnify mode, where the oscilloscope shows the faster desired time/division setting and continues to acquire the desired record length. The result is that the oscilloscope cannot show all of the acquired points within the desired time/division setting.

Instead, the oscilloscope shows you only a portion of the entire record in the time-domain graticule. This feature provides you with a way to magnify a portion of the record without having to use the smaller zoom screen display. This feature gives you the maximum benefit of the sample rate / record length combination in your oscilloscope. With Auto-magnify, you have access to the full record length at the maximum sample rate.

NOTE. Auto-magnify only comes on when the zoom feature is turned off.

1. The entire acquisition is indicated by the horizontal bar in the upper display.
2. The portion of the acquisition shown in the time domain graticule is shown within the part of the upper display defined by the brackets.

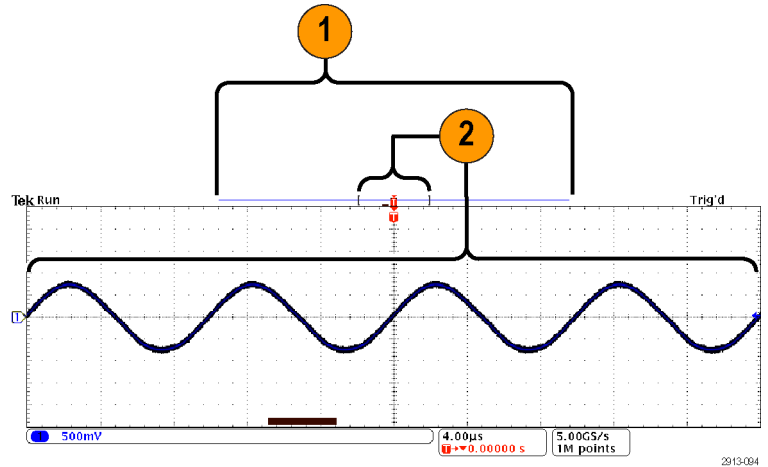

Limit and Mask Testing

Monitor an active input signal against a mask with the MDO3LMT Limit and Mask Test Module. Output pass or fail results. The results can show whether the input signal is within the user-defined vertical and horizontal bounds of the mask. You can create your own mask or recall a mask from a file. To set up and run a limit or mask test, do the following:

1. Select or create the mask.
2. Set up the test.
3. Run the test and view the results.

Create or Select the Mask

The two mask types you can create or select are: limit test and custom.

Create a limit test mask.

1. Push the front panel **Default Setup** button.



3249-008

2. Connect your probe from your oscilloscope to the mask source.

3. Push the front panel **Autoset** button.

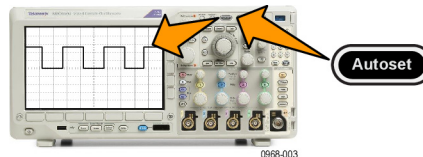

0968-003

4. Push the front panel **Test** button.



5. Push **Application** on the lower menu. Turn **Multipurpose a** to select **Limit/Mask Test** from the menu.
6. Push **Select Mask** on the lower menu and, from the resulting side menu, select **Limit Test**.
7. Push **Create Limit Mask** on the lower menu.

8. On the resulting side menu, push **Source Channel** and turn **Multipurpose a** to choose the waveform to use as the template for the limit test.
9. Push **Horizontal ±Limit** to set the mask horizontal limits. The units are referenced to graticule divisions, where one major division contains 1,000 milli-divisions (mdiv).
10. Push **Vertical ±Limit** to set the mask vertical limits. The units are referenced to graticule divisions, where one major division contains 1,000 millidivisions (mdov).
11. Push **OK Create Limit Mask** to make the mask in the oscilloscope.

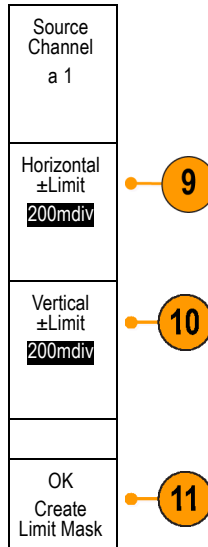

Create a custom mask. There are two ways to create a custom mask. You can load a mask from a text file or create a mask via a remote interface.

Create a custom mask from a text file.

1. Push the front panel **Test** button.
2. Push **Application** on the lower menu. Turn **Multipurpose a** to select **Limit/Mask Test** from the menu.
3. Push **Set Up Mask** on the lower menu.
4. From the resulting side menu, push **Recall Mask from File**.

Your mask text file should have an “.msk” file name extension and use the following format:

```

:REM "Initialize the custom mask"
:MASK:CUSTOM INIT
:REM "Mask Setup Information"
:MASK:USER:LABEL "Custom Mask of STS-1"
:MASK:USER:AMPLITUDE 1.0000
:MASK:USER:VSCALE 200.0000E-3
:MASK:USER:VPOS -2.5000
:MASK:USER:VOFFSET 0.0E+0
:MASK:USER:HSCALE 4.0000E-9
:MASK:USER:HTRIGPOS 318.1000E-3
:MASK:USER:WIDTH 29.5500E-9
:MASK:USER:RECORDLENGTH 1000
:MASK:USER:TRIGTOSAMP 7.2750E-9
:REM "Mask Points are Defined in volts and seconds"
:REM "Points in a segment must be defined in counter clockwise order"
:REM "A single point at 0,0 indicates an empty segment"
:MASK:USER:SEG1:POINTS -7.5000E-9,1.5000,-7.5000E-9,100.0000E-3,-5.1656E-
9,100.0000E-3,-1.3536E-9,500.0000E-3,-1.3536E-9,1.2000,7.2750E-9,1.1000,15.9036E-
9,1.2000,15.9036E-9,500.0000E-3,19.7156E-9,100.0000E-3,22.0500E-9,100.0000E-
3,22.0500E-9,1.5000
:MASK:USER:SEG2:POINTS -7.5000E-9,-500.0000E-3,22.0500E-9,-500.0000E-3,22.0500E-9,-
100.0000E-3,13.4214E-9,-200.0000E-3,13.4214E-9,500.0000E-3,11.6780E-9,800.0000E-
3,7.2750E-9,900.0000E-3,2.8720E-9,800.0000E-3,1.1286E-9,500.0000E-3,1.1286E-9,-
200.0000E-3,-7.5000E-9,-100.0000E-3
:MASK:USER:SEG3:POINTS 0.0E+0,0.0E+0
:MASK:USER:SEG4:POINTS 0.0E+0,0.0E+0
:MASK:USER:SEG5:POINTS 0.0E+0,0.0E+0
:MASK:USER:SEG6:POINTS 0.0E+0,0.0E+0
:MASK:USER:SEG7:POINTS 0.0E+0,0.0E+0
:MASK:USER:SEG8:POINTS 0.0E+0,0.0E+0

```

Create a custom mask via a remote interface. To use remote interface commands to create and edit a mask, see the MDO3000 Series Oscilloscope Programmer Manual.

Set Up the Test

To set up the limit or mask test, connect the test source to the oscilloscope. For a limit test, set the test source horizontal and vertical settings to the same values that were used to create the limit test mask. Push **Set Up Test** on the lower menu and set the following:

Setting	Description
Source Channel	Select the channel to be tested
Violation Threshold	Set the number of violations that can occur before a test status is considered failed.
Stop After Waveform	Set the test to stop after a set number of waveforms.
Stop After Time	Set the test to stop after a set amount of time elapses.

Setting	Description
Select Action on Failure	Set how the oscilloscope responds to test failure. You can set multiple actions. These are: Stop acquisition Save waveform to file Save screen image to file Print screen image Aux out pulse Set a remote interface service request (SRQ)
Select Action on Test Completion	Set how the oscilloscope will respond to test completion. You can set multiple actions. They are: Aux out pulse Set a remote interface service request (SRQ)
Pre-Test Delay	Set a delay before starting a test.
Repeat Test	Set On for the test to repeat when it has run the minimum number of waveforms or the minimum amount of time. Set Off for the test to run a single time and not repeat.
Mask Polarity	Set the mask polarity to use during the test. When Both is selected, the test will run with Normal polarity for about half of the expected number of waveforms or amount of time and then will run with Inverted polarity for the remained of the test.

Run the Test and View the Results

1. Push **Run Test** on the lower menu to start and stop the test.

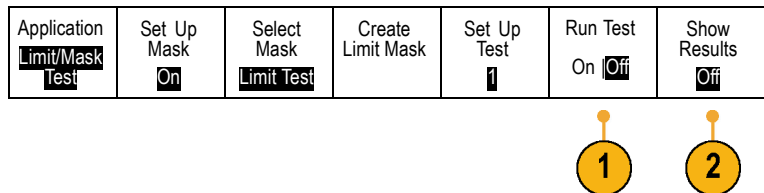

2. Push **Show Results** on the lower menu and use the resulting side menu to select whether to show basic or more detailed results. You can also reset the results.

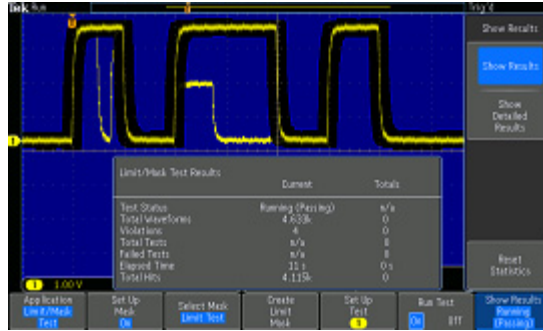

Quick Tips

- Use Average acquisition mode to create a smoother, cleaner limit test mask.
- If you want to re-use the mask later, save it to a file by selecting **Set Up Mask** from the lower menu and **Save Mask to File** from the resulting side menu.
- To simplify the setup of the test source, save the oscilloscope setup so that later you can quickly reload the settings to correctly display the test source for limit testing.
- Have the mask automatically re-scale with the source channel setting changes by selecting **Set Up Mask** on the lower menu and **Lock to Source** as **On** on the resulting side menu.
- The math waveform is not available when using mask testing.

Making Video Tests

Trigger on and display video signals. Do this with standard, built-in video test tools. To use this application:

1. Push **Test**.



2. Turn **Multipurpose a** to select **Video Picture**.

3. Use the bottom menu buttons to set up the desired video test.

Application Video Picture	Display On Off	Standard NTSC PAL	Contrast Automatic	Odd Even Interlaced	Source 1	Location
-------------------------------------	-----------------------------	--------------------------------	------------------------------	----------------------------------	-------------	----------

Choose among:

- Display on/off
- Standard: NTSC or PAL
- Contrast/update rate
- Odd/Even/Interlaced
- Source channel
- Location on the screen to display the results

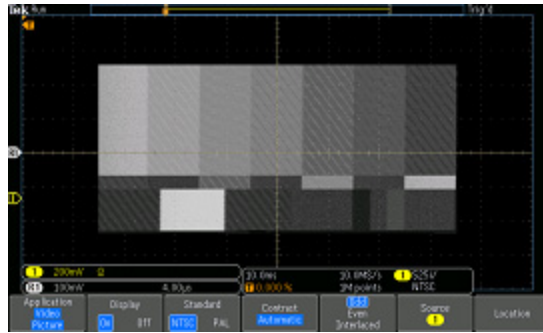

See a test pattern from a video generator



See an actual video picture

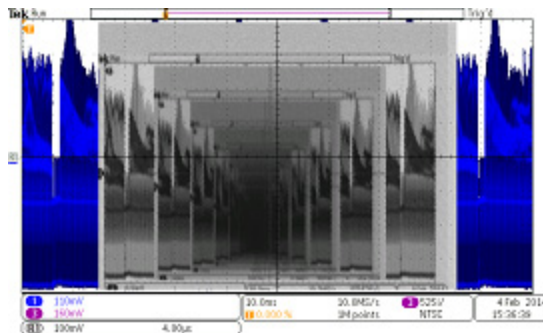

See a video of a video of a video ... signal by connecting a cable from the VIDEO OUT in the rear panel to an analog input channel in the front panel

Making Automated Power Measurements

Acquire, measure, and analyze power signals with the MDO3PWR Power Analysis Module. To use this application:

1. Push **Test**.



2. Turn **Multipurpose a** to select **Power Analysis**.

3. Push **Analysis**.

Application	Analysis					
	None					

2

4. Use the side menu buttons to select the desired analysis function.

Choose among:

- Power quality
- Switching loss
- Harmonics
- Ripple
- Modulation
- Safe operating area
- Deskew

See the *MDO3PWR*, *DPO3PWR* and *DPO4PWR Power Analysis Modules User Manual* for more information.

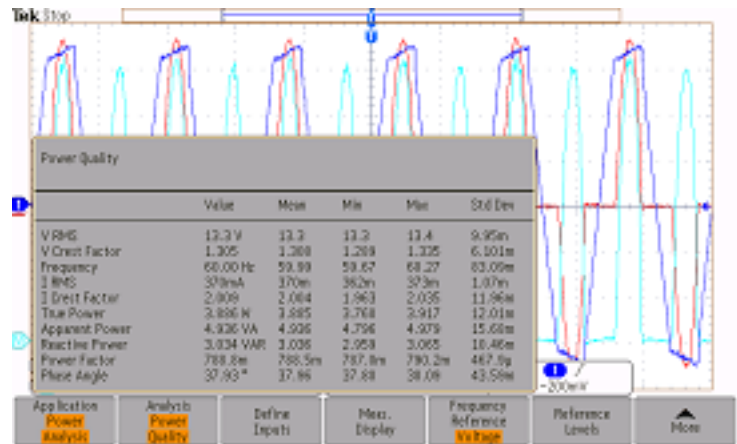

Save and Recall Information

The oscilloscope provides permanent storage for setups, waveforms, and screen images. Use the internal storage of the oscilloscope to save setup files and reference waveform data.

Use external storage, such as USB drives or network drives, to save setups, waveforms, and screen images. Use the external storage to carry data to remote computers for further analysis and for archiving.

External file structure. If you are saving information to external storage, select the appropriate menu (such as the **To File** side menu to save setups and waveforms) and turn **Multipurpose a** to scroll through the external file structure.

- E: is the USB memory device plugged into the USB port on the front of the oscilloscope
- F: is the USB memory device plugged into the USB port on the rear of the oscilloscope
- I through Z are network storage locations

Turn the **Multipurpose a** knob to scroll through the list of files. Push **Select** on the front panel to open and close folders.

Naming your file.

The oscilloscope gives all files it creates a default name in the following format:

- tekXXXXX.set for setup files where XXXXX is an integer from 00000 to 99999
- tekXXXXX.png, tekXXXXX.bmp, or tekXXXXX.tif for image files
- tekXXXXYYY.csv for spreadsheet files or tekXXXXYYY.isf for internal format files

For waveforms, the XXXX is an integer from 0000 to 9999. The YYY is the channel of the waveform, and can be one of the following:

- CH1, CH2, CH3, or CH4 for the analog channels
- D00, D01, D02, D03, and so on through D15 for the digital channels
- MTH for a math waveform
- RF1, RF2, RF3, or RF4 for reference memory waveforms
- ALL for a single spreadsheet file containing multiple channels when you select Save All Waveforms

For RF traces, XXXX is an integer from 0000 to 9999. The YYY defines the trace and can be one of the following:

- NRM for a normal trace
- AVG for an average trace
- MAX for a maximum hold trace

- MIN for a minimum hold trace
- TIQ for a baseband I & Q file

NOTE. Analog, digital, and RF waveforms and traces and those waveforms and traces derived from them (such as math and references) can be saved to an ISF file. When saving all channels in ISF format, a group of files will be saved. Each will have the same value for XXXX, but the YYY values will be set to the different channels that were turned on when the Save All Waveforms operation was performed.

The XXXX value will automatically increment each time you save a file of the same type. For example, the first time you save a file, that file is named tek00000. The next time you save the same type of file, the file will be named tek00001.

Editing file, directory, reference waveform, or instrument setup names. Give files descriptive names that you can recognize at a later date. To edit file names, directory names, reference waveform and instrument setup labels:

1. Push **Save / Recall Menu**.



2. Push **Save Screen Image, Save Waveform, or Save Setup**.

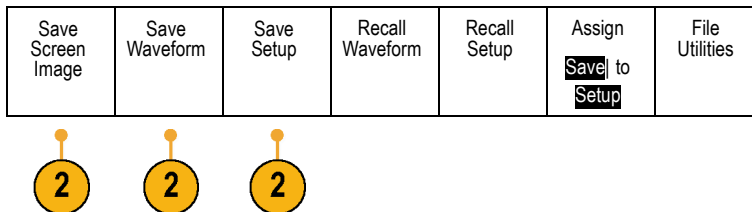

3. For waveform or setup files, enter the file manager by pushing the appropriate side menu button.

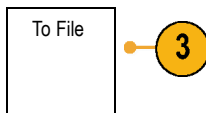

4. Turn **Multipurpose a** to scroll through the file structure. (See page 162, *External file structure*.)

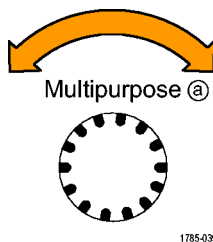

5. Push **Select** to open or close file folders.



6. Push **Edit File Name**.
 Edit the file name the same way you edit labels for channels. (See page 55, *Labeling Channels and Buses*.)
7. Push the **Menu Off** button to cancel the save operation, or push **OK Save** on the side menu to complete the operation.



Saving a Screen Image

A screen image consists of a graphical image of the oscilloscope screen. This is different from waveform data, which consists of numeric values for each point in the waveform. To save a screen image:

1. Push **Save / Recall Menu**.
 Do not yet push the **Save** button.



2. Push **Save Screen Image** on the lower menu.

Save Screen Image	Save Waveform	Save Setup	Recall Waveform	Recall Setup	Assign Save to Setup	File Utilities
-------------------	---------------	------------	-----------------	--------------	----------------------------	----------------



3. Push **File Format** on the side menu to select among: .tif, .bmp, and .png formats.
4. Push **Orientation** to select between saving the image in a landscape (horizontal) and a portrait (vertical) orientation.
5. Push **Ink Saver** to turn the **Ink Saver** mode on or off. When on, this mode provides a white background.
6. Push **Edit File Name** to create a custom name for the screen image file. Skip this step to use a default name.
7. Push **OK Save Screen Image** to write the image to the selected media.

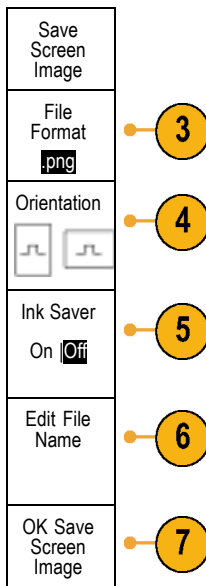

For information on printing screen images of waveforms, go to *Printing a Hard Copy*. (See page 172, *Printing a Hard Copy*.)

Saving and Recalling Waveform and Trace Data

Waveform and trace data consists of the numeric values for each point in the waveform or trace. It copies the data, as opposed to a graphical image of the screen. To save the current waveform or trace data or to recall previously stored waveform or trace data:

1. Push **Save / Recall Menu**.



2. Push **Save Waveform** or **Recall Waveform** on the lower menu.

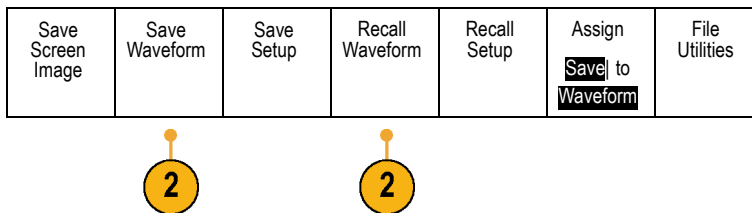

NOTE. The oscilloscope can save digital waveforms to .csv files, not reference memories. The oscilloscope cannot recall digital waveforms.

NOTE. The oscilloscope can save, but not recall, RF acquisitions as .TIQ files. You can use .TIQ files with Tektronix SignalVu Vector Signal Analysis software.

3. Turn the **Multipurpose a** knob and, on the side menu, select one of the displayed waveforms or traces. Alternatively, select **All Displayed Waveforms**.

When saving RF trace data, you can select to save it as either the standard display data or as baseband I and Q data (.TIQ files). Use the I and Q data with Tektronix SignalVu Vector Signal Analysis software.

4. Turn the **Multipurpose b** knob and select the location to save the waveform or trace data to or to recall it from.

Save the information externally to a file on a USB drive or mounted network drive. Alternatively, save the information internally to one of the four or two reference files.

5. Push **File Details** to save to a USB or network drive.



This brings up the file manager screen. Use it to navigate to the desired drive and folder, and optionally to specify the file name. Skip this step to use the default name and location.

Saving a waveform to file. When you push **File Details** on the side menu, the oscilloscope changes the side menu contents. The following table describes these side menu items for saving data to a mass storage file.

Side menu button	Description
Instrument Specific File Format (.ISF)	Sets the oscilloscope to save data from analog, digital, or RF channels (and math and reference waveforms derived, where possible, from those channels), in Instrument Specific Format (.isf) format. This format is the fastest to write. It also creates the smallest-sized file. Use this format if you intend to recall an analog waveform or RF trace to reference memory for viewing or measuring.
Spreadsheet file format (.csv)	Sets the oscilloscope to save data as a comma-separated data file that is compatible with popular spreadsheet programs. Analog and RF data stored in this file format can also be recalled to reference memory.

Saving a waveform or trace to reference memory. To save a waveform or trace to nonvolatile memory inside the oscilloscope, push the **Save Waveform** screen button, select the waveform that you want to save, and then select one of the reference waveform locations.

Saved waveforms contain only the most recent acquisition. Gray-scale information, if any, is not saved.

NOTE. 10 M reference waveforms are volatile and not saved when the oscilloscope power is turned off. To keep these waveforms, save them to external storage.

Displaying a reference waveform. To display a waveform stored in nonvolatile memory:

1. Push **Ref R**.



2. Push **R1**, **R2**, **RI** or **R4**.

If you push the side menu **Ref Details**, you can read whether the reference holds analog waveform or RF trace information.

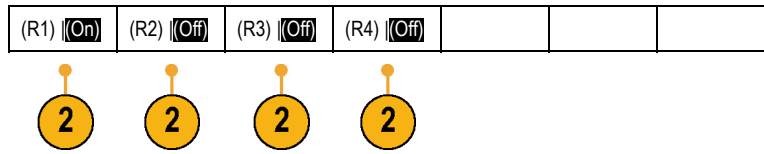

Removing a reference waveform from the display. To remove a reference waveform from the display:

1. Push **Ref R**.



2. Push **R1**, **R2**, **RI** or **R4** on the lower menu to remove the reference waveform or trace from the display.

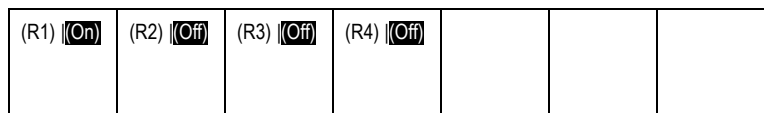

The reference waveform is still in nonvolatile memory and can be displayed again with another push of the button.

NOTE. 10 M reference waveforms are volatile and not saved when the oscilloscope power is turned off. To keep these waveforms, save them to external storage.

Saving and Recalling Setups

Setup information includes acquisition information, such as vertical, horizontal, trigger, cursor, and measurement information. It does not include communications information, such as GPIB addresses. To save the setup information:

1. Push **Save / Recall Menu**.



2. Push **Save Setup** or **Recall Setup** on the lower menu.

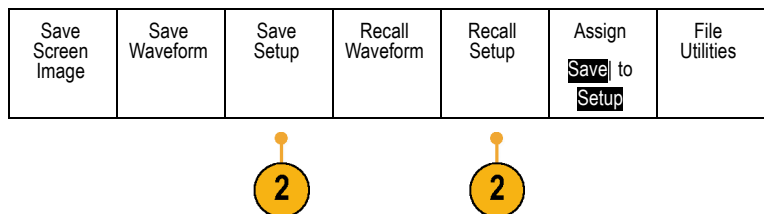

- From the resulting side menu, select the location to save the setup to or to recall it from.

To save setup information to one of the ten internal setup memories in the oscilloscope, push the appropriate side menu button.

To save setup information to a USB or network drive, push the **To File** button.

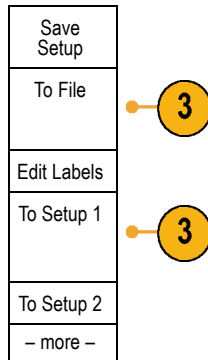

- If you are saving information to a USB or network drive, turn **Multipurpose a** to scroll through the file structure. (See page 162, *External file structure*.)

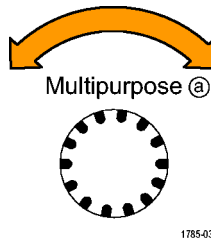

Push **Select** to open or close file folders.



Push the **Menu Off** button to cancel the save operation, or push **Save to Selected File** on the side menu to complete the operation.



5. Save the file.

Save to Selected File

Quick Tips

- **Recalling the Default Setup.** Push **Default Setup** on the front panel to initialize the oscilloscope to a known setup. (See page 57, *Using the Default Setup.*)

Saving with One Button Push

After you have defined the save/recall parameters with the Save/Recall Menu button and menu, you can save files with a single push of the **Save** button. For example, if you have defined the save operation to save waveform data to a USB flash drive, then each push of the **Save** button will save current waveform data to the defined USB flash drive.

1. To define the Save button behavior, push **Save/Recall Menu**.



2. Push **Assign Save to ...**

Save Screen Image	Save Waveform	Save Setup	Recall Waveform	Recall Setup	Assign Save to Setup	File Utilities
-------------------	---------------	------------	-----------------	--------------	----------------------	----------------



3. Push the side menu button corresponding to the items or items you wish to save when you push the **Save** button.

Assign Save to
Screen Image
Waveform
Setup
Image, Waveform, and Setup

4. From now on, when you push **Save** the oscilloscope will perform the action that you just specified rather than requiring you to navigate through the menus each time.



Managing Drives, Directories, and Files

You can manage drives, directories, and files from the oscilloscope user interface.

1. Push **Save/Recall Menu**.



2. Push **File Utilities**.

Save Screen Image	Save Waveform	Save Setup	Recall Waveform	Recall Setup	Assign Save to Setup	File Utilities
-------------------------	------------------	---------------	--------------------	-----------------	-------------------------------	-------------------

Select the desired file operation from the side menus. You can:

- Create a new folder
- Delete a highlighted directory, or file
- Copy a highlighted drive, directory or file
- Paste a previously copied drive, directory, or file
- Mount or unmount a networked drive
- Rename a highlighted drive, directory, or file
- Format a highlighted drive



Mounting a Network Drive

Mount a network storage device, such as a PC or a file server, to save setups, waveforms, and screen images directly to the drive or to recall waveforms or setups from the drive.

To save to or recall files from a network drive, you must first connect your oscilloscope to the network (See page 26, *Connecting Your Oscilloscope to a Computer*).

NOTE. Consult your network administrator for information related to your network.

After the network connection has been established, do the following:

1. Push **Save/Recall Menu** on the front panel.
2. Push **File Utilities** on the lower menu and, from the resulting side menu, select – **more** – **1 of 2**. Then select **Mount**.

3. From the resulting side menu, set the following:

Setting	Description
Drive Letter	Select from I: to Z:
Server Name or IP Address	Use a USB keyboard or the on-screen interface to enter the server name or IP address.
Path	Use a USB keyboard or the on-screen interface to enter the shared file path. For example, to mount an MS Windows PC directory named "C:\Example", enter "C\$\Example". The dollar sign enables sharing. No colon is needed.
User Name	If necessary, use a USB keyboard or the on-screen interface to enter the user name.
User Password	If necessary, use a USB keyboard or the on-screen interface to enter the user password. The oscilloscope only displays "*"s as you type the password. They are erased from the screen after OK Accept is pushed.

NOTE. Ensure that file sharing is enabled for the network location.

4. Push **OK Accept**.

NOTE. To unmount a network drive, push **Save/Recall Menu** on the front panel, push **File Utilities** on the lower menu, push **– more – 1 of 2** on the side menu, and **Unmount** items.

NOTE. Any network locations that were mounted when the oscilloscope was powered down will be automatically remounted when the oscilloscope is powered up. Unmount any network location that you do not want to automatically remount on power up.

Printing a Hard Copy

To print an image of what appears on the oscilloscope screen, do the following procedure.

Connect a Printer to Your Oscilloscope

Connect a non-PictBridge printer to a USB port on the rear or front panel of the oscilloscope. Alternatively, connect a PictBridge printer to the USB device port on the rear panel, or hook up a networked printer through the Ethernet port.

NOTE. Refer to the www.tektronix.com/printer_setup Web page for a list of compatible printers.

Set Up Print Parameters

To set up the oscilloscope to print hard copies:

1. Push **Utility**.



2. Push **Utility Page**.

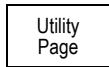

3. Turn **Multipurpose a** and select **Print Setup**.

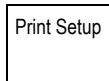

4. Push **Select Printer** if you are changing the default printer.

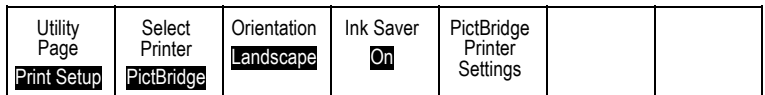

Turn **Multipurpose a** to scroll through the list of available printers.

Push **Select** to choose the desired printer.

To add a non-PictBridge USB printer to the list, plug the printer into a USB host port. The oscilloscope will automatically recognize most printers.

To set up a PictBridge USB printer, refer to the next topic.

To add an Ethernet printer to the list, refer to that topic. (See page 177, *E-mail Printing*.)

5. Select the image orientation (portrait or landscape).

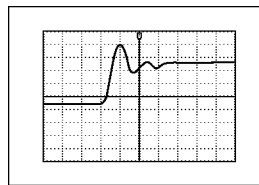

Landscape



Portrait

- Choose **Ink Saver On** or **Off**.
The **On** selection will print out a copy with a clear (white) background.

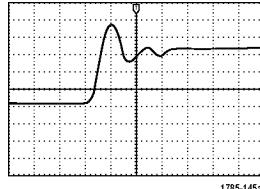

Ink Saver on

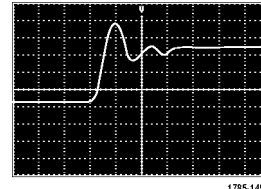

Ink Saver off

Printing to a PictBridge Printer

To set up the oscilloscope to print to a PictBridge printer:

- Push **Utility**.



- Push **Utility Page**.



- Turn **Multipurpose a** and select **I/O**.



- Push **USB**.

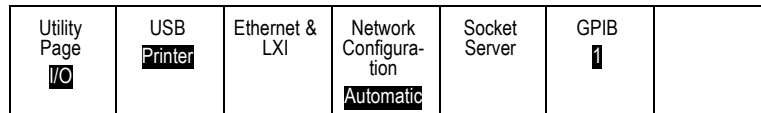

5. Push **Connect to PictBridge Printer**.

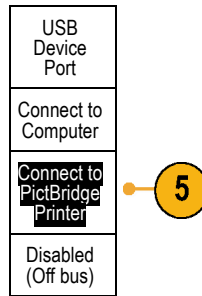

Printing Over Ethernet

To set up the oscilloscope to print over Ethernet:

1. Connect an Ethernet cable to the rear-panel Ethernet port.

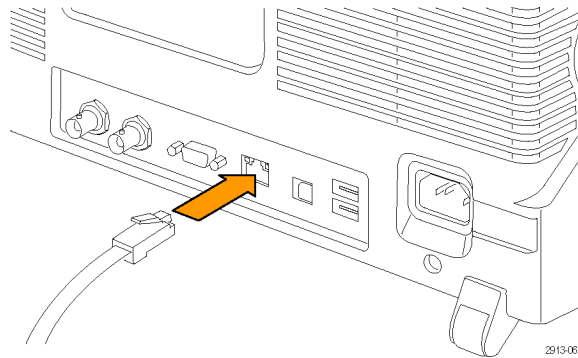

2. Push **Utility**.



3. Push **Utility Page**.



4. Turn the **Multipurpose a** knob and select **Print Setup**.

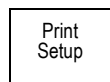

5. Push **Select Printer**.

Utility Page Print Setup	Select Printer (N/A)	Orientation Landscape	Ink Saver Off	PictBridge Printer Settings		
-----------------------------	-------------------------	--------------------------	------------------	--------------------------------	--	--

6. Push **Add Network Printer**.

Add Network Printer	6
Add E-mail printer	
Rename Printer	
Delete Network Printer	

7. Turn **Multipurpose a** to scroll through the list of letters, numbers, and other characters to find the first character in the printer name that you want to enter.

If you are using a USB keyboard, use the arrow keys to position the insertion point and type in the printer name. (See page 35, *Connecting a USB Keyboard to Your Oscilloscope*.)

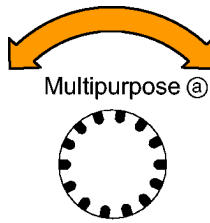

1785-039

ABCDEFGHIJKLMNOPQRSTUVWXYZ
 abcdefghijklmnopqrstuvwxyz
 0123456789_+~!@#%\$^&*()[]{}<>/~"'\|:;.,?`

8. Push **Select** or **Enter Character** to let the oscilloscope know that you have picked the proper character to use.



You can use the lower menu buttons to edit the name, as needed.

Enter Character		←	→	Back Space	Delete	Clear
-----------------	--	---	---	------------	--------	-------

9. Continue scrolling and pushing **Select** until you have entered all the desired characters.

10. Push the down arrow key to move the character cursor down a row to the **Server Name** field.
11. Turn the **Multipurpose a** knob and push **Select** or **Enter Character** as often as needed to enter the name.
12. If desired, push the down arrow key to move the character cursor down a row to the **Server IP Address:** field.

Add Printer
↑
↓
OK Accept

13. Turn **Multipurpose a** and push **Select** or **Enter Character** as often as needed to enter the name.
14. When done, push **OK Accept**.

NOTE. If you have multiple printers connected to the oscilloscope at the same time, the oscilloscope will print to the printer listed in the *Utility> Utility Page> Print Setup> Select Printer* menu item.

E-mail Printing

To set up the oscilloscope to print via e-mail to e-mail enabled printers:

1. Connect an Ethernet cable to the rear-panel Ethernet port.

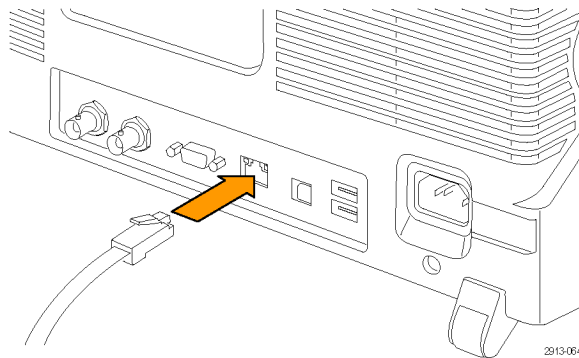

2. Push **Utility**.



3. Push **Utility Page**.

Utility Page



4. Turn **Multipurpose a** and select **Print Setup**.

Print Setup

5. Push **Select Printer**.

Utility Page Print Setup	Select Printer (N/A)	Orientation Landscape	Ink Saver Off	PictBridge Printer Settings		
-----------------------------	-------------------------	--------------------------	------------------	-----------------------------	--	--



6. Push **Add E-Mail Printer**.

Select Printer
Add Network Printer
Add E-mail printer
Rename Printer
Delete Printer



- 7. Turn **Multipurpose a** to scroll through the list of letters, numbers, and other characters to find the first character in the name that you want to enter.

If you are using a USB keyboard, use the arrow keys to position the insertion point and type in the printer name. (See page 35, *Connecting a USB Keyboard to Your Oscilloscope.*)

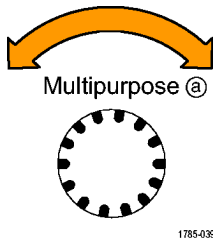

1785-039
 ABCDEFGHIJKLMNOPQRSTUVWXYZ
 abcdefghijklmnopqrstuvwxyz
 0123456789_=-!@#%&*()[]{}<>/~"'\:;.,?>

NOTE. There is a single set of SMTP server settings saved for both the e-mail printer and for **Act on Event** e-mail notification (**Test > Application > Act on Event > Actions > E-mail Notification > Configure E-mail**). If you modify the SMTP settings in one of these two locations, they will be similarly modified in the other location.

- 8. Push **Select** or **Enter Character** to let the oscilloscope know that you have picked the proper character to use.



You can use the lower menu buttons to edit the name, as needed.

Enter Character		←	→	Back Space	Delete	Clear
-----------------	--	---	---	------------	--------	-------

- 9. Continue scrolling and pushing **Select** until you have entered all the desired characters.

- 10. Push the down arrow key to move the character cursor down to more rows to fill out.

- 11. Turn the **Multipurpose a** knob and push **Select** or **Enter Character** as often as needed to enter the name.

- 12. If desired, push the down arrow key to move the character cursor down to added rows.

Add Printer
↑
↓
OK Accept

- 13. Turn **Multipurpose a** and push **Select** or **Enter Character** as often as needed to enter the name.

14. When done, push **OK Accept**.

Printing with One Button Push

Once you have connected a printer to your oscilloscope and set up print parameters, you can print current screen images with a single push of a button:

Push the printer icon button in the lower left corner of the front panel.



Using Oscilloscope Security Features

Erasing Oscilloscope Memory

The MDO3000 provides optional enhanced security to enable password protected control of turning on/off all instrument ports.

You can erase all setup and waveform information saved in the nonvolatile oscilloscope memory with the TekSecure function. If you have acquired confidential data on your oscilloscope, you may want to execute the TekSecure function before you return the oscilloscope to general use. The TekSecure function:

- Replaces all waveforms in all reference memories with null values
- Replaces the current front panel setup and all stored setups with the default setup
- Displays a confirmation or warning message, depending on whether the verification is successful or unsuccessful
- With the MDO3SEC option, you can also turn the I/O ports on or off and turn the firmware upgrade capability on or off.

To use TekSecure, without the MDO3SEC application module installed:

1. Push **Utility**.



2. Push **Utility Page**.



3. Turn the **Multipurpose a** knob and select **Security**.

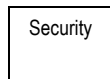

4. Push **TekSecure Erase Memory**.

Utility Page Security	TekSecure Erase Memory					
-----------------------------	------------------------------	--	--	--	--	--



5. Push **OK Erase Setup and Ref Memory** on the side menu.

This erases data in the oscilloscope's reference waveform and setup memory locations.

OK Erase Setup & Ref Memory



To cancel the procedure, push **Menu Off**.



0968-012

6. Power off the oscilloscope, and then power it back on to complete the process.

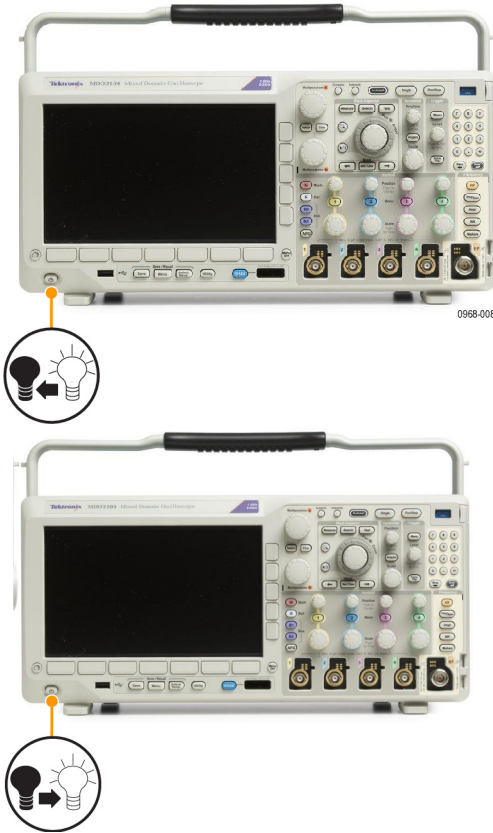

To use TekSecure, with the MDO3SEC application module installed:

1. Push **Utility**.



2. Push **Utility Page**.

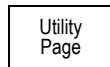

3. Turn the **Multipurpose a** knob and select **Security**.

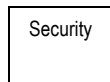

4. Push **TekSecure Erase Memory**.

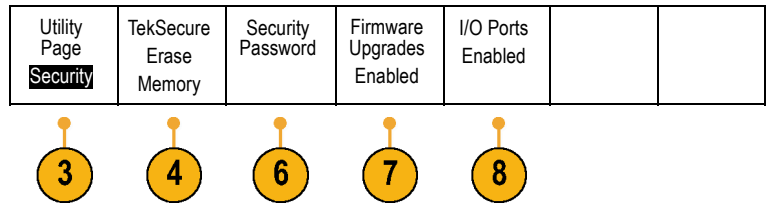

5. Push **OK Erase Setup and Ref Memory** on the side menu. As before, this erases data in the oscilloscope's reference waveform and setup memory locations.

OK Erase Setup & Ref Memory

6. Push **Security Password**. Use **Multipurpose a** and the bottom menu to enter a password.
7. Push **Firmware Upgrades**. Read the on-screen warnings. To disable the ability to load new firmware into the oscilloscope, on the resulting side menu, push **OK Disable Upgrades**.
8. Push **I/O Ports**. Read the on-screen warnings. To disable all USB and Ethernet ports on the oscilloscope, push **OK Disable All Ports** on the resulting side menu.

To cancel the procedure, push **Menu Off**.



9. Power off the oscilloscope, and then power it back on to complete the process.



Use the Arbitrary Function Generator

The MDO3000 contains an optional integrated arbitrary function generator (AFG) (option MDO3AFG). This is useful for simulating signals within a design or adding noise to signals to perform margin testing.

The function generator provides output of predefined waveforms up to 50 MHz. Choose between sine, square, pulse, ramp/triangle, DC, noise, $\sin(x)/x$ (Sinc), Gaussian, Lorentz, exponential rise/fall, Haversine and cardiac signals.

The AFG can generate up to 131,072 points of an arbitrary waveform. You can create the waveform from any of the four internal ARB memories, the four (or two) analog channels, the four (or two) reference waveforms, the math waveform or the 16 digital channel waveforms. You can also use a .CSV (spreadsheet) file stored externally or a predefined template.

You can modify your arbitrary waveform via an on-screen editor and then replicate it out of the generator. For more involved waveform manipulation, you can use Tektronix' ArbExpress PC-based waveform creation and editing software. It is available for free download from www.tektronix.com/software. Use version 3.1 or later with the MDO3000.

How to access the AFG

To access the AFG output, connect your cable to the port marked **AFG OUT** in the back of the oscilloscope.

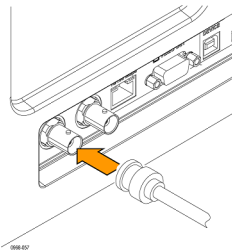

To see the output of the AFG, connect the other end of the cable to one of the input channels on the front of the oscilloscope.

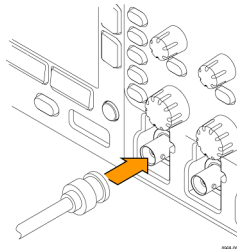

Push the front-panel **AFG** button to turn the AFG output on and off.

The button lights up when the output is on. The light goes out when it is off. The On-Off status is always off when you recall an instrument setup. The AFG will always come up in the off state when you turn the oscilloscope power on.



How to change the waveform type

1. Push the **AFG** button to bring up the AFG lower menu.



Waveform	Waveform Settings	Frequency	100.00kHz	Period	10.000μs	Output Settings
Sine		Amplitude	500.00mVpp	High	250.00mV	
		Offset	0.0000 V	Low	-250.00mV	



2. Push the **Waveform** button on the AFG lower menu and turn the **Multipurpose** a knob to select the waveform type.

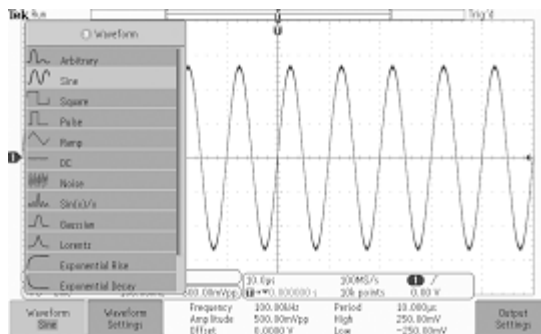

3. Push the **Waveform Settings** button on the AFG lower menu to set the frequency, period, amplitude, offset and the high and low levels of the desired waveform.
4. Push the **Output Settings** button on the lower menu to adjust the load impedance and amount of additive noise.

You can enable the AFG trigger pulse to come out of the rear-panel **AUX OUT** port. This is useful if you want an AUX OUT pulse that is synchronized to your AFG waveform block. To enable this feature, push **AFG > Output Settings > AUX OUT > AFG**.

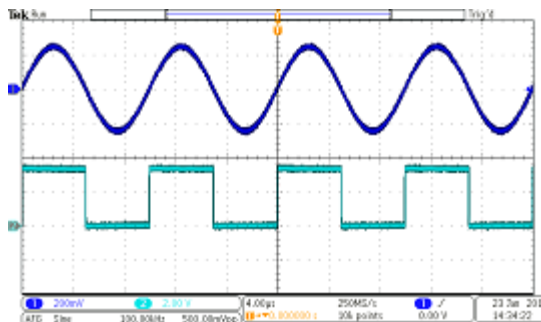

The channel 1 sine wave shows the output of the AFG. The channel 2 square wave show the output of the AFG sync pulse. It comes from the AUX OUT port.

Restrictions. When an output frequency is higher than 4.9 MHz, some restrictions exist. A divided frequency that is lower than 4.9 MHz is output from the AUX OUT port. The AFG trigger frequency will be limited as shown in the table to the right.

The output waveform (MHz) frequency setting.

- ≤ 4.9 MHz
- >4.9 MHz to 14.7 MHz
- >14.7 MHz to 24.5 MHz
- >24.5 MHz to 34.3 MHz
- >34.3 MHz to 44.1 MHz
- >44.1 MHz to 50 MHz

AFG trigger output frequency (MHz).

- Signal frequency
- Signal frequency / 3
- Signal frequency / 5
- Signal frequency / 7
- Signal frequency / 9
- Signal frequency / 11

How to create an arbitrary waveform

You can create the waveform from any of the four internal ARB memories, the four (or two) analog channels, the four (or two) reference waveforms, the math waveform or the 16 digital channel waveforms. You can also use a .CSV (spreadsheet) file stored externally or a predefined template (square, sine, ramp, pulse, or noise).

1. Push the **AFG** button to bring up the AFG lower menu.



2. On the lower-menu, push **Waveform** and turn **Multipurpose a** to select **Arbitrary** from the list of waveforms on the resulting pop-up menu.

Waveform Arbitrary	Waveform Settings	Waveform Edit	Freq. Ampl. Offset	100.00kHz 500.00m- Vpp 0.000 V	Period 10.000μV High 250.00mV Low -250. 00mV	Output Settings
------------------------------	----------------------	------------------	--------------------------	---	---	--------------------



3. Push **Waveform Settings** to set the frequency, period, amplitude, offset, and high and low levels.
4. Push **Waveform Edit** to bring up the Waveform Edit lower menu. This menu will let you manipulate existing waveform points, as well as to add and delete points, and to edit the voltage level.

For cases with many points to edit, consider using Tektronix ArbExpress software, which is available for free download from www.tektronix.com/software.

Also, use the Waveform Edit menu to create new arbitrary waveforms in the instrument. You can do this by loading them from files or from live channels.

If needed, push **AFG > Waveform Edit** to bring up the waveform edit lower menu.

5. Push **Edit Existing** to change, add, or delete points in a current waveform.

Edit Existing	Create New	Load Waveform	Freq. 100.00kHz Ampl. 500.00mVpp Offset 0.000 V	Period 10.000 μ s High 250.00mV Low -250.00mV	Save Waveform
---------------	------------	---------------	---	---	---------------



When you enable the internal editor, the screen splits into a smaller top window and a larger bottom window.

The smaller, top part of the screen becomes an overview, which shows the entire waveform memory. A box shows the zoomed-in portion of the waveform.

The larger, lower part becomes the zoomed-in view of the overview, as defined by the box in the top part of the screen. This lower part shows up to 500 points of the record.

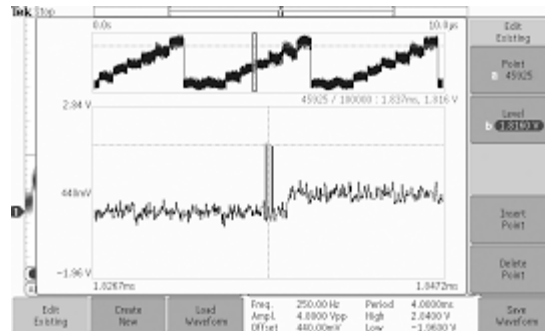

Turn the **Multipurpose a** knob to select a point to edit.

Turn the **Multipurpose b** knob to set the voltage level of that point. The voltage level is a function of the current amplitude and offset settings for the waveform.

Use the side menu items to add or remove points from the waveform.

6. Push **Create New** from the lower-menu to make a fresh arbitrary waveform.
On the resulting side menu, turn **Multipurpose a** or use the keypad to define the number of points in the waveform. Your waveform can have up to 131,072 points.
Turn **Multipurpose b** to choose the basic function. Choose between square, sine, ramp, pulse, and noise.
Push **OK Create** to build the new waveform.

7. Push the lower-menu button labeled **Load Waveform**. Turn **Multipurpose a** to choose which of your waveforms to display. Also, you can use the side menu to load a saved waveform from a file. When you have chosen the desired waveform, push **OK Load** from the side menu. Clear the menu by pushing **Menu Off** twice.

Be sure that you have a BNC cable connected from the AUX OUT port on the back to the channel 1 port on the front.

View your arbitrary waveform on the oscilloscope display.

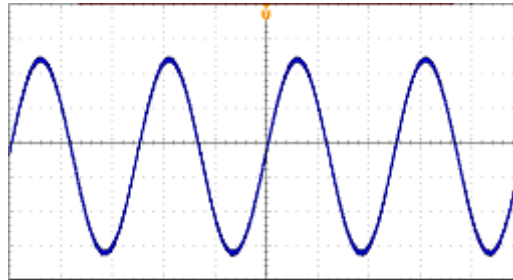

8. On the lower menu, push **Save Waveform**. Turn **Multipurpose a** to select which of the four slots to store your newly created waveform. Push **OK Save**. If you want, push **Edit Labels** and use **Multipurpose a** and the lower menu to assign a name to your new waveform. Clear the label menu by pushing **Menu off**.

Quick Tips

- You can save arbitrary waveforms in .CSV format. A .CSV file consists of sets of waveform point pairs (voltage, point number).
- You can load arbitrary waveforms from a variety of active time domain waveform sources: Channel 1 - 4, Ref 1 - 4, MATH, digital channels D0 - D15.
- The arbitrary waveform memory may be saved to and loaded from one of four arbitrary waveform memory locations. These may only be loaded to the active arbitrary waveform. You cannot save them to files or recall them directly to the arbitrary waveform memory locations.

NOTE. Loading from digital waveform sources will use the main waveform record. MagniVu records are not supported.

NOTE. Load impedance scales the vertical settings to show what the load would see based on the load impedance. Since the AFG is a 50 Ω source, for most accurate operation, set the load impedance to 50 Ω and set the input channel to 50 Ω .

NOTE. Noise range is reduced above 50% of the function Maximum Amplitude according to the function:

$\text{Noise Percent Maximum} = 100.0 * (\text{Maximum Amplitude} / \text{Amplitude} - 1.0)$

Use the Application Modules

Optional application module packages extend the capability of your oscilloscope. (See page 14, *Application Module Free Trial*.) (See page 14, *Installing an Application Module*.)

Refer to the *MDO3000 Series Application Module Installation Instructions* that came with your application module for instructions on installing and testing an application module. Some modules are described in the following list. Additional modules may be available. Contact your Tektronix representative or visit our Web site at www.tektronix.com for more information. Also, refer to *Contacting Tektronix* at the beginning of the manual.

You purchase application modules as stand-alone products. You can purchase them at the time of initial MDO3000 purchase or at a later time.

Application modules have licenses. You can transfer a license between an application module and an oscilloscope. The license may be contained in the module; allowing you to move the module from one instrument to another. Alternatively, you can contain the license in the oscilloscope; allowing you to remove the module and store it for safekeeping. You can transfer the license back to the module for use in another MDO3000 oscilloscope. Transferring the license to an oscilloscope and removing the module permits the use of more than two applications simultaneously.

- The **MDO3AERO Aerospace Serial Triggering and Analysis Module** enables triggering on packet-level information on ARINC429 and MIL-STD-1553 buses as well as use of analytical tools such as digital views of the signal, bus views, packet decoding, search tools, and packet decode tables with time-stamp information. Signal Inputs - Ch1 - Ch4, Math, Ref1 - Ref4. Recommended Probing - Differential or single ended (only one single-ended signal required)
- The **MDO3AUDIO Audio Serial Triggering and Analysis Module** enables triggering on packet-level information on I²S, LJ, RJ, and TDM audio buses as well as use of analytical tools such as digital views of the signal, bus views, packet decoding, search tools, and packet decode tables with time-stamp information. Signal Inputs - Any Ch1 - Ch4 and, with option MDO3MSO, any D0 - D15. Recommended Probing - Single ended.
- The **MDO3AUTO Automotive Serial Triggering and Analysis Module** enables triggering on packet-level information on CAN, CAN FD, and LIN buses as well as use of analytical tools such as digital views of the signal, bus views, packet decoding, search tools, and packet decode tables with time-stamp information. Signal Inputs – CAN, CAN FD, or LIN: Any Ch1 - Ch4 and, with option MDO3MSO, any D0 - D15. Recommended Probing - CAN, CAN FD: Single ended or differential; LIN: Single ended.
- The **MDO3COMP Computer Serial Triggering and Analysis Module** enables triggering on packet-level information on RS-232/422/485/UART buses as well as use of analytical tools such as digital views of the signal, bus views, packet decoding, search tools, and packet decode tables with time-stamp information. Signal Inputs - Any Ch1 - Ch4 and, with option MDO3MSO, any D0 - D15. Recommended Probing - RS-232/UART: Single ended; RS-422/485: Differential.
- The **MDO3EMBD Embedded Serial Triggering and Analysis Module** enables triggering on packet-level information on I²C and SPI buses as well as use of analytical tools such as digital views of the signal, bus views, packet decoding, search tools, and packet decode tables with timestamp information. Signal Inputs - I²C or SPI: Any Ch1 - Ch4 and, with option MDO3MSO, any D0 - D15. Recommended Probing - Single ended.
- The **MDO3FLEX Serial Triggering and Analysis Module** enables triggering on packet-level information on FlexRay buses as well as use of analytical tools such as digital views of the signal, bus views, packet decoding, search tools, packet decode tables with time-stamp information. Signal Inputs - Any Ch1 - Ch4 (and, with option MDO3MSO, any D0 - D15; single-ended probing only). Recommended Probing - Single ended or differential.
- The **MDO3LMT Limit and Mask Test Module** enables testing against limit templates generated from "golden" waveforms and mask testing using custom masks.

- The **MDO3PWR Power Analysis Module** enables quick and accurate analysis of power quality, switching loss, harmonics, safe operating area (SOA), modulation, ripple, and slew rate (dI/dt, dV/dt).
- The **MDO3USB USB 2.0 Serial Triggering and Analysis Module** enables triggering on packet-level content for low-speed, and full-speed USB serial buses. Also, enables use of analytical tools such as digital views of the signal, bus views, packet decoding, search tools, and packet decode tables with time-stamp information for low-speed, full-speed, and high-speed USB serial buses. Signal Inputs - Low-speed and Full-speed: Any Ch1 - Ch4, any D0 - D15 (with option MDO3MSO); Low-speed, Full-speed, and High-speed: Any Ch1 - Ch4, Math, Ref1 - Ref4. Recommended Probing - Low-speed and Full-speed: Single ended or differential; High-speed: Differential.

NOTE. 1 GHz bandwidth models are required for high-speed (HS) USB.

Appendix A: Warranted Specifications

√ Analog bandwidth, 50 Ω	The Analog Bandwidth when the instrument is DC-50 coupled and the Bandwidth Selection if “Full”. The limits stated below are for ambient temperature of ≤30 °C and the bandwidth selection set to FULL. Reduce the upper bandwidth frequency by 1% for each °C above 30 °C.				
	Bandwidth	10 mV/div to 1 V/div	5 mV/div to 9.98 mV/div	2 mV/div to 4.98 mV/div	1 mV/div to 1.99 mV/div
	1 GHz	DC to 1.00 GHz	DC to 500 MHz	DC to 300 MHz	DC to 150 MHz
	500 MHz	DC to 500 MHz		DC to 300 MHz	DC to 150 MHz
	350 MHz	DC to 350 MHz		DC to 300 MHz	DC to 150 MHz
	200 MHz	DC to 200 MHz			DC to 150 MHz
	100 MHz	DC to 100 MHz			
√ DC Balance	0.2 div with the input DC-50 Ω coupled and 50 Ω terminated 0.2 div with the input DC-75 Ω coupled and 75 Ω terminated 0.25 div at 2 mV/div with the input DC-50 Ω coupled and 50 Ω terminated 0.25 div at 2 mV/div with the input DC-75 Ω coupled and 75 Ω terminated 0.5 div at 1 mV/div with the input DC-50 Ω coupled and 50 Ω terminated 0.5 div at 1 mV/div with the input DC-75 Ω coupled and 75 Ω terminated 0.2 div with the input DC-1 MΩ coupled and 50 Ω terminated 0.3 div at 1 mV/div with the input DC-1 MΩ coupled and 50 Ω terminated All above specifications are increased by (0.01 divisions)/(°C) above 40 °C				
√ DC Gain accuracy	±2.5% for 1 mV/div, derated at 0.100%/°C above 30 °C ±2.0% for 2 mV/div, derated at 0.100%/°C above 30 °C ±1.5% for 5 mV/div and above, derated at 0.100%/°C above 30 °C ±3.0% variable gain, derated at 0.100%/°C above 30 °C				
√ DC Voltage Measurement Accuracy, Average Acquisition mode	Offset, position and the constant offset term must be converted to volts by multiplying by the appropriate volts/div term. The basic accuracy specification applies directly to any sample and to the following measurements; High, Low, Max, Min, Mean, Cycle Mean, RMS, and Cycle RMS. The delta volt accuracy specification applies to subtractive calculations involving two of these measurements. The delta volts (difference voltage) accuracy specification applies directly to the following measurements; Positive Overshoot, Negative Overshoot, Pk-Pk, and Amplitude. The limits are as follows:				
	Measurement Type	DC Accuracy in Volts			
	Average of > 16 waveforms	$\pm((\text{DC Gain Accuracy}) \times \text{reading} - (\text{offset} - \text{position}) + \text{Offset Accuracy} + 0.1 \text{ div})$			
	Delta Volts between any two averages of ≥16 waveforms acquired with the same scope setup and ambient conditions	$\pm(\text{DC Gain Accuracy} \times \text{reading} + 0.05 \text{ div})$			

√ Offset accuracy	$\pm[0.005 \times \text{offset} - \text{position} + \text{DC Balance}]$ <i>NOTE. Both the position and constant offset term must be converted to volts by multiplying by the appropriate volts/div term.</i>		
√ Long-term sample rate and delay time accuracy	±10 ppm over any ≥ 1 ms time interval		
√ Auxiliary output (AUX OUT)	Selectable Output: Main Trigger, Event, or AFG Main Trigger: HIGH to LOW transition indicates the trigger occurred. Event Out: The instrument will output a negative edge during a specified trigger event in a test application. A falling edge occurs when there is a specified event in a test application (i.e. the waveform crosses the violation threshold in the limit / mask test application). A rising edge occurs when the trigger system begins waiting for the next test application event. AFG: The trigger output signal from the AFG.		
	Characteristic	Limits	
	Vout (HI)	≥ 2.25 V open circuit; ≥ 0.9 V into a 50 Ω load to ground	
	Vout (LO)	≤ 0.7 V into a load of ≤ 4 mA; ≤0.25 V into a 50 Ω load to ground	
√ Random Noise, Sample acquisition mode	Instrument bandwidth (includes instruments with bandwidth upgrades)	Bandwidth Selection	RMS Noise
		1 GHz	Full bandwidth <(150 μV + 8% of Volts/div setting) 250 MHz bandwidth limit <(150 μV + 6% of Volts/div setting) 20 MHz bandwidth limit <(100 μV + 4% of Volts/div setting)
	500 MHz	Full bandwidth	<(150 μV + 8% of Volts/div setting)
		250 MHz bandwidth limit	<(150 μV + 6% of Volts/div setting)
		20 MHz bandwidth limit	<(100 μV + 4% of Volts/div setting)
	350 MHz	Full bandwidth	<(150 μV + 8% of V/div setting)
		250 MHz bandwidth limit	<(150 μV + 6% of V/div setting)
		20 MHz bandwidth limit	<(100 μV + 4% of V/div setting)
	200 MHz	Full bandwidth	<(150 μV + 6% of Volts/div setting)
		20 MHz bandwidth limit	<(100 μV + 4% of Volts/div setting)
	100 MHz	Full bandwidth	<(150 μV + 6% of Volts/div Setting)
		20 MHz bandwidth limit	<(100 μV + 4% of Volts/div Setting)

<p>√ Delta Time Measurement Accuracy</p>	<p>The formula to calculate delta-time measurement accuracy (DTA) for a given instrument setting and input signal is given below (assumes insignificant signal content above Nyquist)</p> <p>SR_1 = Slew Rate (1st Edge) around the 1st point in the measurement</p> <p>SR_2 = Slew Rate (2nd Edge) around the 2nd point in the measurement</p> <p>N = input-referred noise (volts_{rms}, Refer to the Random Noise, Sample acquisition mode specification)</p> <p>$t_{sr} = 1 /$ (Sample Rate)</p> <p>TBA = timebase accuracy (Refer to the Long-term sample rate and delay time accuracy specification)</p> <p>t_p = delta-time measurement duration (sec)</p> <p>$RD =$ (Record Length) / (Sample Rate)</p> $DTA_{PP} = \pm 5 \times \sqrt{2 \left(\frac{N}{SR_1} \right)^2 + 2 \left(\frac{N}{SR_2} \right)^2 + (5 ps + 1 E^{-6} \times RD)^2 + 2t_{sr} + TBA \times t_p}$ $DTA_{RMS} = \sqrt{2 \left(\frac{N}{SR_1} \right)^2 + 2 \left(\frac{N}{SR_2} \right)^2 + (5 ps + 1 E^{-6} \times RD)^2 + \left(\frac{2t_{sr}}{\sqrt{12}} \right) + TBA \times t_p}$ <p>Assumes that error due to aliasing is insignificant.</p> <p>The term under the square-root sign is the stability, and is due to TIE (Time Interval Error). The errors due to this term occur throughout a single-shot measurement. The second term is due to both the absolute center-frequency accuracy and the center-frequency stability of the timebase and varies between multiple single-shot measurements over the observation interval (the amount of time from the first single-shot measurement to the final single-shot measurement).</p>
<p>√ Threshold Accuracy, digital input</p>	<p>+/- [100 mV + 3% of threshold setting after calibration]</p> <p>Requires valid SPC.</p>

Table 1: RF Channel Characteristics

Characteristic	Description
<p>√ Phase Noise</p>	<p>10 kHz: < -81 dBc/Hz; (-85 dBc/Hz, typical)</p> <p>100 kHz: < -97 dBc/Hz; (-101 dBc/Hz, typical)</p> <p>1 MHz: < -118 dBc/Hz; (-122 dBc/Hz, typical)</p> <p>Phase Noise measured offset from 1 GHz CW signal.</p>
<p>√ Displayed Average Noise Level (DANL)</p>	<p>9 kHz to 50 kHz: < -109 dBm/Hz; (< -113 dBm/Hz, typical)</p> <p>50 kHz to 5 MHz: < -126 dBm/Hz; (-130 dBm/Hz, typical)</p> <p>5 MHz to 2 GHz: < -138 dBm/Hz; (< -142 dBm/Hz, typical)</p> <p>2 GHz to 3 GHz: < -128 dBm/Hz; (< -132 dBm/Hz, typical)</p>
<p>√ Level Measurement Uncertainty</p>	<p>< ±1.2 dB, < ±0.6 dB (typical), 18 °C - 28 °C temperature range</p> <p>< ±2.0 dB, -10 °C to +55 °C</p>

Table 1: RF Channel Characteristics (cont.)

Characteristic	Description
√ Spurious Response (SFDR)	<p>2nd harmonic distortion: >100 MHz, < -55 dBc 2nd harmonic distortion: > 100 MHz, < -60 dBc (typical) With auto settings on and signals 10 dB below reference level 2nd harmonic distortion: 9 kHz to 100 MHz, < -55 dBc 2nd harmonic distortion: 9 kHz to 100 MHz, < -60 dBc (typical) With auto settings on and signals 10 dB below reference level and reference level ≤ -15 dBm 3rd order harmonic distortion: >100 MHz < -53 dBc 3rd order harmonic distortion: >100 MHz < -58 dBc (typical) With auto settings on and signals 10 dB below reference level 3rd order harmonic distortion: 9 kHz to 100 MHz, < -55 dBc 3rd order harmonic distortion: 9 kHz to 100 MHz, < -60 dBc (typical) With auto settings on and signals 10 dB below reference level and reference level ≤ -15 dBm 2nd order intermodulation distortion: >100 Mhz, < -55 dBc 2nd order intermodulation distortion: >100 MHz, < -60 dBc (typical) With auto settings on and signals 10 dB below reference level 2nd order intermodulation distortion: 9 kHz to 15 MHz, < -55 dBc 2nd order intermodulation distortion: 9 kHz to 15 MHz, < -60 dBc (typical) With auto settings on and signals 10 dB below reference level and reference level ≤ -15 dBm 3rd order intermodulation distortion: >15 MHz, < -55 dBc 3rd order intermodulation distortion: >15 MHz < -60 dBc (typical) With auto settings on and signals 10 dB below reference level 3rd order intermodulation distortion: 9 kHz to 15 MHz, < -55 dBc 3rd order intermodulation distortion: 9 kHz to 15 MHz, < -60 dBc (typical) With auto settings on and signals 10 dB below reference level and reference level ≤ -15 dBm -45 dBc (-50 dBc, typical) for side bands < 25 kHz offset from the carrier</p>
√ Residual Spurious Response	<p>< -78 dBm < -67 dBm at 2.5 GHz < -76 dBm at 1.25 GHz ≤ -15 dBm reference level and RF input terminated with 50 Ω.</p>
√ Reference Frequency Error (Cumulative)	<p>Cumulative Error: ±10 x 10⁻⁶ Includes allowances for Aging per Year, Reference Frequency Calibration Accuracy, and Temperature Stability. Valid over the recommended 1 year calibration interval, from -10 °C to +55 °C .</p>

Table 2: Arbitrary Function Generator

Characteristic	Description
√ Sine and Ramp Frequency Accuracy	130 ppm (frequency ≤ 10 kHz); 50 ppm (frequency > 10 kHz)
√ Square and Pulse Frequency Accuracy	130 ppm (frequency ≤ 10 kHz); 50 ppm (frequency > 10 kHz)
√ Signal Amplitude Accuracy	+/- [(1.5% of peak-to-peak amplitude setting) + (1.5% of absolute DC offset setting) + 1 mV] (frequency = 1 kHz)
√ DC Offset Accuracy	+/- [(1.5% of absolute offset setting) + 1 mV] Add 3 mV of uncertainty per 10 °C change from 25 °C ambient

Table 3: DVM/Counter

Characteristic	Description
√ Voltage Accuracy	DC: +/- (2 mV + [(((4 * (Vertical Scale Voltage)) / (Absolute Input Voltage)) + 1)% of Absolute Input Voltage] + (0.5% of Absolute Offset Voltage)) AC: ±2% (40 Hz to 1 kHz) AC: +/-2% (20 Hz to 10 kHz) (typical) For AC measurements, the input channel vertical settings must allow the V _{pp} input signal to cover between 4 and 8 divisions.
√ Frequency Accuracy	10 ppm
√ Frequency Counter Maximum Input Frequency	100 MHz for 100 MHz models. 150 MHz for all other models.

Table 4: Interfaces, Input and Output Ports

Characteristic	Description
√ Auxiliary Output (Aux Out)	Selectable Output: Main Trigger, Event, or AFG Main Trigger: HIGH to LOW transition indicates the trigger occurred. Event Out: The instrument will output a negative edge during a specified trigger event in a test application. A falling edge occurs when there is a specified event in a test application (i.e. the waveform crosses the violation threshold in the limit / mask test application). A rising edge occurs when the trigger system begins waiting for the next test application event. AFG: The trigger output signal from the AFG.

Appendix B: TPP0250, TPP0500B and TPP1000: 250 MHz, 500 MHz and 1 GHz 10X Passive Probes Information

Operating Information

The TPP0250, TPP0500B and TPP1000 10X Passive Probes are compact passive probes with 10X attenuation that are designed for use with Tektronix MDO3000 Series oscilloscopes.

The probes have no user- or Tektronix-serviceable parts.

Connecting the Probe to the Oscilloscope

Connect the probe as shown in the illustrations below.

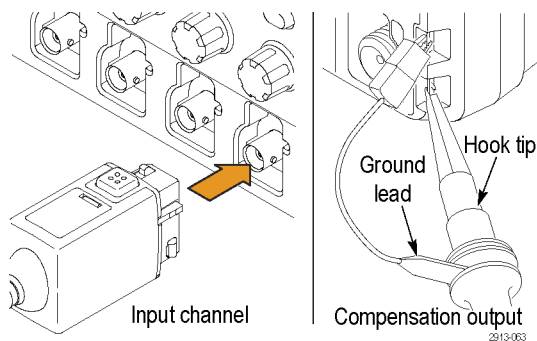

Compensating the Probe with MDO3000 Series Oscilloscopes

For information on compensating the probe, refer to the related section earlier in this manual.

(See page 11, *Compensating a TPP0250, TPP0500B or TPP1000 Passive Voltage Probe.*)



Standard Accessories

The standard accessories included with the probe are shown below.



WARNING. To avoid electric shock when using the probe or accessories, keep fingers behind the finger guard of probe body and accessories.

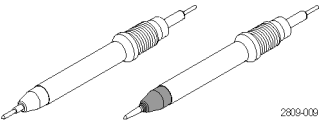

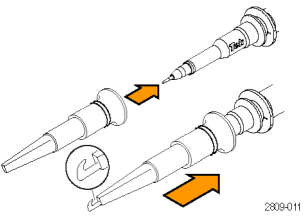
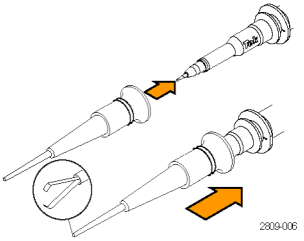
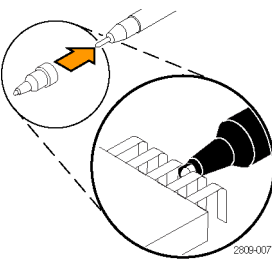
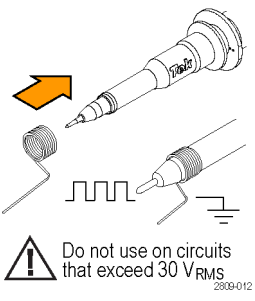

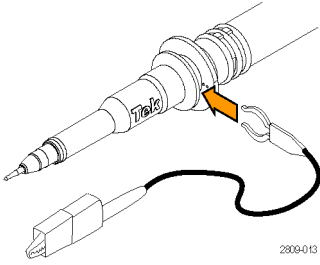
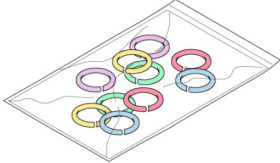
To reduce risk of shock, when using the probe on floating measurements, ensure the reference lead accessories are fully mated before connecting the probe to the circuit under test.

Item	Description
 <p>2809-009</p>	<p>Probe tips – pogo (white) and rigid (gray)</p> <p>The white pogo tip is pre-installed on the probe, and is spring-loaded for compliant testing of circuit boards. Reorder Tektronix part numbers:</p> <p>206-0610-xx (rigid tip) 206-0611-xx (pogo tip)</p>
 <p>2809-010</p>	<p>Insulator sleeve</p> <p>Unscrew this sleeve to replace the probe tips. (See procedure on next page).</p> <p>Reorder Tektronix part number 342-1194-xx</p>
 <p>2809-011</p>	<p>Hook tip</p> <p>Press the hook tip onto the probe tip and then clamp the hook onto the circuit.</p> <p>Rating: 300 V CAT II</p> <p>Reorder Tektronix part number 013-0362-xx</p>
 <p>2809-006</p>	<p>Micro hook tip</p> <p>Use this tip to access test points in tight spaces. Press the hook tip onto the probe tip and then extend the pincers around the circuit.</p> <p>Rating: 300 V CAT II</p> <p>Reorder Tektronix part number 013-0363-xx</p>
 <p>2809-007</p>	<p>Universal IC cap</p> <p>Use this cap to prevent shorting the probe tip between IC pins.</p> <p>Press the cap on the probe tip until it snaps on, and then spin the cap to expose the probe tip toward the IC lead.</p> <p>Reorder Tektronix part number 013-0366-xx</p>
 <p>2809-012</p> <p>Do not use on circuits that exceed 30 V_{RMS}</p>	<p>Ground springs</p> <p>To limit aberrations on high frequency signals caused by ground path inductance, bend the spring to reach nearby ground connections (<0.75 in, long; <0.25 in, short). Reorder Tektronix part numbers:</p> <p>016-2028-xx (long, 2 ea.) 016-2034-xx (short, 2 ea.)</p>

Item	Description
	<p>Ground lead, with alligator clip</p> <p>Secure the lead to the probe head ground and then to your circuit ground.</p> <p>Reorder Tektronix part number 196-3521-xx</p>
	<p>Color bands</p> <p>Use these bands to identify the oscilloscope channel at the probe head.</p> <p>Reorder Tektronix part number 016-0633-xx (5 pairs)</p>

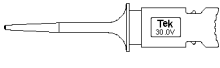
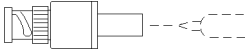
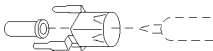
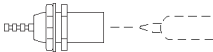
Optional Accessories

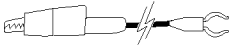
The accessories shown below are available for the probes and are rated ≤ 30 V unless indicated otherwise.

Accessory	Part number
MicroCKT Test Tip One ships with each oscilloscopes	 206-0569-xx
BNC to Tip Adapter, Underterminated	 013-0367-xx
Circuit Board Test Point/PCB Adapter	 016-2016-xx
Chassis-Mount Probe Test Jack	 131-4210-xx
6" Clip-on Ground Lead One ships with each oscilloscopes	 196-3198-xx
12" Alligator Ground Lead One ships with each oscilloscopes	 196-3512-xx
Wire, spool, 32 AWG One ships with each oscilloscopes	 020-3045-xx

Replacing the Probe Tip

Order Tektronix part number 206-0610-xx for rigid tip replacement, or order part number 206-0611-xx for pogo pin replacement.

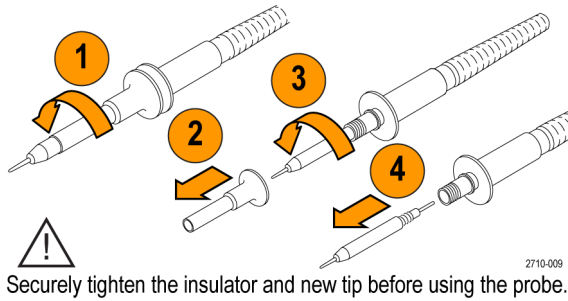

Specifications

Table 5: Electrical and mechanical specifications

Characteristic	TPP0250	TPP0500B	TPP1000
Bandwidth (-3 dB)	250 MHz	500 MHz	1 GHz
System rise time (typical)	<1.4 ns	<700 ps	<450 ps
System input capacitance	Rigid tip: 3.9 pF ±0.3 pF Pogo pin tip: 5.1 pf ±0.5 pF		
System attenuation accuracy	10:1 ±2.2%		
Probe series resistance @DC	9.75 MΩ ±0.5%		
System input resistance @DC	10 MΩ ±2%		
Propagation delay	~5.67 ns		
Maximum input voltage	300 V _{RMS} CAT II		
Cable length	1.3 m, ±3 cm		

Performance Graphs

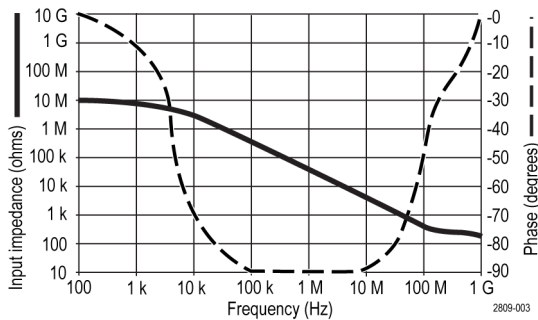

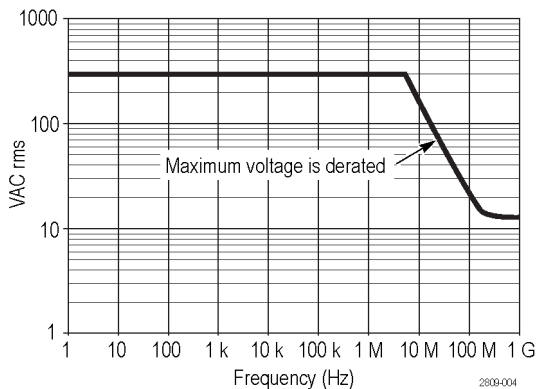

Refer to the reference lead derating curve above when making floating measurements.

Table 6: Environmental specifications

Characteristics	Description
Temperature	
Operating	-15 °C to +65 °C (+5 °F to +149 °F)
Nonoperating	-62 °C to +85 °C (-80 °F to +185 °F)
Humidity	
Operating	5% to 95% relative humidity (%RH) up to +30 °C, 5% to 75% RH above +30 °C up to +65 °C. Noncondensing
Nonoperating	5% to 45% RH above +65 °C up to +85 °C. Noncondensing
Altitude	
Operating	3.0 km (9,842 ft) maximum
Nonoperating	12.2 km (40,000 ft) maximum

Table 7: Certifications and compliances

Characteristics	Description								
EC Declaration of Conformity	Compliance was demonstrated to the following specification as listed in the Official Journal of the European Communities: Low Voltage Directive 2006/95/EC: EN61010-031: 2002								
Measurement Category Descriptions	<table border="1"> <thead> <tr> <th>Category</th> <th>Examples of Products in this Category</th> </tr> </thead> <tbody> <tr> <td>CAT III</td> <td>Distribution-level mains, fixed installation</td> </tr> <tr> <td>CAT II</td> <td>Local-level mains, appliances, portable equipment</td> </tr> <tr> <td>CAT I</td> <td>Circuits not directly connected to mains.</td> </tr> </tbody> </table>	Category	Examples of Products in this Category	CAT III	Distribution-level mains, fixed installation	CAT II	Local-level mains, appliances, portable equipment	CAT I	Circuits not directly connected to mains.
Category	Examples of Products in this Category								
CAT III	Distribution-level mains, fixed installation								
CAT II	Local-level mains, appliances, portable equipment								
CAT I	Circuits not directly connected to mains.								
Pollution Degree 2	Do not operate in environments where conductive pollutants may be present (as defined in IEC 61010-1). Rated for indoor use only.								
Additional Safety Standards	UL61010B-1, First Edition & UL61010B-2-031, First Edition. CAN/CSA-C22.2 No. 1010.1-92, & CAN/CSA-C22.2 No. 1010.2.031-94 IEC61010-031:2002								



Equipment Recycling. This product complies with the European Union's requirements according to Directive 2002/96/EC on waste electrical and electronic equipment (WEEE). For more information about recycling options, check the Support/Service section of the Tektronix Web site (www.tektronix.com).

Safety Summary

Review the following safety precautions to avoid injury and prevent damage to this product or any products connected to it. To avoid potential hazards, use this product only as specified. Using the probe or accessories in a manner not specified could result in a shock or fire hazard.

To Avoid Fire or Personal Injury

Ground-Referenced Oscilloscope Use. Do not float the reference lead of this probe when using with ground referenced oscilloscopes (for example, DPO, MSO, and TDS series oscilloscopes). The reference lead must be connected to earth potential (0 V).

Connect and Disconnect Properly. Connect the probe output to the measurement instrument before connecting the probe to the circuit under test. Disconnect the probe input and the probe reference lead from the circuit under test before disconnecting the probe from the measurement instrument.

Avoid Electric Shock. To avoid injury or loss of life, do not connect or disconnect probes or test leads while they are connected to a voltage source.

Observe All Terminal Ratings. To avoid fire or shock hazard, observe all ratings and markings on the product. Consult the product manual for further ratings information before making connections to the product.

Avoid Electric Shock. When using probe accessories, never exceed the lowest rating of the probe or its accessory, whichever is less, including the measurement category and voltage rating.

Avoid Electric Overload. To avoid injury or fire hazard, do not apply potential to any input, including the reference inputs, that varies from ground by more than the maximum rating for that input.

Avoid Exposed Circuitry and Do not Operate Without Covers. Do not touch exposed connections and components when power is present.

Inspect The Probe And Accessories. Before each use, inspect probe and accessories for damage (cuts, tears, defects in the probe body, accessories, cable jacket, etc.). Do not use if damaged.

Do Not Operate in Wet/Damp Conditions.

Do Not Operate in an Explosive Atmosphere.

Keep Product Surfaces Clean and Dry.

Safety Terms and Symbols Terms in This Manual.

These terms may appear in this manual:



WARNING. Warning statements identify conditions or practices that could result in injury or loss of life.



CAUTION. *Caution statements identify conditions or practices that could result in damage to this product or other property.*

Symbols on the Product. These symbols may appear on the product:



CAUTION
Refer to Manual

Appendix C: P6316 General-Purpose Logic Probe Information

Product Description

The P6316 general-purpose logic probe connects the Tektronix MDO3000 Series of mixed-signal oscilloscopes to digital buses and signals on your target system. The probe breaks out 16 data channels over two 2x8-pin headers (GROUP 1 and GROUP 2). Each header includes eight signals on one row and eight grounds along the opposite row.

The P6316 is included with option MDO3MSO.

A pair of interchangeable flying lead sets are included with the probe. The lead sets bring out one ground connection on each end and eight signal leads for connecting to individual test points.

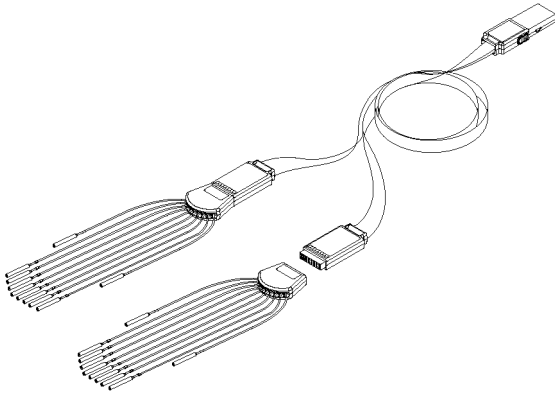

Connecting the Probe to the Oscilloscope

Connect the probe as shown in the illustration below.

1. Insert the probe label-side up into the connector on the oscilloscope.
2. To remove the probe, squeeze the buttons on the side and pull out the probe.

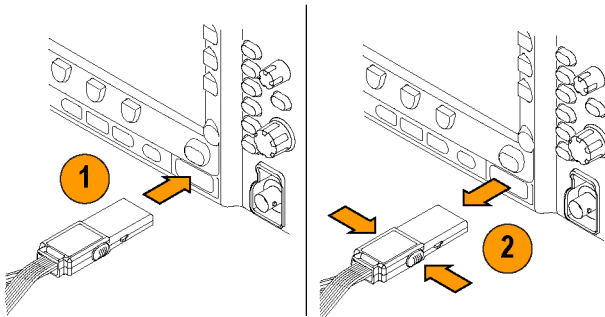

Connecting the Probe to Your Circuit

Attach the probe to the circuit using the appropriate connectors and adapters. Select the best method for your needs, and then proceed to Setting up the Probe.

To set and view the digital channel parameters, do the following:

Push the **D15–D0** button.

The parameters listed below can be set on each digital channel:

- Threshold voltage and vertical position (the default threshold setting is 1.4 V)
- Signal height and position (set once for all 16 channels)
- Channel label

To set and view bus characteristics, do the following:

Push the **B1** to **B2** buttons.

The setup screens allow you to set and view various bus characteristics.

For buses such as SPI and I²C, you must have the appropriate application module. (See page 67, *Setting Up a Serial or Parallel Bus*.)

Functional Check

Logic activity immediately displays on all connected, active channels. If you do not see an active channel:

1. Push **Trigger**.
2. Select **Edge** for the trigger type.
3. Select the channel that you are setting up as the source.
4. Push **Autoset**.

If you do not see an active signal, try another probe channel (or analog probe) to verify circuit activity at the test point.

Typical Application

1. Use the P6316 probe to view digital signals on a system bus.
2. Use an analog probe, such as the TPP0250, TPP0500B or TPP1000 passive probe, to view analog waveform information.

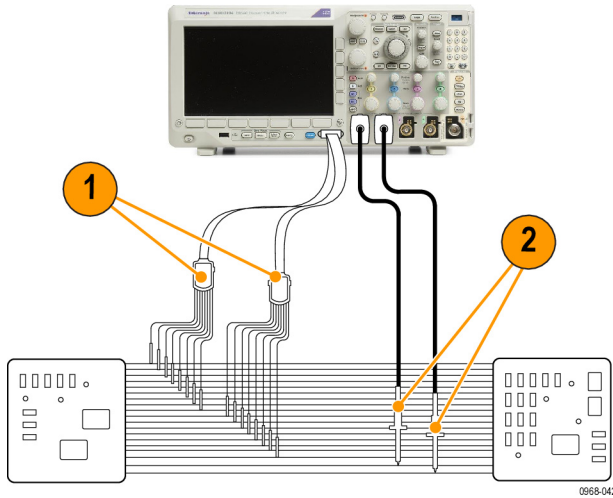

Probe lead sets:

Probe	Group 1	Group 2
Black probe	0	8
Brown probe	1	9
Red probe	2	10
Orange probe	3	11
Yellow probe	4	12
Green probe	5	13
Blue probe	6	14
Violet probe	7	15

Accessories

The following standard accessories ship with the probe and are shown in the illustration that follows.

Item	Description	Quantity	Part number
1	8-channel leadset	2	196-3508-XX
2	Micro grabber clip	2 kits of 10 each	020-2896-XX
3	Probe tip	2 kits of 5 each	020-2897-XX
—	Instructions (English, Japanese, & Simplified Chinese languages)	1 each	071-2345-XX

¹ Instructions are included with the probe, but not in the accessory kit. The instructions can be downloaded at www.tektronix.com/manuals.

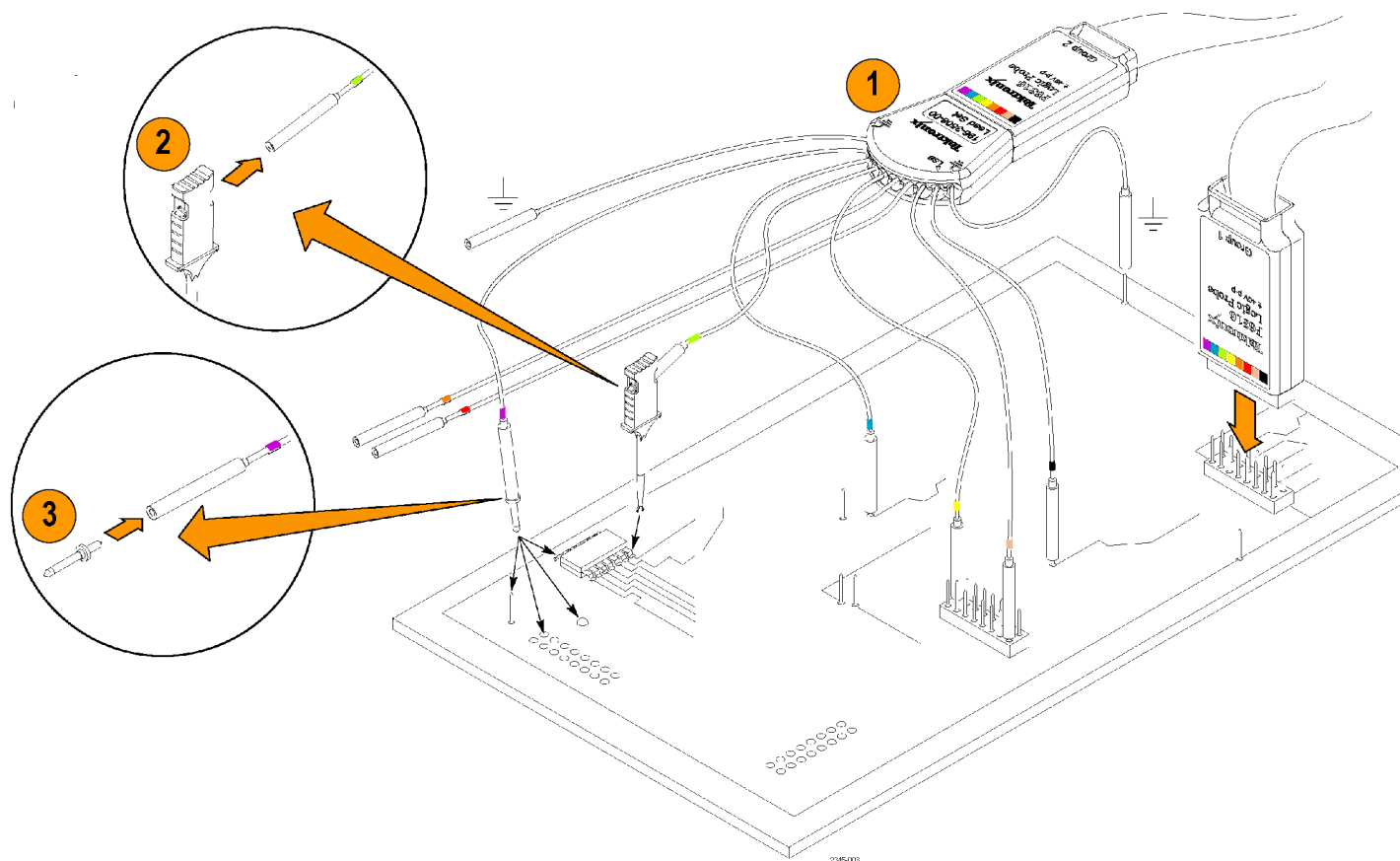

Specifications

Table 8: Electrical and mechanical specifications

Characteristic	Description
Input channels	16 digital input
Input resistance, typical	101K Ohm to ground
Input capacitance	8 pF
Input signal swing	
Minimum, typical	500 mV p-p Specified at the input to the P6316 probe with all 8 ground inputs connected to the user's ground. Use of leadsets, grabber clips, ground extenders, or other connection accessories may compromise this specification.
Maximum, typical	+30 V, -20 V

Table 9: Environmental specifications

Characteristic	Description
Temperature	
Maximum operating	+50 °C (+122 °F)
Minimum operating	0 °C (+32 °F)
Non-operating	-40 °C to +71 °C (-40 °F to +159 °F)
Humidity	5% to 95% relative humidity at up to +30 °C (+86 °F) 5% to 60% RH above +30° C (+86 °F) up to +50 °C (+122 °F), non-condensing
Altitude	
Operating	3,000 meters (9,843 feet)
Non-operating	12,000 meters (39,370 feet)



Equipment Recycling. This product complies with the European Union's requirements according to Directive 2002/96/EC on waste electrical and electronic equipment (WEEE). For more information about recycling options, check the Support/Service section of the Tektronix Web site (www.tektronix.com).

Safety Summary

To avoid potential hazards, use this probe only as specified.

Connect and Disconnect Properly. Connect the probe output to the measurement instrument before connecting the probe to the circuit under test. Disconnect the probe input and the probe ground from the circuit under test before disconnecting the probe from the measurement instrument.

Observe All Terminal Ratings. To avoid fire or shock hazard, observe all ratings and markings on the product. Consult the product manual for further ratings information before making connections to the product.

Do not Operate Without Covers. Do not touch exposed connections and components when power is present.

Avoid Exposed Circuitry. Do not touch exposed connections and components when power is present.

Do Not Operate With Suspected Failures. If you suspect there is damage to this product, have it inspected by qualified service personnel.

Do Not Operate in Wet/Damp Conditions. Do Not Operate in an Explosive Atmosphere.

Keep Product Surfaces Clean and Dry.

Safety Terms and Symbols in This Manual.

These terms may appear in this manual:



WARNING. *Warning statements identify conditions or practices that could result in injury or loss of life.*



CAUTION. *Caution statements identify conditions or practices that could result in damage to this product or other property.*

Symbols on the Product. This symbol may appear on the product:



CAUTION
Refer to Manual

Appendix D: OpenSSL License

License Issues

The OpenSSL toolkit stays under a dual license, i.e. both the conditions of the OpenSSL License and the original SSLeay license apply to the toolkit. See below for the actual license texts. Actually both licenses are BSD-style Open Source licenses. In case of any license issues related to OpenSSL please contact openssl-core@openssl.org.

OpenSSL License

```

-----
/* =====
* Copyright (c) 1998-2011 The OpenSSL Project. All rights reserved.
*
* Redistribution and use in source and binary forms, with or without
* modification, are permitted provided that the following conditions
* are met:
*
* 1. Redistributions of source code must retain the above copyright
* notice, this list of conditions and the following disclaimer.
*
* 2. Redistributions in binary form must reproduce the above copyright
* notice, this list of conditions and the following disclaimer in
* the documentation and/or other materials provided with the
* distribution.
*
* 3. All advertising materials mentioning features or use of this
* software must display the following acknowledgment:
* "This product includes software developed by the OpenSSL Project
* for use in the OpenSSL Toolkit. (http://www.openssl.org/)"
*
* 4. The names "OpenSSL Toolkit" and "OpenSSL Project" must not be used to
* endorse or promote products derived from this software without
* prior written permission. For written permission, please contact
* openssl-core@openssl.org.
*
* 5. Products derived from this software may not be called "OpenSSL "
* nor may "OpenSSL" appear in their names without prior written
* permission of the OpenSSL Project.
*
* 6. Redistributions of any form whatsoever must retain the following
* acknowledgment:
* "This product includes software developed by the OpenSSL Project
* for use in the OpenSSL Toolkit (http://www.openssl.org/)"
*
* THIS SOFTWARE IS PROVIDED BY THE OpenSSL PROJECT ``AS IS'' AND ANY
* EXPRESSED OR IMPLIED WARRANTIES, INCLUDING, BUT NOT LIMITED TO, THE
* IMPLIED WARRANTIES OF MERCHANTABILITY AND FITNESS FOR A PARTICULAR
* PURPOSE ARE DISCLAIMED. IN NO EVENT SHALL THE OpenSSL PROJECT OR
* ITS CONTRIBUTORS BE LIABLE FOR ANY DIRECT, INDIRECT, INCIDENTAL,
* SPECIAL, EXEMPLARY, OR CONSEQUENTIAL DAMAGES (INCLUDING, BUT

```

```
* NOT LIMITED TO, PROCUREMENT OF SUBSTITUTE GOODS OR SERVICES;  
* LOSS OF USE, DATA, OR PROFITS; OR BUSINESS INTERRUPTION)  
* HOWEVER CAUSED AND ON ANY THEORY OF LIABILITY, WHETHER IN CONTRACT,  
* STRICT LIABILITY, OR TORT (INCLUDING NEGLIGENCE OR OTHERWISE)  
* ARISING IN ANY WAY OUT OF THE USE OF THIS SOFTWARE, EVEN IF ADVISED  
* OF THE POSSIBILITY OF SUCH DAMAGE.  
* =====  
*  
* This product includes cryptographic software written by Eric Young  
* (eay@cryptsoft.com). This product includes software written by Tim  
* Hudson (tjh@cryptsoft.com).  
*  
*/
```

Original SSLeay License

```
-----  
/* Copyright (C) 1995-1998 Eric Young (eay@cryptsoft.com)  
* All rights reserved.  
*  
* This package is an SSL implementation written  
* by Eric Young (eay@cryptsoft.com).  
* The implementation was written so as to conform with Netscapes SSL.  
*  
* This library is free for commercial and non-commercial use as long as  
* the following conditions are adhered to. The following conditions  
* apply to all code found in this distribution, be it the RC4, RSA,  
* lhash, DES, etc., code; not just the SSL code. The SSL documentation  
* included with this distribution is covered by the same copyright terms  
* except that the holder is Tim Hudson (tjh@cryptsoft.com).  
*  
* Copyright remains Eric Young's, and as such any Copyright notices in  
* the code are not to be removed.  
* If this package is used in a product, Eric Young should be given attribution  
* as the author of the parts of the library used.  
* This can be in the form of a textual message at program startup or  
* in documentation (online or textual) provided with the package.  
*  
* Redistribution and use in source and binary forms, with or without  
* modification, are permitted provided that the following conditions  
* are met:  
* 1. Redistributions of source code must retain the copyright  
* notice, this list of conditions and the following disclaimer.  
* 2. Redistributions in binary form must reproduce the above copyright  
* notice, this list of conditions and the following disclaimer in the  
* documentation and/or other materials provided with the distribution.  
* 3. All advertising materials mentioning features or use of this software  
* must display the following acknowledgement:  
* "This product includes cryptographic software written by  
* Eric Young (eay@cryptsoft.com)"  
* The word 'cryptographic' can be left out if the routines from the library  
* being used are not cryptographic related :-).
```

```
* 4. If you include any Windows specific code (or a derivative thereof) from
* the apps directory (application code) you must include an acknowledgement:
* "This product includes software written by Tim Hudson (tjh@cryptsoft.com)"
*
* THIS SOFTWARE IS PROVIDED BY ERIC YOUNG ``AS IS" AND
* ANY EXPRESS OR IMPLIED WARRANTIES, INCLUDING, BUT NOT LIMITED TO, THE
* IMPLIED WARRANTIES OF MERCHANTABILITY AND FITNESS FOR A PARTICULAR PURPOSE
* ARE DISCLAIMED. IN NO EVENT SHALL THE AUTHOR OR CONTRIBUTORS BE LIABLE
* FOR ANY DIRECT, INDIRECT, INCIDENTAL, SPECIAL, EXEMPLARY, OR CONSEQUENTIAL
* DAMAGES (INCLUDING, BUT NOT LIMITED TO, PROCUREMENT OF SUBSTITUTE GOODS
* OR SERVICES; LOSS OF USE, DATA, OR PROFITS; OR BUSINESS INTERRUPTION)
* HOWEVER CAUSED AND ON ANY THEORY OF LIABILITY, WHETHER IN CONTRACT, STRICT
* LIABILITY, OR TORT (INCLUDING NEGLIGENCE OR OTHERWISE) ARISING IN ANY WAY
* OUT OF THE USE OF THIS SOFTWARE, EVEN IF ADVISED OF THE POSSIBILITY OF
* SUCH DAMAGE.
*
* The licence and distribution terms for any publicly available version or
* derivative of this code cannot be changed. i.e. this code cannot simply be
* copied and put under another distribution licence
* [including the GNU Public Licence.]
*/
```

Index

Symbols and Numbers

50 Ω protection, 112

A

About, 25
 Accessories, 1
 ACD3000, 3
 Acquire button, 39, 60, 62, 103
 Acquisition
 input channels and digitizers, 59
 modes defined, 62
 readout, 45
 sampling, 59
 Act on event, 65
 Adapter
 TEK-USB-488, 3
 TPA-BNC, 3, 8
 TPA-N-VPI, 3, 8
 Adding waveform, 103
 Adjacent channel power ratio measurement, 133
 Advanced math, 145
 AFG button, 39
 Altitude, 6
 Ampl button, 41, 85
 Amplitude measurement, 126
 Annotating the screen, 115
 Application module, 36
 Application modules, 14, 191
 30-day free trial, 14
 license transfers, 14
 MDO3AERO, 3, 67
 MDO3AUDIO, 3, 67
 MDO3AUTO, 3, 67
 MDO3COMP, 3, 67
 MDO3EMBD, 3, 67
 MDO3FLEX, 67
 MDO3LMT, 3
 MDO3PWR, 3, 67
 MDO3USB, 3, 67
 Arbitrary function generator
 button, 36
 display, 49
 use, 185
 Area measurement, 127

ARINC429, xvi, 3, 40, 67, 68, 71, 95, 154, 191
 bus trigger, 96
 Audio
 bus trigger, 98
 Auto Level, 86
 Auto trigger mode, 89
 Auto-magnify mode, 154
 Autoset, 58
 Video, 59
 Autoset button, 11, 38, 43, 54, 58
 Autoset disable, 58
 Autoset undo, 58
 Auxiliary readout, 47
 Average acquisition mode, 62
 Average detection type, 120
 Average trace, 118

B

B trigger, 101
 B/W button, 41
 B1, B2, 67, 68, 95
 Backlight intensity, 106
 Bandwidth, xvi, 110
 resolution, 86
 Baseline indicator, 86
 Baseline indicators, 47
 Before Installation, 1
 Blackman-Harris FFT window, 88, 145
 Blue lines, 115
 BNC interface, 8
 Burst Width measurement, 125
 Bus
 button, 67, 68, 95
 display, 48, 70
 menu, 40, 68
 positioning and labeling, 113
 setup, 68
 Bus and Waveforms display
 show physical layer bus activity, 80
 Bus button, 39
 Bus trigger, defined, 95
 Buses, 67, 95
 cursor readout, 137
 Button
 Acquire, 39, 60, 62, 103
 AFG, 39
 Ampl, 41, 85
 Arbitrary function generator, 36
 Autoset, 11, 38, 43, 54, 58
 B/W, 41
 B1, B2, 40, 67, 68, 95
 bus, 67, 68, 95
 Bus, 39
 BW, 87
 Channel, 39
 Cursors, 41, 134
 D15 - D0, 44, 83
 Default Setup, 39, 44, 54, 57
 Fine, 38, 41, 43
 Force Trig, 43, 89
 Freq/Span, 41, 84
 hard copy, 44, 180
 Intensity, 42, 107
 M, 40, 141, 142
 Markers, 41
 Math, 39, 40, 141, 142
 Measure, 38, 124, 129, 130
 Menu Off, 44
 Next, 42
 Play-pause, 42, 150
 Previous, 42
 Print, 44
 printer, 180
 Ref, 40, 146, 147, 167
 Reference, 39
 RF, 22, 41, 48, 117
 Run/Stop, 43, 64, 102
 Save / Recall, 39, 44, 164
 Search, 38, 152
 Select, 41
 Set / Clear Mark, 42, 151
 Set to 50%, 43, 91
 Single, 43, 102
 Span, 85
 Test, 38
 Trigger level, 43
 Trigger menu, 92
 Trigger Menu, 39
 Utility, 18, 20, 21, 39, 105, 106, 115, 116, 173
 Vertical, 39
 Zoom, 42
 BW button, 87

byte matching, 99

C

Calibration, 21, 22
Calibration certificate, 1
CAN, 40, 67, 95
 bus trigger, 97
CAN FD, 40, 67, 95
 bus trigger, 97
Case
 hard transit, 4
 soft transit, 3
Center frequency, 85
Channel
 readout, 47
 vertical menu, 109
Channel button, 39
Channel power measurement, 133
Cleaning, 7
Clearance, 6
Clearance, MDO3000, 5
Communications, 26, 29, 32
Compensate
 non-TPP0250, non-TPP500B or
 non-TPP1000 probe, 13
 signal path, 21
 TPP0250, TPP500B or
 TPP1000 probe, 11
Confidential data, 180
Connecting
 a USB keyboard, 35
 to a PC, 26
 Your oscilloscope, 26
Connectivity, 1, 26, 29, 32
Connectors
 front panel, 52
 rear-panel, 53
 side-panel, 52
Controls, 36
Copy a drive, directory, or file, 171
Coupling, 109
Coupling, trigger, 90
Cover
 front, 3
Create new folder, 171
Cross Hair graticule style, 106
Cursor readout, 46, 137

Cursors, 134
 button, 41, 134
 linking, 135
 measurements, 134
 menu, 134
 XY, 138
Cycle Area measurement, 127
Cycle Mean measurement, 127
Cycle RMS measurement, 127

D

D15 - D0 button, 44, 83
Date and time, changing, 20
Default Setup, 57, 170
 button, 44, 54, 57
 menu, 44
 Undo, 57
Default Setup button, 39
Delay measurement, 125
Delay time, 64
Delayed trigger, 100
Delete directory or file, 171
Depth, MDO3000, 5
Deskew, 111
Detection types, 119
Digital channels, 115
 Baseline indicators, 47
 Group icon, 48
 scaling, positioning, grouping,
 and labeling, 113
 setup, 81
Digital Voltmeter
 display, 51
 use, 133
Disable Autoset, 58
Display
 frequency domain, 48
 information, 45
 persistence, 103
 style, 103
 XY, 104
Displaying, reference
 waveforms, 167
Drivers, 26, 29
Dual waveform math, 141
DVM
 display, 51
 use, 133

E

E-mail printing, 177

e*Scope, 29
Edge trigger, defined, 93
Edges
 Fuzzy, 115
 White, 115
Envelope acquisition mode, 62
Erase setup and ref memory, 180
Ethernet, 28, 29, 30
 printing, 175
Event Table, 70
 Display, 70
 Save, 70
Excel, 26, 29
Excursion, 122
Expansion point, 60
Expansion point icon, 45

F

Factory calibration, 22
Fall Time measurement, 125
Falling Edge Count
 measurement, 127
FastAcq, 60
FFT
 Blackman-Harris, 88, 145
 controls, 142
 Flat-Top, 88
 Hamming, 88, 144
 Hanning, 88, 145
 Kaiser, 88
 Rectangular, 88, 144
File format, 165
 Instrument Specific File Format
 (ISF), 167
 TIQ, 165
File names, 162
File system, 162, 167
Fine button, 38, 41, 43
Firmware
 upgrade, 23
 version, 25
firmware.img file, 23
Flash drive, 29
Flat-Top FFT window, 88
FlexRay, 40, 67, 95
 bus trigger, 98
Force Trig button, 43, 89
Format a drive, 171
Frame graticule style, 106
Freq/Span button, 41, 84
Frequency Domain
 menu, 41

Frequency domain display, 48
 Frequency domain markers, 121
 automatic, 122
 manual, 123
 Frequency Domain menu, 22
 Frequency measurement, 125
 Frequency, center, 85
 Frequency, Source
 MDO3000, 5
 Front cover, 3
 Front panel, 36
 front panel connectors, 52
 front panel overlay, 19
 Full graticule style, 106
 Function Generator, 185
 Functional check, 10
 Fuzzy edges, 115

G

Gating, 128
 GPIB, 27
 GPIB address, 28
 Graticule
 Cross Hair, 106
 Frame, 106
 Full, 106
 Grid, 106
 intensity, 107
 IRE, 106
 mV, 106
 Solid, 106
 styles, 105
 Green lines, 115
 Grid graticule style, 106
 Ground, 9
 lead, 14
 strap, 9
 strap connector, 52
 Ground strap, 36
 Ground yourself to discharge
 static, 9
 Group icon, 48
 Grouping channels, 82
 digital, 113

H

Hamming FFT window, 88, 144
 Hanning FFT window, 88, 145
 Hard copy
 button, 44
 printing, 172
 HCTEK4321 transit hard case, 4
 Height, MDO3000, 5
 Hi Res acquisition mode, 62
 High measurement, 126
 High-low indicators, 47
 Histogram (waveform)
 reset the count, 140
 setup, 138
 Histogram measurements, 128
 Hits in Box measurement, 128
 Holdoff, trigger, 90
 Horizontal delay, 90
 Horizontal lines
 Green and blue, 115
 Horizontal position, 43, 60, 90, 91,
 108, 144
 and math waveforms, 142
 defined, 55
 readout, 47
 Horizontal scale, 43, 108, 144
 and math waveforms, 142
 defined, 55
 readout, 47
 How to
 calibrate a TPP0250, TPP0500
 or TPP1000 voltage
 probe, 11
 compensate a non-TPP0250,
 non-TPP0500B or
 non-TPP1000 voltage
 probe, 13
 compensate the signal path, 21
 connect probes and
 adapters, 7
 connect to a computer, 26
 erase memory, 180
 label channels and buses, 55
 manage long record length
 waveforms, 149
 perform a functional check, 10
 power off the oscilloscope, 10
 power on the oscilloscope, 9
 print a hard copy, 172
 print via e-mail, 177
 recall setups, 168
 recall waveforms, 164
 save screen images, 164
 save setups, 168
 save waveforms, 164
 search through and add marks
 to waveforms, 151
 select a trigger, 93

select automatic
 measurements, 125
 setup a waveform
 histogram, 138
 setup analog channels, 54
 setup bus parameters, 68
 setup digital channels, 81
 setup input parameters, 109
 setup VISA communica-
 tions, 26
 take an automatic measurement
 in the frequency
 domain, 132
 take an automatic measurement
 in the time domain, 124
 take digital voltmeter
 measurements, 133
 take manual measurements
 with cursors, 134
 trigger on buses, 95
 upgrade the firmware, 23
 use a sequential trigger, 100
 use a socket server, 32
 use Act on Event, 65
 use e*Scope, 29
 use MagniVu, 83
 use Wave Inspector, 149

Humidity
 P6316, 7

I

I2C, 40, 67, 95
 I2S, 40, 67, 95
 Icon
 Expansion point, 45
 Security, 46
 Trigger level, 46
 Trigger position, 45
 Image orientation, 165, 173
 Impedance, 109
 Indicator
 baseline, 86
 trace, 119
 Indicator, waveform baseline, 48
 Infinite persistence, 104
 Ink Saver, 165, 174
 Inner knob, 42, 142
 Input capacitance, P6316, 6
 Input resistance, P6316, 6
 Instrument Specific File Format
 (ISF), 167

Intensity

- button, 42

- Intensity button, 107

- Invert, 109

- IRE graticule, 106

- ISF format, 167

K

- Kaiser FFT window, 88

Keyboard

- Connection, 35

- Key layout style, 35

- language, 18

- Keypad, 36

Knob

- inner, 42, 142

- Multipurpose, 20, 38, 41, 61, 62, 167

- outer, 42

- pan, 42, 150, 151

- Trigger level, 91

- Vertical position, 55

- Vertical Position, 39

- Vertical scale, 55

- zoom, 42, 142, 149

L

- Label bus, 113

- LabVIEW SignalExpress, 26, 29

- Landscape, 165, 173

Language

- change, 18

- overlay, 19

- Left Justified (LJ), 40, 67, 95

- Level, trigger, 91

- License transfers for application modules, 14

- Limit testing, 155

- LIN, 40, 67, 95

- bus trigger, 97

- Linked cursors, 135

- Lock, standard laptop, 8

- Logic probe, 2

- interface, 8

- Logic trigger, defined, 94

- Long record length

- management, 149

- Low measurement, 126

- Low resolution message, 124

- LXI, 30

M

- M button, 40, 141, 142

- MagniVu, 83

- MagniVu readout, 47

- Main trigger, 100

- Mark, 151

- Markers, 121, 122

- threshold and excursion, 122

- Markers button, 41

- Mask testing, 155

Math

- Advanced, 145

- button, 40, 141, 142

- Dual waveform, 141

- FFT, 142

- menu, 40

- spectrum, 146

- waveforms, 141

- Math button, 39

- Max hold trace, 118

- Max measurement, 126, 128

- Maximum nondestructive input signal, P6316, 6

- Maximum signal swing, P6316, 6

- MDO3AERO, 191

- MDO3AERO, 3, 67

- MDO3AUDIO, 3, 67, 191

- MDO3AUTO, 3, 67, 191

- MDO3COMP, 3, 67, 191

- MDO3EMBD, 3, 67, 191

- MDO3FLEX, 67, 191

- MDO3LMT, 3, 155, 191

- MDO3PWR, 3, 67, 160, 192

- MDO3USB, 3, 67, 192

- Mean measurement, 127, 128

- Measure button, 38, 124, 129, 130

Measurement

- adjacent channel power ratio, 133

- channel power, 133

- occupied bandwidth, 133

- Measurement menu, 38

Measurements

- automatic, 124

- cursor, 134

- defined, 125

- DVM, 133

- frequency domain, 132

- histogram, 128

- power, 160

- reference levels, 131

- snapshot, 130

- statistics, 129

- Median measurement, 128

- Memory, erasure of, 180

Menu, 36

- Bus, 40, 68

- buttons, 38

- Cursors, 134

- Default Setup, 44

- Frequency Domain, 22, 41

- Math, 40

- Measurement, 38

- Reference, 40, 147, 148

- Save / Recall, 39, 44, 164

- Trigger, 92, 100

- Utility, 19, 20, 39, 44, 105, 116, 117, 173

- Vertical, 39, 109

- Menu Off button, 44

Microsoft

- Excel, 29

- Word, 29

- MIL-STD-1553, 40, 67, 95

- bus trigger, 98

- data value matching, 99

- Min hold trace, 118

- Min measurement, 126, 128

- Mode, roll, 64

- Monitor, 82

- Mount or unmount a networked drive, 171

- Multiple transition detection, 115

- Multipurpose knob, 38, 41, 61, 62, 167

- mV graticule, 106

N

- N-connector RF input, 36

- Negative Duty Cycle

- measurement, 125

- Negative Overshoot

- measurement, 126

- Negative Pulse Count

- measurement, 127

- Negative Pulse Width

- measurement, 125

- Network printing, 175

- Networked drives, mounting and unmounting, 171

- NEX-HD2HEADER, 3

- Next button, 42

- Normal trace, 118

- Normal trigger mode, 89

O

- Occupied bandwidth
 - measurement, 133
- Offset and position, 112
- Offset vertical, 110
- OpenChoice Desktop, 1, 26, 29
- Operating specifications, 5
- Option key, 15
- Orientation of the image, 165, 173
- Outer knob, 42
- Overlay, 19

P

- P6316, 83
 - humidity, 7
 - input capacitance, 6
 - input resistance, 6
 - logic probe, 2
 - maximum nondestructive input
 - signal, 6
 - maximum signal swing, 6
 - pollution degree, 6
 - probe ground leads, 81
 - threshold accuracy, 6
 - threshold range, 6
- Pan, 149, 150
 - knob, 42, 150, 151
- Parallel bus, 67, 95
 - trigger, 95, 96
- Pause, 150
- Peak detect acquisition mode, 62
- Peak detection type, 120
- +Peak detection type, 119
- Peak Hits measurement, 128
- Peak-to-peak measurement, 126, 128
- Period measurement, 125
- Persistence
 - display, 103
 - infinite, 104
 - variable, 104
- Phase measurement, 125
- Physical layer bus activity, 80
- PictBridge, 29, 172
- Picture mode, 160
- Play, 150
- Play-pause
 - button, 42, 150
 - mode, 150
- Pollution Degree
 - P6316, 6
- Portrait, 165, 173

- Position
 - bus, 113
 - digital channels, 113
 - Horizontal, 90, 91, 108, 144
 - Vertical, 108
- Position and offset, 112
- Positive Duty Cycle
 - measurement, 125
- Positive Overshoot
 - measurement, 126
- Positive Pulse Count
 - measurement, 127
- Positive Pulse Width
 - measurement, 125
- Posttrigger, 89, 91
- Pouch, probe and accessory, 2
- Power
 - cord, 2
 - input, 53
 - off, 10
 - removing, 10
 - supply, 9
 - switch, 44
- Power measurements, 160
- Predefined math expressions, 141
- Pretrigger, 89, 91
- Previous button, 42
- Print, 173
 - E-mail, 177
 - Ethernet, 175
 - hard copy, 172
- Print button, 44
- Probe
 - accessory, 2
 - logic, 2
- Probe Comp, 11, 12
- PROBE COMP, 36
- PROBE COMP connector, 52
- Probe compensation
 - non-TPP0250, non-TPP0500B
 - or non-TPP1000, 13
 - TPP0250, TPP0500B or
 - TPP1000, 11
- Probe connector
 - analog, 52
 - logic, 52

Probes

- BNC, 8
- connecting, 7
- ground lead, 14
- logic, 8
- P6316, 205
- TEK-USB-488 Adapter, 3
- TekVPI, 3, 7
- TPA-BNC Adapter, 3, 8
- TPP0250, 1, 198
- TPP0500B, 1, 198
- TPP1000, 1, 198
- Pulse Width trigger, defined, 93

R

- Rackmount, 3
- RBW, 86
- Readout
 - Acquisition, 45
 - Auxiliary, 47
 - Channel, 47
 - Cursor, 46, 137
 - Horizontal position/scale, 47
 - MagniVu, 47
 - Record length/sampling
 - rate, 46
 - Timing resolution, 47
 - Trigger, 46, 100
 - Trigger frequency, 116
 - Trigger status, 46
- Real-time sampling, 59
- Rear-panel connectors, 53
- Recalling
 - setups, 168
 - waveforms, 164
- Record length, xvi, 60
- Record length/sampling rate
 - readout, 46
- Rectangular FFT window, 88, 144
- Ref button, 40, 146, 147, 167
- Ref R, 167
- Reference button, 39
- Reference level, 119
- Reference levels, 131
- Reference menu, 40, 147, 148
- Reference waveforms, 147
 - displaying, 167
 - removing, 148, 168
 - saving, 167
 - saving 10 M waveforms, 148
- Removing reference
 - waveforms, 148, 168

- Removing waveform, 103
- Rename a drive, directory, or file, 171
- Resolution bandwidth, 86
- RF button, 22, 41, 48, 117
- RF input connector, 36, 52
- Right Justified (RJ), 40, 67, 95
- Rise Time measurement, 125
- Rise/Fall trigger, defined, 94
- Rising Edge Count
 - measurement, 127
- RMS measurement, 127
- Roll mode, 64
- Rolling window data matching, 98
- RS-232, 40, 67, 95
 - bus trigger, 97
 - cursor readout, 137
 - data value matching, 99
 - decoding, 74
- RS-422, 40, 67
- RS-485, 40, 67
- Run/Stop button, 43, 64, 102
- Runt trigger, defined, 93

S

- Sample acquisition mode, 62
- Sample detection type, 119
- Sample interval, 60
- Sample rates, xvi
- Sampling process, defined, 59
- Sampling, real-time, 59
- Save / Recall
 - menu, 39, 44, 164
 - Menu button, 39
 - Save button, 164
- Save / Recall Save button, 44
- Saving
 - reference waveforms, 167
 - screen images, 164
 - setups, 168
 - waveforms, 164
- Saving and recalling Information, 162
- Scale
 - digital channels, 113
 - Horizontal, 43, 108, 144
 - Vertical, 108
- Screen annotations, 115
- Search, 151
- Search button, 38, 152
- Search mark table, 152
- Securing memory, 180

- Security icon, 46
- Security lock, 8
- Select button, 41
- Selecting a keyboard key layout style, 35
- Sequence (B Trigger), defined, 93
- Sequential triggering, 100
- Serial bus, 67
 - trigger, 95
- Serial number, 17
- Set / Clear Mark button, 42, 151
- Set to 50% button, 43, 91
- Setup
 - default, 44, 54, 57, 170
- Setup and Hold trigger, defined, 94
- Side panel connector, 52
- Sigma1 measurement, 128
- Sigma2 measurement, 128
- Sigma3 measurement, 128
- Signal path compensation, 21
 - Frequency domain, 22
 - Time and frequency domains, 21
- Single button, 43, 102
- Single sequence, 64, 102
- Slope, trigger, 91
- SMTP, 66, 179
- Snapshot, 130
- Socket server, 32
- Socket Server, 28
- Software drivers, 26, 29
- Software, optional, 191
- Solid graticule style, 106
- Span button, 85
- SPC, 21
- Specifications
 - operating, 5
 - power supply, 9
- Spectrogram
 - display, 120
- Spectrum Math, 146
- Spectrum traces, 118
- SPI, 40, 67, 95
 - bus trigger, 97
- Standard Deviation
 - measurement, 128
- Start an acquisition, 102
- Statistics, 129
- Stop an acquisition, 102
- Switch, power, 44

T

- Table
 - Search mark, 152
- Table, Event, 70
- TDM, 40, 67, 95
- TEK-USB-488 Adapter, 3, 27, 28
- TekSecure, 180
- TekVPI, 7
 - probes, 3
- Telnet, 34
- Temperature
 - MDO3000, 5
- Termination, 109
- Test button, 38
- Threshold, 122
 - accuracy, P6316, 6
 - range, P6316, 6
- Timeout trigger, defined, 93
- Timing resolution readout, 47
- TIQ files, 165
- TotalOvershoot measurement, 126
- TPA-BNC Adapter, 3, 8
- TPA-N-VPI Adapter, 3, 8
- TPP0250 probe, 1
- TPP0250, TPP0500B or TPP1000
 - compensation, 11
- TPP0500B probe, 1
- TPP1000 probe, 1
- Trace
 - average, 118
 - indicator, 119
 - max hold, 118
 - min hold, 118
 - normal, 118
- Transit case
 - hard, 4
 - soft, 3
- Transition trigger, defined, 94
- Trigger
 - ARINC429 bus, 96
 - Audio bus, 98
 - B trigger after delay time, 101
 - Bus, defined, 95
 - buses, 95
 - byte matching, 99
 - CAN bus, 97
 - CAN FD bus, 97
 - concepts, 89
 - coupling, 90
 - data matching on a rolling window, 98
 - delayed, 100
 - Edge, defined, 93

- event, defined, 89
 - FlexRay bus, 98
 - forcing, 89
 - Frequency readout, 116
 - holdoff, 90
 - level, 91
 - level button, 43
 - level icon, 46
 - level knob, 91
 - LIN bus, 97
 - Logic, defined, 94
 - menu, 92, 100
 - MIL-STD-1553 bus, 98
 - MIL-STD-1553 data value
 - matching, 99
 - modes, 89, 92
 - Parallel bus, 96
 - parallel bus data matching, 99
 - parallel buses, 67
 - point, 60
 - position icon, 45
 - posttrigger, 89, 91
 - pretrigger, 89, 91
 - Pulse Width, defined, 93
 - readout, 46, 100
 - Rise/Fall, defined, 94
 - RS-232 bus, 97
 - RS-232 data value
 - matching, 99
 - Runt, defined, 93
 - Sequence (B Trigger),
 - defined, 93
 - sequential, 100
 - serial buses, 67
 - Setup and Hold, defined, 94
 - slope, 91
 - SPI bus, 97
 - status readout, 46
 - Timeout, defined, 93
 - Trigger on B events, 101
 - USB bus, 98
 - Video, defined, 95
- Trigger menu
 - button, 39
 - Trigger modes
 - Auto, 89
 - Normal, 89
- Trigger types, defined, 93
 - Triggering on Buses, 95
- ## U
- UART, 40, 67
 - Undo
 - Autoset, 58
 - Default Setup, 57
 - Upgrading
 - bandwidth, 15
 - firmware, 23
 - USB, 67, 95, 162, 172
 - bus trigger, 98
 - Device port, 53
 - flash drive, 29
 - host ports, 44
 - User interface language, 18
 - User marks, 151
 - Utility button, 18, 20, 21, 39, 105, 106, 115, 116, 173
 - Utility menu, 19, 20, 39, 44, 105, 116, 117
- ## V
- Variable persistence, 104
 - Ventilation, 6
 - Versatile Probe Interface, 7
 - Version, firmware, 25
 - Vertical
 - button, 39
 - menu, 39, 109
 - offset, 112
 - Offset, 110
 - position, 108
 - position and autoset, 59
 - position and offset, 112
 - Position knob, 39, 55
 - scale, 108
 - Scale knob, 55
 - Video
 - Autoset, 59
 - picture mode, 160
 - Tests, 159
 - Video Out
 - port, 53
- Video trigger, defined, 95
 - View
 - digital channels, 115
 - waveform record, 46
 - VISA, 26
 - Voltage, Source
 - MDO3000, 5
- ## W
- Wave Inspector, 149
 - Waveform
 - adding, 103
 - baseline indicator, 48
 - Count measurement, 128
 - display style, 103
 - histogram measurements, 128
 - intensity, 107
 - pan, 149, 150
 - pause, 150
 - play, 150
 - play-pause, 150
 - record defined, 60
 - record view, 46
 - removing, 103
 - search and mark, 151
 - user marks, 151
 - zoom, 149
 - Weight
 - MDO3000, 5
 - White edges, 115
 - Width
 - MDO3000, 5
 - Word, 29
- ## X
- XY
 - cursors, 138
 - display, 104
- ## Z
- Zoom, 149
 - button, 42
 - graticule size, 150
 - knob, 42, 149