



**MDO4000C Series
Mixed Domain Oscilloscopes
Specifications and Performance Verification
Technical Reference**



077-1178-01



**MDO4000C Series
Mixed Domain Oscilloscopes
Specifications and Performance Verification
Technical Reference**

Revision B

August 26, 2019

This document supports firmware version 1.02 and above for MDO4000C Series instruments.

Warning

The servicing instructions are for use by qualified personnel only. To avoid personal injury, do not perform any servicing unless you are qualified to do so. Refer to all safety summaries prior to performing service.

www.tek.com

077-1178-01

Copyright © Tektronix. All rights reserved. Licensed software products are owned by Tektronix or its subsidiaries or suppliers, and are protected by national copyright laws and international treaty provisions.

Tektronix products are covered by U.S. and foreign patents, issued and pending. Information in this publication supersedes that in all previously published material. Specifications and price change privileges reserved.

TEKTRONIX and TEK are registered trademarks of Tektronix, Inc.

Contacting Tektronix

Tektronix, Inc.
14150 SW Karl Braun Drive
P.O. Box 500
Beaverton, OR 97077
USA

For product information, sales, service, and technical support:

- In North America, call 1-800-833-9200.
- Worldwide, visit www.tek.com to find contacts in your area.

Table of Contents

Important safety information	iv
General safety summary	iv
Service safety summary	vii
Terms in this manual	viii
Symbols and terms on the product	viii
Specifications	1
Analog Signal Acquisition System Specifications	1
Time Base System Specifications	8
Triggering System Specifications	11
Digital Acquisition System Specifications	16
P6616 Digital Probe Input Specifications	17
RF Input Specifications	18
Arbitrary Function Generator Characteristics	22
Digital Voltmeter/Counter	24
Display System Specifications	24
Interfaces and Input/Output Port Specifications	25
Data Handling Specifications	27
Power Supply System Specifications	27
Environmental Specifications	28
Mechanical Specifications	29
TPA-N-PRE Specifications	30
Performance Verification	33
Test Record	35
Performance Verification Procedures	84
Self Test	85
Check Input Impedance (Resistance)	86
Check DC Balance	88
Check DC Gain Accuracy	90
Check DC Offset Accuracy	94
Check Analog Bandwidth	96
Check Random Noise, Sample Acquisition Mode	99
Check Reference Frequency Error (Cumulative)	101
Check Delta Time Measurement Accuracy	103
Check Digital Threshold Accuracy	105
Check Phase Noise	109
Check Displayed Average Noise Level (DANL)	112
Check Absolute Amplitude Accuracy	118
Check Third Order Intermodulation Distortion	122
Check Residual Spurious Response	126

Check Crosstalk to RF Channel from Analog Channels.....	128
Check Trigger Out	130
With TPA-N-PRE Attached: Check Displayed Average Noise Level (DANL).....	134

List of Tables

Table 1: Analog signal acquisition system specifications.....	1
Table 2: Time base system specifications.....	8
Table 3: Delta-time measurement accuracy formula	10
Table 4: Trigger specifications	11
Table 5: Digital acquisition specifications	16
Table 6: P6616 digital probe input specifications.....	17
Table 7: RF input specifications	18
Table 8: AFG Characteristics	22
Table 9: Digital Voltmeter/Counter.....	24
Table 10: Display system specifications	24
Table 11: Interfaces and Input/Output port specifications	25
Table 12: Data handling specifications.....	27
Table 13: Power supply system specifications	27
Table 14: Environmental specifications.....	28
Table 15: Mechanical specifications.....	29
Table 16: TPA-N-PRE specifications.....	30
Table 17: Required equipment	34
Table 18: Gain expected worksheet	92
Table 19: Maximum bandwidth frequency worksheet	97

Important safety information

This manual contains information and warnings that must be followed by the user for safe operation and to keep the product in a safe condition.

To safely perform service on this product, additional information is provided at the end of this section. (See page vii, *Service safety summary*.)

General safety summary

Use the product only as specified. Review the following safety precautions to avoid injury and prevent damage to this product or any products connected to it. Carefully read all instructions. Retain these instructions for future reference.

Comply with local and national safety codes.

For correct and safe operation of the product, it is essential that you follow generally accepted safety procedures in addition to the safety precautions specified in this manual.

The product is designed to be used by trained personnel only.

Only qualified personnel who are aware of the hazards involved should remove the cover for repair, maintenance, or adjustment.

Before use, always check the product with a known source to be sure it is operating correctly.

This product is not intended for detection of hazardous voltages.

Use personal protective equipment to prevent shock and arc blast injury where hazardous live conductors are exposed.

While using this product, you may need to access other parts of a larger system. Read the safety sections of the other component manuals for warnings and cautions related to operating the system.

When incorporating this equipment into a system, the safety of that system is the responsibility of the assembler of the system.

To avoid fire or personal injury

Use proper power cord. Use only the power cord specified for this product and certified for the country of use.

Do not use the provided power cord for other products.

Ground the product. This product is grounded through the grounding conductor of the power cord. To avoid electric shock, the grounding conductor must be connected to earth ground. Before making connections to the input or output terminals of the product, make sure that the product is properly grounded.

Do not disable the power cord grounding connection.

Power disconnect. The power cord disconnects the product from the power source. See instructions for the location. Do not position the equipment so that it is difficult to operate the power cord; it must remain accessible to the user at all times to allow for quick disconnection if needed.

Connect and disconnect properly. Do not connect or disconnect probes or test leads while they are connected to a voltage source.

Use only insulated voltage probes, test leads, and adapters supplied with the product, or indicated by Tektronix to be suitable for the product.

Observe all terminal ratings. To avoid fire or shock hazard, observe all ratings and markings on the product. Consult the product manual for further ratings information before making connections to the product. Do not exceed the Measurement Category (CAT) rating and voltage or current rating of the lowest rated individual component of a product, probe, or accessory. Use caution when using 1:1 test leads because the probe tip voltage is directly transmitted to the product.

Do not apply a potential to any terminal, including the common terminal, that exceeds the maximum rating of that terminal.

Do not float the common terminal above the rated voltage for that terminal.

Do not operate without covers. Do not operate this product with covers or panels removed, or with the case open. Hazardous voltage exposure is possible.

Avoid exposed circuitry. Do not touch exposed connections and components when power is present.

Do not operate with suspected failures. If you suspect that there is damage to this product, have it inspected by qualified service personnel.

Disable the product if it is damaged. Do not use the product if it is damaged or operates incorrectly. If in doubt about safety of the product, turn it off and disconnect the power cord. Clearly mark the product to prevent its further operation.

Before use, inspect voltage probes, test leads, and accessories for mechanical damage and replace when damaged. Do not use probes or test leads if they are damaged, if there is exposed metal, or if a wear indicator shows.

Examine the exterior of the product before you use it. Look for cracks or missing pieces.

Use only specified replacement parts.

Use proper fuse. Use only the fuse type and rating specified for this product.

Do not operate in wet/damp conditions. Be aware that condensation may occur if a unit is moved from a cold to a warm environment.

Do not operate in an explosive atmosphere.

Keep product surfaces clean and dry. Remove the input signals before you clean the product.

Provide proper ventilation. Refer to the installation instructions in the manual for details on installing the product so it has proper ventilation.

Slots and openings are provided for ventilation and should never be covered or otherwise obstructed. Do not push objects into any of the openings.

Provide a safe working environment. Always place the product in a location convenient for viewing the display and indicators.

Avoid improper or prolonged use of keyboards, pointers, and button pads. Improper or prolonged keyboard or pointer use may result in serious injury.

Be sure your work area meets applicable ergonomic standards. Consult with an ergonomics professional to avoid stress injuries.

Use only the Tektronix rackmount hardware specified for this product.

Probes and test leads

Before connecting probes or test leads, connect the power cord from the power connector to a properly grounded power outlet.

Keep fingers behind the finger guards on the probes.

Remove all probes, test leads and accessories that are not in use.

Use only correct Measurement Category (CAT), voltage, temperature, altitude, and amperage rated probes, test leads, and adapters for any measurement.

Beware of high voltages. Understand the voltage ratings for the probe you are using and do not exceed those ratings. Two ratings are important to know and understand:

- The maximum measurement voltage from the probe tip to the probe reference lead.
- The maximum floating voltage from the probe reference lead to earth ground

These two voltage ratings depend on the probe and your application. Refer to the Specifications section of the manual for more information.



WARNING. *To prevent electrical shock, do not exceed the maximum measurement or maximum floating voltage for the oscilloscope input BNC connector, probe tip, or probe reference lead.*

Connect and disconnect properly. Connect the probe output to the measurement product before connecting the probe to the circuit under test. Connect the probe reference lead to the circuit under test before connecting the probe input. Disconnect the probe input and the probe reference lead from the circuit under test before disconnecting the probe from the measurement product.

Connect and disconnect properly. De-energize the circuit under test before connecting or disconnecting the current probe.

Connect the probe reference lead to earth ground only.

Do not connect a current probe to any wire that carries voltages above the current probe voltage rating.

Inspect the probe and accessories. Before each use, inspect probe and accessories for damage (cuts, tears, or defects in the probe body, accessories, or cable jacket). Do not use if damaged.

Ground-referenced oscilloscope use. Do not float the reference lead of this probe when using with ground-referenced oscilloscopes. The reference lead must be connected to earth potential (0 V).

Floating measurement use. Do not float the reference lead of this probe above the rated float voltage.

Service safety summary

The *Service safety summary* section contains additional information required to safely perform service on the product. Only qualified personnel should perform service procedures. Read this *Service safety summary* and the *General safety summary* before performing any service procedures.

To avoid electric shock. Do not touch exposed connections.

Do not service alone. Do not perform internal service or adjustments of this product unless another person capable of rendering first aid and resuscitation is present.

Disconnect power. To avoid electric shock, switch off the product power and disconnect the power cord from the mains power before removing any covers or panels, or opening the case for servicing.

Use care when servicing with power on. Dangerous voltages or currents may exist in this product. Disconnect power, remove battery (if applicable), and disconnect test leads before removing protective panels, soldering, or replacing components.

Verify safety after repair. Always recheck ground continuity and mains dielectric strength after performing a repair.

Terms in this manual

These terms may appear in this manual:



WARNING. *Warning statements identify conditions or practices that could result in injury or loss of life.*



CAUTION. *Caution statements identify conditions or practices that could result in damage to this product or other property.*

Symbols and terms on the product

These terms may appear on the product:

- DANGER indicates an injury hazard immediately accessible as you read the marking.
- WARNING indicates an injury hazard not immediately accessible as you read the marking.
- CAUTION indicates a hazard to property including the product.



When this symbol is marked on the product, be sure to consult the manual to find out the nature of the potential hazards and any actions which have to be taken to avoid them. (This symbol may also be used to refer the user to ratings in the manual.)

The following symbol(s) may appear on the product:



CAUTION
Refer to Manual



Protective Ground
(Earth) Terminal



Chassis Ground



Standby

Specifications

This chapter contains specifications for the MDO4000C Series oscilloscopes. All specifications are guaranteed unless noted as "typical." Typical specifications are provided for your convenience but are not guaranteed. Specifications that are marked with the ✓ symbol are checked in *Performance Verification*.

All specifications apply to all MDO4000C models unless noted otherwise. To meet specifications, two conditions must first be met:

- The oscilloscope must have been operating continuously for twenty minutes within the specified operating temperature range. (See Table 14 on page 28.)
- You must perform the Signal Path Compensation (SPC) operation described in step 2 of the *Self Test* before evaluating specifications. (See page 85, *Self Test*.) If the operating temperature changes by more than 10 °C (18 °F), you must perform the SPC operation again.

Analog Signal Acquisition System Specifications

The following table shows the specifications for the analog signal acquisition system.

Table 1: Analog signal acquisition system specifications

Characteristic	Description	
Number of input channels	4 analog channels, digitized simultaneously	
Input coupling	DC or AC	
Input resistance selection	1 MΩ or 50 Ω 250 kΩ (to be selected for performance verification only).	
✓ Input impedance, DC coupled	1 MΩ	1 MΩ ±1%
	50 Ω	50 Ω ±1%
	MDO4104C	VSWR ≤1.5:1 from DC to 1 GHz, typical
	MDO4054C	VSWR ≤1.5:1 from DC to 500 MHz, typical
	MDO4034C	VSWR ≤1.5:1 from DC to 350 MHz, typical
	MDO4024C	VSWR ≤1.5:1 from DC to 200 MHz, typical
Input Capacitance, 1 MΩ DC coupled, typical	13 pF ± 2 pF	

Table 1: Analog signal acquisition system specifications (cont.)

Characteristic	Description	
Maximum input voltage	1 M Ω	300 V _{RMS} at the BNC Installation Category II Derate at 20 dB/decade between 4.5 MHz and 45 MHz Derate 14 dB/decade between 45 MHz and 450 MHz Above 450 MHz, 5 V _{RMS} . Maximum peak input voltage at the BNC, ± 424 V
	250 K Ω	75 V _{RMS} at the BNC Installation Category II Derate at 20 dB/decade between 1.3 MHz and 13 MHz Derate 10 dB/decade between 13 MHz and 130 MHz Above 130 MHz, 5 V _{RMS} . Maximum peak input voltage at the BNC, ± 106 V
	50 Ω	5 V _{RMS} with peaks $\leq \pm 20$ V (Duty Factor $\leq 6.25\%$) Overvoltage trip is intended to protect against overloads that might damage termination resistors. A sufficiently large impulse might cause damage regardless of the overvoltage protection circuitry because of the finite time required to detect and respond.
✓ DC Balance	0.1 div with the input DC coupled, set to 50 Ω termination, and input terminated with 50 Ω BNC terminator 0.2 div at 1 mV/div with the input DC coupled, set to 50 Ω termination, and input terminated with 50 Ω BNC terminator 0.2 div with the input DC coupled, set to 1 M Ω termination, and input terminated with 50 Ω BNC terminator 0.225 div at 1 mV/div with the input DC coupled, set to 1 M Ω termination, and input terminated with 50 Ω BNC terminator	
Number of digitized bits	8 bits Displayed vertically with 25 digitization levels (DL) per division, 10.24 divisions dynamic range. "DL" is the abbreviation for "digitization level." A DL is the smallest voltage level change that can be resolved by an A-D Converter. This value is also known as the least significant bit (LSB).	
Sensitivity range (coarse)	1 M Ω	1 mV/div to 10 V/div in a 1-2-5 sequence
	50 Ω	1 mV/div to 1 V/div in a 1-2-5 sequence
Sensitivity range (fine)	1 M Ω	1 mV/div to 5 V/div < -50% to > +50% of selected setting
		10 V/div < -50% to 0%
	Allows continuous adjustment from 1 mV/div to 10 V/div	
	50 Ω	1 mV/div to 500 mV/div < -50% to > +50% of selected setting
1 V/div < -50% to 0%		
Allows continuous adjustment from 1 mV/div to 1 V/div		
Sensitivity resolution (fine), typical	$\leq 1\%$ of current setting	

Table 1: Analog signal acquisition system specifications (cont.)

Characteristic	Description																								
✓ DC gain accuracy	For 50 Ω, 1 MΩ, and 250 kΩ (250 kΩ checked indirectly): ±1.5%, derated at 0.100%/°C above 30 °C ±2.0%, derated at 0.100%/°C above 30 °C, 1 mV/Div setting ±3.0% variable gain, derated at 0.100%/°C above 30 °C																								
Offset ranges, minimum	<table border="1"> <thead> <tr> <th>Volts/div setting</th> <th colspan="2">Offset range</th> </tr> <tr> <th></th> <th>1 MΩ input</th> <th>50 Ω input</th> </tr> </thead> <tbody> <tr> <td>1 mV/div to 50 mV/div</td> <td>±1 V</td> <td>±1 V</td> </tr> <tr> <td>50.5 mV/div to 99.5 mV/div</td> <td>±0.5 V</td> <td>±0.5 V</td> </tr> <tr> <td>100 mV/div to 500 mV/div</td> <td>±10 V</td> <td>±10 V</td> </tr> <tr> <td>505 mV/div to 995 mV/div</td> <td>±5 V</td> <td>±5 V</td> </tr> <tr> <td>1 V/div to 5 V/div</td> <td>±100 V</td> <td>±5 V</td> </tr> <tr> <td>5.05 V/div to 10 V/div</td> <td>±50 V</td> <td>Not applicable</td> </tr> </tbody> </table>	Volts/div setting	Offset range			1 MΩ input	50 Ω input	1 mV/div to 50 mV/div	±1 V	±1 V	50.5 mV/div to 99.5 mV/div	±0.5 V	±0.5 V	100 mV/div to 500 mV/div	±10 V	±10 V	505 mV/div to 995 mV/div	±5 V	±5 V	1 V/div to 5 V/div	±100 V	±5 V	5.05 V/div to 10 V/div	±50 V	Not applicable
	Volts/div setting	Offset range																							
		1 MΩ input	50 Ω input																						
	1 mV/div to 50 mV/div	±1 V	±1 V																						
	50.5 mV/div to 99.5 mV/div	±0.5 V	±0.5 V																						
	100 mV/div to 500 mV/div	±10 V	±10 V																						
	505 mV/div to 995 mV/div	±5 V	±5 V																						
1 V/div to 5 V/div	±100 V	±5 V																							
5.05 V/div to 10 V/div	±50 V	Not applicable																							
For 50 Ω path, 1 V/div is the maximum vertical setting.																									
The input signal cannot exceed Max Input Voltage for the 50 Ω input path. Refer to the Max Input Voltage specification for more information.																									
Position range	±5 divisions																								
✓ Offset accuracy	±[0.005 × offset – position + DC Balance] Both the position and the constant offset term must be converted to volts by multiplying by the appropriate volts/div setting.																								
Number of waveforms for average acquisition mode	2 to 512 waveforms Default of 16 waveforms																								
DC voltage measurement accuracy average acquisition mode	<table border="1"> <thead> <tr> <th>Measurement type</th> <th>DC Accuracy (in Volts)</th> </tr> </thead> <tbody> <tr> <td>Average of ≥ 16 waveforms</td> <td>±[DC Gain Accuracy × reading – (offset - position) + offset accuracy + 0.1 division] Refer to DC Gain Accuracy for temperature derating information.</td> </tr> <tr> <td>Delta Volts between any two averages of ≥16 waveforms acquired with the same oscilloscope setup and ambient conditions</td> <td>±[DC gain accuracy × reading + 0.05 div] Refer to DC Gain Accuracy for temperature derating information.</td> </tr> </tbody> </table>	Measurement type	DC Accuracy (in Volts)	Average of ≥ 16 waveforms	±[DC Gain Accuracy × reading – (offset - position) + offset accuracy + 0.1 division] Refer to DC Gain Accuracy for temperature derating information.	Delta Volts between any two averages of ≥16 waveforms acquired with the same oscilloscope setup and ambient conditions	±[DC gain accuracy × reading + 0.05 div] Refer to DC Gain Accuracy for temperature derating information.																		
	Measurement type	DC Accuracy (in Volts)																							
Average of ≥ 16 waveforms	±[DC Gain Accuracy × reading – (offset - position) + offset accuracy + 0.1 division] Refer to DC Gain Accuracy for temperature derating information.																								
Delta Volts between any two averages of ≥16 waveforms acquired with the same oscilloscope setup and ambient conditions	±[DC gain accuracy × reading + 0.05 div] Refer to DC Gain Accuracy for temperature derating information.																								
Offset, position, and the constant offset term must be converted to volts by multiplying by the appropriate volts/div setting.																									
The basic accuracy specification applies directly to any sample and to the following measurements: High, Low, Max, Min, Mean, Cycle Mean, RMS, and Cycle RMS. The delta volt accuracy specification applies to subtractive calculations involving two of these measurements.																									
The delta volts (difference voltage) accuracy specification applies directly to the following measurements: Positive Overshoot, Negative Overshoot, Pk-Pk, and Amplitude.																									

Table 1: Analog signal acquisition system specifications (cont.)

Characteristic	Description	
DC voltage measurement accuracy Sample acquisition mode, typical	<i>Measurement type</i>	<i>DC Accuracy (in volts)</i>
	Any sample	$\pm[\text{DC gain accuracy} \times \text{reading} - (\text{offset} - \text{position}) + \text{Offset Accuracy} + 0.15 \text{ div} + 0.6 \text{ mV}]$ Refer to DC Gain Accuracy for temperature derating information.
	Delta volts between any two samples acquired with the same oscilloscope setup and ambient conditions	$\pm[\text{DC gain accuracy} \times \text{reading} + 0.15 \text{ div} + 1.2 \text{ mV}]$ Refer to DC Gain Accuracy for temperature derating information.
Offset, position, and the constant offset term must be converted to volts by multiplying by the appropriate volts/div setting.		

Table 1: Analog signal acquisition system specifications (cont.)

Characteristic	Description																																																													
Analog bandwidth selections	MDO4104C, MDO4054C, MDO4034C: 20 MHz, 250 MHz, and Full MDO4024C: 20 MHz and Full																																																													
✓ Analog bandwidth, DC coupled	These limits are for ambient temperature of $\leq 30^{\circ}\text{C}$ and the bandwidth selection set to FULL. Reduce the upper bandwidth frequency by 1% for each $^{\circ}\text{C}$ above 30°C																																																													
	<table border="1"> <thead> <tr> <th></th> <th></th> <th>Volts/Div setting</th> <th>Bandwidth</th> </tr> </thead> <tbody> <tr> <td rowspan="9">50 Ω</td> <td rowspan="3">MDO4104C</td> <td>5 mV/div — 1 V/div</td> <td>DC to 1.00 GHz</td> </tr> <tr> <td>2 mV/div — 4.98 mV/div</td> <td>DC to 350 MHz</td> </tr> <tr> <td>1 mV/div — 1.99 mV/div</td> <td>DC to 175 MHz</td> </tr> <tr> <td rowspan="3">MDO4054C</td> <td>5 mV/div — 1 V/div</td> <td>DC to 500 MHz</td> </tr> <tr> <td>2 mV/div — 4.98 mV/div</td> <td>DC to 350 MHz</td> </tr> <tr> <td>1 mV/div — 1.99 mV/div</td> <td>DC to 175 MHz</td> </tr> <tr> <td rowspan="2">MDO4034C</td> <td>2 mV/div — 1 V/div</td> <td>DC to 350 MHz</td> </tr> <tr> <td>1 mV/div — 1.99 mV/div</td> <td>DC to 175 MHz</td> </tr> <tr> <td rowspan="2">MDO4024C</td> <td>2 mV/div — 1 V/div</td> <td>DC to 200 MHz</td> </tr> <tr> <td>1 mV/div — 1.99 mV/div</td> <td>DC to 175 MHz</td> </tr> <tr> <td rowspan="15">1 MΩ, typical</td> <td rowspan="3">MDO4104C</td> <td>5 mV/div — 10 V/div</td> <td>DC to 500 MHz</td> </tr> <tr> <td>2 mV/div — 4.98 mV/div</td> <td>DC to 350 MHz</td> </tr> <tr> <td>1 mV/div — 1.99 mV/div</td> <td>DC to 175 MHz</td> </tr> <tr> <td rowspan="3">MDO4054C (without option SA3 or SA6)</td> <td>5 mV/div — 10 V/div</td> <td>DC to 500 MHz</td> </tr> <tr> <td>2 mV/div — 4.98 mV/div</td> <td>DC to 350 MHz</td> </tr> <tr> <td>1 mV/div — 1.99 mV/div</td> <td>DC to 175 MHz</td> </tr> <tr> <td rowspan="3">MDO4054C (option SA3 or SA6)</td> <td>5 mV/div — 10 V/div</td> <td>DC to 380 MHz</td> </tr> <tr> <td>2 mV/div — 4.98 mV/div</td> <td>DC to 350 MHz</td> </tr> <tr> <td>1 mV/div — 1.99 mV/div</td> <td>DC to 175 MHz</td> </tr> <tr> <td rowspan="2">MDO4034C</td> <td>2 mV/div — 10 V/div</td> <td>DC to 350 MHz</td> </tr> <tr> <td>1 mV/div — 1.99 mV/div</td> <td>DC to 175 MHz</td> </tr> <tr> <td rowspan="2">MDO4024C</td> <td>2 mV/div — 10 V/div</td> <td>DC to 200 MHz</td> </tr> <tr> <td>1 mV/div — 1.99 V/div</td> <td>DC to 175 MHz</td> </tr> </tbody> </table>			Volts/Div setting	Bandwidth	50 Ω	MDO4104C	5 mV/div — 1 V/div	DC to 1.00 GHz	2 mV/div — 4.98 mV/div	DC to 350 MHz	1 mV/div — 1.99 mV/div	DC to 175 MHz	MDO4054C	5 mV/div — 1 V/div	DC to 500 MHz	2 mV/div — 4.98 mV/div	DC to 350 MHz	1 mV/div — 1.99 mV/div	DC to 175 MHz	MDO4034C	2 mV/div — 1 V/div	DC to 350 MHz	1 mV/div — 1.99 mV/div	DC to 175 MHz	MDO4024C	2 mV/div — 1 V/div	DC to 200 MHz	1 mV/div — 1.99 mV/div	DC to 175 MHz	1 M Ω , typical	MDO4104C	5 mV/div — 10 V/div	DC to 500 MHz	2 mV/div — 4.98 mV/div	DC to 350 MHz	1 mV/div — 1.99 mV/div	DC to 175 MHz	MDO4054C (without option SA3 or SA6)	5 mV/div — 10 V/div	DC to 500 MHz	2 mV/div — 4.98 mV/div	DC to 350 MHz	1 mV/div — 1.99 mV/div	DC to 175 MHz	MDO4054C (option SA3 or SA6)	5 mV/div — 10 V/div	DC to 380 MHz	2 mV/div — 4.98 mV/div	DC to 350 MHz	1 mV/div — 1.99 mV/div	DC to 175 MHz	MDO4034C	2 mV/div — 10 V/div	DC to 350 MHz	1 mV/div — 1.99 mV/div	DC to 175 MHz	MDO4024C	2 mV/div — 10 V/div	DC to 200 MHz	1 mV/div — 1.99 V/div	DC to 175 MHz
		Volts/Div setting	Bandwidth																																																											
50 Ω	MDO4104C	5 mV/div — 1 V/div	DC to 1.00 GHz																																																											
		2 mV/div — 4.98 mV/div	DC to 350 MHz																																																											
		1 mV/div — 1.99 mV/div	DC to 175 MHz																																																											
	MDO4054C	5 mV/div — 1 V/div	DC to 500 MHz																																																											
		2 mV/div — 4.98 mV/div	DC to 350 MHz																																																											
		1 mV/div — 1.99 mV/div	DC to 175 MHz																																																											
	MDO4034C	2 mV/div — 1 V/div	DC to 350 MHz																																																											
		1 mV/div — 1.99 mV/div	DC to 175 MHz																																																											
	MDO4024C	2 mV/div — 1 V/div	DC to 200 MHz																																																											
1 mV/div — 1.99 mV/div		DC to 175 MHz																																																												
1 M Ω , typical	MDO4104C	5 mV/div — 10 V/div	DC to 500 MHz																																																											
		2 mV/div — 4.98 mV/div	DC to 350 MHz																																																											
		1 mV/div — 1.99 mV/div	DC to 175 MHz																																																											
	MDO4054C (without option SA3 or SA6)	5 mV/div — 10 V/div	DC to 500 MHz																																																											
		2 mV/div — 4.98 mV/div	DC to 350 MHz																																																											
		1 mV/div — 1.99 mV/div	DC to 175 MHz																																																											
	MDO4054C (option SA3 or SA6)	5 mV/div — 10 V/div	DC to 380 MHz																																																											
		2 mV/div — 4.98 mV/div	DC to 350 MHz																																																											
		1 mV/div — 1.99 mV/div	DC to 175 MHz																																																											
	MDO4034C	2 mV/div — 10 V/div	DC to 350 MHz																																																											
		1 mV/div — 1.99 mV/div	DC to 175 MHz																																																											
	MDO4024C	2 mV/div — 10 V/div	DC to 200 MHz																																																											
		1 mV/div — 1.99 V/div	DC to 175 MHz																																																											
	Lower frequency limit, AC coupled, typical	< 10 Hz when AC, 1 M Ω coupled The AC coupled lower frequency limits are reduced by a factor of 10 when 10X passive probes are used.																																																												
	Upper frequency limit, 250 MHz bandwidth limited, typical	250 MHz, $\pm 20\%$, all models except MDO4024C																																																												
Upper frequency limit, 20 MHz bandwidth limited, typical	20 MHz, $\pm 20\%$																																																													

Table 1: Analog signal acquisition system specifications (cont.)

Calculated rise time at $0.350/BW = t_r$, typical	The formula is calculated by measuring the -3 dB bandwidth of the oscilloscope. The formula accounts for the rise time contribution of the oscilloscope independent of the rise time of the signal source.			
	<i>Model</i>	50 Ω 1 mV/div to 1.99 mV/div	50 Ω 2 mV/div to 4.98 mV/div	50 Ω 5 mV/div to 1 V/div
	MDO4104C	≤2 ns	≤1 ns	≤350 ps
	MDO4054C	≤2 ns	≤1 ns	≤700 ps
	MDO4034C	≤2 ns	≤1 ns	≤1 ns
	MDO4024C	≤2 ns	≤1.75 ns	≤1.75 ns
	<i>Model</i>	TPP1000 probe 10 mV/div to 19.9 mV/div	TPP1000 probe 20 mV/div to 49.8 mV/div	TPP1000 probe 50 mV/div to 10 V/div
	MDO4104C	≤2 ns	≤1 ns	≤350 ps
	MDO4054C	≤2 ns	≤1 ns	≤700 ps
	MDO4034C	≤2 ns	≤1 ns	≤1 ns
	MDO4024C	≤2 ns	≤1.75 ns	≤1.75 ns
	<i>Model</i>	TPP0500 probe 10 mV/div to 19.9 mV/div	TPP0500 probe 20 mV/div to 49.8 mV/div	TPP0500 probe 50 mV/div to 10 V/div
	MDO4104C	≤2 ns	≤1 ns	≤700 ps
	MDO4054C	≤2 ns	≤1 ns	≤700 ps
	MDO4034C	≤2 ns	≤1 ns	≤1 ns
	MDO4024C	≤2 ns	≤1.75 ns	≤1.75 ns
Peak Detect or Envelope mode pulse response, typical	<i>Model</i>	<i>Minimum pulse width</i>		
	MDO4104C (option SA3 or SA6 and ≤2 channels enabled)	>800 ps (5 GS/s)		
	MDO4104C without options SA3 or SA6	>1.6 ns (2.5 GS/s)		
	MDO4104C (option SA3 or SA6 and ≥3 channels enabled), MDO4054C, MDO4034C, MDO4024C	>1.6 ns (2.5 GS/s)		

Table 1: Analog signal acquisition system specifications (cont.)

✓ Random Noise	<i>Vertical scale setting</i>	50 Ω, RMS, typical		
		MDO4104C (all configurations)	MDO4054C, MDO4034C, MDO4024C (with option SA3 or SA6)	MDO4054C, MDO4034C, MDO4024C (without option SA3 or SA6)
	1 mV/div	≤ 0.093 mV	≤ 0.084 mV	≤ 0.163 mV
	100 mV/div	≤ 3.31 mV	≤ 2.37 mV	≤ 2.01 mV
	1 V/div	≤ 24.27 mV	≤ 20.62 mV	≤ 20.51 mV
	<i>Vertical scale setting</i>	50 Ω, Full BW (mV)		
		MDO4104C	MDO40X4C (with option SA3 or SA6)	MDO40X4C (without RF)
	1 mV	0.14	0.21	0.21
	2 mV	0.20	0.29	0.29
	5 mV	0.38	0.53	0.53
	10 mV	0.68	0.93	0.93
	20 mV	1.28	1.73	1.73
	50 mV	3.08	4.13	4.13
100 mV	6.08	8.13	8.13	
200 mV	12.08	16.13	16.13	
500 mV	30.08	40.13	40.13	
1 V	60.08	80.13	80.13	
Delay between channels, full bandwidth, typical	<p>≤100 ps between any two analog channels with input impedance set to 50 Ω, DC coupling, with equal volts/division setting or above 10 mV/div</p> <p>All settings in the instrument can be manually time aligned using the Probe Deskew function from -125 ns to +125 ns with a resolution of 20 ps</p> <p>This specification does not pertain to the RF channel. For RF channel delay, see the RF Input Specifications.</p>			
Deskew range	-125 ns to +125 ns with a resolution of 20 ps			
Crosstalk (channel isolation), typical	≥100:1 at ≤100 MHz and ≥30:1 at >100 MHz up to the rated bandwidth for any two channels having equal Volts/Div settings			
TekVPI Interface	<p>The probe interface allows installing, powering, compensating, and controlling a wide range of probes offering a variety of features.</p> <p>The interface is available on all front panel inputs. (RF channel requires TPA-N-VPI adapter.)</p>			
Total probe power	<p>Five Tektronix VPI-compliant probe interfaces (one per channel). (RF channel requires TPA-N-VPI adapter.)</p> <p>50 W maximum internal probe power (total for all 5 VPI ports)</p>			
Probe power per channel	<i>Voltage</i>	<i>Max Amperage</i>	<i>Voltage Tolerance</i>	
	5 V	60 mA (300 mW)	±10%	
	12 V	2 A (24 W)	±10%	

Time Base System Specifications

The following table shows the horizontal and acquisition system specifications for the MDO4000C Series oscilloscopes.

Table 2: Time base system specifications

Characteristic	Description				
Sample-rate range	MDO4104C (no SA3 or SA6)	2.5 S/s – 5 GS/s (1 – 4 analog channels enabled)			
	MDO4104C (options SA3 or SA6)	2.5 S/s – 5 GS/s (1 – 2 analog channels enabled)		2.5 S/s – 2.5 GS/s (3 – 4 analog channels enabled)	
		MDO4054C MDO4034C MDO4024C			
	Record Length Range	20 M, 10 M, 1 M, 100 k, 10 k, 1 k			
Seconds/Division range	<i>Instrument</i>	<i>1 k</i>	<i>10 k</i>	<i>100 k – 20 M</i>	
	MDO4104C (option SA3 or SA6, 2 channels enabled)	400 ps – 40 s	400 ps – 400 s	400 ps – 1,000 s	
	MDO4104C (no SA3 or SA6, all channels enabled)				
	MDO4104C (option SA3 or SA6, ≥3 channels enabled)	1 ns – 40 s	1 ns – 400 s	1 ns – 1,000 s	
Maximum triggered acquisition rate		1 and 2 channels		3 and 4 channels	
	Bandwidth	FastAcq	DPO	FastAcq	DPO
	1 GHz	>340,000 wfm/s	> 80,000 wfm/s	>270,000 wfm/s	> 50,000 wfm/s
	< 1 GHz	>270,000 wfm/s	> 50,000 wfm/s	>270,000 wfm/s	> 50,000 wfm/s
	Aperture Uncertainty	Bandwidth	Aperture Uncertainty Max. (record length of 100,000)		
	200 MHz	7 ps			
	350 MHz	7 ps			
	500 MHz	5 ps			
	1 GHz	3 ps			

Table 2: Time base system specifications (cont.)

Characteristic	Description				
✓ Reference frequency error (cumulative)	Model	Description	Spec	CRI	
	Instruments with option SA3 or SA6	Cumulative error	$\pm 1.6 \times 10^{-6}$	Includes allowances for Aging per Year, Reference Frequency Calibration Accuracy, and Temperature Stability Valid over the recommended 1 year calibration interval, from 0 °C to +50 °C.	✓
		Temperature stability	$\pm 25 \times 10^{-9}$ total from 0 °C to +50 °C		
		Crystal aging	Aging Per Year: $\pm 1.0 \times 10^{-6}$		
	Instruments without option SA3 or SA6	Factory tolerance	$\pm 1.5\text{PPM}$	At Calibration, 25 °C ambient, over any ≥ 1 ms interval.	✓
		Temperature stability	$\pm 2.5\text{PPM}$	Tested at operating temperatures.	
		Crystal aging	$\pm 1.0\text{PPM/Year}$	Frequency tolerance change at 25 °C over a period of 1 year	
Reference frequency calibration accuracy		$\pm 0.5 \times 10^{-6}$ for options SA3 or SA6 when operated within 23 °C \pm 5 °C, after 30 minute warm-up 1.5 ppm for models without options SA3 or SA6, when operated within 23 °C \pm 5 °C, after 30 minute warm-up Accuracy at time of factory calibration. Recommended accuracy at beginning of calibration interval.			

Table 2: Time base system specifications (cont.)

Characteristic	Description
✓ Delta-time measurement accuracy	<p>The formula to calculate the delta-time measurement accuracy (DTA) for a given instrument setting and input signal is given in the following table. (See Table 3.) The formula assumes insignificant signal content above Nyquist and insignificant error due to aliasing. The abbreviations used in the formula are as follows:</p> <p>SR₁ = slew rate around 1st point in measurement (1st edge) SR₂ = slew rate around 2nd point in measurement (2nd edge) N = input-referred noise (V_{RMS}) (Refer to <i>Random Noise</i> and <i>Sample Acquisition Mode</i> specifications.) TBA = time base accuracy (±1.6x 10⁻⁶ for models with option SA3 or SA6, ±5.0 x 10⁻⁶ for models without option SA3 or SA6) (Refer to <i>Reference Frequency Error (Cumulative)</i> specifications.) t_p = delta-time measurement duration (sec) RD = (record length)/(sample rate) t_{sr} = 1/(sample rate) assume edge shape that results from Gaussian filter response</p> <hr/> <p>The term under the squareroot sign is the stability and is due to TIE (Time Interval Error). The errors due to this term occur throughout a single-shot measurement. The second term is due to both the absolute center-frequency accuracy and the center-frequency stability of the time base and varies between multiple single-shot measurements over the observation interval (the amount of time from the first single-shot measurement to the final single-shot measurement).</p>

Table 3: Delta-time measurement accuracy formula

The terms used in these formulas are defined under *Delta-time measurement accuracy*, in the preceding table. (See Table 2.)

$$DTA_{pk-pk} = \pm 5 \times \sqrt{2 \left[\frac{N}{SR_1} \right]^2 + 2 \left[\frac{N}{SR_2} \right]^2 + (3ps + 1 \times 10^{-7} \times RD)^2 + 2t_{sr} + TBA \times t_p}$$

$$DTA_{rms} = \sqrt{2 \left[\frac{N}{SR_1} \right]^2 + 2 \left[\frac{N}{SR_2} \right]^2 + (3ps + 1 \times 10^{-7} \times RD)^2 + \left(\frac{2 \times t_{sr}}{\sqrt{12}} \right)^2 + TBA \times t_p}$$

Triggering System Specifications

The following table shows the trigger specifications for analog and digital channels on the MDO4000C Series oscilloscopes. These specifications do not apply to the RF input channel.

NOTE. For RF, see the RF input specifications. (See page 18.)

Table 4: Trigger specifications

Characteristic	Description	
AUX IN (external) trigger	Input impedance	1 M Ω \pm 1% in parallel with 13 pF \pm 2 pF.
	Maximum input voltage	The maximum input voltage at the BNC, 300 V RMS. Installation Category II (CAT II). Derate at 20 dB/decade above 3 MHz to 30 V RMS at 30 MHz, 10 dB/decade above 30 MHz.
	Bandwidth	250 MHz \pm 20%
Trigger bandwidth, Edge, typical	MDO4104C	1 GHz
	MDO4054C	500 MHz
	MDO4034C	350 MHz
	MDO4024C	200 MHz
Trigger bandwidth, Pulse and Logic, typical	MDO4104C	1 GHz
	MDO4054C	500 MHz
	MDO4034C	350 MHz
	MDO4024C	200 MHz
Edge-type trigger sensitivity, DC coupled, typical	<i>Trigger Source</i>	<i>Sensitivity</i>
	Any input channel	1 mV/div to 4.98 mV/div: 1.8 div. 5 mV/div to 9.98 mV/div: 1.2 div. 10 mV/div to 19.98 mV/div: 0.6 div. \geq 20 mV/div: 0.5 div.
	Aux In (External) (Not available for MDO4XX4C on products with option SA3 or SA6)	200 mV from DC to 50 MHz, increasing to 500 mV at 250 MHz.
	Line	Fixed
Trigger jitter, typical	\leq 10 pS _{RMS} for edge-type trigger	
	\leq 100 pS _{RMS} for non edge-type trigger modes	

Table 4: Trigger specifications (cont.)

Characteristic	Description
Edge-type trigger sensitivity, not DC coupled, typical	<i>Trigger Coupling</i>
	AC Coupling
	NOISE REJ
	HF REJ
	LF REJ
Video-type trigger formats and field rates	Triggers from negative sync composite video, field 1, or field 2 for interlaced systems, on any field, specific line, or any line for interlaced or noninterlaced systems. Supported systems include NTSC, PAL, and SECAM.
Video-type trigger sensitivity, typical	<i>Delayed and main trigger.</i> Not supported through Aux In on models with option SA3 or SA6.
	<i>Source</i>
	<i>Sensitivity</i>
Lowest frequency for successful operation of "Set Level to 50%" function, typical	45 Hz
Logic-type or logic qualified trigger or events-delay sensitivities, DC coupled, typical	1.0 vertical division from DC to maximum bandwidth without exceeding pulse width requirements specified for logic triggering.
Pulse-type runt trigger sensitivities, typical	1.0 vertical division from DC to maximum bandwidth without exceeding the pulse width requirements specified for pulse type triggering.
Pulse-type trigger width and glitch sensitivities, typical	1.0 division
Logic-type triggering, minimum logic or rearm time, typical	For all vertical settings, the minimums are:
	<i>Trigger type</i>
	<i>Pulse width</i>
	<i>Re-arm time</i>
	<i>Time between channels</i>
Logic	Not applicable
Time Qualified Logic	4 ns
	2 ns
	1.5 ns
	For logic, the time between channels refers to the length of time a logic state derived from more than one channel must exist to be recognized. For events, the time is the minimum time between a main and delayed event that will be recognized if more than one channel is used.
Minimum clock pulse widths for setup/hold time violation trigger, typical	<i>For all vertical settings, the minimums are:</i>
	<i>Clock active</i>
	<i>Clock inactive</i>
	User hold time + 2.5 ns
	2 ns
	An active pulse width is the width of the clock pulse from its active edge (as defined in the Clock Edge lower-bezel menu item) to its inactive edge. An inactive pulse width is the width of the pulse from its inactive edge to its active edge.
	The user hold time is the number selected by the user.

Table 4: Trigger specifications (cont.)

Setup/hold violation trigger, setup and hold time ranges	<i>Feature</i>	<i>Min</i>	<i>Max</i>
	Setup time	-0.5 ns	1.0 ms
	Hold time	1 ns	1.0 ms
	Setup + Hold time	0.5 ns	2.0 ms
Input coupling on clock and data channels must be the same.			
For Setup time, positive numbers mean a data transition before the clock.			
For Hold time, positive numbers mean a data transition after the clock edge.			
Setup + Hold time is the algebraic sum of the Setup Time and Hold Time that you programmed.			
Pulse type trigger, minimum pulse, rearm time, transition time	<i>Pulse class</i>	<i>Minimum pulse width</i>	<i>Minimum rearm time</i>
	Glitch	4 ns	2 ns + 5% of glitch width setting
	Runt	4 ns	2 ns
	Time-qualified runt	4 ns	8.5 ns + 5% of width setting
	Width	4 ns	2 ns + 5% of width upper limit setting
	Slew rate (transition time)	4 ns	8.5 ns + 5% of delta time setting
For the trigger class width and the trigger class runt, the pulse width refers to the width of the pulse being measured. The rearm time refers to the time between pulses.			
For the trigger class slew rate, the pulse width refers to the delta time being measured. The rearm time refers to the time it takes the signal to cross the two trigger thresholds again.			
Transition time trigger, delta time range	4 ns to 8 s		
Time range for glitch, pulse width, timeout, or time-qualified runt triggering	4 ns to 8 s		
Time Accuracy for pulse width or timeout triggering	<i>Time Range</i>	<i>Accuracy</i>	
	1 ns to 500 ns	±(20% of setting + 0.5 ns)	
	520 ns to 1 s	±(0.01% of setting + 100 ns)	
B trigger after events, minimum pulse width and maximum event frequency, typical	4 ns, 500 MHz		
B trigger, minimum time between arm and trigger, typical	4 ns		
	For trigger after time, this is the time between the end of the time period and the B trigger event. For trigger after events, this is the time between the last A trigger event and the first B trigger event.		
B trigger after time, time range	4 ns to 8 seconds		
B trigger after events, event range	1 to 4,000,000		

Table 4: Trigger specifications (cont.)

Trigger level ranges	<i>Source</i>	<i>Range</i>
	Any input channel	±8 divisions from center of screen ±8 divisions from 0 V when vertical LF reject trigger coupling is selected
	Aux In for instruments without option SA3 or SA6	±8 V
	Line	Not applicable
	Line trigger level is fixed at about 50% of the line voltage. This specification applies to logic and pulse thresholds.	
Trigger level accuracy, DC coupled, typical	For signals having rise and fall times ≥10 ns.	
	<i>Source</i>	<i>Range</i>
	Any input channel	±0.20 div
	Aux In for instruments without option SA3 or SA6	± (10% of setting + 25mV)
	Line	Not applicable
Trigger holdoff range	20 ns minimum to 8 s maximum	
Maximum serial trigger bits	128 bits	
Optional serial bus interface triggering		
I ² C	Address Triggering: 7 and 10 bit user specified addresses, as well as General Call, START byte, HS-mode, EEPROM, and CBUS Data Trigger: 1 to 5 bytes of user specified data Trigger On: Start, Repeated Start, Stop, Missing Ack, Address, Data, or Address and Data Maximum Data Rate: 10 Mbps	
SPI	Data Trigger: 1 to 16 bytes of user-specified data Trigger On: SS Active, MOSI, MISO, or MOSI & MISO Maximum Data Rate: 50 Mbps	
CAN	Data Trigger: 1 to 8 bytes of user-specified data, including qualifiers of equal to (=), not equal to (<>), less than (<), greater than (>), less than or equal to (<=), greater than or equal to (>=) Trigger On: Start of Frame, Type of Frame, Identifier, Data, Identifier and Data, End of Frame, Missing Ack, or Bit Stuffing Errors Frame Type: Data, Remote, Error, Overload Identifier: Standard (11 bit) and Extended (29 bit) identifiers Maximum Data Rate: 1 Mbps	
LIN	Identifier Trigger: 6 bits of user-specified data, equal to (=) Data Trigger: 1 to 8 bytes of user-specified data, including qualifiers of equal to (=), not equal to (<>), less than (<), greater than (>), less than or equal to (<=), greater than or equal to (>=), inside range, or outside range Error: Sync, Identifier Parity, Checksum Trigger On: Sync, Identifier, Data, Identifier & Data, Wakeup Frame, Sleep Frame, or Error Maximum Data Rate: 100 kbps	

Table 4: Trigger specifications (cont.)

FlexRay	<p>Indicator bits: Normal Frame, Payload Frame, Null Frame, Sync Frame, Startup Frame</p> <p>Identifier Trigger: 11 bits of user-specified data, equal to (=), not equal to (<>), less than (<), greater than (>), less than or equal to (<=), greater than or equal to (>=), Inside Range, or Outside Range</p> <p>Cycle Count Trigger: 6 bits of user-specified data, equal to (=)</p> <p>Header Fields Trigger: 40 bits of user-specified data comprising Indicator Bits, Identifier, Payload Length, Header CRC, Cycle Count, equal to (=)</p> <p>Data Trigger: 1 to 16 Bytes of user-specified data, with 0 to 253, or "don't care" bytes of data offset, including qualifiers of equal to (=), not equal to <>, less than (<), greater than (>), less than or equal to (<=), greater than or equal to (>=), Inside Range, Outside Range</p> <p>End Of Frame: User-chosen types Static, Dynamic (DTS), and All</p> <p>Error: Header CRC, Trailer CRC, Null Frame-static, Null Frame-dynamic, Sync Frame, Startup Frame</p> <p>Trigger On: Start of Frame, Type of Frame, Indicator Bits, Identifier, Cycle Count, Header Fields, Data, Identifier & Data, End of Frame, or Error</p> <p>Maximum Data Rate: 100 Mbps</p>
Audio	
I ² S	<p>Data Trigger: 32 bits of user-specified data in a left word, right word, or either, including qualifiers of equal to (=), not equal to <>, less than (<), greater than (>), less than or equal to (<=), greater than or equal to (>=), inside range, outside range</p> <p>Trigger on: Word Select, Data</p> <p>Maximum Data Rate: 12.5 Mbps</p>
Left Justified	<p>Data Trigger: 32 bits of user-specified data in a left word, right word, or either, including qualifiers of equal to (=), not equal to <>, less than (<), greater than (>), less than or equal to (<=), greater than or equal to (>=), inside range, outside range</p> <p>Trigger on: Word Select, Data</p> <p>Maximum Data Rate: 12.5 Mbps</p>
Right Justified	<p>Data Trigger: 32 bits of user-specified data in a left word, right word, or either, including qualifiers of equal to (=), not equal to <>, less than (<), greater than (>), less than or equal to (<=), greater than or equal to (>=), inside range, outside range</p> <p>Trigger on: Word Select, Data</p> <p>Maximum Data Rate: 12.5 Mbps</p>
TDM	<p>Data Trigger: 32 bits of user-specified data in a channel 0-7, including qualifiers of equal to (=), not equal to <>, less than (<), greater than (>), less than or equal to (<=), greater than or equal to (>=), inside range, outside range</p> <p>Trigger on: Frame Sync, Data</p> <p>Maximum Data Rate: 25 Mbps</p>
RS-232	<p>Bit Rate: 50 bps to 10 Mbps</p> <p>Data Bits: 7, 8, or 9</p> <p>Parity: None, Odd, or Even</p> <p>Trigger on: Tx Start bit, Rx Start bit, Tx End of Packet, Rx End of Packet, Tx Data, Rx Data, Tx Parity Error, Rx Parity Error</p> <p>End of Packet: 00 (NUL), OA (LF), OD (CR), 20 (SP), FF</p>

Table 4: Trigger specifications (cont.)

MIL-STD-1553	<p>Bit Rate: 1 Mb/s</p> <p>Trigger on: Sync, Word Type (Command, Status, Data), Command Word (set RT Address (=, ≠, <, >, ≤, ≥, inside range, outside range), T/R, Sub-address/Mode, Data Word Count/Mode Code, and Parity individually), Status Word (set RT Address ((=, ≠, <, >, ≤, ≥, inside range, outside range), Message Error, Instrumentation, Service Request Bit, Broadcast Command Received, Busy, Subsystem Flag, Dynamic Bus Control Acceptance (DBCA), Terminal Flag, and Parity individually) Data Word (user-specified 16-bit data value) Error (Sync, Parity, Manchester, Non-contiguous data) Idle Time (minimum time selectable from 4 μs to 100 μs; maximum time selectable from 12 μs to 100 μs; trigger on < minimum, > maximum, inside range, outside range)</p> <p>Trigger selection of Command Word will trigger on Command and ambiguous Command/Status words. Trigger selection of Status Word will trigger on Status and ambiguous Command/Status words.</p>
USB	<p>Data Rates Supported: HS: 480 Mbps, Full: 12 Mbps, Low: 1.5 Mbps</p> <p>Trigger On: Sync, Reset, Suspend, Resume, End of Packet, Token (Address) Packet, Data Packet, Handshake Packet, Special Packet, Error</p> <p>NOTE. <i>HIGH SPEED support available only on the MDO4104C oscilloscope.</i></p>
Ethernet	<p>Bit Rate: 10BASE-T, 10 Mbps; 100BASE-TX, 100 Mbps</p> <p>Trigger On: Start Frame Delimiter (SFD), MAC Address, MAC Length/Type, IP Header, TCP Header, TCP/IPv4/MAC Client Data, End of Packet, Idle, FCS (CRC) Error, MAC Q-Tag Control Information.</p>

Digital Acquisition System Specifications

The following table shows the digital acquisition specifications for the MDO4000C Series oscilloscopes.

Table 5: Digital acquisition specifications

Characteristic	Description
Threshold voltage range	-40 V to +40 V
Digital channel timing resolution	2 ns main memory, 60.6 ps for MagniVu memory
✓ Logic threshold accuracy	±(100 mV + 3% of threshold setting after calibration) Requires valid SPC, as described in step 2 of the <i>Self Test</i> . (See page 85, <i>Self Test</i> .)
Minimum detectable pulse width, typical	1 ns Using MagniVu memory. Requires the use of 342-1140-00 ground clip on each channel.

P6616 Digital Probe Input Specifications

The following table shows the P6616 Digital Probe specifications.

Table 6: P6616 digital probe input specifications

Characteristic	Description
Number of channels	16 digital inputs
Input resistance, typical	100 k Ω to ground
Input capacitance, typical	3.0 pF Measured at the podlet input. Requires the use of 342-1140-00 ground clip on each channel
Minimum input signal swing, typical	400 mV _{p-p} Requires the use of 342-1140-00 ground clip on each channel
Maximum input signal swing, typical	30 V _{p-p} for $f_{in} \leq 200$ MHz (centered around the DC threshold voltage) at the P6616 probe tip. 10 V _{p-p} for $f_{in} > 200$ MHz (centered around the DC threshold voltage) at the P6616 probe tip. Failure to meet this input signal requirement will compromise the AC performance of the digital channel. It might also damage the input circuitry. See the Absolute maximum input voltage specification.
Maximum Input Toggle Rate, typical	500 MHz Maximum frequency sine wave input (at the minimum signal swing amplitude) that can accurately be reproduced as a logic square wave. Requires the use of a 342-1140-00 ground clip on each channel. Higher toggle rates can be achieved with higher amplitudes.
Absolute maximum input voltage, typical	± 42 V peak at the P6616 input (not at the instrument input) Probe input voltages beyond this limit could permanently damage the instrument and the P6616 probe.
Channel-to-channel skew, typical	200 ps Digital channel to digital channel only. This is the propagation path skew and ignores skew contributions due to threshold inaccuracies (see Threshold accuracy) and sample binning (see Digital channel timing resolution). Factory calibration/deskew is required to achieve this number.

RF Input Specifications

The following table shows the RF input specifications for the MDO4000C Series oscilloscopes with option SA3 or SA6.

Table 7: RF input specifications

Characteristic	Description
Center frequency range	MDO4XXXC option SA6 9 kHz to 6 GHz
	MDO4XXXC option SA3 9 kHz to 3 GHz
Frequency measurement resolution	1 Hz
Span	MDO4XX4C option SA6 Span: 1 kHz to 6 GHz MDO4XX4C option SA3 Span: 1 kHz to 3 GHz Span adjustable in 1-2-5 sequence Variable resolution = 1% of the next span setting
Resolution bandwidth (RBW) range	Adjustable in 1-2-3-5 sequence. RBW ranges for the Windowing functions are as follows: Kaiser (default), Blackman-Harris: 20 Hz – 200 MHz Rectangular, Hamming, Hanning: 10 Hz – 200 MHz Flat-Top: 30 Hz – 200 MHz Kaiser, Blackman-Harris RBW shape factor: 60 dB / 3 dB shape factor: $\geq 4:1$ ratio
Input vertical range	Vertical measurement range +30 dBm to DANL. Vertical setting of 1 dB/div to 20 dB/div in a 1-2-5 sequence
Level display range	Log scale and units: dBm, dBmV, dB μ V, dB μ W, dBmA, dB μ A Measurement points: 1000 Marker level readout resolution: Log scale: 0.1 dB Maximum number of RF traces: 4 Trace functions: maximum hold, average, minimum hold, normal, spectrogram slice (uses normal trace) Detection methods: positive-peak, negative-peak, sample, average
Reference level	Setting range: –140 dBm to +30 dBm, in steps of 1 dB Default setting: 0 dBm
Vertical position	–100 divisions to +100 divisions (displayed in dB)
Maximum operating input level	Average continuous power: +30 dBm (1 W) for reference levels \geq -20 dBm Average continuous power: +24 dBm (0.25 W) for reference levels < -20 dBm DC maximum before damage: $\pm 40 V_{dc}$ Maximum “no damage”: 32 dBm (1.6 W) CW for reference levels \geq -20 dBm 25 dBm (0.32 W) for reference levels of < -20 dBm Peak pulse power: +45 dBm (32 W) Peak Pulse Power is defined as: <10 us pulse width, <1% duty cycle, and a reference level of \geq +10 dBm.

Table 7: RF input specifications (cont.)

Characteristic	Description														
Marker frequency measurement accuracy	$\pm((\text{Reference Frequency Error} \times \text{Marker Frequency}) + (0.001 \times \text{span} + 2)) \text{ Hz}$ Marker Frequency with Span/RBW $\leq 1000:1$ Reference Frequency Error with Marker level to displayed noise level $> 30 \text{ dB}$														
✓ Phase noise at 1 GHz	1 kHz: ($< -104 \text{ dBc/Hz}$, typical) 10 kHz offset: $< -108 \text{ dBc/Hz}$ ($< -111 \text{ dBc/Hz}$, typical) 100 kHz offset: $< -110 \text{ dBc/Hz}$ ($< -113 \text{ dBc/Hz}$, typical) 1 MHz offset: $< -120 \text{ dBc/Hz}$ ($< -123 \text{ dBc/Hz}$, typical)														
Resolution bandwidth (RBW) accuracy	Max RBW % Error = $(0.5/(25 \times \text{WF})) * 100$ WF = Rectangular: 0.89 Hamming: 1.30 Hanning: 1.44 Blackman-Harris: 1.90 Kaiser: 2.23 Flat-Top: 3.77														
✓ Displayed average noise level (DANL)	<table border="1"> <thead> <tr> <th>Frequency range</th> <th>DANL</th> </tr> </thead> <tbody> <tr> <td>9 kHz – 50 kHz</td> <td>$< -116 \text{ dBm/Hz}$ ($< -123 \text{ dBm/Hz}$, typical)</td> </tr> <tr> <td>50 kHz – 5 MHz</td> <td>$< -130 \text{ dBm/Hz}$ ($< -141 \text{ dBm/Hz}$, typical)</td> </tr> <tr> <td>5 MHz – 400 MHz</td> <td>$< -146 \text{ dBm/Hz}$ ($< -150 \text{ dBm/Hz}$, typical)</td> </tr> <tr> <td>400 MHz – 3 GHz</td> <td>$< -147 \text{ dBm/Hz}$ ($< -150 \text{ dBm/Hz}$, typical)</td> </tr> <tr> <td>3 GHz – 4 GHz (MDO4XX4C option SA6 models only)</td> <td>$< -148 \text{ dBm/Hz}$ ($< -151 \text{ dBm/Hz}$, typical)</td> </tr> <tr> <td>4 GHz – 6 GHz (MDO4XX4C option SA6 models only)</td> <td>$< -140 \text{ dBm/Hz}$ ($< -145 \text{ dBm/Hz}$, typical)</td> </tr> </tbody> </table>	Frequency range	DANL	9 kHz – 50 kHz	$< -116 \text{ dBm/Hz}$ ($< -123 \text{ dBm/Hz}$, typical)	50 kHz – 5 MHz	$< -130 \text{ dBm/Hz}$ ($< -141 \text{ dBm/Hz}$, typical)	5 MHz – 400 MHz	$< -146 \text{ dBm/Hz}$ ($< -150 \text{ dBm/Hz}$, typical)	400 MHz – 3 GHz	$< -147 \text{ dBm/Hz}$ ($< -150 \text{ dBm/Hz}$, typical)	3 GHz – 4 GHz (MDO4XX4C option SA6 models only)	$< -148 \text{ dBm/Hz}$ ($< -151 \text{ dBm/Hz}$, typical)	4 GHz – 6 GHz (MDO4XX4C option SA6 models only)	$< -140 \text{ dBm/Hz}$ ($< -145 \text{ dBm/Hz}$, typical)
Frequency range	DANL														
9 kHz – 50 kHz	$< -116 \text{ dBm/Hz}$ ($< -123 \text{ dBm/Hz}$, typical)														
50 kHz – 5 MHz	$< -130 \text{ dBm/Hz}$ ($< -141 \text{ dBm/Hz}$, typical)														
5 MHz – 400 MHz	$< -146 \text{ dBm/Hz}$ ($< -150 \text{ dBm/Hz}$, typical)														
400 MHz – 3 GHz	$< -147 \text{ dBm/Hz}$ ($< -150 \text{ dBm/Hz}$, typical)														
3 GHz – 4 GHz (MDO4XX4C option SA6 models only)	$< -148 \text{ dBm/Hz}$ ($< -151 \text{ dBm/Hz}$, typical)														
4 GHz – 6 GHz (MDO4XX4C option SA6 models only)	$< -140 \text{ dBm/Hz}$ ($< -145 \text{ dBm/Hz}$, typical)														
✓ Absolute amplitude accuracy	<p>$< \pm 1.0 \text{ dB}$, ($< \pm 0.5 \text{ dB}$, typical), $18 \text{ }^\circ\text{C} - 28 \text{ }^\circ\text{C}$ temperature range, 50 kHz to 6 GHz frequency range, reference levels $-25, -20, -15, -10, -5, 0, 5, 10 \text{ dBm}$.</p> <p>$< \pm 1.0 \text{ dB}$, typical, 50 kHz to 6 GHz, all other reference levels, $18 \text{ }^\circ\text{C} - 28 \text{ }^\circ\text{C}$ temperature range:</p> <p>$< \pm 1.5 \text{ dB}$, typical, 50 kHz to 6 GHz, all reference levels, $0 \text{ }^\circ\text{C}$ to $50 \text{ }^\circ\text{C}$ temperature range</p> <p>$< \pm 2.0 \text{ dB}$, typical, 9 kHz to 50 kHz, all reference levels, $18 \text{ }^\circ\text{C}$ to $28 \text{ }^\circ\text{C}$ temperature range</p> <p>$< \pm 3.0 \text{ dB}$, typical, 9 kHz to 50 kHz, all reference levels, $0 \text{ }^\circ\text{C}$ to $50 \text{ }^\circ\text{C}$ temperature range</p> <p>Specification applies to signal to noise ratios $> 40 \text{ dB}$.</p> <p>Accuracy of power level measurements at the center frequency. At frequencies away from center frequency, add Channel Response to the Absolute Amplitude Accuracy.</p>														

Table 7: RF input specifications (cont.)

Characteristic	Description				
Channel response, typical	Measurement center frequency range	Span	Amplitude flatness, pk-pk, typical	Amplitude flatness, RMS, typical	Phase linearity, RMS, typical
	15 MHz – 6 GHz	10 MHz	0.3 dB	0.15 dB	1.5°
	60 MHz – 6 GHz	≤100 MHz	0.75 dB	0.27 dB	1.5°
	170 MHz – 6 GHz	≤320 MHz	0.85 dB	0.27 dB	2.5°
	510 MHz – 6 GHz	≤1000 MHz	1.0 dB	0.3 dB	3.0°
Any, (for Start Frequency > 10 MHz)	>1000 MHz	1.2 dB	N/A	N/A	
Valid over 18 °C – 28 °C temperature range					
Specification applies to signal to noise ratios >40 dB.					

Table 7: RF input specifications (cont.)

Characteristic	Description
Spurious response	2nd and 3rd harmonic distortion >100 MHz: < -60 dBc (< -65 dBc typical) with auto settings on and signals 10 dB below reference level
	2nd and 3rd harmonic distortion: 9 kHz to 100 MHz: < -57 dBc (< -60 dBc typical) with auto settings on, signals 10 dB below reference level, and reference level \leq -15 dBm
	2nd order intermodulation distortion: >200 MHz: < -60 dBc (< -65 dBc typical) with auto settings on and signals 10 dB below reference level
	2nd order intermodulation distortion: > 100 MHz to \leq 200 MHz: < -57 dBc (< -60 dBc, typical) with auto settings on, signals 10 dB below reference level, and reference level \leq -15 dBm
	2nd order intermodulation distortion: 10 MHz to 100 MHz: < -60 dBc (< -65 dBc, typical) with auto settings on, signals 10 dB below reference level, and reference level \leq -15 dBm
	✓ 3rd order intermodulation distortion: > 10 MHz < -62 dBc, (< -65 dBc, typical), with auto settings on and signals 10 dB below reference level
	3rd order intermodulation distortion: 9 kHz to 10 MHz < -55 dBc (< -60 dBc, typical), for reference levels < -15 dBm, with auto settings on and signals 10 dB below reference level
	A/D spurs < -60 dBc (< -65 dBc typical) with auto settings on, signals 5 dB below reference level. Excludes A/D aliasing spurs
	A/D aliasing spurs: at $(5 \text{ GHz} - F_{in})$ and at $(8 \text{ GHz} - F_{in})$: < -55 dBc (< -60 dBc, typical) with auto settings on and signals 5 dB below reference level
	Specifications that apply only to MDO4XX4C option SA6 models IF Rejection (All input frequencies except: 1.00 GHz to 1.25 GHz and 2 GHz to 2.4 GHz): (< -55 dBc, typical) IF spurs at $(5.0 \text{ GHz} - F_{in})$ for input frequencies from 1.00 GHz to 1.25 GHz: (< -50 dBc, typical) IF spurs at $(6.5 \text{ GHz} - F_{in})$ for input frequencies from 2.0 GHz to 2.4 GHz: (< -50 dBc, typical) Image Rejection: < -50 dBc (for input frequencies from 5.5 GHz to 9.5 GHz)
✓ Residual spurious response < -85 dBm at all points except 2.5 GHz, 3.75 GHz, 4.0 GHz, 5.0 GHz, and 6.0 GHz < -78 dBm at 3.75 GHz, 4.0 GHz, and 5.0 GHz (6.0 GHz is typically < -78 dBm) < -73 dBm at 2.5 GHz \leq -25 dBm reference level and RF input terminated with 50 Ω	

Table 7: RF input specifications (cont.)

Characteristic	Description
RF input level trigger frequency and amplitude range	Frequency range: 1 MHz to 3 GHz (MDO4XX4C option SA3 models) 1 MHz to 3.75 GHz (MDO4XX4C option SA6 models) 2.75 GHz to 4.5 GHz (MDO4XX4C option SA6 models) 3.5 GHz to 6.0 GHz (MDO4XX4C option SA6 models) Amplitude range: RF Level Trigger Amplitude Operating Level: 0 dB to -30 dB from Reference Level RF Level Trigger Amplitude Adjustment Range: +10 dB to -40 dB from Reference Level and within the range of -65 dBm to +30 dBm
Power level trigger minimum pulse duration	Minimum pulse duration: 10 μ s ON time with a minimum settling OFF time of 10 μ s.
RF to analog channel skew, typical	< 5 ns
↗ Crosstalk to RF channel from analog channels	< -68 dB from reference level (\leq 1 GHz oscilloscope input frequencies) < -48 dB from reference level ($>$ 1 GHz to 2 GHz oscilloscope input frequencies) Full scale amplitude with 50 Ω input and 100 mV/div vertical setting with direct input (no probes).
Occupied bandwidth accuracy, typical	\pm Span/1000
Adjacent channel power ratio, typical	W-CDMA: -57 dBc W-CDMA with test model 1, Reference level 30 dBm to -10 dBm, with signal level at 1 dB below A/D overrange.

Arbitrary Function Generator Characteristics

Table 8: AFG Characteristics

Characteristic	Description
Sine waveform	Frequency range: 0.1 Hz to 50 MHz Frequency setting resolution: 0.1 Hz Amplitude flatness (typical): \pm 0.5 dB at 1 kHz \pm 1.5 dB for <20 mVpp amplitudes Total harmonic distortion (typical): 1% at 50 Ω Spurious free dynamic range (typical): -40 dB ($V_{pp} \geq 0.1$ V); 30 dB ($V_{pp} < 0.1$ V), 50 Ω load

Table 8: AFG Characteristics (cont.)

Characteristic	Description
Square/pulse waveform	Frequency range: 0.1 Hz to 25 MHz
	Frequency range: 0.1 Hz to 25 MHz
	Frequency setting resolution: 0.1 Hz
	Duty cycle range: 10% - 90% or 10 ns minimum pulse, whichever is larger
	Duty cycle resolution: 0.1%
	Minimum pulse width (typical): 10 ns
	Rise/fall time (typical): 5 ns, 10% to 90%
	Pulse width resolution: 100 ps
	Overshoot (typical): <9% for signal steps greater than 100 mV
	Asymmetry (typical): $\pm 1\% \pm 5$ ns, at 50% duty cycle
Ramp/Triangle waveform	Frequency range: 0.1 Hz to 500 kHz
	Frequency setting resolution: 0.1 Hz
	Variable symmetry: 0% to 100%
	Symmetry resolution: 0.1%
	DC level range (typical): ± 2.5 V in to Hi-Z; ± 1.25 V into 50 Ω
	Gaussian Pulse, Lorentz Pulse, Haversine Maximum Frequency (typical): 5 MHz
	Exponential rise/fall maximum frequency (typical): 5 MHz
Sine(x)/x maximum frequency (typical): 2 MHz	
Random noise waveform	Amplitude range: 20 mV _{pp} to 5 V _{pp} in to Hi-Z; 10 mV _{pp} to 2.5 V _{pp} into 50 Ω
Sine and ramp frequency accuracy	130 ppm (frequency ≤ 10 kHz); 50 ppm (frequency > 10 kHz)
✓ Square and pulse frequency accuracy	130 ppm (frequency ≤ 10 kHz); 50 ppm (frequency > 10 kHz)
Signal amplitude resolution	500 μ V (50 Ω)
	1 mV (HiZ)
✓ Signal amplitude accuracy	+/- [(1.5% of peak-to-peak amplitude setting) + (1.5% of absolute DC offset setting) + 1mV] (frequency = 1kHz) Add 3 mV of uncertainty per 10 °C change from 25 °C ambient
DC offset range	± 2.5 V into Hi-Z
	± 1.25 V into 50 Ω
DC offset resolution	500 μ V (50 Ω)
	1 mV (HiZ)
✓ DC offset accuracy	\pm [(1.5% of offset setting) + 1 mV] Add 3 mV of uncertainty per 10 °C change from 25 °C ambient

Digital Voltmeter/Counter

Table 9: Digital Voltmeter/Counter

Characteristic	Description
Measurement types	AC+DC _{rms} , DC _{rms} , AC _{rms} , frequency count
Voltage resolution	4 digits
✓ Voltage accuracy	<p>DC voltage: $\pm(1.5\% \text{reading} - \text{offset} - \text{position}) + (0.5\% (\text{offset} - \text{position})) + (0.1 * \text{Volts/div})$</p> <p>De-rated at 0.100% / °C of $\text{reading} - \text{offset} - \text{position}$ above 30 °C</p> <p>DC example: an input channel set up with -2 V offset and 1 V/div measuring a -5 V signal would have $\pm(1.5\% \text{ of } (-5 \text{ V} - (-2 \text{ V}) - 0 \text{ V})) + (0.5\% \text{ of } (-2 \text{ V} - 0 \text{ V})) + 0.1 \text{ V} = \pm 155 \text{ mV}$ or 3.1% of the input voltage.</p> <p>AC: $\pm 2\%$ (40 Hz to 1 kHz)</p> <p>AC (typical): $\pm 2\%$ (20 Hz to 10 kHz)</p> <p>For AC measurements, the input channel vertical settings must allow the V_{pp} input signal to cover between 4 and 10 divisions and must be fully visible on the screen.</p> <p>For AC measurements, specifications are only valid for sinewaves.</p>
Frequency resolution	5 digits
✓ Frequency accuracy	<p>$\pm(10 \mu\text{Hz/Hz} + 1 \text{ count})$</p> <p>The signal must be at least 6 mV or 2 div, whichever is greater.</p>
Frequency counter source	Any analog input channel
✓ Frequency counter maximum input frequency	<p>150 MHz for all models</p> <p>Trigger Sensitivity limits must be observed for reliable frequency measurements.</p>

Display System Specifications

The following table shows the display specifications for the MDO4000C Series oscilloscopes.

Table 10: Display system specifications

Characteristic	Description
Display type	Display area: 210.4 mm (8.28 in) (H) x 157.8 mm (6.21 in) (V), 264 mm (10.4 in) diagonal, 6-bit RGB full color, XGA (1024 x 768) TFT liquid crystal display (LCD).
Display resolution	1024 X 768 XGA display resolution
Luminance, typical	400 cd/m ²
Waveform display color scale	The TFT display can support up to 262,144 colors. A subset of these colors is used for the oscilloscope display. The colors that are used are fixed and not changeable by the user.

Interfaces and Input/Output Port Specifications

The following table shows the interfaces and input/output port specifications for the MDO4000C Series oscilloscopes.

Table 11: Interfaces and Input/Output port specifications

Characteristic	Description																				
Ethernet interface	Standard on all models: 10/100/1000 Mbps																				
GPIB interface	Available as an optional accessory (TEK-USB-488 GPIB to USB Adapter), which connects to the USB Device and USB Host port. The control interface is incorporated into the instrument user interface.																				
Video signal output	A 15-pin D-sub VGA connector.																				
USB interface	4 USB host connectors (2.0 HS), two on the instrument front and two on the rear. 1 USB device connector (2.0 HS), on the instrument rear panel. All are standard on all models.																				
Probe compensator output voltage and frequency, typical	<i>Output Voltage</i> Default: 0 – 2.5 V amplitude, $\pm 2\%$ (Source Impedance of 1k Ω) TPPXX00 Cal Mode: 0 – 2.5 V amplitude, $\pm 5\%$ (Source Impedance of $\leq 25\Omega$) <i>Frequency</i> 1 kHz, $\pm 25\%$																				
✓ Auxiliary output (AUX OUT) Trigger Out or Reference Clock Out	You can set the Auxiliary output to Trigger Out, Event, Reference Clock Out or AFG. Reference Clock Out: Outputs the 10 MHz oscilloscope reference clock. Trigger Out: A HIGH to LOW transition indicates that the trigger occurred. Event Out: A High to Low transition indicates that an event occurred. AFG: The trigger output frequency is dependent on the frequency of the AFG signal. <table border="1"> <thead> <tr> <th>AFG frequency</th> <th>Trigger output frequency</th> </tr> </thead> <tbody> <tr> <td>≤ 4.9 MHz</td> <td>Signal frequency</td> </tr> <tr> <td>> 4.9 MHz to 14.7 MHz</td> <td>Signal frequency / 3</td> </tr> <tr> <td>>14.7 MHz to 24.5 MHz</td> <td>Signal frequency / 5</td> </tr> <tr> <td>>24.5 MHz to 34.3 MHz</td> <td>Signal frequency / 7</td> </tr> <tr> <td>>34.3 MHz to 44.1 MHz</td> <td>Signal frequency / 9</td> </tr> <tr> <td>>44.1 MHz to 50 MHz</td> <td>Signal frequency / 11</td> </tr> </tbody> </table> <i>Trigger output logic levels</i> <table border="1"> <thead> <tr> <th>Characteristic</th> <th>Limits</th> </tr> </thead> <tbody> <tr> <td>Vout (HI)</td> <td>≥ 2.5 V open circuit ≥ 1.0 V into a 50 Ω load to ground</td> </tr> <tr> <td>Vout (LO)</td> <td>≤ 0.7 V into a load of ≤ 4 mA ≤ 0.25 V into a 50 Ω load to ground</td> </tr> </tbody> </table>	AFG frequency	Trigger output frequency	≤ 4.9 MHz	Signal frequency	> 4.9 MHz to 14.7 MHz	Signal frequency / 3	>14.7 MHz to 24.5 MHz	Signal frequency / 5	>24.5 MHz to 34.3 MHz	Signal frequency / 7	>34.3 MHz to 44.1 MHz	Signal frequency / 9	>44.1 MHz to 50 MHz	Signal frequency / 11	Characteristic	Limits	Vout (HI)	≥ 2.5 V open circuit ≥ 1.0 V into a 50 Ω load to ground	Vout (LO)	≤ 0.7 V into a load of ≤ 4 mA ≤ 0.25 V into a 50 Ω load to ground
AFG frequency	Trigger output frequency																				
≤ 4.9 MHz	Signal frequency																				
> 4.9 MHz to 14.7 MHz	Signal frequency / 3																				
>14.7 MHz to 24.5 MHz	Signal frequency / 5																				
>24.5 MHz to 34.3 MHz	Signal frequency / 7																				
>34.3 MHz to 44.1 MHz	Signal frequency / 9																				
>44.1 MHz to 50 MHz	Signal frequency / 11																				
Characteristic	Limits																				
Vout (HI)	≥ 2.5 V open circuit ≥ 1.0 V into a 50 Ω load to ground																				
Vout (LO)	≤ 0.7 V into a load of ≤ 4 mA ≤ 0.25 V into a 50 Ω load to ground																				
External Reference nominal input frequency	10 MHz You must select either the internal reference (default) or 10 MHz external.																				

Table 11: Interfaces and Input/Output port specifications (cont.)

Characteristic	Description
External Reference input frequency variation tolerance, typical	<p>$\geq \pm 2 \times 10^{-6}$ for models with option SA3 or SA6.</p> <p>9.9 MHz to 10.1 MHz for models without options SA3 or SA6.</p> <p>You must run SPC, described in step 2 of the Self Test, whenever the external reference is more than 0.2% (2000 ppm) different than the nominal reference frequency or reference at which SPC was last run. The time base changes in correspondence to the fluctuations in the external reference.</p>
External Reference input sensitivity, typical	1.5 V _{p-p}
External Reference input maximum input signal	7 V _{p-p}
External Reference input impedance, typical	R _{in} = 1.5 kΩ ±20% in parallel with 15 pF ±5 pF at 10 MHz

Data Handling Specifications

The following table shows the data handling specifications for the MDO4000C Series oscilloscopes.

Table 12: Data handling specifications

Characteristic	Description
Nonvolatile memory retention time, typical	No time limit for front-panel settings, saved waveforms, setups, or calibration constants. 10 M and 20 M records saved as Reference waveforms are not saved in the nonvolatile memory and they will not be saved across a power cycle.
Real-time clock	A programmable clock providing time in years, months, days, hours, minutes, and seconds

Power Supply System Specifications

The following table shows the power supply system specifications for the MDO4000C Series oscilloscopes.

Table 13: Power supply system specifications

Characteristic	Description
Operating line frequency and voltage range	Volts: 100 – 240; Hz: 50 – 60 Volts: 115; Hz: 400
Maximum power consumption, typical	250 W
Source voltage	100 V to 240 V \pm 10%
Source frequency	(85 to 264 V) 45 Hz to 66 Hz (100 V to 132 V) 360 Hz to 440 Hz
Fuse rating	T6.3AH, 250 VAC The fuse cannot be replaced by the user.

Environmental Specifications

The following table shows the environmental specifications for the MDO4000C Series oscilloscopes.

Table 14: Environmental specifications

Characteristic	Description
Temperature	Operating: 0 °C to +50 °C (32 °F to +122 °F) Nonoperating: -30 °C to +70 °C (-22 °F to +158 °F)
Humidity	Operating: High: 40 °C to 50 °C (104 °F to 122 °F), 10% to 60% relative humidity Low: 0 °C to 40 °C (32 °F to 104 °F), 10% to 90% relative humidity Nonoperating: High: 40 °C to 60 °C (104 °F to 140 °F), 5% to 55% relative humidity Low: 0 °C to 40 °C (32 °F to 104 °F), 5% to 90% relative humidity
Altitude	Operating: 3,000 m (9,843 ft) Nonoperating: 12,000 m (39,370 ft)
Pollution Degree	Pollution Degree 2, indoor, dry location use only

Mechanical Specifications

The following table shows the mechanical specifications for the MDO4000C Series oscilloscopes.

Table 15: Mechanical specifications

Characteristic	Description																		
Weight	<p><i>Benchtop configuration (oscilloscope only)</i></p> <p>Requirements that follow are nominal:</p> <p>11.0 lbs (5.0 kg), stand-alone instrument, without front cover.</p> <p>18.8 lbs (8.5 kg), instrument with rackmount, without front cover</p> <p>23.6 lbs (10.7 kg), when packaged for domestic shipment (without rackmount)</p>																		
	<table border="1"> <thead> <tr> <th></th> <th></th> <th>kg</th> <th>lb</th> </tr> </thead> <tbody> <tr> <td rowspan="2">Instruments without option SA3 or SA6</td> <td>Net</td> <td>5.5</td> <td>12.2</td> </tr> <tr> <td>Shipping</td> <td>11.2</td> <td>24.8</td> </tr> <tr> <td rowspan="2">Instruments with option SA3 or SA6</td> <td>Net</td> <td>5.1</td> <td>11.2</td> </tr> <tr> <td>Shipping</td> <td>10.8</td> <td>23.8</td> </tr> </tbody> </table>			kg	lb	Instruments without option SA3 or SA6	Net	5.5	12.2	Shipping	11.2	24.8	Instruments with option SA3 or SA6	Net	5.1	11.2	Shipping	10.8	23.8
		kg	lb																
Instruments without option SA3 or SA6	Net	5.5	12.2																
	Shipping	11.2	24.8																
Instruments with option SA3 or SA6	Net	5.1	11.2																
	Shipping	10.8	23.8																
Dimensions	<p><i>Benchtop configuration (oscilloscope only)</i></p> <p>Requirements that follow are nominal and unboxed</p> <p>Height:</p> <p>9.0 in (229 mm) feet folded in, handle folded down</p> <p>9.8 in (249 mm) feet folded out, handle folded down</p> <p>11.5 in (292 mm) feet folded in, handle folded up</p> <p>12.3 in (312 mm) feet folded out, handled folded up</p> <p>Width:</p> <p>17.3 in (439 mm) from handle hub to handle hub</p> <p>Depth:</p> <p>5.8 in (147 mm) from back of feet to front of knobs</p> <p>6.1 in (155 mm) from back of feet to front of front cover</p> <p>9.8 in (249 mm) from handle to front of knobs (handle folded to back side of unit)</p> <p>Box Dimensions:</p> <p>Height: 15.7 in (399 mm)</p> <p>Width: 15.6 in (396 mm)</p> <p>Length: 22.2 in (564 mm)</p> <p><i>Rackmount configuration</i></p> <p>Requirements that follow are nominal and unboxed (5U rack sizes):</p> <p>Height: 8.6 in (218 mm)</p> <p>Width: 19.2 in (488 mm), from outside of handle to outside of handle</p> <p>Depth: 15.1 in (384 mm), from outside of handle to back of slide</p>																		
Clearance Requirements	<p>0 mm (0 in), top</p> <p>0 in (0 mm), bottom, on feet, with flip stands down</p> <p>2 in (50.8 mm), left side (facing the front of the instrument)</p> <p>0 in (0 mm), right side (facing the front of the instrument)</p> <p>2 in (50.8 mm), rear (where the power cord is plugged in)</p>																		

TPA-N-PRE Specifications

The following table shows the TPA-N-PRE Preamplifier specifications.

Table 16: TPA-N-PRE specifications

Characteristic	Description
Frequency range	Preamp: 9 kHz to 6 GHz MDO4XX4C option SA6 with preamp: 9 kHz to 6 GHz MDO4XX4C option SA3 with preamp: 9 kHz to 3 GHz
Input vertical range	MDO4000C with preamp attached (Amplifying state): -30 dBm to DANL MDO4000C with preamp attached (Bypass state): +30 dBm to DANL
Preamp gain	Gain of preamp in Amplifying state: +12 dB (nominal) Gain of preamp in Bypass state: -1.5 dB (nominal) This refers to the amount of gain of the preamp alone, or in other words, the amount of gain that the preamp will add to the beginning of the MDO RF input when attached.
Displayed average noise level (DANL) of the MDO4000C with the preamp attached to the MDO's RF input	With the preamp mode set to "Auto" and the reference level set to -40 dBm MDO4XX4C option SA6: 9 kHz to 50 kHz: < -119 dBm/Hz (Max), (-123 dBm/Hz, typical) 50 kHz to 5 MHz: < -140 dBm/Hz (Max), (-146 dBm/Hz, typical) 5 MHz to 400 MHz: < -156 dBm/Hz (Max), (-160 dBm/Hz, typical) 400 MHz to 3 GHz: < -157 dBm/Hz (Max), (-160 dBm/Hz, typical) 3 GHz to 4 GHz: < -158 dBm/Hz (Max), (-161 dBm/Hz, typical) 4 GHz to 6 GHz: < -150 dBm/Hz (Max), (-155 dBm/Hz, typical) MDO4XX4C option SA3: 9 kHz to 50 kHz: < -119 dBm/Hz (Max), (-125 dBm/Hz, typical) 50 kHz to 5 MHz: < -140 dBm/Hz (Max), (-146 dBm/Hz, typical) 5 MHz to 400 MHz: < -156 dBm/Hz (Max), (-160 dBm/Hz, typical) 400 MHz to 3 GHz: < -157 dBm/Hz (Max), (-160 dBm/Hz, typical)
Absolute amplitude accuracy and channel response, typical	This specification applies to the MDO4000C series oscilloscope RF channel with the preamp attached to the RF input of the MDO. Absolute amplitude accuracy (AAA): Accuracy of power level measurements at the center frequency. Channel Response (CR): Accuracy of power level measurements over the whole span relative to the accuracy at the center frequency. Add AAA and CR to find total power level measurement accuracy. AAA: $\leq \pm 1.5$ dB, typical, 18 °C – 28 °C temperature range, either preamp state. AAA: $\leq \pm 2.3$ dB, typical, over full operating range, either preamp state. CR: 0.0 dB Specifications exclude mismatch error at the preamp input. Preamp mode set to "Auto". Reference level 10 dBm to -40 dBm. Input level ranging from reference level to 30 dB below reference level.

Characteristic	Description
Maximum operating input level	<p>The maximum voltage that the preamp input can withstand without creating a shock hazard or damaging the input.</p> <p>Average continuous power: +30 dBm (1 W)</p> <p>DC maximum before damage: ± 20 V DC</p> <p>Maximum power before damage: +30 dBm (1 W) CW.</p> <p>Peak Pulse Power: +45 dBm (32 W)</p> <p>Peak Pulse Power defined as <10 us pulse width, <1% duty cycle, and reference level of $\geq +10$ dBm.</p>
Connector type	SMA – female (outside threads)
Temperature	<p>Operating: 0 °C to +50 °C</p> <p>Non-operating: –20 °C to +60 °C</p>
Humidity	<p>Operating:</p> <p>High: 40 °C to 50 °C (104 °F to 122 °F), 10% to 60% RH</p> <p>Low: 0 °C to 40 °C (32 °F to 104 °F), 10% to 90% RH</p> <p>Non-operating:</p> <p>High: 40 °C to 60 °C (104 °F to 140 °F), 5% to 60% RH</p> <p>Low: 0 °C to 40 °C (32 °F to 104 °F), 5% to 90% RH</p>
Altitude	<p>Operating: Up to 3,000 meters</p> <p>Non-operating: Up to 12,000 meters</p>
Recommended oscilloscopes	<p>MDO4000C Mixed Domain Oscilloscopes</p> <p>NOTE. For best probe support, download and install the latest version of the oscilloscope firmware from www.tektronix.com</p>

Performance Verification

The performance verification procedures verify the performance of your instrument. They do not adjust your instrument. If your instrument fails any of the performance verification tests, you should contact Tektronix to have a factory adjustment performed. See the contact information on the back of the title page of this manual.

This section contains performance verification procedures for the specifications marked with the ✓ symbol. These procedures cover all MDO4000C Series models. Please ignore checks that do not apply to the specific model you are testing.

Print the test record on the following pages and use it to record the performance test results for your oscilloscope.

NOTE. *Completion of the performance verification procedure does not update the stored time and date of the latest successful adjustment. The date and time are updated only when the instrument is adjusted by Tektronix.*

The following equipment, or a suitable equivalent, is required to complete these procedures. You might need additional cables and adapters, depending on the actual test equipment you use.

Table 17: Required equipment

Description	Minimum requirements	Examples
DC voltage source	3 mV to 4 V, $\pm 0.1\%$ accuracy	Fluke 9500B Oscilloscope Calibrator with a 9510 Output Module
Leveled sine wave generator	50 kHz to 1000 MHz, $\pm 4\%$ amplitude accuracy	
Time mark generator	80 ms period, $\pm 1 \times 10^{-6}$ accuracy, rise time < 50 ns	
Signal generator	Frequency: to at least 6 GHz Frequency accuracy: 5 ppm Low phase noise	Anritsu MG3692C Options 2A, 4, 6, 15A, 16, 22, SM6452 Rohde & Schwarz SMT06 (Two generators are needed for checking Third Order Intermodulation Distortion)
Hybrid coupler (power combiner)	Connects the output of two generators to the oscilloscope RF input	Krytar 3005070
Logic probe	Low capacitance digital probe, 16 channels.	P6616 probe; standard accessory shipped with MDO4000C Series oscilloscopes.
BNC-to-0.1 inch pin adapter to connect the logic probe to the signal source.	BNC-to-0.1 inch pin adapter; female BNC to 2x16. 01 inch pin headers.	Tektronix adapter part number 679-6240-00; to connect the Fluke 9500B to the P6616 probe.
Digital multimeter (DMM)	0.1% accuracy or better	DMM4020 Digital Multimeter
Frequency counter		FCA3000 Frequency Counter
Power meter		Agilent N1913A Single-Channel Power Meter
Power head	Frequency range at least 50 kHz – 6 GHz	Agilent E9304A Average Power Sensor
Power splitter		Agilent 11667A Power Splitter
Male N-N adapter		For connecting between the power splitter and the oscilloscope RF Input
One 50 Ω terminator	Impedance 50 Ω ; connectors: female BNC input, male BNC output	Tektronix part number 011-0049-02
One 50 Ω terminator	Impedance 50 Ω ; Male N connector	For terminating the RF Input
One 50 Ω BNC coaxial cable	Male-to-male connectors	Tektronix part number 012-0057-01
One 50 Ω SMA coaxial cable	N connector to SMA	
Three SMA cables	With the correct connector to fit your generator output.	Tektronix part number 174-6025-00 (6 ft) Tektronix part number 174-6026-00 (2 ft)

Test Record

Model	Serial	Procedure performed by	Date
-------	--------	------------------------	------

Test	Passed	Failed
------	--------	--------

Self Test

Input Impedance

Performance checks	Vertical scale	Low limit	Test result	High limit
Channel 1 Input Impedance, 1 M Ω	10 mV/div	990 k Ω		1.01 M Ω
	100 mV/div	990 k Ω		1.01 M Ω
	1 V/div	990 k Ω		1.01 M Ω
Channel 1 Input Impedance, 250 k Ω	100 mV/div	245 k Ω		255 k Ω
Channel 1 Input Impedance, 50 Ω	10 mV/div	49.5 Ω		50.5 Ω
	100 mV/div	49.5 Ω		50.5 Ω
Channel 2 Input Impedance, 1 M Ω	10 mV/div	990 k Ω		1.01 M Ω
	100 mV/div	990 k Ω		1.01 M Ω
	1 V/div	990 k Ω		1.01 M Ω
Channel 2 Input Impedance, 250 k Ω	100 mV/div	245 k Ω		255 k Ω
Channel 2 Input Impedance, 50 Ω	10 mV/div	49.5 Ω		50.5 Ω
	100 mV/div	49.5 Ω		50.5 Ω
Channel 3 Input Impedance, 1 M Ω	10 mV/div	990 k Ω		1.01 M Ω
	100 mV/div	990 k Ω		1.01 M Ω
	1 V/div	990 k Ω		1.01 M Ω
Channel 3 Input Impedance, 250 k Ω	100 mV/div	245 k Ω		255 k Ω
Channel 3 Input Impedance, 50 Ω	10 mV/div	49.5 Ω		50.5 Ω
	100 mV/div	49.5 Ω		50.5 Ω
Channel 4 Input Impedance, 1 M Ω	10 mV/div	990 k Ω		1.01 M Ω
	100 mV/div	990 k Ω		1.01 M Ω
	1 V/div	990 k Ω		1.01 M Ω
Channel 4 Input Impedance, 250 k Ω	100 mV/div	245 k Ω		255 k Ω
Channel 4, Input Impedance, 50 Ω	10 mV/div	49.5 Ω		50.5 Ω
	100 mV/div	49.5 Ω		50.5 Ω
Aux In Input Impedance, 250 k Ω		245 k Ω		255 k Ω

DC Balance

Performance checks	Vertical scale	Low limit	Test result	High limit
Channel 1 DC Balance, 50 Ω , 20 MHz BW	1 mV/div	-0.2 mV		0.2 mV
	2 mV/div	-0.2 mV		0.2 mV
	5 mV/div	-0.5 mV		0.5 mV
	10 mV/div	-1 mV		1 mV
	20 mV/div	-2 mV		2 mV
	49.8 mV/div	-4.98 mV		4.98 mV
	50 mV/div	-5 mV		5 mV
	100 mV/div	-10 mV		10 mV
	200 mV/div	-20 mV		20 mV
	500 mV/div	-50 mV		50 mV
	1 V/div	-100 mV		100 mV
	Channel 1 DC Balance, 1 M Ω , 20 MHz BW	1 mV/div	-0.225 mV	
2 mV/div		-0.4 mV		0.4 mV
5 mV/div		-1 mV		1 mV
10 mV/div		-2 mV		2 mV
20 mV/div		-4 mV		4 mV
100 mV/div		-20 mV		20 mV
500 mV/div		-100 mV		100 mV
1 V/div		-200 mV		200 mV
Channel 1 DC Balance, 50 Ω , 250 MHz BW	20 mV/div	-2 mV		2 mV
	20 mV/div	-4 mV		4 mV
Channel 1 DC Balance, 1 M Ω , 250 MHz BW	20 mV/div	-4 mV		4 mV
Channel 1 DC Balance, 50 Ω , Full BW	20 mV/div	-2 mV		2 mV
Channel 1 DC Balance, 1 M Ω , Full BW	20 mV/div	-4 mV		4 mV

DC Balance

Performance checks	Vertical scale	Low limit	Test result	High limit
Channel 2 DC Balance, 50 Ω , 20 MHz BW	1 mV/div	-0.2 mV		0.2 mV
	2 mV/div	-0.2 mV		0.2 mV
	5 mV/div	-0.5 mV		0.5 mV
	10 mV/div	-1 mV		1 mV
	20 mV/div	-2 mV		2 mV
	49.8 mV/div	-4.98 mV		4.98 mV
	50 mV/div	-5 mV		5 mV
	100 mV/div	-10 mV		10 mV
	200 mV/div	-20 mV		20 mV
	500 mV/div	-50 mV		50 mV
	1 V/div	-100 mV		100 mV
Channel 2 DC Balance, 1 M Ω , 20 MHz BW	1 mV/div	-0.225 mV		0.225 mV
	2 mV/div	-0.4 mV		0.4 mV
	5 mV/div	-1 mV		1 mV
	10 mV/div	-2 mV		2 mV
	20 mV/div	-4 mV		4 mV
	100 mV/div	-20 mV		20 mV
	500 mV/div	-100 mV		100 mV
	1 V/div	-200 mV		200 mV
	10 V/div	-2 V		2 V
Channel 2 DC Balance, 50 Ω , 250 MHz BW	20 mV/div	-2 mV		2 mV
Channel 2 DC Balance, 1 M Ω , 250 MHz BW	20 mV/div	-4 mV		4 mV
Channel 2 DC Balance, 50 Ω , Full BW	20 mV/div	-2 mV		2 mV
Channel 2 DC Balance, 1 M Ω , Full BW	20 mV/div	-4 mV		4 mV

DC Balance

Performance checks	Vertical scale	Low limit	Test result	High limit
Channel 3 DC Balance, 50 Ω , 20 MHz BW	1 mV/div	-0.2 mV		0.2 mV
	2 mV/div	-0.2 mV		0.2 mV
	5 mV/div	-0.5 mV		0.5 mV
	10 mV/div	-1 mV		1 mV
	20 mV/div	-2 mV		2 mV
	49.8 mV/div	-4.98 mV		4.98 mV
	50 mV/div	-5 mV		5 mV
	100 mV/div	-10 mV		10 mV
	200 mV/div	-20 mV		20 mV
	500 mV/div	-50 mV		50 mV
	1 V/div	-100 mV		100 mV
	Channel 3 DC Balance, 1 M Ω , 20 MHz BW	1 mV/div	-0.225 mV	
2 mV/div		-0.4 mV		0.4 mV
5 mV/div		-1 mV		1 mV
10 mV/div		-2 mV		2 mV
20 mV/div		-4 mV		4 mV
500 mV/div		-100 mV		100 mV
100 mV/div		-20 mV		20 mV
1 V/div		-200 mV		200 mV
Channel 3 DC Balance, 50 Ω , 250 MHz BW	20 mV/div	-2 mV		2 mV
	20 mV/div	-4 mV		4 mV
Channel 3 DC Balance, 1 M Ω , 250 MHz BW	20 mV/div	-4 mV		4 mV
Channel 3 DC Balance, 50 Ω , Full BW	20 mV/div	-2 mV		2 mV
Channel 3 DC Balance, 1 M Ω , Full BW	20 mV/div	-4 mV		4 mV

DC Balance

Performance checks	Vertical scale	Low limit	Test result	High limit
Channel 4 DC	1 mV/div	-0.2 mV		0.2 mV
Balance, 50 Ω , 20 MHz	2 mV/div	-0.2 mV		0.2 mV
BW	5 mV/div	-0.5 mV		0.5 mV
	10 mV/div	-1 mV		1 mV
	20 mV/div	-2 mV		2 mV
	49.8 mV/div	-4.98 mV		4.98 mV
	50 mV/div	-5 mV		5 mV
	100 mV/div	-10 mV		10 mV
	200 mV/div	-20 mV		20 mV
	500 mV/div	-50 mV		50 mV
	1 V/div	-100 mV		100 mV
Channel 4 DC	1 mV/div	-0.225 mV		0.225 mV
Balance, 1 M Ω ,	2 mV/div	-0.4 mV		0.4 mV
20 MHz BW	5 mV/div	-1 mV		1 mV
	10 mV/div	-2 mV		2 mV
	20 mV/div	-4 mV		4 mV
	500 mV/div	-100 mV		100 mV
	100 mV/div	-20 mV		20 mV
	1 V/div	-200 mV		200 mV
	10 V/div	-2 V		2 V
Channel 4 DC	20 mV/div	-2 mV		2 mV
Balance, 50 Ω ,				
250 MHz BW				
Channel 4 DC	20 mV/div	-4 mV		4 mV
Balance, 1 M Ω ,				
250 MHz BW				
Channel 4 DC	20 mV/div	-2 mV		2 mV
Balance, 50 Ω , Full				
BW				
Channel 4 DC	20 mV/div	-4 mV		4 mV
Balance, 1 M Ω , Full				
BW				

DC Gain Accuracy

Performance checks	Bandwidth	Vertical scale	Low limit	Test result	High limit	
All models						
Channel 1 DC Gain Accuracy, 0 V offset, 0 V vertical position, 50 Ω	20 MHz	1 mV/div	-2.0%		2.0%	
		2 mV/div	-1.5%		1.5%	
		5 mV/div	-1.5%		1.5%	
		10 mV/div	-1.5%		1.5%	
		20 mV/div	-1.5%		1.5%	
		49.8 mV/div	-3.0%		3.0%	
		50 mV/div	-1.5%		1.5%	
		100 mV/div	-1.5%		1.5%	
		200 mV/div	-1.5%		1.5%	
		500 mV/div	-1.5%		1.5%	
		1 V/div	-1.5%		1.5%	
		250 MHz (not applicable for the MDO4024C)	20 mV/div	-1.5%		1.5%
		Full	20 mV/div	-1.5%		1.5%
	Channel 2 DC Gain Accuracy, 0 V offset, 0 V vertical position, 50 Ω	20 MHz	1 mV/div	-2.0%		2.0%
2 mV/div			-1.5%		1.5%	
5 mV/div			-1.5%		1.5%	
10 mV/div			-1.5%		1.5%	
20 mV/div			-1.5%		1.5%	
49.8 mV/div			-3.0%		3.0%	
50 mV/div			-1.5%		1.5%	
100 mV/div			-1.5%		1.5%	
200 mV/div			-1.5%		1.5%	
500 mV/div			-1.5%		1.5%	
1 V/div			-1.5%		1.5%	
250 MHz (not applicable for the MDO4024C)			20 mV/div	-1.5%		1.5%
Full			20 mV/div	-1.5%		1.5%

DC Gain Accuracy

Performance checks	Bandwidth	Vertical scale	Low limit	Test result	High limit	
All models						
Channel 3 DC Gain Accuracy, 0 V offset, 0 V vertical position, 50 Ω	20 MHz	1 mV/div	-2.0%		2.0%	
		2 mV/div	-1.5%		1.5%	
		5 mV/div	-1.5%		1.5%	
		10 mV/div	-1.5%		1.5%	
		20 mV/div	-1.5%		1.5%	
		49.8 mV/div	-3.0%		3.0%	
		50 mV/div	-1.5%		1.5%	
		100 mV/div	-1.5%		1.5%	
		200 mV/div	-1.5%		1.5%	
		500 mV/div	-1.5%		1.5%	
		1 V/div	-1.5%		1.5%	
		250 MHz (not applicable for the MDO4024C)	20 mV/div	-1.5%		1.5%
		Full	20 mV/div	-1.5%		1.5%
	Channel 4 DC Gain Accuracy, 0 V offset, 0 V vertical position, 50 Ω	20 MHz	1 mV/div	-2.0%		2.0%
2 mV/div			-1.5%		1.5%	
5 mV/div			-1.5%		1.5%	
10 mV/div			-1.5%		1.5%	
20 mV/div			-1.5%		1.5%	
49.8 mV/div			-3.0%		3.0%	
50 mV/div			-1.5%		1.5%	
100 mV/div			-1.5%		1.5%	
200 mV/div			-1.5%		1.5%	
500 mV/div			-1.5%		1.5%	
1 V/div			-1.5%		1.5%	
250 MHz (not applicable for the MDO4024C)			20 mV/div	-1.5%		1.5%
Full			20 mV/div	-1.5%		1.5%

DC Gain Accuracy

Performance checks	Bandwidth	Vertical scale	Low limit	Test result	High limit
All Models					
Channel 1 DC Gain Accuracy, 0 V offset, 0 V vertical position, 1 MΩ	20 MHz	1 mV/div	-2.0%		2.0%
		2 mV/div	-1.5%		1.5%
		5 mV/div	-1.5%		1.5%
		10 mV/div	-1.5%		1.5%
		20 mV/div	-1.5%		1.5%
		50 mV/div	-1.5%		1.5%
		63.5 mV/div	-3.0%		3.0%
		100 mV/div	-1.5%		1.5%
		200 mV/div	-1.5%		1.5%
		500 mV/div	-1.5%		1.5%
		1 V/div	-1.5%		1.5%
		5 V/div	-1.5%		1.5%
		250 MHz	20 mV/div	-1.5%	
		(Not applicable for the MDO4024C)			
	FULL	20 mV/div	-1.5%		1.5%
Channel 2 DC Gain Accuracy, 0 V offset, 0 V vertical position, 1 MΩ	20 MHz	1 mV/div	-2.0%		2.0%
		2 mV/div	-1.5%		1.5%
		5 mV/div	-1.5%		1.5%
		10 mV/div	-1.5%		1.5%
		20 mV/div	-1.5%		1.5%
		50 mV/div	-1.5%		1.5%
		63.5 mV/div	-3.0%		3.0%
		100 mV/div	-1.5%		1.5%
		200 mV/div	-1.5%		1.5%
		500 mV/div	-1.5%		1.5%
		1 V/div	-1.5%		1.5%
		5 V/div	-1.5%		1.5%
		250 MHz	20 mV/div	-1.5%	
		(Not applicable for the MDO4024C)			
	FULL	20 mV/div	-1.5%		1.5%

DC Gain Accuracy

Performance checks	Bandwidth	Vertical scale	Low limit	Test result	High limit	
All Models						
Channel 3 DC Gain Accuracy, 0 V offset, 0 V vertical position, 1 M Ω	20 MHz	1 mV/div	-2.0%		2.0%	
		2 mV/div	-1.5%		1.5%	
		5 mV/div	-1.5%		1.5%	
		10 mV/div	-1.5%		1.5%	
		20 mV/div	-1.5%		1.5%	
		50 mV/div	-1.5%		1.5%	
		63.5 mV/div	-3.0%		3.0%	
		100 mV/div	-1.5%		1.5%	
		200 mV/div	-1.5%		1.5%	
		500 mV/div	-1.5%		1.5%	
		1 V/div	-1.5%		1.5%	
		5 V/div	-1.5%		1.5%	
		250 MHz	20 mV/div	-1.5%		1.5%
			(Not applicable for the MDO4024C)			
		FULL	20 mV/div	-1.5%		1.5%
Channel 4 DC Gain Accuracy, 0 V offset, 0 V vertical position, 1 M Ω	20 MHz	1 mV/div	-2.0%		2.0%	
		2 mV/div	-1.5%		1.5%	
		5 mV/div	-1.5%		1.5%	
		10 mV/div	-1.5%		1.5%	
		20 mV/div	-1.5%		1.5%	
		50 mV/div	-1.5%		1.5%	
		63.5 mV/div	-3.0%		3.0%	
		100 mV/div	-1.5%		1.5%	
		200 mV/div	-1.5%		1.5%	
		500 mV/div	-1.5%		1.5%	
		1 V/div	-1.5%		1.5%	
		5 V/div	-1.5%		1.5%	
		250 MHz	20 mV/div	-1.5%		1.5%
			(Not applicable for the MDO4024C)			
		FULL	20 mV/div	-1.5%		1.5%

DC Offset Accuracy

Performance checks	Vertical scale	Vertical offset ¹	Low limit	Test result	High limit
All models:					
Channel 1 DC Offset Accuracy, 20 MHz BW, 50 Ω	1 mV/div	900 mV	895.3 mV		904.7 mV
	1 mV/div	-900 mV	-904.7 mV		-895.3 mV
	100 mV/div	5.0 V	4.965 V		5.035 V
	100 mV/div	-5.0 V	-5.035 V		-4.965 V
Channel 1 DC Offset Accuracy, 20 MHz BW, 1 MΩ	1 mV/div	900 mV	895.3 mV		904.7 mV
	1 mV/div	-900 mV	-904.7 mV		-895.3 mV
	100 mV/div	9.0 V	8.935 V		9.065 V
	100 mV/div	-9.0 V	-9.065 V		-8.935 V
	500 mV/div	9.0 V	8.855 V		9.145 V
	500 mV/div	-9.0 V	-9.145 V		-8.855 V
	1.01 V/div	99.5 V	98.80 V		100.2 V
	1.01 V/div	-99.5 V	-100.2 V		-98.80 V
	3 V/div	99.5 V	98.40 V		100.6 V
	3 V/div	-99.5 V	-100.6 V		-98.4 V
	5 V/div	99.5 V	98.00 V		101.0 V
	5 V/div	-99.5 V	-101.0 V		-98.00 V
Channel 2 DC Offset Accuracy, 20 MHz BW, 50 Ω	1 mV/div	900 mV	895.3 mV		904.7 mV
	1 mV/div	-900 mV	-904.7 mV		-895.3 mV
	100 mV/div	5.0 V	4.965 V		5.035 V
	100 mV/div	-5.0 V	-5.035 V		-4.965 V
Channel 2 DC Offset Accuracy, 20 MHz BW, 1 MΩ	1 mV/div	900 mV	895.3 mV		904.7 mV
	1 mV/div	-900 mV	-904.7 mV		-895.3 mV
	100 mV/div	9.0 V	8.935 V		9.065 V
	100 mV/div	-9.0 V	-9.065 V		-8.935 V
	500 mV/div	9.0 V	8.855 V		9.145 V
	500 mV/div	-9.0 V	-9.145 V		-8.855 V
	1.01 V/div	99.5 V	98.80 V		100.2 V
	1.01 V/div	-99.5 V	-100.2 V		-98.80 V
	3 V/div	99.5 V	98.40 V		100.6 V
	3 V/div	-99.5 V	-100.6 V		-98.4 V
	5 V/div	99.5 V	98.00 V		101.0 V
	5 V/div	-99.5 V	-101.0 V		-98.00 V

DC Offset Accuracy

Performance checks	Vertical scale	Vertical offset¹	Low limit	Test result	High limit
Channel 3 DC Offset Accuracy, 20 MHz BW, 50 Ω	1 mV/div	900 mV	895.3 mV		904.7 mV
	1 mV/div	-900 mV	-904.7 mV		-895.3 mV
	100 mV/div	5.0 V	4.965 V		5.035 V
	100 mV/div	-5.0 V	-5.035 V		-4.965 V
Channel 3 DC Offset Accuracy, 20 MHz BW, 1 MΩ	1 mV/div	900 mV	895.3 mV		904.7 mV
	1 mV/div	-900 mV	-904.7 mV		-895.3 mV
	100 mV/div	9.0 V	8.935 V		9.065 V
	100 mV/div	-9.0 V	-9.065 V		-8.935 V
	500 mV/div	9.0 V	8.855 V		9.145 V
	500 mV/div	-9.0 V	-9.145 V		-8.855 V
	1.01 V/div	99.5 V	98.80 V		100.2 V
	1.01 V/div	-99.5 V	-100.2 V		-98.80 V
	3 V/div	99.5 V	98.40 V		100.6 V
	3 V/div	-99.5 V	-100.6 V		-98.4 V
	5 V/div	99.5 V	98.00 V		101.0 V
	5 V/div	-99.5 V	-101.0 V		-98.00 V
Channel 4 DC Offset Accuracy, 20 MHz BW, 50 Ω	1 mV/div	900 mV	895.3 mV		904.7 mV
	1 mV/div	-900 mV	-904.7 mV		-895.3 mV
	100 mV/div	5.0 V	4.965 V		5.035 V
	100 mV/div	-5.0 V	-5.035 V		-4.965 V
Channel 4 DC Offset Accuracy, 20 MHz BW, 1 MΩ	1 mV/div	900 mV	895.3 mV		904.7 mV
	1 mV/div	-900 mV	-904.7 mV		-895.3 mV
	100 mV/div	9.0 V	8.935 V		9.065 V
	100 mV/div	-9.0 V	-9.065 V		-8.935 V
	500 mV/div	9.0 V	8.855 V		9.145 V
	500 mV/div	-9.0 V	-9.145 V		-8.855 V
	1.01 V/div	99.5 V	98.80 V		100.2 V
	1.01 V/div	-99.5 V	-100.2 V		-98.80 V
	3 V/div	99.5 V	98.40 V		100.6 V
	3 V/div	-99.5 V	-100.6 V		-98.4 V
	5 V/div	99.5 V	98.00 V		101.0 V
	5 V/div	-99.5 V	-101.0 V		-98.00 V

¹ Use this value for both the calibrator output and the oscilloscope offset setting.

Analog Bandwidth

Performance checks

Bandwidth at Channel	Impedance	Vertical scale	Horizontal scale	V_{in-pp}	V_{bw-pp}	Limit	Test result Gain = V_{bw-pp}/V_{in-pp}
All Models							
Channel 1	50 Ω	1 mV/div	4 ns/div (175 MHz for all models)			≥ 0.707	
		2 mV/div	2 ns/div (Full BW for the MDO4024C, 350 MHz for other models)			≥ 0.707	
		5 mV/div	1 ns/div (Full BW)			≥ 0.707	
		10 mV/div	1 ns/div (Full BW)			≥ 0.707	
		50 mV/div	1 ns/div (Full BW)			≥ 0.707	
		100 mV/div	1 ns/div (Full BW)			≥ 0.707	
		1 V/div	1 ns/div (Full BW)			≥ 0.707	
MDO4104C							
Channel 1	1 M Ω	1 mV/div	4 ns/div (175 MHz)			≥ 0.707	
		2 mV/div	2 ns/div (350 MHz)			≥ 0.707	
		5 mV/div	1 ns/div (500 MHz)			≥ 0.707	
		10 mV/div	1 ns/div (500 MHz)			≥ 0.707	
		50 mV/div	1 ns/div (500 MHz)			≥ 0.707	
		100 mV/div	1 ns/div (500 MHz)			≥ 0.707	
		1 V/div	1 ns/div (500 MHz)			≥ 0.707	

Analog Bandwidth

Performance checks

Bandwidth at Channel	Impedance	Vertical scale	Horizontal scale	V_{in-pp}	V_{bw-pp}	Limit	Test result Gain = V_{bw-pp}/V_{in-pp}
MDO4054C option SA3 or SA6							
Channel 1	1 M Ω	1 mV/div	4 ns/div (175 MHz)			≥ 0.707	
		2 mV/div	2 ns/div (350 MHz)			≥ 0.707	
		5 mV/div	1 ns/div (380 MHz)			≥ 0.707	
		10 mV/div	1 ns/div (380 MHz)			≥ 0.707	
		50 mV/div	1 ns/div (380 MHz)			≥ 0.707	
		100 mV/div	1 ns/div (380 MHz)			≥ 0.707	
		1 V/div	1 ns/div (380 MHz)			≥ 0.707	
All other models with option SA3 or SA6							
Channel 1	1 M Ω	1 mV/div	4 ns/div (175 MHz)			≥ 0.707	
		2 mV/div	2 ns/div (Full BW for the MDO4024C, 350 MHz for other models)			≥ 0.707	
		5 mV/div	1 ns/div (Full BW)			≥ 0.707	
		10 mV/div	1 ns/div (Full BW)			≥ 0.707	
		50 mV/div	1 ns/div (Full BW)			≥ 0.707	
		100 mV/div	1 ns/div (Full BW)			≥ 0.707	
1 V/div	1 ns/div (Full BW)			≥ 0.707			

Analog Bandwidth

Performance checks

Bandwidth at Channel	Impedance	Vertical scale	Horizontal scale	V_{in-pp}	V_{bw-pp}	Limit	Test result Gain = V_{bw-pp}/V_{in-pp}
All Models							
Channel 2	50 Ω	1 mV/div	4 ns/div (175 MHz for all models)			≥ 0.707	
		2 mV/div	2 ns/div (Full BW for the MDO4024C, 350 MHz for other models)			≥ 0.707	
		5 mV/div	1 ns/div (Full BW)			≥ 0.707	
		10 mV/div	1 ns/div (Full BW)			≥ 0.707	
		50 mV/div	1 ns/div (Full BW)			≥ 0.707	
		100 mV/div	1 ns/div (Full BW)			≥ 0.707	
		1 V/div	1 ns/div (Full BW)			≥ 0.707	
MDO4104C							
Channel 2	1 M Ω	1 mV/div	4 ns/div (175 MHz)			≥ 0.707	
		2 mV/div	2 ns/div (350 MHz)			≥ 0.707	
		5 mV/div	1 ns/div (500 MHz)			≥ 0.707	
		10 mV/div	1 ns/div (500 MHz)			≥ 0.707	
		50 mV/div	1 ns/div (500 MHz)			≥ 0.707	
		100 mV/div	1 ns/div (500 MHz)			≥ 0.707	
		1 V/div	1 ns/div (500 MHz)			≥ 0.707	

Analog Bandwidth

Performance checks

Bandwidth at Channel	Impedance	Vertical scale	Horizontal scale	V_{in-pp}	V_{bw-pp}	Limit	Test result Gain = V_{bw-pp}/V_{in-pp}
MDO4054C with option SA3 or SA6							
Channel 2	1 M Ω	1 mV/div	4 ns/div (175 MHz)			≥ 0.707	
		2 mV/div	2 ns/div (350 MHz)			≥ 0.707	
		5 mV/div	1 ns/div (380 MHz)			≥ 0.707	
		10 mV/div	1 ns/div (380 MHz)			≥ 0.707	
		50 mV/div	1 ns/div (380 MHz)			≥ 0.707	
		100 mV/div	1 ns/div (380 MHz)			≥ 0.707	
		1 V/div	1 ns/div (380 MHz)			≥ 0.707	
All other models with option SA3 or SA6							
Channel 2	1 M Ω	1 mV/div	4 ns/div (175 MHz)			≥ 0.707	
		2 mV/div	2 ns/div (Full BW for the MDO4024C, 350 MHz for other models)			≥ 0.707	
		5 mV/div	1 ns/div (Full BW)			≥ 0.707	
		10 mV/div	1 ns/div (Full BW)			≥ 0.707	
		50 mV/div	1 ns/div (Full BW)			≥ 0.707	
		100 mV/div	1 ns/div (Full BW)			≥ 0.707	
		1 V/div	1 ns/div (Full BW)			≥ 0.707	

Analog Bandwidth

Performance checks

Bandwidth at Channel	Impedance	Vertical scale	Horizontal scale	V_{in-pp}	V_{bw-pp}	Limit	Test result Gain = V_{bw-pp}/V_{in-pp}
All Models							
Channel 3	50 Ω	1 mV/div	4 ns/div (175 MHz for all models)			≥ 0.707	
		2 mV/div	2 ns/div (Full BW for the MDO4024C, 350 MHz for other models)			≥ 0.707	
		5 mV/div	1 ns/div (Full BW)			≥ 0.707	
		10 mV/div	1 ns/div (Full BW)			≥ 0.707	
		50 mV/div	1 ns/div (Full BW)			≥ 0.707	
		100 mV/div	1 ns/div (Full BW)			≥ 0.707	
		1 V/div	1 ns/div (Full BW)			≥ 0.707	
MDO4104C							
Channel 3	1 M Ω	1 mV/div	4 ns/div (175 MHz)			≥ 0.707	
		2 mV/div	2 ns/div (350 MHz)			≥ 0.707	
		5 mV/div	1 ns/div (500 MHz)			≥ 0.707	
		10 mV/div	1 ns/div (500 MHz)			≥ 0.707	
		50 mV/div	1 ns/div (500 MHz)			≥ 0.707	
		100 mV/div	1 ns/div (500 MHz)			≥ 0.707	
		1 V/div	1 ns/div (500 MHz)			≥ 0.707	

Analog Bandwidth

Performance checks

Bandwidth at Channel	Impedance	Vertical scale	Horizontal scale	V_{in-pp}	V_{bw-pp}	Limit	Test result Gain = V_{bw-pp}/V_{in-pp}
MDO4054C with option SA3 or SA6							
Channel 3	1 M Ω	1 mV/div	4 ns/div (175 MHz)			≥ 0.707	
		2 mV/div	2 ns/div (350 MHz)			≥ 0.707	
		5 mV/div	1 ns/div (380 MHz)			≥ 0.707	
		10 mV/div	1 ns/div (380 MHz)			≥ 0.707	
		50 mV/div	1 ns/div (380 MHz)			≥ 0.707	
		100 mV/div	1 ns/div (380 MHz)			≥ 0.707	
		1 V/div	1 ns/div (380 MHz)			≥ 0.707	
All other models with option SA3 or SA6							
Channel 3	1 M Ω	1 mV/div	4 ns/div (175 MHz)			≥ 0.707	
		2 mV/div	2 ns/div (Full BW for the MDO4024C, 350 MHz for other models))			≥ 0.707	
		5 mV/div	1 ns/div (Full BW)			≥ 0.707	
		10 mV/div	1 ns/div (Full BW)			≥ 0.707	
		50 mV/div	1 ns/div (Full BW)			≥ 0.707	
		100 mV/div	1 ns/div (Full BW)			≥ 0.707	
		1 V/div	1 ns/div (Full BW)			≥ 0.707	

Analog Bandwidth

Performance checks

Bandwidth at Channel	Impedance	Vertical scale	Horizontal scale	V_{in-pp}	V_{bw-pp}	Limit	Test result Gain = V_{bw-pp}/V_{in-pp}
All Models							
Channel 4	50 Ω	1 mV/div	4 ns/div (175 MHz for all models)			≥ 0.707	
		2 mV/div	2 ns/div (Full BW for the MDO4024C, 350 MHz for other models)			≥ 0.707	
		5 mV/div	1 ns/div (Full BW)			≥ 0.707	
		10 mV/div	1 ns/div (Full BW)			≥ 0.707	
		50 mV/div	1 ns/div (Full BW)			≥ 0.707	
		100 mV/div	1 ns/div (Full BW)			≥ 0.707	
		1 V/div	1 ns/div (Full BW)			≥ 0.707	
MDO4104C							
Channel 4	1 M Ω	1 mV/div	4 ns/div (175 MHz)			≥ 0.707	
		2 mV/div	2 ns/div (350 MHz)			≥ 0.707	
		5 mV/div	1 ns/div (500 MHz)			≥ 0.707	
		10 mV/div	1 ns/div (500 MHz)			≥ 0.707	
		50 mV/div	1 ns/div (500 MHz)			≥ 0.707	
		100 mV/div	1 ns/div (500 MHz)			≥ 0.707	
		1 V/div	1 ns/div (500 MHz)			≥ 0.707	

Analog Bandwidth

Performance checks

Bandwidth at Channel	Impedance	Vertical scale	Horizontal scale	V_{in-pp}	V_{bw-pp}	Limit	Test result Gain = V_{bw-pp}/V_{in-pp}
MDO4054C with option SA3 or SA6							
Channel 4	1 M Ω	1 mV/div	4 ns/div (175 MHz)			≥ 0.707	
		2 mV/div	2 ns/div (350 MHz)			≥ 0.707	
		5 mV/div	1 ns/div (380 MHz)			≥ 0.707	
		10 mV/div	1 ns/div (380 MHz)			≥ 0.707	
		50 mV/div	1 ns/div (380 MHz)			≥ 0.707	
		100 mV/div	1 ns/div (380 MHz)			≥ 0.707	
		1 V/div	1 ns/div (380 MHz)			≥ 0.707	
		All other models with option SA3 or SA6					
Channel 4	1 M Ω	1 mV/div	4 ns/div (175 MHz)			≥ 0.707	
		2 mV/div	2 ns/div (Full BW for the MDO4024C, 350 MHz for other models)			≥ 0.707	
		5 mV/div	1 ns/div (Full BW)			≥ 0.707	
		10 mV/div	1 ns/div (Full BW)			≥ 0.707	
		50 mV/div	1 ns/div (Full BW)			≥ 0.707	
		100 mV/div	1 ns/div (Full BW)			≥ 0.707	
		1 V/div	1 ns/div (Full BW)			≥ 0.707	

Random Noise, Sample Acquisition Mode

Performance checks		Vertical scale = 100 mV/div			
		1 M Ω		50 Ω	
	Bandwidth	Test result (mV)	High limit (mV)	Test result (mV)	High limit (mV)
MDO4104C					
Channel 1	Full		8.30		6.08
	250 MHz limit		5.10		4.05
	20 MHz limit		5.10		4.05
Channel 2	Full		8.30		6.08
	250 MHz limit		5.10		4.05
	20 MHz limit		5.10		4.05
Channel 3	Full		8.30		6.08
	250 MHz limit		5.10		4.05
	20 MHz limit		5.10		4.05
Channel 4	Full		8.30		6.08
	250 MHz limit		5.10		4.05
	20 MHz limit		5.10		4.05
All other models					
MDO4x04C without option SA3 or SA6:					
Channel 1	Full		8.13		8.13
	250 MHz limit		6.10		6.10
	20 MHz limit		4.10		4.10
Channel 2	Full		8.13		8.13
	250 MHz limit		6.10		6.10
	20 MHz limit		4.10		4.10
Channel 3	Full		8.13		8.13
	250 MHz limit		6.10		6.10
	20 MHz limit		4.10		4.10
Channel 4	Full		8.13		8.13
	250 MHz limit		6.10		6.10
	20 MHz limit		4.10		4.10
MDO4x04C with option SA3 or SA6:					
Channel 1	Full		8.30		8.13
	250 MHz limit		6.10		6.10
	20 MHz limit		4.10		4.10
Channel 2	Full		8.30		8.13
	250 MHz limit		6.10		6.10
	20 MHz limit		4.10		4.10

Random Noise, Sample Acquisition Mode

		Vertical scale = 100 mV/div			
Performance checks		1 M Ω		50 Ω	
	Bandwidth	Test result (mV)	High limit (mV)	Test result (mV)	High limit (mV)
Channel 3	Full		8.30		8.13
	250 MHz limit		6.10		6.10
	20 MHz limit		4.10		4.10
Channel 4	Full		8.30		8.13
	250 MHz limit		6.10		6.10
	20 MHz limit		4.10		4.10

Check Reference Frequency Error (Cumulative) for models with option SA3 or SA6

Performance checks	Low limit	Test result	High limit
	-640 ns		+640 ns

Check Reference Frequency Error (Cumulative) for models without option SA3 or SA6

Performance checks	Low limit	Test result	High limit
	-2 μ s		+ 2 μ s

Delta Time Measurement Accuracy

Performance checks

MDO4104C with option SA3 or SA6

Channel 1

MDO = 4 ns/div, Source freq = 240 MHz

MDO V/div	Source V_{pp}	Test result	High limit
5 mV	40 mV		118 ps
100 mV	800 mV		117 ps
500 mV	4 V		117 ps
1 V	4 V		122 ps

MDO = 40 ns/div, Source freq = 24 MHz

1 mV	8 mV		463 ps
5 mV	40 mV		275 ps
100 mV	800 mV		233 ps
500 mV	4 V		231 ps
1 V	4 V		415 ps

MDO = 400 ns/div, Source freq = 2.4 MHz

1 mV	8 mV		4.49 ns
5 mV	40 mV		2.50 ns
100 mV	800 mV		2.03 ns
500 mV	4 V		2.13 ns
1 V	4 V		4.00 ns

MDO = 4 μ s/div, Source freq = 240 kHz

1 mV	8 mV		44.9 ns
5 mV	40 mV		25.0 ns
100 mV	800 mV		20.3 ns
500 mV	4 V		20.1 ns
1 V	4 V		40.0 ns

MDO = 40 μ s/div, Source freq = 24 kHz

1 mV	8 mV		449 ns
5 mV	40 mV		250 ns
100 mV	800 mV		203 ns
500 mV	4 V		201 ns
1 V	4 V		400 ns

MDO = 400 μ s/div, Source freq = 2.4 kHz

1 mV	8 mV		4.49 μ s
5 mV	40 mV		2.50 μ s
100 mV	800 mV		2.03 μ s
500 mV	4 V		2.01 μ s
1 V	4 V		4.00 μ s

Delta Time Measurement Accuracy

MDO4104C with option SA3 or SA6

Channel 2

MDO = 4 ns/div, Source freq = 240 MHz

MDO V/div	Source V_{pp}	Test result	High limit
5 mV	40 mV		118 ps
100 mV	800 mV		117 ps
500 mV	4 V		117 ps
1 V	4 V		122 ps

MDO = 40 ns/div, Source freq = 24 MHz

1 mV	8 mV		463 ps
5 mV	40 mV		256 ps
100 mV	800 mV		233 ps
500 mV	4 V		231 ps
1 V	4 V		415 ps

MDO = 400 ns/div, Source freq = 2.4 MHz

1 mV	8 mV		4.49 ns
5 mV	40 mV		2.50 ns
100 mV	800 mV		2.03 ns
500 mV	4 V		2.01 ns
1 V	4 V		4.00 ns

MDO = 4 μ s/div, Source freq = 240 kHz

1 mV	8 mV		44.9 ns
5 mV	40 mV		25.0 ns
100 mV	800 mV		20.3 ns
500 mV	4 V		20.1 ns
1 V	4 V		40.0 ns

MDO = 40 μ s/div, Source freq = 24 kHz

1 mV	8 mV		449 ns
5 mV	40 mV		250 ns
100 mV	800 mV		203 ns
500 mV	4 V		201 ns
1 V	4 V		400 ns

MDO = 400 μ s/div, Source freq = 2.4 kHz

1 mV	8 mV		4.49 μ s
5 mV	40 mV		2.50 μ s
100 mV	800 mV		2.03 μ s
500 mV	4 V		2.01 μ s
1 V	4 V		4.00 μ s

Delta Time Measurement Accuracy

MDO4104C with option SA3 or SA6

Channel 3

MDO = 4 ns/div, Source freq = 240 MHz

MDO V/div	Source V _{pp}	Test result	High limit
5 mV	40 mV		118 ps
100 mV	800 mV		118 ps
500 mV	4 V		117 ps
1 V	4 V		122 ps

MDO = 40 ns/div, Source freq = 24 MHz

1 mV	8 mV		463 ps
5 mV	40 mV		275 ps
100 mV	800 mV		233 ps
500 mV	4 V		231 ps
1 V	4 V		415 ps

MDO = 400 ns/div, Source freq = 2.4 MHz

1 mV	8 mV		4.49 ns
5 mV	40 mV		2.50 ns
100 mV	800 mV		2.02 ns
500 mV	4 V		2.03 ns
1 V	4 V		4.01 ns

MDO = 4 μs/div, Source freq = 240 kHz

1 mV	8 mV		44.9 ns
5 mV	40 mV		25.0 ns
100 mV	800 mV		20.3 ns
500 mV	4 V		20.1 ns
1 V	4 V		40.0 ns

MDO = 40 μs/div, Source freq = 24 kHz

1 mV	8 mV		449 ns
5 mV	40 mV		250 ns
100 mV	800 mV		203 ns
500 mV	4 V		201 ns
1 V	4 V		400 ns

MDO = 400 μs/div, Source freq = 2.4 kHz

1 mV	8 mV		4.49 μs
5 mV	40 mV		2.50 μs
100 mV	800 mV		2.03 μs
500 mV	4 V		2.01 μs
1 V	4 V		4.00 μs

Delta Time Measurement Accuracy

MDO4104C with option SA3 or SA6

Channel 4

MDO = 4 ns/div, Source freq = 240 MHz

MDO V/div	Source V_{pp}	Test result	High limit
5 mV	40 mV		118 ps
100 mV	800 mV		117 ps
500 mV	4 V		117 ps
1 V	4 V		122 ps

MDO = 40 ns/div, Source freq = 24 MHz

1 mV	8 mV		463 ps
5 mV	40 mV		275 ps
100 mV	800 mV		233 ps
500 mV	4 V		231 ps
1 V	4 V		415 ps

MDO = 400 ns/div, Source freq = 2.4 MHz

1 mV	8 mV		4.49 ns
5 mV	40 mV		2.50 ns
100 mV	800 mV		2.03 ns
500 mV	4 V		2.01 ns
1 V	4 V		4.00 ns

MDO = 4 μ s/div, Source freq = 240 kHz

1 mV	8 mV		44.9 ns
5 mV	40 mV		25.0 ns
100 mV	800 mV		20.3 ns
500 mV	4 V		20.1 ns
1 V	4 V		40.0 ns

MDO = 40 μ s/div, Source freq = 24 kHz

1 mV	8 mV		449 ns
5 mV	40 mV		250 ns
100 mV	800 mV		203 ns
500 mV	4 V		201 ns
1 V	4 V		400 ns

MDO = 400 μ s/div, Source freq = 2.4 kHz

1 mV	8 mV		4.49 μ s
5 mV	40 mV		2.50 μ s
100 mV	800 mV		2.03 μ s
500 mV	4 V		2.01 μ s
1 V	4 V		4.00 μ s

Delta Time Measurement Accuracy

MDO4104C without option SA3 or SA6

Channel 1

MDO = 4 ns/div, Source freq = 240 MHz

MDO V/div	Source V _{pp}	Test result	High limit
5 mV	40 mV		118 ps
100 mV	800 mV		118 ps
500 mV	4 V		117 ps
1 V	4 V		122 ps

MDO = 40 ns/div, Source freq = 24 MHz

1 mV	8 mV		464 ps
5 mV	40 mV		276 ps
100 mV	800 mV		234 ps
500 mV	4 V		232 ps
1 V	4 V		417 ps

MDO = 400 ns/div, Source freq = 2.4 MHz

1 mV	8 mV		4.50 ns
5 mV	40 mV		2.52 ns
100 mV	800 mV		2.05 ns
500 mV	4 V		2.03 ns
1 V	4 V		4.01 ns

MDO = 4 μs/div, Source freq = 240 kHz

1 mV	8 mV		45.0 ns
5 mV	40 mV		25.2 ns
100 mV	800 mV		20.5 ns
500 mV	4 V		20.3 ns
1 V	4 V		40.1 ns

MDO = 40 μs/div, Source freq = 24 kHz

1 mV	8 mV		450 ns
5 mV	40 mV		252 ns
100 mV	800 mV		205 ns
500 mV	4 V		203 ns
1 V	4 V		401 ns

MDO = 400 μs/div, Source freq = 2.4 kHz

1 mV	8 mV		4.50 μs
5 mV	40 mV		2.52 μs
100 mV	800 mV		2.05 μs
500 mV	4 V		2.03 μs
1 V	4 V		4.01 μs

Delta Time Measurement Accuracy

MDO4104C with out option SA3 or SA6

Channel 2

MDO = 4 ns/div, Source freq = 240 MHz

MDO V/div	Source V_{pp}	Test result	High limit
5 mV	40 mV		118 ps
100 mV	800 mV		118 ps
500 mV	4 V		117 ps
1 V	4 V		122 ps

MDO = 40 ns/div, Source freq = 24 MHz

1 mV	8 mV		464 ps
5 mV	40 mV		276 ps
100 mV	800 mV		234 ps
500 mV	4 V		232 ps
1 V	4 V		417 ps

MDO = 400 ns/div, Source freq = 2.4 MHz

1 mV	8 mV		4.50 ns
5 mV	40 mV		2.52 ns
100 mV	800 mV		2.05 ns
500 mV	4 V		2.03 ns
1 V	4 V		4.01 ns

MDO = 4 μ s/div, Source freq = 240 kHz

1 mV	8 mV		45.0 ns
5 mV	40 mV		25.2 ns
100 mV	800 mV		20.5 ns
500 mV	4 V		20.3 ns
1 V	4 V		40.1 ns

MDO = 40 μ s/div, Source freq = 24 kHz

1 mV	8 mV		450 ns
5 mV	40 mV		252 ns
100 mV	800 mV		205 ns
500 mV	4 V		203 ns
1 V	4 V		401 ns

MDO = 400 μ s/div, Source freq = 2.4 kHz

1 mV	8 mV		4.50 μ s
5 mV	40 mV		2.52 μ s
100 mV	800 mV		2.05 μ s
500 mV	4 V		2.03 μ s
1 V	4 V		4.01 μ s

Delta Time Measurement Accuracy

MDO4104C without option SA3 or SA6

Channel 3

MDO = 4 ns/div, Source freq = 240 MHz

MDO V/div	Source V _{pp}	Test result	High limit
5 mV	40 mV		118 ps
100 mV	800 mV		118 ps
500 mV	4 V		117 ps
1 V	4 V		122 ps

MDO = 40 ns/div, Source freq = 24 MHz

1 mV	8 mV		464 ps
5 mV	40 mV		276 ps
100 mV	800 mV		234 ps
500 mV	4 V		232 ps
1 V	4 V		417 ps

MDO = 400 ns/div, Source freq = 2.4 MHz

1 mV	8 mV		4.50 ns
5 mV	40 mV		2.52 ns
100 mV	800 mV		2.05 ns
500 mV	4 V		2.03 ns
1 V	4 V		4.01 ns

MDO = 4 μs/div, Source freq = 240 kHz

1 mV	8 mV		45.0 ns
5 mV	40 mV		25.2 ns
100 mV	800 mV		20.5 ns
500 mV	4 V		20.3 ns
1 V	4 V		40.1 ns

MDO = 40 μs/div, Source freq = 24 kHz

1 mV	8 mV		450 ns
5 mV	40 mV		252 ns
100 mV	800 mV		205 ns
500 mV	4 V		203 ns
1 V	4 V		401 ns

MDO = 400 μs/div, Source freq = 2.4 kHz

1 mV	8 mV		4.50 μs
5 mV	40 mV		2.52 μs
100 mV	800 mV		2.05 μs
500 mV	4 V		2.02 μs
1 V	4 V		4.01 μs

Delta Time Measurement Accuracy

MDO4104C without option SA3 or SA6

Channel 4

MDO = 4 ns/div, Source freq = 240 MHz

MDO V/div	Source V _{pp}	Test result	High limit
5 mV	40 mV		118 ps
100 mV	800 mV		118 ps
500 mV	4 V		117 ps
1 V	4 V		122 ps

MDO = 40 ns/div, Source freq = 24 MHz

1 mV	8 mV		464 ps
5 mV	40 mV		276 ps
100 mV	800 mV		234 ps
500 mV	4 V		232 ps
1 V	4 V		417 ps

MDO = 400 ns/div, Source freq = 2.4 MHz

1 mV	8 mV		4.50 ns
5 mV	40 mV		2.52 ns
100 mV	800 mV		2.05 ns
500 mV	4 V		2.03 ns
1 V	4 V		4.01 ns

MDO = 4 μs/div, Source freq = 240 kHz

1 mV	8 mV		45.0 ns
5 mV	40 mV		25.2 ns
100 mV	800 mV		20.5 ns
500 mV	4 V		20.3 ns
1 V	4 V		40.1 ns

MDO = 40 μs/div, Source freq = 24 kHz

1 mV	8 mV		450 ns
5 mV	40 mV		252 ns
100 mV	800 mV		205 ns
500 mV	4 V		203 ns
1 V	4 V		401 ns

MDO = 400 μs/div, Source freq = 2.4 kHz

1 mV	8 mV		4.50 μs
5 mV	40 mV		2.52 μs
100 mV	800 mV		2.05 μs
500 mV	4 V		2.03 μs
1 V	4 V		4.01 μs

Delta Time Measurement Accuracy

MDO40X4C without option SA3 or SA6

Channel 1

MDO = 4 ns/div, Source freq = 240 MHz (except for the MDO4024C)

MDO V/div	Source V _{pp}	Test result	High limit
5 mV	40 mV		234 ps
100 mV	800 mV		233 ps
500 mV	4 V		233 ps
1 V	4 V		237 ps

MDO = 40 ns/div, Source freq = 24 MHz

1 mV	8 mV		736 ps
5 mV	40 mV		423 ps
100 mV	800 mV		357 ps
500 mV	4 V		354 ps
1 V	4 V		581 ps

MDO = 400 ns/div, Source freq = 2.4 MHz

1 mV	8 mV		6.99 ns
5 mV	40 mV		3.54 ns
100 mV	800 mV		2.73 ns
500 mV	4 V		2.69 ns
1 V	4 V		5.34 ns

MDO = 4 μs/div, Source freq = 240 kHz

1 mV	8 mV		69.9 ns
5 mV	40 mV		35.4 ns
100 mV	800 mV		27.3 ns
500 mV	4 V		26.9 ns
1 V	4 V		53.4 ns

MDO = 40 μs/div, Source freq = 24 kHz

1 mV	8 mV		699 ns
5 mV	40 mV		354 ns
100 mV	800 mV		273 ns
500 mV	4 V		269 ns
1 V	4 V		534 ns

MDO = 400 μs/div, Source freq = 2.4 kHz

1 mV	8 mV		6.99 μs
5 mV	40 mV		3.54 μs
100 mV	800 mV		2.73 μs
500 mV	4 V		2.69 μs
1 V	4 V		5.34 μs

Delta Time Measurement Accuracy

MDO40X4C without option SA3 or SA6

Channel 2

MDO = 4 ns/div, Source freq = 240 MHz (except for the MDO4024C)

MDO V/div	Source V_{pp}	Test result	High limit
5 mV	40 mV		234 ps
100 mV	800 mV		233 ps
500 mV	4 V		233 ps
1 V	4 V		237 ps

MDO = 40 ns/div, Source freq = 24 MHz

1 mV	8 mV		736 ps
5 mV	40 mV		423 ps
100 mV	800 mV		357 ps
500 mV	4 V		354 ps
1 V	4 V		581 ps

MDO = 400 ns/div, Source freq = 2.4 MHz

1 mV	8 mV		6.99 ns
5 mV	40 mV		3.54 ns
100 mV	800 mV		2.73 ns
500 mV	4 V		2.69 ns
1 V	4 V		5.34 ns

MDO = 4 μ s/div, Source freq = 240 kHz

1 mV	8 mV		69.9 ns
5 mV	40 mV		35.4 ns
100 mV	800 mV		27.3 ns
500 mV	4 V		26.9 ns
1 V	4 V		53.4 ns

MDO = 40 μ s/div, Source freq = 24 kHz

1 mV	8 mV		699 ns
5 mV	40 mV		354 ns
100 mV	800 mV		273 ns
500 mV	4 V		269 ns
1 V	4 V		534 ns

MDO = 400 μ s/div, Source freq = 2.4 kHz

1 mV	8 mV		6.99 μ s
5 mV	40 mV		3.54 μ s
100 mV	800 mV		2.73 μ s
500 mV	4 V		2.69 μ s
1 V	4 V		5.34 μ s

Delta Time Measurement Accuracy

MDO40X4C without option SA3 or SA6

Channel 3

MDO = 4 ns/div, Source freq = 240 MHz (except for the MDO4024C)

MDO V/div	Source V _{pp}	Test result	High limit
5 mV	40 mV		234 ps
100 mV	800 mV		233 ps
500 mV	4 V		233 ps
1 V	4 V		237 ps

MDO = 40 ns/div, Source freq = 24 MHz

1 mV	8 mV		736 ps
5 mV	40 mV		423 ps
100 mV	800 mV		357 ps
500 mV	4 V		354 ps
1 V	4 V		581 ps

MDO = 400 ns/div, Source freq = 2.4 MHz

1 mV	8 mV		6.99 ns
5 mV	40 mV		3.54 ns
100 mV	800 mV		2.73 ns
500 mV	4 V		2.69 ns
1 V	4 V		5.34 ns

MDO = 4 μs/div, Source freq = 240 kHz

1 mV	8 mV		69.9 ns
5 mV	40 mV		35.4 ns
100 mV	800 mV		27.3 ns
500 mV	4 V		26.9 ns
1 V	4 V		53.4 ns

MDO = 40 μs/div, Source freq = 24 kHz

1 mV	8 mV		699 ns
5 mV	40 mV		354 ns
100 mV	800 mV		273 ns
500 mV	4 V		269 ns
1 V	4 V		534 ns

MDO = 400 μs/div, Source freq = 2.4 kHz

1 mV	8 mV		6.99 μs
5 mV	40 mV		3.54 μs
100 mV	800 mV		2.73 μs
500 mV	4 V		2.69 μs
1 V	4 V		5.34 μs

Delta Time Measurement Accuracy

MDO40X4C without option SA3 or SA6

Channel 4**MDO = 4 ns/div, Source freq = 240 MHz (except for the MDO4024C)**

MDO V/div	Source V_{pp}	Test result	High limit
5 mV	40 mV		234 ps
100 mV	800 mV		233 ps
500 mV	4 V		233 ps
1 V	4 V		237 ps

MDO = 40 ns/div, Source freq = 24 MHz

1 mV	8 mV		736 ps
5 mV	40 mV		423 ps
100 mV	800 mV		357 ps
500 mV	4 V		354 ps
1 V	4 V		581 ps

MDO = 400 ns/div, Source freq = 2.4 MHz

1 mV	8 mV		6.99 ns
5 mV	40 mV		3.54 ns
100 mV	800 mV		2.73 ns
500 mV	4 V		2.69 ns
1 V	4 V		5.34 ns

MDO = 4 μ s/div, Source freq = 240 kHz

1 mV	8 mV		69.9 ns
5 mV	40 mV		35.4 ns
100 mV	800 mV		27.3 ns
500 mV	4 V		26.9 ns
1 V	4 V		53.4 ns

MDO = 40 μ s/div, Source freq = 24 kHz

1 mV	8 mV		699 ns
5 mV	40 mV		354 ns
100 mV	800 mV		273 ns
500 mV	4 V		269 ns
1 V	4 V		534 ns

MDO = 400 μ s/div, Source freq = 2.4 kHz

1 mV	8 mV		6.99 μ s
5 mV	40 mV		3.54 μ s
100 mV	800 mV		2.73 μ s
500 mV	4 V		2.69 μ s
1 V	4 V		5.34 μ s

Delta Time Measurement Accuracy

MDO40X4C with option SA3 or SA6

Channel 1

MDO = 4 ns/div, Source freq = 240 MHz (except for the MDO4024C)

MDO V/div	Source V _{pp}	Test result	High limit
5 mV	40 mV		234 ps
100 mV	800 mV		233 ps
500 mV	4 V		233 ps
1 V	4 V		237 ps

MDO = 40 ns/div, Source freq = 24 MHz

1 mV	8 mV		734 ps
5 mV	40 mV		421 ps
100 mV	800 mV		356 ps
500 mV	4 V		353 ps
1 V	4 V		580 ps

MDO = 400 ns/div, Source freq = 2.4 MHz

1 mV	8 mV		6.97 ns
5 mV	40 mV		3.53 ns
100 mV	800 mV		2.71 ns
500 mV	4 V		2.68 ns
1 V	4 V		5.32 ns

MDO = 4 μs/div, Source freq = 240 kHz

1 mV	8 mV		69.7 ns
5 mV	40 mV		35.3 ns
100 mV	800 mV		27.1 ns
500 mV	4 V		26.8 ns
1 V	4 V		53.2 ns

MDO = 40 μs/div, Source freq = 24 kHz

1 mV	8 mV		697 ns
5 mV	40 mV		353 ns
100 mV	800 mV		271 ns
500 mV	4 V		268 ns
1 V	4 V		532 ns

MDO = 400 μs/div, Source freq = 2.4 kHz

1 mV	8 mV		6.97 μs
5 mV	40 mV		3.53 μs
100 mV	800 mV		2.71 μs
500 mV	4 V		2.68 μs
1 V	4 V		5.32 μs

Delta Time Measurement Accuracy

MDO40X4C with option SA3 or SA6

Channel 2

MDO = 4 ns/div, Source freq = 240 MHz (except for the MDO4024C)

MDO V/div	Source V _{pp}	Test result	High limit
5 mV	40 mV		234 ps
100 mV	800 mV		233 ps
500 mV	4 V		233 ps
1 V	4 V		237 ps

MDO = 40 ns/div, Source freq = 24 MHz

1 mV	8 mV		734 ps
5 mV	40 mV		421 ps
100 mV	800 mV		356 ps
500 mV	4 V		353 ps
1 V	4 V		580 ps

MDO = 400 ns/div, Source freq = 2.4 MHz

1 mV	8 mV		6.97 ns
5 mV	40 mV		3.53 ns
100 mV	800 mV		2.71 ns
500 mV	4 V		2.68 ns
1 V	4 V		5.32 ns

MDO = 4 μs/div, Source freq = 240 kHz

1 mV	8 mV		69.7 ns
5 mV	40 mV		35.3 ns
100 mV	800 mV		27.1 ns
500 mV	4 V		26.8 ns
1 V	4 V		53.2 ns

MDO = 40 μs/div, Source freq = 24 kHz

1 mV	8 mV		697 ns
5 mV	40 mV		353 ns
100 mV	800 mV		271 ns
500 mV	4 V		268 ns
1 V	4 V		532 ns

MDO = 400 μs/div, Source freq = 2.4 kHz

1 mV	8 mV		6.97 μs
5 mV	40 mV		3.53 μs
100 mV	800 mV		2.71 μs
500 mV	4 V		2.68 μs
1 V	4 V		5.32 μs

Delta Time Measurement Accuracy

MDO40X4C with option SA3 or SA6

Channel 3

MDO = 4 ns/div, Source freq = 240 MHz (except for the MDO4024C)

MDO V/div	Source V _{pp}	Test result	High limit
5 mV	40 mV		234 ps
100 mV	800 mV		233 ps
500 mV	4 V		233 ps
1 V	4 V		237 ps

MDO = 40 ns/div, Source freq = 24 MHz

1 mV	8 mV		734 ps
5 mV	40 mV		421 ps
100 mV	800 mV		356 ps
500 mV	4 V		353 ps
1 V	4 V		580 ps

MDO = 400 ns/div, Source freq = 2.4 MHz

1 mV	8 mV		6.97 ns
5 mV	40 mV		3.53 ns
100 mV	800 mV		2.71 ns
500 mV	4 V		2.68 ns
1 V	4 V		5.32 ns

MDO = 4 μs/div, Source freq = 240 kHz

1 mV	8 mV		69.7 ns
5 mV	40 mV		35.3 ns
100 mV	800 mV		27.1 ns
500 mV	4 V		26.8 ns
1 V	4 V		53.2 ns

MDO = 40 μs/div, Source freq = 24 kHz

1 mV	8 mV		697 ns
5 mV	40 mV		353 ns
100 mV	800 mV		271 ns
500 mV	4 V		268 ns
1 V	4 V		532 ns

MDO = 400 μs/div, Source freq = 2.4 kHz

1 mV	8 mV		6.97 μs
5 mV	40 mV		3.53 μs
100 mV	800 mV		2.71 μs
500 mV	4 V		2.68 μs
1 V	4 V		5.32 μs

Delta Time Measurement Accuracy

MDO40X4C with option SA3 or SA6

Channel 4

MDO = 4 ns/div, Source freq = 240 MHz (except for the MDO4024C)

MDO V/div	Source V_{pp}	Test result	High limit
5 mV	40 mV		234 ps
100 mV	800 mV		233 ps
500 mV	4 V		233 ps
1 V	4 V		237 ps

MDO = 40 ns/div, Source freq = 24 MHz

1 mV	8 mV		734 ps
5 mV	40 mV		421 ps
100 mV	800 mV		356 ps
500 mV	4 V		353 ps
1 V	4 V		580 ps

MDO = 400 ns/div, Source freq = 2.4 MHz

1 mV	8 mV		6.97 ns
5 mV	40 mV		3.53 ns
100 mV	800 mV		2.71 ns
500 mV	4 V		2.68 ns
1 V	4 V		5.32 ns

MDO = 4 μ s/div, Source freq = 240 kHz

1 mV	8 mV		69.7 ns
5 mV	40 mV		35.3 ns
100 mV	800 mV		27.1 ns
500 mV	4 V		26.8 ns
1 V	4 V		53.2 ns

MDO = 40 μ s/div, Source freq = 24 kHz

1 mV	8 mV		697 ns
5 mV	40 mV		353 ns
100 mV	800 mV		271 ns
500 mV	4 V		268 ns
1 V	4 V		532 ns

MDO = 400 μ s/div, Source freq = 2.4 kHz

1 mV	8 mV		6.97 μ s
5 mV	40 mV		3.53 μ s
100 mV	800 mV		2.71 μ s
500 mV	4 V		2.68 μ s
1 V	4 V		5.32 μ s

Digital Threshold Accuracy

Performance checks:

Digital channel	Threshold	V_{slow}	V_{shigh}	Low limit	Test result	High limit
D0	0 V			-0.1 V		0.1 V
	4 V			3.78 V		4.22 V
D1	0 V			-0.1 V		0.1 V
	4 V			3.78 V		4.22 V
D2	0 V			-0.1 V		0.1 V
	4 V			3.78 V		4.22 V
D3	0 V			-0.1 V		0.1 V
	4 V			3.78 V		4.22 V
D4	0 V			-0.1 V		0.1 V
	4 V			3.78 V		4.22 V
D5	0 V			-0.1 V		0.1 V
	4 V			3.78 V		4.22 V
D6	0 V			-0.1 V		0.1 V
	4 V			3.78 V		4.22 V
D7	0 V			-0.1 V		0.1 V
	4 V			3.78 V		4.22 V
D8	0 V			-0.1 V		0.1 V
	4 V			3.78 V		4.22 V
D9	0 V			-0.1 V		0.1 V
	4 V			3.78 V		4.22 V
D10	0 V			-0.1 V		0.1 V
	4 V			3.78 V		4.22 V
D11	0 V			-0.1 V		0.1 V
	4 V			3.78 V		4.22 V
D12	0 V			-0.1 V		0.1 V
	4 V			3.78 V		4.22 V
D13	0 V			-0.1 V		0.1 V
	4 V			3.78 V		4.22 V
D14	0 V			-0.1 V		0.1 V
	4 V			3.78 V		4.22 V
D15	0 V			-0.1 V		0.1 V
	4 V			3.78 V		4.22 V

Phase Noise at 1 GHz

Performance checks	Offset	Low limit	Test result	High limit
Center Frequency 1 GHz	10 kHz	N/A		-108 dBc/Hz
	100 kHz	N/A		-110 dBc/Hz
	1 MHz	N/A		-120 dBc/Hz

Displayed Average Noise Level (DANL)

Performance checks		Low limit	Test result	High limit
All models	9 kHz – 50 kHz	N/A		< -116 dBm/Hz
	50 kHz – 5 MHz	N/A		< -130 dBm/Hz
	5 MHz – 400 MHz	N/A		< -146 dBm/Hz
	400 MHz – 3 GHz	N/A		< -147 dBm/Hz
Option SA6	3 GHz – 4 GHz	N/A		< -148 dBm/Hz
	4 GHz – 6 GHz	N/A		< -140 dBm/Hz

Absolute Amplitude Accuracy

Performance checks			Low limit	Test result	High limit
+10 dBm	All models	50 kHz – 950 kHz	-1 dBm		+1 dBm
		1 MHz – 9 MHz	-1 dBm		+1 dBm
		10 MHz – 90 MHz	-1 dBm		+1 dBm
		100 MHz – 3 GHz	-1 dBm		+1 dBm
	Option SA6 only	>3 GHz – 6 GHz	-1 dBm		+1 dBm
0 dBm	All models	50 kHz – 950 kHz	-1 dBm		+1 dBm
		1 MHz – 9 MHz	-1 dBm		+1 dBm
		10 MHz – 90 MHz	-1 dBm		+1 dBm
		100 MHz – 3 GHz	-1 dBm		+1 dBm
	Option SA6 only	> 3 GHz – 6 GHz	-1 dBm		+1 dBm
-15 dBm	All models	50 kHz – 950 kHz	-1 dBm		+1 dBm
		1 MHz – 9 MHz	-1 dBm		+1 dBm
		10 MHz – 90 MHz	-1 dBm		+1 dBm
		100 MHz – 3 GHz	-1 dBm		+1 dBm
	Option SA6 only	>3 GHz – 6 GHz	-1 dBm		+1 dBm

Third Order Intermodulation Distortion

Performance checks			Low limit	Test result	High limit
All models	Center Frequency 2.745 GHz	Intermod spur 1	N/A		-62 dBc
		Intermod spur 2	N/A		-62 dBc
Option SA6	Center Frequency 4.5 GHz	Intermod spur 1	N/A		-62 dBc
		Intermod spur 2	N/A		-62 dBc

Residual Spurious Response

Performance checks	Low limit	Test result	High limit
All models	9 kHz to 50 kHz	N/A	-85 dBm
	50 kHz to 3 GHz		-85 dBm
	2.5 GHz	N/A	-73 dBm
Option SA6	2.75 GHz to 4.5 GHz	N/A	-85 dBm
	3.5 GHz to 5.99 GHz	N/A	-85 dBm
	3.75 GHz	N/A	-78 dBm
	4 GHz	N/A	-78 dBm
	5 GHz	N/A	-78 dBm

Crosstalk to RF channel from analog channels

Performance checks

Channel 1 crosstalk		Low limit	Test result	High limit
Generator signal frequency and Oscilloscope Center Frequency setting	105 MHz	N/A		-68 dBm
	205 MHz	N/A		-68 dBm
	305 MHz	N/A		-68 dBm
	405 MHz	N/A		-68 dBm
	505 MHz	N/A		-68 dBm
	605 MHz	N/A		-68 dBm
	705 MHz	N/A		-68 dBm
	805 MHz	N/A		-68 dBm
	905 MHz	N/A		-68 dBm
	1.005 GHz	N/A		-68 dBm
	1.105 GHz	N/A		-48 dBm
	1.205 GHz	N/A		-48 dBm
	1.305 GHz	N/A		-48 dBm
	1.405 GHz	N/A		-48 dBm
	1.505 GHz	N/A		-48 dBm
	1.605 GHz	N/A		-48 dBm
	1.705 GHz	N/A		-48 dBm
	1.805 GHz	N/A		-48 dBm
	1.905 GHz	N/A		-48 dBm
	2.005 GHz	N/A		-48 dBm

Crosstalk to RF channel from analog channels

Channel 2 crosstalk		Low limit	Test result	High limit
Generator signal frequency and Oscilloscope Center Frequency setting	105 MHz	N/A		-68 dBm
	205 MHz	N/A		-68 dBm
	305 MHz	N/A		-68 dBm
	405 MHz	N/A		-68 dBm
	505 MHz	N/A		-68 dBm
	605 MHz	N/A		-68 dBm
	705 MHz	N/A		-68 dBm
	805 MHz	N/A		-68 dBm
	905 MHz	N/A		-68 dBm
	1.005 GHz	N/A		-68 dBm
	1.105 GHz	N/A		-48 dBm
	1.205 GHz	N/A		-48 dBm
	1.305 GHz	N/A		-48 dBm
	1.405 GHz	N/A		-48 dBm
	1.505 GHz	N/A		-48 dBm
	1.605 GHz	N/A		-48 dBm
	1.705 GHz	N/A		-48 dBm
	1.805 GHz	N/A		-48 dBm
	1.905 GHz	N/A		-48 dBm
2.005 GHz	N/A		-48 dBm	

Crosstalk to RF channel from analog channels

Channel 3 crosstalk		Low limit	Test result	High limit
Generator signal frequency and Oscilloscope Center Frequency setting	105 MHz	N/A		-68 dBm
	205 MHz	N/A		-68 dBm
	305 MHz	N/A		-68 dBm
	405 MHz	N/A		-68 dBm
	505 MHz	N/A		-68 dBm
	605 MHz	N/A		-68 dBm
	705 MHz	N/A		-68 dBm
	805 MHz	N/A		-68 dBm
	905 MHz	N/A		-68 dBm
	1.005 GHz	N/A		-68 dBm
	1.105 GHz	N/A		-48 dBm
	1.205 GHz	N/A		-48 dBm
	1.305 GHz	N/A		-48 dBm
	1.405 GHz	N/A		-48 dBm
	1.505 GHz	N/A		-48 dBm
	1.605 GHz	N/A		-48 dBm
	1.705 GHz	N/A		-48 dBm
	1.805 GHz	N/A		-48 dBm
	1.905 GHz	N/A		-48 dBm
	2.005 GHz	N/A		-48 dBm

Crosstalk to RF channel from analog channels

Channel 4 crosstalk		Low limit	Test result	High limit
Generator signal frequency and Oscilloscope Center Frequency setting	105 MHz	N/A		-68 dBm
	205 MHz	N/A		-68 dBm
	305 MHz	N/A		-68 dBm
	405 MHz	N/A		-68 dBm
	505 MHz	N/A		-68 dBm
	605 MHz	N/A		-68 dBm
	705 MHz	N/A		-68 dBm
	805 MHz	N/A		-68 dBm
	905 MHz	N/A		-68 dBm
	1.005 GHz	N/A		-68 dBm
	1.105 GHz	N/A		-48 dBm
	1.205 GHz	N/A		-48 dBm
	1.305 GHz	N/A		-48 dBm
	1.405 GHz	N/A		-48 dBm
	1.505 GHz	N/A		-48 dBm
	1.605 GHz	N/A		-48 dBm
	1.705 GHz	N/A		-48 dBm
1.805 GHz	N/A		-48 dBm	
1.905 GHz	N/A		-48 dBm	
2.005 GHz	N/A		-48 dBm	

Auxiliary (Trigger) Output

Performance checks		Low limit	Test result	High limit
Trigger Output	High 1 M Ω	≥ 2.5 V		-
	Low 1 M Ω	-		≤ 0.7 V
Trigger Output	High 50 Ω	≥ 1.0 V		-
	Low 50 Ω	-		≤ 0.25 V

With TPA-N-PRE Attached

With TPA-N-PRE attached: Displayed Average Noise Level (DANL)

Performance checks		Low limit	Test result	High limit
All models (with TPA-N-PRE attached)	9 kHz – 50 kHz	N/A		-119 dBm/Hz
	50 kHz – 5 MHz	N/A		-140 dBm/Hz
	5 MHz – 400 MHz	N/A		-156 dBm/Hz
	5 MHz – 3 GHz	N/A		-157 dBm/Hz
MDO4XX4C option SA6 only (with TPA-N-PRE attached)	3 GHz – 4 GHz	N/A		-158 dBm/Hz
	4 GHz – 6 GHz	N/A		-150 dBm/Hz

AFG Sine and Ramp Frequency Accuracy Tests

AFG Sine and Ramp Frequency Accuracy Tests

Performance checks		Low limit	Test result	High limit
All models	Sine Wave at 10 kHz, 2.5 V, 50 Ω	9.9987 kHz		10.0013 kHz
	Sine Wave at 50 MHz, 2.5 V, 50 Ω	49.9975 MHz		50.0025 MHz

AFG Square and Pulse Frequency Accuracy Tests

AFG Square and Pulse Frequency Accuracy Tests

Performance checks		Low limit	Test result	High limit
All models	Square Wave at 25 kHz, 2.5 V, 50 Ω	24.99875 kHz		25.00125 kHz
	Square Wave at 25 MHz, 2.5 V, 50 Ω	24.99875 MHz		25.00125 MHz

AFG Signal Amplitude Accuracy Tests

AFG Signal Amplitude Accuracy Tests

Performance checks		Low limit	Test result	High limit
All models	Square Wave 20 mVpp @ 1 kHz, 50 Ω , 0 V Offset	9.35 mV		10.65 mV
	Square Wave 1 Vpp @ 1 kHz, 50 Ω , 0.2 V Offset	490.5 mV		509.5 mV

AFG DC Offset Accuracy Tests

AFG DC Offset Accuracy Tests

Performance checks		Low limit	Test result	High limit
All models	20 mV DC @ 50 Ω	18.7 mV		21.3 mV
	1 V DC @ 50 Ω	0.984 V		1.016 V

DVM Voltage Accuracy Tests (DC)

DVM Voltage Accuracy (DC)

Channel 1

Vertical Scale	Input Voltage	Offset Voltage	Low limit	Test result	High limit
1	-5	-5	-5.125		-4.875
0.5	-2	-2	-2.06		-1.94
0.5	-1	-0.5	-1.06		-0.94
0.2	-0.5	-0.5	-0.5225		-0.4775
0.01	0.002	0	0.00097		0.00303
0.2	0.5	0.5	0.4775		0.5225
0.5	1	0.5	0.94		1.06
0.5	2	2	1.94		2.06
1	5	5	4.875		5.125

Channel 2

Vertical Scale	Input Voltage	Offset Voltage	Low limit	Test result	High limit
1	-5	-5	-5.125		-4.875
0.5	-2	-2	-2.06		-1.94
0.5	-1	-0.5	-1.06		-0.94
0.2	-0.5	-0.5	-0.5225		-0.4775

0.01	0.002	0	0.00097		0.00303
0.2	0.5	0.5	0.4775		0.5225
0.5	1	0.5	0.94		1.06
0.5	2	2	1.94		2.06
1	5	5	4.875		5.125
Channel 3					
Vertical Scale	Input Voltage	Offset Voltage	Low limit	Test result	High limit
1	-5	-5	-5.125		-4.875
0.5	-2	-2	-2.06		-1.94
0.5	-1	-0.5	-1.06		-0.94
0.2	-0.5	-0.5	-0.5225		-0.4775
0.01	0.002	0	0.00097		0.00303
0.2	0.5	0.5	0.4775		0.5225
0.5	1	0.5	0.94		1.06
0.5	2	2	1.94		2.06
1	5	5	4.875		5.125
Channel 4					
Vertical Scale	Input Voltage	Offset Voltage	Low limit	Test result	High limit
1	-5	-5	-5.125		-4.875
0.5	-2	-2	-2.06		-1.94
0.5	-1	-0.5	-1.06		-0.94
0.2	-0.5	-0.5	-0.5225		-0.4775
0.01	0.002	0	0.00097		0.00303
0.2	0.5	0.5	0.4775		0.5225
0.5	1	0.5	0.94		1.06
0.5	2	2	1.94		2.06
1	5	5	4.875		5.125

DVM Voltage Accuracy Tests (AC)

DVM Voltage Accuracy (AC)

Channel 1

Vertical Scale	Input Signal	Low limit	Test result	High limit
5 mV	20 mV _{pp} at 1 kHz	9.800 mV		10.200 mV
10 mV	50 mV _{pp} at 1 kHz	24.5 mV		25.500 mV
100 mV	0.5 V _{pp} at 1 kHz	245.000 mV		255.000 mV
200 mV	1 V _{pp} at 1 kHz	490.000 mV		510.000 mV
1 V	5 V _{pp} at 1 kHz	2.450 mV		2.550 mV

Channel 2

Vertical Scale	Input Signal	Low limit	Test result	High limit
5 mV	20 mV _{pp} at 1 kHz	9.800 mV		10.200 mV
10 mV	50 mV _{pp} at 1 kHz	24.5 mV		25.500 mV
100 mV	0.5 V _{pp} at 1 kHz	245.000 mV		255.000 mV
200 mV	1 V _{pp} at 1 kHz	490.000 mV		510.000 mV
1 V	5 V _{pp} at 1 kHz	2.450 mV		2.550 mV

Channel 3

Vertical Scale	Input Signal	Low limit	Test result	High limit
5 mV	20 mV _{pp} at 1 kHz	9.800 mV		10.200 mV
10 mV	50 mV _{pp} at 1 kHz	24.5 mV		25.500 mV
100 mV	0.5 V _{pp} at 1 kHz	245.000 mV		255.000 mV
200 mV	1 V _{pp} at 1 kHz	490.000 mV		510.000 mV
1 V	5 V _{pp} at 1 kHz	2.450 mV		2.550 mV

Channel 4

Vertical Scale	Input Signal	Low limit	Test result	High limit
5 mV	20 mV _{pp} at 1 kHz	9.800 mV		10.200 mV
10 mV	50 mV _{pp} at 1 kHz	24.5 mV		25.500 mV
100 mV	0.5 V _{pp} at 1 kHz	245.000 mV		255.000 mV
200 mV	1 V _{pp} at 1 kHz	490.000 mV		510.000 mV
1 V	5 V _{pp} at 1 kHz	2.450 mV		2.550 mV

DVM Frequency Accuracy Tests and Maximum Input Frequency

DVM Frequency Accuracy

Channel 1

Hz	Low limit	Test result	High limit
10 Hz	9.9989 Hz		10.001 Hz
100 Hz	99.989 Hz		100.01 Hz
1 kHz	999.89 Hz		1.0001 kHz
100 kHz	99.989 kHz		100.01 kHz
1 MHz	999.89 kHz		1.0001 MHz
180 MHz	149.98 MHz		150.02 MHz

Channel 2

Hz	Low limit	Test result	High limit
10 Hz	9.9989 Hz		10.001 Hz
100 Hz	99.989 Hz		100.01 Hz
1 kHz	999.89 Hz		1.0001 kHz
100 kHz	99.989 kHz		100.01 kHz
1 MHz	999.89 kHz		1.0001 MHz
180 MHz	149.98 MHz		150.02 MHz

Channel 3

Hz	Low limit	Test result	High limit
10 Hz	9.9989 Hz		10.001 Hz
100 Hz	99.989 Hz		100.01 Hz
1 kHz	999.89 Hz		1.0001 kHz
100 kHz	99.989 kHz		100.01 kHz
1 MHz	999.89 kHz		1.0001 MHz
180 MHz	149.98 MHz		150.02 MHz

Channel 4

Hz	Low limit	Test result	High limit
10 Hz	9.9989 Hz		10.001 Hz
100 Hz	99.989 Hz		100.01 Hz
1 kHz	999.89 Hz		1.0001 kHz
100 kHz	99.989 kHz		100.01 kHz
1 MHz	999.89 kHz		1.0001 MHz
180 MHz	149.98 MHz		150.02 MHz

Performance Verification Procedures

The Performance Verification Procedures consist of a self test and several check steps, which check the oscilloscope performance to specifications. The following three conditions must be met before performing these procedures:

1. The oscilloscope must have been operating continuously for twenty (20) minutes in an environment that meets the operating range specifications for temperature and humidity.
2. You must perform the Signal Path Compensation (SPC) operation described in step 2 of the *Self Test* before evaluating specifications. (See page 85, *Self Test*.) If the operating temperature changes by more than 10 °C (18 °F), you must perform the SPC operation again.
3. You must connect the oscilloscope and the test equipment to the same AC power circuit. Connect the oscilloscope and test instruments to a common power strip if you are unsure of the AC power circuit distribution. Connecting the oscilloscope and test instruments to separate AC power circuits can result in offset voltages between the equipment, which can invalidate the performance verification procedure.

The time required to complete the entire procedure is approximately ten hours. To ensure instrument performance to the Absolute Amplitude Accuracy specification, it is necessary to check at many points, which can add significant time to the procedure.



WARNING. *Some procedures use hazardous voltages. To prevent electrical shock, always set voltage source outputs to 0 V before making or changing any connections.*

Self Test This procedure uses internal routines to verify that the oscilloscope functions and passes its internal self tests. No test equipment or hookups are required.

1. *Run the System Diagnostics (may take several minutes):*
 - a. Disconnect everything from the oscilloscope inputs.
 - b. Push the front-panel **Default Setup** button.
 - c. Push the **Utility** menu button.
 - d. Push the **Utility Page** lower-bezel button.
 - e. Select **Self Test**.
 - f. Push the **Self Test** lower-bezel button. The Loop X Times side-bezel menu will be set to **Loop 1 Times**.
 - g. Push the **OK Run Self Test** side-bezel button.
 - h. Wait. The internal diagnostics perform an exhaustive verification of proper instrument function. This verification may take several minutes.
 - i. Verify that the status of all tests on the readout is **Pass**.
 - j. Push the **Menu** button twice to clear the dialog box and Self Test menu.
 - k. Cycle the power on the oscilloscope.
2. *Run the signal path compensation routine (may take 5 to 15 minutes):*
 - a. Push the front-panel **Default Setup** button.
 - b. Push the **Utility** menu button.
 - c. Push the **Utility Page** lower-bezel button.
 - d. Select **Calibration**.
 - e. Push the **Signal Path** lower-bezel button.
 - f. Push the **OK-Compensate Signal Paths** side bezel button.
 - g. When the signal path compensation is complete, push the **Menu** button twice to clear the dialog box and Self Test menu.
 - h. Check the lower-bezel **Signal Path** button to verify that the status is **Pass**.

Check Input Impedance (Resistance)

This test checks the Input Impedance.

1. Connect the output of the oscilloscope calibrator (for example, the Fluke 9500) to the oscilloscope channel 1 input, as shown below.

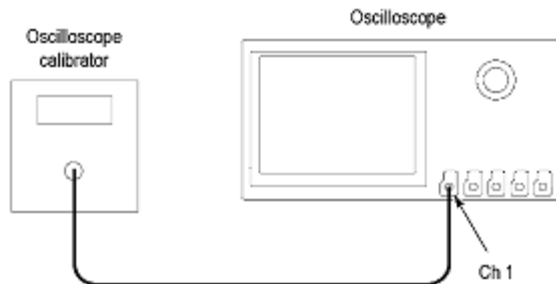

WARNING. The generator is capable of providing dangerous voltages. Be sure to set the generator to off or 0 volts before connecting, disconnecting, and/or moving the test hookup during the performance of this procedure.

2. Set the calibrator impedance to 1 M Ω .
3. Push the front-panel **Default Setup** button.
4. Set the oscilloscope impedance to 1 M Ω as follows:
 - a. Push the channel 1 button.
 - b. Set the **Termination** (input impedance) to **1 M Ω** .
5. Set the Vertical **Scale** to **10 mV/division**.
6. Measure the input resistance of the oscilloscope with the calibrator. Record this value in the test record.
7. Repeat steps 5 and 6 for each vertical scale setting in the test record.
8. Repeat the tests at 250 k Ω as follows:
 - a. Set the calibrator impedance to 1 M Ω .
 - b. Push the **Utility** front-panel button.
 - c. Push the **Utility Page** lower-bezel button.
 - d. Select **Self Test**.
 - e. Push the **250 k Ω Termination Verification** lower-bezel button to set the oscilloscope input impedance to **250 k Ω** .
 - f. Push the channel **1** side-bezel button to enable channel 1.

- g. Set the Vertical **Scale** to 100 **mV/division**.
 - h. Measure the input resistance of the oscilloscope with the calibrator. Record this value in the test record.
9. *Repeat the tests at 50 Ω as follows (this step does not need to be done for products with the AUX IN input):*
- a. Set the calibrator impedance to 50 Ω.
 - b. Set the oscilloscope impedance to 50 Ω as follows: Push the channel 1 button. Set the **Termination** (input impedance) to **50 Ω**.
 - c. Repeat steps 5 through 7.
10. *Repeat the procedure for all remaining channels as follows:*
- a. Push the front-panel channel button to deselect the channel that you already tested.
 - b. Connect the calibrator to the input for the next channel to be tested.
 - c. Starting from step 4, repeat the procedure for each channel and AUX IN input (models without the SA3 or SA6 option).

Check DC Balance

This test checks the DC balance. You do not need to connect any equipment (other than a 50 Ω terminator) to the oscilloscope to perform this check.

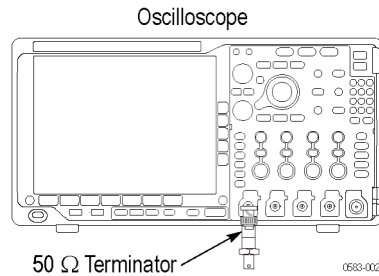

1. Attach a 50 Ω terminator to the oscilloscope channel 1 input.
2. Push the front-panel **Default Setup** button.
3. *Set the input impedance to 50 Ω as follows:*
 - a. Push the channel 1 button.
 - b. Set the **Termination** (input impedance) to **50 Ω** .
4. Set the bandwidth to 20 MHz:
 - a. Push the lower-bezel **Bandwidth** button.
 - b. Push the side-bezel button for **20 MHz**.
5. Set the Horizontal **Scale** to **1 ms** per division.
6. *Set the Acquisition mode to Average as follows:*
 - a. Push the front-panel **Acquire** button.
 - b. Push the **Average** side-bezel button.
 - c. Make sure that the number of averages is **16**.
7. *Set the trigger source to AC line as follows:*
 - a. Push the Trigger **Menu** front-panel button.
 - b. Select the **AC Line** trigger source.
8. Set the Vertical **Scale** to **1 mV** per division.
9. *Select the mean measurement (if not already selected) as follows:*
 - a. Push the front-panel Wave Inspector **Measure** button.
 - b. Push the **Add Measurement** lower-bezel button.
 - c. Select the **Mean** measurement.
 - d. Push the **OK Add Measurement** side-bezel button.
 - e. View the **Mean** measurement value in the display.

10. Enter the mean value as the test result in the test record.
11. Repeat steps 8 and 10 for each vertical scale setting in the test record.
12. Push the channel 1 button and then repeat steps 4, 8, and 10 for each bandwidth setting.

NOTE. *The MDO4024C does not have a 250 MHz BW limit setting.*

13. *Repeat the tests at 1 M Ω impedance as follows:*
 - a. Push the front-panel channel 1 button.
 - b. Set the **Termination** (input impedance) to **1M Ω** .
 - c. Repeat steps 4 through 12.
14. *Repeat the procedure for all remaining channels as follows:*
 - a. Deselect the channel that you already tested.
 - b. Move the 50 Ω terminator to the next channel input to be tested.
 - c. Starting from step 2, repeat the procedure for each channel.

Check DC Gain Accuracy This test checks the DC gain accuracy.

1. Connect the oscilloscope to a DC voltage source. If using the Fluke 9500 calibrator, connect the calibrator head to the oscilloscope channel to test.

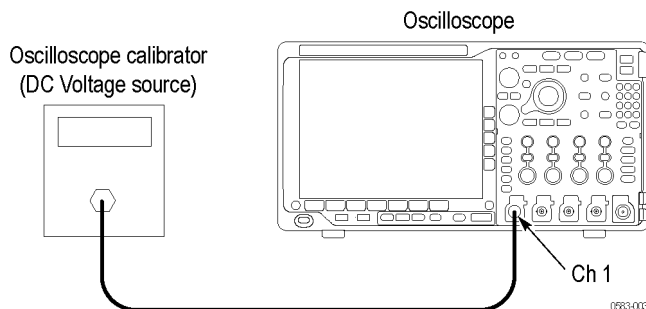

WARNING. The generator is capable of providing dangerous voltages. Be sure to set the generator to off or 0 volts before connecting, disconnecting, and/or moving the test hookup during the performance of this procedure.

2. Push the front-panel **Default Setup** button. The Termination (input impedance) is set to 1 M Ω and channel 1 input is selected.
3. Select 50 Ω input impedance as follows:
 - a. Set the calibrator to 50 Ω output impedance.
 - b. Push the channel 1 button.
 - c. Set the **Termination** (input impedance) to **50 Ω** .
4. Set the bandwidth to 20 MHz as follows:
 - a. Push the lower-bezel **Bandwidth** button.
 - b. Push the **20 MHz** side-bezel button to select the bandwidth.
5. Set the Acquisition mode to Average as follows:
 - a. Push the front-panel **Acquire** button.
 - b. Push the **Mode** lower-bezel button (if it is not already selected), and then push the **Average** side bezel button.
 - c. Make sure that the number of averages is **16**.
6. Select the Mean measurement as follows:
 - a. Push the front-panel Wave Inspector **Measure** button.
 - b. Push the **Add Measurement** lower-bezel button (if it is not already selected).

- c. Select the **Mean** measurement.
 - d. Push the **OK Add Measurement** side-bezel button.
7. *Set the trigger source to AC line as follows:*
 - a. Push the **Trigger Menu** button on the front panel.
 - b. Push the **Source** lower-bezel button.
 - c. Select the **AC Line** as the trigger source.
8. Set the **Vertical Scale** to **1 mV/division**.
9. *Record the negative-measured and positive-measured mean readings in the worksheet as follows:*
 - a. Set the DC Voltage Source to V_{negative} .
 - b. Push the front-panel Wave Inspector **Measure** button.
 - c. Push the **More** lower-bezel button.
 - d. Push **Reset Statistics** in the side-bezel menu.
 - e. Enter the mean reading in the worksheet as $V_{\text{negative-measured}}$. (See Table 18.)
 - f. Set the DC Voltage Source to V_{positive} .
 - g. Push **Reset Statistics** in the side-bezel menu again.
 - h. Enter the mean reading in the worksheet as $V_{\text{positive-measured}}$.

Table 18: Gain expected worksheet

Termination	Vertical Scale	$V_{diffExpected}$	$V_{negative}$	$V_{positive}$	$V_{negative-measured}$	$V_{positive-measured}$	V_{diff}	DC Gain Accuracy
50Ω	1 mV	9 mV	-4.5 mV	+4.5 mV				
	2 mV	18 mV	-9 mV	+9 mV				
	5 mV	45 mV	-22.5 mV	+22.5 mV				
	10 mV	90 mV	-45 mV	+45 mV				
	20 mV	180 mV	-90 mV	+90 mV				
	49.8 mV	448.2 mV	-224.1 mV	+224.1 mV				
	50 mV	450 mV	-225 mV	+225 mV				
	100 mV	900 mV	-450 mV	+450 mV				
	200 mV	1800 mV	-900 mV	+900 mV				
	500 mV	4900 mV	-2450 mV	+2450 mV				
	1 V	9000 mV	-4500 mV	+4500 mV				
1MΩ	1 mV	9 mV	-4.5 mV	+4.5 mV				
	2 mV	18 mV	-9 mV	+9 mV				
	5 mV	45 mV	-22.5 mV	+22.5 mV				
	10 mV	90 mV	-45 mV	+45 mV				
	20 mV	180 mV	-90 mV	+90 mV				
	50 mV	450 mV	-225 mV	+225 mV				
	63.5 mV	571.5 mV	-285.75 mV	+285.75 mV				
	100 mV	900 mV	-450 mV	+450 mV				
	200 mV	1800 mV	-900 mV	+900 mV				
	500 mV	4900 mV	-2450 mV	+2450 mV				
	1 V	9000 mV	-4500 mV	+4500 mV				
	5 V	45 V	-22.5 V	+22.5 V				

10. Record Gain Accuracy:

- a.** Calculate V_{diff} as follows:

$$V_{diff} = | V_{negative-measured} - V_{positive-measured} |$$

- b.** Enter V_{diff} in the worksheet. (See Table 18.)

- c.** Calculate *Gain Accuracy* as follows:

$$Gain\ Accuracy = ((V_{diff} - V_{diffExpected}) / V_{diffExpected}) * 100\%$$

- d.** Enter *Gain Accuracy* in the worksheet and in the test record.

11. Repeat steps 8 through 10 for each vertical scale setting in the test record.

12. Repeat steps 8 through 11 for each bandwidth setting in the test record.

13. *Repeat the procedure for all remaining channels as follows:*
 - a. Push the front-panel button to deselect the channel that you have already tested.
 - b. Move the DC voltage source connection to the next channel input to be tested.
 - c. Starting from step 8, repeat the procedure for each channel.
14. Repeat tests at 1 M Ω impedance:
 - a. Set the calibrator to 1 M Ω output.
 - b. Push the front-panel channel 1 button.
 - c. Set the **Termination** to **1 M Ω** .
 - d. Repeat steps 8 through 13.

Check DC Offset Accuracy

This test checks the DC offset accuracy.

1. Connect the oscilloscope to a DC voltage source. If you are using the Fluke 9500 calibrator as the DC voltage source, connect the calibrator head to the oscilloscope channel 1.

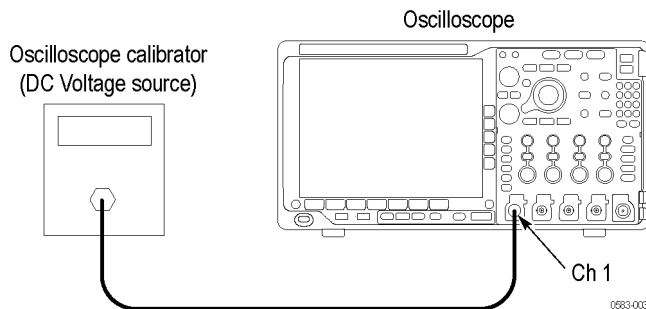

WARNING. *The generator is capable of providing dangerous voltages. Be sure to set the generator to off or 0 volts before connecting, disconnecting, and/or moving the test hookup during the performance of this procedure.*

2. Push the front-panel **Default Setup** button.
3. *Set the Acquisition mode to Average as follows:*
 - a. Push the front-panel **Acquire** button.
 - b. Push the **Mode** lower-bezel button (if not already selected).
 - c. Push the **Average** side-bezel button.
 - d. Make sure that the **number of averages** is set to **16**.
4. Set the trigger source to AC line:
 - a. Push the Trigger **Menu** front-panel button.
 - b. Push the **Source** lower-bezel button.
 - c. Select **AC Line** as the trigger source.
5. Set the Horizontal **Scale** to **1.00 ms** per division.
6. *Set the Bandwidth to 20 MHz as follows:*
 - a. Push the channel 1 button.
 - b. Push the lower-bezel **Bandwidth** button.
 - c. Push the side-bezel button to set the bandwidth to **20 MHz**.

7. Check that the vertical position is set to 0 divs:
 - a. Push the lower-bezel **More** button to select **Position**.
 - b. In the side-bezel button, check that the **Vertical Position** is set to **0 divs**.
 - c. If it is not 0 divs, turn the Vertical **Position** knob to set the position to 0.
8. *Select 50 Ω impedance as follows:*
 - a. Set the calibrator to 50 Ω output impedance (50 Ω source impedance).
 - b. Push the channel 1 button.
 - c. Set the **Termination** to **50 Ω** .
9. Set the vertical **Scale** to **1 mV** per division.
10. *Set the offset as follows:*
 - a. Set the calibrator to 900 mV vertical offset.
 - b. Push the lower-bezel **More** button to select **Offset**.
 - c. Set the **Vertical Offset** to **900 mV**, as shown in the test record.
11. *Select the Mean measurement (if not already selected) as follows:*
 - a. Push the front-panel Wave Inspector **Measure** button.
 - b. Push the **Add Measurement** lower-bezel button.
 - c. Select the **Mean** measurement.
 - d. Push the **OK Add Measurement** side-bezel button.
12. View the mean value in the measurement pane at the bottom of the display and enter it as the test result in the test record.
13. Repeat step 12 for each vertical scale and offset setting combination shown in the test record.
14. *Repeat the tests at 1 M Ω impedance as follows:*
 - a. Change the calibrator impedance to 1 M Ω .
 - b. Push the front-panel channel 1 button.
 - c. Set the **Termination** (input impedance) to **1 M Ω** .
 - d. Repeat steps 9 through 13.
15. *Repeat the procedure for all remaining channels as follows:*
 - a. Deselect the channel that you have already tested.
 - b. Move the DC voltage source connection to the next channel to be tested.
 - c. Starting from step 6, repeat the procedure for each channel.

Check Analog Bandwidth

This test checks the bandwidth at 50 Ω and 1 M Ω for each channel.

1. Connect the output of the leveled sine wave generator (for example, Fluke 9500) to the oscilloscope channel 1 input as shown in the following illustration.

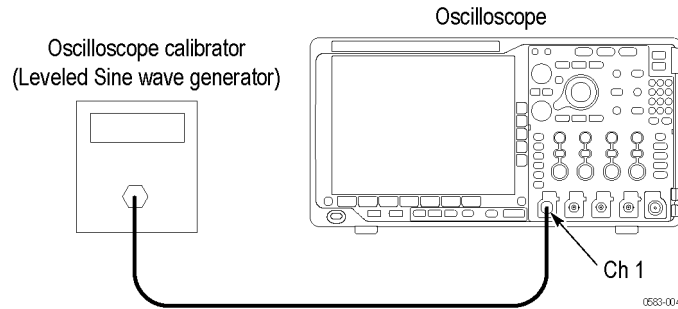

WARNING. *The generator is capable of providing dangerous voltages. Be sure to set the generator to off or 0 volts before connecting, disconnecting, and/or moving the test hookup during the performance of this procedure.*

2. Push the front-panel **Default Setup** button.
3. *Select 50 Ω impedance as follows:*
 - a. Set the calibrator to 50 Ω output impedance and to generate a sine wave.
 - b. Push the front-panel channel 1 button.
 - c. Set the **Termination** (input impedance) to **50 Ω** .
4. *Set the Acquisition mode to Sample as follows:*
 - a. Push the front-panel **Acquire** button.
 - b. Push the **Mode** lower-bezel button (if not already selected).
 - c. Push the **Sample** side-bezel button.
5. Set the Vertical **Scale** to **1 mV** per division.
6. For vertical scales less than 500 mV/div, adjust the signal source to at least 8 vertical divisions at the selected vertical scale with a set frequency of 50 kHz. For example, at 5 mV/div, use a ≥ 40 mV_{p-p} signal, at 2 mV/div, use a ≥ 16 mV_{p-p} signal, and at 1 mV/div, use a ≥ 8 mV_{p-p} signal. For vertical scales of 500 mV/div and 1 V/div adjust the signal source to 3 V_{p-p}. Use a sine wave for the signal source.
7. Set the Horizontal **Scale** to **10 μ s** per division.

8. Record the peak-to-peak measurement:
 - a. Push the front-panel Wave Inspector **Measure** button.
 - b. Select the **Peak-to-Peak** measurement.
 - c. Push the **OK Add Measurement** side-bezel button.
 - d. This will provide a mean V_{p-p} of the signal. Call this value V_{in-pp} .
 - e. Enter this value in the test record.
9. Set the Horizontal **Scale** to **4 ns** per division.
10. Adjust the signal source to the maximum bandwidth frequency for the bandwidth and model desired, as shown in the following worksheet.
11. Record the peak-to-peak measurement as follows:
 - a. View the mean V_{p-p} of the signal. Call this value V_{bw-pp} .
 - b. Enter this value in the test record.

NOTE. For more information on the contents of this worksheet, refer to the bandwidth specifications. (See Table 1 on page 1.)

Table 19: Maximum bandwidth frequency worksheet

Impedance	Vertical Scale	Maximum bandwidth
Model: MDO4104C		
50 Ω	5 mV/div – 1 V/div	DC to 1 GHz
	2 mV/div – 4.98 mV/div	DC to 350 MHz
	1 mV/div – 1.99 mV/div	DC to 175 MHz
1 M Ω (typical)	5 mV/div – 1 V/div	DC to 500 MHz
	2 mV/div – 4.98 mV/div	DC to 350 MHz
	1 mV/div – 1.99 mV/div	DC to 175 MHz
Model: MDO4054C		
50 Ω	5 mV/div – 1 V/div	DC to 500 MHz
	2 mV/div – 4.98 mV/div	DC to 350 MHz
	1 mV/div – 1.99 mV/div	DC to 175 MHz
1 M Ω with option SA3 or SA6 (typical)	5 mV/div – 10 V/div	DC to 380 MHz
	2 mV/div – 4.98 mV/div	DC to 350 MHz
	1 mV/div – 1.99 mV/div	DC to 175 MHz

Table 19: Maximum bandwidth frequency worksheet (cont.)

Impedance	Vertical Scale	Maximum bandwidth
Model: MDO4034C		
50 Ω	5 mV/div – 1 V/div	DC – 350 MHz
	1 mV/div – 1.99 mV/div	DC – 175 MHz
1 M Ω with option SA3 or SA6 (typical)	2 mV/div – 10V/div	DC to 350 MHz
	1 mV/div – 1.99 mV/div	DC to 175 MHz
Model: MDO4024C		
50 Ω	2 mV/div – 1 V/div	DC – 200 MHz
	1 mV/div – 1.99 mV/div	DC – 175 MHz
1 M Ω with option SA3 or SA6 (typical)	2 mV/div – 1 V/div	DC to 200 MHz
	1 mV/div – 1.99 mV/div	DC to 175 MHz

¹ For MDO4104C performance verification, use 500 MHz, rather than 1 GHz, on the 5 mV/div vertical scale.

12. Use the values of V_{bw-pp} and V_{in-pp} that you entered in the test record to calculate the *Gain* at bandwidth with the following equation:

$$Gain = V_{bw-pp} / V_{in-pp}$$

To pass the performance measurement test, Gain should be ≥ 0.707 . Enter *Gain* in the test record.

13. Repeat steps 5 through 12 for all combinations of Vertical Scale and Horizontal Scale settings listed in the test record.
14. For MDO40X4C with option SA3 or SA6, and for MDO4104C, repeat the tests at 1 M Ω impedance as follows:
- Change the calibrator impedance to 1 M Ω .
 - Push the front-panel channel 1 button.
 - Set the **Termination** (input impedance) to **1 M Ω** .
 - Repeat steps 5 through 13.
15. Repeat the procedure for all remaining channels as follows:
- Push the front-panel button to deselect the channel that you have already tested.
 - Move the calibrator connection to the next channel input to be tested.
 - Starting from step 3, repeat the procedure for each input channel.

**Check Random Noise,
Sample Acquisition Mode**

This test checks random noise. You do not need to connect any test equipment to the oscilloscope for this test.

1. Disconnect everything from the oscilloscope inputs.
2. Push the front-panel **Default Setup** button.
3. *Set Gating to Off as follows:*
 - a. Push the front-panel Wave Inspector **Measure** button.
 - b. Push the bottom-bezel **More** button to select **Gating**.
 - c. Push the side-bezel **Off (Full Record)** button.
4. *Select the RMS measurement as follows:*
 - a. Push the bottom-bezel **Add Measurement** button.
 - b. Select the **RMS** measurement.
 - c. Push the side-bezel **OK Add Measurement** button.
5. *Reset statistics as follows:*
 - a. Push the bottom-bezel **More** button to select **Statistics**.
 - b. Push the side-bezel **Reset Statistics** button.
6. Read and make a note of the RMS Mean value. This is the Sampled Mean Value (SMV).
7. *Set the Acquisition mode to Average as follows:*
 - a. Push the front-panel **Acquire** button.
 - b. Push the bottom-bezel **Mode** button to display the Acquisition Mode menu (if it is not already selected).
 - c. Push the side-bezel **Average** button.
 - d. Make sure that the **number of averages** is set to **16**.
8. *Reset statistics as follows:*
 - a. Push the front-panel Wave Inspector **Measure** button.
 - b. Push the bottom-bezel **More** button to select **Statistics** (if it is not already selected).
 - c. Push the side-bezel **Reset Statistics** button.
9. Read and make a note of the RMS Mean value. This is the Averaged Mean Value (AMV).
10. Calculate the RMS noise ($\text{RMS noise} = \text{SMV} - \text{AMV}$), and enter the calculated RMS noise in the test record.

11. *Set the Acquisition mode to Sample as follows:*
 - a. Push the front-panel **Acquire** button.
 - b. Push the **Mode** lower-bezel button (if it is not already selected).
 - c. Push the **Sample** side-bezel button.
12. *Repeat the tests at 50 Ω as follows:*
 - a. Push the front-panel channel **1** button.
 - b. Set the **Termination** (input impedance) to **50 Ω** .
 - c. Push the front-panel Wave Inspector **Measure** button, and repeat steps 5 through 11.
13. *Repeat the tests at 250 MHz bandwidth as follows:*
 - a. Push the front-panel channel **1** button.
 - b. Set the **Termination** (input impedance) to **1 M Ω** .
 - c. Push the bottom-bezel **Bandwidth** button.
 - d. Push the side-bezel **250 MHz** button.
 - e. Push the front-panel Wave Inspector **Measure** button.
 - f. Repeat steps 5 through 12.
14. *Repeat the tests at 20 MHz bandwidth as follows:*
 - a. Push the front-panel channel 1 button.
 - b. Set the **Termination** (input impedance) to **1 M Ω** .
 - c. Push the bottom-bezel **Bandwidth** button.
 - d. Push the side-bezel **20 MHz** button.
 - e. Push the front-panel Wave Inspector **Measure** button.
 - f. Repeat steps 5 through 12.
15. *Repeat the procedure for all remaining channels as follows:*
 - a. Push the front-panel button to deselect the channel that you have already tested.
 - b. Starting from step 3, repeat the procedure for each input channel.

Check Reference Frequency Error (Cumulative)

This test checks the reference frequency error (time base).

1. Connect the output of a time mark generator to the oscilloscope channel 1 input using a 50 Ω cable, as shown in the following illustration.

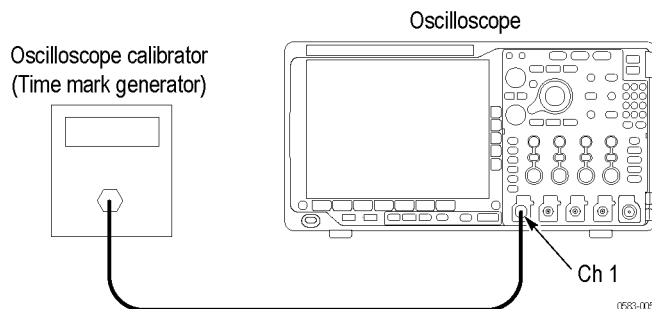

WARNING. The generator is capable of providing dangerous voltages. Be sure to set the generator to off or 0 volts before connecting, disconnecting, and/or moving the test hookup during the performance of this procedure.

2. Set the time mark generator period to **400 ms**. Use a time mark waveform with a fast rising edge.
3. Push the front-panel **Default Setup** button.
4. Set the impedance to 50 Ω as follows:
 - a. Push the front-panel channel 1 button.
 - b. Set the **Termination** to **50 Ω** .
5. If it is adjustable, set the time mark amplitude to approximately **2 V_{p-p}**.
6. Set the Vertical **Scale** to **500 mV** per division.
7. Set the Horizontal **Scale** to **20 ms** per division.
8. Adjust the Vertical **Position** knob to center the time mark signal on the screen.
9. Set the trigger **Mode** to **Normal**. Do this by pushing **Trigger** on the front panel, pushing **Mode, Auto, & Holdoff** on the bottom menu, and selecting **Normal** from the side menu.
10. Adjust the Trigger **Level** as necessary for a triggered display.
11. Set the delay to 400 ms as follows:
 - a. Push the front-panel **Acquire** button.
 - b. Push the lower-bezel **Delay** button to turn delay on (if it is not already on).
 - c. Turn the Horizontal **Position** knob counter-clockwise to set the delay to exactly **400 ms**.

12. Set the Horizontal **Scale** to **200 ns/div**.
13. Compare the rising edge of the marker with the center horizontal graticule line. For models with option SA3 or SA6, the rising edge should be within ± 640 ns of center graticule. For models without option SA3 or SA6, the rising edge should be within ± 2 μ s of center graticule. Enter the deviation in the test record.

NOTE. *640 ns from graticule center corresponds to a $\pm 1.6 \times 10^{-6}$ time base error. 1 μ s from the graticule center corresponds to a $\pm 5.0 \times 10^{-6}$ time base error.*

Check Delta Time Measurement Accuracy

This test checks the Delta-time measurement accuracy (DTA) for a given instrument setting and input signal.

Connect a 50 Ω coaxial cable from the signal source to the oscilloscope channel 1, as shown in the following illustration.

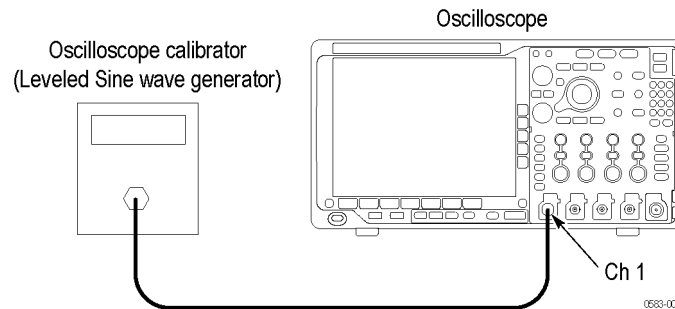

WARNING. *The generator is capable of providing dangerous voltages. Be sure to set the generator to off or 0 volts before connecting, disconnecting, and/or moving the test hookup during the performance of this procedure.*

2. Push the oscilloscope front-panel **Default Setup** button.
3. Select 50 Ω impedance as follows:
 - a. Set the sine wave generator output impedance to 50 Ω .
 - b. Push the channel 1 button to display the channel 1 menu.
 - c. Set the **Termination** (input impedance) to **50 Ω** .
4. Set the trigger source to channel 1 as follows:
 - a. Push the **Trigger Menu** button.
 - b. Push the **Source** lower-bezel button (if not already selected).
 - c. Select channel 1 (if not already selected).
5. Set the Mean & St Dev Samples to 100 as follows:
 - a. Push the Wave Inspector **Measure** button.
 - b. Push the bottom-bezel **Add Measurement** button.
 - c. Select the **Delay** measurement.
 - d. Push the side-bezel **Configure Delay** button.
 - e. Select the falling **Delay Edge**.
 - f. Set the **Delay Edge Occurrence** to **Last**.
 - g. Push the side-bezel **OK Add Measurement** button.

- h. Push the bottom-bezel **More** button to select **Statistics**.
 - i. Set the **Mean & Std Dev Samples** to **100**, as shown in the side menu.
6. Set the signal source to 240 MHz and 40 mV as shown in the test record.

NOTE. *To provide consistent results, set the signal source frequency such that the zero crossing does not occur at the beginning or end of the record.*

7. Set the Horizontal **Scale** to **4 ns** per division.
8. Set the Vertical **Scale** to **5 mV** per division.
9. *Record the Std Dev value as follows:*
- a. Push the side-bezel **Reset Statistics** button.
 - b. Push the **Menu** button to remove the side-bezel menu.
 - c. Wait five or 10 seconds for the oscilloscope to acquire all of the samples.
 - d. Verify that the **Std Dev** is less than the upper limit shown in the test record.
 - e. Enter the reading in the test record.
10. Repeat steps 6 through 9 for each setting combination shown in the test record.
11. *Repeat the procedure for all remaining channels as follows:*
- a. Push the front-panel button to deselect the channel that you have already tested.
 - b. Connect the signal source to the input for the next channel to be tested.
 - c. Repeat the procedure from step 3 until all channels have been tested.

Check Digital Threshold Accuracy

This test checks the threshold accuracy of the digital channels. This procedure applies to digital channels D0 through D15, and to threshold values of 0 V and +4 V.

1. Connect the P6616 digital probe to the oscilloscope, as shown in the following illustration:
 - a. Connect the DC voltage source to the digital channel D0.
 - b. If you are using the Fluke 9500 calibrator as the DC voltage source, connect the calibrator head to the digital channel D0, using the BNC-to-0.1 inch pin adapter listed in the Required Equipment table. (See Table 17 on page 34.)

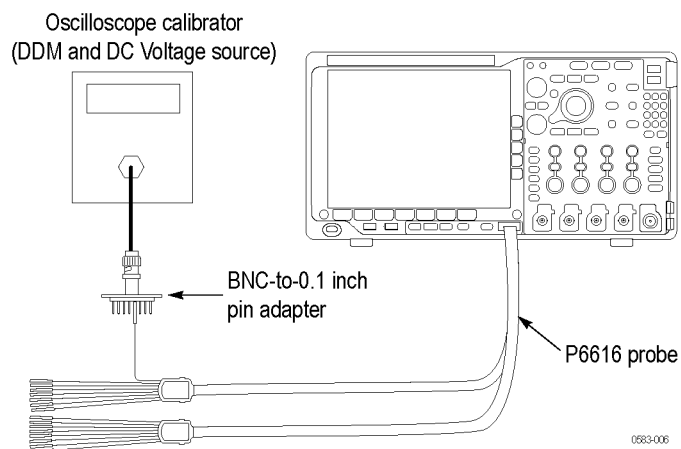

WARNING. The generator is capable of providing dangerous voltages. Be sure to set the generator to off or 0 volts before connecting, disconnecting, and/or moving the test hookup during the performance of this procedure.

2. Turn on the digital channels as follows:
 - a. Push the front-panel **D15-D0** button.
 - b. Push the **D15-D0 On/Off** lower-bezel button.
 - c. Push the **Turn On D7 - D0** and the **Turn On D15 - D8** side-bezel buttons to turn these channels On.
 - d. Make sure that the side-bezel **Display** selection is **On**.
 - e. The instrument will display the 16 digital channels.

3. *Set the channel threshold to 0 V as follows:*
 - a. Push the **Thresholds** lower-bezel button (if not already selected).
 - b. Select channel **D0**.
 - c. Set the value to **0.00 V** (0 V/div), using the coarse and fine settings of the knob as necessary to set the exact value.
4. Push the **Menu** button and then set the Horizontal **Scale** to **4 μ s** per division.
5. *Set the Trigger source as follows:*
 - a. Push the front-panel Trigger **Menu** button.
 - b. Push the **Source** lower-bezel button (if not already selected).
 - c. Select channel D0.
6. Set the trigger **Mode** to **Normal**. Do this by pushing **Trigger** on the front panel, pushing **Mode, Auto, & Holdoff** on the bottom menu, and selecting **Normal** from the side menu.
7. Set the DC voltage source (V_s) to -400 mV. Wait 3 seconds. Check the logic level of the channel D0 signal display. If it is at a static logic high, change the DC voltage source V_s to -500 mV.
8. Increment V_s by $+10$ mV. Wait 3 seconds and check the logic level of the channel D0 signal display. If it is a static logic high, record the V_s value as in the 0 V row of the test record.

If the signal level is a logic low or is alternating between high and low, repeat this step (increment V_s by 10 mV, wait 3 seconds, and check for a static logic high) until a value for V_{s+} is found.
9. Click the lower-bezel **Slope** button to change the slope to **Falling**.
10. Set the DC voltage source (V_s) to $+400$ mV. Wait 3 seconds. Check the logic level of the channel D0 signal display.

If it is at a static logic low, change the DC voltage source V_s to $+500$ mV.
11. Reduce V_s by -10 mV. Wait 3 seconds and check the logic level of the channel D0 signal display. If it is a static logic low, record the V_s value as V_{s+} in the 0 V row of the test record.

If the signal level is a logic high or is alternating between high and low, repeat this step (decrement V_s by 10 mV, wait 3 seconds, and check for a static logic low) until a value for V_{s+} is found.
12. Find the average using this formula: $V_{sAvg} = (V_{s-} + V_{s+})/2$. Record the average as the test result in the test record.

Compare the test result to the limits. If the result is between the limits, continue with the procedure to test the channel at the $+4$ V threshold value.

13. Set the channel threshold to +4 V as follows:
 - a. Push the front-panel **D15-D0** button.
 - b. Push the **Thresholds** lower-bezel button.
 - c. Select channel **D0**.
 - d. Push the **Fine** front-panel button to turn off the fine adjustment.
 - e. Set the value near **4.00 V** (4 V/div).
 - f. Push the **Fine** button to turn the fine adjustment on again.
 - g. Set the value to exactly **4.00 V** (4 V/div).
14. Set the DC voltage source (Vs) to +4.4 V. Wait 3 seconds. Check the logic level of the channel D0 signal display.
15. Decrement Vs by –10 mV. Wait 3 seconds and check the logic level of the channel D0 signal display. If it is a static logic low, record the Vs value as V_{s+} in the 4 V row of the test record.

If the signal level is a logic high or is alternating between high and low, repeat this step (decrement Vs by 10 mV, wait 3 seconds, and check for a static logic low) until a value for V_{s+} is found.
16. Push the front-panel **Trigger Menu** button.
17. Click the lower-bezel **Slope** button to change the slope to **Rising**.
18. Set the DC voltage source (Vs) to +3.6 V. Wait 3 seconds. Check the logic level of the channel D0 signal display.

If the signal level is a static logic high, change the DC voltage source Vs to +3.5 V.
19. Increment Vs by +10 mV. Wait 3 seconds and check the logic level of the channel D0 signal display. If it is a static logic high, record the Vs value as V_{s-} in the 4 V row of the test record.

If the signal level is a logic low or is alternating between high and low, repeat this step (increment Vs by 10 mV, wait 3 seconds, and check for a static logic high) until a value for V_{s-} is found.
20. Find the average using this formula: $V_{sAvg} = (V_{s-} + V_{s+})/2$. Record the average as the test result in the test record.

Compare the test result to the limits. If the result is between the limits, the channel passes the test.

21. *Repeat the procedure for all remaining digital channels as follows:*

- a.** Push the D15–D0 button.
- b.** Move the DC voltage source connection, including the ground lead, to the next digital channel to be tested.
- c.** Starting from step 3, repeat the procedure until all 16 digital channels have been tested.

Check Phase Noise This step checks the phase noise measured at 10 kHz, 100 kHz, and 1 MHz offsets from a 1 GHz CW signal. This check is only for instruments with option SA3 or SA6.



WARNING. *The generator is capable of providing dangerous voltages. Be sure to set the generator to off or 0 volts before connecting, disconnecting, and/or moving the test hookup during the performance of this procedure.*

NOTE. *Do not use an N connector with the Anritsu generator. Equipment damage will result if an N connector is used.*

1. Connect the output of a signal generator, such as the Anritsu generator, to the oscilloscope RF Input, using a 50 Ω SMA coaxial cable (see the following figure).

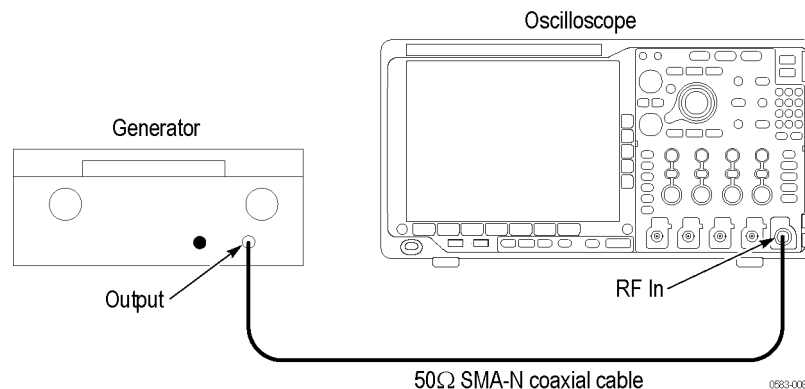

2. Set the generator for a 1 GHz, 0 dBm signal.
3. *Initial oscilloscope setup:*
 - a. Push the front-panel **Default Setup** button.
 - b. Turn Channel 1 off.
 - c. Push the front-panel **RF** button to turn on the RF channel and display the bottom-bezel RF menu.
 - d. *Turn on the average trace as follows:*
 - Push the bottom-bezel **Spectrum Traces** button.
 - Push the side-bezel **Average** button to set the **Average Trace** to **On**.
 - Push the side-bezel **Normal** button twice to set the Normal Trace to **Off**.

- e. *Turn on average detection as follows:*
 - Push the bottom-bezel **Detection Method** button.
 - Push the side-bezel button to set the detection method to **Manual**.
 - Push the side-bezel **Average Trace** button.
 - Set the detection method to **Average**.
 - f. *Set the center frequency to 1 GHz as follows:*
 - Push the front-panel **Freq/Span** button.
 - Push the side-bezel **Center Frequency** button.
 - Set the center frequency to **1 GHz**.
 - g. *Set the Span to 50.0 kHz.*
 - h. Center the signal on the display. To do this:
 - Push the **Markers** front-panel button.
 - Push the **R To Center** side-bezel button.
 - i. *Set the resolution bandwidth (RBW) to 250 Hz as follows:*
 - Push the front-panel **BW** button.
 - Push the side-bezel **RBW Mode** button to set the RBW mode to Manual.
 - Set the resolution bandwidth to 250 Hz.
 - j. *Set the markers to delta as follows:*
 - Push the front-panel **Markers** button.
 - Push the side-bezel **Manual Markers** button to set the manual markers to On.
 - Push the side-bezel **Readout** button to select **Delta**.
4. *Check at 10 kHz:*
- a. Push the front-panel **Markers** button.
 - b. Set marker a to the signal peak.
 - c. Set marker b to 10 kHz offset, as shown in the following figure.

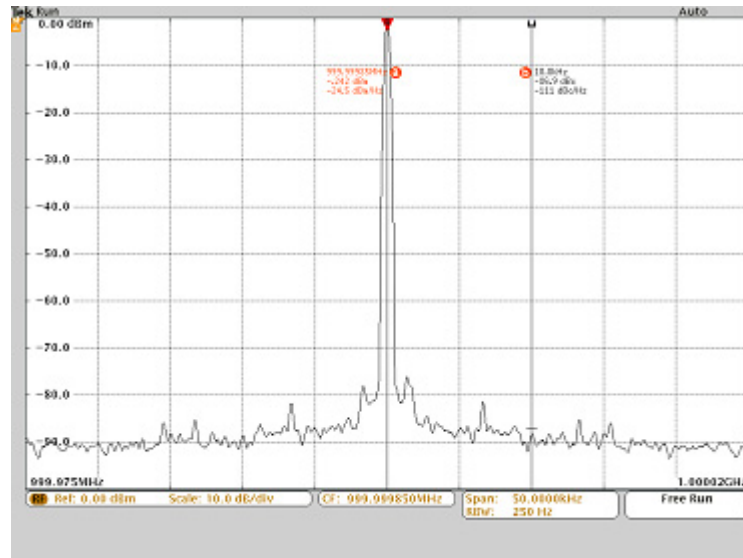

- d. Note the bottom value in the marker b readout (in dBc/Hz) and enter it in the test record. Make sure that the instrument meets the specification given in the test record.
5. *Repeat the check at 100 kHz:*
 - a. Change the span to 500 kHz.
 - b. Change the resolution bandwidth (RBW) to 1 kHz.
 - c. Set marker a to the signal peak.
 - d. Set marker b to 100 kHz offset.
 - e. Note the bottom value in the marker b readout (in dBc/Hz) and enter it in the test record. Make sure that the instrument meets the specification given in the test record.
 6. *Repeat the check at 1 MHz:*
 - a. Change the span to 5 MHz.
 - b. Change the resolution bandwidth (RBW) to 50 kHz.
 - c. Set marker a to the signal peak.
 - d. Set marker b to 1 MHz offset.
 - e. Note the bottom value in the marker b readout (in dBc/Hz) and enter it in the test record. Make sure that the instrument meets the specification given in the test record.

**Check Displayed Average
Noise Level (DANL)**

This test does not require an input signal.

The test measures the average internal noise level of the instrument, ignoring residual spurs. This check is for instruments with option SA3 or SA6.

It checks six ranges:

- 9 kHz to 50 kHz (all models)
- 50 kHz to 5 MHz (all models)
- 5 MHz to 400 MHz (all models)
- 400 MHz to 3 GHz (all models)
- 3 GHz to 4 GHz (option SA6 only)
- 4 GHz to 6 GHz (option SA6 only)

NOTE. *If the specific measurement frequency results in measuring a residual spur that is visible above the noise level, the DANL specification applies not to the spur but to the noise level on either side of the spur. Please refer to the Spurious Response specifications. (See page 21.)*

1. *Initial oscilloscope setup:*
 - a. Terminate the RF input in $50\ \Omega$ and make sure that no input signal is applied.
 - b. Push the front-panel **Default Setup** button.
 - c. Turn channel 1 off.
 - d. Push the front-panel **RF** button to turn on the RF channel and display the bottom-bezel RF menu.
 - e. *Turn on the average trace as follows:*
 - Push the bottom-bezel **Spectrum Traces** button.
 - Push the side-bezel **Average** button to set average trace to **On**.
 - Set the side-bezel **Normal** button to **Off**.
 - f. *Turn on average detection as follows:*
 - Push the bottom-bezel **Detection Method** button.
 - Push the side-bezel button to set the detection method to **Manual**.
 - Push the side-bezel **Average Trace** button.
 - Set the detection method to **Average**.
 - g. *Set the reference level to $-25.0\ \text{dBm}$ as follows:*
 - Push the front-panel **Ampl** button.
 - Push the side-bezel **Ref Level** button.
 - Set the Ref Level to $-25.0\ \text{dBm}$.
2. *Check from 9 kHz to 50 kHz (option SA3 or SA6):*
 - a. Set the start and stop frequencies as follows:
 - Push the front-panel **Freq/Span** button.
 - Push the side-bezel **Stop** button.
 - Set the stop frequency to 50 kHz.
 - Push the side-bezel **Start** button.

- Set the start frequency to 9 kHz.
 - Wait 60 seconds. Due to the low RBW for this span, it takes a little while for the instrument to compute a valid average.
- b.** Set Manual Marker (a) at the frequency with the highest noise level as follows:
- Push the **Markers** front-panel button.
 - Push the **Manual Markers** side-bezel button to turn on the markers.
 - Turn Multipurpose knob **a** to move the marker to the frequency at the noise threshold (highest point of noise), ignoring any spurs. See the following figure.

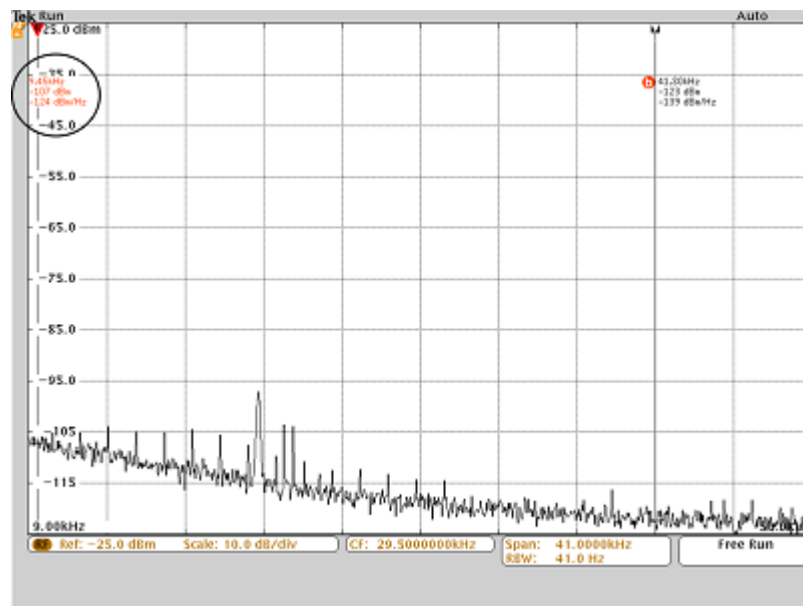

- c.** Record the noise threshold value (in dBm/Hz) in the test record and make sure that the instrument meets the specification.
- 3.** Check from 50 kHz to 5 MHz (option SA3 or SA6):
- a.** Set the start and stop frequency as follows:
- Push the front-panel **Freq/Span** button.
 - Push the side-bezel **Stop** button.
 - Set the stop frequency to 5 MHz.

- Push the side-bezel **Start** button.
 - Set the start frequency to 50 kHz.
- b. Set Manual Marker (a) at the frequency with the highest noise level as follows:
- Push the **Markers** front-panel button.
 - Push the **Manual Markers** side-bezel button to turn on the markers.
 - Turn Multipurpose knob **a** to move the marker to the frequency at the noise threshold (highest point of noise), ignoring any spurs. See the following figure.

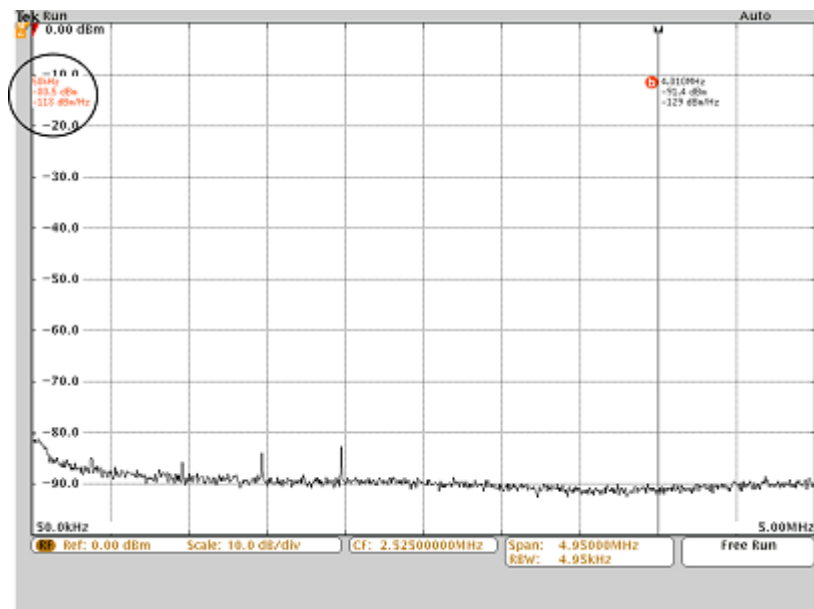

- c. Record the noise threshold value (in dBm/Hz) in the test record and compare it to the instrument specification.
4. Check from 5 MHz to 400 MHz (option SA3 or SA6):
- a. Set the stop frequency to 400 MHz.
 - b. Set the start frequency to 5 MHz.
 - c. Set Manual Marker (a) at the frequency of the highest noise, ignoring any spurs.
 - d. Set the center frequency as follows: Push the **R To Center** side-bezel button.

- e. *Set the span to 10 MHz as follows:*
 - Push the side-bezel **Span** button.
 - Set the Span to 10 MHz.
 - f. Record the highest noise value (in dBm/Hz) in the test record and compare it to the instrument specification.
5. *Check from 400 MHz to 3 GHz (option SA3 or SA6):*
 - a. Set the stop frequency to 3 GHz.
 - b. Set the start frequency to 400 MHz.
 - c. Set Manual Marker (a) at the frequency of the highest noise, ignoring any spurs.
 - d. *Set the center frequency as follows:* Push the **R To Center** side-bezel button.
 - e. *Set the span to 10 MHz as follows:*
 - Push the side-bezel **Span** button.
 - Set the Span to 10 MHz.
 - f. Record the highest noise value (in dBm/Hz) in the test record and compare it to the instrument specification.
6. *Check from 3 GHz to 4 GHz (option SA6 only):*
 - a. Set the stop frequency to 4 GHz.
 - b. Set the start frequency to 3 GHz.
 - c. Set Manual Marker (a) at the frequency of the highest noise, ignoring any spurs.
 - d. *Set the center frequency as follows:* Push the **R To Center** side-bezel button.
 - e. *Set the span to 10 MHz as follows:*
 - Push the side-bezel **Span** button.
 - Set the Span to 10 MHz.
 - f. Record the highest noise value (in dBm/Hz) in the test record and compare it to the instrument specification.
7. *Check from 4 GHz to 6 GHz (option SA6 only):*
 - a. Set the stop frequency to 6 GHz.
 - b. Set the start frequency to 4 GHz.
 - c. Set Manual Marker (a) at the frequency of the highest noise, ignoring any spurs.

- d. *Set the center frequency as follows:* Push the **R To Center** side-bezel button.
- e. *Set the span to 10 MHz as follows:*
 - Push the side-bezel **Span** button.
 - Set the Span to 10 MHz.
- f. Record the highest noise value (in dBm/Hz) in the test record and compare it to the instrument specification.

Check Absolute Amplitude Accuracy

This test checks the absolute amplitude accuracy at three reference levels: +10 dBm, 0 dBm, and -15 dBm. This check uses the generator to step frequencies across four spans to verify that the instrument meets the specification. This check is for instruments with option SA3 or SA6.

For this check, you will need the following equipment, which is described in the Required Equipment table. (See Table 17 on page 34.)

- Generator, such as the Anritsu generator
- Power meter
- Power head
- Power splitter
- Adapters and cables as shown in the following figure.



WARNING. The generator is capable of providing dangerous voltages. Be sure to set the generator to off or 0 volts before connecting, disconnecting, and/or moving the test hookup during the performance of this procedure.

NOTE. Use an SMA connector with the Anritsu generator. Equipment damage will result if an N connector is used.

1. Connect the equipment as shown in the following figure.

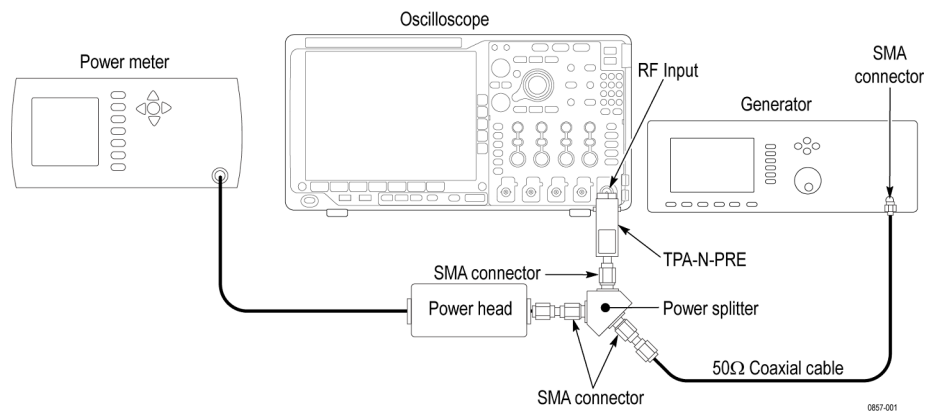

2. Initial oscilloscope setup:

- a. Push the front-panel **Default Setup** button.
- b. Turn Channel 1 off.
- c. Push the front-panel **RF** button to turn on the RF channel.

3. *Check at +10 dBm:*
 - a. Set the reference level to +10 dBm as follows: Push the front-panel **Ampl** button. Push the side-bezel **Ref Level** button. Set the Ref Level to +10 dBm.
 - b. *Set the frequency range as follows:*
 - Push the front-panel **Freq/Span** button.
 - Push the side-bezel **Center Frequency** button.
 - Set the center frequency to 50 kHz.
 - Push the side-bezel **Span** button.
 - Set the span to 100 kHz.
 - c. Set the generator to provide a 50 kHz, +10 dBm signal.
 - d. Step the generator and MDO Center Frequency, in 100 kHz intervals, through frequencies from 50 kHz to 950 kHz. At each interval, determine the test result as follows:
 - Note the reading on the power meter and the readout for the Reference marker on the oscilloscope.
 - Calculate the difference between the two readings. This is the test result.
 - e. In the test record, enter the greatest result determined within this frequency range (50 kHz to 950 kHz).
 - f. Change the center frequency and span as follows:
 - At each interval ensure the MDO4000C center frequency and generator output are set to the same frequency.
 - Change the center frequency to 1 MHz.
 - Change the span to 2 MHz.
 - g. Set the generator to provide a 1 MHz, +10 dBm signal.
 - h. Step the generator and MDO Center Frequency, in 1 MHz intervals, through frequencies from 1 MHz to 9 MHz. At each interval, determine the test result as follows:
 - Note the reading on the power meter and the readout for the Reference marker on the oscilloscope.
 - Calculate the difference between the two readings. This is the test result.
 - i. In the test record, enter the greatest result determined within this frequency range (1 MHz to 9 MHz).

- j.** *Change the center frequency and span as follows:*
 - Change the center frequency to 10 MHz.
 - Change the span to 20 MHz.
- k.** Set the generator to provide a 10 MHz, +10 dBm signal.
- l.** Step the generator and MDO4000C Center Frequency, in 10 MHz intervals, through frequencies from 10 MHz to 90 MHz. At each interval ensure the MDO4000C center frequency and generator output are set to the same frequency. At each interval, determine the test result as follows:
 - Note the reading on the power meter and the readout for the Reference marker on the oscilloscope.
 - Calculate the difference between the two readings. This is the test result.
- m.** In the test record, enter the greatest result determined within this frequency range (10 MHz to 90 MHz).
- n.** *Change the center frequency and span as follows:*
 - Change the center frequency to 100 MHz.
 - Change the span to 50 MHz.
- o.** Set the generator to provide a 100 MHz, +10 dBm signal.
- p.** Step the generator, in 100 MHz intervals, through frequencies from 100 MHz to 2.9 GHz. At each interval, determine the test result as follows:
 - At each interval ensure the MDO center frequency and generator output are set to the same frequency.
 - Note the reading on the power meter and the readout for the Reference marker on the oscilloscope.
 - Calculate the difference between the two readings. This is the test result.
- q.** In the test record, enter the greatest result determined within this frequency range (100 MHz to 3 GHz).

For models with option SA6 only (steps r through s)

- r. Step the generator, in 100 MHz intervals, through frequencies from 3.1 GHz to 5.9 GHz. At each interval, determine the test result as follows:
 - At each interval ensure the MDO center frequency and generator output are set to the same frequency
 - Note the reading on the power meter and the readout for the Reference marker on the oscilloscope.
 - Calculate the difference between the two readings. This is the test result.
 - s. In the test record, enter the greatest result determined within this frequency range (3.1 GHz to 6 GHz).
4. *Check at 0 dBm:*
 - a. Set the reference level to 0 dBm as follows: Push the front-panel **Ampl** button. Push the side-bezel **Ref Level** button. Set the Ref Level to 0 dBm.
 - b. Set the generator to provide a 1 MHz, 0 dBm signal.
 - c. Repeat step 3 while keeping the generator output level and the instrument reference level set to 0 dBm.
 5. *Check at –15 dBm:*
 - a. Set the reference level to –15 dBm as follows: Push the front-panel **Ampl** button. Push the side-bezel **Ref Level** button. Set the Ref Level to –15 dBm.
 - b. Set the generator to provide a 1 MHz, –15 dBm signal.
 - c. Repeat step 3 while keeping the generator output level and the instrument reference level set to –15 dBm.

Check Third Order Intermodulation Distortion

This check verifies that the oscilloscope meets the specification for Third Order Intermodulation Distortion. This check is for instruments with option SA3 or SA6.



WARNING. *The generators are capable of providing dangerous voltages. Be sure to set the generators to off or 0 volts before connecting, disconnecting, and/or moving the test hookup during the performance of this procedure.*

Required equipment. You will need the following equipment for this check. All items are shown in the required equipment list. (See Table 17.)

- Two generators. Each generator must be capable of providing signals up to 6 GHz. You can use two of the same model generator, or two different generators, depending on what you have available. Example generators are the Anritsu MG3691C and the Rohde & Schwarz SMT06.
- A power combiner (hybrid coupler), such as the Krytar 3005070.
- Three SMA cables. Use cables that will connect to your generators' outputs.

1. *Connect the equipment as follows.* (See the following figure.)
 - Connect an SMA cable from the RF input on the oscilloscope to the power combiner connector labeled “IN.”
 - Connect an SMA cable from the RF output of a generator to a –3 dB input on the power combiner.
 - Connect an SMA cable from the RF output of the other generator to the other -3 dB input on the power combiner.

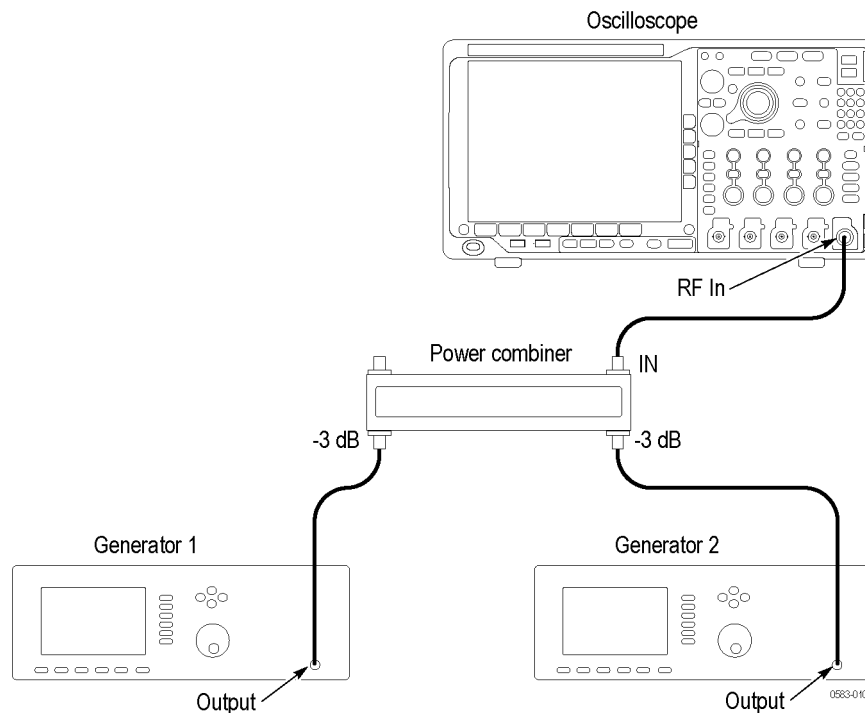

2. Set generator 1 to provide a 2.735 GHz, –10 dBm signal at the RF input of the oscilloscope.
3. Set generator 2 to provide a 2.755 GHz, –10 dBm signal at the RF input of the oscilloscope.
4. *Initial oscilloscope setup:*
 - a. Push the front-panel **Default Setup** button.
 - b. Turn channel 1 off.
 - c. Push the front-panel **RF** button to turn on the RF channel and show the bottom-bezel menu.
 - d. *Turn on the average trace as follows:* Push the bottom-bezel **Spectrum Traces** button. Push the side-bezel **Average** button to set the Average Traces to On. Push the side-bezel **Normal** button twice to set the Normal Trace to **Off**.

- e. *Set the center frequency as follows:* Push the front-panel **Freq/Span** button. Push the side-bezel **Center Frequency** button. Set the center frequency to 2.745 GHz.
 - f. *Set the span as follows:* Push the side-bezel **Span** button. Set the Span to 100 MHz.
 - g. *Set the resolution bandwidth (RBW) as follows:* Push the front-panel **BW** button. Push the side-bezel **RBW Mode** button to select Manual. Push the side-bezel **RBW** button. Set the resolution bandwidth to 100 kHz.
 - h. Push the front-panel **Markers** button.
 - i. Push the side-bezel **Manual Markers** button to set the manual markers to On.
 - j. Push the side-bezel **Readout** button to select **Delta**.
5. *Check at 2.745 GHz as follows (options SA3 or SA6):*
- a. Set marker a to the peak of the generator 1 signal (2.735 GHz).
 - b. Check for peaks at two frequencies:
 - 20 MHz lower frequency than the generator 1 signal
 - 20 MHz higher frequency than the generator 2 signal
 - c. Set marker b to each of these two peaks in turn. See the following figure.

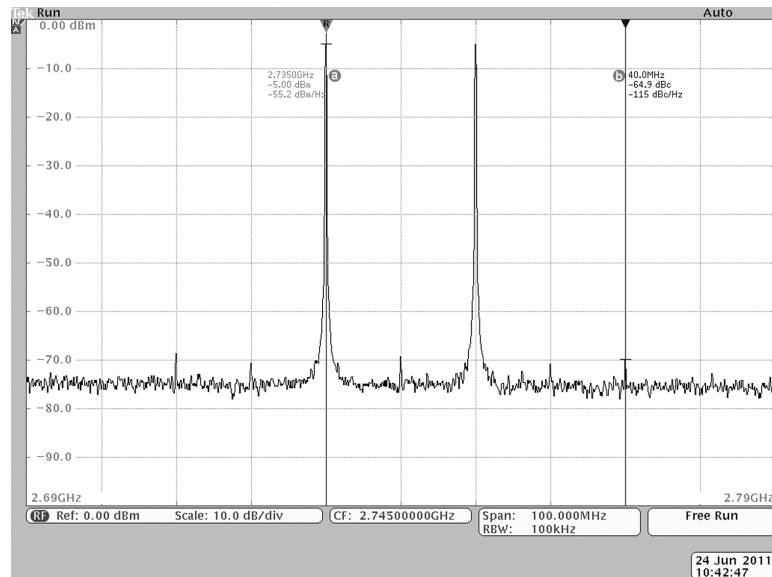

- d. Record the values in dBc units for both peaks in the test record and verify that the values are below the specified limit.
6. Check at 4.5 GHz as follows (option SA6 only):
 - a. Set generator 1 to provide a 4.49 GHz, -10 dBm signal at the RF input of the oscilloscope.
 - b. Set generator 2 to provide a 4.510 GHz, -10 dBm signal at the RF input of the oscilloscope.
 - c. Set the Center Frequency to 4.5 GHz.
 - d. Set marker a to the peak of the generator 1 signal (4.49 GHz).
 - e. Check for peaks at two frequencies:
 - 20 MHz lower frequency than the generator 1 signal
 - 20 MHz higher frequency than the generator 2 signal
 - f. Set marker b to each of these two peaks in turn.
 - g. Record the values in dBc units for both peaks in the test record and verify that the values are below the specified limit.

Check Residual Spurious Response

This check verifies that the oscilloscope meets the specification for residual spurious response. This check does not require an input signal. This check is for instruments with option SA3 or SA6.

1. *Terminate the oscilloscope RF input in 50 Ω and make sure that no input signal is applied.*
2. *Initial oscilloscope setup:*
 - a. Push the front-panel **Default Setup** button.
 - b. Turn Channel 1 off.
 - c. Push the front-panel **RF** button to turn on the RF channel.
 - d. Set the reference level to -25 dBm as follows:
 - Push the front-panel **Ampl** button.
 - Push the side-bezel **Ref Level** button.
 - Set the Ref Level to -25 dBm.
 - e. Turn on Average spectrum traces, set to 32 averages and turn off Normal spectrum traces as follows:
 - Press the **RF** button.
 - Push the **Spectrum Traces** bottom-bezel button.
 - Push the **Average** side-bezel button.
 - Set averaging to 32.
 - Push the **Normal** side-bezel button until it is turned off.
3. *Check in the range of 9 kHz to 50 kHz as follows:*
 - a. Push the front-panel **Freq/Span** button. Push the side-bezel **Start** button. Set the start frequency to 9 kHz. Push the side-bezel **Stop** button. Set the stop frequency to 50 kHz.
 - b. Set the resolution bandwidth (RBW) to 300 Hz as follows:
 - Push the front-panel **BW** button.
 - Push the side-bezel **RBW Mode** button to select Manual.
 - Push the side-bezel **RBW** button.
 - Set the resolution bandwidth to 300 Hz.
 - c. Observe any spurs that are greater than -85 dBm and note them in the test record.

4. *Check in the range of 50 kHz to 3 GHz as follows:*
 - a. Push the front-panel **Freq/Span** button. Push the side-bezel **Start** button. Set the start frequency to 50 kHz. Push the side-bezel **Stop** button. Set the stop frequency to 3 GHz.
 - b. Set the resolution bandwidth (RBW) to 50 kHz as follows:
 - Push the front-panel **BW** button.
 - Push the side-bezel **RBW Mode** button to select Manual.
 - Push the side-bezel **RBW** button.
 - Set the resolution bandwidth to 50 kHz.
 - c. Excluding the spur at 2.5 GHz, observe any spurs that are greater than -85 dBm and note them in the test record.
 - d. If the spur at 2.5 GHz is greater than -73 dBm, note it in the test record.
5. *For instruments with option SA6: Check in the range of 2.75 GHz to 4.5 GHz as follows:*
 - a. Change the oscilloscope start frequency to 2.75 GHz and the stop frequency to 4.5 GHz.
 - b. Excluding the spur at 3.75 GHz, observe any spurs that are greater than -85 dBm and note them in the test record.
 - c. If the spur at 3.75 GHz is greater than -78 dBm, note it in the test record.
6. *For instruments with option SA6: Check in the range of 3.5 GHz to 6.0 GHz as follows:*
 - a. Change the oscilloscope start frequency to 3.5 GHz and the stop frequency to 6.0 GHz.
 - b. Excluding any spurs at 4 GHz and 5 GHz, observe any spurs that are greater than -85 dBm and note them in the test record.
 - c. If the spur at 4 GHz or 5 GHz is greater than -78 dBm, note it in the test record.

Check Crosstalk to RF Channel from Analog Channels

This check verifies that the oscilloscope meets the specification for crosstalk from an analog channel to the RF channel. This check is for instruments with option SA3 or SA6.



WARNING. *The generator is capable of providing dangerous voltages. Be sure to set the generator to off or 0 volts before connecting, disconnecting, and/or moving the test hookup during the performance of this procedure.*

1. Terminate the oscilloscope RF input in $50\ \Omega$.
2. Connect the output of a signal generator to all four analog inputs on the oscilloscope. If you are using the Fluke 9500 oscilloscope calibrator as the signal generator, you can connect the active heads to all four analog inputs at once (Ch 1, Ch 2, Ch 3, and Ch 4). If your generator does not have the capacity to hook up all four channels at once, you can move the connector to each channel in turn.

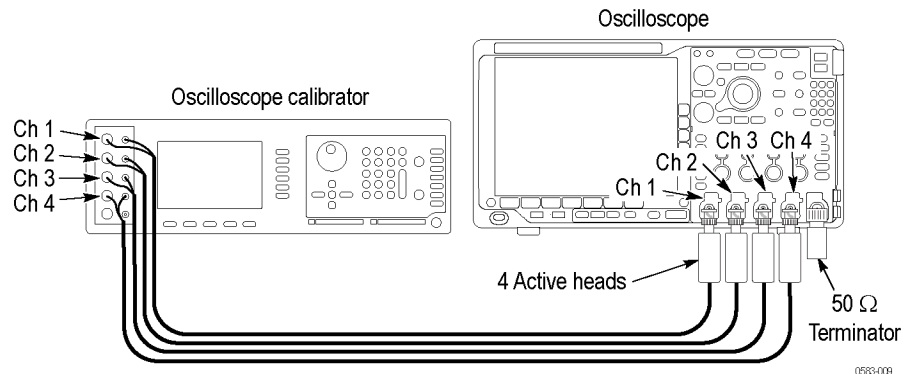

3. Set the generator to provide a 105 MHz, 633 mV_{p-p} (0 dBm) sine wave signal.
4. *Initial oscilloscope setup:*
 - a. Push the front-panel **Default Setup** button.
 - b. Select all analog channels (CH1, CH2, CH3, and CH4), and in the vertical menu, push **Termination** to select **50 Ω** impedance.
 - c. Push the front-panel **RF** button to turn on the RF channel and display the bottom-bezel menu.
 - d. *Turn on the average trace as follows:* Push the bottom-bezel **Spectrum Traces** button. Push the side-bezel **Average** button to set the **Average Traces** to **On**, with 16 averages. Push the side-bezel **Normal** button twice to turn the Normal Trace Off.
 - e. *Set the span to 50 MHz as follows:* Push the front-panel **Freq/Span** button. Push the side-bezel **Span** button. Set the Span to 50 MHz.
5. Set the generator to provide the signal to channel 1.

6. *Measure the Channel 1 crosstalk at 105 MHz as follows:*
 - a. *Set the center frequency to 105 MHz as follows:* Push the front-panel **Freq/Span** button. Push the side-bezel **Center Frequency** button. Set the center frequency to 105 MHz.
 - b. Use a marker to measure the amplitude of the Channel 1 signal at the center frequency. Be sure to ignore spurs that are unrelated to this measurement. See the following figure.
 - c. Record the amplitude of the Channel 1 signal in the test record. Make sure that it is within the specified limit.
7. Repeat step 6, changing the generator signal frequency and the oscilloscope Center Frequency settings as indicated in the test record. Check all listed frequencies and record the results in the test record.
8. Repeat steps 5 through 7 to check crosstalk on channels 2-4.

Check Trigger Out

This test checks the Trigger Output.

1. Connect the Trigger Out signal from the rear of the instrument to the channel 1 input using a 50 Ω cable, as shown in the following illustration.

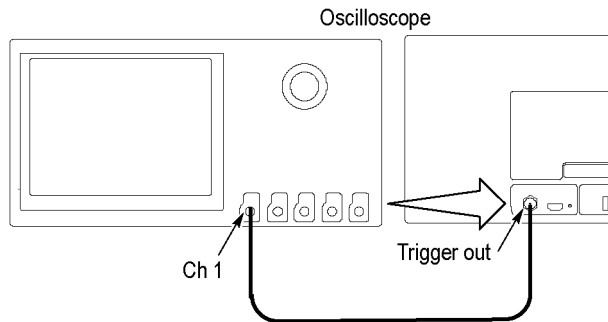

2. Push the front-panel **Default Setup** button.
3. Set the Vertical **Scale** to **1 V** per division.
4. *Record the Low and High measurements at 1 M Ω as follows:*
 - a. Push the front-panel Wave Inspector **Measure** button.
 - b. Push the **Add Measurement** lower-bezel button.
 - c. Select the **Low** measurement.
 - d. Push the **OK Add Measurement** side-bezel button.
 - e. Enter the Low measurement reading in the test record.
 - f. Select the **High** measurement.
 - g. Push the **OK Add Measurement** side-bezel button.
 - h. Enter the High measurement reading in the test record.
5. *Record the Low and High measurements at 50 Ω as follows:*
 - a. Push the front-panel channel 1 button.
 - b. Set the **Termination** (input impedance) to **50 Ω** .
 - c. Repeat step 4.

When the MDO4000C Has a TPA-N-PRE attached to its RF Input

The following instructions apply to situations where the MDO4000C has a TPA-N-PRE preamplifier attached to its RF input (option SA3 or SA6)

Perform the following functional check to ensure proper operation of the TPA-N-PRE/MDO4000C system.

For this check, you will need the following equipment, which is described in the Required Equipment table. (See Table 17 on page 34.)

- Generator, such as the Anritsu generator
- Power meter
- Power head
- Power splitter
- Adapters and cables as shown in the following figure.



WARNING. *The generator is capable of providing dangerous voltages. Be sure to set the generator to off or 0 volts before connecting, disconnecting, and/or moving the test hookup during the performance of this procedure.*

NOTE. *Use an SMA connector with the Anritsu generator. Equipment damage will result if an N connector is used.*

1. Connect the equipment as shown in the following figure.

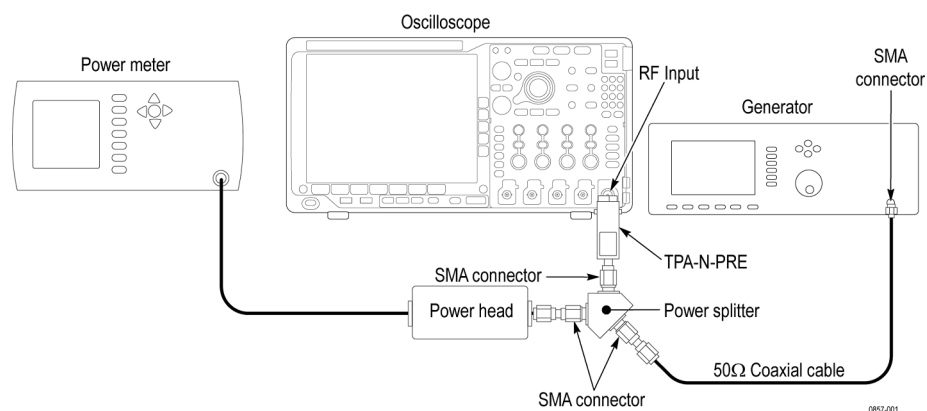

2. Initial oscilloscope setup:
 - a. Push the front-panel **Default Setup** button.
 - b. Turn Channel 1 off.

- c. Push the front-panel **RF** button to turn on the RF channel.
 - d. Push the Menu button on the TPA-N-PRE preamplifier. On the MDO4000C, for the Mode, select **Auto**.
3. Check at 1.7 GHz
- a. Set the reference level to -25 dBm as follows: Push the front-panel **Ampl** button. Push the side-bezel **Ref Level** button. Set the Ref Level to -25 dBm.
 - b. *Set the frequency range as follows:*
 - Push the front-panel **Freq/Span** button.
 - Push the side-bezel **Center Frequency** button.
 - Set the center frequency to 1.7 GHz.
 - Push the side-bezel **Span** button.
 - Set the span to 50 MHz.
 - c. Set the generator to provide a 1.7 GHz, -30 dBm signal.
 - d. Note the reading on the power meter and the readout for the Reference marker on the oscilloscope. See the following figure:

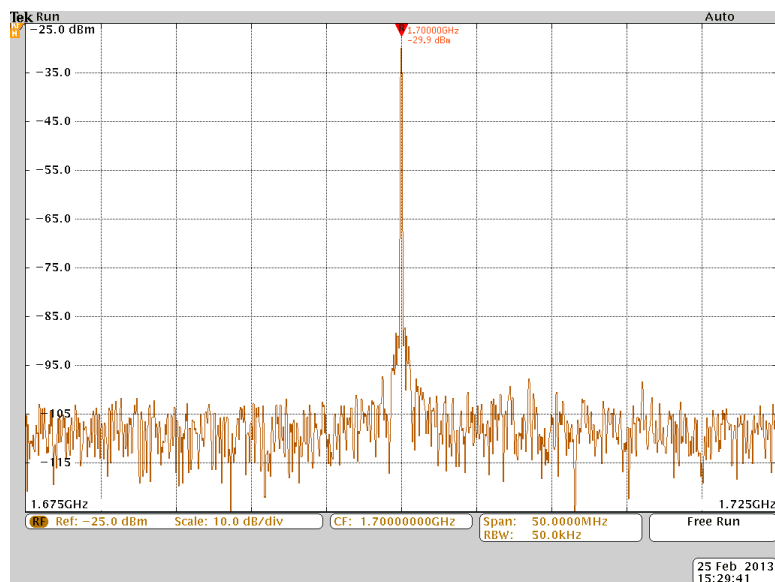

- e. The absolute difference between the two readings should be small (~ 2dB or less). If the MDO4000C reading is too low, tighten the preamp more firmly to the MDO4000C by hand and check the reading again.
 - f. Check at the -40 dBm reference level.
 - Set the generator to provide a 1.7 GHz, -45 dBm signal..
 - Set the reference level to -40 dBm.
 - Compare the MDO4000C and the power meter readings as before. The absolute difference between the readings should be ~2dB or less. If the MDO4000C reading is too low, tighten the preamp more firmly to the MDO4000C by hand and check the reading again.
4. Check at 5.5 GHz (option SA6 only)
- a. Set the reference level to -25 dBm as follows: Push the front-panel **Ampl** button. Push the side-bezel **Ref Level** button. Set the Ref Level to -25 dBm.
 - b. *Set the frequency range as follows:*
 - Set the center frequency to 5.5 GHz.
 - Set the span to 50 MHz.
 - c. Set the generator to provide a 5.5 GHz, -30 dBm signal.
 - d. Note the reading on the power meter and the readout for the Reference marker on the oscilloscope.
 - e. The absolute difference between the two readings should be small (~ 2dB or less). If the MDO4000C reading is too low, tighten the preamp more firmly to the MDO4000C by hand and check the reading again.
 - f. Check at the -40 dBm reference level.
 - Set the generator to provide a 5.5 GHz, -45 dBm signal..
 - Set the reference level to -40 dBm.
 - Compare the MDO4000C and the power meter readings as before. The absolute difference between the readings should be ~2dB or less. If the MDO4000C reading is too low, tighten the preamp more firmly to the MDO4000C by hand and check the reading again.

**With TPA-N-PRE Attached:
Check Displayed Average
Noise Level (DANL)**

This test does not require an input signal.

The test measures the average internal noise level of the instrument, ignoring residual spurs. This check is for instruments with option SA3 or SA6.

It checks six ranges:

- 9 kHz to 50 kHz (all models)
- 50 kHz to 5 MHz (all models)
- 5 MHz to 400 MHz (all models)
- 400 MHz to 3 GHz (all models)
- 3 GHz to 4 GHz (option SA6 only)
- 4 GHz to 6 GHz (option SA6 only)

NOTE. *If the specific measurement frequency results in measuring a residual spur that is visible above the noise level, the DANL specification applies not to the spur but to the noise level on either side of the spur. Please refer to the Spurious Response specifications. (See page 21.)*

1. *Initial oscilloscope setup:*
 - a. Terminate the TPA-N-PRE preamp input in 50 Ω and make sure that no input signal is applied.
 - b. Push the front-panel **Default Setup** button.
 - c. Turn channel 1 off.
 - d. Push the front-panel **RF** button to turn on the RF channel and display the bottom-bezel RF menu.
 - e. *Turn on the average trace as follows:*
 - Push the bottom-bezel **Spectrum Traces** button.
 - Push the side-bezel **Average** button to set average trace to **On**.
 - Set the side-bezel **Normal** to **Off**.
 - f. *Turn on average detection as follows:*
 - Push the bottom-bezel **Detection Method** button.
 - Push the side-bezel button to set the detection method to **Manual**.
 - Push the side-bezel **Average Trace** button.
 - Set the detection method to **Average**.
 - g. Push the **Menu** button on the TPA-N-PRE preamplifier. On the MDO4000C, verify that the side-bezel **Mode** button is set to **Auto**.
 - h. *Set the reference level to –40.0 dBm as follows:*
 - Push the front-panel **Ampl** button.
 - Push the side-bezel **Ref Level** button.
 - Set the Ref Level to –40.0 dBm.
2. *Check from 9 kHz to 50 kHz (all models):*
 - a. *Set the stop and start frequencies as follows:*
 - Push the front-panel **Freq/Span** button.
 - Push the side-bezel **Stop** button.
 - Set the stop frequency to 50 kHz.
 - Push the side-bezel **Start** button.

- Set the start frequency to 9 kHz.
 - Wait 60 seconds. Due to the low RBW for this span, it takes a little while for the instrument to compute a valid average.
- b.** Set Manual Marker (a) at the frequency with the highest noise level as follows:
- Push the **Markers** front-panel button.
 - Push the **Manual Markers** side-bezel button to turn on the markers.
 - Turn Multipurpose knob **a** to move the marker to the frequency at the noise threshold (highest point of noise), ignoring any spurs. See the following figure.

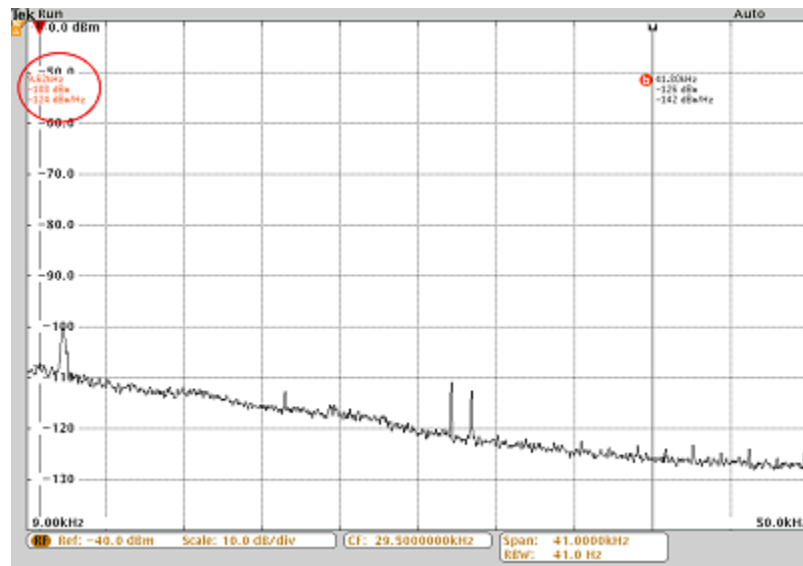

- c.** Record the highest noise value (in dBm/Hz) in the test record and compare it to the instrument specification.
- 3.** Check from 50 kHz to 5 MHz (all models):
- a.** Set the start and stop frequency as follows:
 - Push the front-panel **Freq/Span** button.
 - Push the side-bezel **Stop** button.
 - Set the stop frequency to 5 MHz.

- Push the side-bezel **Start** button.
 - Set the start frequency to 50 kHz.
- b. Set Manual Marker (a) at the frequency with the highest noise level as follows:
- Push the **Markers** front-panel button.
 - Push the **Manual Markers** side-bezel button to turn on the markers.
 - Turn Multipurpose knob **a** to move the marker to the frequency at the noise threshold (highest point of noise), ignoring any spurs. See the following figure.

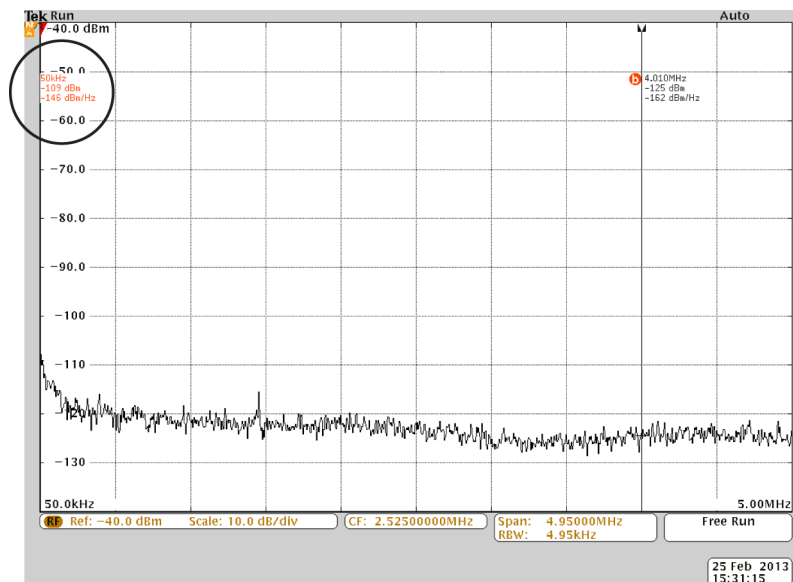

- c. Record the noise threshold value (in dBm/Hz) in the test record and compare it to the instrument specification.
4. Check from 5 MHz to 400 MHz (all models):
- a. Set the stop frequency to 400 MHz.
 - b. Set the start frequency to 5 MHz.
 - c. Set Manual Marker (a) at the frequency of the highest noise, ignoring any spurs.
 - d. Set the center frequency as follows: Push the **R To Center** side-bezel button.

- e. Set the Span to 10 MHz.
 - Push the side-bezel **Span** button.
 - Set the Span to 10 MHz.
 - f. Record the highest noise value (in dBm/Hz) in the test record and compare it to the instrument specification.
5. *Check from 400 MHz to 3 GHz (all models):*
- a. Set the stop frequency to 3 GHz.
 - b. Set the start frequency to 400 MHz.
 - c. Set Manual Marker (a) at the frequency of the highest noise, ignoring any spurs.
 - d. *Set the center frequency as follows:* Push the **R To Center** side-bezel button.
 - e. *Set the Span to 10 MHz as follows.*
 - Push the side-bezel **Span** button.
 - Set the Span to 10 MHz.
 - f. Record the highest noise value (in dBm/Hz) in the test record and compare it to the instrument specification.
6. *Check from 3 GHz to 4 GHz (option SA6 only):*
- a. Set the stop frequency to 4 GHz.
 - b. Set the start frequency to 3 GHz.
 - c. Set Manual Marker (a) at the frequency of the highest noise, ignoring any spurs.
 - d. *Set the center frequency as follows:* Push the **R To Center** side-bezel button.
 - e. *Set the Span to 10 MHz as follows.*
 - Push the side-bezel **Span** button.
 - Set the Span to 10 MHz.
 - f. Record the highest noise value (in dBm/Hz) in the test record and compare it to the instrument specification.
7. *Check from 4 GHz to 6 GHz (option SA6 only):*
- a. Set the stop frequency to 6 GHz.
 - b. Set the start frequency to 4 GHz.
 - c. Set Manual Marker (a) at the frequency of the highest noise, ignoring any spurs.

- d. *Set the center frequency as follows:* Push the **R To Center** side-bezel button.
- e. *Set the Span to 10 MHz as follows:*
 - Push the side-bezel **Span** button.
 - Set the Span to 10 MHz.
- f. Record the highest noise value (in dBm/Hz) in the test record and compare it to the instrument specification.

Check AFG Sine and Ramp Frequency

This test checks the AFG Sine and Ramp Frequency. This check is for instruments with MDO4AFG.

1. Connect AFG output to the frequency counter.
2. Push the Default Setup button on the oscilloscope front panel.
3. Push the AFG button on the front panel.
4. Under Waveform Settings, set amplitude and frequency to those shown in the test record.
5. Set Waveform to Sine wave (or Ramp).
6. Push Output Settings on the bottom menu. Push Load Impedance on the side menu to select 50 Ω .
7. Measure frequency in the frequency counter. Compare results to the limits in the test record.
8. Repeat steps 3 - 7 above for all rows in the test record. This completes the procedure.

Check AFG Square and Pulse Frequency Accuracy

This test checks the AFG Square and Pulse Frequency Accuracy. This check is for instruments with MDO4AFG

1. Connect the AFG output to the frequency counter.
2. Push the Default Setup button on the oscilloscope front panel.
3. Push the AFG button on the front panel.
4. Under Waveform Settings, set Amplitude and frequency to that shown in the test record.
5. Set output to Square wave (or Pulse).
6. Push Output Settings on the bottom menu. Push Load Impedance on the side menu to select 50 Ω .

7. Measure frequency in the frequency counter. Compare results to the limits in the test record.
8. Repeat steps 3 - 7 for all rows in the test record. This completes the procedure.

Check AFG Signal Amplitude Accuracy

This test checks the AFG Signal Amplitude Accuracy. This check is for instruments with MDO4AFG

1. Connect the AFG output to the DMM through a 50 Ω termination.
2. Push the Default Setup button on the oscilloscope front panel.
3. Push the AFG button on the front panel.
4. Push Output Settings on the bottom menu. Push Load Impedance on the side menu to select 50 Ω .
5. Under Waveform Settings, set amplitude and frequency to the value shown in the test record.
6. Under Waveform set the signal to Square.
7. Measure voltage on the DMM. Compare the result to the limits in the test record.
8. Repeat steps 3 - 7 above for all rows in the test record. This completes the procedure.

Check AFG DC Offset Accuracy

This test checks the AFG DC Offset Accuracy. This check is for instruments with MDO4AFG

1. Connect the AFG output to the DMM through a 50 Ω termination.
2. Push the Default Setup button on the oscilloscope front panel.
3. Push the AFG button on the front panel.
4. Under Waveform set the signal to DC.
5. Under Waveform Settings, set Amplitude to the value shown in the test record.
6. Push Output Settings on the bottom menu. Push Load Impedance on the side menu to select 50 Ω .
7. Measure voltage on the DMM. Compare the value to the limits in the test record.
8. Repeat steps 3 - 7 above for each line in the test record. This completes the procedure.

Check DVM Voltage Accuracy (DC)

This test checks the DVM voltage accuracy (DC).

1. Connect the oscilloscope to a DC voltage source to run this test. If using the Fluke 9500 calibrator as the DC voltage source, connect the calibrator head to the oscilloscope channel to test.
2. Push the Default Setup button on the front panel to set the instrument to the factory default settings.
3. Push channel button 1, 2, 3, or 4 to select the channel you want to check.
4. Confirm that the oscilloscope termination and calibrator impedance are both set to 1 M Ω . Push Termination on the lower menu to select 1 M Ω .
5. Set the calibrator to the input voltage shown in the test record (for example, -5 V for a 1 V/div setting). Set the calibrator impedance to match the termination setting for the oscilloscope.
6. On the oscilloscope, push More on the lower menu repeatedly, to select Offset.
7. Set the oscilloscope to the vertical offset value shown in the test record (for example, -5 V for -5 V input and 1 V/div setting).
8. Turn the vertical Scale knob to match the value in the test record (for example, 1 V/division).
9. Turn the Horizontal Scale knob to 1 ms/div.
10. Push Bandwidth on the lower menu.
11. Push 20 MHz on the side menu.
12. Check that the vertical position is set to 0 divs. If not, turn the appropriate Vertical Position knob to set the position to 0 divs. Or, push More on the lower menu repeatedly to select Position, and then push Set to 0 divs on the side menu.
13. Push Acquire on the front panel.
14. Push Mode on the lower menu, and then push Average on the side menu. Use the default number of averages (16).
15. Push the Trigger Menu button on the front panel.
16. Push Source on the lower menu.
17. Turn Multipurpose knob "a" to select AC Line as the trigger source.
18. On the front panel, push the Measure button.
19. Push the DVM lower-bezel button to turn on the DVM function.
20. Turn the Multipurpose a knob to select DC mode
21. Turn the Multipurpose b knob to select the input channel to be tested.

22. Push Menu Off on the front panel. The measured value should appear in a measurement pane at the top of the display.
23. Enter the measured value in the test record. (See page 61, DVM Voltage Accuracy Tests (DC).)
24. Repeat the procedure (steps 6, 7, 8 and 22) for each volts/division setting shown in the test record.
25. Repeat all steps, starting with step 1, for each oscilloscope channel you want to check. This completes the procedure.

Check DVM Voltage Accuracy (AC)

This test checks the DVM voltage accuracy (AC).

1. Connect the output of the leveled sine wave generator (for example, Fluke 9500) to the oscilloscope channel 1 input.
2. Push Default Setup on the front panel to set the instrument to the factory default settings.
3. Push channel button 1, 2, 3, or 4 for the channel that you want to check.
4. Set the generator to 50 Ω output impedance (50 Ω source impedance).
5. Set the oscilloscope termination to 50 Ω . Push Termination on the lower menu to select 50 Ω .
6. Set the generator to produce a square wave of the amplitude and frequency listed in the test record (for example, 20 mV_{pp} and 1 kHz).
7. Turn the vertical scale knob so that the signal covers between 4 and 8 vertical divisions on screen.
8. Push the Measure button, then the DVM lower-bezel button to turn on the DVM function.
9. Use the multipurpose knob a to select AC RMS mode
10. Use the multipurpose knob b to select the input channel being tested.
11. Enter the measured value in the test record.
12. Repeat procedure for each voltage and frequency combination shown in the record.
13. Repeat all steps for each oscilloscope channel.

Check DVM Frequency Accuracy and Maximum Input Frequency

This test checks DVM Frequency Accuracy

1. Push Default Setup on the oscilloscope front panel to set the instrument to the factory default settings.
2. Connect the output of the time mark generator to the oscilloscope channel 1 input using a 50 Ω cable. Use the time mark generator with a 50 Ω source with the oscilloscope set for internal 50 Ω termination.
3. Set the time mark generator to the value shown in the test record. For example, use 10 Hz. Use a time mark waveform with a fast rising edge.
4. Set the mark amplitude to 1 Vpp.
5. Set the oscilloscope vertical Scale to 500 mV/div.
6. Set the Horizontal Scale to 20 ms/div.
7. Adjust the Trigger Level for a triggered display.
8. Adjust the vertical Position knob to center the time mark on center screen.
9. Push the Measure button on the front panel, and then the DVM lower-bezel button to turn on the DVM feature.
10. Turn multipurpose knob a to select Frequency mode.
11. Turn multipurpose knob b to select the input channel being tested.
12. Enter the measured value in the test record.
13. Repeat this procedure for each frequency setting shown in the record. (Keep the same vertical and horizontal scales as set in steps 5 and 6.)
14. Repeat all these steps for each oscilloscope channel. This completes the procedure.

This completes the performance verification procedure.