



Modular Series

Professional Mounts & Solutions

peerless-AV[®]

Introducing the innovative & versatile Modular Series solutions from Peerless-AV

THE DIFFERENCE WITH TWIN POLE MODULAR SERIES

Large scale AV installations can be an involved and time consuming business. However, Peerless-AV believe that bigger, both in terms of screen sizes or number of displays, does not have to mean more complicated. By constantly striving to improve the versatility and ease of use of our products, and through working closely with installers and integrators the new Twin Pole Modular Series product range is designed to ensure the very best installer experience.

Designed around a standard 50mm diameter twin column the components in this series can be combined to fulfil multiple requirements, from a single ceiling mounted display to an unlimited floor-to-ceiling video wall array. With a minimum number of SKUs and a simple, intuitive method of selecting the required parts it could not be simpler to create the bespoke Modular Series arrangement that is ideally suited to your next project.

For peace of mind all Modular Series products are tested to the highest UL mounting safety standards to withstand four times the rated load capacity. They also include a number of innovative features and benefits, such as incremental tilt and back-to-back screen options, making them the most versatile and easy to install products available.

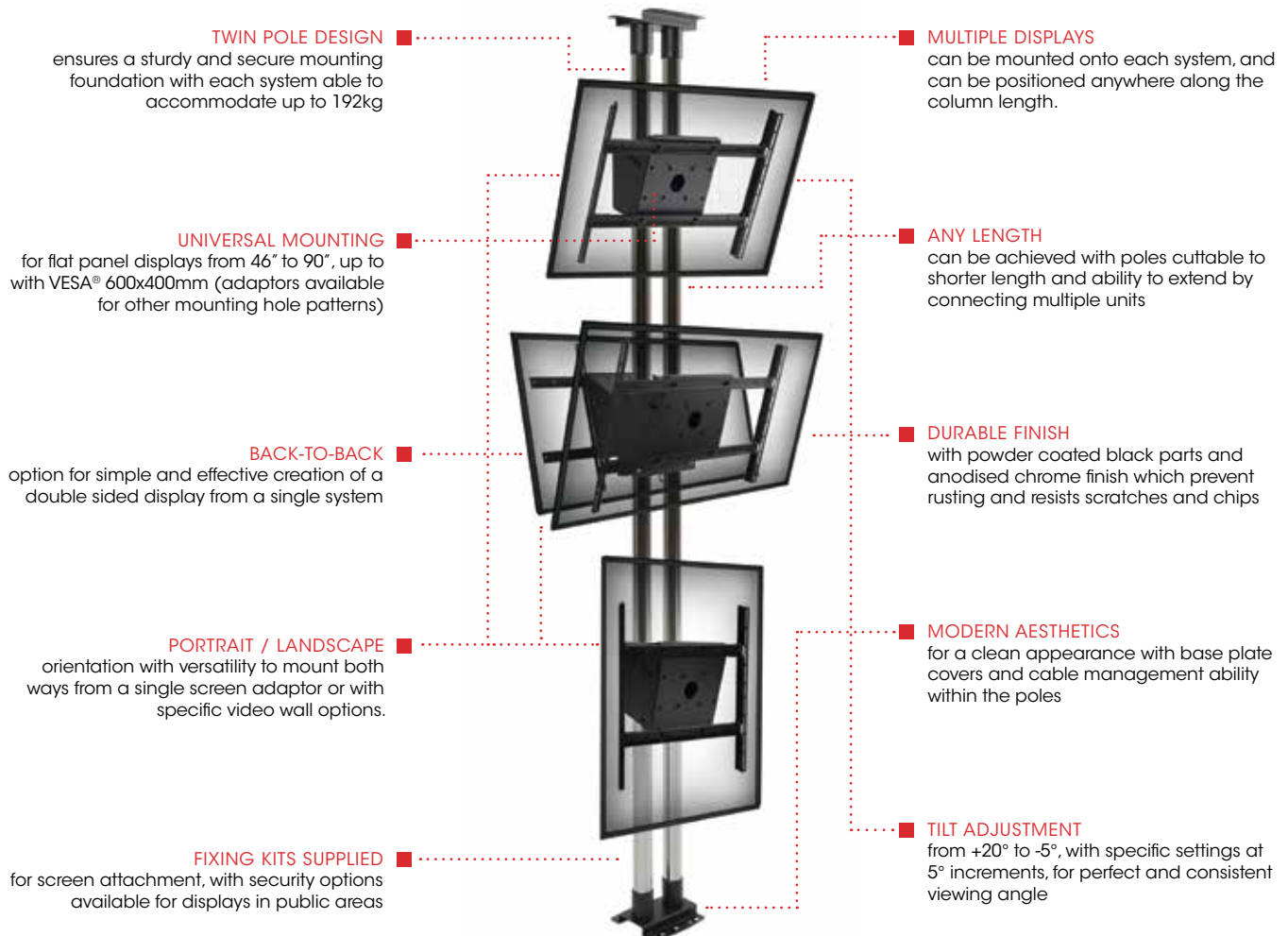

Configuration Options

There are two ways to configure your Modular Series solution, depending upon your specific requirements. This can be in either a single twin column application with one or more displays on an individual unit or with a number of twin column units and multiple screens on each combined to form a video wall application.

SINGLE APPLICATION



One twin pole system, available in 4 different mounting options, with single or multiple displays arranged in portrait, landscape or back-to-back orientation using MOD-UNL screen adaptor.



1

Ceiling Mount System



2

Floor to Ceiling Mount System



3

Floor to Wall Mount System



4

Free standing Mount System

VIDEO WALL APPLICATION



Multiple twin pole system, available in 3 different mounting options, with multiple displays arranged in portrait or landscape orientation using standard screen adaptor or dedicated video wall mounts.

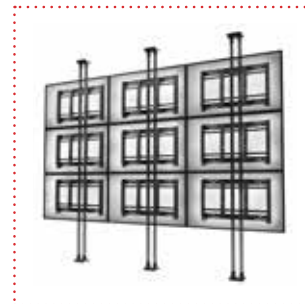

1

Floor to Ceiling Video Wall Mount System



2

Floor to Wall Video Wall Mount System



3

Free standing Video Wall Mount System



CEILING MOUNT SYSTEM

A versatile solution for mounting single or multiple flat panel displays from a ceiling, with a choice of 2 ceiling fixings, heavy duty flat plate or I-beam connector. Choose between single or back-to-back mounting along with accessories such as Media Box holders (MOD-MBM & MOD-MBL) for a clean and stylish appearance.

CHOOSE



or



MOD-CPF2
Heavy Duty Floor/
Ceiling Plate

MOD-CP12
I-Beam
Ceiling Plate

CHOOSE



MOD-P100
1m
Chrome Pole

or



MOD-P150
1.5m
Chrome Pole



MOD-P200
2m
Chrome Pole



MOD-P300
3m
Chrome Pole

CHOOSE

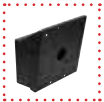

or



MOD-FPMS2
Single Screen
Mount Bracket

MOD-FPMD2
Back to Back Screen
Mount Bracket

REQUIRED



MOD-ACS2
Screen Stacking
Clamp



MOD-UNL2
Universal Screen
Adapter

OPTIONAL



MOD-ADF
Pole Drill Fixture



MOD-APC
Pole Coupler



MOD-AWM2
Wall Mount Adapter*



MOD-ACF2
Ceiling Plate Cover



MOD-MBL
Large Media Box



MOD-MBM
Medium Media Box



VESA® up to
600x400mm



Max weight
96kg per display
192kg total @ 3m length

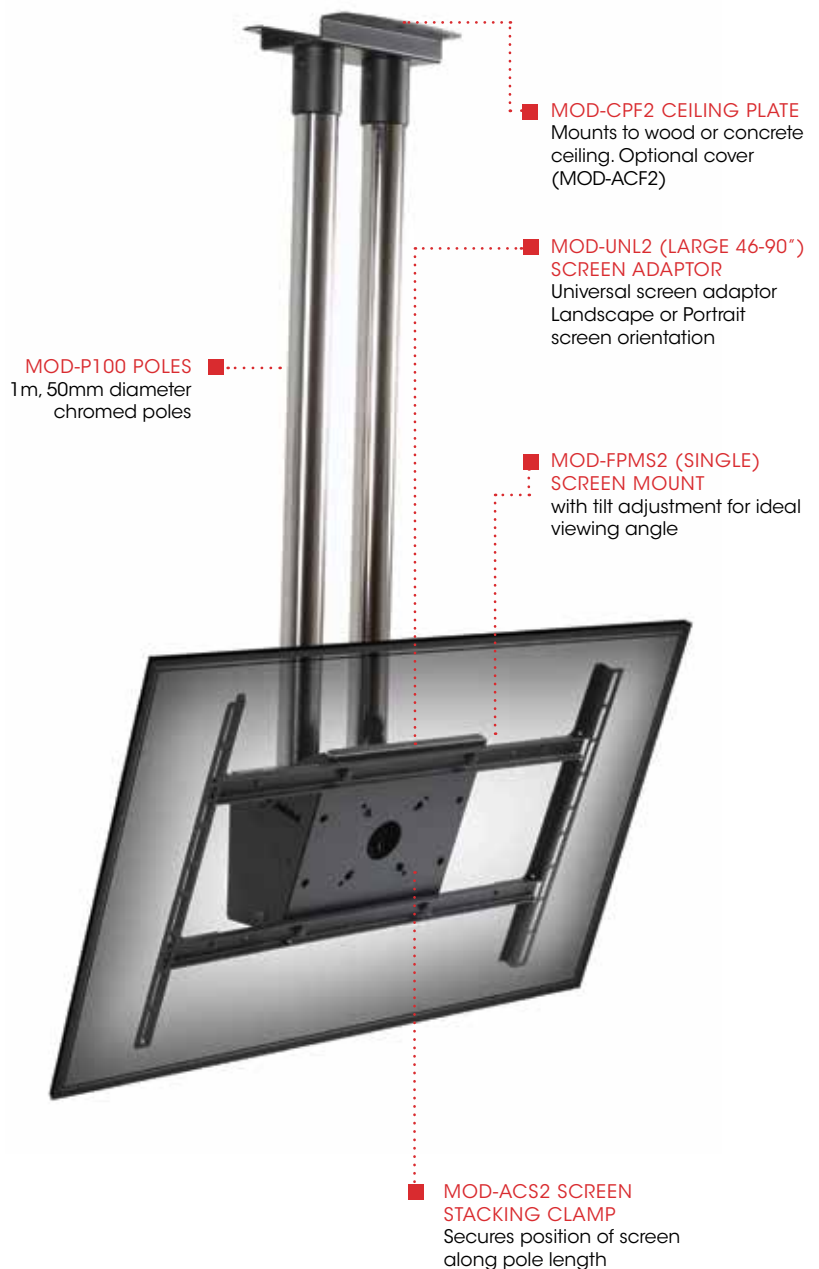

EXAMPLE KIT SHOWN FOR SINGLE SCREEN AT 1m DROP CONSISTS OF:

1 x MOD-CPF2 : 2 x MOD-P100 : 1 x MOD-FPMS2 : 1 x MOD-UNL2 : 1 x MOD-ASC2

* MOD-AWM2 also compatible with SmartMount flat & tilt models (SF640 to SF680 & ST640 to ST680)



FLOOR TO CEILING SYSTEM

Secured top and bottom with the heavy duty plates, this floor-to-ceiling arrangement is the perfect solution to display a number of screens for a wide variety of applications. The MOD-ASC2 can clamp anywhere along the pole length for versatile screen positioning, while multiple poles can be connected to achieve extended heights using the MOD-APC accessory.

REQUIRED



x 2

MOD-CPF2
Heavy Duty Floor/
Ceiling Plate

CHOOSE



MOD-P100
1m
Chrome Pole



MOD-P150
1.5m
Chrome Pole

or



MOD-P200
2m
Chrome Pole



MOD-P300
3m
Chrome Pole

CHOOSE

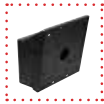

MOD-FPMS2
Single Screen
Mount Bracket

or



MOD-FPMD2
Back to Back Screen
Mount Bracket

REQUIRED



MOD-ACS2
Screen Stacking
Clamp



MOD-UNL2
Universal Screen
Adapter

OPTIONAL



MOD-ADF
Pole Drill Fixture



MOD-APC
Pole Coupler



MOD-AWM2
Wall Mount Adapter*



MOD-ACF2
Floor/Ceiling Cover



MOD-MBL
Large Media Box



MOD-MBM
Medium Media Box



VESA® up to
600x400mm



Max weight
96kg per display
192kg total @ 3m length

MOD-ACS2 SCREEN STACKING CLAMP
Secures position of screen along pole length

MOD-CPF2 CEILING PLATE
Mounts to wood or concrete ceiling
Optional cover (MOD-ACF2)

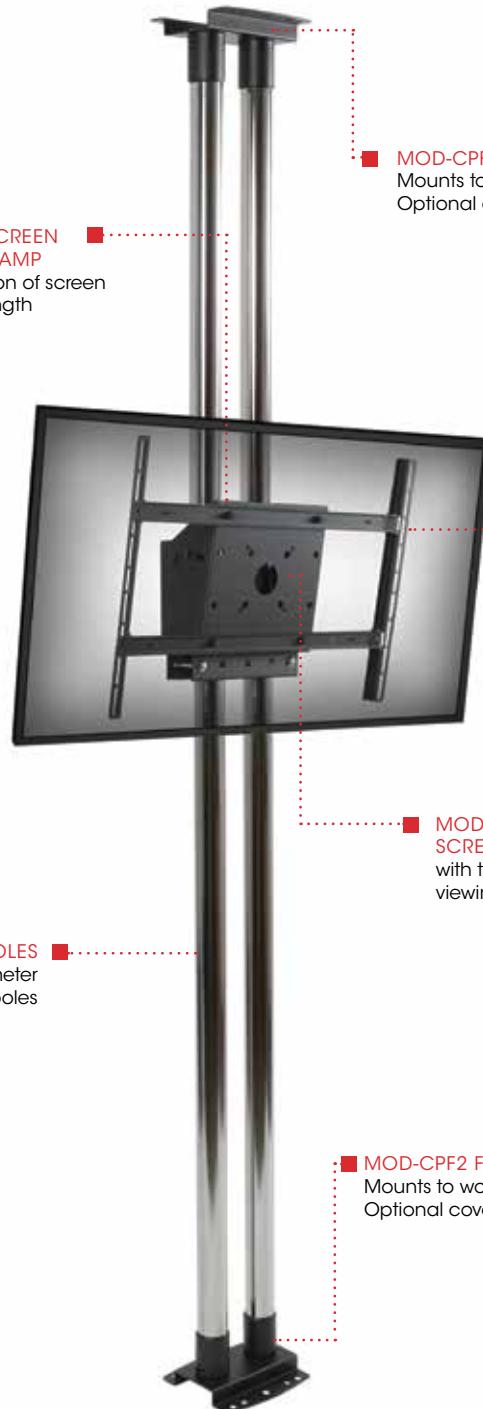

MOD-UNL2 (LARGE 46-90") SCREEN ADAPTOR
Universal screen adaptor
Landscape or Portrait screen orientation

MOD-FPMS2 SINGLE SCREEN MOUNT
with tilt adjustment for ideal viewing angle

MOD-300 POLES
3m, 50mm diameter
chromed poles

MOD-CPF2 FLOOR PLATE
Mounts to wood or concrete floor
Optional cover (MOD-ACF2)

EXAMPLE KIT SHOWN FOR SINGLE SCREEN WITH 3m HEIGHT CONSISTS OF:
2 x MOD-CPF2 : 2 x MOD-P300 : 1 x MOD-FPMS2 : 1 x MOD-UNL2 : 1 x MOD-ASC2

* MOD-AWM2 also compatible with SmartMount flat & tilt models (SF640 to SF680 & ST640 to ST680)



FLOOR TO WALL SYSTEM

When space is limited create an eye-catching visual display against a wall or in a totem arrangement aligned to a column or pillar. The MOD-WP2 wall bracket positions each screen a mere 172mm from the wall for a discrete appearance and includes fine adjustment of $\pm 22\text{mm}$ to enable a simple way to ensure columns are installed vertically.

REQUIRED



MOD-CPF2
Heavy Duty Floor/
Plate



MOD-WP2
Wall Plate

CHOOSE



MOD-P100
1m
Chrome Pole



MOD-P150
1.5m
Chrome Pole

or



MOD-P200
2m
Chrome Pole



MOD-P300
3m
Chrome Pole

REQUIRED

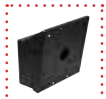

MOD-FPMS2
Single Screen
Mount Bracket



MOD-ACS2
Screen Stacking
Clamp



MOD-UNL2
Universal Screen
Adapter

OPTIONAL



MOD-ADF
Pole Drill Fixture



MOD-APC
Pole Coupler



MOD-AWM2
Wall Mount Adapter*



MOD-ACF2
Floor Plate Cover



MOD-MBL
Large Media Box



MOD-MBM
Medium Media Box



VESA® up to
600x400mm



Max weight
96kg per display
192kg total @ 3m length

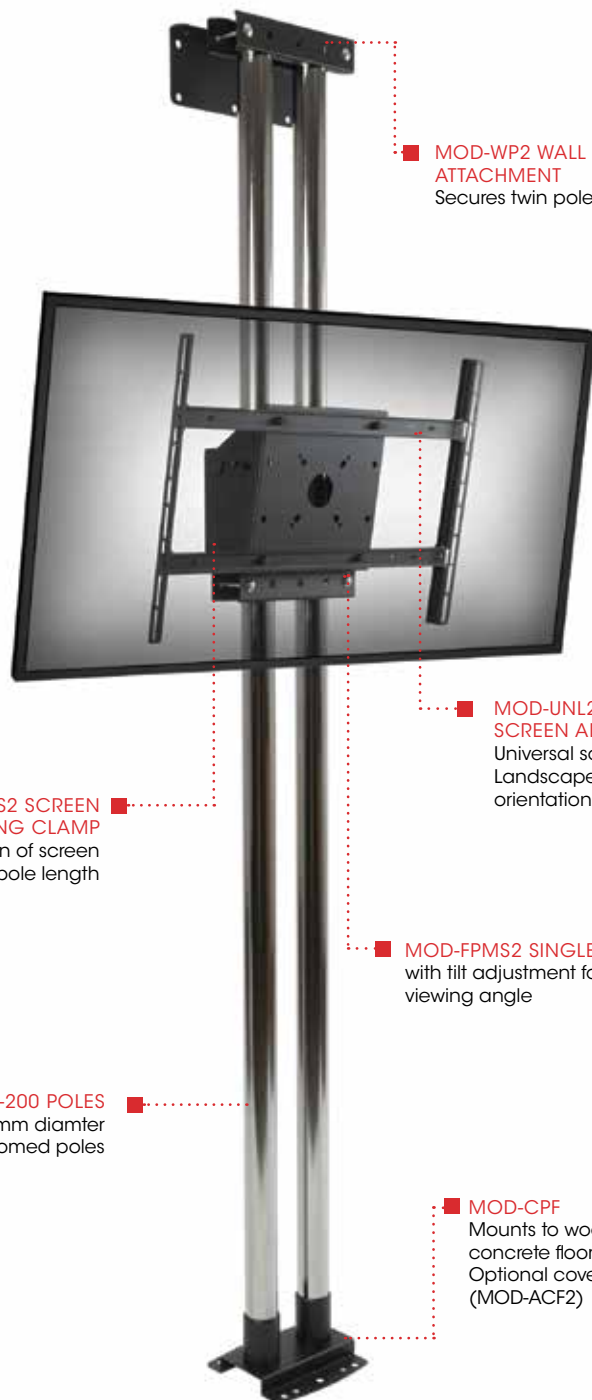

MOD-WP2 WALL MOUNT ATTACHMENT
Secures twin poles parallel to wall

MOD-UNL2 (LARGE 46-90") SCREEN ADAPTOR
Universal screen adaptor
Landscape or Portrait screen orientation

MOD-ACS2 SCREEN STACKING CLAMP
Secures position of screen
along pole length

MOD-FPMS2 SINGLE SCREEN MOUNT
with tilt adjustment for the ideal
viewing angle

MOD-200 POLES
2m, 50mm diameter
chromed poles

MOD-CPF
Mounts to wood or
concrete floor
Optional cover
(MOD-ACF2)

EXAMPLE KIT SHOWN FOR SINGLE SCREEN WITH 2m HEIGHT CONSISTS OF:

1 x MOD-WP2 : 2 x MOD-P200 : 1 x MOD-FPMS2 : 1 x MOD-UNL2 : 1 x MOD-ASC2 : 1 x MOD-CPF2

* MOD-AWM2 also compatible with SmartMount flat & tilt models (SF640 to SF680 & ST640 to ST680)



FREESTANDING SYSTEM

This versatile free standing configuration is ideal for a wide range of applications from retail store window displays to advertising, information and wayfinding points in shopping centres and leisure complexes. The option of back-to-back screen mounting enables users to double the display area from a single footprint and maximise impact.

REQUIRED



MOD-FPP2
Floor Pedestal Plate

CHOOSE *



MOD-P100
1m
Chrome Pole



MOD-P150
1.5m
Chrome Pole

or



MOD-P200
2m
Chrome Pole

* Max 2m height for freestanding unit

CHOOSE



MOD-FPMS2
Single Screen
Mount Bracket

or



MOD-FPMD2
Back to Back Screen
Mount Bracket

REQUIRED



MOD-ACS2
Screen Stacking
Clamp



MOD-UNL2
Universal Screen
Adapter

OPTIONAL



MOD-AWM2
Wall Mount Adapter*



MOD-MBM
Medium Media Box



MOD-MBL
Large Media Box



MOD-ACAP
Tube End Plug Kit



VESA® up to
600x400mm



Max weight
96kg per display
192kg total @ 2m length



MOD-ACS2 SCREEN STACKING CLAMP
Secures position of screen along pole length

MOD-UNL2 (LARGE 46-90") SCREEN ADAPTOR
Universal screen adaptor Landscape or Portrait screen orientation

MOD-FPMS2 (SINGLE) SCREEN MOUNT
with tilt adjustment for the ideal viewing angle

MOD-P200 POLES
2m, 50mm diameter
chromed poles
(2m max. height)

MOD-FPP2 HEAVY DUTY FLOOR FIXTURE
Free standing applications can be bolted in place for added security

EXAMPLE KIT SHOWN FOR SINGLE SCREEN WITH 2m HEIGHT CONSISTS OF:

1 x MOD-FPP2 : 2 x MOD-P200 : 1 x MOD-FPMS2 : 1 x MOD-UNL2 : 1 x MOD-ASC2

* MOD-AWM2 also compatible with SmartMount flat & tilt models (SF640 to SF680 & ST640 to ST680)

Build the right Modular System for you in four simple stages...

Simply choose the components and functionality you need and custom build a set-up that matches your overall requirements.

1 CHOOSE THE CEILING / FLOOR / WALL PLATE

Heavy Duty Floor/ Ceiling Plate

MOD-CPF2 (Black)

Mounts to concrete and wood joist
Max Weight: 192kg (422lb)



Heavy Duty Floor / Ceiling Plate Cover

MOD-ACF2 (Black)

For use with MOD-CPF2 only



Wall Plate

MOD-WP2 (Black)

Adjustment: +/- 22.2mm



I-Beam Ceiling Plate

MOD-CPI2 (Black)

Fully adjustable for I-beams
85mm to 250mm wide
Max Weight: 192kg (422lb)
Tilt Angle: +/- 60°



Floor Pedestal Plate

MOD-FPP2 (Black)

For freestanding applications
Max Weight: 192kg (422lbs)



2 SELECT POLE LENGTH & ACCESSORIES

Extension Poles

MOD-P100 1.0m (39") length,
MOD-P150 1.5m (59") length,
MOD-P200 2.0m (78") length,
MOD-P300 3.0m (118") length



Tube End Cap Kit

MOD-ACAP (Black)

Kit contains 2pcs
Provides clean pole end finish



Trim Disc

MOD-ATD-W (White)

Fits around pole to clean up rough cut through false ceiling tiles



Pole Coupler

MOD-APC (Chrome)

Connects 2 x 50mm diameter poles



Pole Drill Fixture

MOD-ADF (Black)

Allows marking & positioning of new installation holes to be drilled into newly cut 50mm diameter poles



3 WHICH SCREEN CONFIGURATION?

Flat Mount Single & Back-to-Back Screens

Screen-Stacking Clamp MOD-ASC2 (Black)

Clamps around extension pole to stack multiple screens
Max: weight 96kg (211lb)



Single Screen Mount MOD-FPMS2

Tilt Angle: +20/ -5°
VESA®: 75/100/200 x 200mm
Max weight: 96kg (211lb)



Back-to-Back Screen Mount MOD-FPMD2

Tilt Angle: +20/ -5°
VESA®: 75/100/200 x 200mm
Max weight: 192kg (411lb)



Full Service Video Wall Mount

Wall Mount Adapter MOD-AWM2

Allows for a wall mount to be attached *
Max weight: 96kg (211lb)



4 REQUIRED SCREEN ADAPTOR MOUNT

Universal Screen Adaptor MOD-UNL2

Screen Size: 46" - 90"
Max VESA®: 600 x 400mm
Max Weight: 96kg (211lb)



Media Box Holder MOD-MBM (MOD-FPMS2 only)

Max weight 4.55kg (10lb)
Max internal dimensions:
195x195x35mm



Media Box Holder MOD-MBL (MOD-FPMS2 only)

Max weight 90kg (198lb)
Max internal dimensions:
241x196x63mm



Landscape Video Wall DS-VW765-LQR & DS-VW765-LAND (See page 13 for full spec)



Portrait Video Wall DS-VW765-PQR & DS-VW765-POR (See page 13 for full spec)



* MOD-AWM2 is also compatible with flat & tilt models from the SmartMount range (SF640 to SF680 & ST640 to ST680)

IF you require further assistance or additional information on how to select the correct configuration for your requirements please contact Peerless-AV on Tel: +44 (0) 1923 200100 ; E-mail: info@peerless-av.eu.com ; Web: www.peerless-av.com



FREE STANDING VIDEO WALL

This versatile free standing configuration is a fast and effective method to create an eye-catching video wall array in a wide range of applications and settings. When deployed for use in public spaces safety and security are assured with the ability to bolt the floor plate in place and the use of security screen attachment hardware fixings.

Example: DS-VW765-LAND



Max weight
57kg per display
192kg total @ 2m length

**DS-VW765-LAND
MICRO-ADJUSTMENT**
8-point tool-less fine tuning ensures seamless display alignment

**DS-VW765-LAND
HORIZONTAL SHIFT**
Left-to-Right adjustment for flush display positioning

MOD-P200 POLES
2m long 50mm diameter chromed poles (2m max. height)

MOD-AWM2
Video Wall mount adaptor can be positioned at any point along the columns

**DS-VW765-LAND
VIDEO WALL MOUNT**
Universal for flat panel displays from 40" to 65" up to VESA® 700 x 400mm

**MOD-FPP2 HEAVY DUTY
FLOOR FIXTURE**
Free standing floor plate can be bolted down for added stability

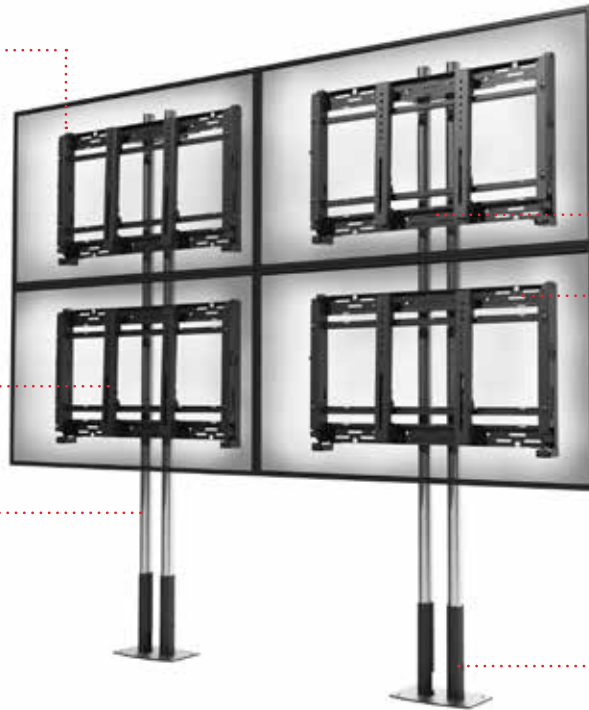

EXAMPLE KIT SHOWN FOR 2x2 LANDSCAPE VIDEO WALL WITH 2m HEIGHT CONSISTS OF:
2 x MOD-FPP2 : 4 x MOD-P200 : 4 x MOD-AWM2 : 4 x DS-VW765LAND

FLOOR PLATE REQUIRED



MOD-FPP2
Floor Pedestal Plate

COLUMN CHOOSE



MOD-P100
1m Chrome Pole



MOD-P150
1.5m Chrome Pole



MOD-P200
2m Chrome Pole

SCREEN MOUNT REQUIRED



MOD-ASC2
Screen Stacking Clamp



MOD-UNL2
Universal Screen Adaptor



MOD-FPMS2
Single Screen Bracket

or



MOD-FPMD2
Back to Back Bracket

VIDEO WALL MOUNT REQUIRED



MOD-AWM2
Wall Mount Adaptor

CHOOSE

LANDSCAPE or PORTRAIT



DS-VW765-LQR
Quick Release,
Fully Serviceable
Landscape

or



DS-VW765-LAND
Fully Serviceable
Landscape



DS-VW765-PQR
Quick Release,
Fully Serviceable
Portrait

or



DS-VW765-POR
Fully Serviceable
Portrait

ACCESSORIES OPTIONAL



MOD-MBM
Medium Media Box



MOD-MBL
Large Media Box



MOD-ADF
Pole Drill Fixture



MOD-ACAP
Tube End Plug Kit



Floor to Wall Video Wall System

Sturdy, secure and adaptable the Floor-to-Wall configuration is the ideal solution for creating a video wall in many applications from retail spaces and sales floors to corporate receptions and hotel lobbies. A full range of adjustment in the wall plate and video wall mount ensure that any number of displays can be perfectly aligned for a truly seamless appearance.

Example: DS-VW765-PQR

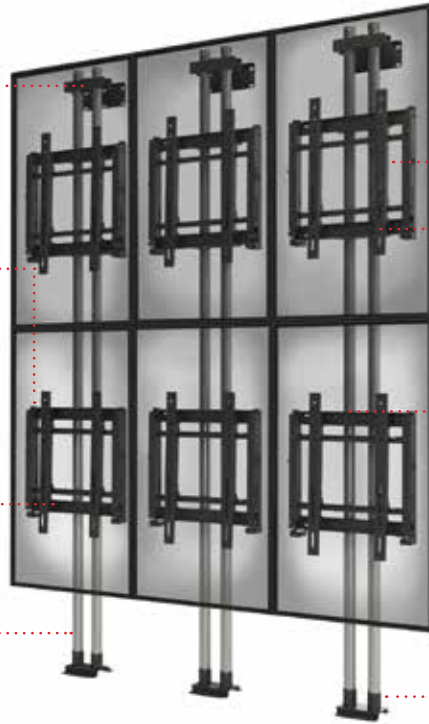

MOD-WP2 WALL PLATE
Secures twin poles parallel to the wall

DS-VW765-PQR MICRO-ADJUSTMENT
8-point tool-less fine tuning ensures seamless display alignment

DS-VW765-PQR HORIZONTAL SHIFT
Lateral adjustment for flush display alignment

MOD-P300 POLES
3m 50mm diameter chromed poles

DS-VW765-PQR QUICK RELEASE
Simple push release with full extension for simple access & maintenance

DS-VW765-PQR
Portrait Quick Release mount for flat panel displays from 42" to 65"

MOD-AWM2
Video Wall mount adaptor can be positioned at any point along the columns

MOD-CPF2 FLOOR PLATE
Attaches to wood & concrete floor. Optional cover (MOD-ACF2)

EXAMPLE KIT SHOWN FOR 3x2 PORTRAIT VIDEO WALL WITH 3m HEIGHT CONSISTS OF:
3 x MOD-CPF2 : 3 x MOD-WP2 : 6 x MOD-P300 : 6 x MOD-AWM2 : 6 x DS-VW765-PQR

FLOOR/WALL PLATE REQUIRED



MOD-CPF2
Heavy Duty Floor Plate



MOD-WP2
Wall Plate

OPTIONAL



MOD-ACF2
Floor Plate Cover

COLUMN CHOOSE



MOD-P100
1m Chrome Pole



MOD-P150
1.5m Chrome Pole



MOD-P200
2m Chrome Pole



MOD-P300
3m Chrome Pole

SCREEN MOUNT REQUIRED or



MOD-ASC2
Screen Stacking Clamp



MOD-UNL2
Universal Screen Adaptor

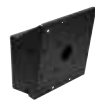

MOD-FPMS2
Single Screen Bracket

VIDEO WALL MOUNT REQUIRED



MOD-AWM2
Wall Mount Adaptor

CHOOSE

LANDSCAPE or PORTRAIT



DS-VW765-LQR
Quick Release, Fully Serviceable Landscape

or



DS-VW765-LAND
Fully Serviceable Landscape



DS-VW765-PQR
Quick Release, Fully Serviceable Portrait

or



DS-VW765-POR
Fully Serviceable Portrait

ACCESSORIES OPTIONAL



MOD-MBM
Medium Media Box



MOD-MBL
Large Media Box



MOD-ADF
Pole Drill Fixture



MOD-APC
Pole Coupler



Floor to Ceiling Video Wall System

The ultimate solution for creating a large format video wall, where the only limitation is the distance from floor to ceiling. Add multiple screens onto each twin pole system and quickly position the displays with perfect alignment when using the Video Wall mount adaptors, with horizontal movement and 8-point micro adjustment for the ultimate fine tuning.

Example: DS-VW765-LQR



- DS-VW765-LQR QUICK RELEASE**
Simple push release with full extension for simple access & maintenance
- MICRO-ADJUSTMENT**
8-point tool-less fine tuning ensures seamless display alignment
- HORIZONTAL SHIFT**
Lateral adjustment for flush display alignment
- MOD-P300 POLES**
3m 50mm diameter chromed poles

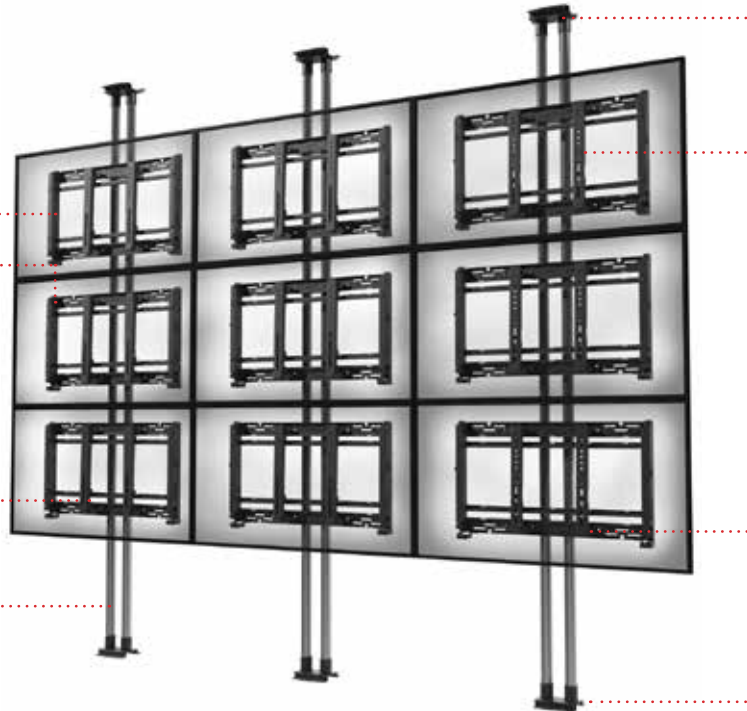

- DS-VW765-LQR**
Portrait Quick Release mount for flat panel displays from 46" to 65"
- MOD-CPF2 CEILING PLATE**
Mounts to wood or concrete - Optional cover (MOD-ACF2)
- MOD-AWM2**
Video Wall mount adaptor can be positioned at any point along the columns

EXAMPLE KIT SHOWN FOR 3x3 LANDSCAPE VIDEO WALL WITH 3m HEIGHT CONSISTS OF:
6 x MOD-CPF2 : 6 x MOD-P300 : 9 x MOD-AWM2 : 9 x DS-VW765LQR

FLOOR PLATE REQUIRED



MOD-CPF2
Heavy Duty Floor/Ceiling Plate

OPTIONAL



MOD-ACF2
Floor Plate Cover

COLUMN CHOOSE



MOD-P100
1m Chrome Pole



MOD-P150
1.5m Chrome Pole



MOD-P200
2m Chrome Pole



MOD-P300
3m Chrome Pole

SCREEN MOUNT REQUIRED or



MOD-ASC2
Screen Stacking Clamp



MOD-UNL2
Universal Screen Adaptor

CHOOSE



MOD-FPMS2
Single Screen Bracket

or

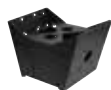

MOD-FPMD2
Back to Back Bracket

VIDEO WALL MOUNT REQUIRED



MOD-AWM2
Wall Mount Adaptor

CHOOSE

LANDSCAPE or PORTRAIT



DS-VW765-LQR
Quick Release, Fully Serviceable Landscape

or



DS-VW765-LAND
Fully Serviceable Landscape



DS-VW765-PQR
Quick Release, Fully Serviceable Portrait

or



DS-VW765-POR
Fully Serviceable Portrait

ACCESSORIES OPTIONAL



MOD-MBM
Medium Media Box



MOD-MBL
Large Media Box



MOD-ADF
Pole Drill Fixture



MOD-APC
Pole Coupler



Full Service Video Wall Mounts

Peerless-AV understands the challenges facing installers and integrators and our experience in the market has led to the creation of mounts that are packed with innovative features that offer up to a 60% reduction in installation time. With a choice of Quick Release or Full Service in both Portrait and Landscape there is a solution for every requirement.

Quick Release, Full-service video wall mount

DS-VW765-LQR (Landscape)

for 46" to 65" displays
up to VESA® 700x400mm
57kg max weight



DS-VW765PQR (Portrait)

for 42" to 65" displays
up to VESA® 400x600mm
57kg max weight



Key Features

- Easy-to-use push release and pop out mechanism provides quick service access, even for in-wall applications, while spring loaded catch securely clicks the display back into place
- Quick release can be restricted with a locking screw when feature is not needed
- Carriage extension force can be adjusted to compensate for the weight of the display
- Tool-less micro-adjustments at 8 points seamlessly align the displays
- Display extends from wall with prop-open function for simple service and maintenance

Full-service video wall mount

DS-VW765-LAND (Landscape)

for 40" to 65" displays
up to VESA® 700x400mm
57kg max weight



DS-VW765POR (Portrait)

for 42" to 65" displays
up to VESA® 400x600mm
57kg max weight



Key Features

- Tool-less micro-adjustments at 8 points seamlessly align the displays
- Display extends from wall with pull-out & prop-open function for simple service and maintenance
- Displays click securely back into place with spring-loaded mechanism
- Included security hardware prevents the mount from extending out from the wall
- Integrated cable management tie-backs make display-to-display cabling simple

One of the most time consuming and challenging parts of any video wall installation is to ensure that all the displays are perfectly aligned with no gaps or spaces between them. With Peerless-AV mounts this process could not be quicker or more simple. Tool-less micro-adjustments at 8 points enables every panel in an array to be individually fine tuned, both horizontally and vertically, as well as at all 4 corners for effective pitch and roll movement.

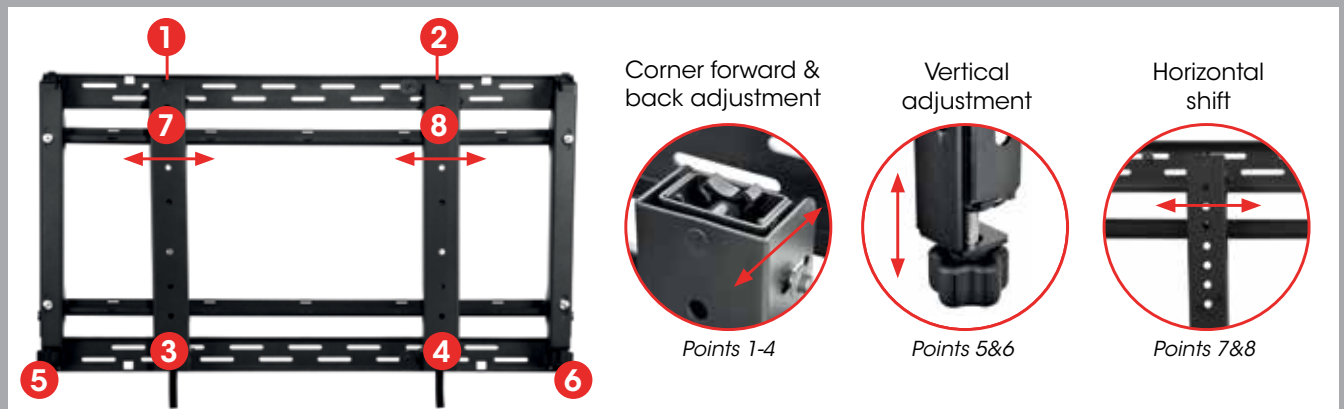

Technical Specifications

Heavy Duty Flat Ceiling/ Floor Plate MOD-CPF2 (Black)

- Mounts to concrete & wood joist
- Use as floor plate in floor-to-ceiling applications
- 170kg (374lbs) max weight capacity



Ceiling/ Floor Plate Cover MOD-ACF2 (Black)

- For use with MOD-CPF ceiling/floor plate.
- Can be installed over an existing installation
- Suitable for ceiling and floor-to-ceiling applications

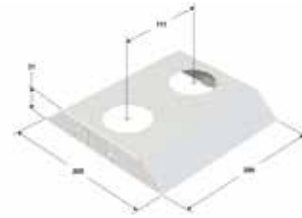

I-Beam Ceiling Plate MOD-CPI2 (Black)

- Fully adjustable for I-beams 85mm to 250mm wide
- 120kg (264lbs) max weight capacity
- +/- 60° tilt angle



Wall Plate MOD-WP2 (Black)

- Mounts to wall
- Secures twin poles parallel to wall
- ±22mm of front-to-back adjustment



Floor Pedestal Plate MOD-FPP2 (Black)

- For Freestanding applications
- Can be bolted to floor
- 192kg (422lbs) max weight capacity

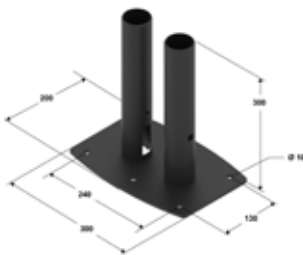

Chrome Extension Poles

- MOD-P100 - 1.0m (39")
- MOD-P150 - 1.5m (59")
- MOD-P200 - 2.0m (78")
- MOD-P300 - 3.0m (118")

- 50.8mm (2") diameter pole
- Cuttable to desired length
- Polished durable chrome finish

Ø50.8mm
[2.0in]



Pole Coupler MOD-APC (Chrome)

- Connects 2 x 50mm diameter poles

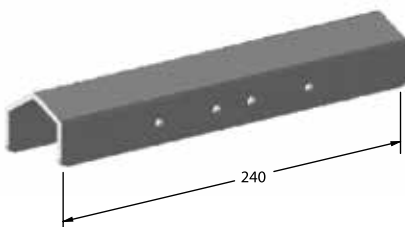

Pole Drill Fixture MOD-ADF (Black)

- Allows marking and positioning of new installation holes to be drilled into newly cut 50mm diameter poles

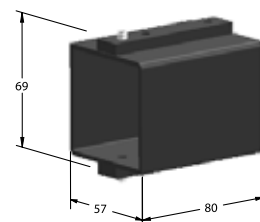

Single Screen Mount MOD-FPMS2 (Black)

- For 10"-75" flat panel screens
- VESA 75, 100 & 200x200mm compatible
- 100kg (220lbs) max weight capacity
- +20/-5° tilt lockable in 5° increments

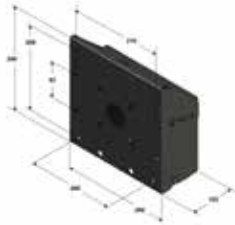

Dual Screen Mount MOD-FPMD2 (Black)

- For 10"-75" back-to-back flat panel screens
- VESA 75, 100 & 200x200mm compatible
- 170kg (374lbs) max weight capacity
- +20/-5° tilt lockable in 5° increments

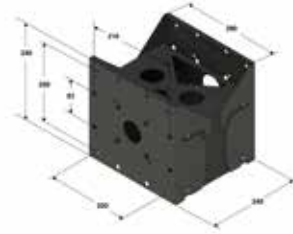

Screen Stacking Clamp MOD-ASC2 (Black)

- Clamps around extension pole to stack multiple single & back-to-back screens
- Can be positioned at any point on the column length
- 96kg (211lbs) max weight capacity



Wall Mount Adaptor MOD-AWM2 (Black)

- Clamps around extension pole to stack multiple video wall mount
- Can be positioned at any point on the column length
- 96kg (211lbs) max weight capacity



Large Universal Adaptor MOD-UNL2 (Black)

- For 46"-90" flat panel screens
- Expands from 200 to 600mm wide
- Compatible up to VESA 600 x 400
- 96kg (211lbs) max weight capacity



Media Box Holder MOD-MBM (Black)

- Medium - 195 x 195 x 35mm max internal
- Attaches to back of MOD-FPMS2 only
- 4.55kg (10lbs) max weight capacity

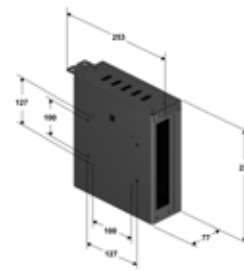

Media Box Holder MOD-MBL (Black)

- Large - 241 x 196 x 63mm max internal
- Attaches to back of MOD-FPMS2 only
- 90kg (198lbs) max weight capacity

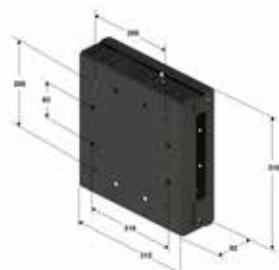

Trim Disc Accessory MOD-ATD-W (White)

- Fits around 50mm pole to clean up rough cut through false ceiling tile

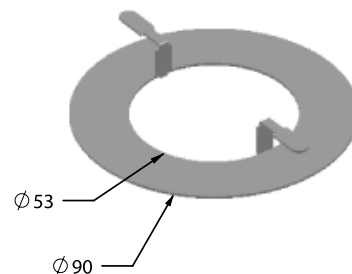



If you can imagine it, we can create it with Peerless Custom Mounting Solutions

Peerless-AV CMS places the resources of the industry leader in custom mounting solutions at your disposal. Whether your requirement is a simple modification to a standard Peerless product or a large scale, fully bespoke installation, Peerless CMS has the experience, know-how and facilities to make your solution a reality.

Special customer requests are the very reason why Peerless CMS exists. Through our customer focused D³ process - Design, Develop and Deploy, we work with you from creating the initial concept through to the installation of your solution.

We offer direct access to highly trained teams of mount design professionals who not only understand the AV landscape, but also are experienced at serving your markets. They are backed by over 40 years of experience.

Peerless is driven by the challenge of unique customer requirements. We have a long history of creating innovative solutions in every professional market - from hotels, restaurants, retail stores, hospitals, stadiums, pubs and clubs, schools and universities, we are ready to help you.

So if the mounting solution you require is not available in this brochure then please do not hesitate to contact us today to take advantage of this bespoke service.



Peerless-AV
2300 White Oak Circle
Aurora, IL 60502 USA

(800) 865-2112
(630) 375-5100
Fax: **(800) 359-6500**

Peerless-AV Europe
Unit 3 Watford Interchange
Colonial Way, Watford
Herts, WD24 4WP
United Kingdom

+44 (0) 1923 200100
Fax: **+44 (0) 1923 200101**

Peerless-AV de México
Ave de las Industrias 413
Parque Industrial Escobedo
Escobedo, N.L.,
Mexico 66050

+52 (81) 8384-8300
Fax: **+52 (81) 8384-8360**