



POWER QUALITY. SOLVED.

A STEEL PARTNERS COMPANY

Matrix[®] ONE

240V & 480V

TECHNICAL REFERENCE MANUAL

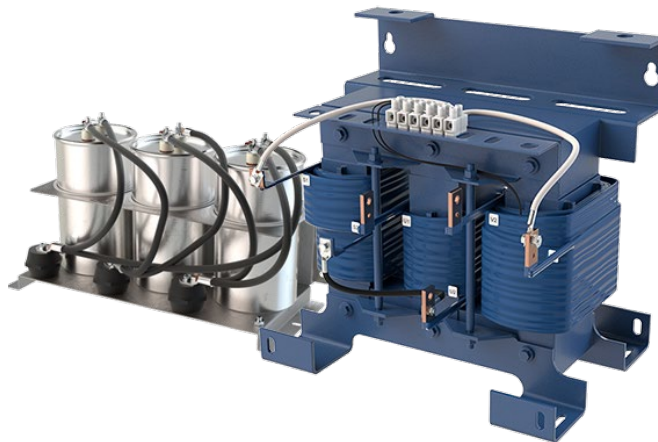

WARNING

High Voltage! Only a qualified electrician can carry out the electrical installation of this filter.

Quick Reference

1	Performance Data	Pages 5 - 10
2	Selection Guide	Pages 11 - 17
3	Installation Guide	Pages 17 - 26
4	Start-up/Troubleshooting	Pages 27 - 31

This page intentionally left blank

TABLE OF CONTENTS

1. SAFETY	1
WARNINGS AND CAUTIONS.....	1
PRODUCT SAFETY LABELING.....	1
GENERAL SAFETY INSTRUCTIONS.....	2
2. GENERAL INFORMATION	3
RECEIPT & REPAIR STATEMENT	3
ENCLOSURES	4
AGENCY APPROVALS	4
WARRANTY.....	4
3. MATRIX ONE PERFORMANCE DATA	5
PERFORMANCE SPECIFICATIONS	5
FILTER EFFICIENCY + WATT LOSS	6
MATRIX ONE 240V, 60HZ	6
FILTER EFFICIENCY + WATT LOSS	7
<i>Matrix ONE 480V, 60Hz</i>	7
LOAD EFFECT ON THID	8
TYPICAL HARMONIC SPECTRUM	8
POWER FACTOR	9
ALTITUDE DERATING.....	9
TEMPERATURE DERATING.....	10
4. HOW TO SELECT	11
SELECTION GUIDE	11
UNDERSTANDING THE MATRIX ONE PART NUMBER:	12
MATRIX ONE 240 VOLTS, 60HZ.....	13
<i>Part Number Selection Tables</i>	13
MATRIX ONE 480 VOLTS, 60HZ.....	15
<i>Part Number Selection Tables</i>	15
5. HOW TO INSTALL	17
INSTALLATION CHECKLIST	17
GROUNDING	18
POWER WIRING CONNECTION	19
BASIC SCHEMATIC DIAGRAMS	21
OPEN PANEL UNIT INTERCONNECTION DIAGRAM	22
ENCLOSED UNIT INTERCONNECTION DIAGRAM.....	23
CONTACTOR WIRING OPTION.....	24
TORQUE RATINGS.....	25
TORQUE RATINGS.....	26
6. START-UP	27
SAFETY PRECAUTIONS	27
7. TROUBLESHOOTING	29
HARMONIC FILTER FIELD CHECKS	30

List of Figures

Figure 3-1: Load Effect on THID	8
Figure 3-2: Typical Harmonic Spectrum with and without Matrix ONE	8
Figure 3-3: Matrix ONE % Load vs Power Factor	9
Figure 3-4: Altitude Derating Curve	9
Figure 3-5: Temperature Derating	10
Figure 5-1: Open Unit Schematic Diagram	21
Figure 5-2: Enclosed Unit Schematic Diagram	21
Figure 5-3: Matrix ONE 240V & 480V Open Panel Interconnection	22
Figure 5-4: Matrix ONE 240V & 480V Enclosed Interconnection	23



List of Tables

Table 3-1: Performance Specifications	5
Table 3-2: Watt Loss - Matrix ONE 240V, 60Hz	6
Table 3-3: Watt Loss - Matrix ONE 480V, 60Hz	7
Table 4-1: Matrix ONE 240V Open Panel	13
Table 4-2: Matrix ONE 240V Enclosed	14
Table 4-3: Matrix ONE 480V Open Panel	15
Table 4-4: Matrix ONE 480V Enclosed	16
Table 5-1: Overtemperature Switch	18
Table 5-2: Torque Ratings-240V	25
Table 5-3: Torque Ratings-480V	26
Table 7-1: Troubleshooting Guide	31

1. SAFETY





Warnings and Cautions

The following symbols are used in this manual:



 <p>WARNING</p>	<p>High Voltage Warning: warns of situations that dangerously high voltage is involved. Failure to use proper precautions may lead to serious injury or death.</p>
 <p>WARNING</p>	<p>General Warning: warns of situations that can result in serious injury or death if proper precautions are not used.</p>
 <p>Caution</p>	<p>General Caution: identifies situations that could lead to malfunction or possible equipment damage.</p>

Product Safety Labeling

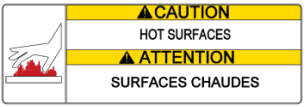
The following labels are placed on the Matrix ONE product:

	<p>Label notes to install to refer to instruction manual first before installing.</p>
	<p>High Voltage: surfaces on product can have high voltage which can cause injury.</p>
	<p>Wait five minutes for capacitors to discharge. Verify safe voltage level before servicing.</p>
	<p>Connect Thermal Switch: connecting the thermal switch can reduce risk of damage.</p>
	<p>Hot Surfaces: surfaces of product can be hot at times and cause burns.</p>

General Safety Instructions

 WARNING	<p>High Voltage! Only a qualified electrician can carry out the electrical installation of this filter.</p>
	<p>High voltage is used in the operation of this filter. Use extreme caution to avoid contact with high voltage when operating, installing or repairing this filter. Injury or death may result if safety precautions are not observed.</p>
 WARNING	<p>The opening of the branch circuit protective device may be an indication that a fault current has been interrupted. To reduce the risk of fire or electrical shock, current-carrying parts and other components of the filter should be examined and replaced if damaged.</p>
	<p>An upstream disconnect/protection device must be used as required by the National Electrical Code (NEC) or governing authority.</p>
	<p>Even if the upstream disconnect/protection device is open, the drive downstream of the filter may feedback high voltage to the filter. The drive safety instructions must be followed. Injury or death may result if safety precautions are not observed.</p>
	<p>The filter must be grounded with a grounding conductor connected to all grounding terminals. Open panel filters must have reactor grounded through a 2"x2" area cleaned of paint and varnish on lower mounting bracket.</p>
	<p>Only spare parts obtained from MTE Corporation or an authorized MTE distributor can be used.</p>
	<p>After removing power, allow at least five minutes to elapse and verify that the capacitors have discharged to a safe level before contacting internal components. Connect a DC voltmeter across the capacitor terminals and ensure that the voltage is at a safe level.</p>
 Caution	<p>Loose or improperly secured connections may damage or degrade filter performance. Visually inspect and secure all electrical connections before power is applied to the filter.</p>
	<p>The user of this filter must assure that the input voltage and frequency is correct for the filter rating and that the voltage applied falls within the rated operating tolerance envelop specified for the filter. For severe power line applications where the power feed is likely to experience surges and transients that exceed the input voltage rating, it is recommended that a TVSS (Transient Voltage Surge Suppression) or SPD (Surge Protection Device) be deployed ahead of the filter to reduce the possibility of exceeding the filter rated voltage. Consult with TVSS or SPD manufacturer to determine the correct protection requirements for your power line conditions.</p>

2. GENERAL INFORMATION

The purpose of this manual is to properly specify, size, and install the Matrix ONE.

For most current information, please refer to website

www.mtecorp.com/matrix-one-single-phase-filters

Receipt & Repair Statement

Upon Receipt of this Filter:

The Matrix ONE harmonic filter has been subjected to demanding factory tests before shipment. Carefully inspect the shipping container for damage that may have occurred in transit. Then unpack the filter and carefully inspect for any signs of damage. Save the shipping container for future transport of the filter.

In the event of damage, please contact and file a claim with the freight carrier involved immediately.

If the equipment is not going to be put into service upon receipt, cover and store the filter in a clean, dry location. After storage, ensure that the equipment is dry and that no condensation or dirt has accumulated on the internal components of the filter before applying power.

Repair/Exchange Procedure

MTE Corporation requires a Return Material Authorization Number and form before we can accept any filters that qualify for return or repair. If problems or questions arise during installation, setup, or operation of the filter, please contact MTE for assistance at:

Toll Free: 1-800-455-4MTE (1-800-455-4683)

International Tel: (+1)-262-253-8200

Fax: (+1)-262-253-8222

Enclosures

MTE enclosures are designed to provide a degree of protection for electrical components and prevent incidental personnel contact with the enclosed equipment. Depending on the enclosure selected, these enclosures meet the requirements of NEMA 1/2 or 3R.

An approximate cross reference guide between NEMA, UL, CSA and IEC enclosure follows.

Type 1 NEMA / IEC IP20 Enclosure:

Are designed for indoor use and will provide protection against contact with the enclosed equipment.

Type 2 NEMA / IEC IP20 Enclosure:

Are designed for indoor use and will provide protection against contact with the enclosed equipment and provide a degree of protection against limited amounts of falling water and dirt.

Type 3R NEMA / IEC IP23 Enclosure:

Are designed for outdoor use primarily to provide protection against contact with the enclosed equipment and provide a degree of protection against falling rain sleet and external ice formation.

Agency Approvals

UL and cUL listed to UL508 Type MX and CSA-C22.2 No 14-95
File E180243 (1-999 Ampere, 120VAC through 690VAC 50/60Hz 1 or 3 phase).

Warranty

Three years from the date of shipment. See <https://www.mtecorp.com/industry-leading-warranty/> for details.

3. MATRIX ONE PERFORMANCE DATA

Performance Specifications

Table 3-1: Performance Specifications

Service Load Condition	Typically a 4-pulse rectifier
Input Voltage(s)	240 VAC ± 10%, 60 ± 0.75 Hz 1 phase 480 VAC ± 10%, 60 ± 0.75 Hz 1 phase
Maximum THID	12% at full load
Input voltage line distortion	1% maximum to ensure performance guaranty
Minimum source impedance	1.5%
Service Factor	1.00
Overload	150% for 1 minute duration
Ambient Temperature (Operating)	-40 to +50 degrees C Open Panel Filter -40 to +40 degrees C Enclosed Filter -40 to +90 degrees C Storage
Insulation System	Class N (200° C)
Altitude without derating	3,300 feet above sea level
Relative Humidity	0 to 95% non-condensing
Over Voltage	Category II
Insertion Load	+10% no load -10% full load

Notes (SCCR):

The Short Circuit Current Rating (SCCR) is not required under Exception No.1 of UL508A SB4.2.1 effective 4/25/06. This exception also applies to all the Contactor Options (002, 009, 012, and similar), where the Contactors are separated from the Main Power path by exempt components (such as Reactors) of sufficient Impedance, which is assured in case of the Reactors that are integral components of our Filter.

Filter Efficiency + Watt loss Matrix ONE 240V, 60Hz

Table 3-2: Watt Loss - Matrix ONE 240V, 60Hz

Maximum Output (Amps RMS)	Efficiency (%)	Typical Power Dissipation @ Rated Current (Watts)	Typical Capacitor Current (Amps RMS)
17	97.5%	181	9.5
26	97.9%	228	14.5
38	98.4%	258	21.1
49	97.9%	430	27.2
73	98.5%	473	40.6
94	98.5%	636	52.3
115	98.7%	631	63.9
140	98.6%	805	77.8
180	98.6%	1055	101.2
225	99.0%	967	125.1
265	99.0%	1115	147.3
330	99.0%	1359	183.5
430	99.1%	1647	239.1
540	99.2%	1872	300.2
620	99.2%	2094	344.7

NOTE: Use the IEC AC-3 rating for the corresponding filter capacitor current when selecting a contactor.

Filter Efficiency + Watt loss Matrix ONE 480V, 60Hz

Table 3-3: Watt Loss - Matrix ONE 480V, 60Hz

Maximum Output (Amps RMS)	Efficiency (%)	Typical 480V Power Dissipation @ Rated Current (Watts)	Typical Capacitor Current 480V (Amps RMS)
8	97.50%	184	4.4
13	97.87%	219	7.2
19	98.05%	292	10.6
24	98.15%	350	13.3
37	98.56%	509	20.6
47	98.52%	667	26.1
59	98.61%	648	32.8
69	98.84%	629	38.4
90	98.85%	818	50.0
110	98.84%	1010	61.2
135	98.79%	1287	75.1
165	98.85%	1503	91.7
215	99.17%	1409	119.5
270	99.23%	1641	150.1
310	99.27%	1797	172.4

NOTE: Use the IEC AC-3 rating for the corresponding filter capacitor current when selecting a contactor.

Load Effect on THID

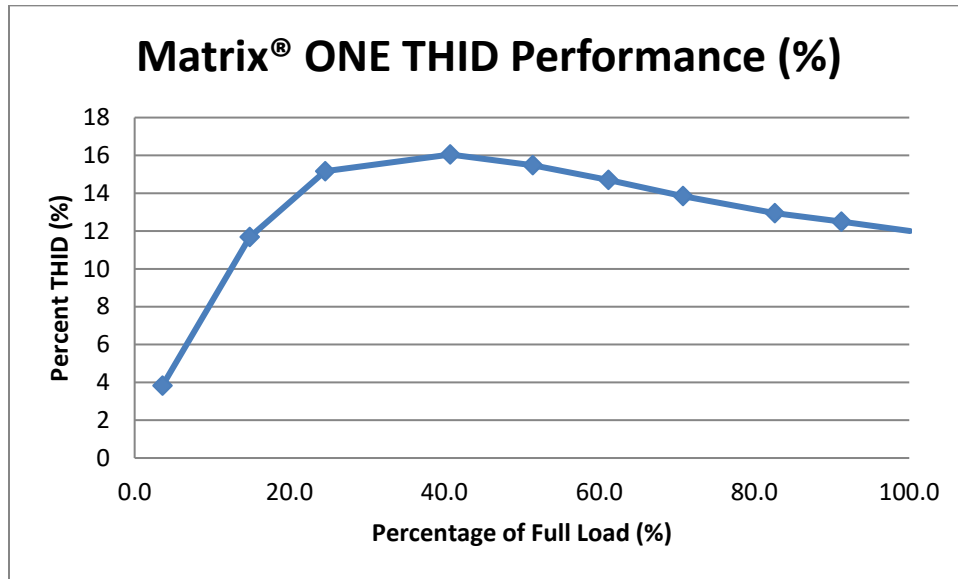

Figure 3-1: Load Effect on THID

Typical Harmonic Spectrum

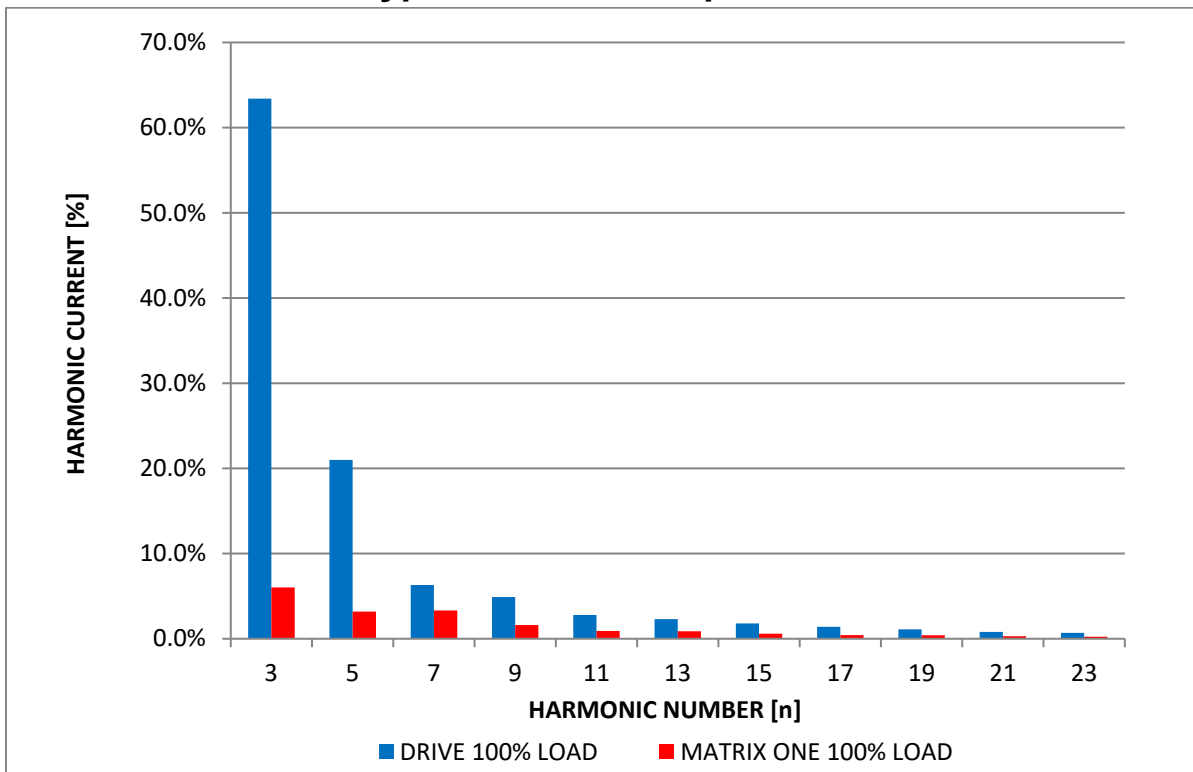

Figure 3-2: Typical Harmonic Spectrum with and without Matrix ONE

Power Factor

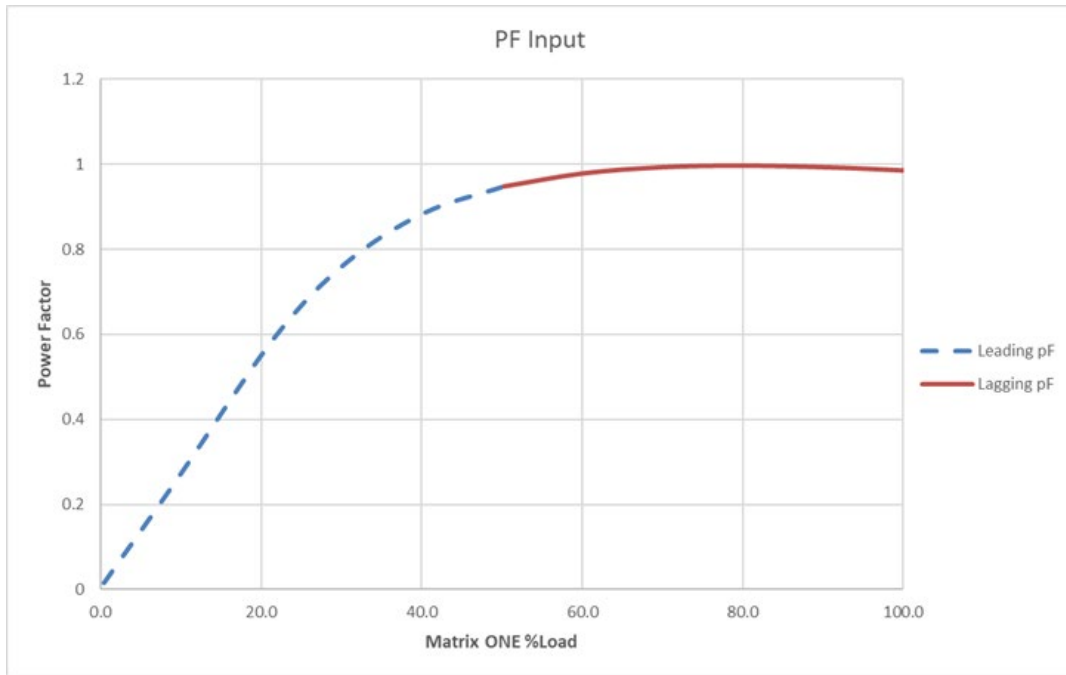

Figure 3-3: Matrix ONE % Load vs Power Factor

Altitude Derating

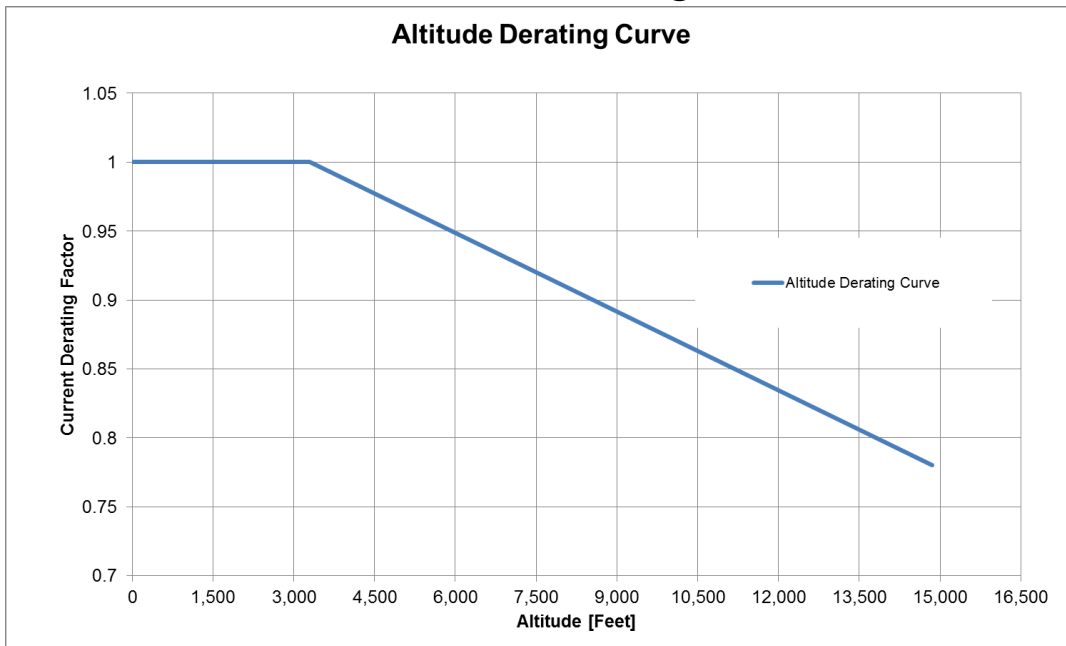

Figure 3-4: Altitude Derating Curve

Temperature Derating

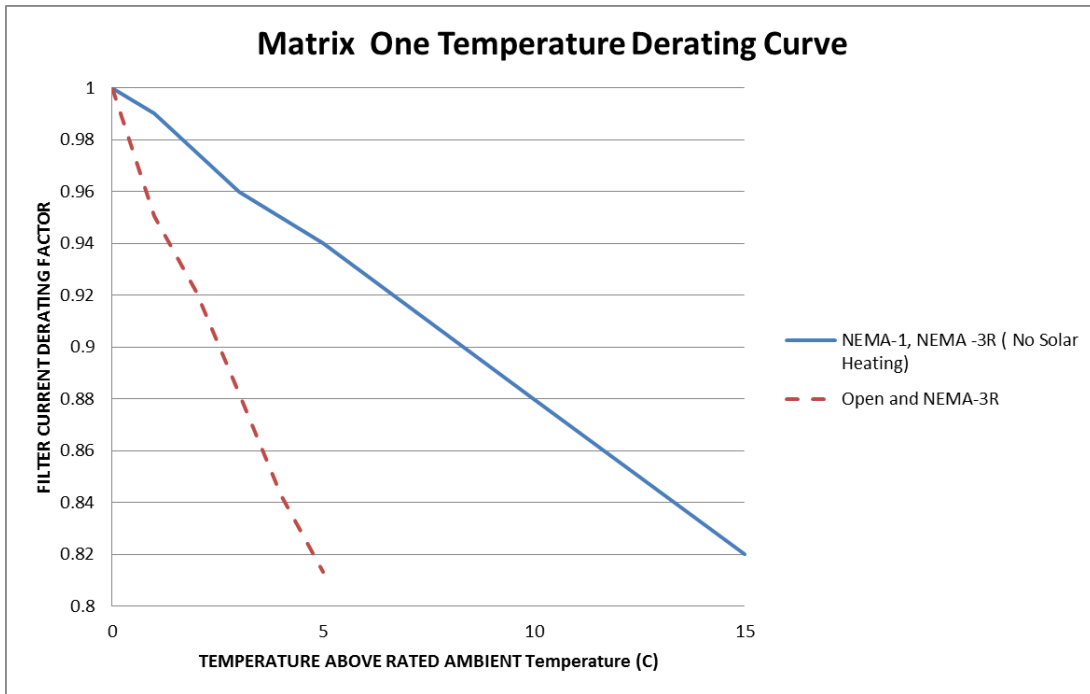

Figure 3-5: Temperature Derating

4. HOW TO SELECT



Prior to filter selection, please consult drive manual/manufacturer to ensure drive is suitable for single phase filter application, system ratings are understood in single phase operation, and to configure proper parameters. Failure to do so may result in failure of drive, filter, or other equipment.

Selection Guide

The MTE Corporation Matrix ONE harmonic filter is designed for harmonic mitigation of 4-pulse inverter drives supplying variable torque loads in a wide variety of applications. The suitability of this filter for a specific application must therefore be determined by the customer. In no event will MTE Corporation assume responsibility or liability for any direct or consequential damages resulting from the use or application of this filter, nor will MTE Corporation assume patent liability with respect to the use of information, circuits or equipment described in this instruction manual.

Matrix ONE harmonic filters are available in Open Panel, NEMA 1/2, and 3R mechanical configurations.

NOTE: For inverters feeding isolation transformers select a filter with a current rating equal to or greater than that of the transformer primary current.

Please verify information below for proper selection:

- Line Voltage and Frequency:** Input voltage 240V or 480V, 60 Hz. See Table 3-1: Performance Specifications (p5) for specification.
- Current Rating:** 240V 17-620 Amp; 480V 8-310 Amp.
- Voltage Distortion:** For environments where voltage distortion exceeds 2%, contact MTE at 1-800-455-4MTE (4683) for derating information.
- Contactors Option:** Matrix ONE is equipped with user installable contactor options. See Figure 5-4: Matrix ONE 240V & 480V Enclosed Interconnection (p24).
- Performance:** See Table 3-1: Performance Specifications (p5) for specification.
- Altitude:** 3,300 feet above sea level without derating. See Figure 3-4: Altitude Derating Curve (p9) for derating information.
- Enclosure Type:** Open Panel, NEMA 1/2 & NEMA 3R, see Enclosures (p4) for enclosure descriptions.
- Temperature:** See Table 3-1: Performance Specifications (p5) for operating temperature information and Figure 3-5: Temperature Derating (p10) for derating information.
- Refer to Article 430 Table 430.91 of the National Electrical code for the selection of the appropriate enclosure Type Number for your application.

Understanding the MATRIX ONE Part Number:

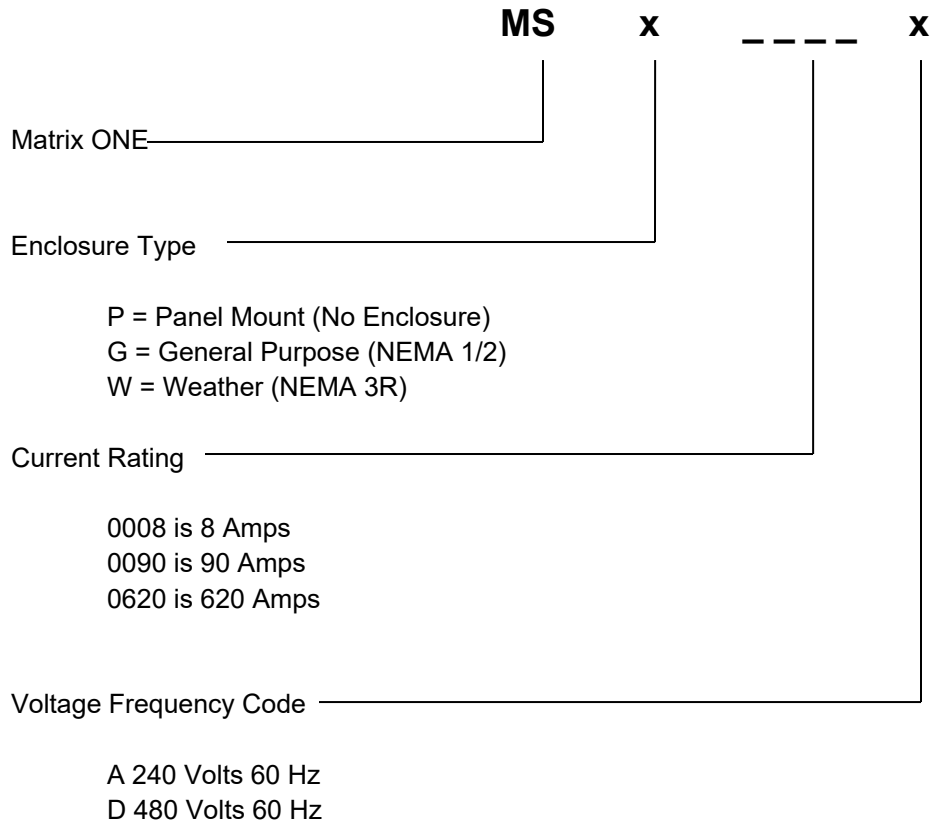

Additional Options

Standard NEMA 3R enclosure with optional rodent/serpent screen

Matrix ONE 240 Volts, 60Hz Part Number Selection Tables Open Panel

Table 4-1: Matrix ONE 240V Open Panel

Motor HP	Filter Amps Rating	Part Number	App. Wt. (lbs.)*	Open Magnetics (in.) (H x W x D)	Capacitor (in.) (H x W) Capacitor Panel (in.) (H x W x D)
3	17	MSP0017A	42	8.7 x 10.5 x 7.2	4.8 x 3.5
5	26	MSP0026A	47	8.7 x 10.5 x 7.7	4.8 x 3.9
7.5	38	MSP0038A	69	10.5 x 12.0 x 9.6	6.9 x 18.4 x 7.0
10	49	MSP0049A	76	10.5 x 12.0 x 10.2	6.9 x 18.4 x 7.0
15	73	MSP0073A	108	10.6 x 12.0 x 12.0	7.9 x 4.6
20	94	MSP0094A	150	15.2 x 15.3 x 10.9	9.2 x 16.4 x 7.6
25	115	MSP0115A	168	15.3 x 15.3 x 11.6	6.9 x 16.3 x 7.6
30	140	MSP0140A	200	15.2 x 15.3 x 12.3	9.2 x 16.4 x 7.6
40	180	MSP0180A	249	15.3 x 15.3 x 14.6	9.9 x 16.4 x 7.6
50	225	MSP0225A	295	18.3 x 15.3 x 13.8	9.9 x 16.4 x 7.6
60	265	MSP0265A	318	18.4 x 15.3 x 14.9	(2) 9.9 x 16.4 x 7.6
75	330	MSP0330A	375	18.4 x 15.3 x 16.7	(2) 9.9 x 16.4 x 7.6
100	430	MSP0430A	612	20.5 x 24.0 x 17.4	9.6 x 16.4 x 7.6 8.0 x 16.4 x 7.6
125	540	MSP0540A	720	20.6 x 24.0 x 18.5	9.9 x 16.4 x 7.6 11.1 x 16.4 x 7.6
150	620	MSP0620A	828	20.6 x 24.0 x 19.7	(2) 11.5 x 16.3 x 7.6

NOTE: Approximate weight of filter above includes weight of reactor and accompanying capacitor and/or cap-panel assembly.

Matrix ONE 240 Volts, 60Hz Part Number Selection Tables Enclosed

Table 4-2: Matrix ONE 240V Enclosed

Motor HP	Filter Amps Rating	Part Number	NEMA 1/2 Enclosure (in.) (H x W x D)	App. Wt (lbs.)	Part Number	NEMA 3R Enclosure (in.) (H x W x D)	App. Wt (lbs.)
3	17	MSG0017A	24.0 x 12.5 x 17.9	90	MSW0017A	24.0 x 12.5 x 23.0	97
5	26	MSG0026A	24.0 x 12.5 x 17.9	95	MSW0026A	24.0 x 12.5 x 23.0	103
7.5	38	MSG0038A	33.9 x 18.3 x 20.9	144	MSW0038A	33.9 x 18.3 x 26.0	155
10	49	MSG0049A	33.9 x 18.3 x 20.9	146	MSW0049A	33.9 x 18.3 x 26.0	156
15	73	MSG0073A	33.9 x 18.3 x 20.9	184	MSW0073A	33.9 x 18.3 x 26.0	195
20	94	MSG0094A	51.3 x 27.7 x 24.9	320	MSW0094A	51.3 x 27.7 x 30.0	333
25	115	MSG0115A	51.3 x 27.7 x 24.9	338	MSW0115A	51.3 x 27.7 x 30.0	351
30	140	MSG0140A	51.3 x 27.7 x 24.9	370	MSW0140A	51.3 x 27.7 x 30.0	383
40	180	MSG0180A	51.3 x 27.7 x 24.9	420	MSW0180A	51.3 x 27.7 x 30.0	433
50	225	MSG0225A	51.3 x 27.7 x 24.9	467	MSW0225A	51.3 x 27.7 x 30.0	480
60	265	MSG0265A	87.6 x 43.7 x 31.1	741	MSW0265A	87.6 x 43.7 x 40.1	786
75	330	MSG0330A	87.6 x 43.7 x 31.1	800	MSW0330A	87.6 x 43.7 x 40.1	845
100	430	MSG0430A	87.6 x 43.7 x 31.1	1040	MSW0430A	87.6 x 43.7 x 40.1	1084
125	540	MSG0540A	87.6 x 43.7 x 31.1	1147	MSW0540A	87.6 x 43.7 x 40.1	1191
150	620	MSG0620A	84.0 x 52.0 x 36.5	1456	MSW0620A	84.0 x 52.0 x 45.5	1497

Matrix ONE 480 Volts, 60Hz Part Number Selection Tables Open Panel

Table 4-3: Matrix ONE 480V Open Panel

Motor HP	Filter Amps Rating	Part Number	App. Wt. (lbs.)*	Open Magnetics (in.) (H x W x D)	Capacitor (in.) (H x W) Capacitor Panel (in.) (H x W x D)
3	8	MSP0008D	41	8.6 x 10.5 x 7.2	7.8 x 3.9
5	13	MSP0013D	51	8.7 x 10.5 x 7.7	8.3 x 4.6
7.5	19	MSP0019D	67	10.5 x 12.0 x 8.0	8.3 x 4.6
10	24	MSP0024D	75	10.5 x 12.0 x 8.5	9.2 x 4.6
15	37	MSP0037D	106	10.6 x 12.0 x 11.8	4.8 x 3.5
20	47	MSP0047D	146	15.2 x 15.3 x 10.9	10.9 x 16.4 x 7.6
25	59	MSP0059D	160	15.2 x 15.3 x 11.4	7.9 x 16.3 x 7.6
30	69	MSP0069D	164	15.1 x 15.3 x 11.9	6.7 x 16.4 x 7.6
40	90	MSP0090D	213	15.2 x 15.3 x 13.2	6.7 x 16.4 x 7.6
50	110	MSP0110D	255	18.3 x 15.3 x 13.0	7.7 x 16.3 x 7.6
60	135	MSP0135D	303	18.3 x 15.3 x 14.3	(2) 7.7 x 16.4 x 7.6
75	165	MSP0165D	349	18.3 x 15.3 x 15.4	9.2 x 16.4 x 7.6
100	215	MSP0215D	582	20.4 x 24.0 x 15.8	(2) 6.7 x 16.4 x 7.6
125	270	MSP0270D	687	20.3 x 24.0 x 18.7	6.7 x 16.4 x 7.6 7.9 x 16.3 x 7.6
150	310	MSP0310D	778	20.3 x 24.0 x 20.2	(2) 7.9 x 16.4 x 7.6

NOTE: Approximate weight of filter above includes weight of reactor and accompanying capacitor and/or cap-panel assembly.



Matrix ONE 480 Volts, 60Hz Part Number Selection Tables Enclosed

Table 4-4: Matrix ONE 480V Enclosed

Motor HP	Filter Amps Rating	Part Number	NEMA 1/2 Enclosure (in.) (H x W x D)	App. Wt (lbs.)	Part Number	NEMA 3R Enclosure (in.) (H x W x D)	App. Wt (lbs.)
3	8	MSG0008D	24.0 X 12.5 X 17.9	89	MSW0008D	24.0 X 12.5 X 23.0	97
5	13	MSG0013D	24.0 X 12.5 X 17.9	98	MSW0013D	24.0 X 12.5 X 23.0	106
7.5	19	MSG0019D	33.9 X 18.3 X 20.9	142	MSW0019D	33.9 X 18.3 X 26.0	153
10	24	MSG0024D	33.9 X 18.3 X 20.9	149	MSW0024D	33.9 X 18.3 X 26.0	160
15	37	MSG0037D	33.9 X 18.3 X 20.9	181	MSW0037D	33.9 X 18.3 X 26.0	192
20	47	MSG0047D	51.3 X 27.7 X 24.9	312	MSW0047D	51.3 X 27.7 X 30.0	325
25	59	MSG0059D	51.3 X 27.7 X 24.9	326	MSW0059D	51.3 X 27.7 X 30.0	339
30	69	MSG0069D	51.3 X 27.7 X 24.9	330	MSW0069D	51.3 X 27.7 X 30.0	343
40	90	MSG0090D	51.3 X 27.7 X 24.9	383	MSW0090D	51.3 X 27.7 X 30.0	396
50	110	MSG0110D	76.0 X 27.7 X 24.9	499	MSW0110D	76.0 X 27.7 X 34.0	524
60	135	MSG0135D	76.0 X 27.7 X 24.9	546	MSW0135D	76.0 X 27.7 X 34.0	571
75	165	MSG0165D	76.0 X 27.7 X 24.9	592	MSW0165D	76.0 X 27.7 X 34.0	617
100	215	MSG0215D	87.6 X 43.7 X 31.1	1005	MSW0215D	87.6 X 43.7 X 40.1	1049
125	270	MSG0270D	87.6 X 43.7 X 31.1	1110	MSW0270D	87.6 X 43.7 X 40.1	1155
150	310	MSG0310D	84.0 X 52.0 X 36.5	1399	MSW0310D	84.0 X 52.0 X 45.5	1439

5. HOW TO INSTALL

Installation Checklist

 WARNING	<p>Prior to installation, please refer to all general warnings on pages 1 & 2. Failure to practice this can result in bodily injury!</p>
	<p>Input and output wiring to the filter should be performed by authorized personnel in accordance with NEC and all local electrical codes and regulations.</p>
 WARNING	<p>The filter is designed for use with copper conductors with a minimum temperature rating of 75 degrees C.</p>
	<p>Do not install capacitor assembly above/near the Harmonic Mitigating Reactor. Premature or catastrophic failure may occur.</p>

Matrix ONE Filters are supplied in the following mechanical configurations:

- Open Panel Mount: Open panel units consist of a reactor and one or more capacitor panel modules referred to as cap-panels on drawings and diagrams. Additional wiring between the reactor and capacitor/capacitor panel is required by customer.
- Floor mounted general purpose NEMA 1/2, & 3R cabinets: Reactor and capacitor/capacitor assemblies are supplied in a cabinet with all items pre-wired together.

Minimum Required Space:

Open panel Matrix ONE filters are designed for mounting within the customer's enclosure. When determining the internal temperature rise and cooling requirements of the enclosure, include the power dissipation of the filter along with all the other components located in the panel. A general guideline is to allow a side clearance of eight (8) inches and a vertical clearance of eight (8) inches for proper heat dissipation and access within the enclosure. Clearances may be less if proper ventilation exists. Filter components must operate within temperatures specified in this manual or filter operating life will be compromised. Also, be aware of minimum electrical clearances as defined by the appropriate system safety standard(s). Open panel Matrix ONE filters generate heat and should be positioned away from heat sensitive components. Avoid locations where the filter would be subjected to excessive vibrations. Locate the filter as close to the inverter as possible.

NOTE: Locate the capacitor panel in the lowest temperature regions of the enclosure – generally toward the bottom and away from high temperature components.

General purpose NEMA 1/2 and 3R enclosed filters are designed for floor mounting in an environment suitable for the enclosure type. Do not install in or near a corrosive environment. Avoid locations where the filter would be subjected to excessive vibrations. Allow a minimum side and back clearance of eight (8) inches and front clearance of thirty-six (36) inches for proper heat dissipation and access.

Grounding

 WARNING	The filter must always be grounded with a grounding conductor connected to ground terminals.
	For open panel units, ensure a 2" x 2" area is cleaned of paint and varnish on lower mounting bracket for ground connection.
	On NEMA 3R enclosures, CAB-26AP and larger, no live parts shall be mounted below 8 inches from the bottom of the enclosure.

NOTE: For cable shield grounding follow the drive manufacturer’s recommendations.

Grounding and Ground Fault Protection

Due to high leakage currents associated with variable frequency drives, ground fault protective devices do not necessarily operate correctly when placed ahead of a Matrix filter feeding a drive. When using this type of device, its function should be tested in the actual installation.

Overtemperature Interlock

An overtemperature interlock circuit should be used in conjunction with thermal switch to turn off the drive to prevent filter damage due to abnormal operating conditions. The temperature switch is normally closed and will open when an internal reactor temperature of 180°C is reached. See Table 5-1: Overtemperature Switch, below for contact rating information and the drive user manual for interconnection information.

Table 5-1: Overtemperature Switch

<i>NC Switch</i> opens at 180 Deg. +/- 5 Deg. C		
Current Amps	Voltage	Contact Load
6	120 AC	Resistive Loads
3	120 AC	Inductive Loads
3	240 AC	Resistive Loads
2.5	240 AC	Inductive Loads
8	12 VDC	Resistive Loads
4	24 VDC	Resistive Loads

MTE highly recommends the use of the overtemperature switch to prevent damage to the filter in rare instances of overheating from abnormal operating conditions.

Power Wiring Connection

 WARNING	<p>Input and output power wiring to the filter should be performed by authorized personnel in accordance with the NEC and all local electrical codes and regulations. Cable lugs and mounting hardware are provided by the customer.</p>
	<p>Any extremely low or high resistance readings indicate a mis-wire and may result in damage to filter components if not corrected.</p>
	<p>On NEMA 3R enclosures, CAB-26AP and larger, no live parts shall be mounted below 8 inches from the bottom of the enclosure.</p>

Verify that the power source to which the filter is to be connected is in agreement with the nameplate data on the filter. A fused disconnect switch or circuit breaker should be installed between the filter and its source of power in accordance with the requirements of the NEC and all local electrical codes and regulations. Refer to the drive user manual for selection of the correct fuse rating and class.

- For panel mounted filter applications, interconnection between the filter, its power source, the cap-panels, and the drive is shown in Figure 5-3: Matrix ONE 240V & 480V Open Panel Interconnection (p22).
- For filters supplied in general purpose NEMA 1/2 & 3R cabinets, interconnection between the filter, its power source, and the drive is shown in Figure 5-4: Matrix ONE 240V & 480V Enclosed Interconnection (p23).

Wire gauge range and terminal torque requirements as well as selecting conductors that interconnect the HMR and capacitor assemblies are shown in Table 5-2: Torque Ratings-240V (p25) for 240V, Table 5-3: Torque Ratings-480V (p26) for 480V. Filters that use multiple cap-panels share total cap current shown on Table 3-2: Watt Loss - Matrix ONE 240V, 60Hz (p6) for 240V, Table 3-3: Watt Loss - Matrix ONE 480V, 60Hz (p7) for 480V.

Refer to the drive user manual for instructions on interconnecting the drive and motor and the correct start-up procedures for the drive.

The filter is designed for use with copper conductors with a minimum temperature rating of 75 degrees C.

Wiring Checks

Using Figure 5-1: Open Unit Schematic Diagram (p21) and Figure 5-2: Enclosed Unit Schematic Diagram (p21), visually check the wired components to confirm, verify, and correct wiring. Then, with a multi meter, check phase to phase isolation using the 100 K ohm range. The multi meter will read the parallel equivalent of the bleeder resistors after the capacitors initially charge. All phase to phase resistance values should be the same.

Check for the Following Faults:

- Capacitor shorted
- Capacitor bus not connected
- Capacitor bus to chassis short
- Paralleling wiring errors

Basic Schematic Diagrams

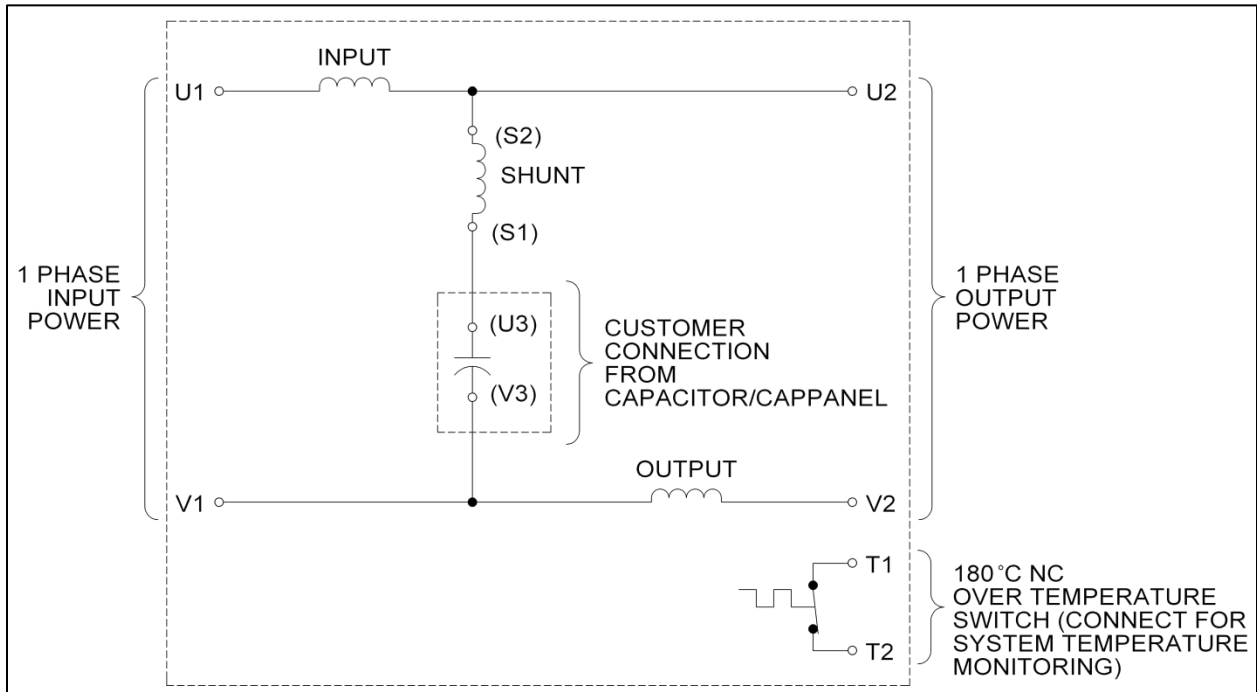

Figure 5-1: Open Unit Schematic Diagram

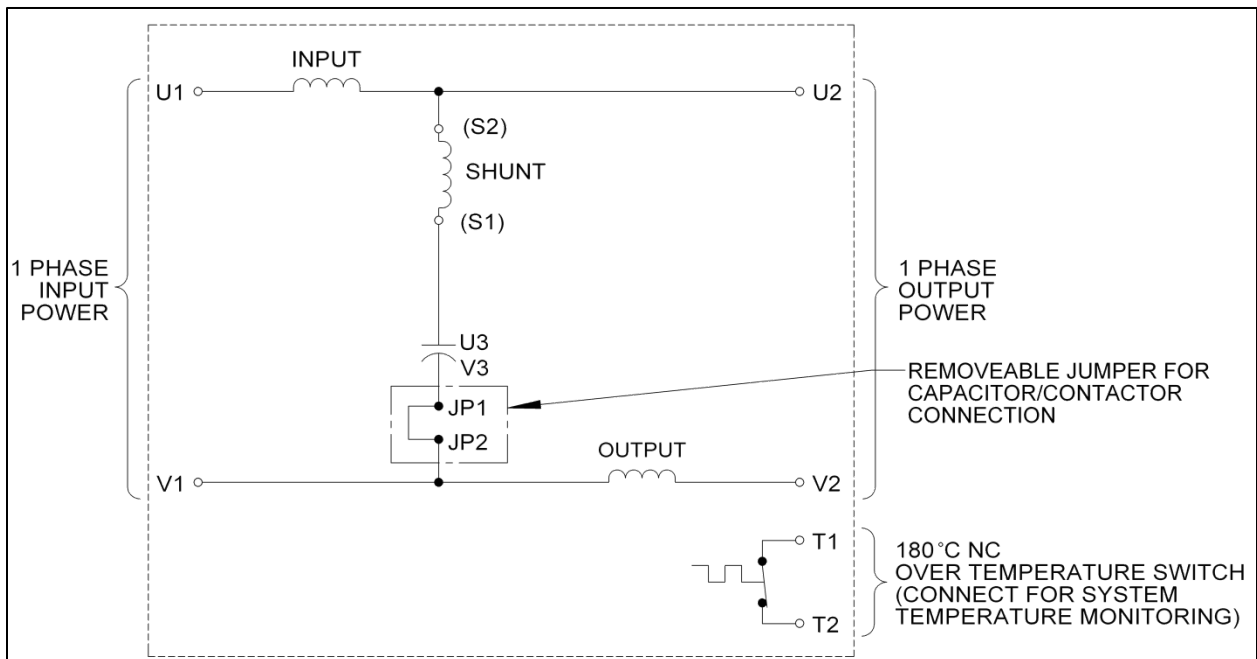

Figure 5-2: Enclosed Unit Schematic Diagram

Open Panel Unit Interconnection Diagram

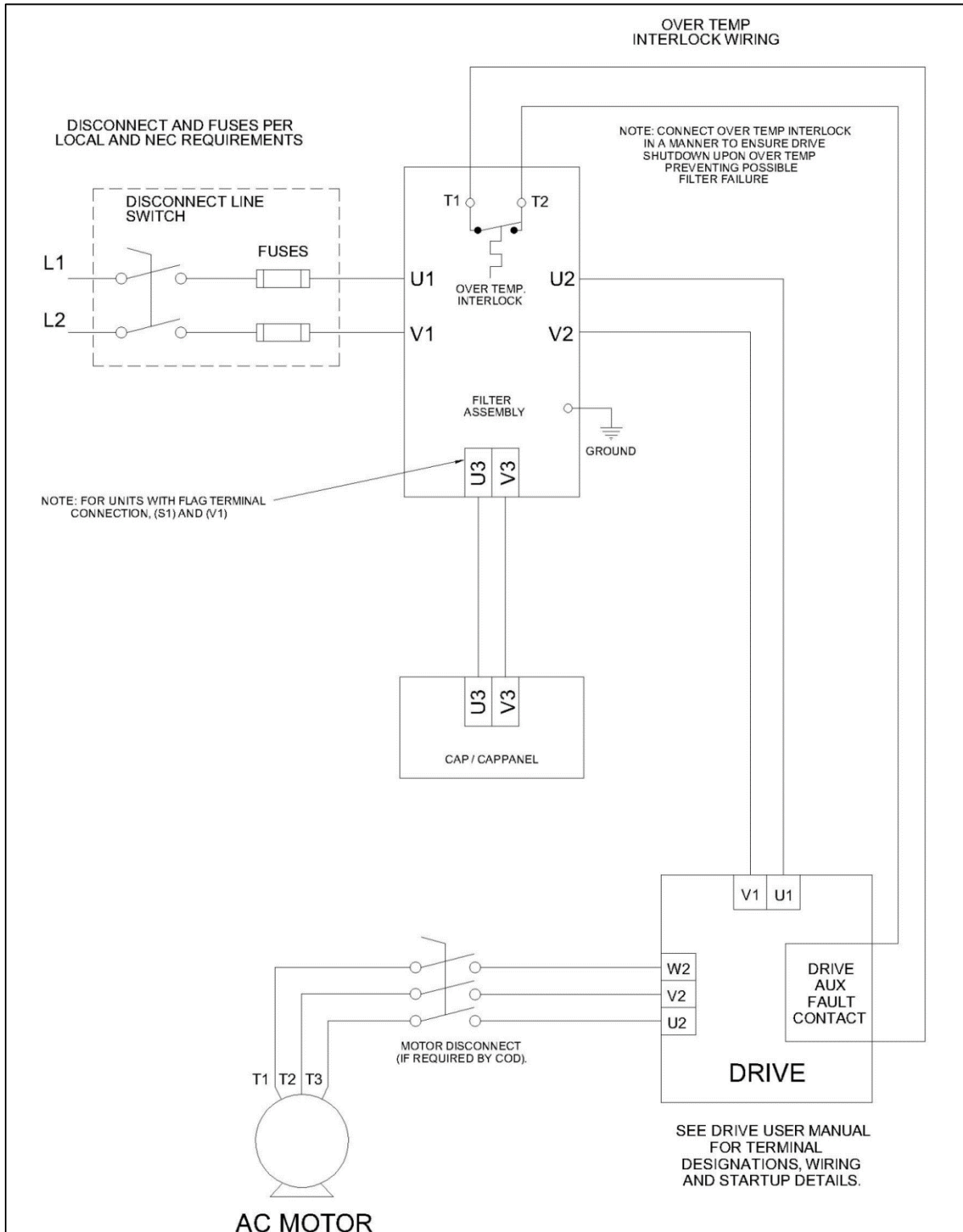

Figure 5-3: Matrix ONE 240V & 480V Open Panel Interconnection

Enclosed Unit Interconnection Diagram

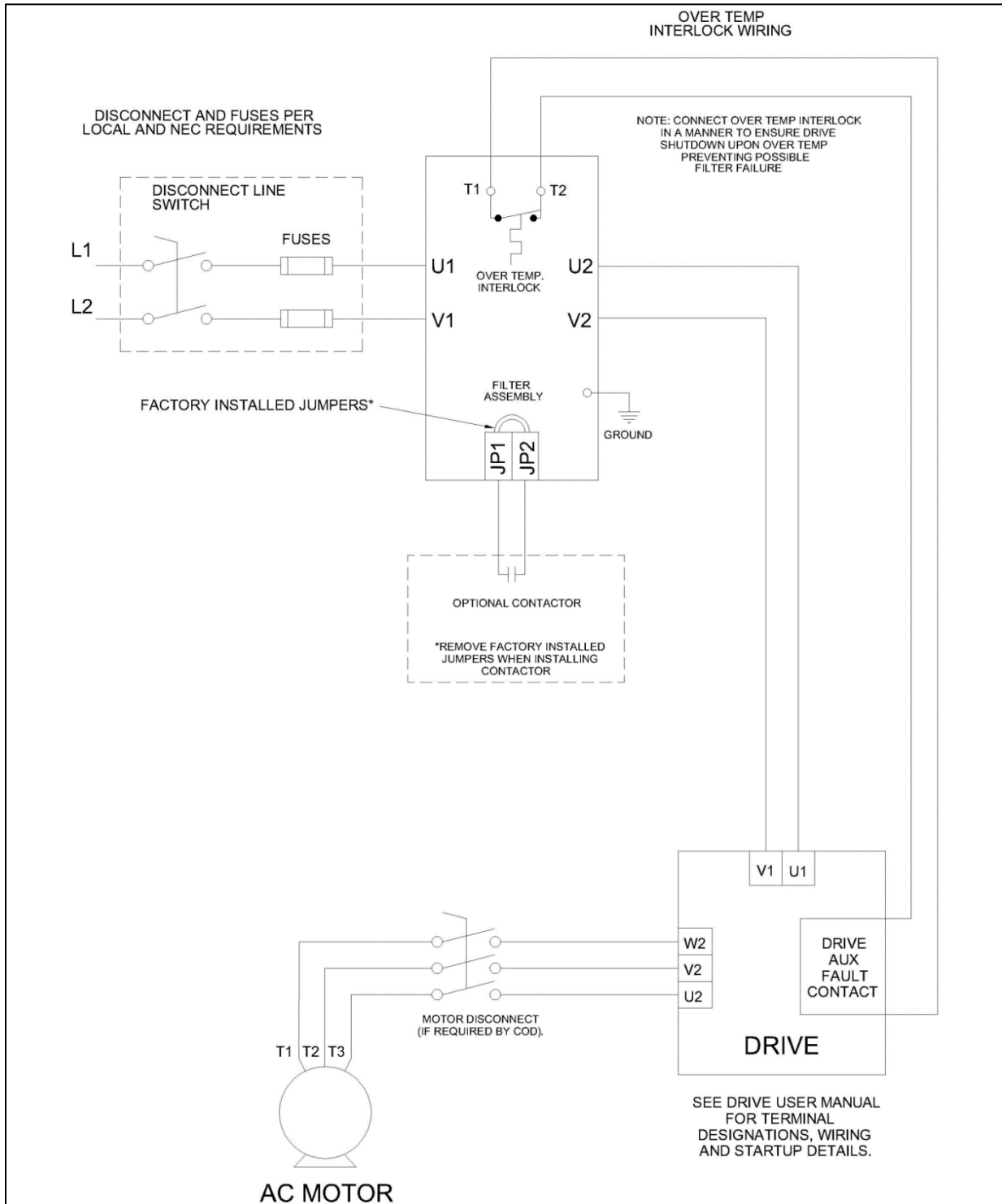

Figure 5-4: Matrix ONE 240V & 480V Enclosed Interconnection

Contactor Wiring Option

The Matrix ONE comes with a user configurable contactor wiring block. This option allows the user to add disconnect options to meet their applications. Refer to Figure 5-4: Matrix ONE 240V & 480V Enclosed Interconnection ([p23](#)) for the wiring diagram. The units will be shipped with factory installed jumpers as shown in the figure. Jumpers must be removed for installation of contactor option.

Torque Ratings

Table 5-2: Torque Ratings-240V

Filter Rating (Amps)	Matrix ONE HMR Terminals			Cap-panel Terminals U3-V3		
	Input /Output Power U1-V1 / U2-V2		U3-V3/JP1 Interconnect Cap-panel	240V Cap-panel Part Number	Minimum Interconnect Wire Gauge (AWG)	Terminal Torque (in-lbs.)
	Recommended Min. Wire Size (AWG)	Terminal Torque (in-lbs.)	Terminal Torque (in-lbs.)			
17	14	16	16	CAP-323HIC	14	60
26	10	16	16	CAP-325HIC	14	60
38	8	16	16	CAPPANEL-017(C)	12	60
49	8	16	16	CAPPANEL-019(C)	10	60
73	4	16	16	CAP-317HIC	8	60
94	2	16	16	CAPPANEL-021(C)	6	60
115	2	N/A	N/A	CAPPANEL-023(C)	6	60
140	1/0	N/A	N/A	CAPPANEL-018(C)	4	60
180	3/0	N/A	N/A	CAPPANEL-086(C)	2	60
225	4/0	N/A	N/A	CAPPANEL-092(C)	1	60
265	1/0 (2x) or 300 kcmil	N/A	N/A	CAPPANEL-093(C) CAPPANEL-093(C)	1/0 1/0	60 60
330	2/0 (2x) or 400 kcmil	N/A	N/A	CAPPANEL-093(C) CAPPANEL-094(C)	3 3	60 60
430	250 kcmil (2x)	N/A	N/A	CAPPANEL-097(C) CAPPANEL-098(C)	1 1	60 60
540	300 kcmil (2x)	N/A	N/A	CAPPANEL-099(C) CAPPANEL-101(C)	1/0 1/0	60 60
620	350 kcmil (2x)	N/A	N/A	CAPPANEL-101(C) CAPPANEL-101(C)	2/0 2/0	60 60

NOTE: Cap-panel numbers designated with “(C)” as a suffix indicate cap-panels will be either -xxx or -xxxC.

NOTE: Cap-panel interconnect wiring specification according to UL508 75° C Table.

NOTE: To prevent flexing or bending of the coil windings attached to Matrix ONE HMR Flat copper terminal tabs, use two wrenches to tighten customer provided cable mounting hardware.

Note: Refer to reference drawings on MTE website for termination wire ranges

Torque Ratings

Table 5-3: Torque Ratings-480V

Filter Rating (Amps)	Matrix ONE HMR Terminals			Cap-panel Terminals U3-V3		
	Input /Output Power U1-V1 / U2-V2		U3-V3/JP1 Interconnect Cap-panel	480V Cap-panel Part Number	Minimum Interconnect Wire Gauge (AWG)	Terminal Torque (in-lbs.)
	Recommended Min. Wire Size (AWG)	Terminal Torque (in-lbs.)	Terminal Torque (in-lbs.)			
8	14	16	16	CAP-364TP	14	23
13	14	16	16	CAP-366TP	14	23
19	14	16	16	CAP-367TP	14	23
24	12	16	16	CAP-368TP	14	23
37	8	16	16	CAP-323HIC	12	60
47	6	16	16	CAPPANEL-013(C)	10	60
59	4	N/A	16	CAPPANEL-004(C)	10	60
69	4	N/A	16	CAPPANEL-012(C)	8	60
90	3	N/A	N/A	CAPPANEL-024(C)	8	60
110	1	N/A	N/A	CAPPANEL-026(C)	6	60
135	4 (2x) or 1/0	N/A	N/A	CAPPANEL-145(C)	4	60
165	3 (2x) or 2/0	N/A	N/A	CAPPANEL-029(C)	3	60
215	2 (2x) or 250 kcmil	N/A	N/A	CAPPANEL-030(C) CAPPANEL-030(C)	1/0 1/0	60 60
270	1/0 (2x) or 300 kcmil	N/A	N/A	CAPPANEL-024(C) CAPPANEL-095(C)	4 4	60 60
310	2/0 (2x) or 350 kcmil	N/A	N/A	CAPPANEL-095(C) CAPPANEL-143(C)	2/0 2/0	60 60

NOTE: Cap-panel numbers designated with “C” as a suffix indicate cap-panels will be either -xxx or -xxxC.

NOTE: Cap-panel interconnect wiring specification according to UL508 75° C Table.

NOTE: To prevent flexing or bending of the coil windings attached to Matrix ONE HMR Flat copper terminal tabs, use two wrenches to tighten customer provided cable mounting hardware.

Note: Refer to reference drawings on MTE website for termination wire ranges

6. START-UP

Safety Precautions

Before start-up, observe the following warnings and instructions:

 WARNING	<p>Internal components of the filter are at line potential when the filter is connected to the drive. This voltage is extremely dangerous and may cause death or severe injury if you come in contact with it.</p>
	<p>Remove all power to the Matrix ONE filter in compliance to standardized 26 CFR 1920.147 lockout/tagout policies. After disconnecting the utility power, wait at least 5 minutes before doing any work on the filter connections. After removing power, allow at least five minutes to elapse and verify that the capacitors have discharged to a safe level before contacting internal components. Connect a DC voltmeter across the capacitor terminals and ensure that the voltage is at a safe level.</p>
	<p>Use extreme caution to avoid contact with line voltage when checking for power. INJURY OR DEATH MAY RESULT IF SAFETY PRECAUTIONS ARE NOT OBSERVED.</p>
	<p>After disconnecting the utility power, wait at least 5 minutes before doing any work on the filter connections. After removing power, allow at least five minutes to elapse and verify that the capacitors have discharged to a safe level before contacting internal components. Connect a DC voltmeter across the capacitor terminals. Start with the meter on the highest scale and progressively switch to a lower scale as the indicated voltage falls below the maximum value of the scale used.</p>

Sequence of Operation

1. Read and follow safety precautions.
2. After installation, ensure that:
 - All filter ground terminals are connected to ground.
 - Power wiring to the utility, drive and motor is in accordance with the power wiring connection diagrams shown in installation instructions section. Use the guidelines of
 - Table 5-2 (p25) for 240V and Table 5-3 (p26) for 480V, for power and cap-panel wire gauges.
3. Check that moisture has not condensed on the filter components. If moisture is present, do not proceed with start-up until the moisture has been removed.
4. Disconnect the filter output from the drive.
5. Connect the filter to the utility.
6. Confirm that line voltage is present at the input terminals (U1, V1) of the filter.
7. Confirm that line voltage is present at the output terminals (U2, V2) of the filter and that it is less than or equal to 1.1 times the input voltage.
8. Using a clamp on Amp meter, check input phase currents to verify they are within a 5% match to each other and approximately 50% of filter current rating.
9. Remove power and verify that **NO VOLTAGE** is present on the filter terminals.
10. Connect the filter output to the drive.
11. Refer to the drive user manual for the drive start-up procedure. Observe all safety instructions in the drive user manual.

7. TROUBLESHOOTING

 WARNING	<p>When properly installed, this equipment has been designed to provide maximum safety for operating personnel. However, hazardous voltages and elevated temperatures exist within the confines of the enclosure. Servicing should therefore be performed by qualified personnel only and in accordance with OSHA Regulations.</p>
	<p>High voltage is used in the operation of this filter. Use Extreme caution to avoid contact with high voltage when operating, installing or repairing this filter. INJURY OR DEATH MAY RESULT IF SAFETY PRECAUTIONS ARE NOT OBSERVED.</p>
	<p>After removing power, allow at least five minutes to elapse and verify that the capacitors have discharged to a safe level before contacting internal components. Connect a DC voltmeter across the capacitor terminals or terminals U1, V1 and ensure that the voltage is at a safe level.</p>

To aid in troubleshooting, two basic schematic diagrams, two interconnection diagrams and a troubleshooting guide that lists potential problems and solutions are included:

Figure 5-1: Open Unit Schematic Diagram (p21)

Figure 5-2: Enclosed Unit Schematic Diagram (p21)

Figure 5-3: Matrix ONE 240V & 480V Open Panel Interconnection (p22)

Figure 5-4: Matrix ONE 240V & 480V Enclosed Interconnection (p23)

Table 7-1: Troubleshooting Guide (p31)

Harmonic Filter Field Checks

1. Disconnect all power and remove input power wiring from U1 and V1 terminals.
2. Remove VFD drive power connections from filter terminals U2 and V2 as well as any control wiring to the filter contactor or temperature switch. (For filters using control transformers: remove power fuses on top of transformer.)
3. Visually inspect filter terminals and wiring lugs for signs of heat and corrosion. **Contact factory if any wires appear to be missing or cut!**
4. Inspect the U3 and V3 capacitor interconnect terminals and wiring.
5. Visually inspect all capacitors for signs of case deformation, bowing of the top, leaking oil or terminal damage. Note the CAP- # and date code of any damaged capacitors.
6. Using a multi meter set to read 100K ohms check:
 - a. Phase to phase U1-V1 (mechanically activate contactor if present) after reactor and caps charge reading should be about 40K (total equivalent breeder resistance value). Open circuit or very low readings indicate a problem.
 - b. Phase to chassis U1- case and V1-case; low readings indicate a ground fault problem.
7. Ensure the “disconnect” is safe then wire the utility power to U1 and V1.
8. Apply power and verify that proper output voltage is present on U2 and V2.
9. Using a clamp on amp meter read the filter input current:
 - a. Mechanically activate the contactor if the filter is equipped with one. Readings should be the same (+/- 5%) for all phase currents; **contact the factory if currents are out of tolerance!**
 - b. Open contactor readings will show zero current for all phases.
10. Disconnect filter power and wire the VFD to U2 and V2 as well as any control wiring to the filter contactor or temperature switch. Replace any control transformer fuses. Follow the drive power start-up guidelines in the drive manufacturer’s user manual.

Table 7-1: Troubleshooting Guide

PROBLEM:	Line voltage is not present at the filter output terminals.
Possible cause:	Power to the filter is turned off.
Solution:	Turn power on.
Possible cause:	One or more external line fuses are blown.
Solution:	Verify the continuity of line fuses in all phases. Replace as necessary.
PROBLEM:	Full Load Harmonic current distortion exceeds 12% at full load.
Possible cause:	The capacitor assembly has not been connected.
Solution:	Check interconnection of capacitor assembly per the following: Figure 5-1: Open Unit Schematic Diagram (p21) Figure 5-2: Enclosed Unit Schematic Diagram (p21) Figure 5-3: Matrix ONE 240V & 480V Open Panel Interconnection (p22) Figure 5-4: Matrix ONE 240V & 480V Enclosed Interconnection (p23)
Possible cause:	A capacitor has failed.
Solution:	Inspect the tops of all capacitors for bowing. Replace failed capacitors.
Possible cause:	Source impedance is less than 1.5%.
Solution:	Add a minimum 1.5% impedance line reactor to the filter input.
Possible cause:	Input source voltage harmonic distortion.
Solution:	Identify equipment causing harmonic voltage distortion and add filters as required or accept elevated THVD.
PROBLEM:	Filter output voltage is not within specification
Possible cause:	Filter input voltage is not within specification.
Solution:	Check the AC input line voltage and verify that it is within tolerance. Refer to the filter service conditions and performance specifications for tolerances.
Possible cause:	Source impedance is out of tolerance.
Solution:	Verify that the source impedance is within tolerance. Refer to the filter service conditions and performance specifications for tolerances.
Possible cause:	Source impedance is out of tolerance.
Solution:	Verify that the source impedance is within tolerance. Refer to the filter service conditions and performance specifications for tolerances.
Possible cause:	One or more Capacitors are damaged.
Solution:	Visually check capacitor top for distortion or doming. Check for shorts or open caps. Replace failed capacitors.
Possible cause:	Drive set up parameter does not allow for input filter
Solution:	Consult drive manufacturer to update setup to accommodate input filter.
Possible cause:	Input voltage subject to extreme transients such as switching between two voltage sources. Drive faults on over or under voltage.
Solution:	Source switching is not recommended without proper phase synchronizing or allowing reasonable time delay before transfer to new source.